

**GARMIN**<sup>™</sup>

**G1000**<sup>®</sup> Integrated Flight Deck  
Pilot's Guide



**Diamond**  
**DA40/40F**

Copyright © 2006-2007 Garmin Ltd. or its subsidiaries. All rights reserved.

This manual reflects the operation of System Software version 369.13 or later for the Diamond DA40 or DA40F. Some differences in operation may be observed when comparing the information in this manual to earlier or later software versions.

Garmin International, Inc., 1200 East 151st Street, Olathe, Kansas 66062, U.S.A.  
Tel: 913/397.8200 Fax: 913/397.8282

Garmin AT, Inc., 2345 Turner Road SE, Salem, OR 97302, U.S.A.  
Tel: 503/391.3411 Fax: 503/364.2138

Garmin (Europe) Ltd., Liberty House, Hounslow Business Park, Southampton, SO40 9RB, U.K  
Tel: 44/0870.8501241 Fax: 44/0870.8501251

Garmin Corporation, No. 68, Jangshu 2nd Road, Shijr, Taipei County, Taiwan  
Tel: 886/02.2642.9199 Fax: 886/02.2642.9099

Website Address: [www.garmin.com](http://www.garmin.com)

Except as expressly provided herein, no part of this manual may be reproduced, copied, transmitted, disseminated, downloaded or stored in any storage medium, for any purpose without the express written permission of Garmin. Garmin hereby grants permission to download a single copy of this manual and of any revision to this manual onto a hard drive or other electronic storage medium to be viewed for personal use, provided that such electronic or printed copy of this manual or revision must contain the complete text of this copyright notice and provided further that any unauthorized commercial distribution of this manual or any revision hereto is strictly prohibited.

Garmin® is a registered trademark of Garmin Ltd. or its subsidiaries, and G1000® is a trademark of Garmin Ltd. or its subsidiaries. These trademarks may not be used without the express permission of Garmin.

Bendix/King® and Honeywell® are registered trademarks of Honeywell International, Inc.; Becker® is a registered trademark of Becker Flugfunkwerk GmbH; NavData® is a registered trademark of Jeppesen, Inc.; XM® is a registered trademark of XM Satellite Radio, Inc.; and Stormscope® is a registered trademark of L-3 Communications.

**LIMITED WARRANTY**

This Garmin product is warranted to be free from defects in materials or workmanship for two years from the date of purchase. Within this period, Garmin will, at its sole option, repair or replace any components that fail in normal use. Such repairs or replacement will be made at no charge to the customer for parts and labor, provided that the customer shall be responsible for any transportation cost. This warranty does not cover failures due to abuse, misuse, accident, or unauthorized alterations or repairs.

THE WARRANTIES AND REMEDIES CONTAINED HEREIN ARE EXCLUSIVE AND IN LIEU OF ALL OTHER WARRANTIES EXPRESS OR IMPLIED OR STATUTORY, INCLUDING ANY LIABILITY ARISING UNDER ANY WARRANTY OF MERCHANTABILITY OR FITNESS FOR A PARTICULAR PURPOSE, STATUTORY OR OTHERWISE. THIS WARRANTY GIVES YOU SPECIFIC LEGAL RIGHTS, WHICH MAY VARY FROM STATE TO STATE.

IN NO EVENT SHALL GARMIN BE LIABLE FOR ANY INCIDENTAL, SPECIAL, INDIRECT OR CONSEQUENTIAL DAMAGES, WHETHER RESULTING FROM THE USE, MISUSE, OR INABILITY TO USE THIS PRODUCT OR FROM DEFECTS IN THE PRODUCT. Some states do not allow the exclusion of incidental or consequential damages, so the above limitations may not apply to you.

Garmin retains the exclusive right to repair or replace the unit or software, or to offer a full refund of the purchase price, at its sole discretion. SUCH REMEDY SHALL BE YOUR SOLE AND EXCLUSIVE REMEDY FOR ANY BREACH OF WARRANTY.

To obtain warranty service, contact your local Garmin Authorized Service Center. For assistance in locating a Service Center near you, visit the Garmin Website at "<http://www.garmin.com>" or contact Garmin Customer Service at 800-800-1020.

---

 **WARNING:** To reduce the risk of unsafe operation, carefully review and understand all aspects of the G1000 Pilot's Guide documentation. Thoroughly practice basic operation prior to actual use. During flight operations, carefully compare indications from the G1000 to all available navigation sources, including the information from other NAVAIDs, visual sightings, charts, etc. For safety purposes, always resolve any discrepancies before continuing navigation.

---

 **WARNING:** The Garmin G1000 has a very high degree of functional integrity. However, the pilot must recognize that providing monitoring and/or self-test capability for all conceivable system failures is not practical. Although unlikely, it may be possible for erroneous operation to occur without a fault indication shown by the G1000. It is thus the responsibility of the pilot to detect such an occurrence by means of cross-checking with all redundant or correlated information available in the cockpit.

---

 **WARNING:** For safety reasons, G1000 operational procedures must be learned on the ground.

---

 **WARNING:** The United States government operates the Global Positioning System and is solely responsible for its accuracy and maintenance. The GPS system is subject to changes which could affect the accuracy and performance of all GPS equipment. Portions of the Garmin G1000 utilize GPS as a precision electronic NAVigation AID (NAVAID). Therefore, as with all NAVAIDs, information presented by the G1000 can be misused or misinterpreted and, therefore, become unsafe.

---

 **WARNING:** The altitude calculated by G1000 GPS receivers is geometric height above Mean Sea Level and could vary significantly from the altitude displayed by pressure altimeters, such as the GDC 74A Air Data Computer, or other altimeters in aircraft. GPS altitude should never be used for vertical navigation. Always use pressure altitude displayed by the G1000 PFD or other pressure altimeters in aircraft.

---

 **WARNING:** The displayed minimum safe altitudes (MSAs) are only advisory in nature and should not be relied upon as the sole source of obstacle and terrain avoidance information. Always refer to current aeronautical charts for appropriate minimum clearance altitudes.

---

 **WARNING:** Navigation and terrain separation must NOT be predicated upon the use of the terrain function. The G1000 Terrain Proximity feature is NOT intended to be used as a primary reference for terrain avoidance and does not relieve the pilot from the responsibility of being aware of surroundings during flight. The Terrain Proximity feature is only to be used as an aid for terrain avoidance and is not certified for use in applications requiring a certified terrain awareness system. Terrain data is obtained from third party sources. Garmin is not able to independently verify the accuracy of the terrain data.

---

 **WARNING:** Do not use outdated database information. Databases used in the G1000 System must be updated regularly in order to ensure that the information remains current. Pilots using any outdated database do so entirely at their own risk.

---

- 
- 

**WARNING:** Do not use basemap (land and water data) information for primary navigation. Basemap data is intended only to supplement other approved navigation data sources and should be considered as an aid to enhance situational awareness.

---

  - 

**WARNING:** Traffic information shown on the G1000 Multi Function Display is provided as an aid in visually acquiring traffic. The aircraft should be maneuvered based only upon ATC guidance or positive visual acquisition of conflicting traffic.

---

  - 

**WARNING:** XM Weather should not be used for hazardous weather penetration. Weather information provided by the GDL 69/69A is approved only for weather avoidance, not penetration.

---

  - 

**WARNING:** NEXRAD weather data is to be used for long-range planning purposes only. Due to inherent delays in data transmission and the relative age of the data, NEXRAD weather data should not be used for short-range weather avoidance.

---

  - 

**WARNING:** Use of the Stormscope is not intended for hazardous weather penetration (thunderstorm penetration). Stormscope information, as displayed on the G1000 MFD, is to be used only for weather avoidance, not penetration.

---

  - 

**WARNING:** The illustrations in this guide are only examples. Never use the G1000 to attempt to penetrate a thunderstorm. Both the FAA Advisory Circular, Subject: Thunderstorms, and the Airman’s Information Manual (AIM) recommend avoiding “by at least 20 miles any thunderstorm identified as severe or giving an intense radar echo.”

---

  - 

**CAUTION:** The Garmin G1000 does not contain any user-serviceable parts. Repairs should only be made by an authorized Garmin service center. Unauthorized repairs or modifications could void both the warranty and the pilot’s authority to operate this device under FAA/FCC regulations.

---

  - 

**CAUTION:** The GDU 1040 PFD and GDU 1040/1044 MFD displays use a lens coated with a special anti-reflective coating that is very sensitive to skin oils, waxes, and abrasive cleaners. **CLEANERS CONTAINING AMMONIA WILL HARM THE ANTI-REFLECTIVE COATING.** It is very important to clean the lens using a clean, lint-free cloth and an eyeglass lens cleaner that is specified as safe for anti-reflective coatings.

---

  - 

**NOTE:** When using Stormscope, there are several atmospheric phenomena in addition to nearby thunderstorms that can cause isolated discharge points in the strike display mode. However, clusters of two or more discharge points in the strike display mode do indicate thunderstorm activity if these points reappear after the screen has been cleared.

---

 **NOTE:** All visual depictions contained within this document, including screen images of the G1000 panel and displays, are for example only, are subject to change, and may not reflect the most current G1000 System. Depictions of equipment may differ slightly from the actual equipment.

---

 **NOTE:** The GDU 1040/1044 PFD/MFD may require a warm-up time of up to 30 minutes when exposed to -40°C for an extended period. A warm-up time of up to 15 minutes may be required when exposed to -30°C for an extended period.

---

 **NOTE:** This device complies with part 15 of the FCC Rules. Operation is subject to the following two conditions: (1) this device may not cause harmful interference, and (2) this device must accept any interference received, including interference that may cause undesired operation.

---

 **NOTE:** This product, its packaging, and its components contain chemicals known to the State of California to cause cancer, birth defects, or reproductive harm. This notice is being provided in accordance with California’s Proposition 65. For additional information, refer to the website at [www.garmin.com/prop65](http://www.garmin.com/prop65).

---

 **NOTE:** Interference from GPS repeaters operating inside nearby hangars can cause an intermittent loss of attitude and heading displays while the aircraft is on the ground. Moving the aircraft more than 100 feet away from the source of the interference should alleviate the condition.

---

 **NOTE:** Lamp(s) inside this product may contain mercury (Hg) and must be recycled or disposed of according to local, state, or federal laws. For more information, refer to the website at [www.garmin.com/aboutGarmin/environment/disposal.jsp](http://www.garmin.com/aboutGarmin/environment/disposal.jsp).

---

| <b>Record of Revisions</b> |                 |             |                   |   |
|----------------------------|-----------------|-------------|-------------------|---|
| <b>Part Number</b>         | <b>Revision</b> | <b>Date</b> | <b>Page Range</b> | <b>Description</b>  |
| 190-00592-00               | A               | 11/10/05    | i – I-6           | Optional fuel pressure gauge information added  |
| 190-00592-01               | A               | 6/16/06     | i – I-4           | GFC 700 information added   |
| 190-00592-02               | A               | 7/20/06     | i – I-4           | TAWS information added<br>GDL 69A crew muting information added   |
| 190-00592-03               | A               | 4/26/07     | i – I-6           | EIS updated<br>Airways information added<br>WAAS information added<br>VNV information added<br>Charts information added<br>Stormscope information added<br>TAS600 information added |

**SECTION 1 SYSTEM OVERVIEW**

- 1.1 Line Replaceable Units** ..... 1-2
- 1.2 Secure Digital (SD) Cards** ..... 1-7
- 1.3 System Power-up** ..... 1-8
- 1.4 System Operation**..... 1-9
  - Normal Display Operation ..... 1-9
  - Reversionary Display Operation ..... 1-9
  - G1000 System Annunciations ..... 1-10
  - System Status..... 1-11
  - AHRS Operation ..... 1-13
  - GPS Receiver Operation ..... 1-14
- 1.5 G1000 Controls**..... 1-18
  - PFD/MFD Controls ..... 1-18
  - Softkey Function..... 1-20
- 1.6 Accessing G1000 Functionality** ..... 1-27
  - Menus ..... 1-27
  - Data Entry ..... 1-27
  - Page Groups ..... 1-29
  - System Settings ..... 1-33
  - Timers ..... 1-38
  - Scheduler..... 1-40
  - Electronic Checklists (Optional) ..... 1-42
- 1.7 Display Backlighting** ..... 1-44

**SECTION 2 FLIGHT INSTRUMENTS**

- 2.1 Flight Instruments** ..... 2-4
  - Airspeed Indicator ..... 2-4
  - Attitude Indicator ..... 2-6
  - Altimeter ..... 2-7
  - Vertical Speed Indicator (VSI) ..... 2-8
  - Vertical Deviation, Glideslope, and Glidepath Indicators 2-9
  - Horizontal Situation Indicator (HSI) ..... 2-10
  - Course Deviation Indicator (CDI) ..... 2-15
- 2.2 Supplemental Flight Data** ..... 2-22
  - Outside Air Temperature ..... 2-22
  - Wind Data ..... 2-23
  - Vertical Navigation (VNV) Indications ..... 2-24
- 2.3 PFD Annunciations and Alerting Functions** ..... 2-25
  - G1000 Alerting System..... 2-25
  - Marker Beacon Annunciations ..... 2-26
  - Traffic Annunciation ..... 2-26
  - TAWS Annunciations (Optional) ..... 2-27

- Altitude Alerting ..... 2-27
- Low Altitude Annunciation ..... 2-28
- Minimum Descent Altitude/Decision Height Alerting ... 2-28
- 2.4 Abnormal Operations** ..... 2-30
  - Abnormal GPS Conditions ..... 2-30
  - Unusual Attitudes ..... 2-31

**SECTION 3 ENGINE INDICATION SYSTEM**

- 3.1 EIS Display**..... 3-2
- 3.2 Engine Page** ..... 3-4
  - Fuel Calculations ..... 3-6
- 3.3 Leaning Assist Mode** ..... 3-8
- 3.4 EIS in Reversionary Mode** ..... 3-9
  - Lean Display ..... 3-10
  - System Display ..... 3-12

**SECTION 4 AUDIO PANEL AND CNS**

- 4.1 Overview** ..... 4-1
  - PFD/MFD Controls and Frequency Display ..... 4-2
  - Audio Panel Controls ..... 4-4
- 4.2 COM Operation**..... 4-6
  - COM Transceiver Selection and Activation ..... 4-6
  - COM Transceiver Manual Tuning ..... 4-7
  - Quick-Tuning and Activating 121.500 MHz ..... 4-8
  - Auto-Tuning the COM Frequency ..... 4-9
  - Frequency Spacing ..... 4-13
  - Automatic Squelch ..... 4-14
  - Volume ..... 4-14
- 4.3 NAV Operation**..... 4-15
  - NAV Radio Selection and Activation ..... 4-15
  - NAV Receiver Manual Tuning ..... 4-16
  - Auto-Tuning the NAV Frequency ..... 4-18
  - Marker Beacon Receiver ..... 4-23
  - ADF/DME Tuning ..... 4-24
- 4.4 GTX 33 Mode S Transponder**..... 4-28
  - Transponder Controls ..... 4-28
  - Transponder Mode Selection ..... 4-29
  - Entering a Transponder Code ..... 4-31
  - IDENT Function ..... 4-33
  - Flight ID Reporting ..... 4-34
- 4.5 Additional Audio Panel Functions** ..... 4-35
  - Power-Up ..... 4-35



|  |      |   |       |
|--|------|---|-------|
| Mono/Stereo Headsets .....                       | 4-35 | <b>5.18 Nearest Airspaces (MFD)</b> .....   | 5-69  |
| Speaker .....                                    | 4-35 | General Notes on Airspace Alerts .....  | 5-70  |
| Intercom .....                                   | 4-36 | Airspace Type and Controlling Agency .....  | 5-71  |
| Passenger Address (PA) System .....              | 4-38 | General Notes on Associated Frequencies .....                                     | 5-73  |
| Clearance Recorder and Player .....              | 4-38 | <b>5.19 Nearest Airports (PFD)</b> .....  | 5-74  |
| Entertainment Inputs .....                       | 4-39 | Operations .....  | 5-74  |
| <b>4.6 Audio Panel Preflight Procedure</b> ..... | 4-40 | <b>5.20 Flight Planning (MFD)</b> .....   | 5-76  |
| <b>4.7 Abnormal Operation</b> .....              | 4-41 | Flight Planning Operations .....  | 5-76  |
| Stuck Microphone .....                           | 4-41 | AUX - Trip Planning Page .....  | 5-86  |
| COM Tuning Failure .....                         | 4-41 | Trip Statistics (Trip Stats) .....  | 5-87  |
| Audio Panel Fail-Safe Operation .....            | 4-41 | Fuel Statistics (Fuel Stats) .....  | 5-87  |
| Reversionary Mode .....                          | 4-41 | Other Statistics (Other Stats) .....  | 5-88  |
|  |      | Trip Planning Page Operations .....   | 5-88  |
|  |      | Utility Page .....  | 5-90  |
|  |      | Display of Airways on the Flight Plan Page .....                                  | 5-102 |
|  |      | Vertical Navigation (VNV) .....   | 5-105 |
|  |      | Navigating an Example Flight Plan .....   | 5-113 |
|  |      | Parallel Track (PTK) .....  | 5-140 |
|  |      | Arrival Alerts .....  | 5-143 |
|  |      | <b>5.21 Flight Planning (PFD)</b> .....   | 5-144 |
|  |      | Operations .....  | 5-144 |
|  |      | <b>5.22 Procedures (MFD)</b> .....  | 5-149 |
|  |      | Leg Types Supported by the G1000 .....  | 5-149 |
|  |      | Departures .....  | 5-150 |
|  |      | <b>5.23 Procedures (PFD)</b> .....  | 5-162 |
|  |      | <b>5.24 Abnormal Operation</b> .....  | 5-167 |
|  |      | Dead Reckoning .....  | 5-167 |
|  |      |   |       |
|  |      | <b>SECTION 6 HAZARD AVOIDANCE</b>   |       |
|  |      | <b>6.1 XM Satellite Weather (Optional)</b> .....                                  | 6-1   |
|  |      | Activating Services .....   | 6-1   |
|  |      | Using XM SATELLITE Weather Products .....   | 6-3   |
|  |      | Weather Softkeys on the Weather Data Link Page .....                              | 6-6   |
|  |      | <b>6.2 WX-500 Stormscope (Optional)</b> .....                                     | 6-25  |
|  |      | Setting Up Stormscope on the Navigation Map .....                                 | 6-25  |
|  |      | Selecting the Stormscope Page .....   | 6-29  |
|  |      | <b>6.3 Terrain Proximity</b> .....  | 6-30  |
|  |      | Displaying Terrain Proximity Data .....   | 6-31  |
|  |      | Terrain Proximity Page .....  | 6-33  |
|  |      | <b>6.4 Terrain Awareness and Warning System (TAWS</b><br><b>- Optional)</b> ..... | 6-35  |
|  |      | Displaying TAWS Data .....  | 6-36  |

TAWS Page ..... 6-38  
 TAWS Alerts ..... 6-40  
 System Status ..... 6-46  
**6.5 Traffic Information Service (TIS)** ..... 6-47  
 Displaying TRAFFIC Data ..... 6-48  
 Traffic Map Page ..... 6-50  
 TIS Alerts ..... 6-51  
 System Status ..... 6-52  
**6.6 Avidyne TAS600 Series Traffic Advisory System (Optional)** ..... 6-55  
 Displaying TRAFFIC Data ..... 6-56  
 Traffic Map Page ..... 6-58  
 TAS Alerts ..... 6-60  
 System Status ..... 6-61

**SECTION 7 AUTOMATIC FLIGHT CONTROL SYSTEM**

**7.1 AFCS Controls** ..... 7-2  
**7.2 Flight Director Operation** ..... 7-4  
 Activating the Flight Director ..... 7-4  
 Command Bars ..... 7-5  
 Flight Director Modes ..... 7-5  
**7.3 Pitch Modes** ..... 7-6  
 Pitch Hold Mode (PIT) ..... 7-7  
 Selected Altitude Capture Mode (ALTS) ..... 7-8  
 Altitude Hold Mode (ALT) ..... 7-9  
 Vertical Speed Mode (VS) ..... 7-10  
 Flight Level Change Mode (FLC) ..... 7-11  
 Vertical Navigation Modes (VPTH, ALTV) ..... 7-12  
 Glidepath Mode (GP) ..... 7-17  
 Glideslope Mode (GS) ..... 7-18  
 Go Around (GA) Mode ..... 7-19  
**7.4 Roll Modes** ..... 7-20  
 Roll Hold Mode (ROL) ..... 7-21  
 Heading Select Mode (HDG) ..... 7-22  
 Navigation Mode (GPS, VOR, LOC, BC) ..... 7-23  
 Approach Mode (GPS, VAPP, LOC) ..... 7-25  
**7.5 Autopilot Operation** ..... 7-27  
 Engaging the Autopilot ..... 7-27  
 Control Wheel Steering ..... 7-28  
 Disengaging the Autopilot ..... 7-28  
**7.6 Example Flight Plan** ..... 7-29  
 Departure ..... 7-30

Intercepting a VOR Radial ..... 7-32  
 Flying a Flight Plan/GPS Course ..... 7-33  
 Descent ..... 7-34  
 Approach ..... 7-38  
 Go Around/Missed Approach ..... 7-40  
**7.7 AFCS Annunciations and Alerts** ..... 7-42  
 AFCS Status Alerts ..... 7-42  
 Overspeed Protection ..... 7-43

**SECTION 8 ADDITIONAL FEATURES**

**8.1 SafeTaxi** ..... 8-1  
 SafeTaxi Cycle Number and Revision ..... 8-4  
**8.2 ChartView** ..... 8-7  
 ChartView Softkeys ..... 8-7  
 Terminal Procedures Charts ..... 8-8  
 Chart Options ..... 8-18  
 Day/Night View ..... 8-23  
 ChartView Cycle Number and Expiration Date ..... 8-25  
**8.3 FliteCharts** ..... 8-29  
 FliteCharts Softkeys ..... 8-29  
 Terminal Procedures Charts ..... 8-30  
 Chart Options ..... 8-38  
 Day/Night View ..... 8-41  
 FliteCharts Cycle Number and Expiration Date ..... 8-43  
**8.4 XM Radio Entertainment (Optional)** ..... 8-47  
 Activating XM Satellite Radio Services ..... 8-47  
 Using XM Radio ..... 8-49  
 Automatic Audio Muting ..... 8-53  
**8.5 Abnormal Operation** ..... 8-54

**APPENDICES**

**Annunciations and Alerts** ..... A-1  
**SD Card Use and Databases** ..... B-1  
**Glossary** ..... C-1  
**Frequently Asked Questions** ..... D-1  
**General TIS Information** ..... F-1  
**Map Symbols** ..... G-1

**INDEX**

## SECTION 1 SYSTEM OVERVIEW



**NOTE:** Refer to the *Automatic Flight Control System (AFCS) Section for details on the GFC 700 AFCS.*

The G1000 Integrated Flight Deck System presents flight instrumentation, position, navigation, communication, and identification information using flat-panel color displays. The system is distributed across the following Line Replaceable Units (LRUs):

- **GDU 1040** Primary Flight Display (PFD)
- **GDU 1040/1044** Multi Function Display (MFD)
- **GMA 1347** Audio Panel with Integrated Marker Beacon Receiver
- **GIA 63/63W** Integrated Avionics Units (IAU)
- **GDC 74A** Air Data Computer (ADC)
- **GEA 71** Engine/Airframe Unit
- **GTX 33** Mode S Transponder
- **GRS 77** Attitude and Heading Reference System (AHRS)
- **GMU 44** Magnetometer
- **GDL 69/69A** Data Link Receiver
- **GSA 81** AFCS Servos
- **GSM 85** Servo Mounts

Figure 1-1 shows interactions between the LRUs. Additional/optional equipment are shown in Figure 1-2.

The Diamond DA40/40F may be optionally equipped with a GFC 700 Automated Flight Control System (AFCS), providing flight director (FD), autopilot (AP), and manual electric trim (MET) functions of the G1000 System.

## 1.1 LINE REPLACEABLE UNITS

- **GDU 1040/1044** (2) – A GDU 1040 is configured as the Primary Flight Display (PFD) and a GDU 1040 or 1044 (for airframes equipped with the GFC 700) as a Multi Function Display (MFD). Both displays feature 10.4-inch LCD screens with 1024 x 768 resolution. The displays communicate with each other through a High-speed Data Bus (HSDB) Ethernet connection. Each display is also paired with an Ethernet connection to an IAU.



- **GMA 1347** – The Audio Panel integrates navigation/communication radio (NAV/COM) digital audio, intercom, and marker beacon controls, and is installed between the displays. This unit also provides manual control of display Reversionary Mode (red **DISPLAY BACKUP** button; see Section 1.4, System Operation) and communicates with both IAUs using an RS-232 digital interface.



- **GIA 63/63W** (2) – The Integrated Avionics Units (IAU) function as the main communications hub, linking all LRUs with the PFD. Each IAU contains a GPS receiver, a very high frequency (VHF) communication/navigation/glideslope (COM/NAV/GS) receiver, and system integration microprocessors, and is paired with the on-side display via an HSDB connection. Each GIA 63W contains a GPS WAAS receiver. The IAUs are not paired together and do not communicate with each other directly.



**GDC 74A** – The Air Data Computer (ADC) processes data from the pitot/static system and outside air temperature (OAT) sensor. The ADC provides pressure altitude, airspeed, vertical speed, and OAT information to the G1000 System, and it communicates with the primary IAU, displays, and AHRS using an ARINC 429 digital interface.



- **GEA 71** – The Engine Airframe Unit receives and processes signals from the engine and airframe sensors. This unit communicates with both IAUs using an RS-485 digital interface.



- **GTX 33** – The solid-state Transponder provides Modes A, C, and S capability and communicates with both IAUs through an RS-232 digital interface.



- **GRS 77 (2)** – The Attitude and Heading Reference System (AHRS) provides aircraft attitude and heading information via ARINC 429 to both the PFD and the primary IAU. The AHRS contains advanced sensors (including accelerometers and rate sensors) and interfaces with the Magnetometer to obtain magnetic field information, with the ADC to obtain air data, and with both IAUs to obtain GPS information. AHRS operation is discussed in Section 1.4, System Operation.



- **GMU 44** – The Magnetometer measures local magnetic field and sends data to the AHRS for processing to determine aircraft magnetic heading. This unit receives power directly from the AHRS and communicates with it via an RS-485 digital interface.



- **GDL 69/69A** – The Data Link Satellite Radio Receiver provides real-time weather information to MFD maps and the PFD Inset Map. The GDL 69A model is also capable of providing digital audio entertainment. The Data Link Receiver communicates with the MFD via an HSDB connection. A subscription to XM Satellite Radio Service is required to enable Data Link Receiver capability.



- **GSA 81** and **GSM 85** – The GSA 81 servos are used for automatic control of pitch, pitch trim, and roll. These units interface with each IAU.

The GSM 85 servo mounts are responsible for transferring the output torque of the servo actuators to the mechanical flight-control surface linkages.



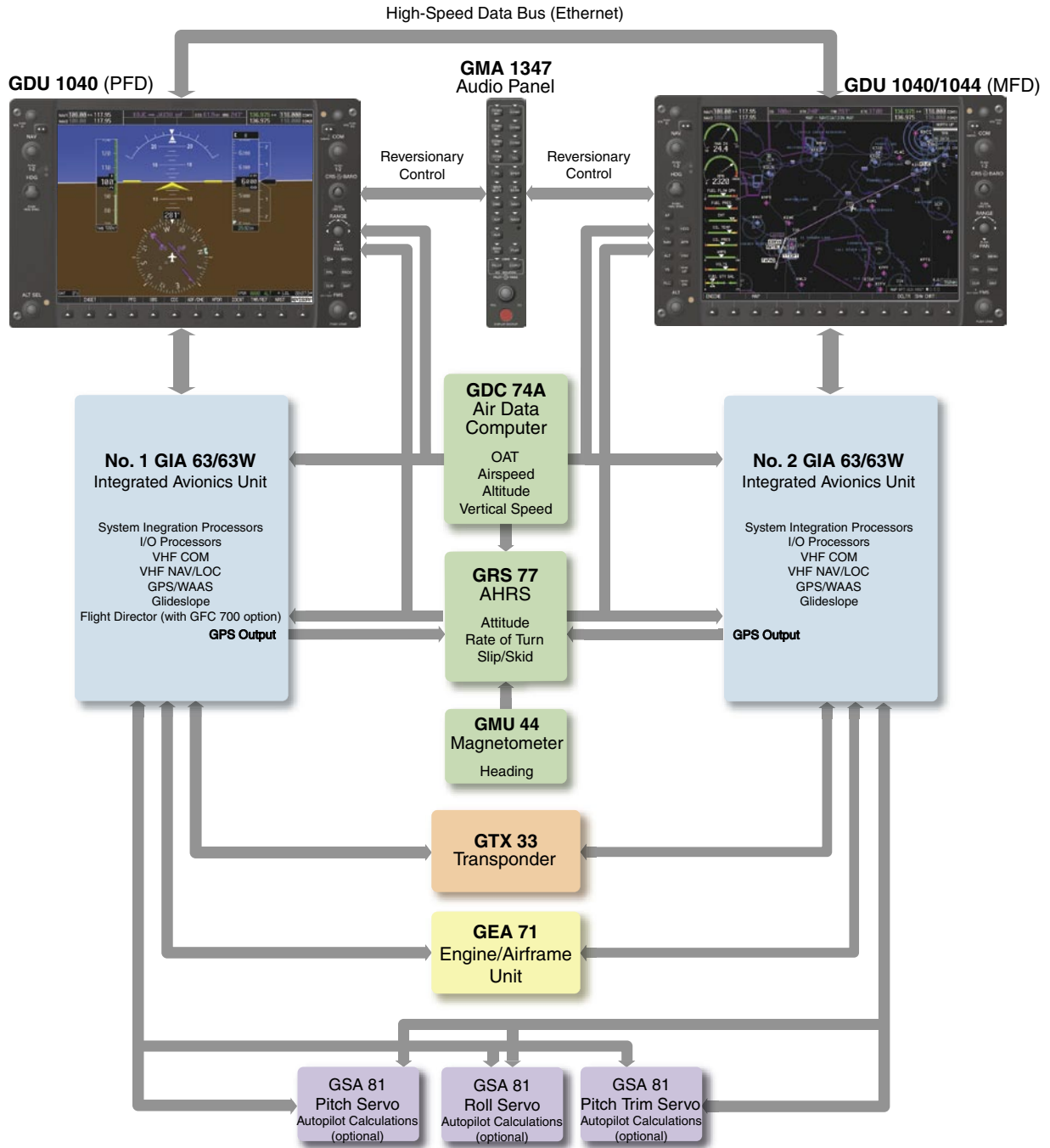

Figure 1-1 G1000 System Block Diagram



**NOTE:** The GDU 1044 is available in systems using the Garmin GFC 700 Automatic Flight Control System.

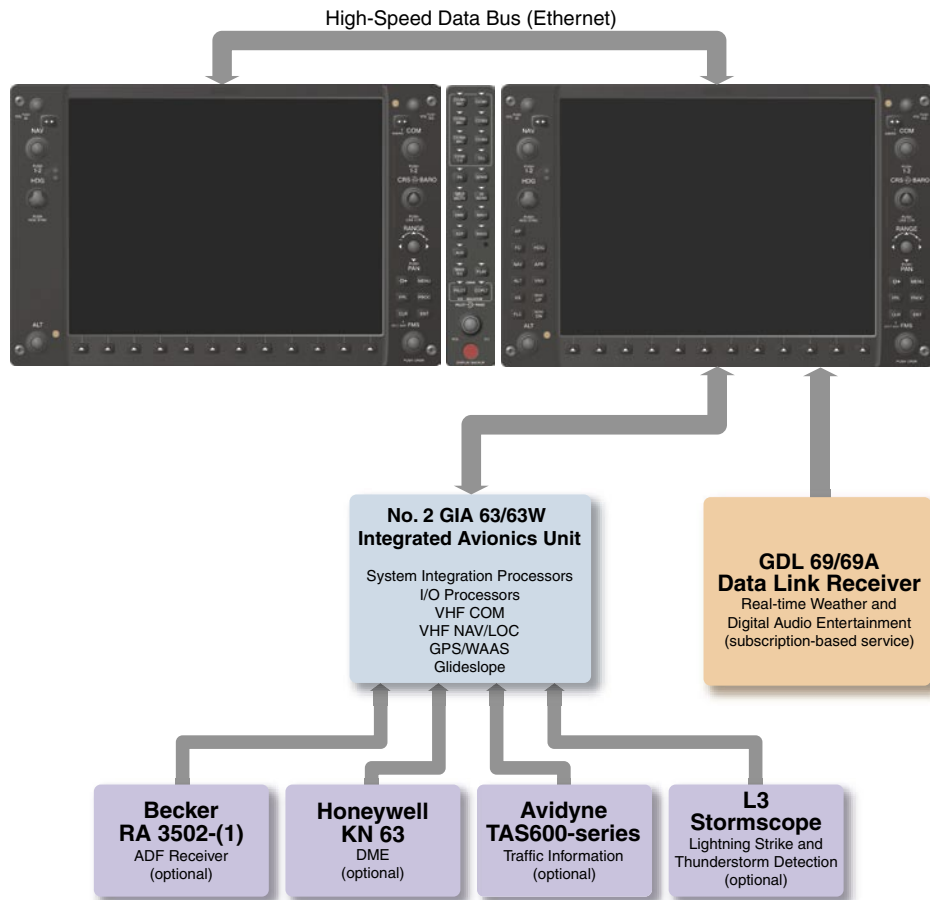

Figure 1-2 G1000 With Optional/Additional Interfaces



**NOTE:** For information on additional equipment shown in Figure 1-2, consult the applicable optional interface user’s guide. This document assumes that the reader is already familiar with the operation of this additional equipment.



## 1.2 SECURE DIGITAL (SD) CARDS



**NOTE:** Ensure the G1000 System is powered off before inserting an SD card.



**NOTE:** Refer to Appendix B for instructions on updating databases.

The PFD and MFD data card slots use Secure Digital (SD) cards and are located on the upper right side of the display bezels. Each display bezel is equipped with two SD card slots. SD cards are used for aviation database and system software updates as well as terrain database storage.

### Installing an SD card:

- 1) Insert the SD card in the SD card slot, pushing the card in until the spring latch engages. The front of the card should remain flush with the face of the display bezel.
- 2) To eject the card, gently press on the SD card to release the spring latch.



Figure 1-3 Display Bezel SD Card Slots

### 1.3 SYSTEM POWER-UP

**NOTE:** See the Aircraft Flight Manual (AFM) for specific procedures concerning avionics power application and emergency power supply operation.

**NOTE:** Refer to Appendix A for system-specific annunciations and alerts.

The G1000 System is integrated with the aircraft electrical system and receives power directly from electrical busses. The PFD, MFD, and supporting sub-systems include both power-on and continuous built-in test features that exercise the processor, RAM, ROM, external inputs, and outputs to provide safe operation.

During system initialization, test annunciations are displayed, as shown in Figure 1-4. All system annunciations should disappear typically within the first minute of power-up. Upon power-up, key annunciator lights also become momentarily illuminated on the Audio Panel and the display bezels.

On the PFD, the AHRS begins to initialize and displays “AHRS ALIGN: Keep Wings Level”. The AHRS should display valid attitude and heading fields typically within the first minute of power-up. The AHRS can align itself both while taxiing and during level flight.

When the MFD powers up, the splash screen (Figure 1-5) displays the following information:

- System version
- Copyright
- Land database name and version
- Obstacle database name and version
- Terrain database name and version
- Aviation database name, version, and effective dates

Current database information includes valid operating dates, cycle number, and database type. When this information has been reviewed for currency (to ensure that no databases have expired), the pilot is prompted to continue.

Pressing the **ENT** Key (or right-most softkey) acknowledges this information, and the Navigation Map Page is displayed upon pressing the key a second time. When the system has acquired a sufficient number of satellites to determine a position, the aircraft’s current position is shown on the Navigation Map Page.

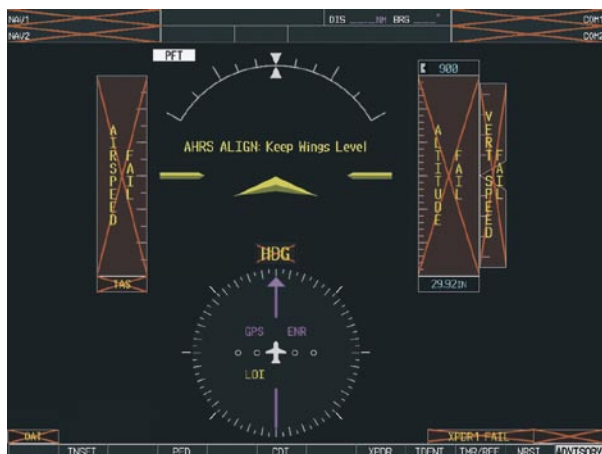

Figure 1-4 PFD Initialization



Figure 1-5 Example MFD Power-up Splash Screen

## 1.4 SYSTEM OPERATION



**NOTE:** Refer to Appendix A for detailed descriptions of all alerts and annunciations. Refer to the Aircraft Flight Manual (AFM) for additional information regarding pilot responses to these annunciations.

The displays are connected together via a single Ethernet bus for high-speed communication. As shown in Figure 1-1, each IAU is connected to the on-side display. This allows the units to share information, enabling true system integration

### NORMAL DISPLAY OPERATION

In normal operating mode, the PFD presents graphical flight instrumentation (attitude, heading, airspeed, altitude, vertical speed), replacing the traditional flight instrument cluster (see the Flight Instruments Section for more information). The MFD normally displays a full-color moving map with navigation information (see the GPS Navigation Section), while the left portion of the MFD is dedicated to the Engine Indication System (EIS; see the EIS Section). Both displays offer control for COM and NAV frequency selection.



Figure 1-6 G1000 Normal Operation

### REVERSIONARY DISPLAY OPERATION

In the event of a display failure, the G1000 System automatically switches to reversionary (backup) mode. In Reversionary Mode, all important flight information from the PFD is presented on the remaining display in the same format as in normal operating mode, with the addition of the EIS. EIS operation while in Reversionary Mode is discussed in the EIS Section. As when the PFD is operating normally, windows for flight planning, nearest airports, and procedures are available. The Inset Map is moved to the right side of the display.

If a display fails, the appropriate IAU-display Ethernet interface is cut off. Thus, the IAU can no longer communicate with the remaining display (refer to Figure 1-1), and the NAV and COM functions provided to the failed display by the IAU are flagged as invalid on the remaining display. The system reverts to backup paths for the AHRS, ADC, Engine/Airframe Unit, and Transponder, as required. The change to backup paths is completely automated for all LRUs and no pilot action is required.

If the system fails to detect a display problem, Reversionary Mode may be manually activated by pressing the Audio Panel's red **DISPLAY BACKUP** Button. Pressing this button again deactivates Reversionary Mode.



*DISPLAY BACKUP* Button Manually Activates/Deactivates Reversionary Mode on Both Displays

Figure 1-7 G1000 Reversionary Mode (Failed PFD)

## G1000 SYSTEM ANNUNCIATIONS

When an LRU or an LRU function fails, a large red 'X' is typically displayed over the instrument experiencing failed data (Figure 1-8 displays all possible flags and responsible LRUs). The G1000 System alerts the pilot when backup paths are utilized by the LRUs. Upon G1000 power-up, certain instruments remain invalid as equipment begins to initialize. All instruments should be operational within one minute of power-up. If any instrument remains flagged, the G1000 should be serviced by a Garmin-authorized repair facility.

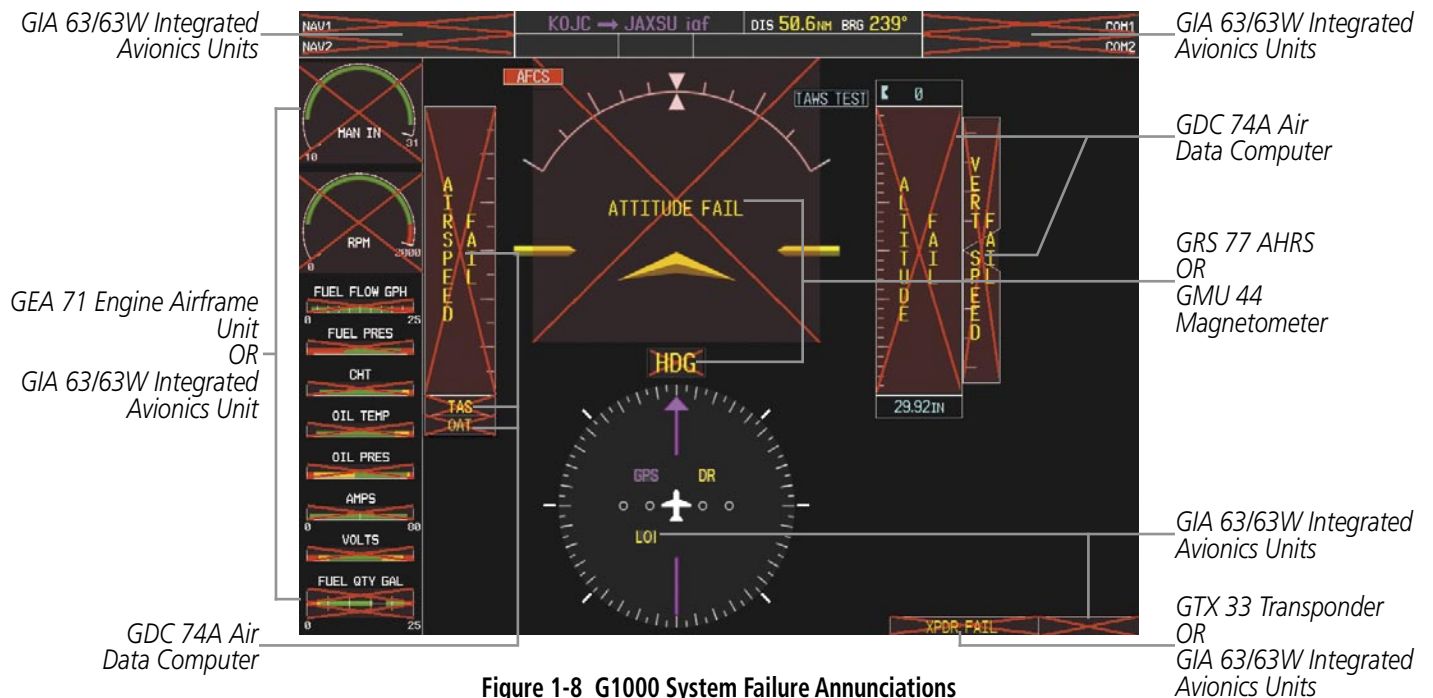

Figure 1-8 G1000 System Failure Annunciations

**SYSTEM STATUS**

The System Status Page displays the statuses, serial numbers, and software version numbers for all detected system LRUs. Active LRUs are indicated by green check marks; failed, by red 'X's. Failed LRUs should be noted and a service center or Garmin-authorized dealer informed.

**Viewing LRU information:**

- 1) Use the large **FMS** Knob on the MFD to select the Auxiliary (AUX) Page Group (see Section 1.6 for information on MFD page groups).
- 2) Use the small **FMS** Knob to select the System Status Page (last page in the AUX Page Group).
- 3) To place the cursor in the 'LRU Info' Box, press the **LRU** Softkey.
  - OR:**
  - a) Press the **MENU** Key.
  - b) With 'Select LRU Window' highlighted, press the **ENT** Key.
- 3) Use the **FMS** Knob to scroll through the box to view LRU status information.



Figure 1-9 Example System Status Page

Pertinent information on all system databases is also displayed on this page. Refer to the Appendices and Additional Features sections for more information about databases.

### Viewing database information:

- 1) Select the AUX - System Status Page.
- 2) To place the cursor in the 'Database' Box, press the **DBASE** Softkey.

**OR:**

- a) Press the **MENU** Key.
- b) Highlight 'Select Dbase Window' and press the **ENT** Key.
- 3) Use the **FMS** Knob to scroll through the box to view database status information.

The G1000 uses aural tones to convey the priority of airframe-specific alerts. The alerting system's annunciation tone may be tested from the System Status Page. Refer to the Appendices for airframe-specific alerts.

### Testing the system annunciation tone:

- 1) Select the AUX - System Status Page.
- 2) Press the **ANN TEST** Softkey.

**OR:**

- a) Press the **MENU** Key.
- b) Highlight 'Enable Annunciator Test Mode' and press the **ENT** Key.

**AHRS OPERATION**

**NOTE:** Aggressive maneuvering while AHRS is not operating normally may degrade AHRS accuracy.

The Attitude and Heading Reference System (AHRS) performs attitude, heading, and vertical acceleration calculations for the G1000 System, utilizing GPS, magnetometer, and air data in addition to information from its internal sensors. Attitude and heading information are updated on the PFD while the AHRS receives appropriate combinations of information from the external sensor inputs.

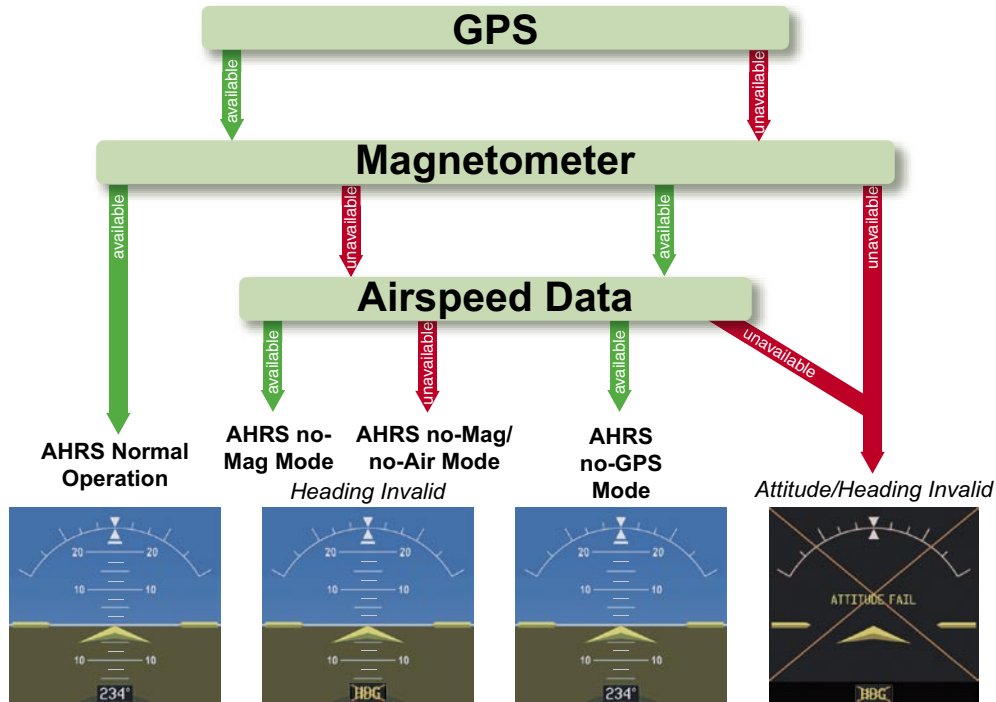

**Figure 1-10 AHRS Operation**

Loss of GPS, magnetometer, or air data inputs is communicated to the pilot by message advisory alerts (refer to Appendix A for specific AHRS alert information). Any failure of the internal AHRS inertial sensors results in loss of attitude and heading information (indicated by red 'X' flags over the corresponding flight instruments).

Two GPS inputs are provided to the AHRS. If GPS information from one of the inputs fails, the AHRS uses the remaining GPS input and an alert message is issued to inform the pilot. If both GPS inputs fail, the AHRS can continue to provide attitude and heading information to the PFD as long as magnetometer and airspeed data are available and valid.

If the magnetometer input fails, the AHRS continues to output valid attitude information; however, the heading output on the PFD is flagged as invalid with a red 'X'.

Failure of the air data input has no effect on the AHRS output while AHRS is receiving valid GPS information. Invalid/unavailable airspeed data in addition to GPS failure results in loss of all attitude and heading information.

## GPS RECEIVER OPERATION

Each Integrated Avionics Unit (IAU) contains a GPS receiver. Internal system checking is performed to ensure both GPS receivers are providing accurate data to the PFD. When both GPS receivers are providing accurate data, the GPS receiver producing the better solution is used by the system. Information collected by the specified receiver (GPS1 for the #1 IAU or GPS2 for the #2 IAU) may be viewed on the AUX - GPS Status Page.

### Viewing GPS receiver status information:

- 1) Use the large **FMS** Knob on the MFD to select the Auxiliary (AUX) Page Group (see Section 1.6 for information on MFD page groups).
- 2) Use the small **FMS** Knob to select the GPS Status Page (third page in the AUX Page Group).
- 3) To change the selected GPS receiver, press the desired **GPS** Softkey.

OR:

- a) Press the **MENU** Key.
- b) Use the **FMS** Knob to highlight the receiver which is not selected and press the **ENT** Key.

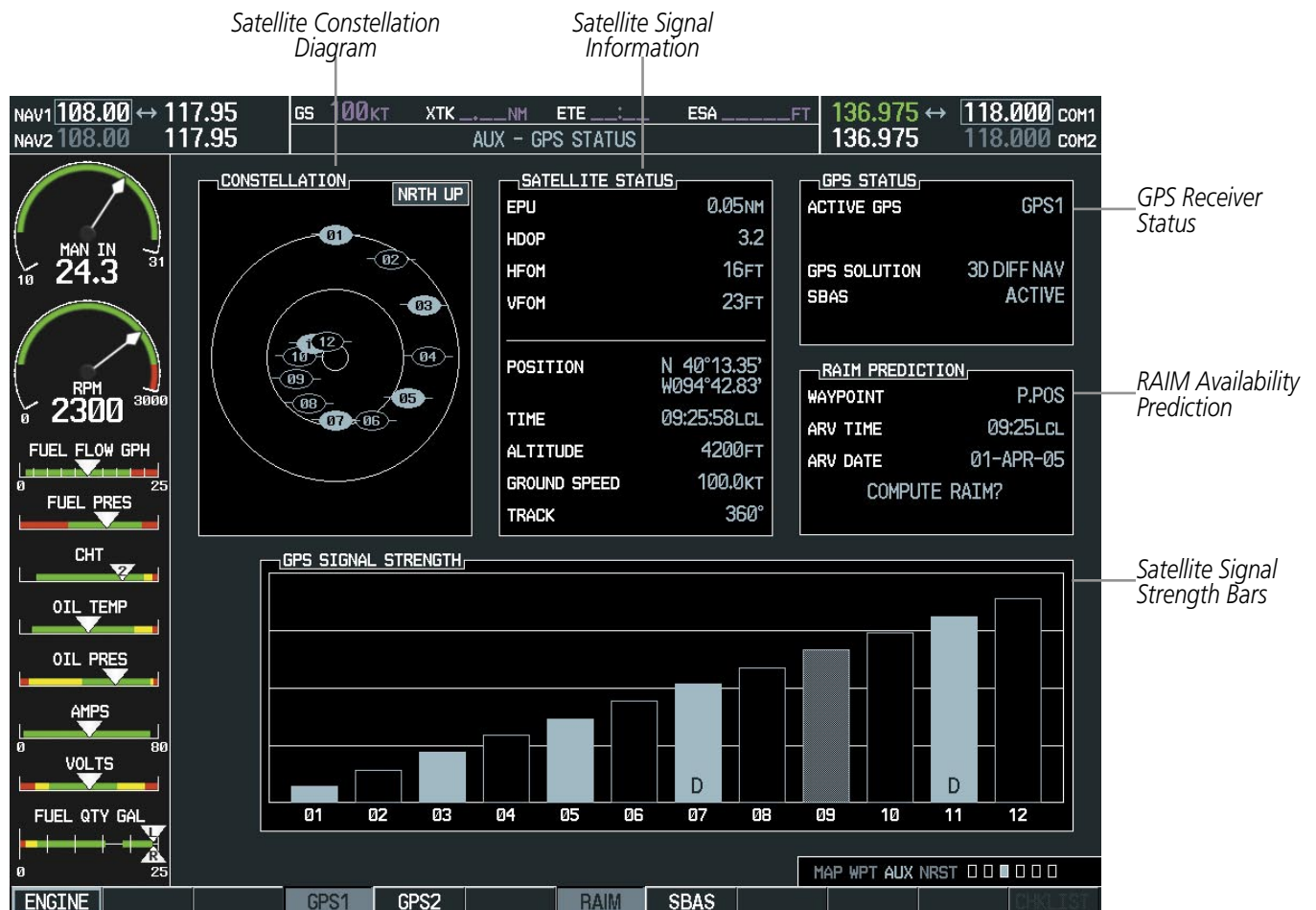

Figure 1-11 GPS Status Page



For WAAS-enabled systems, GPS sensor annunciations are most often seen after system power-up when one GPS receiver has acquired satellites before the other or one of the GPS receivers has not yet acquired a WAAS signal. While the aircraft is on the ground, the WAAS signal may be blocked by obstructions causing one GPS receiver to have difficulty acquiring a good signal. Also, while airborne, turning the aircraft may result in one of the GPS receivers temporarily losing the WAAS signal. If no failure message exists, check the GPS Status Page and compare the information for GPS1 and GPS2. Discrepancies may indicate a problem.

## GPS RECEIVER STATUS

The GPS solution type (ACQUIRING, 2D NAV, 2D DIFF NAV, 3D NAV, 3D DIFF NAV) for the active GPS receiver (GPS1 or GPS2) is shown in the upper right of the GPS Status Page. When the receiver is in the process of acquiring enough satellite signals for navigation, the receiver uses satellite orbital data (collected continuously from the satellites) and last known position to determine the satellites that should be in view. ACQUIRING is indicated as the solution until a sufficient number of satellites have been acquired for computing a solution.

When the receiver is in the process of acquiring a 3D navigational GPS solution, 3D NAV is indicated as the solution until the 3D differential fix has finished acquisition. Satellite-Based Augmentation System (SBAS) status should be indicated as INACTIVE at this point. When acquisition is complete, the solution status changes to 3D DIFF NAV and SBAS becomes active.

In certain situations, such as when the aircraft is outside or on the fringe of the WAAS coverage area, it may be desirable to disable WAAS (although it is not recommended). When disabled, the SBAS field in the GPS Status box indicates DISABLED.

### Disabling WAAS (for WAAS-enabled systems):

- 1) Select the GPS Status Page.
- 2) Press the **SBAS** Softkey. The RAIM PREDICTION box is replaced by SBAS SELECTION.
- 3) Press the **FMS** Knob. 'WAAS' is highlighted.
- 4) Press the **ENT** Key to uncheck the box.
- 5) Press the **FMS** Knob to remove the cursor.



Figure 1-12 Enable/Disable WAAS

## RAIM PREDICTION

Receiver Autonomous Integrity Monitoring (RAIM) is a GPS receiver function that performs a consistency check on all tracked satellites. RAIM ensures that the available satellite geometry allows the receiver to calculate a position within a specified RAIM protection limit (2.0 nautical miles for oceanic and enroute, 1.0 nm for terminal, and 0.3 nm for non-precision approaches). During oceanic, enroute, and terminal phases of flight, RAIM is available nearly 100% of the time.

The RAIM prediction function also indicates whether RAIM is available at a specified date and time. RAIM computations predict satellite coverage within  $\pm 15$  min of the specified arrival date and time. In G1000 systems with WAAS enabled, performing RAIM prediction is not necessary in most cases. However, if the selected approach is outside the WAAS coverage area, it may be necessary to perform a RAIM prediction for the intended approach.

Because of the tighter protection limit on approaches, there may be times when RAIM is not available. The G1000 automatically monitors RAIM and warns with an alert message when it is not available. If RAIM is not predicted to be available for the final approach course, the approach does not become active, as indicated by the messages “Approach is not active”. If RAIM is not available when crossing the FAF, the missed approach procedure must be flown.

### Predicting RAIM availability:

- 1) Select the GPS Status Page.
- 2) Press the **RAIM** Softkey.
- 2) Press the **FMS** Knob. The ‘WAYPOINT’ field is highlighted.
- 3) Turn the small **FMS** Knob to display the Waypoint Information Window.
- 4) Enter the desired waypoint and press the **ENT** Key (refer to Section 1.6 for instructions on data entry).

#### OR:

- a) To use the present position, press the **MENU** Key.
- b) With ‘Set WPT to Present Position’ highlighted, press the **ENT** Key.
- c) Press the **ENT** Key to accept the waypoint entry.
- 5) Enter an arrival time and press the **ENT** Key.
- 6) Enter an arrival date and press the **ENT** Key.
- 7) With the cursor highlighting ‘COMPUTE RAIM?’, press the **ENT** Key. Once RAIM availability is computed, one of the following is displayed:
  - ‘COMPUTE RAIM?’—RAIM has not been computed for the current waypoint, time, and date combination
  - ‘COMPUTING AVAILABILITY’—RAIM calculation in progress
  - ‘RAIM AVAILABLE’—RAIM is predicted to be available for the specified waypoint, time, and date
  - ‘RAIM NOT AVAILABLE’—RAIM is predicted to be unavailable for the specified waypoint, time, and date

## SATELLITE INFORMATION

Satellites currently in view are shown at their respective positions on a satellite constellation diagram. This sky view is always oriented north-up, with the outer circle representing the horizon, the inner circle representing 45° above the horizon, and the center point showing the position directly overhead. Each satellite is represented by an oval containing the Pseudo-random noise (PRN) number (i.e., satellite identification number). Satellites whose signals are currently being used are represented by solid ovals.

The GPS Status Page can be helpful in troubleshooting weak (or missing) signal levels due to poor satellite coverage or installation problems. As the GPS receiver locks onto satellites, a signal strength bar is displayed for each satellite in view, with the appropriate satellite PRN number (01-32 or 120-138 for WAAS) below each bar. The progress of satellite acquisition is indicated by signal bar appearance:

- No signal strength bar—Receiver is looking for the indicated satellite.
- Hollow signal strength bar—Receiver has found the satellite and is collecting data. Each satellite has a 30-second data transmission that must be collected (signal strength bar is hollow) before the satellite may be used for navigation (signal strength bar becomes solid).
- Solid signal strength bar—Receiver has collected the necessary data and the satellite signal can be used.
- Checkered signal strength bar—Receiver has excluded the satellite (Fault Detection and Exclusion; FDE).
- “D” indication on signal strength bar—Satellite is being used for differential computations.

Using the current satellite signal information, the system calculates the aircraft's GPS position, time, altitude, ground speed, and track for the aircraft (displayed below the satellite signal accuracy measurements for reference). The following quantities denote the accuracy of the aircraft's GPS fix:

- Estimated Position Uncertainty (EPU)—A statistical error indication; the radius of a circle centered on an estimated horizontal position in which actual position has 95% probability of lying
- Horizontal Dilution of Precision (HDOP)—Measures satellite geometry quality (i.e., number of satellites received and where they are relative to each other) on a range from 0.0 to 9.9, with lower numbers denoting better accuracy
- Horizontal and Vertical Figures of Merit (HFOM and VFOM)—Measures of horizontal and vertical position uncertainty; the current 95% confidence horizontal and vertical accuracy values reported by the GPS receiver

## 1.5 G1000 CONTROLS

The G1000 controls have been designed to simplify operation of the system and minimize workload and the time required to access sophisticated functionality. Controls are located on the PFD and MFD bezels and Audio Panel. PFD and MFD controls and softkeys are discussed in this section. See the Audio Panel and CNS Section for more information about Audio Panel and NAV/COM controls. AFCS controls (on the bezel of the MFD) are described in the AFCS section.

### PFD/MFD CONTROLS

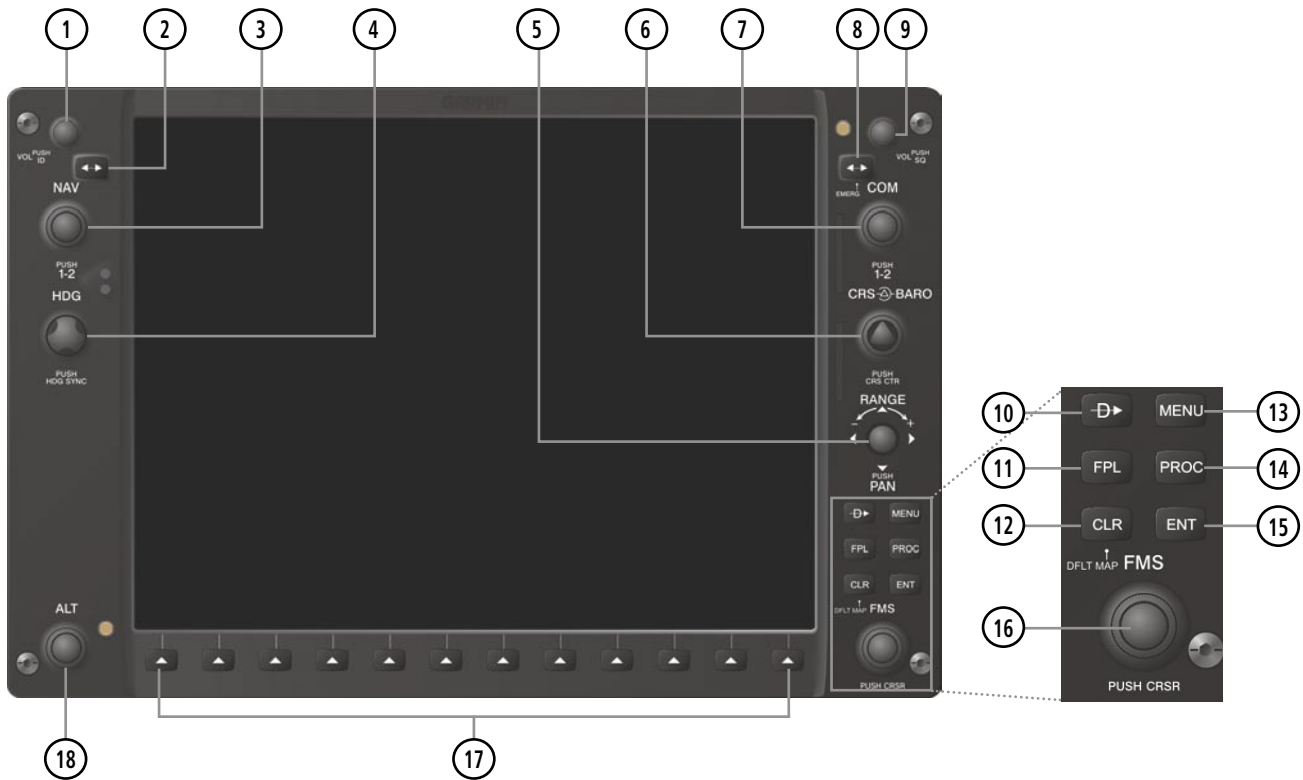

Figure 1-13 PFD/MFD Controls

The **NAV**, **CRS/BARO**, **COM**, **FMS**, and **ALT** knobs are concentric dual knobs, each having small (inner) and large (outer) control portion. When a portion of the knob is not specified in the text, either may be used.

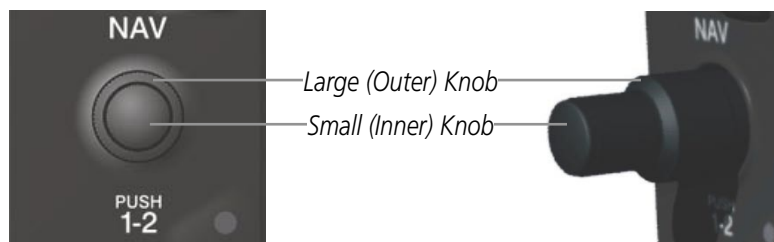



Figure 1-14 Dual Concentric Knob

- ① **NAV VOL/ID Knob** Turn to control NAV audio volume (shown in the NAV Frequency Box as a percentage)  
Press to toggle Morse code identifier audio on/off
- ② **NAV Frequency Transfer Key** Transfers the standby and active NAV frequencies
- ③ **NAV Knob** Turn to tune NAV receiver standby frequencies (large knob for MHz; small for kHz)  
Press to toggle light blue tuning box between NAV1 and NAV2
- ④ **Heading Knob** Turn to manually select a heading  
Press to display a digital heading momentarily to the left of the Horizontal Situation Indicator (HSI) and synchronize the Selected Heading to the and current heading
- ⑤ **Joystick** Turn to change map range  
Press to activate Map Pointer and move in desired direction to pan map
- ⑥ **CRS/BARO Knob** Turn large knob for altimeter barometric pressure setting  
Turn small knob to adjust course (only when HSI is in VOR or OBS Mode)  
Press to re-center the CDI and return course pointer directly to bearing of active waypoint/station
- ⑦ **COM Knob** Turn to tune COM transceiver standby frequencies (large knob for MHz; small for kHz)  
Press to toggle light blue tuning box between COM1 and COM2  
The selected COM (green) is controlled with the **COM MIC** Key (Audio Panel).
- ⑧ **COM Frequency Transfer Key (EMERG)** Transfers the standby and active COM frequencies  
Press and hold two seconds to tune the emergency frequency (121.5 MHz) automatically into the active frequency field
- ⑨ **COM VOL/SQ Knob** Turn to control COM audio volume level (shown as a percentage in the COM Frequency Box)  
Press to turn the COM automatic squelch on/off
- ⑩ **Direct-to Key**  Activates the direct-to function and allows the user to enter a destination waypoint and establish a direct course to the selected destination (specified by identifier, chosen from the active route)
- ⑪ **FPL Key** Displays flight plan information
- ⑫ **CLR Key (DFLT MAP)** Erases information, cancels entries, or removes menus  
Press and hold to display the MFD Navigation Map Page (MFD only).
- ⑬ **MENU Key** Displays a context-sensitive list of options for accessing additional features or making setting changes
- ⑭ **PROC Key** Gives access to IFR departure procedures (DPs), arrival procedures (STARs), and approach procedures (IAPs) for a flight plan or selected airport
- ⑮ **ENT Key** Validates/confirms selection or data entry

- ⑩ **FMS Knob (Flight Management System Knob)** Press to turn the selection cursor on/off

**Data Entry:** With cursor on, turn to enter data in the highlighted field (large knob moves cursor location; small knob selects character for highlighted cursor location)

**Scrolling:** When a list of information is too long for the window/box, a scroll bar appears, indicating more items to view. With cursor on, turn large knob to scroll through the list.

**Page Selection:** Turn knob on MFD to select the page to view (large knob selects a page group; small knob selects a specific page from the group)
- ⑪ **Softkey Selection Keys** Press to select softkey shown above the bezel key on the PFD/MFD display
- ⑫ **ALT Knob** Sets the Selected Altitude, shown above the Altimeter (the large knob selects the thousands, the small knob selects the hundreds)

## SOFTKEY FUNCTION

The softkeys are located along the bottoms of the displays. The softkeys shown depend on the softkey level or page being displayed. The bezel keys below the softkeys can be used to select the appropriate softkey. When a softkey is selected, its color changes to black text on gray background and remains this way until it is turned off, at which time it reverts to white text on black background. When a softkey function is disabled, the softkey label is subdued (dimmed).

Softkeys revert to the previous level after 45 seconds of inactivity.



Figure 1-15 Softkeys (Second-Level PFD Configuration)

In the following descriptions, top level softkeys are denoted with bullets.

## PFD SOFTKEYS

The **CDI**, **IDENT**, **TMR/REF**, **NRST**, and **ALERTS** softkeys undergo a momentary change to black text on gray background and automatically switch back to white text on black background when selected.

The PFD softkeys provide control over flight management functions, including GPS, NAV, terrain, traffic, and lightning (optional). Each softkey sublevel has a **BACK** Softkey which can be selected to return to the previous level. The **ALERTS** Softkey is visible at all softkey levels (label changes if messages are issued).

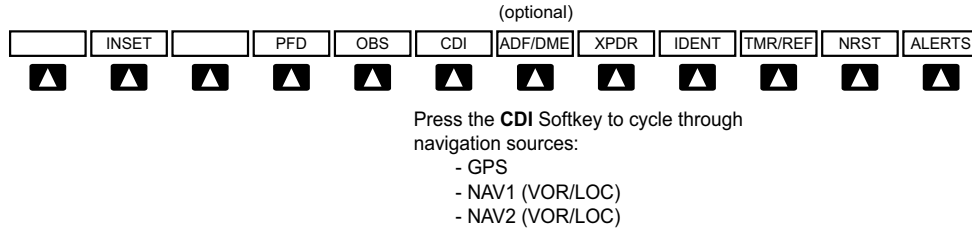

Figure 1-16 Top Level PFD Softkeys

- **INSET** Displays Inset Map in PFD lower left corner
- OFF** Removes Inset Map
- DCLTR (3)** Selects desired amount of map detail; cycles through declutter levels:
  - DCLTR (No Declutter): All map features visible
  - DCLTR-1: Removes land data
  - DCLTR-2: Removes land and SUA data
  - DCLTR-3: Removes everything except active flight plan
- TRAFFIC** Displays/removes traffic information on Inset Map
- TOPO** Displays/removes topographical data (e.g., coastlines, terrain, rivers, lakes) on Inset Map
- TERRAIN** Displays/removes terrain information on Inset Map
- STRMSCP** Displays/removes Stormscope weather information on Inset Map (optional)
- NEXRAD** Displays/removes NEXRAD weather and coverage information on Inset Map (optional)
- XM LTNG** Displays/removes XM lightning information on Inset Map (optional)

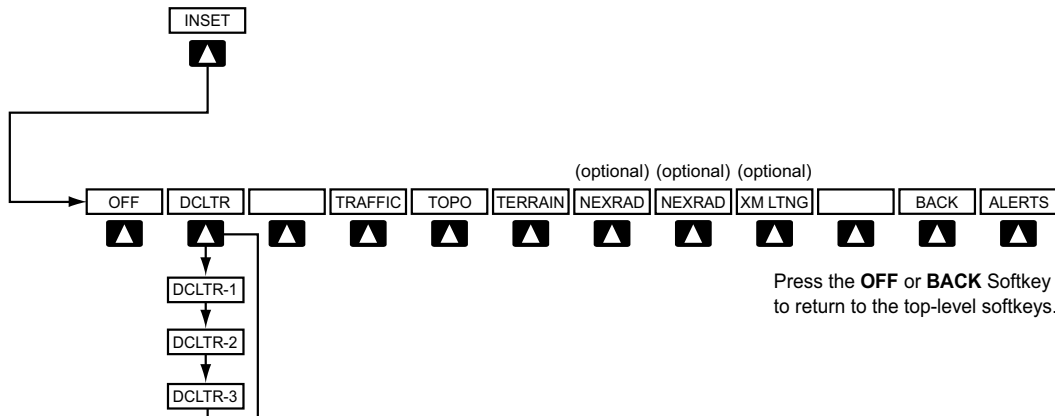

Figure 1-17 INSET Softkeys

- **PFD** Displays second-level softkeys for additional PFD configuration
- DFLT5** Resets PFD to default settings, including changing units to standard
- WIND** Displays softkeys to select and configure wind data
  - OPTN1** Displays wind data in longitudinal and lateral components
  - OPTN2** Displays wind data total direction and speed
  - OPTN3** Displays wind data total direction with head and cross-wind speed components
  - OFF** Removes wind information from display
- DME** Displays/removes DME Information Window (*optional*)
- BRG1** Cycles the Bearing 1 Information Window through:
  - NAV1: Waypoint frequency/identifier and DME information
  - GPS: Waypoint identifier and GPS distance information
  - ADF: Waypoint frequency
  - Off: Removes window
- HSI FMT** Displays softkeys to select the HSI format
  - 360 HSI** Displays HSI as a 360° compass rose
  - ARC HSI** Displays HSI as a 140° viewable arc (Bearing Information windows unavailable)
- BRG2** Cycles the Bearing 2 Information Window through:
  - NAV2: Waypoint frequency/identifier and DME information
  - GPS: Waypoint identifier and GPS distance information
  - ADF: Waypoint frequency
  - Off: Removes window
- ALT UNIT** Displays softkeys for changing the Altimeter barometric setting and altitude displays to metric units
  - METERS** Displays the current and Selected altitudes in meters in addition to feet, when selected
  - IN** Displays the Altimeter barometric setting in inches of mercury (in Hg)
  - HPA** Displays the Altimeter barometric setting in hectopascals (hPa)
- STD BARO** Sets barometric pressure to 29.92 in Hg (1013 hPa if metric display is selected)
- **OBS** Selects OBS Mode on the CDI when navigating by GPS (only available with active leg)
- **CDI** Cycles CDI through GPS, NAV1 (VOR/LOC), and NAV2 (VOR/LOC) navigation sources
- **ADF/DME** Displays/removes ADF/DME Radio Tuning Window (*optional*; may appear as **ADF**, **DME**, or **ADF/DME** depending on installation)



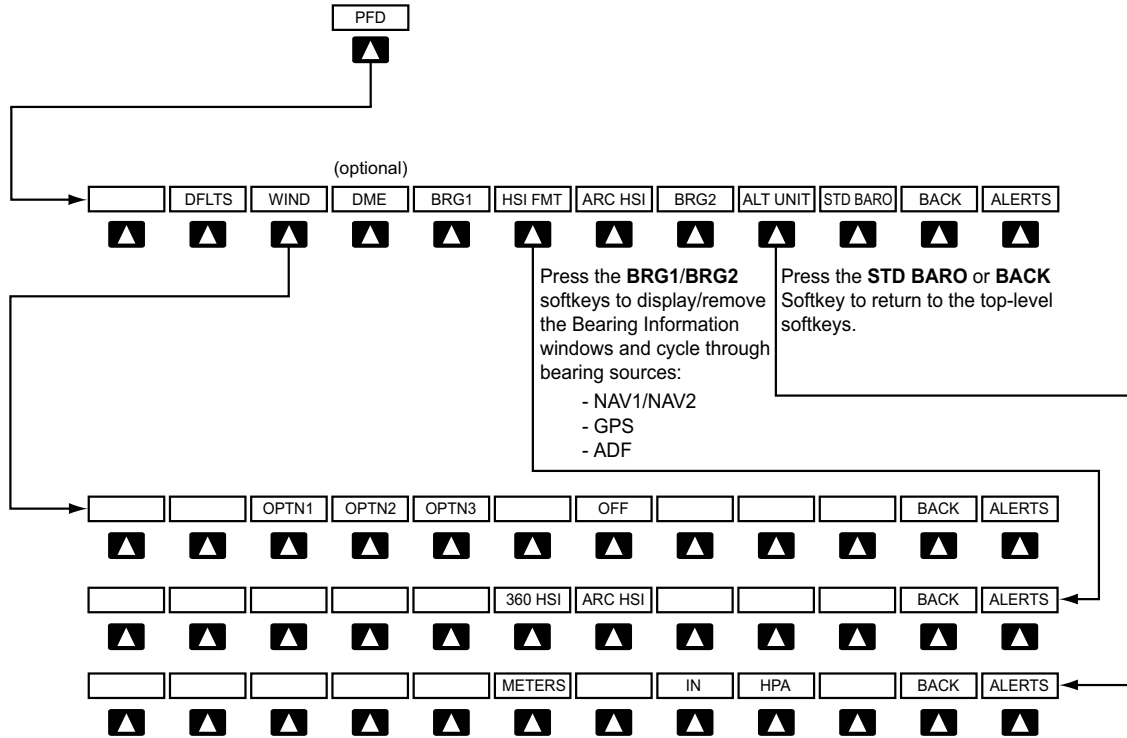

Figure 1-18 PFD Configuration Softkeys

- **XPDR** Displays transponder mode selection softkeys:
- STBY** Selects standby mode (Transponder does not reply to any interrogations)
- ON** Selects Mode A (Transponder replies to interrogations)
- ALT** Selects Mode C – altitude reporting mode (Transponder replies to identification and altitude interrogations)
- GND** Manually selects Ground Mode (Transponder does not allow Mode A and Mode C replies, but does permit acquisition squitter and replies to discretely addressed Mode S interrogations)
- VFR** Automatically enters the VFR code (1200 in U.S.A. only)
- CODE** Displays transponder code selection softkeys 0-7
- 0 — 7** Use numbers to enter code
- BKSP** Removes numbers entered, one at a time
- **IDENT** Activates the Special Position Identification (SPI) pulse for 18 seconds, identifying the transponder return on the ATC screen
- **TMR/REF** Displays/removes Timer/References Window
- **NRST** Displays/removes Nearest Airports Window
- **ALERTS** Displays/removes Alerts Window

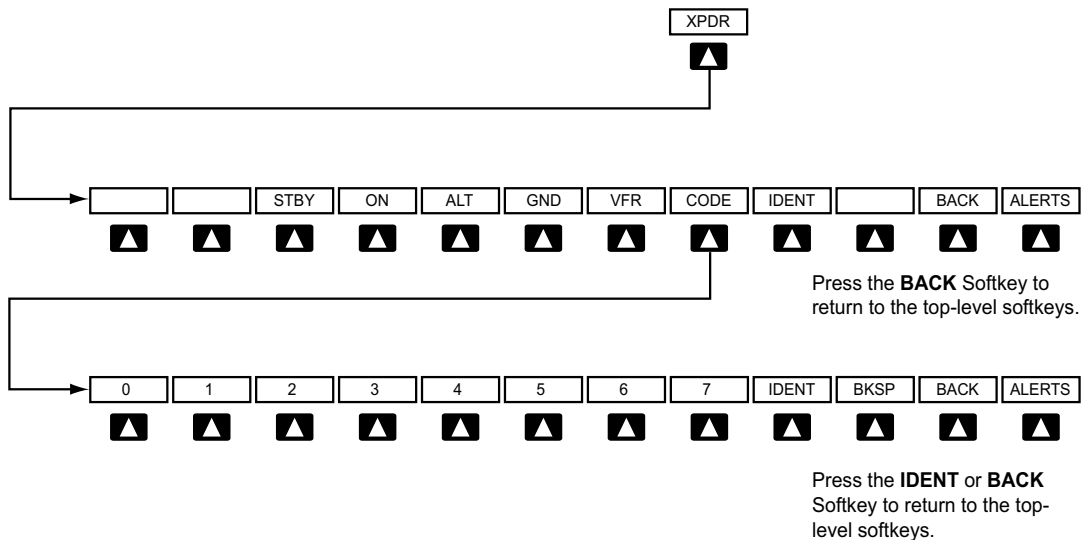
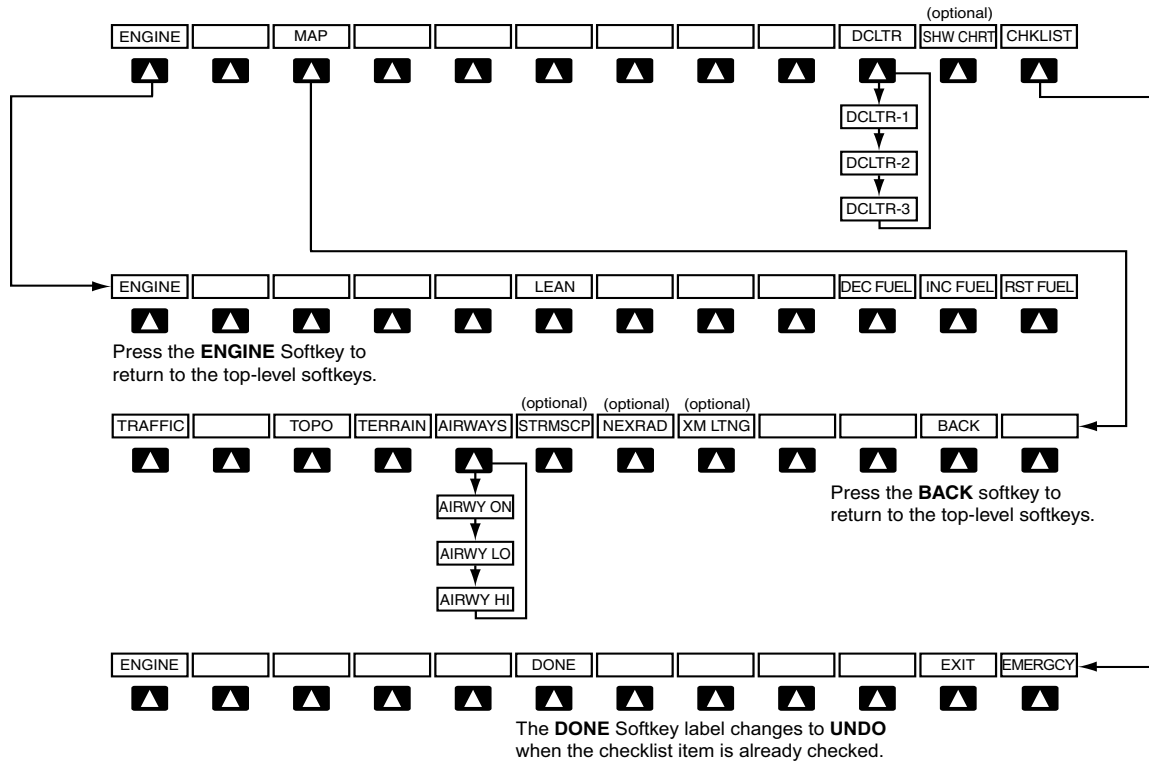

Figure 1-19 XPDR Softkeys

**MFD SOFTKEYS**

MFD softkeys vary depending on the page selected. EIS and Navigation Map Page (default MFD page) softkeys are described here.



**Figure 1-20 MFD Softkeys (EIS, Navigation Map Page, and Checklist)**

- ENGINE** Displays EIS - Engine Page and second-level engine softkeys; press again to exit page (see the EIS Section for more information)
- LEAN** Accesses engine leaning assist mode
- DEC FUEL** Decreases displayed fuel remaining in 1-gal increments
- INC FUEL** Increases displayed fuel remaining in 1-gal increments
- RST FUEL** Resets displayed fuel remaining to maximum fuel capacity for aircraft and fuel used to zero

- **MAP** Enables second-level Navigation Map Page softkeys
- TRAFFIC** Displays/removes traffic information on Navigation Map Page
- TOPO** Displays/removes topographical data (e.g., coastlines, terrain, rivers, lakes) on Navigation Map Page
- TERRAIN** Displays/removes terrain information on Navigation Map Page
- AIRWAYS** Selects the desired display of Airways; cycles through:
  - AIRWY ON: All Airways displayed
  - AIRWY LO: Low Altitude (Victor) Airways displayed
  - AIRWY HI: High Altitude Airways (Jetways) displayed
  - AIRWAYS: Airways are not displayed
- STRMSCP** Displays/removes Stormscope weather information on Inset Map (*optional*)
- NEXRAD** Displays/removes NEXRAD weather/coverage on Navigation Map Page (*optional*)
- XM LTNG** Displays/removes XM lightning information on Navigation Map Page (*optional*)
- BACK** Returns to top-level softkeys
- **DCLTR (3)** Selects desired amount of map detail; cycles through declutter levels:
  - DCLTR (No Declutter): All map features visible
  - DCLTR-1: Removes land data
  - DCLTR-2: Removes land and SUA data
  - DCLTR-3: Removes everything except the active flight plan
- **SHW CHRT** Displays optional FliteCharts or ChartView charts (*optional*)
- **CHKLIST** Displays the Checklist Page
- DONE** Selects the highlighted checklist item
- EXIT** Returns to the top-level softkeys
- EMERGCY** Immediately accesses the emergency procedures

## 1.6 ACCESSING G1000 FUNCTIONALITY

### MENUS

The G1000 has a dedicated **MENU** Key that when pressed displays a context-sensitive list of options. This options list allows the user to access additional features or make settings changes which specifically relate to the currently displayed window/page. There is no all-encompassing menu. Some menus provide access to additional submenus that are used to view, edit, select, and review options. Menus display 'No Options' when there are no additional features or settings for the window/page selected.

#### Navigating a menu:

- 1) Press the **MENU** Key to display the menu.
- 2) Turn the **FMS** Knob to scroll through a list of available options (a scroll bar always appears to the right of the window/box when the option list is longer than the window/box).
- 3) Press the **ENT** Key to select the desired option.
- 4) Press the **CLR** Key or **FMS** Knob to remove the menu and cancel the operation.



Figure 1-21 Page Menu Examples

### DATA ENTRY

The **FMS** Knob can be used for directly entering alphanumeric data (e.g., Flight ID, waypoint identifiers, barometric minimum descent altitude) into the G1000. In some instances, such as when entering an identifier, the G1000 tries to predict the desired identifier based on the characters being entered. In this case, if the desired identifier appears, use the **ENT** Key to confirm the entry without entering the rest of the identifier manually. This can save the pilot from having to enter all the characters of the identifier.

Besides character-by-character data entry, the system also provides a shortcut for entering waypoint identifiers. When the cursor is on a field awaiting entry of a waypoint identifier, turning the small **FMS** Knob counter-clockwise accesses three different lists of waypoint identifiers for quick selection: flight plan (FPL), nearest (NRST), and recently-entered (RECENT). The G1000 automatically fills in the identifier, facility, and city fields with the information for the selected waypoint.

**Using the FMS Knob to enter data:**

- 1) If needed, press the **FMS** Knob to activate the cursor.
- 2) Use the large **FMS** Knob to highlight the desired field.
- 3) Begin entering data.
  - a) To quickly enter a waypoint identifier, turn the small **FMS** Knob counter-clockwise to display a list of waypoints in the active flight plan (list is titled FPL). If desired, turn the small **FMS** Knob clockwise to scroll through lists of nearest waypoints (NRST) and recently-entered waypoints (RECENT).
  - b) Turn the large **FMS** Knob to highlight the desired waypoint from the list and press the **ENT** Key.

**OR:**

- a) Turn the small **FMS** Knob to select a character for the first placeholder.

Turning the knob clockwise scrolls through the alphabet (where appropriate) toward the letter Z, starting at K, and the digits zero through nine. Afterwards, turning the knob counter-clockwise scrolls in the opposite direction.
  - b) Use the large **FMS** Knob to move the cursor to the next placeholder in the field.
  - c) Repeat, using the small **FMS** Knob to select a character and the large **FMS** Knob to move the cursor, until the field is complete.
  - d) Press the **ENT** Key to confirm entry.
- 7) Press the **FMS** Knob or **CLR** Key to cancel data entry (the field reverts back to its previous information).

**PAGE GROUPS**



**NOTE:** Refer to other supporting sections in this Pilot's Guide for details on specific pages.

Information on the MFD is presented on pages which are grouped according to function. The page group and active page title are displayed in the upper center of the screen, below the Navigation Status Box. In the bottom right corner of the screen, the current page group, number of pages available in the group, and placement of the current page within the group are indicated by icons. For some of these pages (Airport/Procedure/Weather Information, XM, Procedure Loading), the title of the page changes while the page icon remains the same.

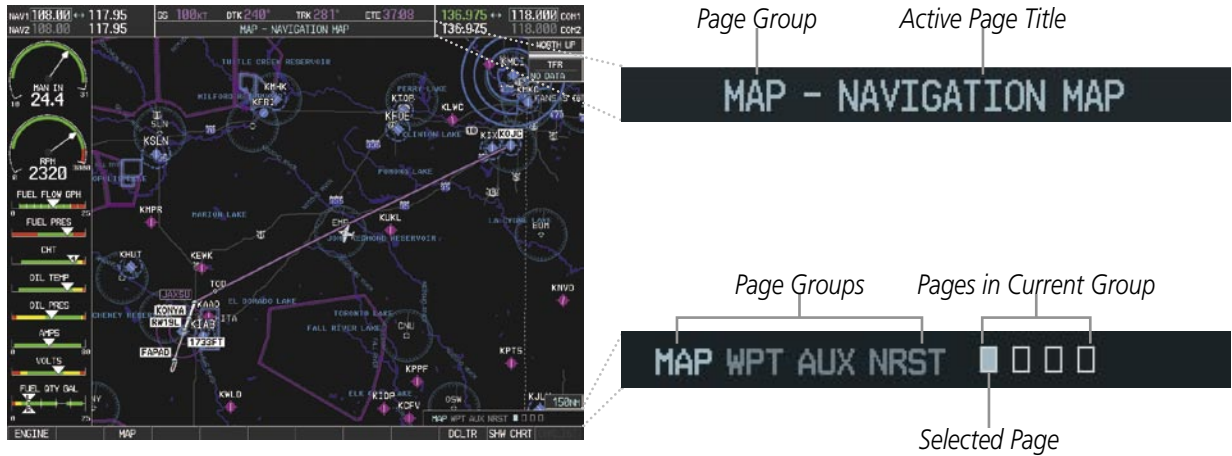

**Figure 1-22 Page Title and Page Group Icons**

There are four main page groups, navigated using the **FMS** Knob; specific pages within each group can vary depending on the configuration of optional equipment.

**Selecting a page using the FMS Knob:**

- 1) Turn the large **FMS** Knob until the desired page group is selected.
- 2) Turn the small **FMS** Knob until the desired page is selected.

There are also several pages (Airport/Procedures/Weather Information and XM pages) which are selected first from within a main page group with the **FMS** Knob, then with the appropriate softkey at the bottom of the page (or from the page menu). In this case, the page remains set to the selected page until a different page softkey is selected, even if a different page group is selected.

• **Map Page Group (MAP)**

- Navigation Map
- Traffic Map
- Stormscope (optional)
- Weather Data Link (optional)
- Terrain Proximity/TAWS (TAWS optional)



Figure 1-23 Map Pages

• **Waypoint Page Group (WPT)**

Airport/Procedures/Weather Information Pages

- Airport Information (**INFO** Softkey)
- Departure Information (**DP** Softkey)
- Arrival Information (**STAR** Softkey)
- Approach Information (**APR** Softkey)
- Weather Information (optional) (**WX** Softkey)

- Intersection Information
- NDB Information
- VOR Information
- User Waypoint Information

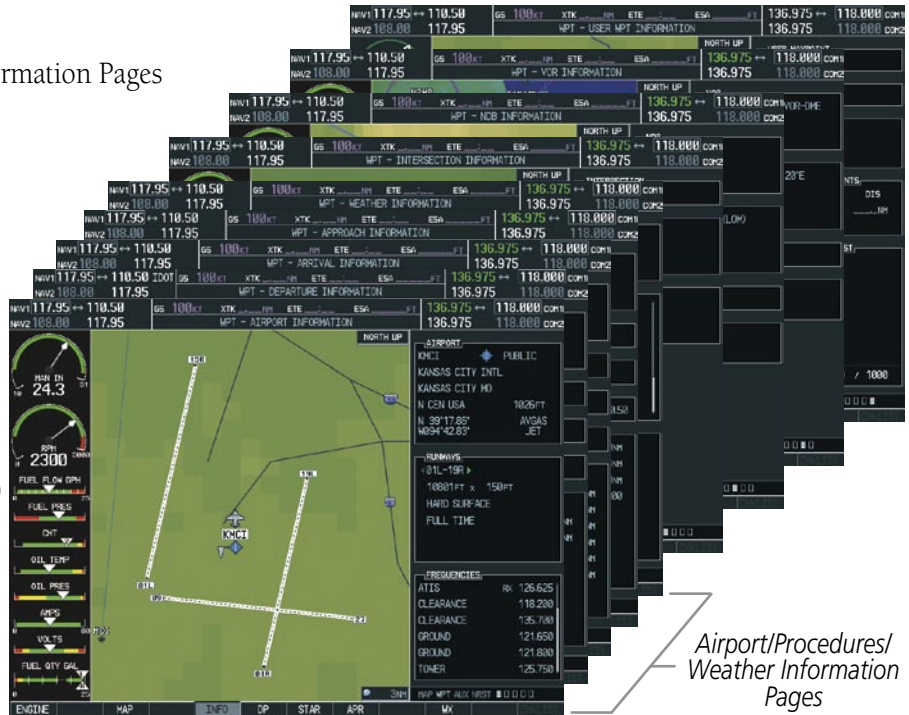

Figure 1-24 Waypoint Pages



• **Auxiliary Page Group (AUX)**

- Trip Planning
- Utility
- GPS Status
- System Setup
- XM Satellite screens (optional)
  - XM Information (INFO Softkey)
  - XM Radio (RADIO Softkey)
- System Status



XM Pages

Figure 1-25 Auxiliary Pages

• **Nearest Page Group (NRST)**

- Nearest Airports
- Nearest Intersections
- Nearest NDB
- Nearest VOR
- Nearest User Waypoints
- Nearest Frequencies
- Nearest Airspaces



Figure 1-26 Nearest Pages

In addition to the main page groups accessed exclusively using the **FMS** Knob, there are pages for flight planning (FPL) and loading procedures (PROC) which are accessed by key. In some instances, softkeys may be used to access the Procedure Loading pages.

The Flight Plan pages are accessed using the **FPL** Key on the MFD. Main pages within this group are selected by turning the small **FMS** Knob.

• **Flight Plan Page Group (FPL)**

- Active Flight Plan
- Flight Plan Catalog
- Stored Flight Plan  
(**NEW** Softkey)



Figure 1-27 Flight Plan Pages

The Procedure Loading pages may be accessed at any time on the MFD by pressing the **PROC** Key. A menu is initialized, and when a departure, approach, or arrival is selected, the appropriate Procedure Loading page is opened. These pages can also be accessed from the Active and Stored Flight Plan pages using the **LD** softkeys. Turning the **FMS** Knob does not scroll through the Procedure Loading pages (note the single page icon in the lower right corner).

• **Procedure Loading Page Group (PROC)**

- Departure Loading
- Arrival Loading
- Approach Loading



Figure 1-28 Procedure Loading Pages

Information on optional electronic checklist pages is offered later in this section. Checklist pages may be accessed from any page on the MFD using the **CHKLIST** Softkey.

**SYSTEM SETTINGS**

G1000 system settings are managed from the System Setup Page. The following settings can be changed:

- Date/time
- Displayed navigation angle reference (see the Flight Instruments Section)
- Airspace alerts (see the GPS Navigation Section)
- Arrival alerts (see the GPS Navigation Section)
- MFD Navigation Status Box fields (see the GPS Navigation Section)
- CDI scaling for GPS navigation source (see the Flight Instruments Section)
- COM channel spacing (see the Audio Panel and CNS Section)
- Criteria for displaying nearest airports (see the GPS Navigation Section)

**Restoring system setup defaults:**

- 1) Select the AUX - System Setup Page.
  - 2) Press the **DFLTS** Softkey.
- OR:**
- a) Press the **MENU** Key.
  - b) Highlight 'Restore Defaults' and press the **ENT** Key.



Figure 1-29 System Setup Page

## DATE/TIME

The G1000 obtains the current Universal Coordinated Time (UTC) date and time directly from the GPS satellite signals (shown on the AUX - GPS Status Page, Figure 1-11). System time (displayed in the lower right corner of the PFD) can be displayed in three formats: local 12-hr, local 24-hr, or UTC. Local time is set by adding/subtracting an offset (hours:minutes) to/from UTC.



PFD

Figure 1-30 System Time (Local 24-hr Format)

### Configuring the system time:

- 1) Select the AUX - System Setup Page.
- 2) Press the **FMS** Knob to activate the cursor.
- 3) Turn the large **FMS** Knob to highlight the 'Time Format' field.
- 4) Turn the small **FMS** Knob to select the desired format and press the **ENT** Key to confirm selection. The 'Time Offset' field is highlighted.
- 5) Use the **FMS** Knob to enter the desired time offset (±HH:MM) and press the **ENT** Key to confirm selection.



Figure 1-31 Date/Time Settings (System Setup Page)

## DISPLAY UNITS

Units in which various quantities are displayed on the G1000 screens are listed on the System Setup Page. The Navigation Angle reference can be set from here (refer to the Flight Instruments Section).

| Category                    | Settings  | Affected Quantities  | Exceptions  |
|-----------------------------|---|--|---|
| Navigation Angle            | Magnetic (North)<br>True (North)                              | Heading<br>Course<br>Bearing<br>Track<br>Desired Track<br>Wind direction (Trip Planning Page)  |   |
| Distance and Speed          | Metric<br>Nautical*   | Crosstrack error (HSI)<br>Bearing distances (information windows)<br>DME distance (information window)<br>Flight plan distances<br>Map ranges<br>DIS, GS, TAS, XTK fields (Navigation Status Box)<br>All distances on MFD<br>Altitude buffer distance (System Setup)<br>Arrival Alert trigger distance (System Setup)<br>All speeds on MFD | Airspeed Indicator<br>True Airspeed (PFD)<br>Wind speed vector<br>Map range (Traffic Page, Terrain Proximity/TAWS Page)<br>CDI scaling (System Setup)<br>Fuel range calculation (EIS) |
| Altitude and Vertical Speed | Feet*<br>Meters   | All altitudes on MFD<br>All elevations on MFD  | Altimeter<br>Vertical Speed Indicator<br>VNV altitudes (Active Flight Plan)   |
| Temperature                 | Celsius*<br>Fahrenheit  | All temperatures on PFD<br>Total Air Temperature (Trip Planning Page)  | Engine Indication System (EIS)  |
| Fuel and Fuel Flow*         | Gallons*<br>Imperial Gallons<br>Kilograms<br>Liters<br>Pounds | Fuel parameters (Trip Planning Page)   | Engine Indication System (EIS)  |
| Weight                      | Pounds*<br>Kilograms  | N/A  | N/A   |
| Position                    | HDDD°MM.MM'<br>HDDD°MM'SS.S"                                  | All positions  | N/A   |

\* Default setting; contact a Garmin-authorized service center to change display units settings

**Table 1-1 Display Units Settings (System Setup Page)**

## PILOT PROFILES

System settings may be saved under a pilot profile. When the system is powered on, the last selected pilot profile is shown on the MFD Power-up Splash Screen (Figure 1-5). The G1000 can store up to 25 profiles; the currently active profile, the amount of memory used, and the amount of memory available are shown at the top of the System Setup Page in the box labeled 'Pilot Profile'. From here, pilot profiles may be created, selected, renamed, or deleted.



Figure 1-32 Display Unit Settings  
(System Setup Page)

### Creating a profile:

- 1) Select the AUX - System Setup Page.
- 2) Press the **FMS** Knob momentarily to activate the flashing cursor.
- 3) Turn the large **FMS** Knob to highlight 'CREATE' in the Pilot Profile Box.
- 4) Press the **ENT** Key. A 'Create Profile' window is displayed.
- 5) Use the **FMS** Knob to enter a profile name up to 16 characters long and press the **ENT** Key. Pilot profile names cannot begin with a blank as the first letter.
- 6) In the next field, use the small **FMS** Knob to select the desired settings upon which to base the new profile. Profiles can be created based on Garmin factory defaults, default profile settings (initially based on Garmin factory defaults unless edited by the pilot), or current system settings.
- 7) Press the **ENT** Key.

8) With 'CREATE' highlighted, press the **ENT** Key to create the profile

**OR:**

Use the large **FMS** Knob to select 'CREATE and ACTIVATE' and press the **ENT** Key to activate the new profile.

9) To cancel the process, select 'CANCEL' with the large FMS Knob and press the **ENT** Key.

#### **Selecting an active profile:**

- 1) Select the AUX - System Setup Page.
- 2) Press the **FMS** Knob momentarily to activate the flashing cursor.
- 3) Turn the large **FMS** Knob to highlight the active profile field in the Pilot Profile Box.
- 4) Turn the small **FMS** Knob to display the pilot profile list and highlight the desired profile.
- 5) Press the **ENT** Key. The G1000 loads and displays the system settings for the selected profile.

#### **Renaming a profile:**

- 1) Select the AUX - System Setup Page.
- 2) Press the **FMS** Knob momentarily to activate the flashing cursor.
- 3) Turn the large **FMS** Knob to highlight 'RENAME' in the Pilot Profile Box.
- 4) Press the **ENT** Key.
- 5) In the 'Rename Profile' window, turn the **FMS** Knob to select the profile to rename.
- 6) Press the **ENT** Key.
- 7) Use the **FMS** Knob to enter a new profile name up to 16 characters long and press the **ENT** Key.
- 8) With 'RENAME' highlighted, press the **ENT** Key.
- 9) To cancel the process, use the large **FMS** Knob to select 'CANCEL' and press the **ENT** Key.

#### **Deleting a profile:**

- 1) Select the AUX - System Setup Page.
- 2) Press the **FMS** Knob momentarily to activate the flashing cursor.
- 3) Turn the large **FMS** Knob to highlight 'DELETE' in the Pilot Profile Box.
- 4) Press the **ENT** Key.
- 5) In the 'Delete Profile' window, turn the **FMS** Knob to select the profile to delete.
- 6) Press the **ENT** Key.
- 7) With 'DELETE' highlighted, press the **ENT** Key.
- 8) To cancel the process, use the large **FMS** Knob to select 'CANCEL' and press the **ENT** Key.

## TIMERS

The G1000 timers available include:

- Stopwatch-like generic timers (available from the PFD Timer/References Window and on the MFD AUX - Utility Page)
- Total-time-in-flight timer (MFD AUX - Utility Page)
- Time since departure (MFD AUX - Utility Page)

The generic timer can be set to count up or down from a specified time (HH:MM:SS). When the countdown on the timer reaches zero the digits begin to count up from zero. If the timer is reset before reaching zero on a countdown, the digits are reset to the initial value. If the timer is counting up when reset, the digits are zeroed.

### Setting the generic timer (PFD):

- 1) Press the **TMR/REF** Softkey.
- 2) Turn the large **FMS** Knob to select the timer field (hh/mm/ss).
- 3) Use the **FMS** Knob to enter the desired time and press the **ENT** Key.
- 4) With the UP/DN field highlighted, turn the small **FMS** Knob to select the timer counting direction (UP/DN) and press the **ENT** Key.
- 6) With 'START?' highlighted, press the **ENT** Key to start the timer. The field changes to 'STOP?'.
- 7) To stop the timer, press the **ENT** Key with 'STOP?' highlighted. The field changes to 'RESET?'.
- 8) To reset the timer, press the **ENT** Key with 'RESET?' highlighted. The field changes back to 'START?' and the digits are reset.
- 9) To remove the window, press the **CLR** Key or the **TMR/REF** Softkey.



Figure 1-33 Generic Timer (Timer/References Window)



**Setting the generic timer (MFD AUX - Utility Page):**

- 1) Select the AUX - Utility Page.
- 2) Press the **FMS** Knob momentarily to activate the flashing cursor.
- 3) Turn the small **FMS** Knob to select the timer counting direction (UP/DN) and press the **ENT** Key.
- 4) Use the large **FMS** Knob to enter the desired time and press the **ENT** Key.
- 6) With 'START?' highlighted, press the **ENT** Key to start the timer. The field changes to 'STOP?'.
- 6) To stop the timer, press the **ENT** Key with 'STOP?' highlighted. The field changes to 'RESET?'.
- 7) To reset the timer, press the **ENT** Key with 'RESET?' highlighted. The field changes back to 'START?' and the digits are reset.



Figure 1-34 Timers (Utility Page)

The flight timer can be set to count up from zero starting at system power-up or from the time that the aircraft lifts off; the timer can also be reset to zero at any time.

**Setting the flight timer starting criterion:**

- 1) Select the AUX - Utility Page.
- 2) Press the **FMS** Knob momentarily to activate the flashing cursor.
- 3) Turn the large **FMS** Knob to highlight the field next to the flight timer.
- 4) Turn the small **FMS** Knob to select the starting criterion (PWR-ON or IN-AIR) and press the **ENT** Key.

**Resetting the flight timer:**

- 1) Select the AUX - Utility Page.
- 2) Press the **MENU** Key.
- 3) With 'Reset Flight Timer' highlighted, press the **ENT** Key.

The G1000 records the time at which departure occurs, depending on whether the pilot prefers the time to be recorded from system power-up or from aircraft lift off. The displayed departure time can also be reset to display the current time at the point of reset. The format in which the time is displayed is controlled from the System Setup Page.

**Setting the departure timer starting criterion:**

- 1) Select the AUX - Utility Page.
- 2) Press the **FMS** Knob momentarily to activate the flashing cursor.
- 3) Turn the large **FMS** Knob to highlight the field next to the departure time.
- 4) Turn the small **FMS** Knob to select the starting criterion (PWR-ON or IN-AIR) and press the **ENT** Key.

**Resetting the departure time:**

- 1) Select the AUX - Utility Page.
- 2) Press the **MENU** Key.
- 3) Use the **FMS** Knob to highlight 'Reset Departure Time' and press the **ENT** Key.

**SCHEDULER**

The G1000's Scheduler feature can be used to enter and display reminder messages (e.g., "Change oil", "Switch fuel tanks", "Overhaul") in the Alerts Window on the PFD. Messages can be set to display based on a specific date and time (event), once the message timer reaches zero (one-time; default setting), or recurrently whenever the message timer reaches zero (periodic). Message timers set to periodic alerting automatically reset to the original timer value once the message is displayed. When power is cycled, messages are retained until deleted, and message timer countdown is restarted.

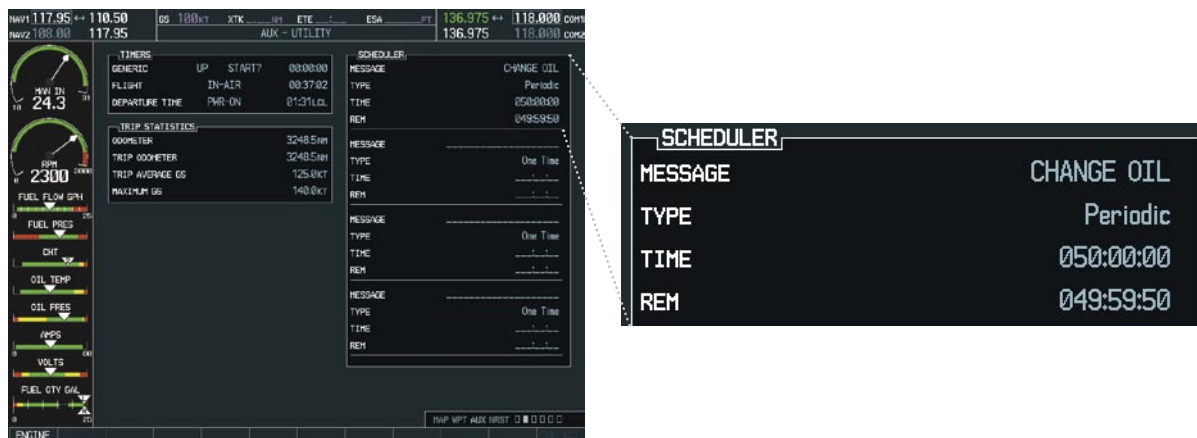

Figure 1-35 Scheduler (Utility Page)

**Entering a scheduler message:**

- 1) Select the AUX - Utility Page.
- 2) Press the **FMS** Knob momentarily to activate the flashing cursor.
- 3) Turn the large **FMS** Knob to highlight the first empty scheduler message naming field.

- 4) Use the **FMS** Knob to enter the message text to be displayed in the Alerts Window and press the **ENT** Key.
- 5) Press the **ENT** Key again or use the large **FMS** Knob to move the cursor to the field next to 'Type'.
- 6) Turn the small **FMS** Knob to select set the message alert type:
  - Event—Message issued at the specified date/time
  - One-time—Message issued when the message timer reaches zero (default setting)
  - Periodic—Message issued each time the message timer reaches zero
- 7) Press the **ENT** Key again or use the large **FMS** Knob to move the cursor to the next field.
- 8) For periodic and one-time message, use the **FMS** Knob to enter the timer value (HHH:MM:SS) from which to countdown and press the **ENT** Key.
- 9) For event-based messages:
  - a) Use the **FMS** Knob to enter the desired date (DD-MMM-YYY) and press the **ENT** Key.
  - b) Press the **ENT** Key again or use the large **FMS** Knob to move the cursor to the next field.
  - c) Use the **FMS** Knob to enter the desired time (HH:MM) and press the **ENT** Key.
- 10) Press the **ENT** Key again or use the large **FMS** Knob to move the cursor to enter the next message.

**Deleting a scheduler message:**

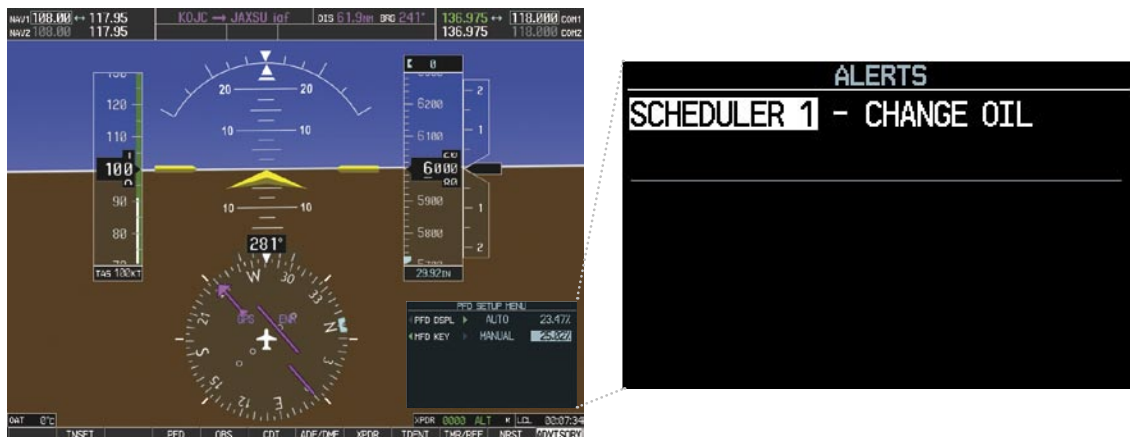

- 1) Select the AUX - Utility Page.
- 2) Press the **FMS** Knob momentarily to activate the flashing cursor.
- 3) Turn the large **FMS** Knob to highlight the name field of the scheduler message to be deleted.
- 4) Press the **CLR** Key to clear the message text. If the **CLR** Key is pressed again, the message is restored.
- 5) Press the **ENT** Key to confirm message deletion.

Scheduler messages appear in the Alerts Window on the PFD and cause the **ALERTS** Softkey label to change to 'ADVISORY'. Pressing the **ADVISORY** Softkey opens the Alerts Window and acknowledges the scheduler message. The softkey reverts to the 'ALERTS' label and when pressed, the Alerts Window is removed from the display and the scheduler message is deleted from the message queue.



**Figure 1-36 PFD Alerts Window**

## ELECTRONIC CHECKLISTS (OPTIONAL)

- 
**NOTE:** The checklists presented in this section are for example only and may not reflect checklists actually available for the Diamond DA40/40F. The information described in this section is not intended to replace the checklist information described in the AFM or the Pilot Safety and Warning Supplements document.
- 
**NOTE:** Garmin is not responsible for the content of checklists. User-defined checklists are created by the aircraft manufacturer. Modifications or updates to the checklists are coordinated through the aircraft manufacturer. The user cannot edit these checklists.
- 
**NOTE:** Checklists cannot be edited from within the system. Refer to the Garmin Aviation Checklist Editor (ACE) User's Guide for information on creating and editing checklists.

The MFD is able to display optional electronic checklists which allow a pilot to quickly find the proper procedure on the ground and during each phase of flight. The G1000 accesses the checklists from an SD card inserted into the bezel slot (see Figure 1-3). If the SD card contains an invalid checklist file or no checklist, the Power-up Splash Screen displays 'Invalid Checklist File' or 'Checklist File Not Present' and the **CHKLIST** Softkey is not available.



Figure 1-37 Checklist Page Example

**Accessing and navigating checklists:**

- 1) From any page, press the **CHKLIST** Softkey.
- 2) Turn the large **FMS** Knob to select the 'GROUP' field.
- 3) Turn the small **FMS** Knob to select the desired procedure and press the **ENT** Key.
- 4) Turn the large **FMS** Knob to select the 'Checklist' field.
- 5) Turn the **FMS** Knob to select the desired checklist and press the **ENT** Key.
- 6) Turn the **FMS** Knob to scroll through the checklist and highlight the desired checklist item (has a hollow white box for checkmark).

The following colors are used for checklist items:

- Blue - Items has not been highlighted
- Green - Item has been selected
- White - Item is highlighted for selection
- Yellow - Warning notes

- 7) Press the **ENT** Key or **DONE** Softkey to select the highlighted checklist item (item turns green and a checkmark is placed in the box next to the item). The next item is automatically highlighted for selection.

Press the **CLR** Key to remove a check mark from an item.

- 8) Once the last item in a checklist is selected, 'Go to the next checklist?' is highlighted. Press the **ENT** Key to advance to the next checklist displayed.
- 9) Press the **EXIT** Softkey or hold down the **CLR** Key momentarily to exit the Checklist Page and return to the page last viewed.

**Immediately accessing emergency procedures:**

- 1) From any page, press the **CHKLIST** Softkey.
- 2) Press the **EMERGENCY** Softkey.

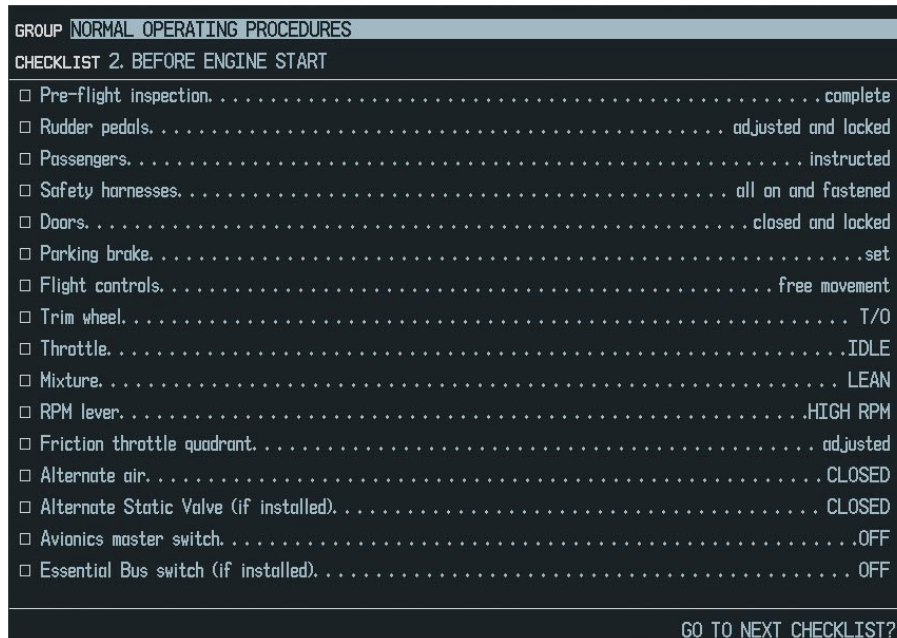

Figure 1-38 Sample Checklist

## 1.7 DISPLAY BACKLIGHTING

The backlighting of the PFD and MFD displays and bezel and Audio Panel keys can be adjusted automatically or manually. The default setting (automatic backlighting adjustment) uses photocell technology to automatically adjust for ambient lighting conditions. Photocell calibration curves are pre-configured to optimize display appearance through a broad range of cockpit lighting conditions. Manual backlighting adjustment can be accomplished using the existing instrument panel dimmer bus or the following procedures. In normal operating mode, backlighting can only be adjusted from the PFD. In Reversionary Mode, it can be adjusted from the remaining display.

### Adjusting display backlighting:

- 1) Press the PFD **MENU** Key to display the PFD Setup Menu. 'AUTO' is now highlighted next to 'PFD DSPL'.
- 2) Turn the small **FMS** Knob to select 'MANUAL' and press the **ENT** Key. The intensity value is now highlighted.
- 3) Use the **FMS** Knob to enter the desired backlighting then press the **ENT** Key.
- 4) Turn the large **FMS** Knob to highlight 'AUTO' next to 'MFD DSPL' and repeat steps 2-3.
- 5) To remove the menu, press the **CLR** or **MENU** Key.

### Adjusting key backlighting:

- 1) Press the PFD **MENU** Key to display the PFD Setup Menu. 'AUTO' is now highlighted next to 'PFD DSPL'.
- 2) Turn the large **FMS** Knob to highlight 'PFD DSPL'.
- 3) Turn the small **FMS** Knob in the direction of the green arrowhead to display 'PFD KEY'.
- 4) Turn the large **FMS** Knob to highlight 'AUTO'.
- 5) Turn the small **FMS** Knob to select 'MANUAL' and press the **ENT** Key. The intensity value is now highlighted.
- 6) Use the **FMS** Knob to enter the desired backlighting and press the **ENT** Key.
- 7) Turn the large **FMS** Knob to highlight 'MFD DSPL'.
- 8) Turn the small **FMS** Knob in the direction of the green arrowhead to display 'MFD KEY' and repeat steps 4-6.
- 9) To remove the menu, press the **CLR** or **MENU** Key.



Figure 1-39 PFD Setup Menu

## SECTION 2 FLIGHT INSTRUMENTS



---

**WARNING:** In the event that the airspeed, attitude, altitude, or heading indications become unusable, refer to the backup instruments.

---



---

**NOTE:** The Automatic Flight Control System (AFCS) provides additional readouts and bugs on selected flight instruments. Refer to the AFCS Section for details on these bugs and readouts, as they appear on the display during certain AFCS modes.

---

Increased situational awareness is provided by replacing the traditional instruments on the panel with an easy-to-scan Primary Flight Display (PFD) that features a large horizon, airspeed, attitude, altitude, vertical speed, and course deviation information. In addition to the flight instruments, navigation, communication, terrain, traffic, and weather information are also presented on the PFD and explained in other sections of this Pilot's Guide.

The following flight instruments and supplemental flight data are displayed on the PFD:

- Airspeed Indicator, showing
  - True airspeed
  - Airspeed awareness ranges
  - Reference flags
- Attitude Indicator with slip/skid indication
- Altimeter, showing
  - Barometric setting
  - Selected Altitude
- Vertical Deviation, Glideslope, and Glidepath Indicators
- Vertical Speed Indicator (VSI)
- Horizontal Situation Indicator, showing
  - Turn Rate Indicator
  - Bearing pointers and information windows
  - DME Information Window
- Course Deviation Indicator (CDI)
- Outside air temperature (OAT)
- Wind data
- Vertical Navigation indications

The PFD also displays various alerts and annunciations.



- |  |                                  |
|--|----------------------------------|
| ① NAV Frequency Box                    | ⑫ Altimeter Barometric Setting   |
| ② Airspeed Indicator                   | ⑬ Vertical Speed Indicator (VSI) |
| ③ True Airspeed                        | ⑭ Selected Altitude Bug          |
| ④ Current Heading                      | ⑮ Altimeter                      |
| ⑤ Horizontal Situation Indicator (HSI) | ⑯ Selected Altitude              |
| ⑥ Outside Air Temperature (OAT)        | ⑰ COM Frequency Box              |
| ⑦ Softkeys                             | ⑱ AFCS Status Box                |
| ⑧ System Time                          | ⑲ Navigation Status Box          |
| ⑨ Transponder Data Box                 | ⑳ Slip/Skid Indicator            |
| ⑩ Selected Heading Bug                 | ㉑ Attitude Indicator             |
| ⑪ Turn Rate Indicator                  |                                  |

Figure 2-1 Primary Flight Display (Default)





- ① Traffic Annunciation
- ② Selected Heading
- ③ Vspeed Reference
- ④ Wind Data
- ⑤ Inset Map
- ⑥ DME Information Window
- ⑦ Bearing Information Windows
- ⑧ Minimum Descent Altitude/ Decision Height
- ⑨ Flight Plan Window
- ⑩ Annunciation Window
- ⑪ Selected Course
- ⑫ Vertical Speed Required
- ⑬ Vertical Deviation Indicator (VDI)
- ⑭ Current VNV Target Altitude
- ⑮ AFCS Status Annunciation

Figure 2-2 Additional PFD Information

## 2.1 FLIGHT INSTRUMENTS

### AIRSPEED INDICATOR



**NOTE:** Refer to the Aircraft Flight Manual Supplement (AFMS) for speed criteria and Vspeed values.

The Airspeed Indicator displays airspeed on a rolling number gauge using a moving tape. The true airspeed is displayed in knots below the Airspeed Indicator. The numeric labels and major tick marks on the moving tape are marked at intervals of 10 knots, while minor tick marks on the moving tape are indicated at intervals of 5 knots. Speed indication starts at 20 knots, with 60 knots of airspeed viewable at any time. The actual airspeed is displayed inside the black pointer. The pointer remains black until reaching never-exceed speed ( $V_{NE}$ ), at which point it turns red.

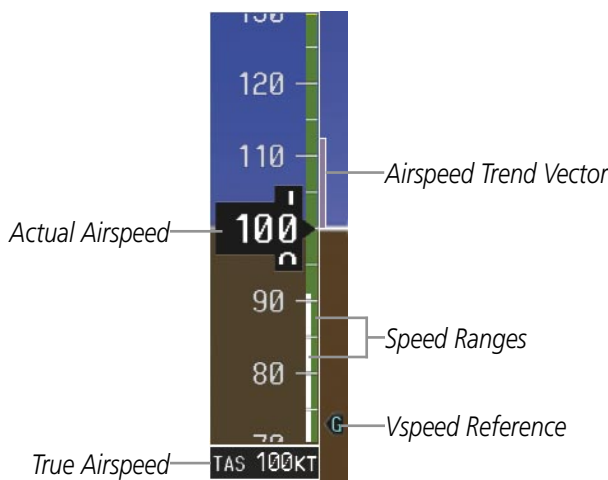

Figure 2-3 Airspeed Indicator



Figure 2-4 Red Pointer at  $V_{NE}$

A color-coded (white, green, yellow, and red) speed range strip is located on the moving tape. The colors denote flaps operating range, normal operating range, caution range, and never-exceed speed ( $V_{NE}$ ). Red and yellow ranges are also present for low speed awareness. For EASA-certified aircraft, the yellow low airspeed awareness band is not shown and the limits on the other lower speed ranges differ (refer to the AFMS for speed criteria).

The Airspeed Trend Vector is a vertical, magenta line, extending up or down on the airspeed scale, shown to the right of the color-coded speed range strip. The end of the trend vector corresponds to the predicted airspeed in 6 seconds if the current rate of acceleration is maintained. If the trend vector crosses  $V_{NE}$ , the text of the actual airspeed readout changes to yellow. The trend vector is absent if the speed remains constant or if any data needed to calculate airspeed is not available due to a system failure.

Vspeeds (Glide,  $V_R$ ,  $V_X$ , and  $V_Y$ ) can be changed and their flags turned on/off from the Timer/References Window. When active (on), the Vspeeds are displayed at their respective locations to the right of the airspeed scale. By default, all Vspeed values are reset and all flags turned off when power is cycled.

**Changing Vspeeds and turning Vspeed flags on/off:**

- 1) Press the **TMR/REF** Softkey.
- 2) Turn the large **FMS** Knob to highlight the desired Vspeed.
- 3) Use the small **FMS** Knob to change the Vspeed in 1-kt increments (when a speed has been changed from a default value, an asterisk appears next to the speed).
- 4) Press the **ENT** Key or turn the large **FMS** Knob to highlight the ON/OFF field
- 5) Turn the small **FMS** Knob clockwise to ON or counterclockwise to OFF.
- 6) To remove the window, press the **CLR** Key or the **TMR/REF** Softkey.



Figure 2-5 Timer/References Window

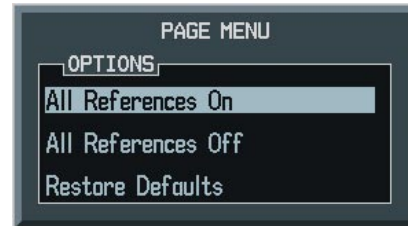

Figure 2-6 Timer/References Menu

**Turning all Vspeed flags on/off:**

- 1) Press the **TMR/REF** Softkey.
- 2) Press the **MENU** Key.
- 3) To view all Vspeed flags, highlight 'All References On' and press the **ENT** Key.
- 4) To remove all Vspeed flags, turn the **FMS** Knob to highlight 'All References Off' and press the **ENT** Key.

**Restoring all Vspeed defaults:**

- 1) Press the **TMR/REF** Softkey.
- 2) Press the **MENU** Key.
- 3) Turn the **FMS** Knob to highlight 'Restore Defaults' and press the **ENT** Key.

## ATTITUDE INDICATOR

Attitude information is displayed over a virtual blue sky and brown ground with a white horizon line. The Attitude Indicator displays the pitch, roll, and slip/skid information.

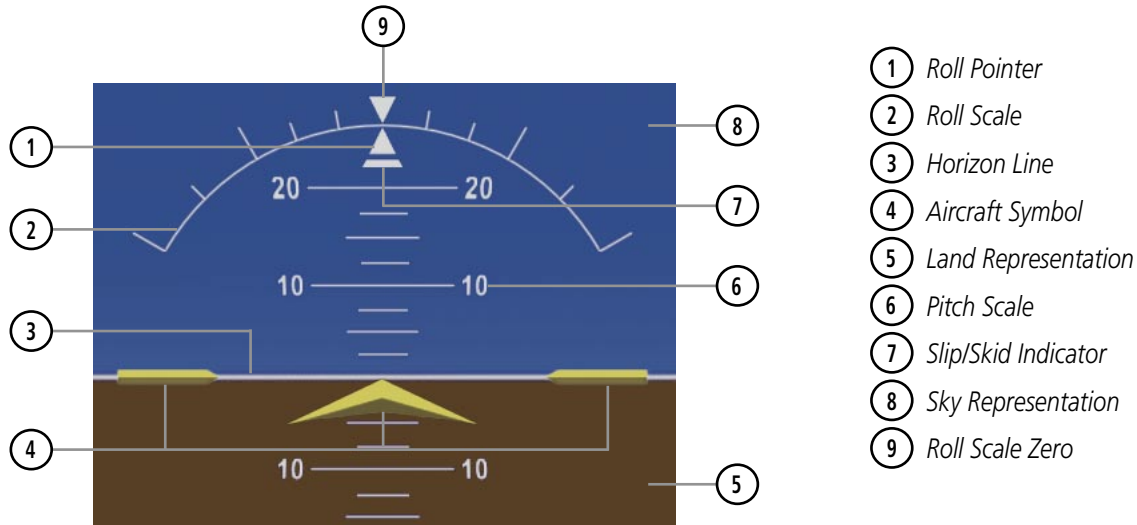

Figure 2-7 Attitude Indicator

The horizon line is part of the pitch scale. Above and below the horizon line, major pitch marks and numeric labels are shown for every 10°, up to 80°. Minor pitch marks are shown for intervening 5° increments, up to 25° below and 45° above the horizon line. Between 20° below to 20° above the horizon line, minor pitch marks occur every 2.5°.

The inverted white triangle indicates zero on the roll scale. Major tick marks at 30° and 60° and minor tick marks at 10°, 20°, and 45° are shown to the left and right of the zero. Angle of bank is indicated by the position of the pointer on the roll scale.

The Slip/Skid Indicator is the bar beneath the roll pointer. The indicator moves with the roll pointer and moves laterally away from the pointer to indicate lateral acceleration. Slip/skid is indicated by the location of the bar relative to the pointer. One bar displacement is equal to one ball displacement on a traditional Slip/Skid Indicator.



Figure 2-8 Slip/Skid Indication

**ALTIMETER**

The Altimeter displays 600 feet of barometric altitude values at a time on a rolling number gauge using a moving tape. Numeric labels and major tick marks are shown at intervals of 100 feet. Minor tick marks are at intervals of 20 feet. The current altitude is displayed in the black pointer.

The Selected Altitude is displayed above the Altimeter in the box indicated by a selection bug symbol. A bug corresponding to this altitude is shown on the tape; if the Selected Altitude exceeds the range shown on the tape, the bug appears at the corresponding edge of the tape. See the AFCS Section for more information about how the G1000 uses the Selected Altitude.

**Setting the Selected Altitude:**

Turn the **ALT** Knob to set the Selected Altitude in 100-ft increments (increments reduce to 10 feet for approach) up to the aircraft’s service ceiling.

If set, the Minimum Descent Altitude/Decision Height (MDA/DH) value is also available for the Selected Altitude.

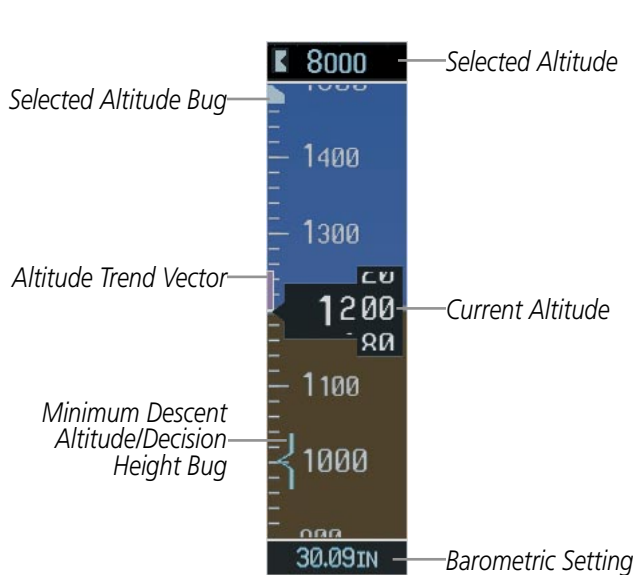

**Figure 2-9 Altimeter**



**Figure 2-10 Altimeter (Metric Units)**

Selected and current altitudes can also be displayed in meters (readouts displayed above the normal readouts in feet; Figure 2-10). Note that the altitude tape does not change scale.

**Displaying altitude in meters:**

- 1) Press the **PFD** Softkey to display the second-level softkeys.
- 2) Press the **ALT UNIT** Softkey.
- 3) Press the **METERS** Softkey to turn on metric altitude readouts.
- 4) Press the **BACK** Softkey to return to the top-level softkeys.

A magenta Altitude Trend Vector extends up or down the left of the altitude tape, the end resting at the approximate altitude to be reached in 6 seconds at the current vertical speed. The trend vector is not shown if altitude remains constant or if data needed for calculation is not available due to a system failure.

The barometric pressure setting is displayed below the Altimeter in inches of mercury (in Hg) or hectopascals (hPa) when metric units are selected. Adjusting the altimeter barometric setting creates discontinuities in VNV vertical deviation, moving the descent path. For large adjustments, it may take several minutes for the aircraft to re-establish on the descent path. If the change is made while nearing a waypoint with a VNV Target Altitude, the aircraft may not re-establish on the descent path in time to meet the vertical constraint.

#### Selecting the altimeter barometric pressure setting:

Turn the **BARO** Knob to select the desired setting.

#### Selecting standard barometric pressure (29.92 in Hg):

- 1) Press the **PFD** Softkey to display the second-level softkeys.
- 2) Press the **STD BARO** Softkey.

#### Changing altimeter barometric pressure setting units:

- 1) Press the **PFD** Softkey to display the second-level softkeys.
- 2) Press the **ALT UNIT** Softkey.
- 3) Press the **IN** Softkey to display the barometric pressure setting in inches of mercury (in Hg).

Or, press the **HPA** Softkey to display the barometric pressure setting in hectopascals (hPa; see Figure 2-10).

- 4) Press the **BACK** Softkey to return to the top-level softkeys.

## VERTICAL SPEED INDICATOR (VSI)

---

The Vertical Speed Indicator (VSI, Figure 2-11) displays the aircraft vertical speed using a non-moving tape labeled at 1000 and 2000 fpm with minor tick marks every 500 fpm. The current vertical speed is displayed in the pointer along the tape. Digits appear in the pointer when the climb or descent rate is greater than 100 fpm. If the rate of ascent/descent exceeds 2000 fpm, the pointer appears at the corresponding edge of the tape and the rate appears inside the pointer.

A magenta chevron bug is displayed as the Required Vertical Speed Indication (RVSI) for reaching a VNV Target Altitude once the “TOD [Top of Descent] within 1 minute” alert has been generated. See the GPS Navigation Section for details on VNV features, and refer to Section 2.2, Supplemental Flight Data, for more information about VNV indications on the PFD.

**VERTICAL DEVIATION, GLIDESLOPE, AND GLIDEPATH INDICATORS**

**NOTE:** The *Glidepath Indicator* is only shown for aircraft with *GIA 63W Integrated Avionics Units* when *WAAS* is available.

The Vertical Deviation Indicator (VDI; Figure 2-11) uses a magenta chevron to indicate the baro-VNV vertical deviation when Vertical Navigation (VNV) is being used; the VDI appears in conjunction with the “TOD within 1 minute” alert. Full-scale deflection (two dots) is 1000 feet. The VDI is removed from the display if vertical deviation becomes invalid. See the GPS Navigation Section for details on VNV features, and refer to Section 2.2, Supplemental Flight Data, for more information about VNV indications on the PFD.

The Glideslope Indicator (Figure 2-12) appears to the left of the Altimeter whenever an ILS frequency is tuned in the active NAV field. A green diamond acts as the Glideslope Indicator, like a glideslope needle on a conventional indicator. If a localizer frequency is tuned and there is no glideslope, “NO GS” is annunciated.

The glidepath is analogous to the glideslope for GPS approaches supporting WAAS vertical guidance (LNAV+V, L/VNV, LPV) and is generated by the system to reduce pilot workload during approach. When an approach of this type is loaded into the flight plan and GPS is the selected navigation source, the Glidepath Indicator (Figure 2-13) appears as a magenta diamond. If the approach type downgrades past the final approach fix (FAF), “NO GP” is annunciated.

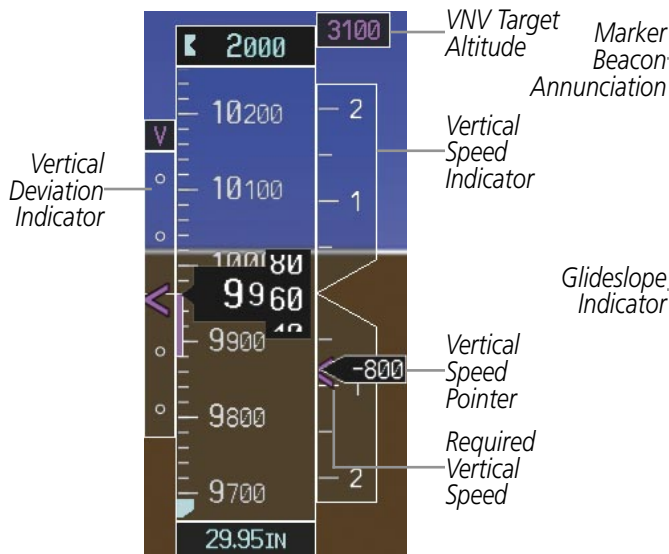

Figure 2-11 Vertical Speed and Deviation Indicators (VSI and VDI)

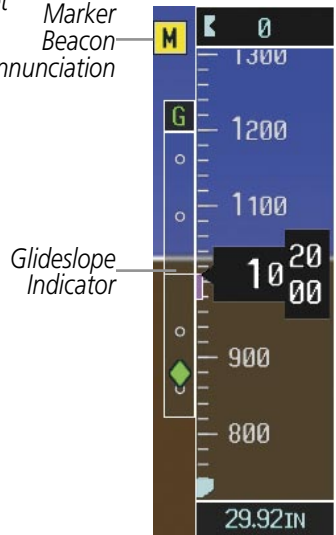

Figure 2-12 Glideslope Indicator

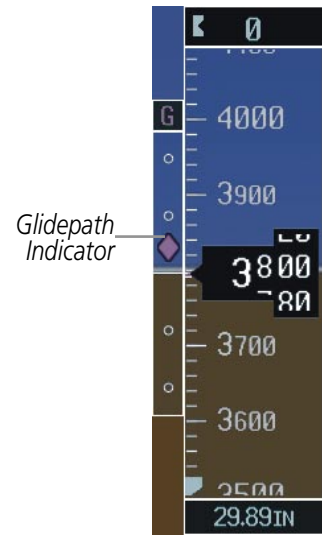

Figure 2-13 Glidepath Indicator

## HORIZONTAL SITUATION INDICATOR (HSI)

The Horizontal Situation Indicator (HSI) displays a rotating compass card in a heading-up orientation. Letters indicate the cardinal points and numeric labels occur every 30°. Major tick marks are at 10° intervals and minor tick marks at 5° intervals. A digital reading of the current heading appears on top of the HSI, and the current track is represented on the HSI by a magenta diamond bug. The HSI also presents turn rate, course deviation, bearing, and navigation source information and is available in two formats (360° compass rose and 140° arc).

### Changing the HSI display format:

- 1) Press the **PFD** Softkey.
- 2) Press the **HSI FRMT** Softkey.
- 3) Press the **360 HSI** or **ARC HSI** Softkey.

The 360° HSI (Figure 2-14) contains a Course Deviation Indicator (CDI), with a Course Pointer, To/From Indicator, and a sliding deviation bar and scale. The course pointer is a single line arrow (GPS, VOR1, and LOC1) or a double line arrow (VOR2 and LOC2) which points in the direction of the set course. The To/From arrow rotates with the course pointer and is displayed when the active NAVAID is received.

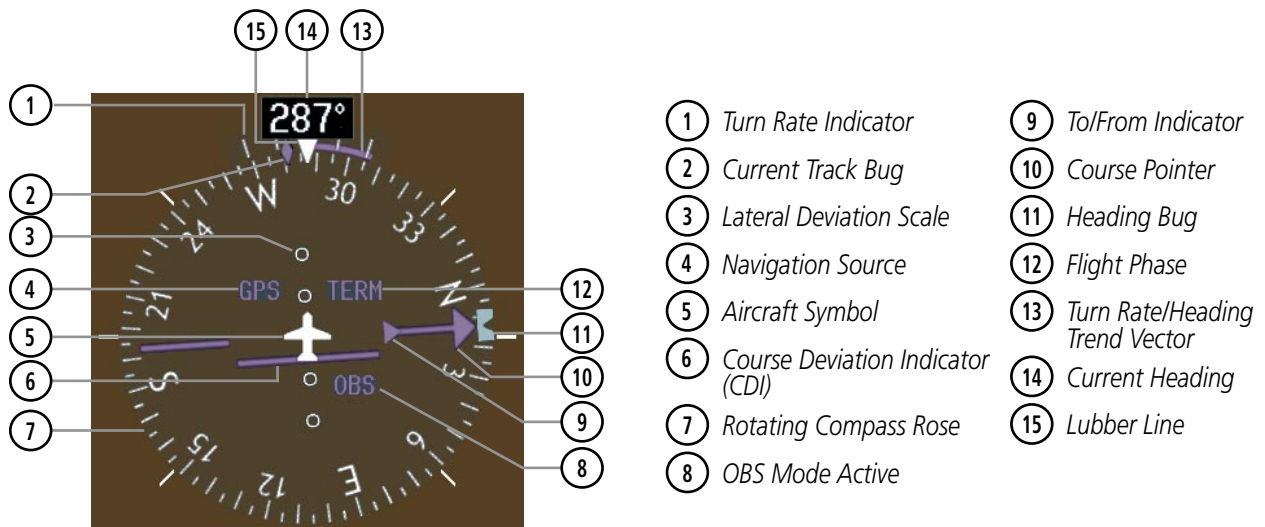

Figure 2-14 Horizontal Situation Indicator (HSI)



The Arc HSI (Figure 2-15) is a 140° expanded section of the compass rose. The Arc HSI contains a Course Pointer, To/From Indicator, a sliding deviation indicator (the To/From and deviation indicators are combined), and a deviation scale. Upon station passage, the To/From Indicator flips and points to the tail of the aircraft, just like a conventional To/From flag. Depending on the navigation source, the CDI on the Arc HSI can appear in two different ways: an arrowhead (GPS, VOR, OBS) or a diamond (LOC).



**Figure 2-15 Arc HSI**

The Selected Heading is shown to the upper left of the HSI for 3 seconds after being adjusted. The light blue bug on the compass rose corresponds to the Selected Heading. While the HSI is displayed as an arc, if the Selected Heading Bug is adjusted off the shown portion of the compass rose, the digital reading displayed.

**Adjusting the Selected Heading:**

- Turn the **HDG** Knob to set the Selected Heading.
- Press the **HDG** Knob to synchronize the bug to the current heading.

The Selected Course is shown to the upper right of the HSI for 3 seconds after being adjusted. While the HSI is displayed as an arc, the Selected Course is displayed whenever the Course Pointer is not within the 140° currently shown.

**Adjusting the Selected Course:**

- Turn the **CRS** Knob to set the Selected Course.
- Press the **CRS** Knob to re-center the CDI and return the course pointer to the bearing of the active waypoint or navigation station (see OBS Mode for adjusting a GPS course).



**Figure 2-16 Heading and Course Indications**

Navigation angles (track, heading, course, bearing) are corrected to the computed magnetic variation ('Mag Var') or referenced to true north (denoted 'T'), set on the AUX - System Setup Page. When an approach referenced to true north has been loaded into the flight plan, the system generates a message to change the navigation angle setting to 'True' at the appropriate time.



Figure 2-17 Heading and Course Indications (True)

**Changing the navigation angle setting:**

- 1) Use the **FMS** Knob to select the AUX - System Setup Page on the MFD.
- 2) Press the **FMS** Knob to activate the cursor.
- 3) Turn the large **FMS** Knob to highlight 'Nav Angle' in the 'Display Units' box (Figure 2-18).
- 4) Turn the small **FMS** Knob to highlight the desired setting and press the **ENT** Key.
  - TRUE - References angles to true north (denoted with 'T')
  - MAGNETIC - Angles corrected to the computed magnetic variation ('Mag Var')



Figure 2-18 System Setup Page, Navigation Angle Settings

### TURN RATE INDICATOR

The Turn Rate Indicator is located directly above the rotating compass card. Tick marks to the left and right of the lubber line denote half-standard and standard turn rates. A magenta Turn Rate Trend Vector shows the current turn rate. The end of the trend vector gives the heading predicted in 6 seconds, based on the present turn rate. A standard-rate turn is shown on the indicator by the trend vector stopping at the standard turn rate tick mark, corresponding to a predicted heading of 18° from the current heading. At rates greater than 4 deg/sec, an arrowhead appears at the end of the magenta trend vector and the prediction is no longer valid.



Figure 2-19 Turn Rate Indicator and Trend Vector

### BEARING POINTERS AND INFORMATION WINDOWS



**NOTE:** When the Arc HSI is displayed, the Bearing Information windows and pointers are disabled.

Two bearing pointers and associated information can be displayed on the HSI for NAV and GPS sources. The pointers are light blue and are single- (BRG1) or double-lined (BRG2); an icon is shown in the respective information window to indicate the pointer type. The bearing pointers never override the CDI and are visually separated from the CDI by a white ring (shown when bearing pointers are selected but not necessarily visible due to data unavailability).

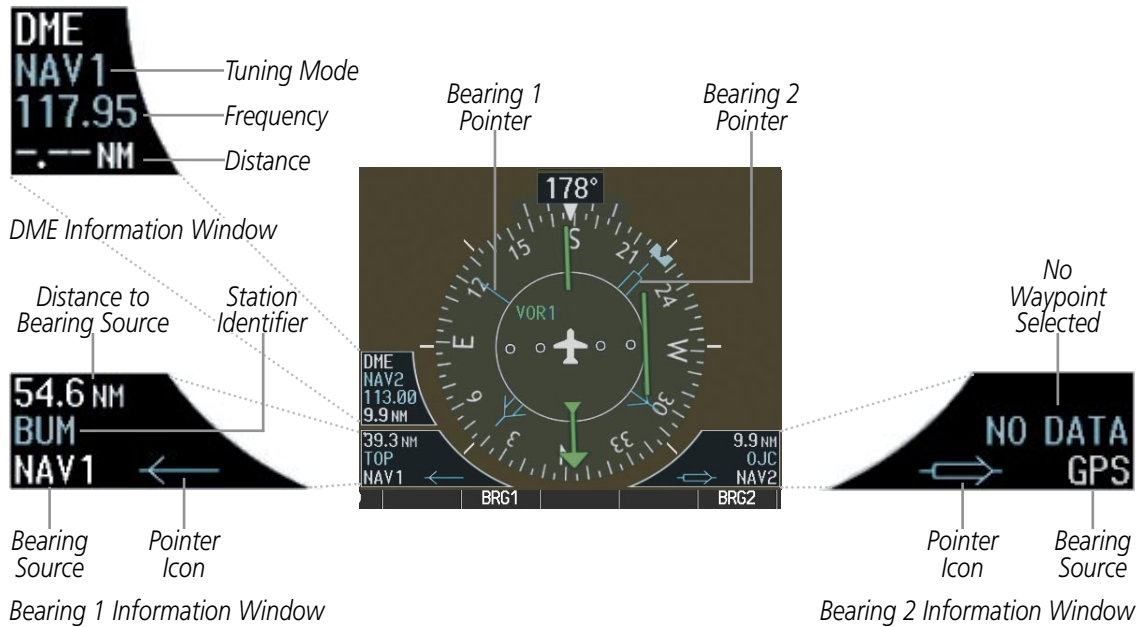

Figure 2-20 HSI with Bearing and DME Information

When a bearing pointer is displayed, its associated information window is also displayed. The Bearing Information windows (Figure 2-20) are displayed to the lower sides of the HSI and show:

- Bearing source (NAV, GPS, ADF)
- Pointer icon (BRG1 = single line, BRG2 = double line)
- Frequency (NAV, ADF)
- Station/waypoint identifier (NAV, GPS)
- GPS-derived great circle distance to bearing source

If the NAV radio is the bearing source and is tuned to an ILS frequency (refer to the Audio Panel and CNS Section for information on tuning the radios), the bearing pointer is removed from the HSI and the frequency is replaced with “ILS”. When NAV1 or NAV2 is the selected bearing source, the frequency is replaced by the station identifier when the station is within range. If GPS is the bearing source, the active waypoint identifier is displayed in lieu of a frequency.

The bearing pointer is removed from the HSI and “NO DATA” is displayed in the information window if:

- The NAV radio is not receiving the tuned VOR station
- GPS is the bearing source and an active waypoint is not selected

#### Selecting bearing display and changing sources:

- 1) Press the **PFD** Softkey.
- 2) Press a **BRG** Softkey to display the desired bearing pointer and information window with a NAV source.
- 3) Press the **BRG** Softkey again to change the bearing source to GPS.
- 4) Press the **BRG** Softkey a third time to change the bearing source to ADF (note: ADF radio installation is optional).
- 5) To remove the bearing pointer and information window, press the **BRG** Softkey again.

## DME INFORMATION WINDOW



**NOTE:** DME radio installation is optional.

The DME Information Window is displayed above the BRG1 Information Window and shows the DME label, tuning mode (NAV1, NAV2, or HOLD), frequency, and distance. When a signal is invalid, the distance is replaced by “-- -- NM”. Refer to the Audio Panel and CNS Section for information on tuning the radios.

#### Displaying the DME Information Window:

- 1) Press the **PFD** Softkey.
- 2) Press the **DME** Softkey to display the DME Information Window above the BRG1 Information Window.
- 3) To remove the DME Information Window, press the **DME** Softkey again.

## COURSE DEVIATION INDICATOR (CDI)

**NOTE:** If a heading change of greater than 105° with respect to the course is made, the CDI on the Arc HSI switches to the opposite side of the deviation scale and displays reverse sensing.

The Course Deviation Indicator (CDI) moves left or right from the course pointer along a lateral deviation scale to display aircraft position relative to the course. If the course deviation data is not valid, the CDI is not displayed.

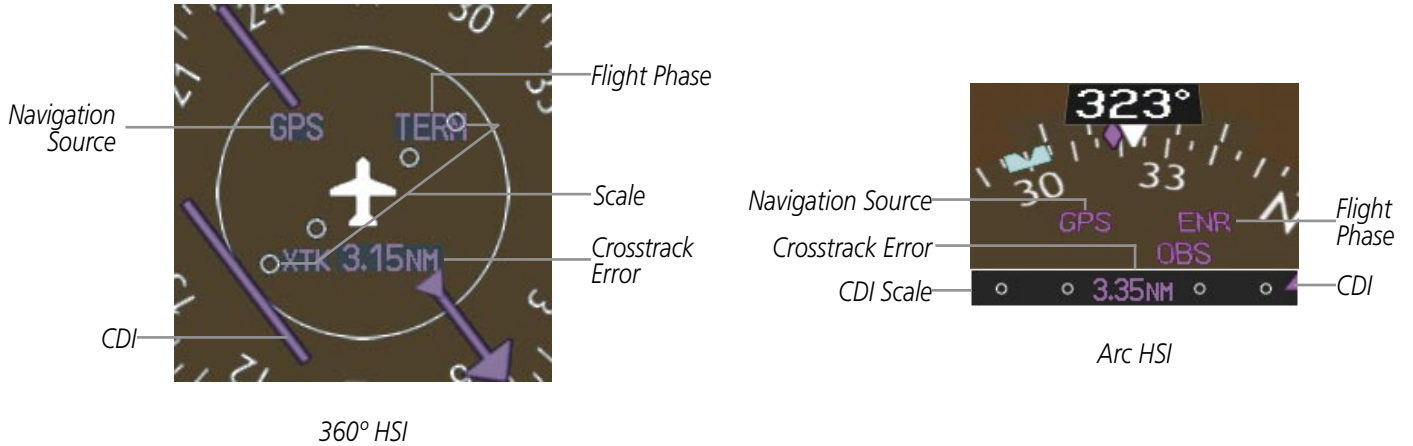

Figure 2-21 Course Deviation Indicator

The CDI can display two sources of navigation: GPS or NAV (VOR, localizer). Color indicates the current navigation source: magenta (for GPS) or green (for VOR and LOC). The full scale limits for the CDI are defined by a GPS-derived distance when coupled to GPS. When coupled to a VOR or localizer (LOC), the CDI has the same angular limits as a mechanical CDI. If the CDI exceeds the maximum deviation on the scale (two dots) while coupled to GPS, the crosstrack error (XTK) is displayed below the white aircraft symbol.

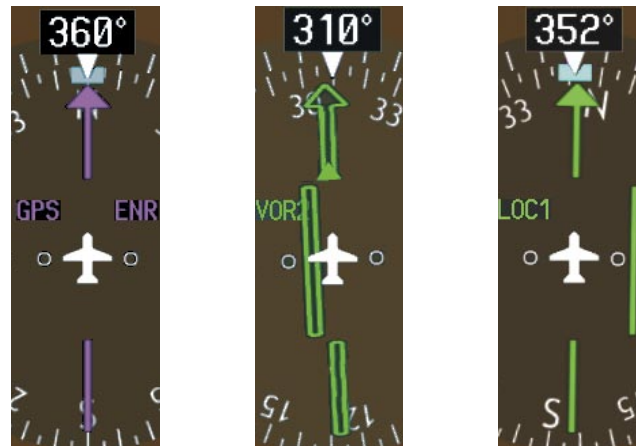
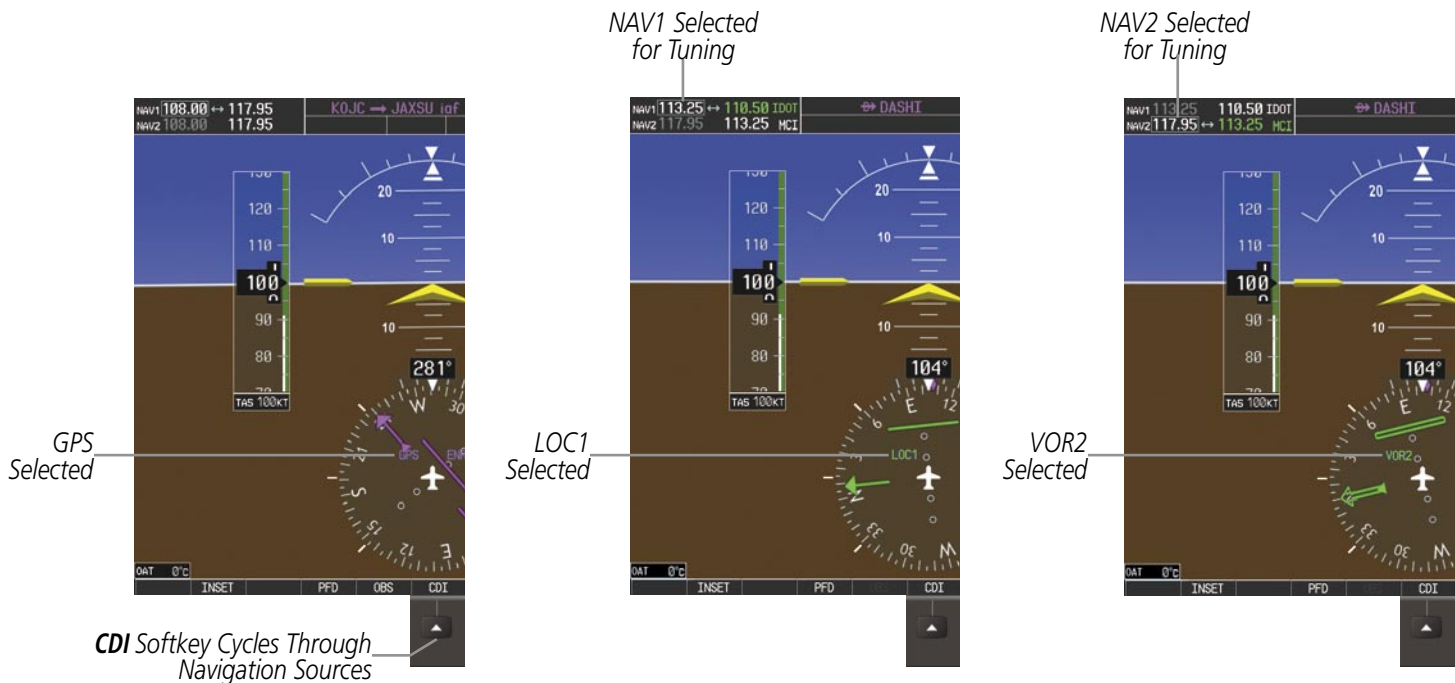

Figure 2-22 Navigation Sources

**Changing navigation sources:**

- 1) Select the **CDI** Softkey to change from GPS to VOR1 or LOC1. This places the light blue tuning box over the NAV1 standby frequency in the upper left corner of the PFD.
- 2) Select the **CDI** Softkey again to change from VOR1 or LOC1 to VOR2 or LOC2. This places the light blue tuning box over the NAV2 standby frequency.
- 3) Select the **CDI** Softkey a third time to return to GPS.



**Figure 2-23 Selecting a Navigation Source**

The system automatically switches from GPS to LOC navigation source and changes the CDI scaling accordingly when all of the following occur:

- A localizer or ILS approach has been loaded into the active flight plan
- The final approach fix (FAF) is the active waypoint, the FAF is less than 15 nm away, and the aircraft is moving toward the FAF
- A valid localizer frequency has been tuned
- The GPS CDI deviation is less than 1.2 times full-scale deflection

GPS steering guidance is still provided after the CDI automatically switches to LOC until LOC capture, up to the Final Approach Fix (FAF) for an ILS approach, or until GPS information becomes invalid. Activating a Vector-to-Final (VTF; see the GPS Navigation Section) also causes the CDI to switch to LOC navigation source; GPS steering guidance is not provided after this switch.

## GPS CDI SCALING

When GPS is the selected navigation source, the flight plan legs are sequenced automatically and annunciations appear on the HSI for the flight phase. Flight phase annunciations are normally shown in magenta, but when cautionary conditions exist the color changes to yellow. If the current leg in the flight plan is a heading leg, 'HDG LEG' is annunciated in magenta beneath the aircraft symbol.

The current GPS CDI scale setting is displayed as 'System CDI' on the AUX - System Setup Page and the full-scale deflection setting may also be changed (2.0 nm, 1.0 nm, 0.3 nm, or Auto) from this page (Figure 2-24). If the selected scaling is smaller than the automatic setting for enroute and terminal phases, the CDI is scaled accordingly and the selected setting is displayed rather than the flight phase annunciation.

### Changing the selected GPS CDI setting:

- 1) Use the **FMS** Knob to select the AUX - System Setup Page on the MFD.
- 2) Press the **FMS** Knob to activate the cursor.
- 3) Turn the large **FMS** Knob to highlight 'Selected' in the 'GPS CDI' box.
- 4) Turn the small **FMS** Knob to highlight the desired setting and press the **ENT** Key.
- 5) To cancel the selection, press the **FMS** Knob or the **CLR** Key.



Figure 2-24 System Setup Page, GPS CDI Settings

When set to 'Auto' (default), the GPS CDI scale automatically adjusts to the desired limits based upon the current phase of flight (Figure 2-25, Table 2-1).

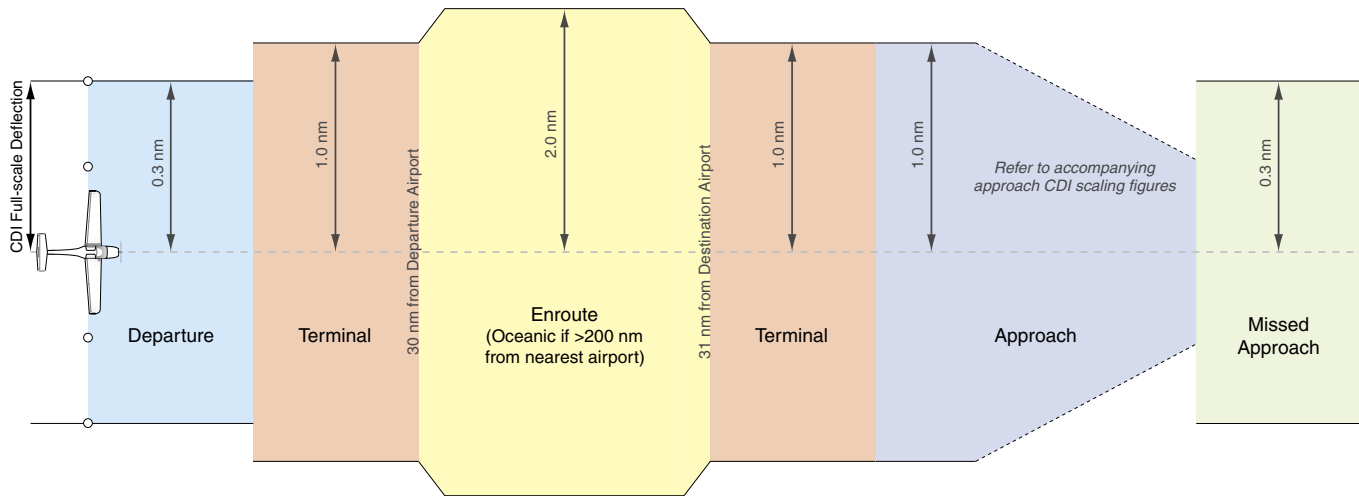
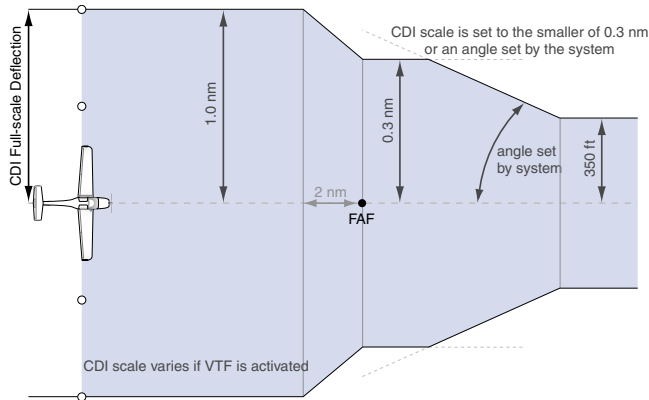

Figure 2-25 Automatic CDI Scaling

- Once a departure procedure is activated, the CDI is scaled for **departure** (0.3 nm).
- The system switches from departure to **terminal** CDI scaling (1.0 nm) under the following conditions:
  - The next leg in the procedure is not aligned with the departure runway
  - The next leg in the departure procedure is not CA, CD, CF, CI, CR, DE, FA, FC, FD, FM, IF, or TF (see Glossary for leg type definitions)
  - After any leg in the departure procedure that is not CA or FA
- At 30 nm from the departure airport (or at the last departure waypoint if more than 30 nm from the departure airport), the **enroute** phase of flight is automatically entered and CDI scaling changes to 2.0 nm over a distance of 1.0 nm.
- If after completing the departure procedure the nearest airport is more than 200 nm away from the aircraft and the approach procedure has not yet commenced, the CDI is scaled for **oceanic** flight (2.0 nm).
- Within 31 nm of the destination airport (**terminal** area), the CDI scale gradually ramps down from 2.0 nm to 1.0 nm over a distance of 1.0 nm; if a transition back to enroute flight occurs, the CDI scale increases back to 2.0 in the same manner.
- During **approach**, the CDI scale ramps down even further (see Figures 2-26 and 2-27). This transition normally occurs within 2.0 nm of the final approach fix (FAF). The CDI switches to approach scaling automatically once the approach procedure is activated or if Vector-to-Final (VTF) is selected.
  - If the active waypoint is the FAF, the ground track and the bearing to the FAF must be within 45° of the final approach segment course.
  - If the active waypoint is part of the missed approach procedure, the active leg and preceding missed approach legs must be aligned with the final approach segment course and the aircraft must not have passed the turn initiation point.





**Figure 2-26 Typical LNAV and LNAV+V Approach CDI Scaling**

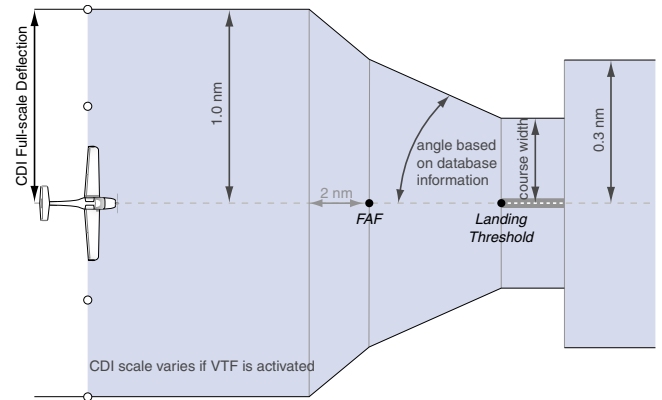

**Figure 2-27 Typical LNAV/VNAV and LPV Approach CDI Scaling**

- When a **missed approach** is activated, the CDI scale changes to 0.3 nm.
- The system automatically switches back to **terminal** scaling under the following conditions:
  - The next leg in the missed approach procedure is not aligned with the final approach path
  - The next leg in the missed approach procedure is not CA, CD, CF, CI, CR, DE, FA, FC, FD, FM, IF, or TF
  - After any leg in the missed approach procedure that is not CA or FA

| Flight Phase                                    | Annunciation    | Automatic CDI Full-scale Deflection  |
|---|-----------------|--|
| Departure                                       | <b>DPRT</b>     | 0.3 nm   |
| Terminal  | <b>TERM</b>     | 1.0 nm   |
| Enroute   | <b>ENR</b>      | 2.0 nm   |
| Oceanic   | <b>OCN</b>      | 2.0 nm   |
| Approach (Non-precision)                        | <b>LNAV</b>     | 1.0 nm decreasing to 350 feet depending on variables (see Figure 2-26)                               |
| Approach (Non-precision with Vertical Guidance) | <b>LNAV + V</b> |  |
| Approach (LNAV/VNAV)                            | <b>L/VNAV</b>   | 1.0 nm decreasing to a specified course width, then 0.3 nm, depending on variables (see Figure 2-27) |
| Approach (LPV)                                  | <b>LPV</b>      |  |
| Missed Approach                                 | <b>MAPR</b>     | 0.3 nm   |

**Table 2-1 Automatic GPS CDI Scaling**

OBS MODE



**NOTE:** VNV is inhibited while automatic waypoint sequencing has been suspended.

Enabling Omni-bearing Selector (OBS) Mode suspends the automatic sequencing of waypoints in a GPS flight plan (GPS must be the selected navigation source), but retains the current “active-to” waypoint as the navigation reference even after passing the waypoint. ‘OBS’ is annunciated to the lower right of the aircraft symbol when OBS Mode is selected (see Figure 2-28).

While OBS Mode is enabled, a course line is drawn through the “active-to” waypoint on the moving map. If desired, the course to/from the waypoint can now be adjusted. When OBS Mode is disabled, the GPS flight plan returns to normal operation with automatic sequencing of waypoints, following the course set in OBS Mode. The flight path on the moving map retains the modified course line.

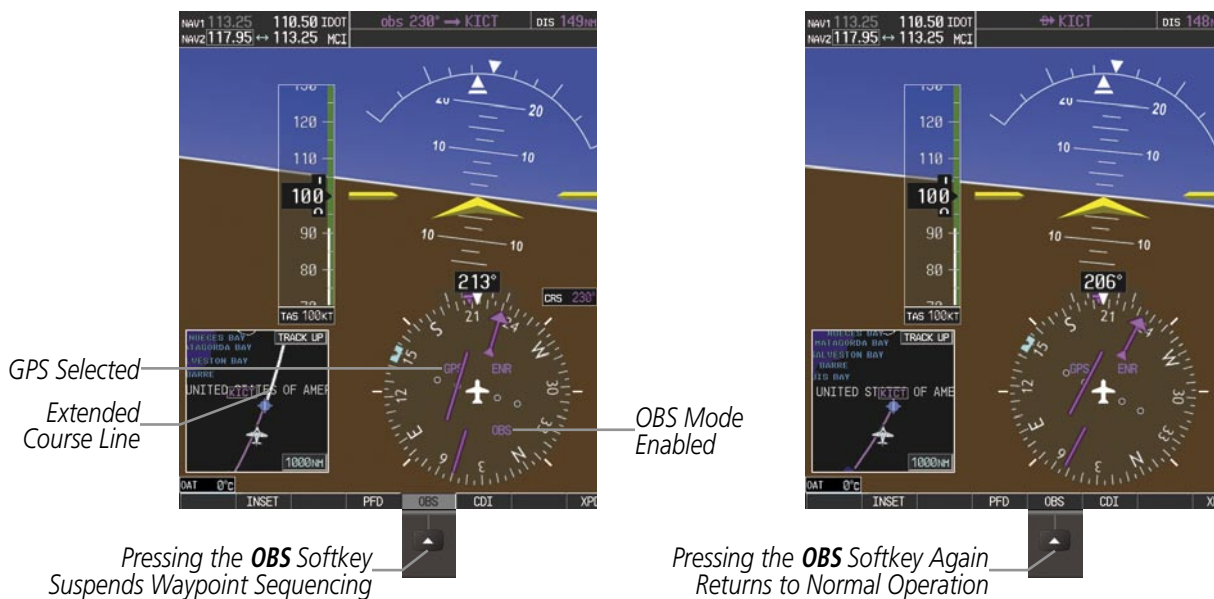
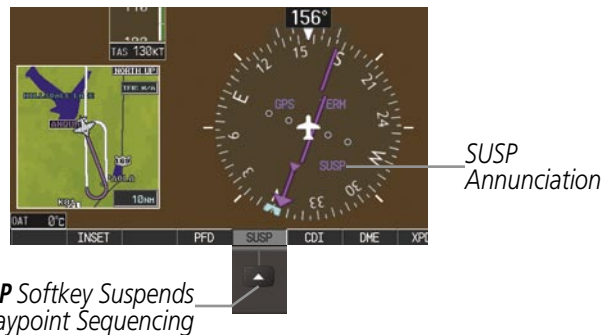

Figure 2-28 Omni-bearing Selector (OBS) Mode

**Enabling/disabling OBS Mode while navigating a GPS flight plan:**

- 1) Select the **OBS** Softkey to select OBS Mode.
- 2) Turn the **CRS** Knob to select the desired course to/from the waypoint. Press the **CRS** Knob to synchronize the Selected Course with the bearing to the next waypoint.
- 3) Select the **OBS** Softkey again to return to automatic waypoint sequencing.

As the aircraft crosses the missed approach point (MAP), automatic approach waypoint sequencing is suspended. 'SUSP' appears on the HSI (to the lower right of the aircraft symbol) in place of 'OBS' and the **OBS** Softkey label changes to **SUSP**.



**Figure 2-29 Suspending Automatic Waypoint Sequencing**

## 2.2 SUPPLEMENTAL FLIGHT DATA



**NOTE:** Selecting the **DFLTS** Softkey (a second-level PFD softkey) turns off metric Altimeter display, the Inset Map, and wind data display.

In addition to the flight instruments, the PFD also displays various supplemental information, including the Outside Air Temperature (OAT), wind data, and Vertical Navigation (VNV) indications.

### OUTSIDE AIR TEMPERATURE

The Outside Air Temperature (OAT) is displayed in degrees Celsius (°C) by default in the lower left of the PFD under normal display conditions, or below the true airspeed in reversionary mode.

Normal Display



Reversionary Mode



OAT 0°C

Figure 2-30 Outside Air Temperature

**WIND DATA**

Wind direction and speed (relative to the aircraft) in knots can be displayed in a window to the upper left of the HSI. When the window is selected for display, but wind information is invalid or unavailable, the window shows “NO WIND DATA”. Wind data can be displayed in three different ways:

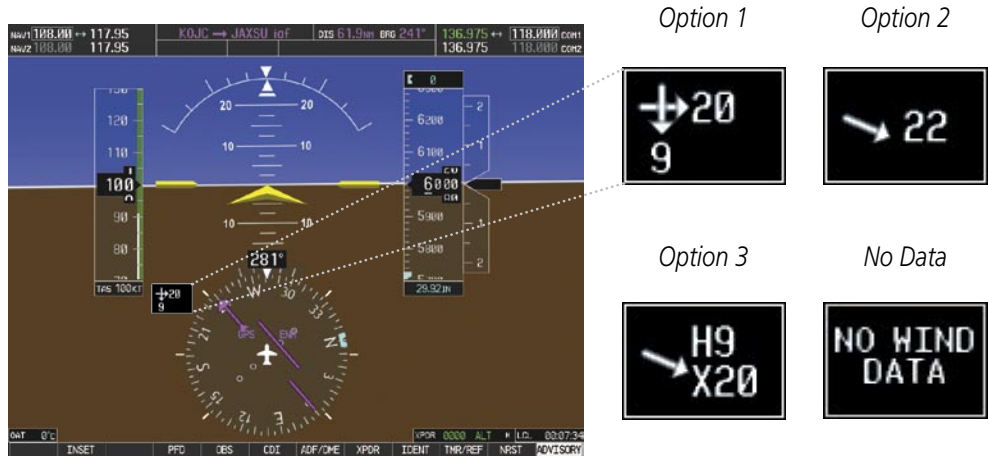

**Figure 2-31 Wind Data**

**Displaying wind data:**

- 1) Press the **PFD** Softkey.
- 2) Press the **WIND** Softkey to display wind data below the Selected Heading.
- 3) Press one of the **OPTN** softkeys to change how wind data is displayed:
  - **OPTN 1:** Head and crosswind components
  - **OPTN 2:** Total wind direction and speed
  - **OPTN 3:** Total wind direction with head and crosswind speed components
- 4) To remove the window, press the **OFF** Softkey.

## VERTICAL NAVIGATION (VNV) INDICATIONS

When a VNV flight plan has been activated, VNV indications (VNV Target Altitude, RSVI, VDI) appear on the PFD in conjunction with the “TOD within 1 minute” message and “Vertical track” voice alert. See the GPS Navigation section for details on VNV features. VNV indications are removed from the PFD according to the criteria listed in Table 2-2.



Figure 2-32 Vertical Navigation Indications (PFD)

| Criteria  | VNV Indication Removed         |                          |                     |
|---|--------------------------------|--------------------------|---------------------|
|   | Required Vertical Speed (RSVI) | Vertical Deviation (VDI) | VNV Target Altitude |
| Aircraft > 1 min before the next TOD and not on a descent leg   | X                              | X                        | X                   |
| Aircraft > 1 min before the next TOD due to flight plan change  | X                              | X                        | X                   |
| VNV cancelled ( <b>CNCL VNV</b> Softkey selected on MFD)  | X                              | X                        | X                   |
| Distance to active waypoint cannot be computed due to unsupported flight plan leg type (see GPS Navigation Section) | X                              | X                        | X                   |
| Aircraft > 250 feet below active VNV Target Altitude  | X                              | X                        | X                   |
| Current crosstrack or track angle error has exceeded limit  | X                              | X                        | X                   |
| Active altitude-constrained waypoint can not be reached within maximum allowed flight path angle and vertical speed | X                              | X                        |                     |
| Last altitude-constrained waypoint in active flight plan reached  | X                              | X<br>(30 sec before)     | X                   |

Table 2-2 VNV Indication Removal Criteria

## 2.3 PFD ANNUNCIATIONS AND ALERTING FUNCTIONS

The following annunciations and alerting functions are displayed on the PFD. Refer to Appendix A for more information on alerts and annunciations.

### G1000 ALERTING SYSTEM

Messages appear in the Alerts Window (in the lower right corner of the PFD; Figure 2-33) when a warning, caution, advisory alert, or G1000 message advisory occurs. System alert messages are provided for aware of G1000 system problems or status and may not require pilot action. The Alerts Window allows system alerts to be displayed simultaneously. The **FMS** Knob can be used to scroll through the alert messages. The Alerts Window is enabled/disabled by selecting the **ALERTS** Softkey. If the window is already open when a new message is generated, selecting the **ALERTS** Softkey to acknowledge the message causes it to turn gray.

The Annunciation Window appears to the right of the Vertical Speed Indicator and displays abbreviated annunciation text for aircraft alerts. Text color is based on alert level: warnings appear in red, cautions in yellow, advisory alerts in white. New alerts, regardless of priority, are displayed at the top of the Annunciation Window, separated by a white line from acknowledged alerts. Once acknowledged, they are sequenced based on priority.

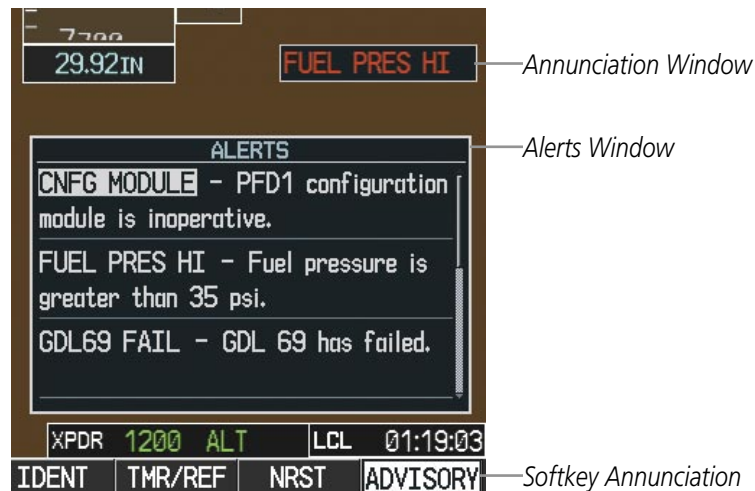

Figure 2-33 G1000 Alerting System

The **ALERTS** Softkey label changes to display the appropriate annunciation when an alert is issued. The annunciation flashes and the appropriate aural alert sounds until acknowledged by pressing the softkey. The softkey then reverts to the **ALERTS** Softkey label, and when selected again opens the Alerts Window to display a descriptive message of the alert.

Warnings are time-critical and require immediate attention. A flashing **WARNING** Softkey annunciation and aural tone (single chime every two seconds) indicate the presence of a warning. The aural tone and flashing **WARNING** Softkey annunciation continue until acknowledged (by pressing the **WARNING** Softkey).

Caution indicates the existence of abnormal conditions on the aircraft that may require pilot intervention. A flashing **CAUTION** Softkey annunciation and single aural tone (one chime) indicate the presence of a caution. The flashing **CAUTION** Softkey annunciation continues to flash until acknowledged (by pressing the **CAUTION** Softkey).

An advisory provides general information to the pilot that may not need immediate attention. A flashing **ADVISORY** Softkey annunciation (no aural tone) indicates the presence of a message advisory. The flashing **ADVISORY** Softkey annunciation continues to flash until acknowledged (by pressing the **ADVISORY** Softkey).



Figure 2-34 Softkey Annunciation (ALERTS Softkey Labels)

## MARKER BEACON ANNUNCIATIONS

Marker Beacon Annunciations are displayed on the PFD to the left of the Selected Altitude. Outer marker reception is indicated in blue, middle in yellow, and inner in white. Refer to the Audio Panel and CNS Section for more information on Marker Beacon Annunciations.

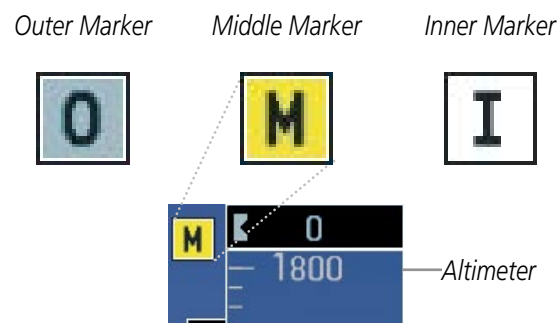

Figure 2-35 Marker Beacon Annunciations

## TRAFFIC ANNUNCIATION

The G1000 System displays traffic symbolically on the PFD Inset Map, the Navigation Map Page (MFD), and various other MFD page maps. Refer to the Hazard Avoidance Section and Appendix E for more details about the Traffic Information Service (TIS) and optional Traffic Advisory Systems (TAS). When a traffic advisory (TA) is detected, the following automatically occur:

- The PFD Inset Map is enabled and displays traffic
- A flashing black-on-yellow 'TRAFFIC' annunciation (Figure 2-36) appears to the top left of the Attitude Indicator for five seconds and remains displayed until no TAs are detected in the area
- A single "Traffic" aural alert is generated, unless an optional Traffic Advisory System (TAS) is installed (refer to the applicable TAS documentation for alerts generated by TAS equipment)

If additional TAs appear, new aural and visual alerts are generated.



**TAWS ANNUNCIATIONS (OPTIONAL)**

Terrain Awareness and Warning System (TAWS) annunciations appear on the PFD to the upper left of the Altimeter. Refer to the Hazard Avoidance Section and Appendix A for information on TAWS alerts and annunciations.

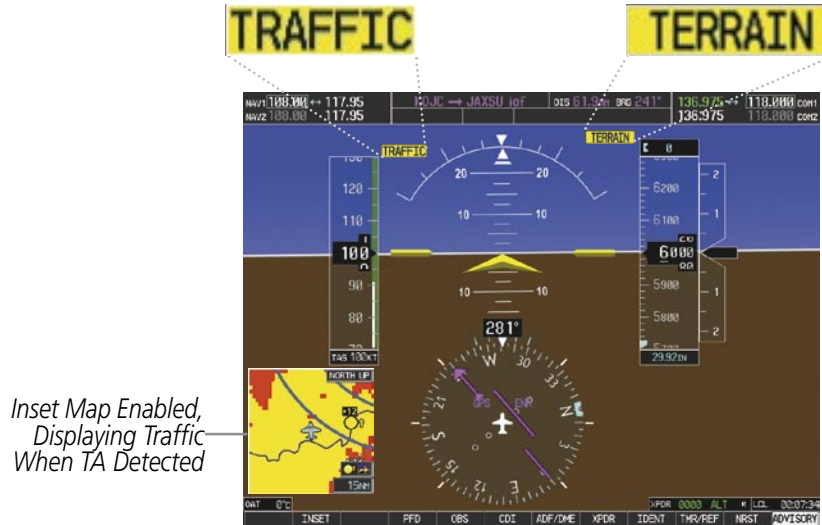

**Figure 2-36 Traffic and Example TAWS Annunciations**

**ALTITUDE ALERTING**

The Altitude Alerting function provides the pilot with visual and aural alerts when approaching the Selected Altitude. Whenever the Selected Altitude is changed, the Altitude Alerter is reset. The Altitude Alerter is independent of the GFC 700 AFCS, but alerting tones are generated only when the GFC 700 is installed. The following occur when approaching the Selected Altitude:

- Upon passing through 1000 feet of the Selected Altitude, the Selected Altitude (shown above the Altimeter) changes to black text on a light blue background, flashes for 5 seconds, and an aural tone is generated.
- When the aircraft passes within 200 ft of the Selected Altitude, the Selected Altitude changes to light blue text on a black background and flashes for 5 seconds.
- After reaching the Selected Altitude, if the pilot flies outside the deviation band ( $\pm 200$  feet of the Selected Altitude), the Selected Altitude changes to yellow text on a black background, flashes for 5 seconds, and an aural tone is generated.



**Figure 2-37 Altitude Alerting Visual Annunciations**

## LOW ALTITUDE ANNUNCIATION



**NOTE:** The Low Altitude Annunciation is available only for aircraft with GIA 63W Integrated Avionics Units when WAAS is available. This annunciation is not shown for systems with TAWS, unless TAWS is inhibited.

When the Final Approach Fix (FAF) is the active waypoint in a GPS WAAS approach using vertical guidance, a Low Altitude Annunciation may appear if the current aircraft altitude is at least 164 feet below the prescribed altitude at the FAF. A black-on-yellow 'LOW ALT' annunciation appears to the top right of the Altimeter, flashing for several seconds then remaining displayed until the condition is resolved.



Figure 2-38 Low Altitude on GPS WAAS Approach

## MINIMUM DESCENT ALTITUDE/DECISION HEIGHT ALERTING

For altitude awareness, a barometric Minimum Descent Altitude (MDA, or Decision Height, DH) can be set in the Timer/References Window and is reset when the power is cycled. When active, the altitude setting is displayed to the lower left of the Altimeter and with a bug at the corresponding altitude along the Altimeter (once the altitude is within the range of the tape). The following visual annunciations occur when approaching the MDA/DH:

- When the aircraft altitude descends to within 2500 feet of the MDA/DH setting, the 'BARO MIN' box appears with the altitude in light blue text. The bug appears on the altitude tape in light blue once in range.
- When the aircraft passes through 100 feet of the MDA/DH, the bug and text turn white.
- Once the aircraft reaches the MDA/DH, the bug and text turn yellow and the aural alert, "Minimums Minimums", is generated.

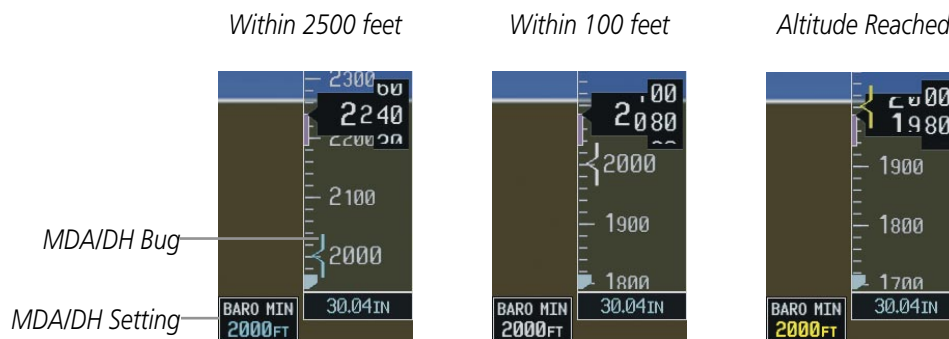
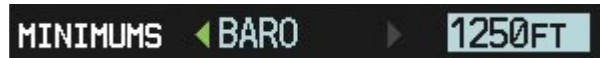

Figure 2-39 Minimum Descent Altitude/Decision Height Alerting Visual Annunciations

**Setting the barometric minimum descent altitude/decision height and bug:**

- 1) Select the **TMR/REF** Softkey.
- 2) Turn the large **FMS** Knob to highlight the 'Minimums' field (Figure 2-40).
- 3) Turn the small **FMS** Knob to select BARO. OFF is selected by default. Press the **ENT** Key or turn the large **FMS** Knob to highlight the next field.
- 4) Use the small **FMS** Knob to enter the desired altitude (from zero to 16,000 feet).
- 5) To remove the window, press the **CLR** Key or the **TMR/REF** Softkey.



**Figure 2-40 Minimum Descent Altitude/Decision Height Setting (Timer/References Window)**

Alerting is inhibited while the aircraft is on the ground and until the aircraft reaches 150 feet above the setting for the alert. If the aircraft proceeds to climb after having reached the MDA/DH, once it reaches 50 feet above the MDA/DH, alerting is disabled.

## 2.4 ABNORMAL OPERATIONS

### ABNORMAL GPS CONDITIONS

The annunciations listed in Table 2-3 can appear on the HSI when abnormal GPS conditions occur; see Figure 2-41 for examples. Refer to the GPS Navigation Section for more information on Dead Reckoning Mode.

| Annunciation | Location                       | Description   |
|--------------|--------------------------------|---|
| LOI          | Lower left of aircraft symbol  | Loss of Integrity Monitoring—GPS integrity is insufficient for the current phase of flight  |
| WARN         | Lower left of aircraft symbol  | Warning—RAIM function detects excessive GPS position errors   |
| INTEG OK     | Lower left of aircraft symbol  | Integrity OK—GPS integrity has been restored to within normal limits (annunciation displayed for 5 seconds)                                     |
| DR           | Upper right of aircraft symbol | Dead Reckoning—System is using projected position rather than GPS position to compute navigation data and sequence active flight plan waypoints |

Table 2-3 Abnormal GPS Conditions Annunciated on HSI



Figure 2-41 Example HSI Annunciations

Dead Reckoning Mode causes the CDI to be removed from the display (when GPS is the selected navigation source) and the following items on the PFD to be shown in yellow:

- Current Track Bug
- Wind Data (calculated based on GPS information)
- Distances in the Bearing Information windows
- GPS bearing pointers

These items should be verified when operating in Dead Reckoning Mode.

**UNUSUAL ATTITUDES**

When the aircraft enters an unusual pitch attitude, red extreme pitch warning chevrons pointing toward the horizon are displayed on the Attitude Indicator, starting at 50° above and 30° below the horizon line.

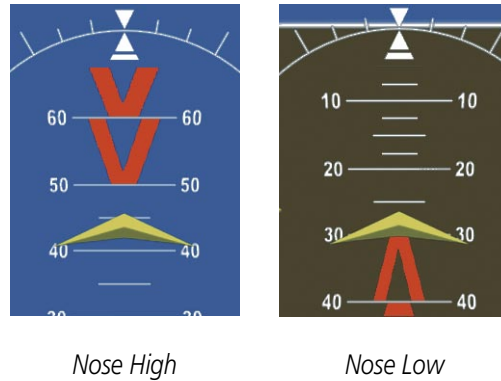

**Figure 2-42 Pitch Attitude Warnings**

If pitch exceeds +30°/-20° or bank exceeds 65°, some information displayed on the PFD is removed. The Altimeter and Airspeed, Attitude, Vertical Speed, and Horizontal Situation indicators remain on the display and the Bearing Information, Alerts, and Annunciation windows can be displayed during such situations. The following information is removed from the PFD (and corresponding softkeys are disabled) when the aircraft experiences unusual attitudes:

- Traffic Annunciations
- AFCS Annunciations
- Flight director Command Bars
- Inset Map
- Outside air temperature (OAT)
- DME Information Window
- Wind data
- Transponder Status Box
- System Time
- PFD Setup Menu
- Windows displayed in the lower right corner of the PFD:
  - Timer/References
  - Nearest Airports
  - Flight Plan
  - Alerts
  - Procedures
  - ADF/DME Tuning
- Minimum Descent Altitude/ Decision Height readout
- Vertical Deviation, Glideslope, and Glidepath Indicators
- Altimeter Barometric Setting
- Selected Altitude
- VNV Target Altitude

**BLANK PAGE**

## SECTION 3 ENGINE INDICATION SYSTEM

The G1000 Engine Indication System (EIS) displays critical engine, electrical, fuel, and other system parameters on the left side of the Multi Function Display (MFD) during normal operations (Figure 3-1). EIS information can be fully expanded to an entire page (EIS - Engine Page) using the **ENGINE** Softkey. In Reversionary Mode, the displays are re-configured to present Primary Flight Display (PFD) symbology together with the EIS.

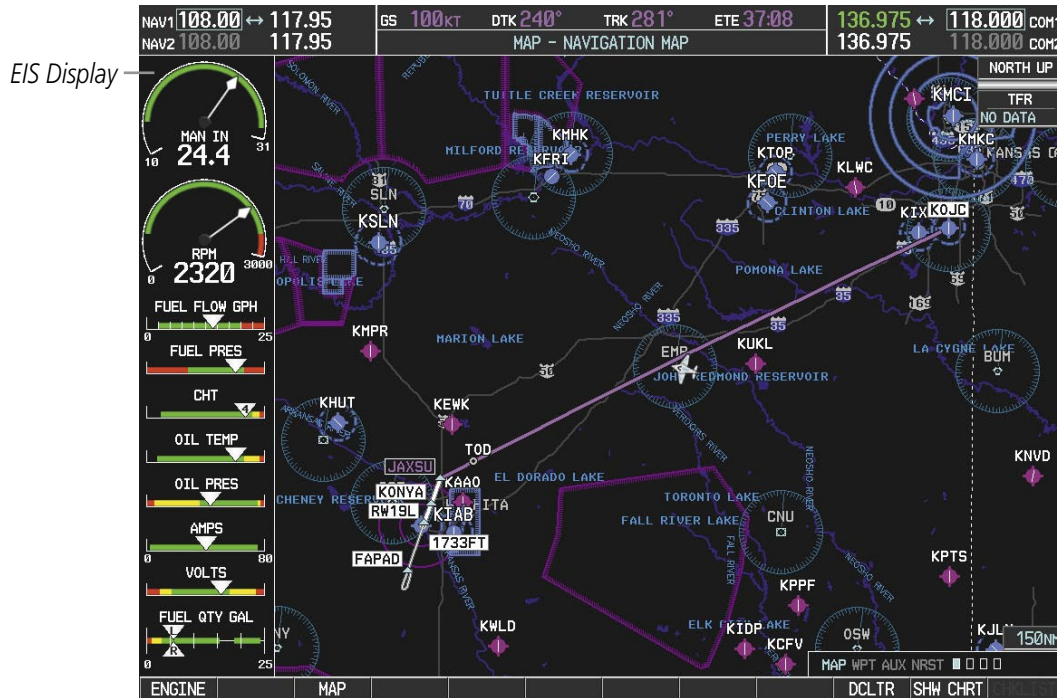

**Figure 3-1 MFD (DA40)**

Green bands on the instruments indicate normal ranges of operation; yellow and red bands indicate caution and warning, respectively. White or uncolored bands indicate areas outside of normal operation not yet in the caution or warning ranges. When unsafe operating conditions occur, the corresponding readouts flash to indicate cautions and warnings. If sensory data to an instrument becomes invalid or unavailable, a red “X” is displayed across the instrument.

## 3.1 EIS DISPLAY

- |   |  |
|---|--|
| ① <b>Engine Manifold Pressure Gauge (MAN IN HG)</b> | Displays manifold pressure in inches of Mercury (in Hg) to indicate engine power ( <i>DA40 only</i> )  |
| ② <b>Tachometer (RPM)</b>                           | Displays propeller speed in revolutions per minute (rpm); the red band indicates propeller overspeed   |
| ③ <b>Fuel Flow Indicator (FUEL FLOW GPH)</b>        | Displays current fuel flow in gallons per hour (gph)   |
| ④ <b>Fuel Pressure Indicator (FUEL PRESS PSI)</b>   | Displays the fuel pressure in pounds per square inch (psi) ( <i>DA40 only option</i> )   |
| ⑤ <b>Cylinder Head Temperature Indicator (CHT)</b>  | Displays the head temperature of the hottest cylinder (number is shown in pointer)   |
| ⑥ <b>Oil Temperature Indicator (OIL TEMP)</b>       | Displays engine oil temperature  |
| ⑦ <b>Oil Pressure Indicator (OIL PRES)</b>          | Displays pressure of oil supplied to the engine  |
| ⑧ <b>Ammeter (AMPS)</b>                             | Displays the alternator load in amperes  |
| ⑨ <b>Voltmeter (VOLTS)</b>                          | Displays the primary bus voltage   |
| ⑩ <b>Fuel Quantity Indicator (FUEL QTY GAL)</b>     | Displays the quantity, in gallons (gal), of fuel in the tanks; pointers labeled L and R indicate the fuel quantity in each tank<br><br><i>Standard Tanks:</i> Indicator ranges from 0 to 20 gal with tick marks every 5 gal; only displays to 17 gal per side when full<br><br><i>Long Range Tanks (optional):</i> Indicator ranges from 0 to 25 gal with tick marks every 5 gal; only displays to 24 gal per side when full |



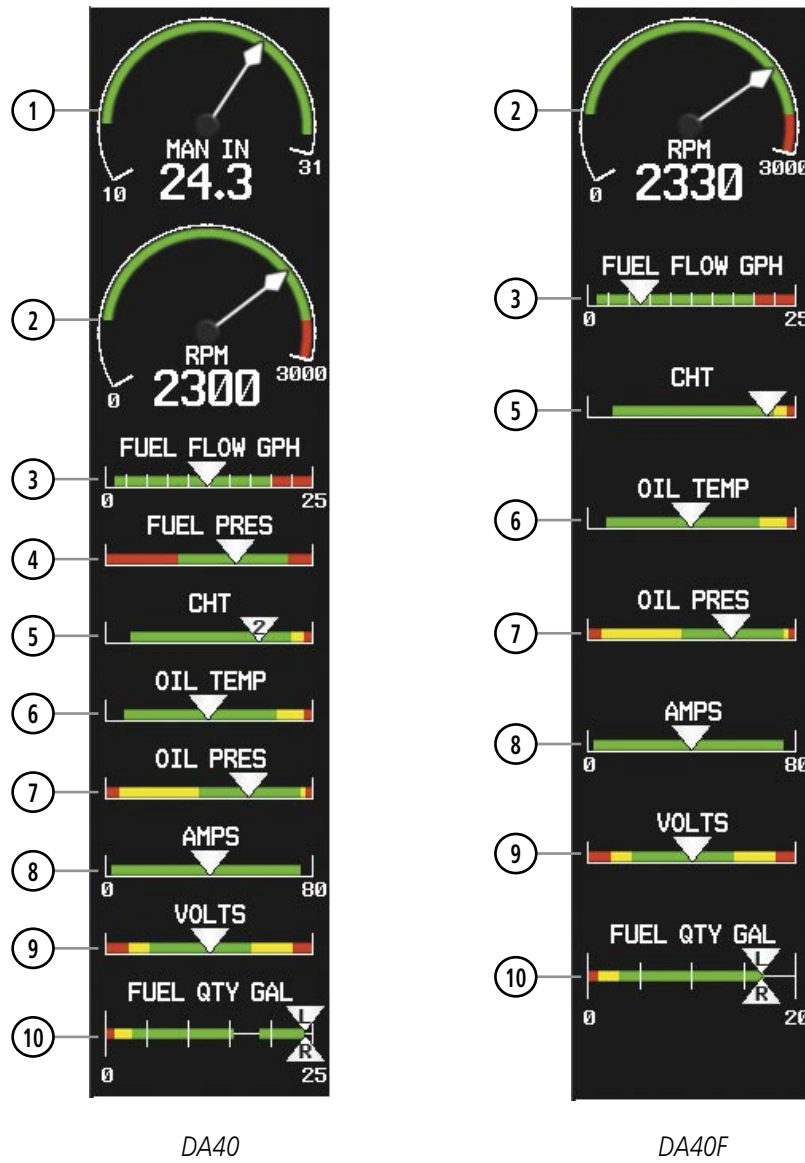

Figure 3-2 EIS Display

## 3.2 ENGINE PAGE

Pressing the **ENGINE** Softkey accesses the Engine Page, which displays all engine, fuel, fuel calculation, and electrical information.

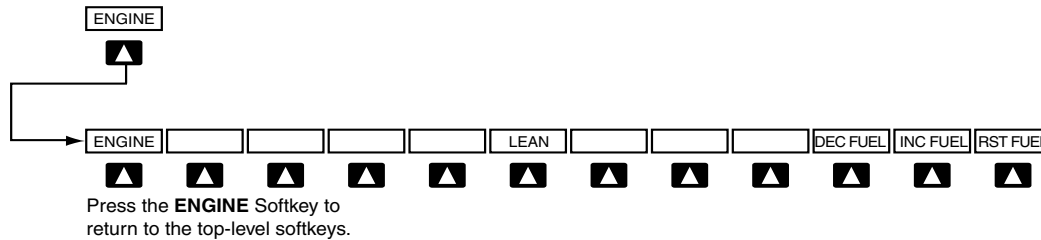

Figure 3-3 Engine Page Softkeys

- ENGINE** Displays EIS - Engine Page and second-level engine softkeys; press again to exit page
- LEAN** Accesses Leaning Assist Mode
- DEC FUEL** Decreases displayed fuel remaining in 1-gal increments
- INC FUEL** Increases displayed fuel remaining in 1-gal increments
- RST FUEL** Resets displayed fuel remaining to maximum fuel capacity for aircraft and fuel used to zero

- ① **Engine Manifold Pressure Gauge (MAN IN HG)** Displays manifold pressure in inches of Mercury (in Hg) to indicate engine power (*DA40 only*)
- ② **Oil Temperature and Pressure Gauges (OIL °F PSI)** Displays oil temperature in degrees Fahrenheit (°F) and pressure in pounds per square inch (psi)
- ③ **Fuel Quantity Gauges (L/R FUEL QTY GAL)** Display the amount of fuel in gallons (gal) of fuel in the tanks.  
*Standard Tanks:* Indicator ranges from 0 to 20 gal with tick marks every 5 gal; only displays to 17 gal per side when full  
*Long Range Tanks (optional):* Indicator ranges from 0 to 25 gal with tick marks every 5 gal; only displays to 24 gal per side when full
- ④ **Total Time in Service (TTL TIME IN SVC)** Displays the total flight hours and is activated when the aircraft becomes airborne (note that time airborne does not necessarily correspond to tachometer time)
- ⑤ **Fuel Calculations Group (FUEL CALCULATOR)** Displays calculated fuel used, endurance, and range (in nautical miles, RANGE NM) based on the displayed fuel remaining and the fuel flow totalizer
- ⑥ **Electrical Group (ELECTRICAL)** Displays the alternator load in amperes and the primary bus voltage
- ⑦ **Engine Temperature Group (TEMPERATURE)** Displays exhaust gas (EGT) and head (CHT) temperatures of all cylinders in °F
- ⑧ **Fuel Flow and Pressure Gauge (FUEL GPH PSI)** Displays fuel flow in gallons per hour (gph) and fuel pressure in pounds per square inch (psi); *fuel pressure gauge is a DA40-only option*
- ⑨ **Tachometer (RPM)** Displays propeller speed in revolutions per minute (rpm); the red band indicates propeller overspeed

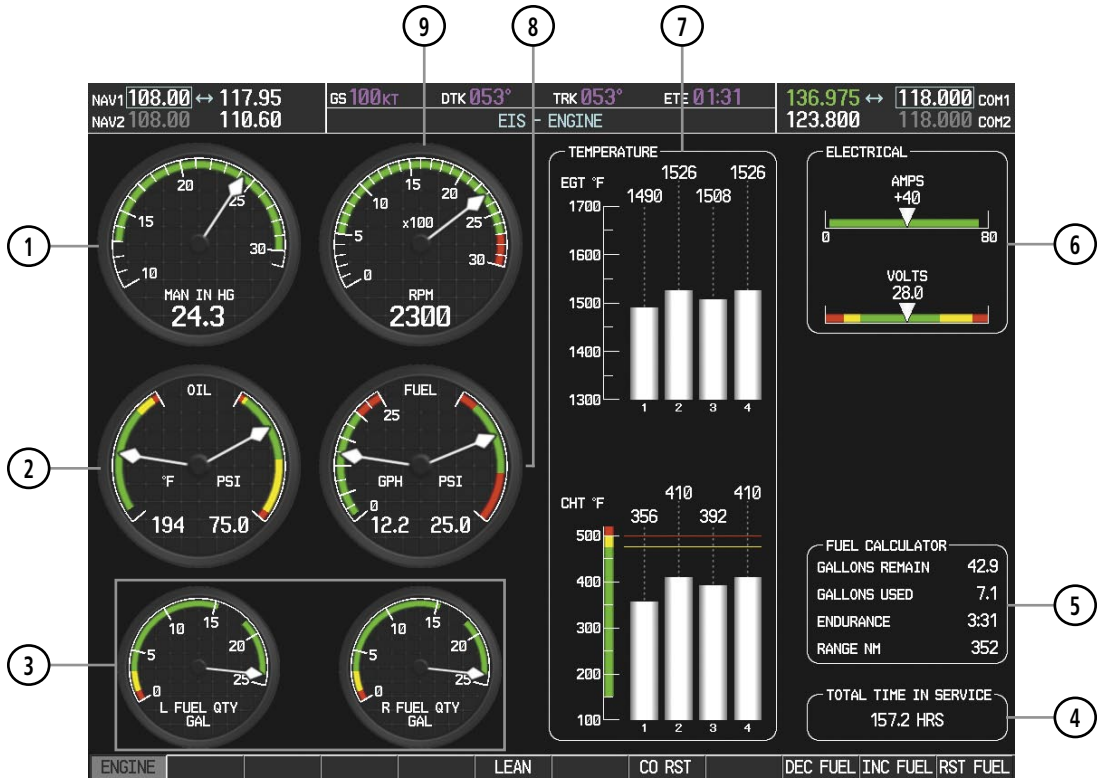

Figure 3-4 Engine Page (DA40)

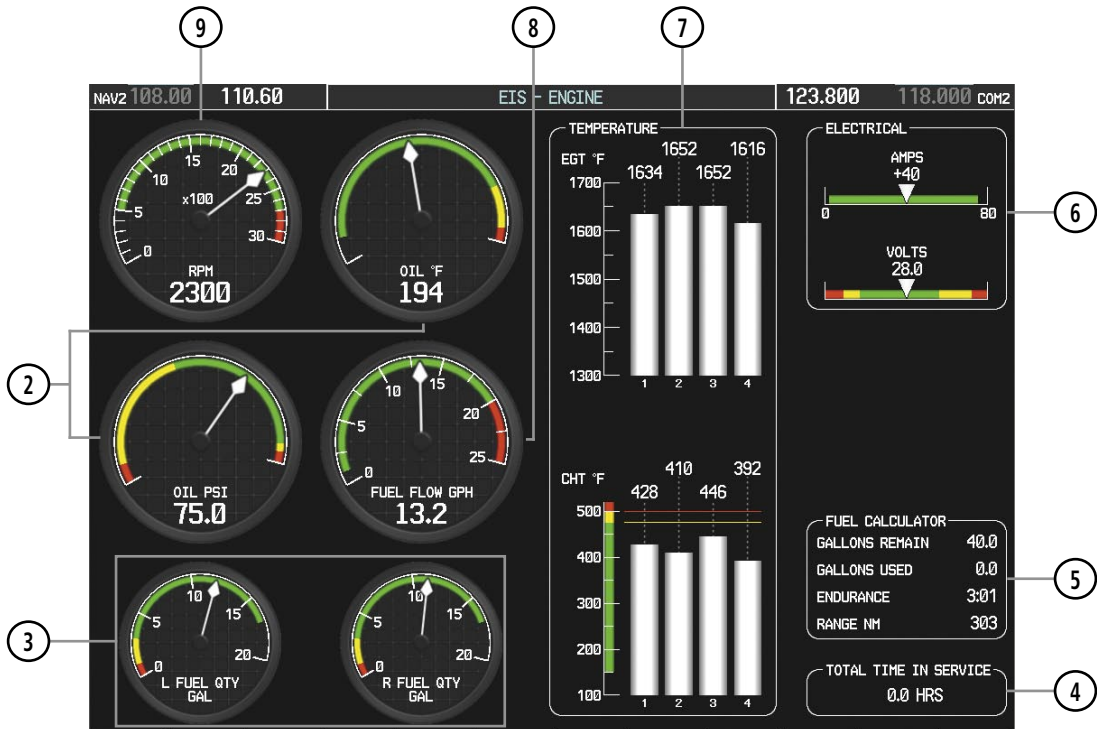

Figure 3-5 Engine Page (DA40F)

## FUEL CALCULATIONS



**NOTE:** Fuel calculations do not use the aircraft fuel quantity indicators and are calculated from the last time the fuel was reset.

Fuel used (GAL USED), endurance (ENDUR), and range (in nautical miles, RANGE NM) are calculated based on the displayed fuel remaining (GAL REM) and the fuel flow totalizer. The calculated range also takes into account the aircraft's heading and the wind direction and speed.

### Adjusting the fuel totalizer quantity:

On the Engine Page, use the **DEC FUEL** and **INC FUEL** softkeys to obtain the desired fuel remaining (GAL REM).

### Resetting the fuel totalizer:

On the Engine Page, press the **RST FUEL** Softkey; this also resets the fuel remaining (GAL REM) to zero.

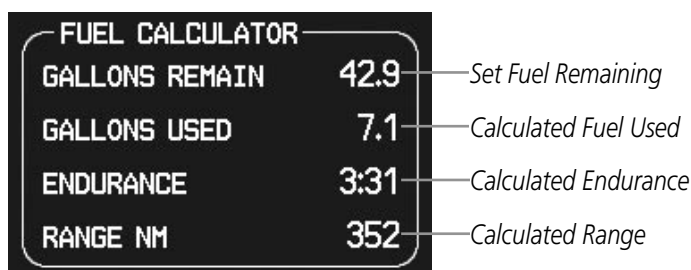
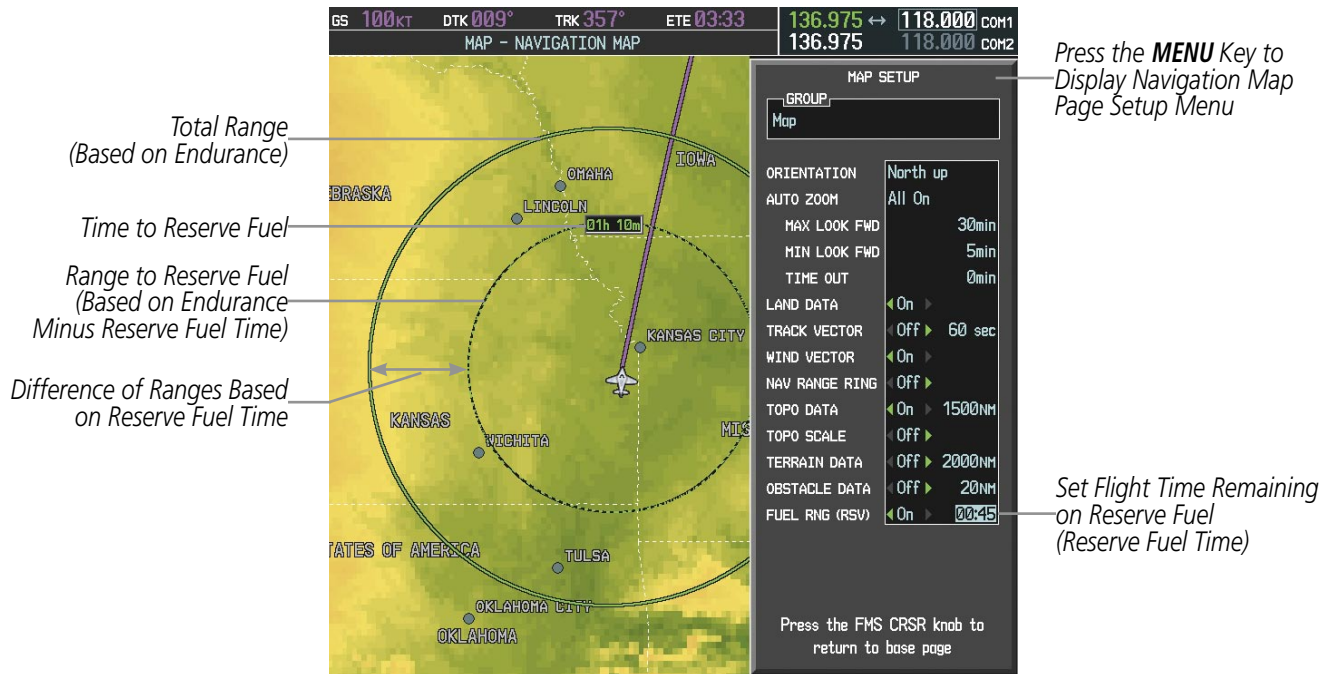

Figure 3-6 Fuel Calculations Group

A map feature related to the EIS Fuel Calculations is the Fuel Range Ring, which graphically illustrates the aircraft's remaining range based on the endurance (ENDUR), heading, groundspeed, and wind direction and speed. The solid green circle represents the range until all the remaining fuel is depleted. The dashed green circle indicates the aircraft range until only reserve fuel remains. Once on reserve fuel, the range is indicated by a solid yellow circle.

The Fuel Range Ring shifts position in relation to the aircraft according to wind effects. For example, more fuel is required for flying into a headwind, and the aircraft's decreased range in that direction is indicated by the Fuel Range Ring shifting toward the tail of the Aircraft Symbol.

The amount of reserve fuel (only for purposes of the Fuel Range Ring) is set on the Navigation Map Page Setup Menu in terms of remaining flight time. When enabled the Fuel Range Ring appears on the Navigation Map Page, the Weather Data Link Page, and PFD Inset Map.



**Figure 3-7 Fuel Range Ring and Setup**

**Enabling/disabling the Fuel Range Ring and selecting a reserve fuel time:**

- 1) Display the Navigation Map Page (press and hold the **CLR** Key for 2 seconds to quickly select this map).
- 2) Press the **MENU** Key.
- 3) Highlight 'Map Setup' and press the **ENT** Key. The Map Setup Menu is displayed.
- 4) Use the small **FMS** Knob to select the 'Map' group and press the **ENT** Key.
- 5) Highlight the 'FUEL RNG (RSV)' field.
- 6) Turn the small **FMS** Knob to select 'On' or 'Off'.
- 7) Turn the large **FMS** Knob to highlight the reserve fuel time, how long the aircraft can fly after reaching the reserve fuel.
- 8) Enter the desired reserve fuel time (00:00 to 23:59; hours:minutes) and press the **ENT** Key.
- 9) Press the **FMS** Knob to return to the Navigation Map Page.

### 3.3 LEANING ASSIST MODE



**NOTE:** The pilot should follow the engine manufacturer's recommended leaning procedures in the Aircraft Flight Manual Supplement (AFMS).

A leaning assist function is available on the Engine Page to assist in the leaning process.

#### Accessing Leaning Assist Mode:

- 1) Press the **ENGINE** Softkey to open the Engine Page.
- 2) Press the **LEAN** Softkey to identify peaks.
- 3) Press the **LEAN** Softkey again to exit Leaning Assist Mode.

When the **LEAN** Softkey is pressed, the system initially highlights the number and EGT readout of the cylinder with the hottest EGT. The  $\Delta$  Peak temperature is the difference between the peak temperature and the present temperature for the peaked cylinder. When the first peak is detected, "1st" is annunciated below that cylinder's EGT bar and the temperature is marked in light blue on the graph.

The system continues to detect peak EGTs for each cylinder lean of peak as the fuel flow is decreased, and the peak of each cylinder's EGT is indicated by a light blue marker on the graph. Once all cylinders are lean of peak, the last cylinder to peak is denoted by the "Last" annunciation below its bar on the graph.

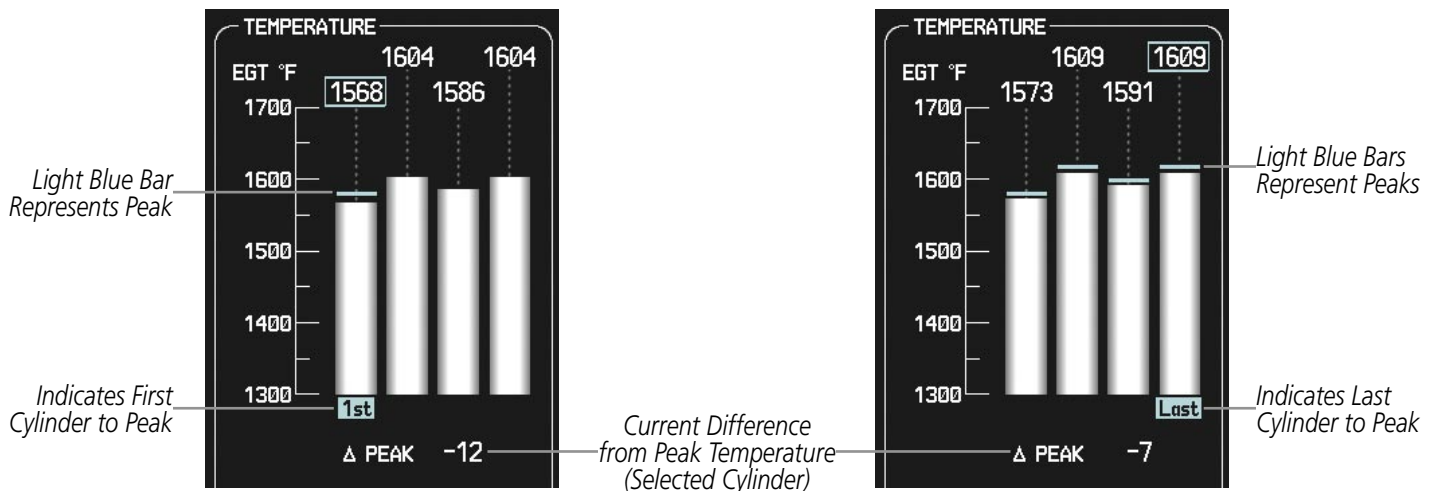

Figure 3-8 Leaning Assist Mode

### 3.4 EIS IN REVERSIONARY MODE

In reversionary display mode, the remaining display is re-configured to present PFD symbology together with the EIS Display (refer to the System Overview for information about display Reversionary Mode).



**Figure 3-9 Reversionary Mode (DA40)**

When the G1000 displays enter Reversionary Mode, the EIS is separated into three displays: Engine (identical to the normal EIS Display on the MFD), Lean, and System. For a description of the Engine Display, refer to Section 3.1. The Lean Display presents temperature information and assistance for engine leaning. The System Display shows various system parameters and fuel calculations. To return to the Engine Display from the Lean or System Display, press the **ENGINE** or **BACK** Softkey.

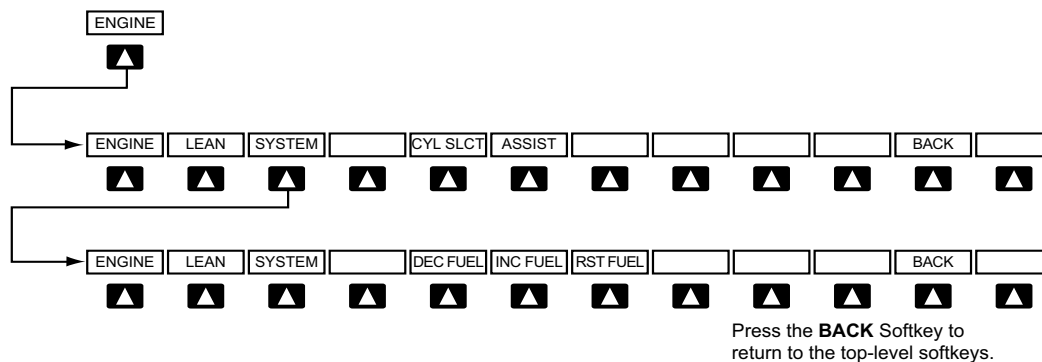

Figure 3-10 EIS Softkeys (Reversionary Mode)

- **ENGINE** Displays second-level engine softkeys
- **LEAN** Displays the EIS Lean Display
- **CYL SLCT** Cycles through the cylinders to obtain information about a particular cylinder, shown in light blue on the bar graphs
- **ASSIST** Accesses Leaning Assist Mode
- **SYSTEM** Displays the EIS System Display
- **DEC FUEL** Decreases displayed fuel remaining in 1-gal increments
- **INC FUEL** Increases displayed fuel remaining in 1-gal increments
- **RST FUEL** Resets displayed fuel remaining to maximum fuel capacity for aircraft and fuel used to zero

## LEAN DISPLAY



**NOTE:** The pilot should follow the engine manufacturer's recommended leaning procedures in the Aircraft Flight Manual Supplement (AFMS).

The EIS Lean Display provides information and a user interface to perform engine leaning while in Reversionary Mode. Exhaust gas (EGT) and head (CHT) temperatures for each cylinder are displayed in bar graph form with a readout for the temperature of the selected cylinder shown below each graph.

### Accessing the EIS Lean Display:

- 1) Press the **ENGINE** Softkey.
- 2) Press the **LEAN** Softkey.
- 3) To return to the default Engine Display, press the **ENGINE** or **BACK** Softkey.



- ① **Engine Manifold Pressure Gauge (MAN IN HG)** Displays manifold pressure in inches of Mercury (in Hg) to indicate engine power (*DA40 only*)
- ② **Tachometer (RPM)** Displays propeller speed in revolutions per minute (rpm); the red band indicates propeller overspeed
- ③ **Fuel Flow (FFLOW GPH)** Displays current fuel flow in gallons per hour (gph)
- ④ **Exhaust Gas Temperature Bar Graph (EGT °F)** Exhaust Gas Temperature (EGT) for each cylinder is represented as a bar; below the graph, the EGT readout is given for the selected cylinder (number highlighted in light blue)
- ⑤ **Cylinder Head Temperature Bar Graph (CHT °F)** Head temperature for each cylinder is represented as a bar; below the graph, the CHT readout is given for the selected cylinder (shown in light blue)

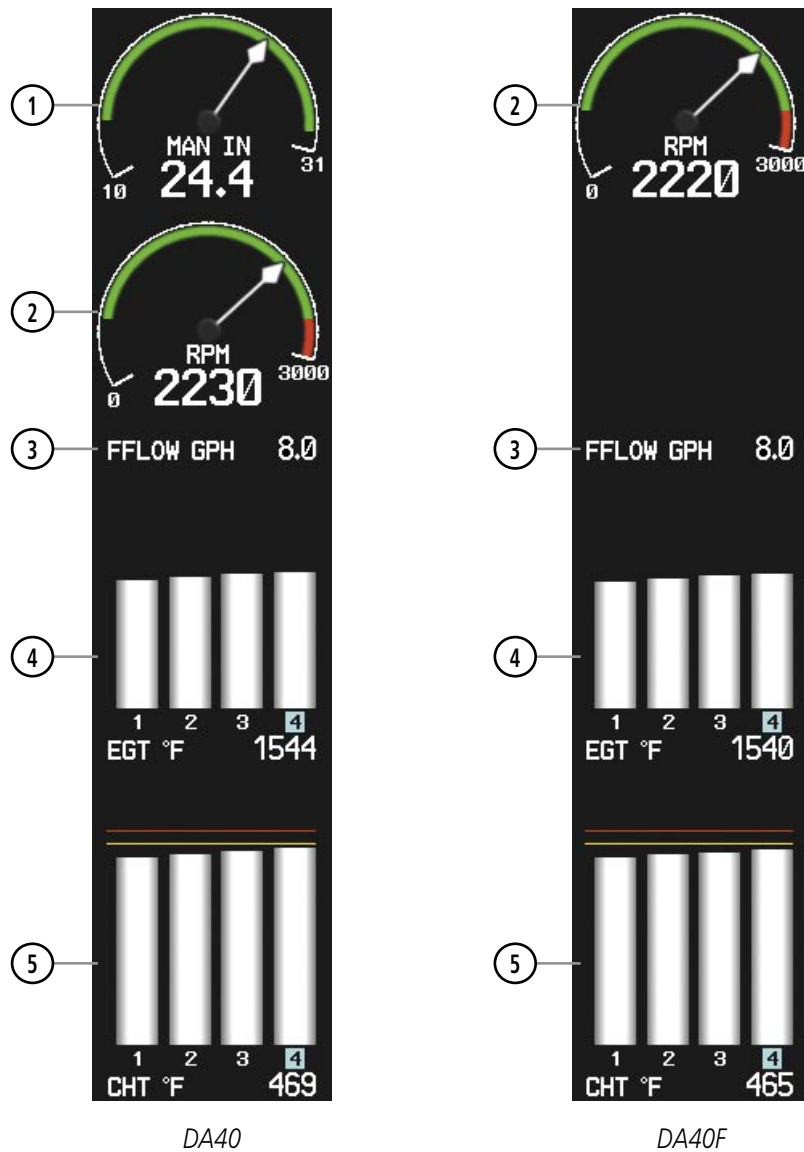

Figure 3-11 Lean Display

By default, the cylinder with the hottest temperature is selected (number highlighted in light blue) when the **LEAN** Softkey is pressed. Bars for cylinders with temperatures in the normal range are shown in white. On the CHT Bar Graph, caution and warning conditions are indicated in yellow and red, respectively.

Since only one cylinder's EGT and CHT are displayed at a time, this information can be cycled through for each cylinder using the **CYL SLCT** Softkey; the selected cylinder's number is highlighted in light blue on the bar graphs. This softkey is disabled when Leaning Assist Mode is selected.

### Monitoring the desired cylinder's temperatures:

From the Lean Display, press the **CYL SLCT** Softkey to cycle through each cylinder and view its temperature information. The selected cylinder number is highlighted in light blue.

While in Reversionary Mode, the leaning assist function is available when the **ASSIST** Softkey is pressed from the Lean Display to assist in the leaning process (refer to the section on Leaning Assist Mode for more information).

## SYSTEM DISPLAY



**NOTE:** Refer to the Aircraft Flight Manual Supplement (AFMS) for limitations.

The EIS System Display shows the dial gauges, various system parameters, and fuel calculations while in Reversionary Mode.

### Accessing the EIS System Display:

- 1) Press the **ENGINE** Softkey.
- 2) Press the **SYSTEM** Softkey.
- 3) To return to the default Engine Display, press the **ENGINE** or **BACK** Softkey.

Fuel calculations are based on the displayed fuel remaining (GAL REM) and the fuel flow totalizer.

### Adjusting the fuel totalizer quantity:

From the System Display, press the **DEC FUEL** or **INC FUEL** Softkey to adjust the fuel remaining (GAL REM).

### Resetting the fuel totalizer:

From the System Display, press the **RST FUEL** Softkey. This also resets the fuel remaining (GAL REM) to zero.

- |   |  |  |
|---|--|--|
| ① | <b>Engine Manifold Pressure Gauge (MAN IN HG)</b>          | Displays manifold pressure in inches of Mercury (in Hg) to indicate engine power ( <i>DA40 only</i> )    |
| ② | <b>Tachometer (RPM)</b>                                    | Displays propeller speed in revolutions per minute (rpm); the red band indicates propeller overspeed     |
| ③ | <b>Oil Temperature (OIL °F) and Oil Pressure (OIL PSI)</b> | Display engine oil temperature (in degrees Fahrenheit, °F) and pressure (in pounds per square inch, psi) |
| ④ | <b>Voltmeter (VOLTS) and Ammeter (AMPS)</b>                | Display the primary bus voltage and the alternator load in amperes                                       |
| ⑤ | <b>Fuel Flow (FFLOW GPH)</b>                               | Displays current fuel flow in gallons per hour (gph)   |

- ⑥ **Fuel Pressure (FPRESS PSI)** Displays the fuel pressure in pounds per square inch (psi) (*DA40 only option*)
- ⑦ **Set Fuel Remaining (GAL REM)** Displays current fuel remaining in gallons as set by the pilot and adjusted for fuel burn since last set
- ⑧ **Calculated Fuel Used (GAL USED)** Displays calculated quantity of fuel used in gallons
- ⑨ **Calculated Endurance (ENDUR)** Displays calculated flight time remaining with fuel onboard (HH:MM when more than an hour remains)
- ⑩ **Calculated Range (RANGE NM)** Displays calculated aircraft range in nautical miles
- ⑪ **Total Time in Service (TTL TIME IN SVC)** Displays the total flight hours and is activated when the aircraft becomes airborne (note that time airborne does not necessarily correspond to tachometer time)

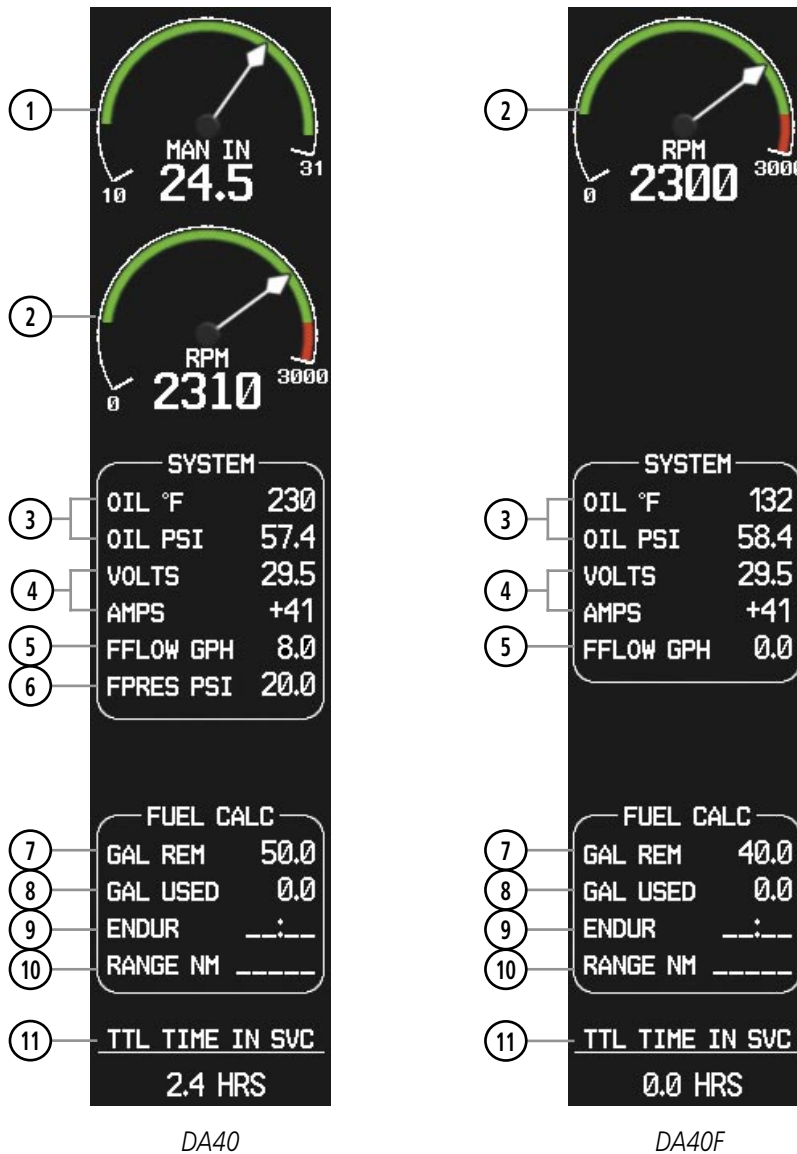

Figure 3-12 System Display

**BLANK PAGE**

## SECTION 4 AUDIO PANEL AND CNS

### 4.1 OVERVIEW

The Communication/Navigation/Surveillance (CNS) system includes the Audio Panel, communication radios, navigation radios, and Mode S transponder. The System Overview Section provides a block diagram description of the Audio Panel and CNS system interconnection.

CNS operation in Diamond DA40/40F aircraft is performed by the following Line Replaceable Units (LRUs):

- GDU 1040 Primary Flight Display (PFD)
- GMA 1347 Audio Panel
- GDU 1040/1042 Multi Function Display (MFD)
- GTX 33 Mode S Transponder
- GIA 63W Integrated Avionics Units (2)

The PFD/MFD controls are used to tune the communication transceivers and navigation radios.

The Audio Panel provides the traditional audio selector functions of microphone and receiver audio selection. The Audio Panel includes an intercom system (ICS) between the pilot, copilot, and passengers, a marker beacon receiver, and a COM clearance recorder. Ambient noise from the aircraft radios is reduced by a feature called Master Avionics Squelch (MASQ). When no audio is detected, MASQ processing further reduces the amount of background noise from the radios.

The Mode S transponder is controlled with softkeys and the **FMS** Knob located on the Primary Flight Display (PFD). The Transponder Data Box is located to the left of the System Time Box. The data box displays the active four-digit code, mode, and reply status (Figure 4-1).

PFD/MFD CONTROLS AND FREQUENCY DISPLAY



Figure 4-1 PFD/MFD Controls, COM/NAV Frequency Tuning Boxes, and ADF/DME Tuning Window (PFD Shown)

- ① **NAV VOL/ID Knob** – Controls NAV audio volume level. Press to turn the Morse code identifier audio on and off. Volume level is shown in the NAV frequency field as a percentage.
- ② **NAV Frequency Transfer Key** – Transfers the standby and active NAV frequencies.
- ③ **NAV Knob** – Tunes the standby frequencies for the NAV receiver (large knob for MHz; small knob for kHz). Press to move the tuning box (light blue box) and Frequency Transfer Arrow between NAV1 and NAV2.
- ④ **NAV Frequency Box** – Displays NAV standby and active frequency fields, volume, and station ID. The frequency of the NAV radio selected for navigation is displayed in green.
- ⑤ **COM Frequency Box** – Displays COM standby and active frequency fields and volume. The selected COM transceiver frequency is displayed in green.
- ⑥ **COM Knob** – Tunes the standby frequencies for the COM transceiver (large knob for MHz; small knob for kHz). Press to move the tuning box (light blue box) and Frequency Transfer Arrow between COM1 and COM2.
- ⑦ **COM Frequency Transfer Key** – Transfers the standby and active COM frequencies. Press and hold this key for two seconds to tune the emergency frequency (121.500 MHz) automatically into the active frequency field.
- ⑧ **COM VOL/SQ Knob** – Controls COM audio volume level. Press to turn the COM automatic squelch on and off. Volume level is shown in the COM frequency field as a percentage.
- ⑨ **ADF/DME Tuning Window** – Displays ADF frequencies, volume setting, and modes, and DME tuning selection. Display by pressing **ADF/DME** Softkey.
- ⑩ **ENT Key** – Validates or confirms an ADF frequency or ADF/DME mode and Auto-tune selection.
- ⑪ **FMS Knob** – Flight Management System Knob, used to enter transponder codes, enter ADF frequencies select ADF/DME modes and Auto-tune entries when ADF/DME Tuning Window or NRST Window is present. Press the **FMS** Knob to turn the selection cursor on and off. The large knob moves the cursor in the window. The small knob selects individual characters for the highlighted cursor location.
- ⑫ **Transponder Data Box** – Indicates the selected transponder code, operating mode, reply, and ident status for the transponder.

## AUDIO PANEL CONTROLS

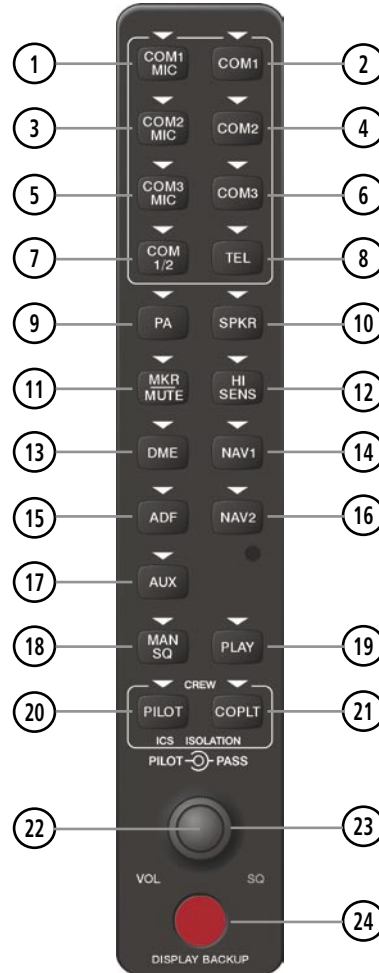

Figure 4-2 Audio Panel Controls (GMA 1347)



**NOTE:** When a key is selected, a triangular annunciator above the key is illuminated.

- ① **COM1 MIC** – Selects the #1 transmitter for transmitting. COM1 receive is simultaneously selected when this key is pressed allowing received audio from the #1 COM receiver to be heard. COM2 receive can be added by pressing the **COM2** Key.
- ② **COM1** – When selected, audio from the #1 COM receiver can be heard.
- ③ **COM2 MIC** – Selects the #2 transmitter for transmitting. COM2 receive is simultaneously selected when this key is pressed allowing received audio from the #2 COM receiver to be heard. COM1 receive can be added by pressing the **COM1** Key.
- ④ **COM2** – When selected, audio from the #2 COM receiver can be heard.
- ⑤ **COM3 MIC** – Not used in DA40/40F aircraft.



- ⑥ **COM3** – Not used in DA40/40F aircraft.
- ⑦ **COM 1/2** – Not used in DA40/40F aircraft.
- ⑧ **TEL** – Not used in DA40/40F aircraft.
- ⑨ **PA** – Selects the passenger address system. The selected COM transmitter is deselected when the **PA** Key is pressed.
- ⑩ **SPKR** – Selects and deselects the cabin speaker. COM and NAV receiver audio can be heard on the speaker.
- ⑪ **MKR/MUTE** – Selects marker beacon receiver audio. Mutes the currently received marker beacon receiver audio. Unmutes automatically when new marker beacon audio is received. Also, stops play of recorded COM audio.
- ⑫ **HI SENS** – Press to increase marker beacon receiver sensitivity. Press again to return to low sensitivity.
- ⑬ **DME** – Turns optional DME audio on or off.
- ⑭ **NAV1** – When selected, audio from the #1 NAV receiver can be heard.
- ⑮ **ADF** – Turns optional ADF receiver audio on or off.
- ⑯ **NAV2** – When selected, audio from the #2 NAV receiver can be heard.
- ⑰ **AUX** – Not used in DA40/40F aircraft.
- ⑱ **MAN SQ** – Enables manual squelch for the intercom. When the intercom is active, press the **PILOT** Knob to illuminate SQ. Turn the **PILOT/PASS** Knobs to adjust squelch.
- ⑲ **PLAY** – Press once to play the last recorded COM audio. Press again while audio is playing and the previous block of recorded audio will be played. Each subsequent press plays each previously recorded block. Pressing the **MKR/MUTE** Key during play of a memory block stops play.
- ⑳ **PILOT** – Selects and deselects the pilot intercom isolation.
- ㉑ **COPLT** – Selects and deselects the copilot intercom isolation.
- ㉒ **PILOT Knob** – Press to switch between volume and squelch control as indicated by illumination of VOL or SQ. Turn to adjust intercom volume or squelch. The **MAN SQ** Key must be selected to allow squelch adjustment.
- ㉓ **PASS Knob** – Turn to adjust Copilot/Passenger intercom volume or squelch. The **MAN SQ** Key must be selected to allow squelch adjustment.
- ㉔ **DISPLAY BACKUP Button** – Manually selects Reversionary Mode.

## 4.2 COM OPERATION

### COM TRANSCIVER SELECTION AND ACTIVATION

- NOTE:** During PA Mode, the COM MIC Annunciator is extinguished and the COM active frequency color changes to white, indicating that neither COM transmitter is active.
- NOTE:** When turning on the G1000 for use, the system remembers the last frequencies used and the active COM transceiver state prior to shutdown.

The COM Frequency Box is composed of four fields; the two active frequencies are on the left side and the two standby frequencies are on the right. The COM transceiver is selected for transmitting by pressing the **COM MIC** Keys on the Audio Panel. During reception of audio from the COM radio selected for transmission, audio from the other COM radio is muted.

An active COM frequency displayed in green indicates that the COM transceiver is selected on the Audio Panel (**COM1 MIC** or **COM2 MIC** Key). Both active COM frequencies appearing in white indicate that no COM radio is selected for transmitting (**PA** Key is selected on the Audio Panel).

Frequencies in the standby field are displayed in either white or gray. The standby frequency in the tuning box is white. The other standby frequency is gray.

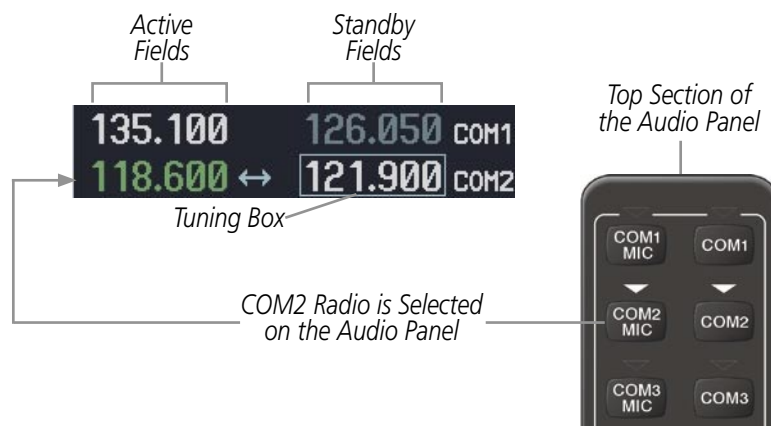
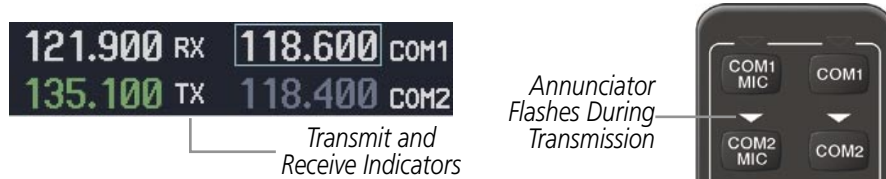

Figure 4-3 Selecting a COM Radio for Transmit

**TRANSMIT/RECEIVE INDICATIONS**

During COM transmission, a white TX appears by the active COM frequency replacing the Frequency Transfer Arrow. On the Audio Panel, when the active COM is transmitting, the active transceiver **COM MIC** Key Annunciator flashes approximately once per second.

During COM signal reception, a white RX appears by the active COM frequency replacing the Frequency Transfer Arrow.



**Figure 4-4** COM Radio Transmit and Receive Indications

**COM TRANSCEIVER MANUAL TUNING**

The COM frequency controls and frequency boxes are on the right side of the PFD and MFD.

**Manually tuning a COM frequency:**

- 1) Turn the **COM** Knob to tune the desired frequency in the COM Tuning Box (large knob for MHz; small knob for kHz).
- 2) Press the **Frequency Transfer** Key to transfer the frequency to the active field.
- 3) Adjust the volume level with the COM **VOL/SQ** Knob.
- 4) Press the COM **VOL/SQ** Knob to turn automatic squelch on and off.



**Figure 4-5** COM Frequency Tuning

### SELECTING THE RADIO TO BE TUNED

Press the small **COM** Knob to transfer the frequency tuning box and Frequency Transfer Arrow between the upper and lower radio frequency fields.



Figure 4-6 Switching COM Tuning Boxes

### QUICK-TUNING AND ACTIVATING 121.500 MHZ

Pressing and holding the COM **Frequency Transfer** Key for two seconds automatically loads the emergency COM frequency (121.500 MHz) in the active field of the COM radio selected for tuning (the one with the transfer arrow). In the example shown, pressing the Audio Panel **COM2 MIC** Key activates the transceiver.



Figure 4-7 Quickly Tuning 121.500 MHz

## AUTO-TUNING THE COM FREQUENCY

COM frequencies can be automatically tuned from the following:

- Nearest Airports Window (PFD)
- WPT – Airport Information Page
- NRST – Nearest Airports Page
- NRST – Nearest (ARTCC, FSS, WX) Frequencies Page
- NRST – Nearest Airspaces Page

### AUTO-TUNING FROM THE PFD

COM frequencies for the nearest airports can be automatically tuned from the Nearest Airports Window on the PFD. When the desired frequency is entered, it becomes a standby frequency. Pressing the **Frequency Transfer** Key places this frequency into the COM Active Frequency Field.

#### Auto-tuning a COM frequency for a nearby airport from the PFD:

- 1) Press the **NRST** Softkey on the PFD to open the Nearest Airports Window. A list of 25 nearest airport identifiers and COM frequencies is displayed.
- 2) Turn the **FMS** Knob to scroll through the list and highlight the desired COM frequency.
- 3) Press the **ENT** Key to load the COM frequency into the COM Standby Tuning Box.
- 4) Press the **Frequency Transfer** Key to transfer the frequency to the COM Active Frequency Field.



Press the **NRST** Softkey to Open the Nearest Airports Window

Figure 4-8 Nearest Airports Window (PFD)

### AUTO-TUNING FROM THE MFD

Frequencies can be automatically loaded into the COM Frequency Box from pages in the NRST or WPT page group by highlighting the frequency and pressing the **ENT** Key (Figures 4-9, 4-10, and 4-11).

#### Auto-tuning a COM frequency from the WPT and NRST Pages:

- 1) From any page that the COM frequency can be auto-tuned, activate the cursor by pressing the **FMS** Knob or the appropriate softkey.
- 2) Turn the **FMS** Knob to place the cursor on the desired COM frequency (Figure 4-11).
- 3) Press the **ENT** Key to load the COM frequency into the standby field of the selected COM radio.
- 4) Press the **Frequency Transfer** Key to transfer the frequency to the COM Active Frequency Field.

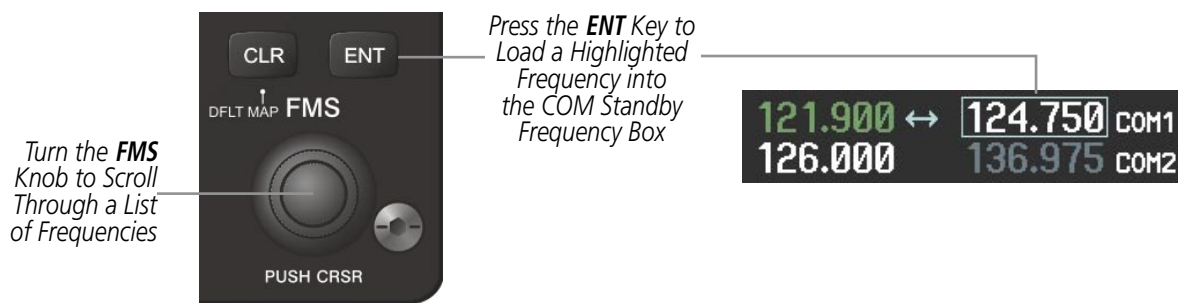

Figure 4-9 Frequency Auto-Tuning from the MFD

OR:

- 5) Press the **MENU** Key to display the page menu (Figure 4-10).
- 6) Turn the large **FMS** Knob to scroll through the menu options.
- 7) Press the **ENT** Key to place the cursor on the desired selection.
- 8) Scroll through the frequency selections with the **FMS** Knob or the **ENT** Key.
- 9) Press the **ENT** Key to load the COM frequency into the standby field of the selected COM radio.
- 10) Press the **Frequency Transfer** Key to transfer the frequency to the COM Active Frequency Field.

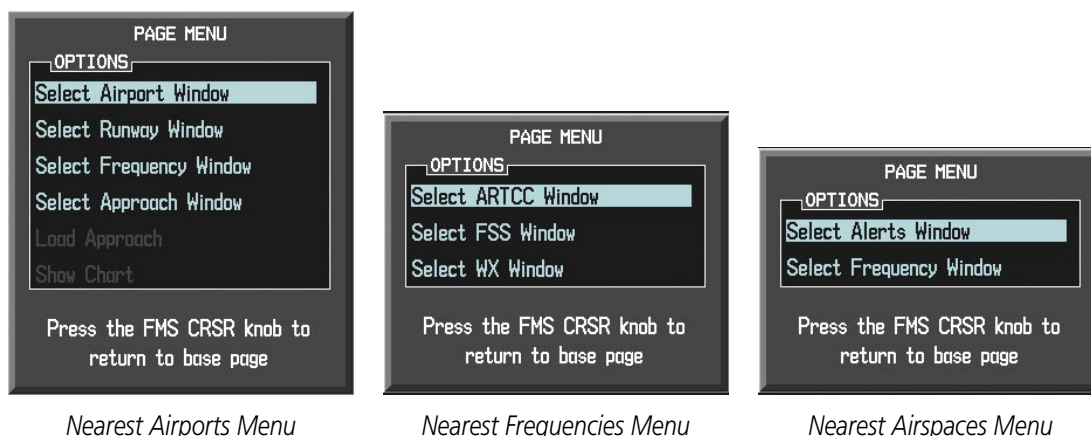
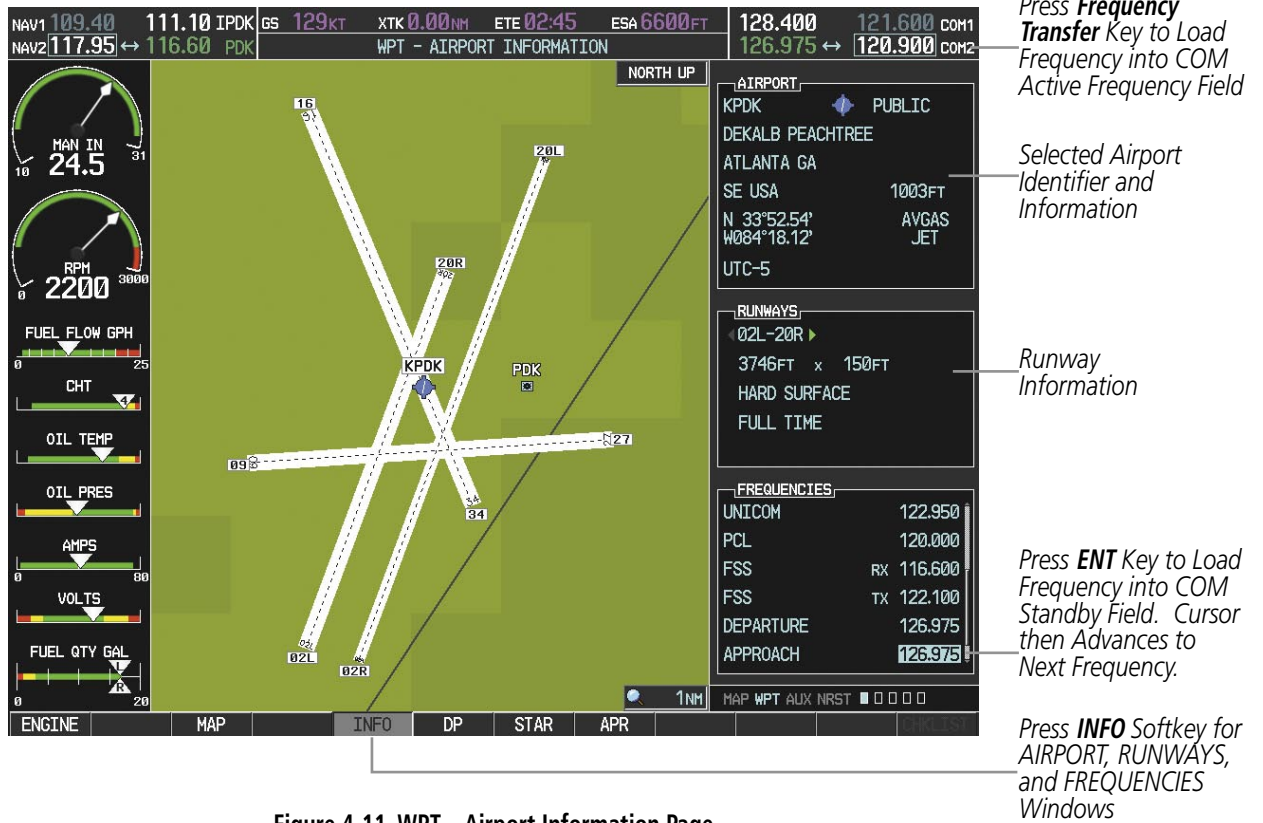

Figure 4-10 Nearest Pages Menus

On the WPT - Airport Information Page, the cursor can be placed on the frequency field by pressing the **FMS** Knob and scrolling through the list. The frequency is transferred to the COM Standby Field with the **ENT** Key.



**Figure 4-11 WPT – Airport Information Page**

COM frequencies can also be auto-tuned from the NRST – Nearest Airspaces, NRST – Nearest Frequencies, and NRST – Nearest Airports Pages on the MFD in a similar manner using the appropriate softkeys or **MENU** Key, the **FMS** Knob, and the **ENT** Key.



Figure 4-12 NRST – Nearest Airspaces, NRST – Nearest Airports, and NRST – Nearest Frequencies Pages



**FREQUENCY SPACING**

The G1000 COM radios can tune either 25-kHz spacing (118.000 to 136.975 MHz) or 8.33-kHz spacing (118.000 to 136.990 MHz) for 760-channel or 3040-channel configuration. When 8.33-kHz channel spacing is selected, all of the 25-kHz channel spacing frequencies are also available in the complete 3040-channel list.

COM channel spacing is set on the System Setup Page of the AUX Page Group.



Figure 4-13 COM Channel Spacing

**Changing COM frequency channel spacing:**

- 1) Select the AUX – System Setup Page.
- 2) Press the **FMS** Knob to activate the flashing cursor.
- 3) Turn the large **FMS** Knob to highlight the Channel Spacing Field in the COM Configuration Box.
- 4) Turn the small **FMS** Knob to select the desired channel spacing.
- 5) Press the **ENT** Key to complete the channel spacing selection.

While the COM CONFIG Window is selected, the G1000 softkeys are blank.



Figure 4-14 AUX – System Setup Page

## AUTOMATIC SQUELCH

Automatic Squelch quiets unwanted static noise when no audio signal is received, while still providing good sensitivity to weak COM signals. To disable Automatic Squelch, press the **VOL/SQ** Knob. When Automatic Squelch is disabled, COM audio reception is always on. Continuous static noise is heard over the headsets and speaker, if selected. Pressing the **VOL/SQ** Knob again enables Automatic Squelch.

When Automatic Squelch is disabled, a white SQ appears next to the COM frequency.



Figure 4-15 Overriding Automatic Squelch

## VOLUME

COM radio volume level can be adjusted from 0 to 100% using the **VOL/SQ** Knob. Turning the knob clockwise increases volume, turning the knob counterclockwise decreases volume. When adjusting volume, the level is displayed in place of the standby frequencies. Volume level indication remains for two seconds after the change.



Figure 4-16 COM Volume Level

## 4.3 NAV OPERATION

### NAV RADIO SELECTION AND ACTIVATION

The NAV Frequency Box is composed of four fields; two standby fields and two active fields. The active frequencies are on the right side and the standby frequencies are on the left.

A NAV radio is selected for navigation by pressing the **CDI** Softkey located on the PFD. The active NAV frequency selected for navigation is displayed in green. Pressing the **CDI** Softkey once selects NAV1 as the navigation radio. Pressing the **CDI** Softkey twice selects NAV2 as the navigation radio. Pressing the **CDI** Softkey a third time activates GPS mode. Pressing the **CDI** Softkey again cycles back to NAV1.

While cycling through the **CDI** Softkey selections, the NAV Tuning Box and the Frequency Transfer Arrow are placed in the active NAV Frequency Field and the active NAV frequency color changes to green.

The three navigation modes that can be cycled through are:

- VOR1 (or LOC1) – If NAV1 is selected, a green single line arrow (not shown) labeled either VOR1 or LOC1 is displayed on the HSI and the active NAV1 frequency is displayed in green.
- VOR2 (or LOC2) – If NAV2 is selected, a green double line arrow (shown) labeled either VOR2 or LOC2 is displayed on the HSI and the active NAV2 frequency is displayed in green.
- GPS – If GPS Mode is selected, a magenta single line arrow (not shown) appears on the HSI and neither NAV radio is selected. Both active NAV frequencies are then displayed in white.

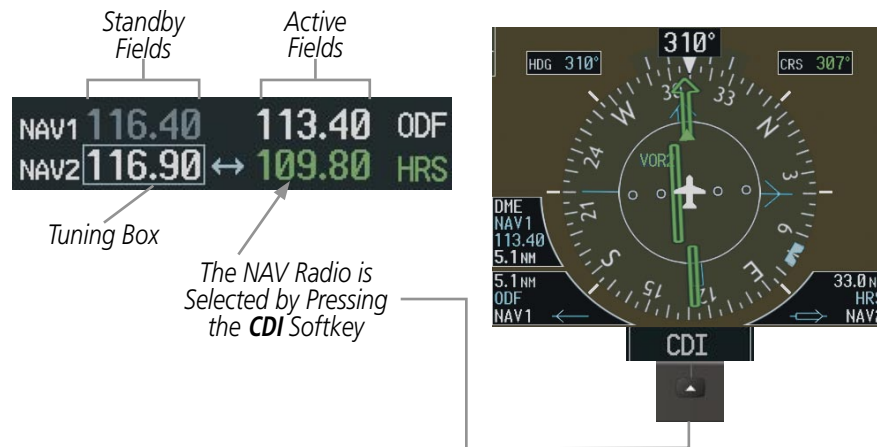

**Figure 4-17 Selecting a NAV Radio for Navigation**

See the Flight Instruments Section for selecting the DME and Bearing Information windows and using VOR or ADF as the source for the bearing pointer.

NAV radios are selected for listening by pressing the corresponding keys on the Audio Panel. Pressing the **NAV1**, **NAV2**, **ADF**, or **DME** Key selects and deselects the navigation radio source. Selected audio can be heard over the headset and the speaker (if selected). All radios can be selected individually or simultaneously.



Figure 4-18 Selecting a NAV Radio Receiver

### NAV RECEIVER MANUAL TUNING

The NAV frequency controls and frequency boxes are on the left side of the PFD and MFD.

#### Manually tuning a NAV frequency:

- 1) Turn the **NAV** Knob to tune the desired frequency in the NAV Tuning Box.
- 2) Press the **Frequency Transfer** Key to transfer the frequency to the NAV Active Frequency Field.
- 3) Adjust the volume level with the NAV **VOL/ID** Knob.
- 4) Press the NAV **VOL/ID** Knob to turn the Morse code identifier audio on and off.

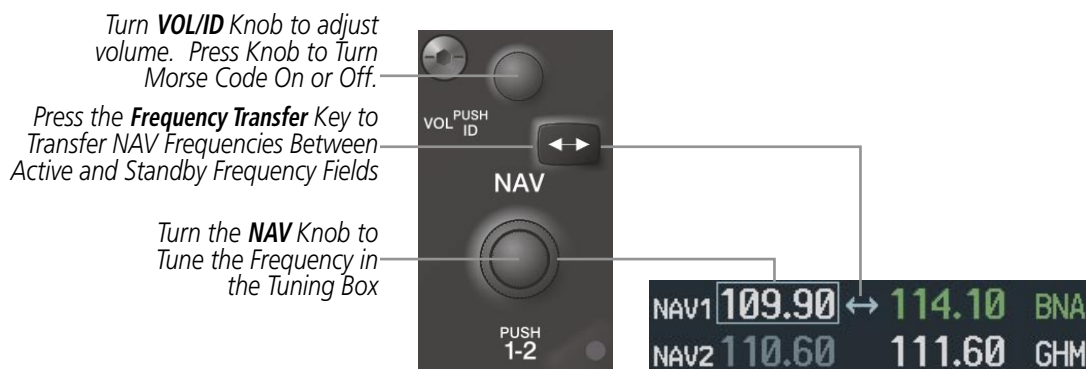

Figure 4-19 NAV Frequency Tuning

### SELECTING THE RADIO TO BE TUNED

Press the small **NAV** Knob to transfer the frequency tuning box and Frequency Transfer Arrow between the upper and lower radio frequency fields.



Figure 4-20 Switching NAV Tuning Boxes

### VOR/LOC ID

When the Morse code Identifier audio is on for a NAV radio, a white ID appears to the left of the active NAV frequency.

In the example shown, in order to listen to either station identifier, press the **NAV1** or **NAV2** Key on the Audio Panel. Pressing the **VOL/ID** Knob turns off the Morse code audio only in the radio with the NAV Tuning Box. To turn off both NAV IDs, transfer the NAV Tuning Box between NAV1 and NAV2 with the small **NAV** Knob and press the **VOL/ID** Knob again to turn the Morse code off in the other radio.



Figure 4-21 NAV Radio ID Indication

### VOLUME

NAV Radio volume level can be adjusted from 0 to 100% using the **VOL/ID** Knob. Turning the knob clockwise increases volume, counterclockwise decreases volume.

When adjusting, the level is displayed in place of the standby frequencies. Volume level indication remains for two seconds after the change.



Figure 4-22 NAV Volume Levels

## AUTO-TUNING THE NAV FREQUENCY

NAV frequencies can be selected and loaded from the following MFD pages:

- WPT – Airport Information
- WPT – VOR Information
- NRST – Nearest Airports
- NRST – Nearest VOR
- NRST – Nearest (WX, VOR) Frequencies
- NRST – Nearest Airspaces

The MFD provides auto-tuning of NAV frequencies from waypoint and nearest pages. During enroute navigation, the NAV frequency is entered automatically into the NAV standby frequency field. During approach activation the NAV frequency is entered automatically into the NAV active frequency field.

Frequencies can be automatically loaded into the NAV Frequency Boxes by highlighting the frequency and pressing the **ENT** Key (Figures 4-23, 4-24, and 4-25).

### Auto-tuning a NAV frequency:

- 1) From any page that the NAV frequency can be auto-tuned, activate the cursor by pressing the **FMS** Knob or the appropriate softkey.
- 2) Turn the **FMS** Knob to place the cursor on the desired NAV identifier.
- 3) Press the **FREQ** Softkey to place the cursor on the NAV frequency (Figure 4-25).
- 4) Press the **ENT** Key to load the NAV frequency into the standby field of the selected NAV radio.
- 5) Press the **Frequency Transfer** Key to transfer the frequency to the NAV Active Frequency Field.

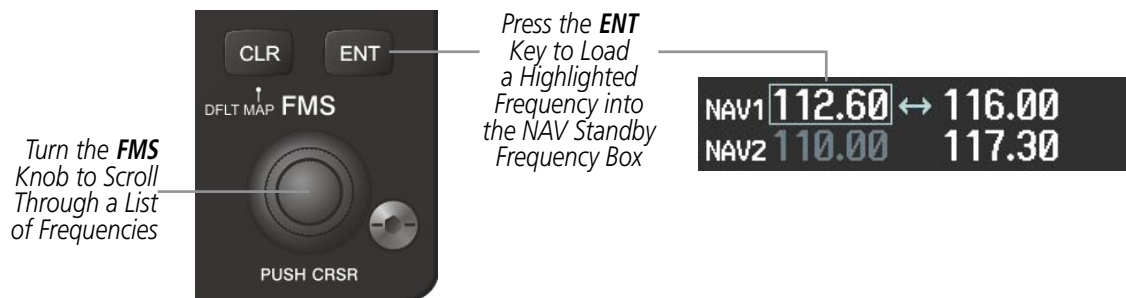
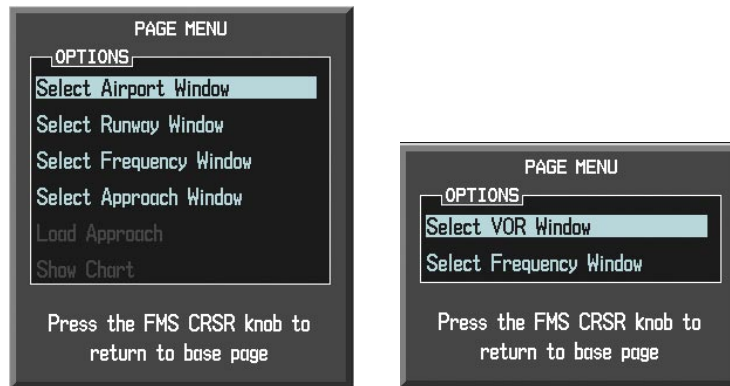

Figure 4-23 NAV Frequency Auto-Tuning from the MFD

**OR:**

- 6) Press the **MENU** Key to display the page menu (Figure 4-24).
- 7) Turn the large **FMS** Knob to scroll through the menu options.
- 8) Press the **ENT** Key to place the cursor in the desired window.
- 9) Scroll through the frequency selections with the **FMS** Knob or the **ENT** Key.
- 10) Press the **ENT** Key to load the NAV frequency into the standby field of the selected NAV radio.
- 11) Press the **Frequency Transfer** Key to transfer the frequency to the NAV Active Frequency Field.



*Nearest Airports Menu*

*Nearest VOR Menu*

**Figure 4-24 Nearest Pages Menus**

In the example shown, the VOR list is selected with the **VOR** Softkey or from the page menu. The **FMS** Knob or **ENT** Key is used to scroll through the list. The cursor is placed on the frequency with the **FREQ** Softkey and loaded into the NAV Tuning Box with the **ENT** Key.



Press the **ENT** Key to Load the Frequency into the NAV Standby Field.

Press the **VOR** Softkey to Place the Cursor on the VOR Identifier

Press the **FREQ** Softkey to Place the Cursor on the VOR Frequency

Figure 4-25 Loading the NAV Frequency from the NRST – Nearest VOR Page



While enroute, NAV frequencies can also be auto-tuned from the NRST – Nearest Airports, WPT – Airport Information, WPT – VOR Information, and NRST – Nearest Frequencies Pages on the MFD in a similar manner using the appropriate softkeys or **MENU** Key, the **FMS** Knob, and the **ENT** Key.



Figure 4-26 NRST – Nearest Frequencies, WPT – VOR Information, WPT – Airport Information, and NRST – Nearest Airports Pages

## AUTO-TUNING NAV FREQUENCIES ON APPROACH ACTIVATION



---

**NOTE:** *The primary NAV frequency is auto-tuned upon loading a VOR or ILS/Localizer approach.*

---



---

**NOTE:** *When an ILS/LOC approach has been activated in GPS Mode, the system switches to NAV Mode as the final approach course is intercepted (within 15 nm of the FAF). See the GPS Navigation Section for details.*

---

NAV frequencies are automatically loaded into the NAV Frequency Box on approach activation.

When loading or activating a VOR or ILS/LOC approach, the approach frequency is automatically transferred to a NAV frequency field as follows:

- If the current CDI navigation source is GPS, the approach frequency is transferred to the NAV1 active frequency field. The frequency that was previously in the NAV1 active frequency field is transferred to standby.
- If the current CDI navigation source is GPS, and if the approach frequency is already loaded into the NAV1 standby frequency field, the standby frequency is transferred to active.
- If the current CDI navigation source is NAV1 or NAV2, the approach frequency is transferred to the standby frequency fields of the selected CDI NAV radio.

**MARKER BEACON RECEIVER**

**NOTE:** The marker beacon indicators operate independently of marker beacon audio and cannot be turned off.

The marker beacon receiver is used as part of the ILS. The marker beacon receiver is always on and detects any marker beacon signals within the reception range of the aircraft.

The receiver detects the three marker tones – outer, middle, and inner – and provides the marker beacon annunciations located to the left of the Altimeter on the PFD.

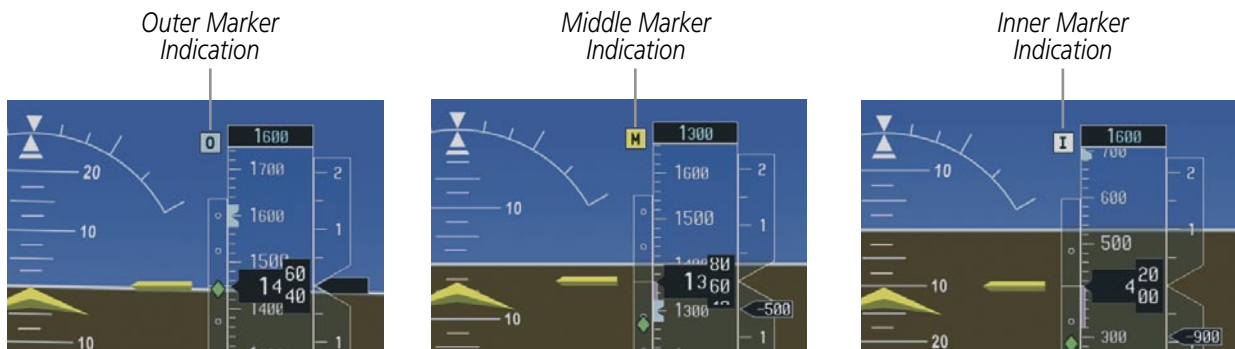

**Figure 4-27 Marker Beacon Annunciations on the PFD**



**Figure 4-28 Marker Beacon Keys**

The Audio Panel provides three different states of marker beacon operation; On, Muted, and Deselected. Pressing the **MKR/MUTE** Key selects and deselected marker beacon audio. The key annunciator indicates when marker beacon audio is selected.

During marker beacon audio reception, pressing the **MKR/MUTE** Key mutes the audio but does not affect the marker annunciations (Figure 4-27). The marker tone is silenced, then waits for the next marker tone. The **MKR/MUTE** Key Annunciator is illuminated, indicating audio muting. The audio returns when the next marker beacon signal is received. If the **MKR/MUTE** Key is pressed during signal reception (O, M, I indication) while marker beacon audio is muted, the audio is deselected and the **MKR/MUTE** Key Annunciator is extinguished.

Pressing the **HI SENS** Key switches between high and low marker beacon receiver sensitivity. The HI SENS function (annunciator illuminated) is used to provide an earlier indication when nearing a marker during an approach. The LO SENS function (annunciator extinguished) results in a narrower marker dwell while over a station.

## ADF/DME TUNING



**NOTE:** When another auxiliary window is turned on, the ADF/DME Tuning Window is replaced on the PFD.

See the Flight Instruments Section for displaying the DME and bearing information windows (ADF) and using the ADF as the source for the bearing pointer.

The G1000 system tunes the ADF receiver (optional) and DME transceiver (optional). The ADF is tuned by entering the frequency in the ADF standby frequency field of the ADF/DME Tuning Window. (The softkey may be labeled ADF/DME, ADF, or DME, depending on installed equipment.)

The UHF DME frequency is tuned by pairing with a VHF NAV frequency. DME frequency pairing is automatic and only the VHF NAV frequency is shown.

The following ADF/DME information is displayed in the ADF/DME Tuning Window:

- Active and standby ADF frequencies
- ADF receiver mode
- ADF receiver volume
- DME tuning mode (DME transceiver pairing)

When the ADF/DME Tuning Window is displayed, the selection cursor is placed over the standby ADF frequency field.

Turning the large **FMS** Knob moves the selection cursor through the various fields (standby ADF frequency, ADF receiver mode, ADF radio volume, and DME tuning mode). Pressing the **FMS** Knob activates/deactivates the selection cursor in the ADF/DME Tuning Window. The ADF frequency is entered using the **FMS** Knob and the **ENT** Key.

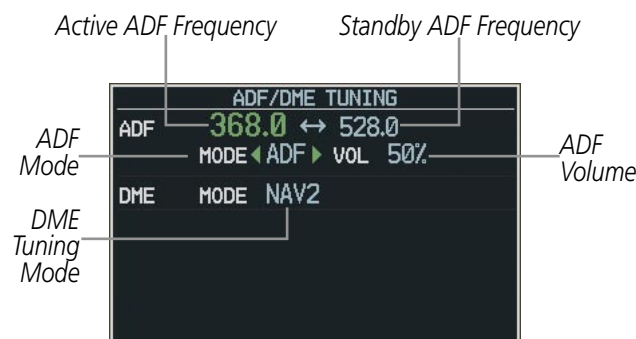

Figure 4-29 ADF/DME Tuning Window

**ADF TUNING**

ADF frequencies in the 190.0-kHz to 1799.5-kHz range are entered in the standby ADF frequency field of the ADF/DME Tuning Window. The G1000 System does not tune the ADF emergency frequency, 2182.0-kHz.

**Tuning an ADF frequency:**

- 1) Press the **ADF/DME** Softkey to display the ADF/DME Tuning Window.
- 2) Turn the large **FMS** Knob to place the selection cursor over the standby ADF frequency field.
- 3) Turn the small **FMS** Knob to begin data entry and change each digit.
- 4) Turn the large **FMS** Knob to move the cursor to the next digit position.
- 5) Press the **ENT** Key to complete data entry for the standby frequency.

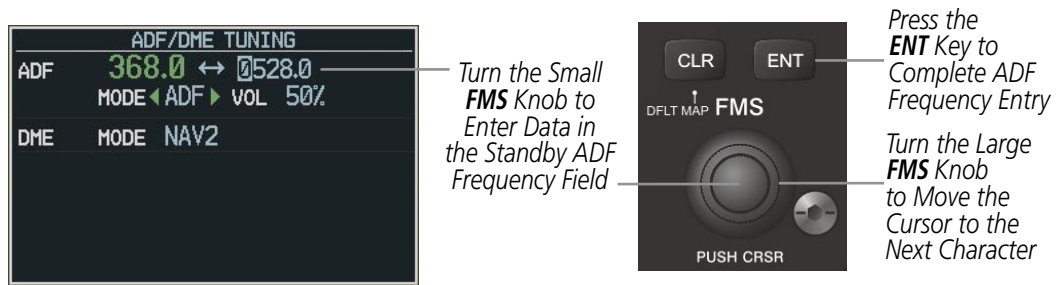

**Figure 4-30 Entering ADF Standby Frequencies**

Pressing the **CLR** Key before completing frequency entry cancels the frequency change and reverts back to the previously entered frequency.

Pressing the **CLR** Key when the cursor is flashing, clears the frequency and replaces the standby field with '0000.0'.

**Transferring the active and standby ADF frequencies:**

- 1) Turn the large **FMS** Knob to place the selection cursor over the standby ADF frequency field.
- 2) Press the **ENT** Key to complete the frequency transfer.



**Figure 4-31 Transferring ADF Frequencies**

### SELECTING ADF RECEIVER MODE

The following modes can be selected: (In all modes NDB audio can be heard by selecting the **ADF** Key on the Audio Panel.)

- ANT (Antenna) – The ADF bearing pointer parks on the HSI at 90 degrees. Best mode for listening to NDB audio.
- ADF (Automatic Direction Finder) – The ADF pointer points to the relative bearing of the NDB station.
- ADF/BFO (ADF/Beat Frequency Oscillator) – The ADF pointer points to the relative bearing of the NDB station and an audible tone confirms signal reception. This mode allows identification of the interrupted carrier beacon stations used in various parts of the world.
- ANT/BFO (Antenna/Beat Frequency Oscillator) – The ADF bearing pointer parks on the HSI at 90 degrees while an audible tone is provided when a signal is received. This mode also allows identification of the interrupted carrier beacon stations and confirms signal reception.

#### Selecting an ADF receiver mode:

- 1) Turn the large **FMS** Knob to place the selection cursor over the ADF mode field.
- 2) Turn the small **FMS** Knob to select the desired ADF receiver mode.



Figure 4-32 Selecting ADF Receiver Mode

ADF receiver volume level can be adjusted in the tuning window from 0 to 100%. The default volume level is set to 50%. The ADF volume level is the same for both Audio Panels.

#### Adjusting ADF receiver volume:

- 1) Turn the large **FMS** Knob to place the selection cursor over the ADF volume field.
- 2) Turn the small **FMS** Knob to adjust volume as desired.



Figure 4-33 Adjusting ADF Receiver Volume

## DME TUNING



**NOTE:** When turning on the G1000 for use, the system remembers the last frequency used for DME tuning and the NAV1, NAV2, or HOLD state prior to shutdown.

The DME transceiver is tuned by selecting NAV1, NAV2, or HOLD in the ADF/DME Tuning Window.



Figure 4-34 ADF/DME Tuning Window, DME Modes

The following DME transceiver pairing can be selected:

- NAV1 – Pairs the DME frequency from the selected NAV1 frequency.
- NAV2 – Pairs the DME frequency from the selected NAV2 frequency.
- HOLD – When in the HOLD position, the DME frequency remains paired with the last selected NAV frequency.

### Selecting DME transceiver pairing:

- 1) Press the **ADF/DME** Softkey to display the ADF/DME Tuning Window.
- 2) Turn the small **FMS** Knob to select the DME tuning mode.
- 3) Press the **ENT** Key to complete the selection.

Pressing the **CLR** Key or **FMS** Knob while in the process of DME pairing cancels the data entry and reverts back to the previously selected DME tuning state. Pressing the **FMS** Knob activates/deactivates the cursor in the ADF/DME Tuning Window.

## 4.4 GTX 33 MODE S TRANSPONDER

The GTX 33 Mode S Transponder provides Mode A, Mode C, and Mode S interrogation and reply capabilities. Selective addressing or Mode Select (Mode S) capability includes the following features:

- Level-2 reply data link capability (used to exchange information between aircraft and ATC facilities)
- Surveillance identifier capability
- Flight ID (Flight Identification) reporting – The Mode S Transponder reports aircraft identification as either the aircraft registration or a unique Flight ID.
- Altitude reporting
- Airborne status determination
- Transponder capability reporting
- Mode S Enhanced Surveillance (EHS) requirements
- Acquisition squitter – Acquisition squitter, or short squitter, is the transponder 24-bit identification address. The transmission is sent periodically, regardless of the presence of interrogations. The purpose of acquisition squitter is to enable Mode S ground stations and aircraft equipped with a Traffic Avoidance System (TAS) to recognize the presence of Mode S-equipped aircraft for selective interrogation.

The Hazard Avoidance Section provides more details on traffic avoidance systems.

### TRANSPONDER CONTROLS

Transponder function is displayed on three levels of softkeys on the PFD: Top-level, Mode Selection, and Code Selection. When the top-level **XPDR** Softkey is pressed, the Mode Selection softkeys appear: **STBY, ON, ALT, VFR, CODE, IDENT, BACK**.

When the **CODE** Softkey is pressed, the number softkeys appear: **0, 1, 2, 3, 4, 5, 6, 7, IDENT, BKSP, BACK**. The digits 8 and 9 are not used for code entry. Pressing the numbered softkeys in sequence enters the transponder code. If an error is made, pressing the **BKSP** Softkey moves the code selection cursor to the previous digit. Pressing the **BKSP** Softkey again moves the cursor to the next previous digit.

Pressing the **BACK** Softkey during code selection reverts to the Mode Selection Softkeys. Pressing the **BACK** Softkey during mode selection reverts to the top-level softkeys.

The code can also be entered with the **FMS** Knob. Code entry must be completed with either the softkeys or the **FMS** Knob, but not a combination of both.

Pressing the **IDENT** Softkey while in Mode or Code Selection initiates the ident function and reverts to the top-level softkeys.

After 45 seconds of transponder softkey inactivity, the system reverts back to the top-level softkeys.



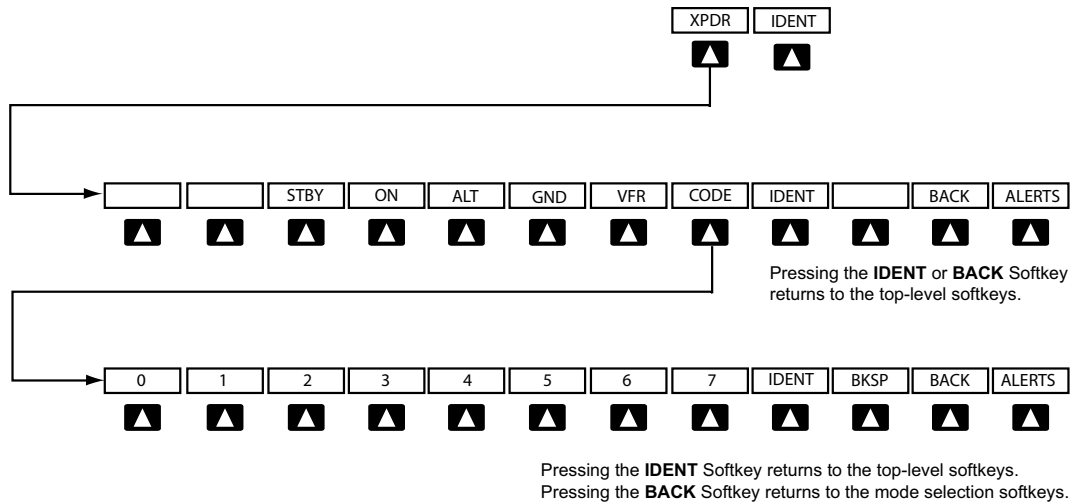

Figure 4-35 Transponder Softkeys (PFD)

## TRANSPONDER MODE SELECTION

Mode selection can be automatic (Ground and Altitude Modes) or manual (Standby, ON, and Altitude Modes). The **STBY**, **ON**, and **ALT** Softkeys can be accessed by pressing the **XPDR** Softkey.

### Selecting a transponder mode:

- 1) Press the **XPDR** Softkey to display the Transponder Mode Selection Softkeys.
- 2) Press the desired softkey to activate the transponder mode.

## GROUND MODE

Ground Mode is normally selected automatically when the aircraft is on the ground. The transponder powers up in the last mode it was in when shut down. Ground Mode can be overridden by pressing any one of the Mode Selection Softkeys. A green GND indication and transponder code appear in the mode field of the Transponder Data Box. In Ground Mode, the transponder does not allow Mode A and Mode C replies, but it does permit acquisition squitter and replies to discretely addressed Mode S interrogations.

When Standby Mode has been selected on the ground, the transponder can be returned to Ground Mode by pressing the **GND** Softkey.

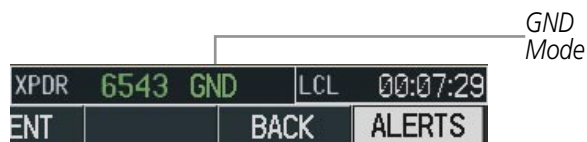

Figure 4-36 Ground Mode

## STANDBY MODE (MANUAL)

**NOTE:** In Standby Mode, the IDENT function is inoperative.

Standby Mode can be selected at any time by pressing the **STBY** Softkey. In Standby, the transponder does not reply to interrogations, but new codes can be entered. When Standby is selected, a white STBY indication and transponder code appear in the mode field of the Transponder Data Box. In all other modes, these fields appear in green.



Figure 4-37 Standby Mode

## MANUAL ON MODE

ON Mode can be selected at any time by pressing the **ON** Softkey. ON Mode generates Mode A and Mode S replies, but Mode C altitude reporting is inhibited. In ON Mode, a green ON indication and transponder code appear in the mode field of the Transponder Data Box.

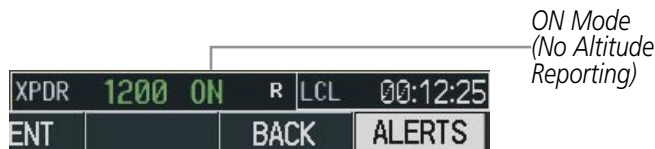

Figure 4-38 ON Mode

## ALTITUDE MODE (AUTOMATIC OR MANUAL)

Altitude Mode is automatically selected when the aircraft becomes airborne. Altitude Mode may also be selected manually by pressing the **ALT** Softkey.

If Altitude Mode is selected, a green ALT indication and transponder code appear in the mode field of the Transponder Data Box, and all transponder replies requesting altitude information are provided with pressure altitude information.



Figure 4-39 Altitude Mode

## REPLY STATUS

When the transponder sends replies to interrogations, a white R indication appears momentarily in the reply status field of the Transponder Data Box.



Figure 4-50 Reply Indication

## ENTERING A TRANSPONDER CODE

### Entering a transponder code with softkeys:

- 1) Press the **XPDR** Softkey to display the Transponder Mode Selection Softkeys.
- 2) Press the **CODE** Softkey to display the Transponder Code Selection Softkeys, for digit entry.
- 3) Press the digit softkeys to enter the code in the code field. When entering the code, the next softkey in sequence must be pressed within 10 seconds, or the entry is cancelled and restored to the previous code. Pressing the **BKSP** Softkey moves the code selection cursor to the previous digit. Five seconds after the fourth digit has been entered, the transponder code becomes active.

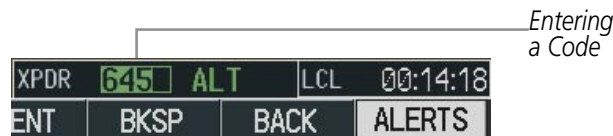

Figure 4-51 Entering a Code

**Entering a transponder code with the PFD FMS Knob:**

- 1) Press the **XPDR** and the **CODE** Softkeys as in the previous procedure to enable code entry.
- 2) Turn the small **FMS** Knob on the PFD to enter the first two code digits.
- 3) Turn the large **FMS** Knob to move the cursor to the next code field.
- 4) Enter the last two code digits with the small **FMS** Knob.
- 5) Press the **ENT** Key to complete code digit entry.

Pressing the **CLR** Key or small **FMS** Knob before code entry is complete cancels code entry and restores the previous code. Waiting for 10 seconds after code entry is finished activates the code automatically.

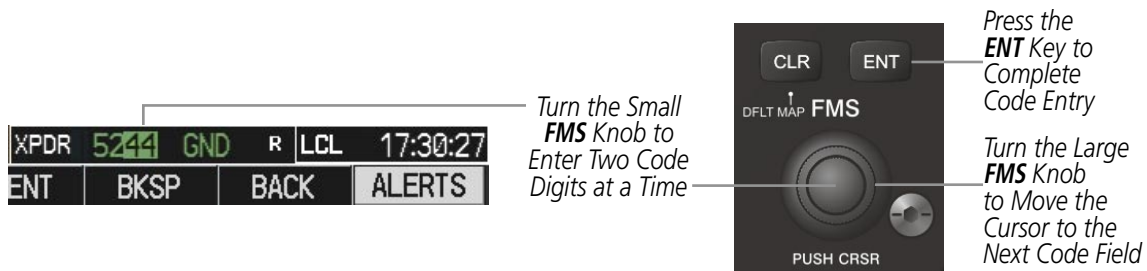

Figure 4-52 Entering a Code with the FMS Knob

**VFR CODE**

The VFR code can be entered either manually or by pressing the **XPDR** Softkey, then the **VFR** Softkey. When the **VFR** Softkey is pressed, the pre-programmed VFR code is automatically displayed in the code field of the Transponder Data Box. Pressing the **VFR** Softkey again restores the previous identification code.

The pre-programmed VFR Code is set at the factory to 1200. If a VFR code change is required, contact a Garmin-authorized service center for configuration.

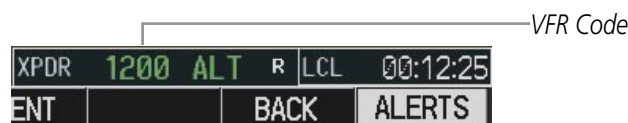

Figure 4-53 VFR Code

## IDENT FUNCTION

**NOTE:** In Standby Mode, the **IDENT** Softkey is inoperative.

Pressing the **IDENT** Softkey sends an ID indication to Air Traffic Control (ATC). The ID return distinguishes one transponder from all the others on the air traffic controller's radar screen. The **IDENT** Softkey appears on all levels of transponder softkeys. When the **IDENT** Softkey is pressed, a green IDNT indication is displayed in the mode field of the Transponder Data Box for a duration of 18 seconds.

After the **IDENT** Softkey is pressed while in Mode or Code Selection, the system reverts to the top-level softkeys.



Figure 4-54 IDENT Softkey and Indication

## FLIGHT ID REPORTING



**NOTE:** If the Flight ID is required but the system is not configured for it, contact a Garmin-authorized service center for configuration.

When the Flight ID must be entered before flight operation, the identifier is placed in the Timer/References Window on the PFD. The Flight ID is not to exceed seven characters. No space is needed when entering Flight ID. When a Flight ID contains a space, the system automatically removes it upon completion of Flight ID entry.

### Entering a Flight ID:

- 1) Press the **TMR/REF** Softkey to display the Timer/References Window.
- 2) Press the **FMS** Knob to activate the selection cursor, if not already activated.
- 3) Turn the large **FMS** Knob to scroll down to the Flight ID.
- 4) Turn the small **FMS** Knob to enter the desired Flight ID.
- 5) Press the **ENT** Key to complete Flight ID entry.

If an error is made during Flight ID entry, pressing the **CLR** Key returns to the original Flight ID entry. While entering a Flight ID, turning the **FMS** Knob counterclockwise moves the cursor back one space for each detent of rotation. If an incorrect Flight ID is discovered after the unit begins operation, reenter the correct Flight ID using the same procedure.



Figure 4-55 Timer/References Window, Entering Flight ID

## 4.5 ADDITIONAL AUDIO PANEL FUNCTIONS

### POWER-UP

---

The Audio Panel performs a self-test during power-up. During the self-test all Audio Panel annunciator lights illuminate for approximately two seconds. Once the self-test is completed, most of the settings are restored to those in use before the unit was last turned off.

### MONO/STEREO HEADSETS

---

Stereo headsets are recommended for use with the G1000.

Using a monaural headset in a stereo jack shorts the right headset channel output to ground. While this does not damage the Audio Panel, a person listening on a monaural headset hears only the left channel in both ears. If a monaural headset is used at one of the passenger positions, any other passenger using a stereo headset hears audio in the left ear only.

### SPEAKER

---

All of the radios can be heard over the cabin speaker. Pressing the **SPKR** Key selects and deselects the cabin speaker. Speaker audio is muted when the PTT is pressed. Certain aural alerts and warnings (autopilot, traffic, altitude) are always heard on the speaker, even when the speaker is not selected.

The speaker volume is adjustable within a nominal range. Contact a Garmin-authorized service center for volume adjustment.



Figure 4-56 Passenger Address and Speaker Keys

## INTERCOM

The Audio Panel includes a six-position intercom system (ICS) and two stereo music inputs for the pilot, copilot and up to four passengers. The intercom provides Pilot and Copilot isolation from the passengers and aircraft radios.



Figure 4-57 Intercom Controls

| PILOT KEY Annunciator | COPLT KEY Annunciator | Pilot Hears  | Copilot Hears  | Passenger Hears  |
|-----------------------|-----------------------|--|--|--|
| OFF                   | OFF                   | Selected radios, aural alerts, pilot, copilot, passengers, MUSIC 1 | Selected radios, aural alerts, pilot, copilot, passengers, MUSIC 1 | Selected radios, aural alerts, pilot, copilot, passengers, MUSIC 2 |
| ON                    | OFF                   | Selected radios, aural alerts, pilot                               | Copilot, passengers, MUSIC 1                                       | Copilot, passengers, MUSIC 2                                       |
| OFF                   | ON                    | Selected radios, aural alerts, pilot; passengers, MUSIC 1          | Copilot  | Selected radios, aural alerts, pilot, passengers, MUSIC 2          |
| ON                    | ON                    | Selected radios, aural alerts, pilot, copilot                      | Selected radios, aural alerts, pilot, copilot                      | Passengers; MUSIC 2  |

Table 4-1 ICS Isolation Modes

Pilot isolation is selected when the PILOT Annunciator is illuminated. During Pilot isolation, the pilot can hear the selected radios and aural alerts and warnings. The copilot and passengers can communicate with each other. The copilot is isolated from aural alerts and warnings.

Copilot isolation is selected when the COPLT Annunciator is illuminated. The copilot is isolated from the selected radios, aural alerts and warnings, and everyone else. The pilot and passengers can hear the selected radios and communicate with each other.

When both the PILOT and COPLT Annunciators are illuminated, the pilot and copilot can hear the selected radios and communicate with each other. The passengers are isolated from the pilot and copilot but can communicate with each other.

When both the PILOT and COPLT Annunciators are extinguished, everyone hears the selected radios and is able to communicate with everyone else.



## INTERCOM VOLUME AND SQUELCH

The **PILOT/PASS** Knob controls volume or manual squelch adjustment for the pilot and copilot/passenger. The small knob controls the pilot volume and squelch. The large knob controls the copilot/passenger volume and squelch. The VOL and SQ annunciations at the bottom of the unit indicate which function the knob is controlling. Pressing the **PILOT/PASS** Knob switches between volume and squelch control as indicated by the VOL or SQ annunciation being illuminated.

The **MAN SQ** Key allows either automatic or manual control of the squelch setting. When the MAN SQ Annunciator is extinguished (Automatic Squelch is on), the **PILOT/PASS** Knob controls only the volume (pressing the **PILOT/PASS** Knob has no effect on the VOL/SQ selection).

When the MAN SQ Annunciator is illuminated (Manual Squelch), the **PILOT/PASS** Knob controls both volume and squelch.

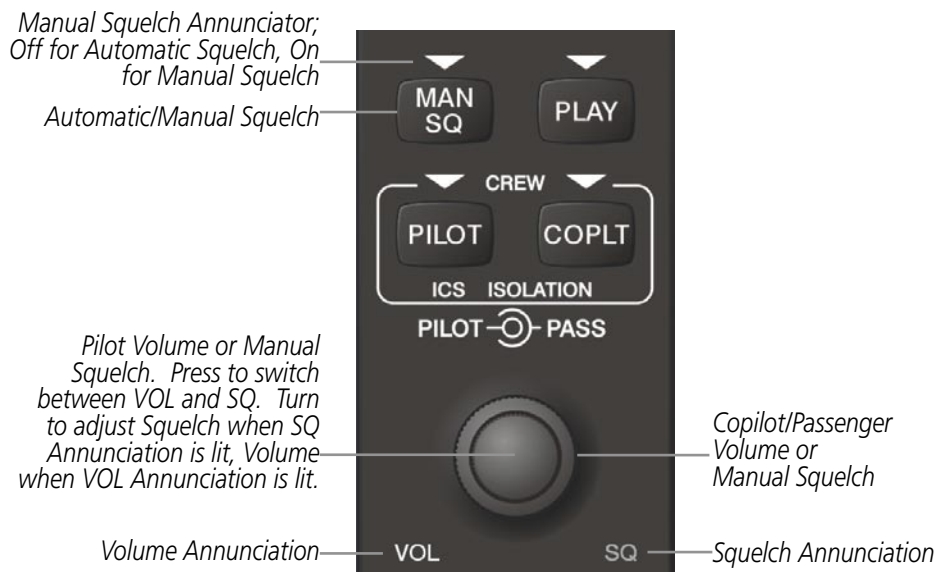

Figure 4-58 Volume/Squelch Control

## PASSENGER ADDRESS (PA) SYSTEM

A passenger address system is available for delivering voice messages over the cabin speaker. When the **PA** Key is selected on the Audio Panel, the COM MIC Annunciator is extinguished, and the active COM frequency changes to white, indicating that there is no COM selected. A Push-to-Talk (PTT) must be pressed to deliver PA announcements. The PA Annunciator flashes about once per second while the PTT is depressed.

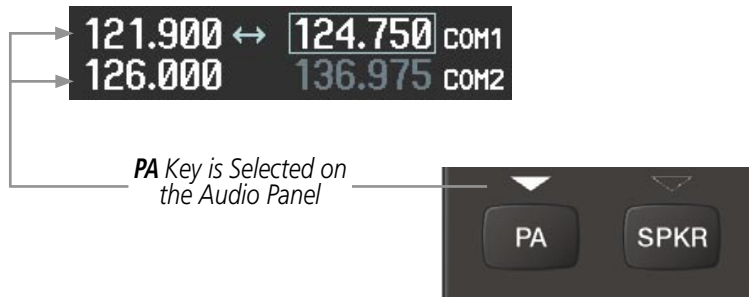

Figure 4-59 PA Key Selected for Cabin Announcements

## CLEARANCE RECORDER AND PLAYER

The Audio Panel contains a digital clearance recorder that records up to 2.5 minutes of the selected COM radio signal. Recorded COM audio is stored in separate memory blocks. Once 2.5 minutes of recording time have been reached, the recorder begins recording over the stored memory blocks, starting from the oldest block.

The **PLAY** Key controls the play function. Pressing the **PLAY** Key once plays the latest recorded memory block. The PLAY Annunciator flashes to indicate when play is in progress. The PLAY Annunciator turns off after the present memory block has finished playing.

Pressing the **MKR/MUTE** Key during play of a memory block stops play. If a COM input signal is detected during play of a recorded memory block, play is halted.

Pressing the **PLAY** Key while audio is playing begins playing the previously recorded memory block. Each subsequent press of the **PLAY** Key selects the previously recorded memory block.

Powering off the unit automatically clears all recorded blocks.

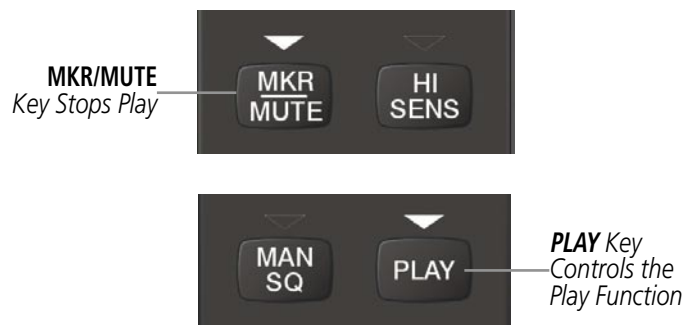

Figure 4-45 Marker Mute and Play Keys

## ENTERTAINMENT INPUTS

---



**NOTE:** *MUSIC 1 and MUSIC 2 inputs cannot be completely turned off. Audio level for MUSIC 1 and MUSIC 2 can be adjusted by a Garmin-authorized service center.*

---

The Audio Panel provides two stereo auxiliary entertainment inputs: MUSIC 1 and MUSIC 2. These inputs are compatible with popular portable entertainment devices such as MP3 and CD players. Two 3.5-mm stereo phone jacks are installed in convenient locations for audio connection. The headphone outputs of the entertainment devices are plugged into the MUSIC 1 or MUSIC 2 jacks.

The current ICS state of isolation affects the distribution of the entertainment input MUSIC 1 (see Table 4-1).

### MUSIC 1

MUSIC 1 can be heard by the pilot and copilot when both the PILOT and the COPLT Annunciators are extinguished. MUSIC 1 can also be heard by the pilot when the COPLT Annunciator is illuminated and by the copilot when the PILOT Annunciator is illuminated.

#### MUSIC 1 MUTING

MUSIC 1 muting occurs when aircraft radio or marker beacon activity is heard. MUSIC 1 is always soft muted when an interruption occurs from these sources. Soft muting is the gradual return of MUSIC 1 to its original volume level. The time required for MUSIC 1 volume to return to normal is between one-half and four seconds.

#### MUSIC 1 MUTING ENABLE/DISABLE

Pressing and holding the **MKR/MUTE** Key for three seconds switches MUSIC 1 muting on and off. When switching, either one or two beeps are heard; one beep indicates that music muting is enabled, two beeps indicate music muting is disabled. MUSIC 1 muting is reset (enabled) during power up.

### MUSIC 2

MUSIC 2 can be heard only by the passengers and is never muted.

### XM RADIO ENTERTAINMENT (OPTIONAL)

XM Radio audio from the Data Link Receiver may be heard by the pilot and passengers simultaneously (optional: requires subscription to XM Radio Service). Refer to the Additional Features Section for more details on the Data Link Receiver.

Connecting a stereo input to either MUSIC 1 or MUSIC 2 jacks removes the XM Radio Audio from that input. For example, if passengers prefer their own music while the pilot listens to the XM Radio, the entertainment audio should be connected to the MUSIC 2 jack.

## 4.6 AUDIO PANEL PREFLIGHT PROCEDURE

**NOTE:** If the pilot and/or copilot are using headsets that have a high/low switch or volume control knob, verify that the switch is in the high position and the volume control on the headsets are at maximum volume setting. On single-pilot flights, verify that all other headsets are not connected to avoid excess noise in the audio system.

**NOTE:** When the **MAN SQ** Key is pressed, the ICS squelch can be set manually by the pilot and copilot. If manual squelch is set to full open (SQ annunciated and the knobs turned counterclockwise) background noise is heard in the ICS system as well as during COM transmissions.

After powering up the G1000 System, the following steps will aid in maximizing the use of the Audio Panel as well as prevent pilot and copilot induced issues. These preflight procedures should be performed each time a pilot boards the aircraft to insure awareness of all audio levels in the Audio Panel and radios.

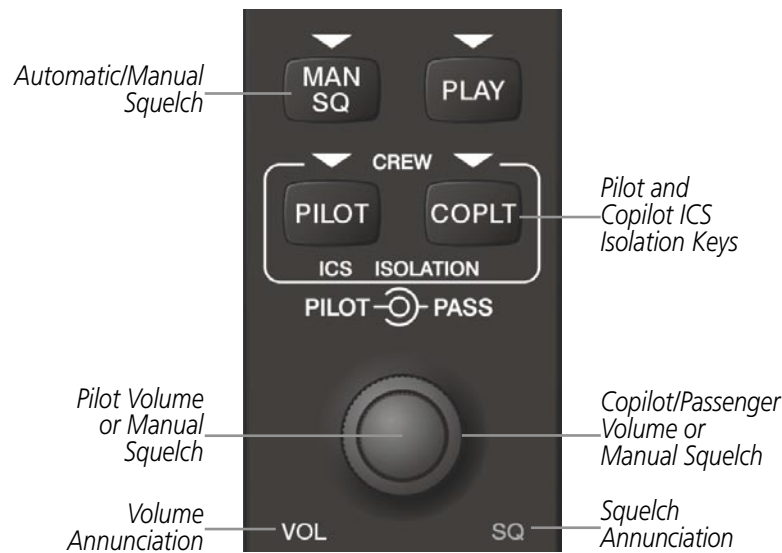

Figure 4-61 Audio Panel Controls

### Setting the Audio Panel during preflight:

- 1) Verify that the PILOT and COPLT Annunciators are extinguished.
- 2) Verify that the MAN SQ Annunciator is extinguished.
- 3) Turn the **PILOT/PASS** Knobs clockwise two full turns. This will set the headset intercom audio level to max volume (least amount of attenuation).
- 4) Adjust radio volume levels (COM, NAV, etc.) to a suitable level.
- 5) Adjust the **PILOT/PASS** Knob volume to the desired intercom level.

Once this procedure has been completed, the pilot and copilot can change settings, keeping in mind the notes above.

## 4.7 ABNORMAL OPERATION

Abnormal operation of the G1000 includes equipment failures of the G1000 components and failure of associated equipment, including switches and external devices.

### STUCK MICROPHONE

If the push-to-talk (PTT) Key becomes stuck, the COM transmitter stops transmitting after 35 seconds of continuous operation. An alert appears on the PFD to advise the pilot of a stuck microphone.

The **COM1 MIC** or **COM2 MIC** Key Annunciator on the Audio Panel flashes as long as the PTT Key remains stuck.



Figure 4-62 Stuck Microphone Alert

### COM TUNING FAILURE

In case of a COM system tuning failure, the emergency frequency (121.500 MHz) is automatically tuned in the radio in which the tuning failure occurred. Depending on the failure mode, a red X may appear on the frequency display.



Figure 4-63 COM Tuning Failure

### AUDIO PANEL FAIL-SAFE OPERATION

If there is a failure of the Audio Panel, a fail-safe circuit connects the pilot's headset and microphone directly to the COM1 transceiver. Audio will not be available on the speaker.

### REVERSIONARY MODE

The red **DISPLAY BACKUP** Button selects Reversionary Mode for both displays. Reversionary Mode operation displays flight and engine information on both the PFD and MFD, in case of display failure.

See the System Overview Section for more information on the **DISPLAY BACKUP** Button.



Figure 4-64 Display Backup Button

**BLANK PAGE**

## SECTION 5 GPS NAVIGATION

### 5.1 INTRODUCTION

This section of the Pilot's Guide provides GPS and vertical navigation operating procedures for the G1000 installed in the Diamond DA40/40F. This section assumes some prior knowledge of the other sections of the G1000 Pilot's Guide, especially the "how-to" of entering data and MFD Page Groups. All screen displays in this section are for reference only and are subject to change. This section is organized as follows:

- MFD Navigation Map
- PFD Inset Map and Windows
- Direct to Navigation
- Airport Information
- Intersection Information
- NDB Information
- VOR Information
- User Waypoint Information
- Nearest Airports
- Nearest Intersections
- Nearest NDBs
- Nearest VORs
- Nearest Frequencies
- Nearest Airspaces
- Nearest User Waypoints
- Flight Planning
- Procedures
- Abnormal Operation

## 5.2 NAVIGATION MAP (MFD)

**WARNING:** The basemap (land and water data) must not be used for navigation, only for situational awareness. Any basemap indication should be compared with other navigation sources.

**NOTE:** MFD Navigation Map operations involving the display of traffic, Terrain Proximity, and weather data are described in the Hazard Awareness Section.

**NOTE:** Refer to the appendices for a full description and interpretation of aviation map data.

This section describes the MFD Navigation Map setup and operation which in most cases is a “one-time” operation since the setup can be customized to accommodate the individual needs of the pilot.



Figure 5-1 Navigation Map Page



The Navigation Map Page (Figure 5-1) is the first page in the Map Page Group and provides the following GPS Navigation display capability:

- Map display showing airports, NAVAIDs, airspaces, land data (highways, cities, lakes, rivers, borders, etc.) with names
- Map pointer information (distance and bearing to pointer, location of pointer, name, and other pertinent information)
- Map range
- Wind direction and speed
- Airways
- Heading indication
- Aircraft icon representing present position
- Icons for enabled map features
- Track vector
- Topography scale
- Fuel range ring
- Topography data

## NAVIGATION MAP SETUP

The map can be customized using the map setup groups listed in the Navigation Map Page Setup Menu. To display the menu, press the **MENU** Key (with the Navigation Map Page displayed).



Figure 5-2 Navigation Map Page Menu

Within the Map Setup Option there are the following setup groups (Figure 5-3):

- Map
- Weather (refer to the Hazard Awareness Section)
- Traffic (refer to the Hazard Awareness Section)
- Aviation
- Airways
- Land



Figure 5-3 Map Setup Groups

## MAP GROUP

### ORIENTATION

There are four map orientation selections: North up, Track up, DTK up, and HDG up. The orientation default setting is 'North Up'.

- North up fixes the top of the map to a north heading.
- Track up adjusts the top of the map display to the current ground track.
- Desired Track Up (DTK up) fixes the top of the map display to the desired course.
- Heading Up (HDG up) fixes the top of the map display to the current aircraft heading.

#### Changing the map orientation:

- 1) With the Navigation Map Page displayed, press the **MENU** Key. The cursor flashes on the 'Map Setup' option.
- 2) Press the **ENT** Key. The Map Setup Menu is displayed.
- 3) Select the 'ORIENTATION' field. Select the desired orientation and press the **ENT** Key.
- 4) Press the **FMS** Knob to return to the Navigation Map Page.



Figure 5-4 Map Group

### Auto Zoom

- In the event of a Terrain Proximity alert condition (caution or warning), the map field of a page allowing auto zoom and displaying TAWS/Terrain Proximity data automatically adjusts to the lowest map range in which the highest priority alert is clearly visible and proceeds to auto zoom when the Terrain Proximity alert condition clears.
- In the event of a new traffic advisory alert, the map field of a page allowing auto zoom and capable of displaying traffic advisory alerts automatically adjusts to the lowest map range in which the traffic advisory is clearly visible and proceeds to auto zoom when the traffic advisory clears.

The minimum and maximum look forward times (configurable per airframe and on the Map Setup page for the 'Map' group) determines the minimum and maximum radial distances to display from the current aircraft position when in north up orientation or from the map center when in heading up, desired track up, or track up orientations based upon the aircraft's ground speed.

- The maximum look forward time is the basis for which the maximum zoom range necessary to display the active waypoint, if possible, is determined.
- The minimum look forward time is the basis for which the minimum zoom range necessary to display the active waypoint, if possible, is determined.
- The time out time (configurable on the Map Setup page for the "Map" group) determines the amount of time that auto zoom is allowed to be overridden by a manual adjustment of the range knob unless the time out value is zero, in which case the override condition never times out.
- The active waypoint is visible on the map in a lower zoom range or the current zoom range exceeds the maximum zoom range.
- The current zoom range exceeds the minimum zoom range.

#### **Enabling/disabling automatic zoom:**

- 1) Press the **MENU** Key with the Navigation Map Page displayed. The cursor flashes on the 'Map Setup' option.
- 2) Press the **ENT** Key. The Map Setup Menu is displayed.
- 3) Select the 'Map' group
- 4) Press the **ENT** Key.
- 5) Highlight the 'AUTO ZOOM' field.
- 6) Select 'Off', 'MFD Only', 'PFD Only', or 'ALL On'.
- 7) Press the **ENT** Key to accept the selected option. The flashing cursor highlights the 'MAX LOOK FWD' field. Times are from zero to 999 minutes.
- 8) Use the small and large **FMS** Knobs to set the time. Press the **ENT** Key.
- 9) Repeat step 8 for 'MIN LOOK FWD' (zero-99 minutes) and 'MAX LOOK FWD' (zero to 999 minutes).
- 10) Press the **FMS** Knob to return to the Navigation Map Page.

#### **Land Data**

The Navigation Map can display background land data (roads, lakes, borders, etc). The background land data can also be removed from the display (turned off).

#### **Enabling/disabling land data:**

- 1) Press the **MENU** Key with the Navigation Map Page displayed. The cursor flashes on the 'Map Setup' option.
- 2) Press the **ENT** Key. The Map Setup Menu is displayed.
- 3) Select the 'Map' group.
- 4) Press the **ENT** Key.
- 4) Highlight the 'LAND DATA' field.

- 5) Select 'On' or 'Off'.
- 6) Press the **FMS** Knob to return to the Navigation Map Page.

**Track Vector**

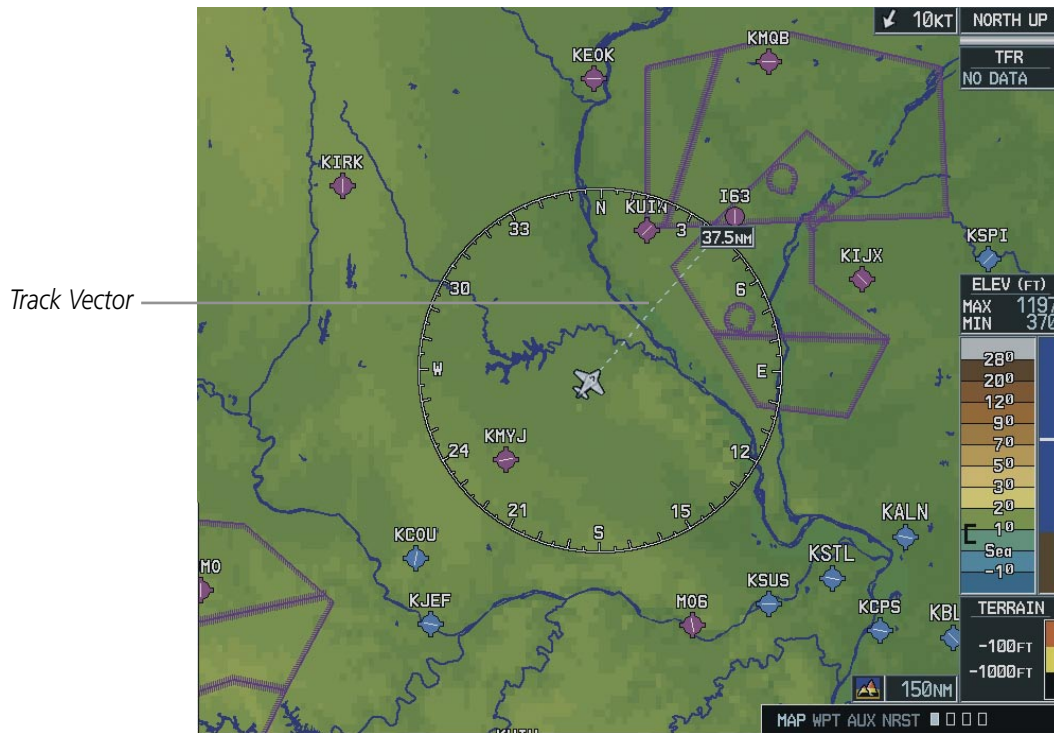

**Figure 5-5 Track Vector**

The Navigation Map can display a track vector as a dashed light blue line segment with an Map Pointerhead attached to the end, extended to a predicted location along the current aircraft track (Figure 5-5). The track vector is useful in minimizing track angle error. The track vector look-ahead times are selectable times (30 sec, 60 sec, 2 min, 5 min, 10 min, 20 min) that determine the length of the track vector to project from the current aircraft position so that the Map Pointer head is constantly pointing to the aircraft's predicted location along the current track in the selected time.

For example, if a user selects the 60 second track vector look-ahead time on the Map Setup page, the track vector displayed on the map is the length equivalent to 60 seconds from the current aircraft position along the current aircraft track.

**Enabling/disabling the track vector:**

- 1) Press the **MENU** Key with the Navigation Map Page displayed. The cursor flashes on the 'Map Setup' option.
- 2) Press the **ENT** Key. The Map Setup Menu is displayed.
- 3) Select the 'Map' group.
- 4) Press the **ENT** Key.
- 5) Highlight the 'TRACK VECTOR' field.

- 6) Select 'On' or 'Off'. Press the **ENT** Key to accept the selected option. The flashing cursor highlights the 'LOOK AHEAD' time field. Use the **FMS** Knobs to select the desired time (30 seconds, 60 seconds, 2 minutes, 5 minutes, 10 minutes, 20 minutes). Press the **ENT** Key.
- 7) Press the **FMS** Knob to return to the Navigation Map Page.

### Wind Vector

The wind vector is displayed in the upper right corner of the map and displays wind direction and speed (in knots). Wind direction is indicated by an Map Pointer.

#### Enabling/disabling the wind vector:

- 1) Press the **MENU** Key with the Navigation Map Page displayed. The cursor flashes on the 'Map Setup' option.
- 2) Press the **ENT** Key. The Map Setup Menu is displayed.
- 3) Select the 'Map' group.
- 4) Press the **ENT** Key.
- 5) Highlight the 'WIND VECTOR' field.
- 6) Select 'On' or 'Off'.
- 7) Press the **FMS** Knob to return to the Navigation Map Page.

### Nav Range Ring

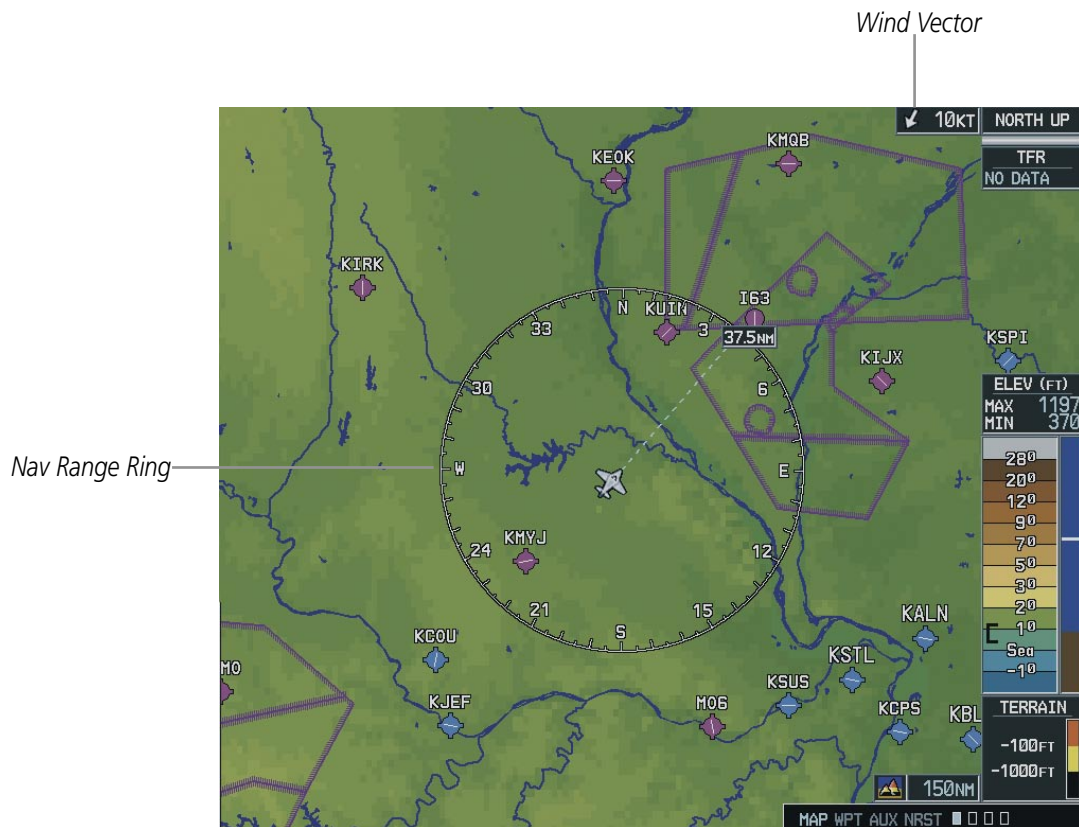

Figure 5-6 Nav Range Ring

The Nav Range Ring (Figure 5-6) shows the direction of travel (ground track) on a rotating compass card. The range of the Nav Ring is determined by the map range: 125 feet (500 feet map range) to 500 nm (2000 nm map range).

#### Enabling/disabling the Nav Range Ring:

- 1) Press the **MENU** Key with the Navigation Map Page displayed. The cursor flashes on the 'Map Setup' option.
- 2) Press the **ENT** Key. The Map Setup Menu is displayed.
- 3) Select the 'Map' group.
- 4) Press the **ENT** Key.
- 5) Highlight the 'NAV RANGE RING' field.
- 6) Select 'On' or 'Off'.
- 7) Press the **FMS** Knob to return to the Navigation Map Page.

#### Topo Data

Topographic data can be enabled or disabled on the Navigation Map using the 'TOPO DATA' setting. The topo data range is the maximum map range on which topo data is displayed.

**Enabling/disabling topo data and select a topo data range:**

- 1) Press the **MENU** Key with the Navigation Map Page displayed. The cursor flashes on the 'Map Setup' option.
- 2) Press the **ENT** Key. The Map Setup Menu is displayed.
- 3) Select the 'Map' group.
- 4) Press the **ENT** Key.
- 3) Highlight the 'TOPO DATA' field.
- 4) Select 'On' or 'Off'.
- 5) Highlight the range field. TOPO ranges are from Off to 2000 nm.
- 6) To change the TOPO range setting, turn the small **FMS** Knob to display the range list.
- 7) Select the desired range.
- 8) Press the **ENT** Key.

**Topo Scale**

The topo scale setting enables or disables the topography range box located in the lower right corner of the Navigation Map.

**Enabling/disabling the topo range box:**

- 1) Press the **MENU** Key with the Navigation Map Page displayed. The cursor flashes on the 'Map Setup' option.
- 2) Press the **ENT** Key. The Map Setup Menu is displayed.
- 3) Select the 'Map' group and press the **ENT** Key.
- 4) Highlight the 'TOPO Range' field.
- 5) Select 'On' or 'Off'.
- 6) Press the **FMS** Knob to return to the Navigation Map Page.

**Terrain Proximity Data**

Terrain Proximity data can be enabled or disabled on the Navigation Map Page using the 'TERRAIN DATA' setting. A data range can also be selected. The data range is the maximum map range that Terrain Proximity data is displayed.

**Enabling/disabling Terrain Proximity data and to select a Terrain Proximity data range:**

- 1) With the Navigation Map Page displayed, press the **MENU** Key to display the Navigation Map Page Menu. The cursor flashes on the 'Map Setup' option.
- 2) Press the **ENT** Key. The Map Setup Menu is displayed.
- 3) Select the 'Map' group.
- 4) Press the **ENT** Key.
- 5) Highlight the 'Terrain Proximity DATA' field.
- 6) Select 'On' or 'Off'.



- 7) Select the **ENT** Key to accept the selected option. The flashing cursor highlights the range field. Terrain Proximity ranges are from Off to 2000 nm.
- 8) To change the Terrain Proximity range setting, turn the small **FMS** Knob to display the range list.
- 9) Select the desired range.
- 10) Press the **ENT** Key. Press the **FMS** Knob to return to the Navigation Map Page.

### Obstacle Data



Figure 5-7 Obstacle Data

Obstacle data can be enabled or disabled on the Navigation Map Page using the 'OBSTACLE DATA' setting. A data range can also be selected. The data range is the maximum map range that Terrain Proximity data is displayed.

#### Enabling/disabling obstacle data and to select a Terrain Proximity data range:

- 1) With the Navigation Map Page displayed, press the **MENU** Key to display the Navigation Map Page Menu. The cursor flashes on the 'Map Setup' option.
- 2) Press the **ENT** Key. The Map Setup Menu is displayed.
- 3) Select the 'Map' group.
- 4) Press the **ENT** Key.
- 5) Highlight the 'OBSTACLE DATA' field.
- 6) Select 'On' or 'Off'.

- 7) Press the **ENT** Key to accept the selected option. The flashing cursor highlights the range field. OBSTACLE ranges are from Off to 50 nm.
- 8) To change the OBSTACLE range setting, turn the small **FMS** Knob to display the range list.
- 9) Select the desired range.
- 10) Press the **ENT** Key.
- 11) Press the **FMS** Knob to return to the Navigation Map Page.

### **FUEL RANGE RING (FUEL RNG) (RSV)**

Refer to the EIS section for details regarding the Fuel Range Ring.

### **WEATHER GROUP**

Refer to the Hazard Awareness Section for information pertaining to the setup and display of the Weather Group Options.

### **TRAFFIC GROUP**

Refer to the Hazard Awareness Section for information pertaining to the setup and display of the Traffic Group Options.

**AVIATION GROUP**



**Figure 5-8 Map Group**

- Active Flight Plan (ACTIVE FPL)- The active flight plan zoom range sets the maximum range at which the active flight plan magenta line is shown on the display (off - 2000 nm).
- Active Flight Plan Waypoint (ACTIVE FPL WPT)- The active flight plan waypoint label size sets the size at which the active flight plan names appear on the display (none, small, medium, and large). The zoom range sets the maximum range at which active flight plan waypoints appear on the display (off - 2000 nm).
- Large, Medium, and Small Airports (LARGE APT, MEDIUM APT, SMALL APT) - The airport label size sets the size at which the large, medium, or small airport names size appear on the display. The zoom range sets the maximum range at which the airports appear on the display:
  - Large: off - 500 nm
  - Medium: off - 300 nm
  - Small: off - 100 nm
- Safe Taxi (SAFETAXI) - The zoom range sets the maximum range at which taxiways appear on the display:
  - Off - 20 nm

- Runway Extension (RWY EXTENSION) - The zoom range sets the maximum range at which runway extensions appear on the display:
  - Off - 100 nm
- Intersection, Non-Directional Beacon, and VOR Waypoints (INT WAYPOINT, NDB WAYPOINT, VOR WAYPOINT) - The INT, NDB, and VOR label size sets the maximum range at which the NAVAIDS names appear on the display. The zoom range sets the maximum range at which the NAVAIDS appear on the display:
  - INT: off - 30 nm
  - NDB: off - 30 nm
  - VOR: off - 300 nm
- Airspace Boundaries (CLASS B/TMA, CLASS C/TCA, and CLASS D) - The airspace zoom range sets the maximum range at which the three classes of airspace appear on the display. The zoom range sets the maximum range at which the airspace boundaries appear on the display:
  - CLASS B: off - 500 nm
  - CLASS C: off - 500 nm
  - CLASS D: off - 300 nm
- “Other” Airspace Boundaries (RESTRICTED, MOA (Military), OTHER AIRSPACE, and TFR (temporary flight restrictions). The other airspace boundary zoom range sets the maximum range at which restricted, MOA, and other (training, caution, danger, warning, and alert areas) airspace boundaries are displayed
- RESTRICTED: off - 500 nm
- MOA (MILITARY): off - 500 nm
- OTHER/ADIZ: off - 500 nm
- TFR: (only present when GDL 69 is installed): off - 2000 nm

#### Selecting an aviation group item text size:

- 1) Press the **MENU** Key with the Navigation Map Page displayed. The cursor flashes on the ‘Map Setup’ option.
- 2) Select the **ENT** Key. The Map Setup Menu is displayed.
- 3) Select the ‘Aviation’ group.
- 4) Select the **ENT** Key. The cursor flashes on the ‘ACTIVE FPL’ field.
- 5) Select the desired aviation option.
- 6) Select the desired text size.
- 7) Select the **ENT** Key to accept the selected text size.
- 8) Press the **FMS** Knob to return to the Navigation Map Page.

**Selecting an aviation group item range:**

- 1) Press the **MENU** Key with the Navigation Map Page displayed. The cursor flashes on the 'Map Setup' option.
- 2) Press the **ENT** Key. The Map Setup Menu is displayed.
- 3) Select the 'Aviation' group.
- 4) Press the **ENT** Key. The cursor flashes on the 'ACTIVE FPL' field.
- 5) Select the desired aviation option.
- 6) Select the desired range (RNG). Press the **ENT** Key to accept the selected option.
- 7) Press the **FMS** Knob to return to the Navigation Map Page.

**AIRWAYS GROUP**

Figure 5-9 Airways Setup Options

The Airways group manages the display of airways. See the airways section for more information on using the airways feature.

- **Airways** - Selects the display of airways:
  - OFF (default setting)
  - ALL
  - LO Only (200 nm default setting)
  - HI Only (300 nm default setting)
- **LOW ALT AIRWAY** - The range sets the maximum range at which low altitude airways appear on the display.
  - LO ALT AIRWAY: 500 ft. - 500 nm
- **HI ALT AIRWAY** - The range sets the maximum range at which high altitude airways appear on the display.
  - HI ALT AIRWAY: 500 ft. - 500 nm

**Selecting an airway to display:**

- 1) Press the **MENU** Key with the Navigation Map Page displayed. The cursor flashes on the 'Map Setup' option.
- 2) Press the **ENT** Key. The Map Setup Menu is displayed.
- 3) Select the 'Airways' group.
- 4) Press the **ENT** Key. The cursor flashes on the 'AIRWAYS' field.
- 5) Select the desired airways option (Off, All, LO Only, HI Only).
- 6) Press the **ENT** Key to accept the selected option.
- 7) Press the **FMS** Knob to return to the Navigation Map Page.

**Selecting a low or high altitude airway display range:**

- 1) Press the **MENU** Key with the Navigation Map Page displayed. The cursor flashes on the 'Map Setup' option.
- 2) Press the **ENT** Key. The Map Setup Menu is displayed.
- 3) Select the 'Airways' group.
- 4) Press the **ENT** Key. The cursor flashes on the 'AIRWAYS' field.
- 5) Move the cursor to the LO ALT AIRWAY or HI ALT AIRWAY field.
- 6) Select the desired range.
- 7) Press the **ENT** Key to accept the selected range.
- 8) Press the **FMS** Knob to return to the Navigation Map Page.



## LAND GROUP



Figure 5-11 Land Group

- Latitude/Longitude (LAT/LON) - The LAT/LON label size sets the size at which latitude/longitude labels appear on the display (none, small, medium, and large). The zoom range sets the maximum range at which LAT/LON waypoints appear on the display (off - 2000 nm).
- Highways, Roads, and Railroads (FREEWAY, LOCAL HWY, LOCAL ROAD, RAILROAD) - The highway and road zoom range sets the maximum range at which highways, roads, and railroads appear on the display:
  - FREEWAY: off - 800 nm
  - NATIONAL HWY: off - 80 nm
  - LOCAL HWY: off - 30 nm
  - LOCAL ROAD: off - 15 nm
  - RAILROAD: off - 30 nm
- Cities and Towns (LARGE CITY, MEDIUM CITY, SMALL CITY) - The cities and town label size sets the maximum range at which city and town names appear on the display. The zoom range sets the maximum range at which cities and towns appear on the display:



- LARGE CITY (approximate populations greater than 200,000): off - 1500 nm
- MEDIUM CITY (approximate populations greater than 50,000): off - 200 nm
- SMALL CITY (approximate populations greater than 5,000): off - 50 nm
- States and Provinces, Rivers and Lakes, and User Waypoints (STATE/PROV, RIVER/LAKE, USER WAYPOINT) - the label range sets the maximum range at which the three categories appear on the display. The zoom range sets the maximum range at which the three categories appear on the display:
  - STATE/PROV: off - 1500 nm
  - RIVER/LAKE off - 500 nm
  - USER WAYPOINT: off - 300 nm

#### Selecting a land group item text size:

- 1) Press the **MENU** Key with the Navigation Map Page displayed. The cursor flashes on the 'Map Setup' option.
- 2) Press the **ENT** Key. The Map Setup Menu is displayed.
- 3) Select the 'Land' group.
- 4) Press the **ENT** Key. The cursor flashes on the 'LAT/LON' field.
- 5) Select the desired land option.
- 6) Select the desired text size.
- 7) Press the **ENT** Key to accept the selected option.
- 8) Press the **FMS** Knob to return to the Navigation Map Page.

#### Selecting a land group item range:

- 1) Press the **MENU** Key with the Navigation Map Page displayed. The cursor flashes on the 'Map Setup' option.
- 2) Press the **ENT** Key. The Map Setup Menu is displayed.
- 3) Select the 'Land' group.
- 4) Press the **ENT** Key. The cursor flashes on the 'LAT/LON' field.
- 5) Select the desired land option.
- 6) Press the **ENT** Key to accept the selected option.
- 7) Press the **FMS** Knob to return to the Navigation Map Page.

## SELECTING A MAP RANGE

The Navigation Map can be set to 28 different range settings from 500 feet to 2000 nautical miles. The current range is indicated in the lower right corner of the Navigation Map Page and represents the **top-to-bottom distance covered by the map**. To change the map range turn the joystick counter-clockwise to zoom in, or clockwise to zoom out.

## DECLUTTERING THE MAP

The declutter feature steps through 4 levels of removing map information. The declutter level is displayed in the **DCLTR** Softkey and next to the Declutter Menu Option. In Table 5-1, the shaded area under the declutter level headings represent map items “removed” and the white areas represent map items “displayed” for the various levels of declutter.

### Decluttering the map:

- 1) Press the **MENU** Key with the Navigation Map Page displayed.
- 3) Select 'Declutter'. The current declutter level is shown.
- 4) Press the **ENT** Key.

### OR:

Select the **DCLTR** Key with the Navigation Map Page displayed. The current declutter level is shown. With each press, another level of map information is removed.

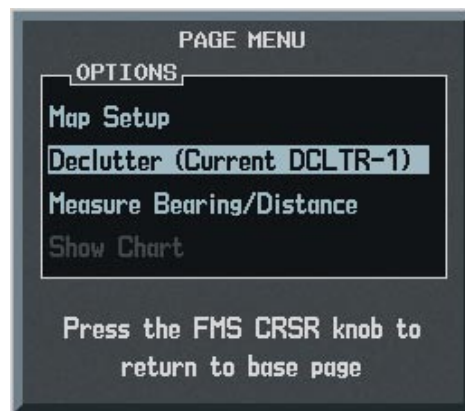

Figure 5-12 Map Declutter Option

|                                  | No Declutter | Declutter-1 | Declutter-2 | Declutter-3 |
|----------------------------------|--------------|-------------|-------------|-------------|
| Flight Plan Route Lines          |              |             |             |             |
| Flight Plan Route Waypoints      |              |             |             |             |
| Rivers/Lakes                     |              |             |             |             |
| Topography Data                  |              |             |             |             |
| TAWS/Terrain Proximity           |              |             |             |             |
| Map Borders                      |              |             |             |             |
| Bearing Line                     |              |             |             |             |
| Stormscope Lightning Strike Data |              |             |             |             |
| NEXRAD                           |              |             |             |             |
| XM Lightning Data                |              |             |             |             |
| Traffic                          |              |             |             |             |
| Airports                         |              |             |             |             |
| Runway Labels                    |              |             |             |             |
| Restricted                       |              |             |             |             |
| MOA (Military)                   |              |             |             |             |
| User Waypoints                   |              |             |             |             |
| Latitude/Longitude Grid          |              |             |             |             |
| VORs                             |              |             |             |             |
| NDBs                             |              |             |             |             |
| Intersections                    |              |             |             |             |
| Class B/TMA                      |              |             |             |             |
| Class C/TCA                      |              |             |             |             |
| Class D                          |              |             |             |             |
| Other/ADIZ                       |              |             |             |             |
| Obstacles                        |              |             |             |             |
| Land/Country Text                |              |             |             |             |
| Cities                           |              |             |             |             |
| Roads                            |              |             |             |             |
| Railroads                        |              |             |             |             |
| Major Political Boundaries       |              |             |             |             |
| River/Lake Names                 |              |             |             |             |

Table 5-1 Map Declutter Levels

## MAP PANNING

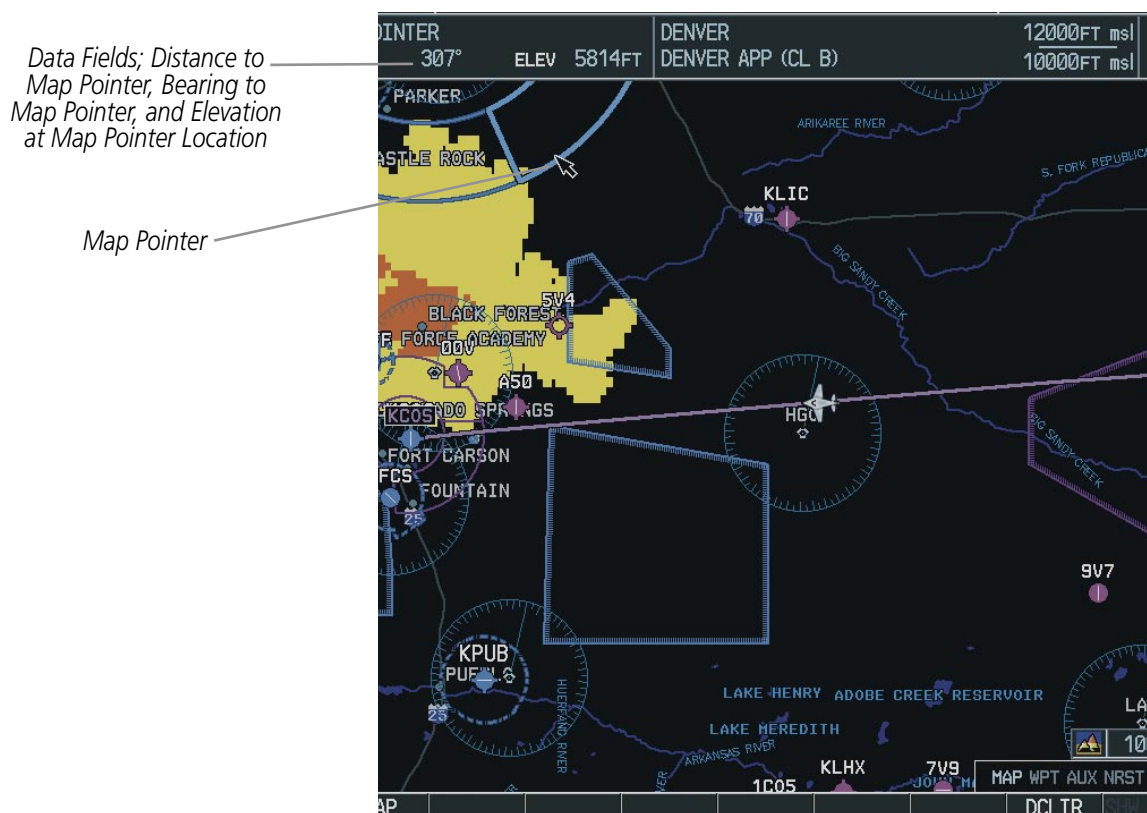

Figure 5-13 Map Panning

Map panning (Figure 5-13) moves the map beyond its current limits without adjusting the map range. When the panning function is selected by pushing in the **Joystick**, the Map Pointer flashes on the map display. A window also appears at the top of the map display showing the latitude/longitude position of the Map Pointer, the bearing and distance to the pointer from the aircraft's present position and the elevation of the land at the position of the Map Pointer. When the Map Pointer crosses an airspace boundary, the boundary is highlighted and airspace information is shown at the top of the display. The information includes the name and class of airspace, the ceiling in feet expressed in Mean Sea Level (MSL), and the floor in feet MSL.

**Panning the map:**

- 1) Push the **Joystick** to display the Map Pointer.
- 2) Move the **Joystick** in the general direction of the desired destination to place the Map Pointer at the destination location. When the Map Pointer is placed on an object, the name of the object is highlighted (even if the name was not originally displayed on the map). This feature applies to everything displayed on the map except route lines. When any map feature or object is selected on the map display, features or objects are displayed in the box located at the top of the display. From here, the waypoint as the direct-to destination. When the Map Pointer crosses an airspace boundary, the boundary is highlighted and airspace information is displayed at the top of the display.
- 3) Push the **Joystick** to remove the Map Pointer and re-center the map on the aircraft's current position.

**Creating user waypoints from the Navigation Map Page:**

- 1) With the Navigation Map Page displayed, push the **Joystick** to activate the panning function. The Map Pointer is displayed at the present aircraft position.
- 2) After placing the Map Pointer at the desired position, press the **ENT** Key. The User Waypoint Information Page is displayed with the captured position.
- 3) Enter a waypoint name.
- 4) Press the **ENT** Key to accept the selected name. The first reference waypoint field is highlighted.
- 5) If desired, enter the identifier of the reference waypoint and the radial and distance to the reference waypoint.
- 6) Press the **FMS** Knob to remove the flashing cursor.

**DISPLAYING TOPOGRAPHIC DATA ON THE MAP**

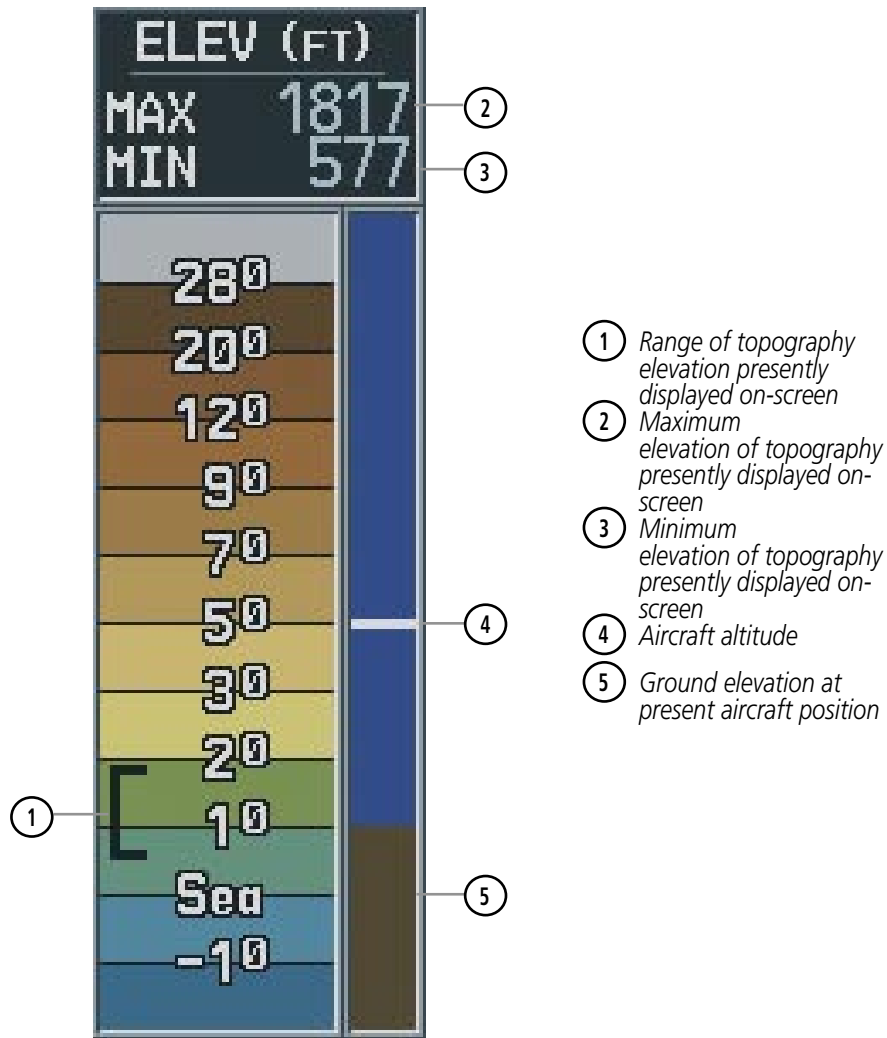

Figure 5-14 Topography Scale

The Navigation Map displays various shades of topography land colors representing the rise and fall of land elevation similar to aviation sectional charts (Figure 5-19). The Navigation Map can display a topographic range representing various key points of Terrain Proximity elevation colors with their associated elevation value labeled.

**Enabling/disabling topo data and selecting a topo data range:**

- 1) Press the **MENU** Key with the Navigation Map Page displayed. The cursor flashes on the 'Map Setup' option.
- 2) Press the **ENT** Key. The Map Setup Menu is displayed.
- 3) Select the 'Map' group.
- 4) Press the **ENT** Key.
- 3) Highlight the 'TOPO DATA' field.
- 4) Select 'On' or 'Off'.
- 5) Highlight the range field. TOPO ranges are from Off to 2000 nm.
- 6) To change the TOPO range setting, turn the small **FMS** Knob to display the range list.
- 7) Select the desired range.
- 8) Press the **ENT** Key.

**Displaying topographic data on all pages displaying maps:**

- 1) Press the **MAP** Softkey.
- 2) Press the **TOPO** Softkey.
- 3) Press the **TOPO** Softkey again to remove topo data from the Navigation Map. When topographic data is removed from the page, all navigation data is presented on a black background.

**TOPO SCALE**

The 'TOPO SCALE' menu option enables or disables the topography range box located in the lower right corner of the Navigation Map.

**Enabling/disabling the topo range box:**

- 1) Press the **MENU** Key with the Navigation Map Page displayed. The cursor flashes on the 'Map Setup' option.
- 2) Press the **ENT** Key. The Map Setup Menu is displayed.
- 3) Select the 'Map' group and select the **ENT** Key.
- 4) Highlight the 'TOPO SCALE' field.
- 5) Select 'On' or 'Off'.
- 6) Press the **FMS** Knob to return to the Navigation Map Page.

**GPS NAVIGATION STATUS BOX**



**NOTE:** The coloration of primary, GPS-derived data is yellow when in dead reckoning mode. These primary fields include the NAV Status Box fields except Active Leg, TAS, and DTK.



**Table 5-15 GPS Navigation Status Box**

The GPS Navigation Status Box (Figure 5-15) is displayed in the top center of the MFD and PFD. It displays four, user-configurable fields which can display the information listed below:

- Bearing to next waypoint (BRG)
- Distance to next waypoint (DIS)
- Desired track to next waypoint (DTK)
- Enroute safe altitude (ESA)
- Estimated Time of Arrival (ETA)
- Estimated Time Enroute (ETE)
- Ground Speed (GS)
- Maximum Safe Altitude (MSA)
- True Airspeed (TAS)
- Track angle error (TKE)
- Track angle (TRK)
- Vertical speed required (VSR)
- Cross track error (XTK)

By default, the Navigation Status Box is set to display ground speed (GS), distance to next waypoint (DIS), estimated time enroute (ETE), and enroute safe altitude (ESA).

### Changing a field in the GPS Navigation Status Box:

- 1) Select the System Setup Page.
- 2) Press the **FMS** Knob momentarily to activate the flashing cursor.
- 2) Turn the large **FMS** Knob to highlight the desired field number in the MFD Data Bar Fields Box.
- 3) Turn the small **FMS** Knob to display and scroll through the data options list.
- 4) Select the desired data.
- 5) Press the **ENT** Key. Pressing the Defaults (**DFLTS**) Softkey can be used to return any field to its default setting (listed previously).

### MEASURING BEARING AND DISTANCE

The second map setup option is 'Measure Bearing/Distance' (Figure 5-16), which provides a quick and easy method for determining the bearing and distance between any two points on the Navigation Map. Pressing the **ENT** Key at any location with the 'Measure' option enabled allows bearing and distance from the newly selected position to be acquired.

Data Fields;  
Distance to Map  
Pointer, Bearing to  
Map Pointer, and  
Elevation at Map  
Pointer Location

Bearing Line

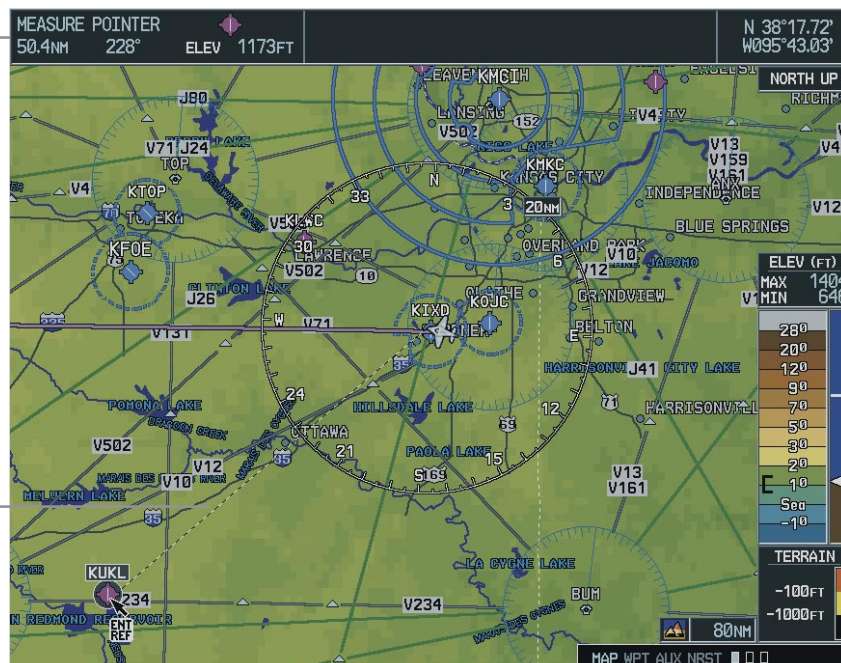

Figure 5-16 Measuring Bearing and Distance on the MFD Navigation Map



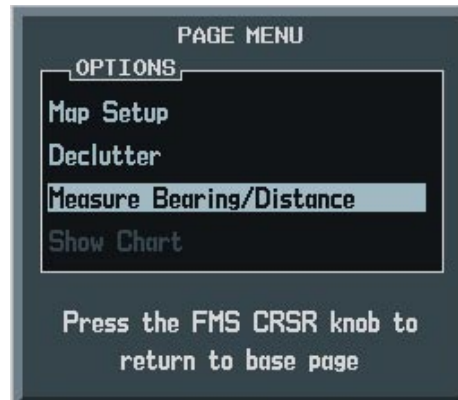

Figure 5-17 Measure Bearing/Distance Option

### Measuring bearing and distance between two points:

- 1) Press the **MENU** Key (with the Navigation Map Page displayed).
- 2) Highlight the 'Measure Bearing/Distance' field.
- 3) Press the **ENT** Key. An on-screen reference pointer is displayed on the map display at the aircraft's present position.
- 4) Move the **Joystick** to place the reference pointer at the desired location. The bearing and distance is displayed at the top of the map display. Elevation at the current position is also displayed. Pressing the **ENT** Key changes the starting point for measuring.
- 5) To exit the Measure Bearing/Distance option, push the **Joystick** or select 'Stop Measuring' from the page menu.
- 6) Press the **ENT** Key.

### DISPLAYING CHARTS

ChartView and FliteCharts resemble the paper version of Jeppesen and NACO terminal procedures charts. The charts are displayed in full color with high-resolution. See the Additional Features section for more information on ChartView and FliteCharts.

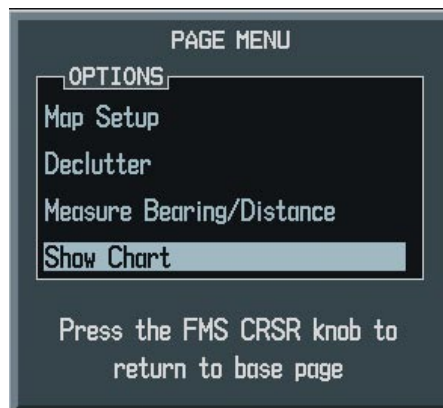



Figure 5-18 'Show Chart' Option

## 5.3 PFD INSET MAP AND WINDOWS

 **NOTE:** The Inset Map is removed from the PFD any time aircraft pitch is greater than  $+30^\circ$  or less than  $-20^\circ$ , or when a  $65^\circ$  bank angle is reached.

 **NOTE:** Inset Map operations involving the display of traffic, Terrain Proximity, and weather data are discussed in the Hazard Awareness section.

GPS navigation operations on the Primary Flight Display centers around the use of the Inset Map and Display Windows (Figures 5-19 and 5-20).

### INSET MAP

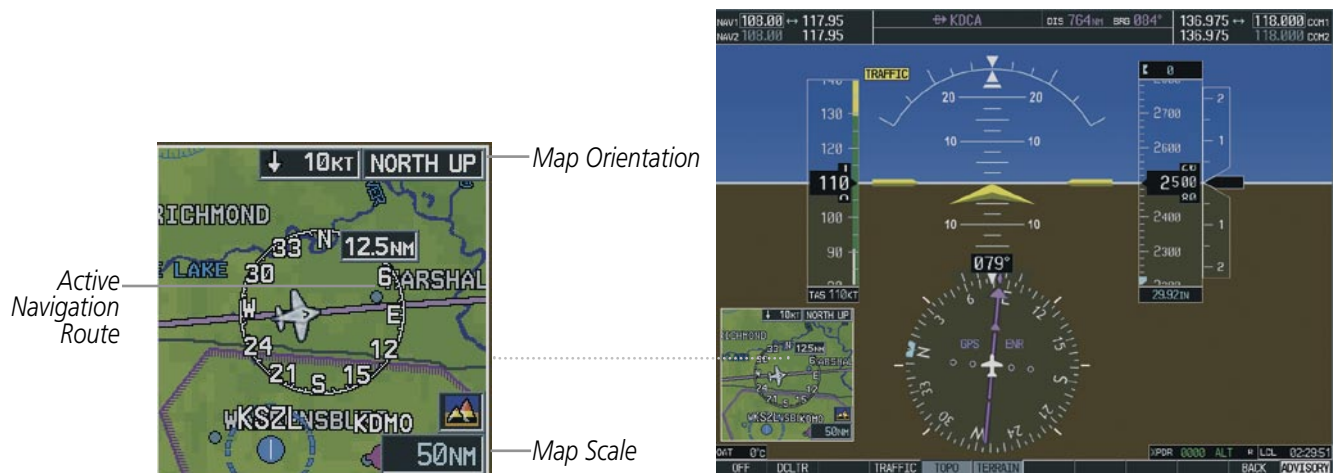

Figure 5-19 PFD Inset Map

The Inset Map is a smaller version of the MFD Navigation Map and is optionally displayed in the lower left corner of the PFD. The Inset Map is displayed by pressing the **INSET** Softkey. Inset Map features are enabled on the MFD (refer to the Navigation Map Setup section for details).

The Map Inset can display the following information:

- Moving map
- Zoom scale legend
- Orientation
- Aircraft icon
- TOPO data
- Traffic data
- Weather data
- Terrain Proximity data

- Active navigation flight plan
- Track vector
- Wind direction/speed
- Latitude/longitude lines
- NAV range ring
- Fuel range ring (reserve; the fuel reserve rings are enabled and disabled from the MFD only)
- Obstacles data
- Potential Terrain Proximity/obstacle impact data (TAWS)

The following Inset Map operations can be performed (operations are performed independently of the MFD):

- Changing the zoom range
- Changing the declutter level
- Map panning
- Topo
- Traffic
- Terrain Proximity
- Stormscope
- NEXRAD
- Lightning

To change the Inset Map zoom range, turn the **Joystick** clockwise to increase or counterclockwise to decrease the range. Zoom ranges from 500 feet to 2,000 nautical miles. To change the declutter level, press the **INSET** Softkey. Press the **DCLTR** Softkey to remove background map details until the desired amount of detail is displayed. The declutter level appears in the softkey (i.e., DCLTR-1).

#### **Panning the map:**

- 1) Push the **Joystick** to display the Map Pointer. The map can now move beyond its current limits without adjusting the range.
- 2) Move the **Joystick** to pan the map in the general direction of the desired location. When the pointer is placed on an object, the name of the object is highlighted for approximately 4 seconds (even if the name was not originally displayed on the map). This feature applies to everything displayed on the map except for route lines.
- 3) Push the **Joystick** to cancel the panning function and re-center the map on the aircraft's current position.

## PFD WINDOWS

PFD windows are displayed in the lower right corner of the PFD. PFD windows can display different types of information; the discussion in this section of the Pilot's Guide is limited to the following windows that pertain to GPS navigation:

- Nearest Airports
- Direct-to
- Flight Plan
- Procedures



Figure 5-20 PFD Window Location

### COLLAPSING AIRWAYS ON THE PFD FLIGHT PLAN WINDOW

On the PFD Flight Plan Window when the airway display has been collapsed, only the Entry and Exit waypoints of the airway are shown. When collapsed format is active, leg-to-leg computed values such as DIS or ETE shown for the exit waypoint reflects the total of all the legs on the airway that have been hidden in the collapsed display. The DTK value is inhibited because its meaning is not clear in this context.

The “Expanded” format is automatically selected after the “Load Airway” function is used (facilitates review of the flight plan).

## 5.4 DIRECT-TO-NAVIGATION (MFD)

**NOTE:** The Direct-to Window Inset Map (Figure 5-21) range is adjustable. To change the map range, turn the Joystick to the left to select a lower range, turn it to the right to select a higher range.

**NOTE:** A vertical navigation direct-to (when part of a flight plan) creates a descent path (and provides guidance to stay on the path) from the aircraft's current altitude to the altitude of the direct-to waypoint. All altitude constraints prior to the direct-to waypoint are removed from the active flight plan upon successful activation of the vertical direct-to. All altitude constraints following the vertical direct-to waypoint are retained. See the section on Vertical Navigation for more information regarding the use and purpose of altitude constraints and offset distances.

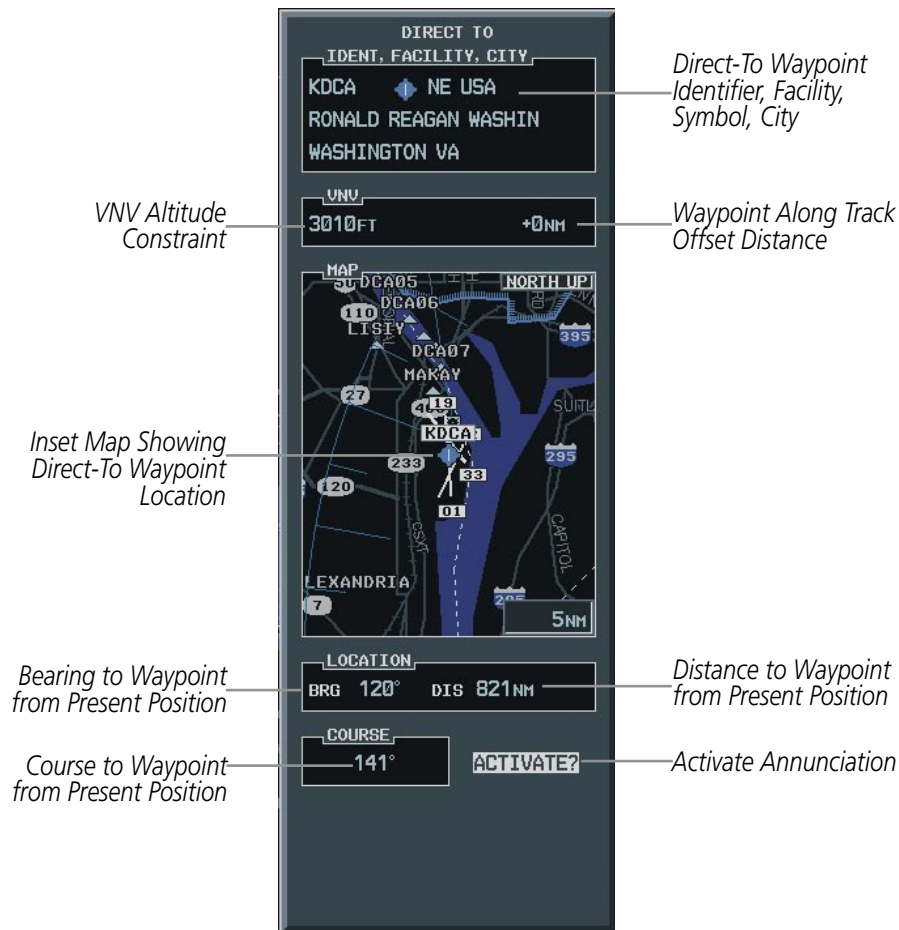

Figure 5-21 MFD Direct to Window

The “direct-to” navigation feature provides a quick method of setting a GPS course to a destination waypoint. Once a direct-to is activated, the G1000 establishes a point-to-point course line from the present position to the selected direct-to destination. Course guidance is provided until the direct-to is cancelled or replaced by a new destination.

## SELECTING A DIRECT-TO WAYPOINT

A direct-to waypoint can be selected in the following ways:

- By identifier, facility, or the name of a city
- From the active flight plan or nearest airports list
- From a waypoint field, waypoint page, or highlight shortcut

### Selecting and activating a direct-to destination by entering an identifier:

- 1) Press the **Direct-to** (D➤) Key.
- 2) Enter the destination waypoint identifier (Figure 5-22).



Figure 5-22 Entering an Identifier

- 3) Press the **ENT** Key to confirm the identifier. The ‘Activate?’ field is highlighted (Figure 5-23).



Figure 5-23 Activate Field

- 4) If no altitude constraint or course is desired, press the **ENT** Key to activate. To enter an altitude constraint, proceed to step 5.
- 5) Turn the large **FMS** Knob to place the cursor over the ‘VNV’ altitude field (Figure 5-24).

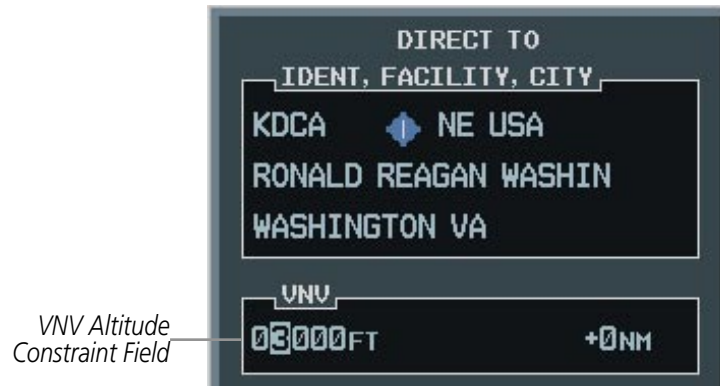

Figure 5-24 Entering a Direct-to Altitude Constraint

- 6) Enter the desired altitude.
- 7) Press the **ENT** Key. The option to select MSL or AGL is now displayed.



Figure 5-25 Entering an Along Track Offset Distance

- 8) Turn the small **FMS** Knob to select 'MSL' or 'AGL'.
- 9) Press the **ENT** Key. The cursor is now flashing in the VNV offset distance field.
- 10) Enter the desired distance before (-) or after (+) the along track offset waypoint.
- 11) Press the **ENT** Key. The 'Activate?' field is highlighted.
- 12) Press the **ENT** Key to activate.

## CLEARING VERTICAL CONSTRAINTS

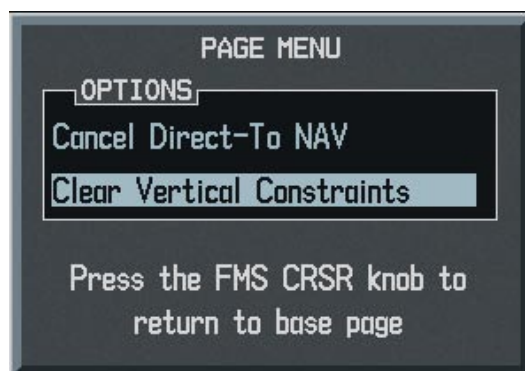

Figure 5-26 Clear Vertical Constraints

### Clearing a vertical constraint:

- 1) Press the **Direct-to** Key to display the Direct-to Window.
- 2) Press the **MENU** Key. With 'Clear Vertical Constraints' highlighted (Figure 5-26), press the **ENT** Key.

In addition to selecting a destination by an identifier, the Direct-to Window also allows the selection of airports, VORs and NDBs by facility or city name (Figure 5-27).

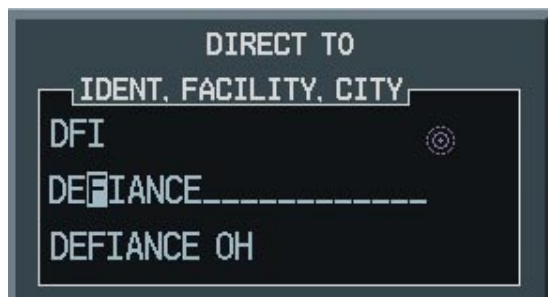

Figure 5-27 Entering a Facility Name

### Selecting a direct-to destination by facility or the name of a city:

- 1) Press the **Direct-to** Key. The Direct-to Window is displayed with the waypoint identifier field highlighted.
- 2) Highlight the facility or city name field.
- 3) Enter the facility or city location of the desired waypoint. If duplicate entries exist for the entered facility or city name, additional entries can be viewed by turning the small **FMS** Knob during the selection process.
- 4) Press the **ENT** Key to confirm the selected waypoint.
- 5) Press the **ENT** Key to activate a direct-to.

Any waypoint contained in the flight plan can be selected as a direct-to destination from the Direct-to Waypoint Window when navigating an active flight plan.



## SPECIFYING A COURSE TO A WAYPOINT

When navigating a direct-to, the G1000 sets a direct great circle course to the selected destination. The course to a destination can also be manually selected using the course field ('COURSE') on the Direct-to Waypoint Window.

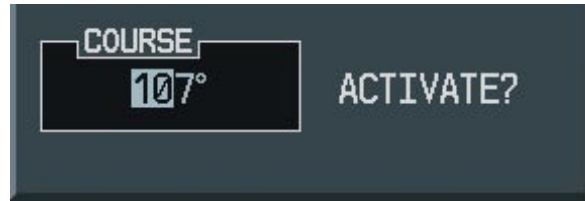

Figure 5-28 Entering a Direct-to Course

### Manually selecting a direct-to course:

- 1) Press the **Direct-to** Key. The Direct-to Window is displayed with the destination field highlighted.
- 2) Highlight the course field.
- 3) Enter the desired course (Figure 5-28).
- 4) Press the **ENT** Key twice to begin navigation using the selected destination and course.
- 5) To reselect a direct course from the present position (or select a new manually defined course) press the **Direct-to** Key. Press the **ENT** Key twice.

## CANCELING DIRECT-TO NAVIGATION

Once a direct-to is activated, the G1000 provides navigation guidance to the selected destination until the direct-to is either replaced with a new direct-to or flight plan, cancelled, or when the G1000 is powered off.

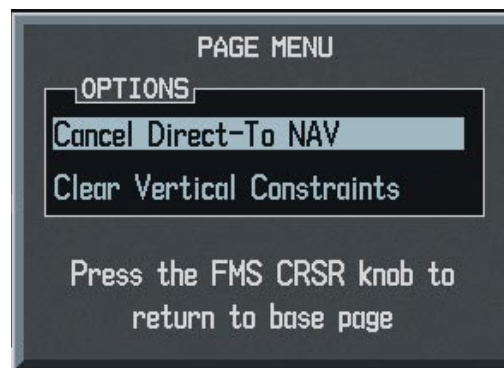

Figure 5-29 Cancel Direct-to Option

### Cancelling a direct-to:

- 1) Press the **Direct-to** Key to display the Direct-to Window. Press the **MENU** Key.
- 2) With 'Cancel Direct-To NAV' highlighted (Figure 5-29), press the **ENT** Key. If a flight plan is still active, the G1000 resumes navigating the flight plan along the closest leg.

## DIRECT-TO NAVIGATION SHORTCUTS

A direct-to can be performed from any page displaying a single waypoint identifier (such as the waypoint pages for airports and NAVAIDS) by simply pressing the **Direct-to** Key and the **ENT** Key. For pages that display a list of waypoints (e.g., the Nearest Airport Page), the desired waypoint must be highlighted with the cursor before pressing the **Direct-to** Key.

Direct-to destinations may also be selected from the Navigation Map Page by panning to the desired destination location, pressing the **Direct-to** Key, and then the **ENT** Key twice. If no airport, NAVAID or user waypoint exists at the desired location, a temporary waypoint named 'MAPWPT' is automatically created at the location of the Map Pointer.



### Selecting a direct-to destination from the Navigation Map Page:

- 1) From the Navigation Map Page, press the **Joystick** to display the Map Pointer.
- 2) Move the **Joystick** to place the Map Pointer at the desired destination location.
- 3) If the Map Pointer is placed on an existing airport, NAVAID, or user waypoint, the waypoint name is highlighted.
- 4) Press the **ENT** Key twice to navigate to the waypoint.
- 5) If the Map Pointer is placed on an open location, press the **Direct-to** Key.
- 6) Press the **ENT** Key twice to create a 'MAPWPT' waypoint and then navigate to it.

## DIRECT-TO NAVIGATION SHORTCUTS USING THE FMS KNOB

### Select a Direct-to Destination to a Flight Plan Waypoint

- 1) While navigating an active flight plan, press the **Direct-to** (D▶) Key.
- 2) Turn the small **FMS** Knob to the left to display a list of flight plan waypoints as shown in Figure 5-31.



Figure 5-31 Flight Plan Waypoint List (MFD)

- 3) Turn the large **FMS** Knob to select the desired waypoint.
- 4) Press the **ENT** Key. The cursor is now displayed on 'ACTIVATE?'.  
5) Press **ENT** again to activate a Direct-to.

### Select a Direct-to Destination to a Nearest Airport

- 1) Press the **Direct-to** (D▶) Key.
- 2) Turn the small **FMS** Knob to the left. Initially, a flight plan waypoint list is displayed as in Figure 5-32. The list is populated only when navigating a flight plan.



Figure 5-32 Nearest Airport List (MFD)

- 3) Turn the small **FMS** Knob to the right to display the 'NRST' airports to the aircraft's current position.
- 4) Turn the large **FMS** Knob to select the desired airport.

- 5) Press the **ENT** Key. The cursor is now displayed on 'ACTIVATE?'.
- 6) Press **ENT** again to activate a Direct-to.

### Select a Direct-to Destination to a Recently Entered Identifier

- 1) Press the **Direct-to** (D➤) Key.
- 2) Turn the small **FMS** Knob to the left. Initially, a flight plan waypoint list is displayed as in Figure 5-33. The list is populated only when navigating a flight plan.



Figure 5-33 Recently Entered Waypoints List (MFD)

- 3) Turn the small **FMS** Knob to the right to display the 'RECENT' waypoints as shown in Figure 5-33.
- 4) Turn the large **FMS** Knob to select the desired airport.
- 5) Press the **ENT** Key. The cursor is now displayed on 'ACTIVATE?'.
- 6) Press **ENT** again to activate a Direct-to.

## 5.6 DIRECT-TO-NAVIGATION (PFD)



**NOTE:** Section 5.3 describes the PFD Inset Map and PFD Windows. It is recommended that the user read this section before beginning GPS navigation operations on the PFD.



Figure 5-34 PFD Direct-to Window

- |                               |                        |
|-------------------------------|------------------------|
| ① Identifier                  | ⑥ City and State       |
| ② Facility Name               | ⑦ Along Track Offset   |
| ③ VNV Altitude Constraint     | ⑧ Distance to Waypoint |
| ④ Bearing From Waypoint       | ⑨ Waypoint Symbol      |
| ⑤ Course to Selected Waypoint |                        |

### OPERATIONS

A direct-to waypoint can be selected in the following ways:

- By identifier, waypoint location or facility name
- From a list of waypoints in the active flight plan
- From a list of 25 nearest airports

The PFD Direct-to window is enabled and disabled by pressing the **Direct-to** Key (D▶). The currently selected waypoint displays the information shown in Figure 5-34.

#### Direct-to Navigation from the PFD:

- 1) Select the **Direct-to** Key (D▶).
- 2) Turn the large **FMS** Knob to place the cursor in the desired selection field.

- 3) Turn the small **FMS** Knob to begin selecting the desired identifier, location, etc.
- 4) Press the **ENT** Key.
- 5) The cursor is now flashing on 'ACTIVATE?'. If no altitude constraint or course is desired, press the **ENT** Key to activate. To enter an altitude constraint, proceed to step 6.
- 6) Turn the large **FMS** Knob to place the cursor over the 'VNV' altitude field.

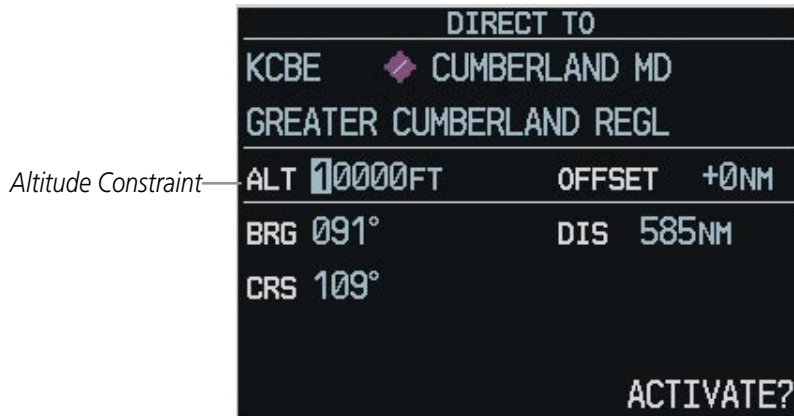

Figure 5-35 Entering Altitude Constraint

- 7) Turn the small **FMS** Knob to enter the desired VNV altitude.



Figure 5-36 Selecting Altitude Mode

- 8) Press the **ENT** Key. The option to select MSL or AGL is now displayed.
- 9) Turn the small **FMS** Knob to select 'MSL' or 'AGL'.
- 10) Press the **ENT** Key. The cursor is placed in the 'VNV' offset distance field.

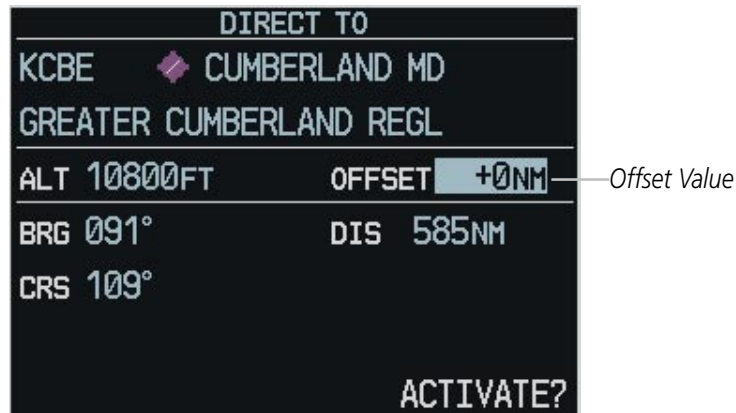

Figure 5-37 Entering Offset Value

- 11) Turn the small **FMS** Knob to enter the desired target altitude offset from the selected Direct-to.
- 12) Press the **ENT** Key to highlight 'Activate?' or turn the large **FMS** Knob to highlight the 'COURSE' field.
- 13) Turn the small **FMS** Knob to enter the desired course to the waypoint.
- 14) Press the **ENT** Key to highlight 'ACTIVATE?'.
- 15) Press the **ENT** again to activate the Direct-to.

#### Selecting a direct-to by city or facility name:

- 1) Press the **Direct-to** Key.
- 2) Highlight the city field (to the right of the identifier) or facility field (directly below the identifier) field.
- 3) Enter the city (to the right of the identifier field) or the facility (directly below the identifier field).
- 4) Once the desired city or facility name is displayed, press the **ENT** Key to confirm the selection.
- 5) Press the **ENT** Key to activate the direct-to.

#### Selecting a direct-to from a list of waypoints in an active flight plan:

- 1) Press the **Direct-to** Key.
- 2) Highlight the FPL field.
- 3) Turn the small **FMS** Knob to display a selection window showing all waypoints in the active flight plan.
- 4) Scroll through the list and highlight the desired waypoint.
- 5) Press the **ENT** Key twice to activate the direct-to.

#### Selecting a direct-to from the nearest airports list:

- 1) Press the **Direct-to** Key.
- 2) Highlight the NRST field.
- 3) Turn the small **FMS** Knob to display a selection window showing the 25 nearest airports.
- 4) Scroll through the list and highlight the desired airport.
- 5) Press the **ENT** Key twice to activate the direct-to.

**Selecting a specific course to a waypoint:**

- 1) Press the **Direct-to** Key.
- 2) Enter the desired destination waypoint.
- 3) Press the **ENT** Key.
- 4) Highlight the 'CRS' field.
- 5) Enter the desired course.
- 6) Press the **ENT** Key twice to activate the direct-to using the selected course to the destination.

**Clearing vertical constraints:**

- 1) Press the **Direct-to** Key.
- 2) Press the **MENU** Key to display the Direct-to Menu.
- 3) Select 'Clear Vertical Constraints' (Figure 5-38). Press the **ENT** Key.



Figure 5-38 Clear Vertical Constraints Menu Option

**Cancelling a direct-to:**

- 1) Press the **Direct-to** Key.
- 2) Press the **MENU** Key to display the Direct-to Menu.
- 3) Press the **ENT** Key to cancel direct-to navigation. If a flight plan is still active, the G1000 resumes navigating the flight plan along the closest leg of flight.



## 5.7 AIRPORT INFORMATION (MFD)



Figure 5-39 Airport Information Page

- |              |                           |
|--------------|---------------------------|
| ① Identifier | ⑥ Facility Name           |
| ② Location   | ⑦ Elevation               |
| ③ Region     | ⑧ Available Fuel Type     |
| ④ Position   | ⑨ Runway Information      |
| ⑤ UTC        | ⑩ COM and NAV Frequencies |

### Selecting the Airport Information Page (Figure 5-39):

- 1) Select the 'WPT' page group.
- 2) Select the first rectangular page icon.

### Selecting an airport by identifier, facility name, or city location:

- 1) With the Airport Information Page displayed, press the **FMS** Knob to activate the cursor.
- 2) Select the identifier, facility name or city location field.
- 3) Enter the desired identifier, facility name, or city location. Press the **ENT** Key.
- 4) To remove the flashing cursor, press the **FMS** Knob.

As an identifier, facility name or location is entered, the G1000's Spell'N'Find™ feature scrolls through the database, displaying those waypoints matching the characters which have been entered to that point. If duplicate entries exist for the entered facility name or location, additional entries may be viewed by continuing to turn the small **FMS** Knob during the selection process. If duplicate entries exist for an entered identifier, a duplicate waypoint appears once you select the identifier (Figure 5-40).

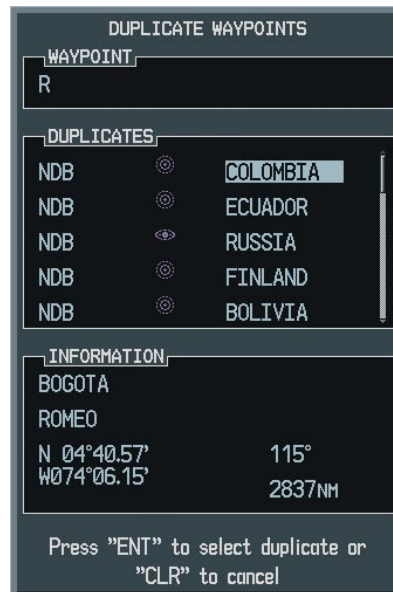

Figure 5-40 Duplicate Waypoints

**Loading a frequency in the standby COM or NAV window:**

- 1) With the Airport Information Page displayed, press the **FMS** Knob to activate the cursor.
- 2) Move the cursor to the Frequencies Box.
- 3) Turn the **FMS** Knob to scroll through the list, placing the cursor on the desired frequency. If a listed frequency has additional information for the pilot to view, the frequency is preceded by an info ('i') designation. Press the **ENT** Key to view the information. The following may be displayed with the frequency:
  - 'TX' – transmit only
  - 'RX' – receive only
  - 'PT' – part time frequency
  - 'i' – additional information exists, press the **ENT** Key
- 4) Press the **ENT** Key to place the selected frequency in the standby field of the COM or NAV window.
- 5) Press the **FMS** Knob to remove the cursor.

The Airport Frequencies field uses the descriptions and abbreviations listed in Table 5-2:

| Communication Frequencies Which May Include Additional Information | Communication Frequencies Without Additional Information | Navigation Frequencies |
|--|--|------------------------|
| Approach   | ATIS   | ILS                    |
| Arrival  | ASOS   | LOC                    |
| Class B  | AWOS   |                        |
| Class C  | Center   |                        |
| CTA  | Clearance  |                        |
| Departure  | Gate   |                        |
| TMA  | Control  |                        |
| Terminal   | Ground   |                        |
| TRSA   | Helicopter   |                        |
|  | Multicom   |                        |
|  | Pre-Taxi   |                        |
|  | Radar  |                        |
|  | Ramp   |                        |
|  | Other  |                        |
|  | Tower  |                        |
|  | Unicom   |                        |

**Table 5-2 Frequency Descriptions and Abbreviations**

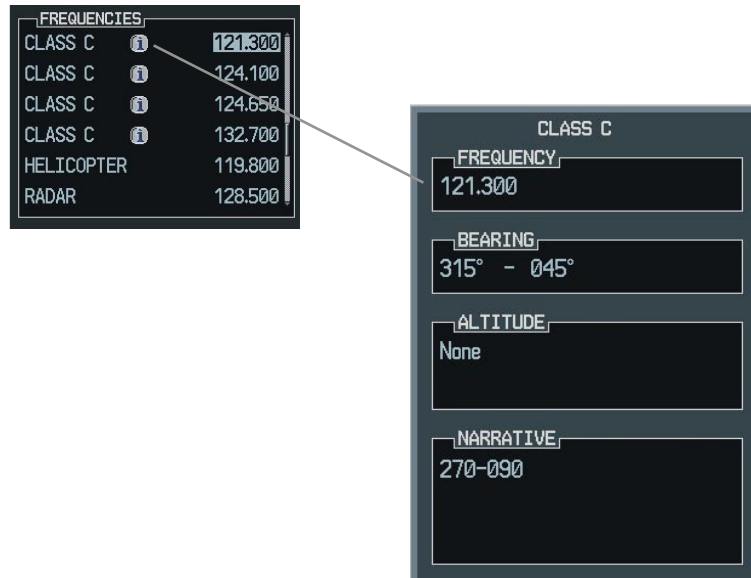

Figure 5-41 Viewing a Restriction

#### Loading a pilot control lighting frequency into selected COM standby frequency:

- 1) With the Airport Information Page displayed, press the **FMS** Knob to activate the cursor.
- 2) Move the cursor to the 'PCL FREQ' field in the Runways Window.
- 3) Press the **ENT** Key to place the PCL frequency in the standby field of the COM window.
- 4) Press the **FMS** Knob to remove the cursor.

The airport runway information field displays runway designations, length, surface type and lighting for the selected airport. A map image of the runway layout and surrounding area is also displayed on the Airport Information Page. The map image range is displayed in the lower left corner and is adjustable using the joystick. For airports with multiple runways, information for each runway is available.

**Displaying information for each additional runway:**

- 1) Press the **FMS** Knob to activate the cursor.
- 2) Place the cursor on the runway designation field.
- 3) Turn the small **FMS** Knob to display the next runways for the selected airport.
- 4) Select the desired runway.
- 5) Press the **FMS** Knob to remove the flashing cursor.
- 6) Turn the **Joystick** counterclockwise to select a lower range and rotate it clockwise to select a higher range.

The following descriptions and abbreviations are used on the airport runway information box:

- Type – Usage type: Public, Military, or Private
- Surface – Runway surface types include: Hard, Turf, Sealed, Gravel, Dirt, Soft, Unknown, or Water
- Lighting – Runway lighting types include: No Lights, Part Time, Full Time, Unknown, or Frequency (for pilot-controlled lighting)

**Selecting a runway:**

- 1) With the Airport Information Page displayed, press the **FMS** Knob to activate the cursor.
- 2) Place the cursor on the 'RUNWAYS' identifier field.
- 3) Turn the small **FMS** Knob to display the next runway for the selected airport. Continue turning the small **FMS** Knob to select the desired runway.
- 4) To remove the flashing cursor, press the **FMS** Knob.

**Creating user waypoints via the Airport Information Page Map:**

- 1) With the Airport Information Page displayed, push the **Joystick** to activate the panning function. The target pointer is displayed at the center of the map.
- 2) After placing the pointer at the desired position, press the **ENT** Key. The User Waypoint Information Page is now displayed with the captured position.
- 3) Enter a waypoint name.
- 4) Press the **ENT** Key to accept the selected name. The first reference waypoint field is highlighted.
- 5) If desired, enter the identifier of the reference waypoint and the radial and distance to the reference waypoint.
- 6) Press the **FMS** Knob to remove the flashing cursor.

## 5.8 INTERSECTION INFORMATION (MFD)



**NOTE:** The VOR displayed on the Intersection Information Page is the nearest VOR, not necessarily the VOR used to define the intersection.

The Intersection Information Page displays the following intersection information:

- Map of surrounding area
- Identifier
- Country and/or region (e.g. “N CEN USA”)
- Position
- Nearest VOR (e.g. identifier, symbol, radial angle, distance)
- Cyan triangular intersection symbol

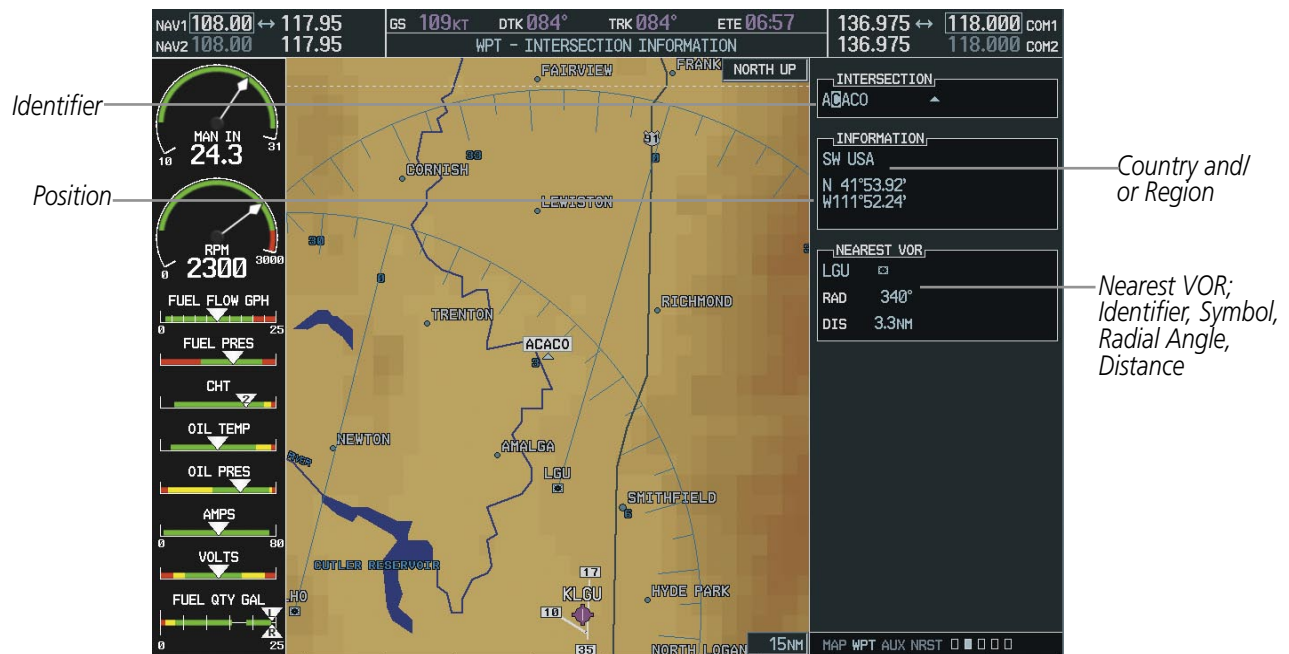

Figure 5-42 Intersection Information Page

The Intersection Information page allows the pilot to select an Intersection by selecting an identifier.

**Selecting an Intersection by identifier:**

- 1) With the Intersection Information Page displayed, press the **FMS** Knob to activate the cursor.
- 2) Enter a name for the identifier.
- 3) Press the **ENT** Key.
- 4) Press the **FMS** Knob to remove the flashing cursor.

## 5.9 NDB INFORMATION (MFD)

The NDB Information Page displays the following NDB information (Figure 5-43):

- Map of surrounding area
- Identifier
- Name
- City and/or State
- Facility name
- Position
- Frequency
- Nearest airport (e.g. identifier, symbol, bearing, distance)
- NDB symbol, depending on type (see the appendices for NDB and LOM symbols)
- Marker description

**Selecting the NDB Information Page:**

- 1) Select the WPT page group.
- 2) Select the third rectangular page icon.

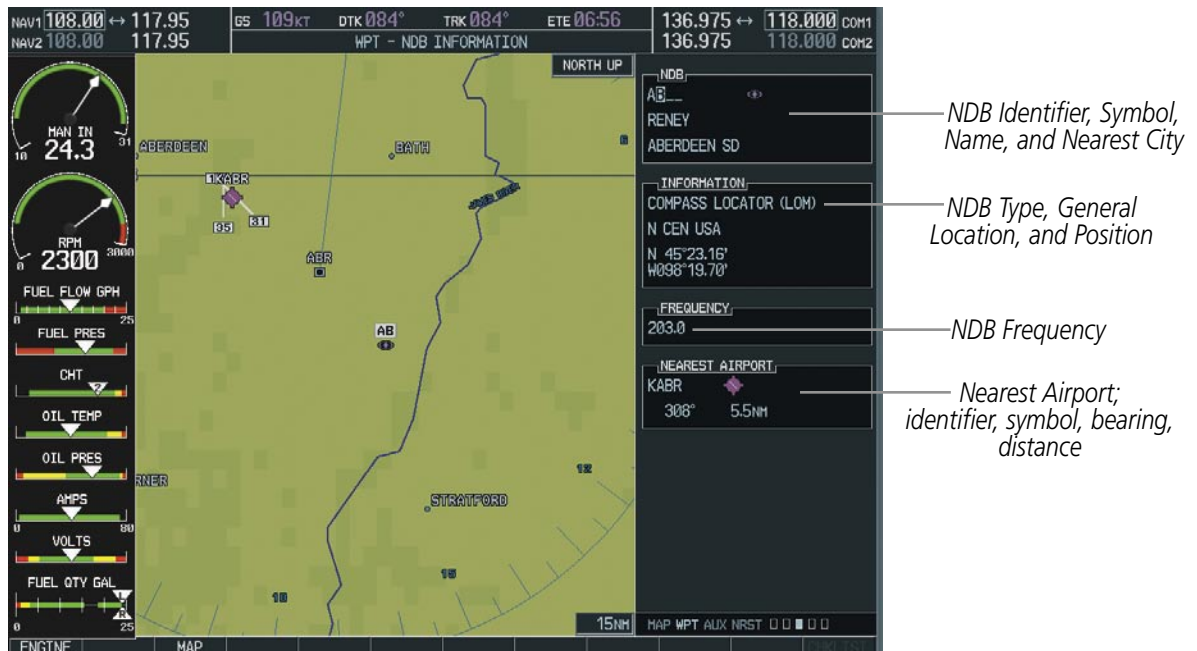

Figure 5-43 NDB Information Page

### Selecting a specific NDB:

- 1) With the NDB Information Page displayed, press the **FMS** Knob to activate the cursor.
- 2) Highlight the desired selection field (identifier, name or closest city).
- 3) Enter an identifier, name or city.
- 4) Press the **ENT** Key.
- 5) Press the **FMS** Knob to remove the flashing cursor.

If duplicate identifiers occur, a Duplicate Waypoints Menu pops up, from which the desired waypoint can be selected. When scrolling through the closest cities list to select an NDB, a city may appear more than once, depending on the number of NDBs near it.



## 5.10 VOR INFORMATION (MFD)

The following VOR Information is displayed on the MFD using the VOR information page (Figure 5-44):

- Map of surrounding area
- Identifier
- Name
- City/state
- Facility name
- Position
- Frequency
- Nearest airport (e.g. identifier, symbol, bearing, distance)
- Magnetic variation at VOR location
- VOR symbol, depending on type (VOR, VOR/DME, VOR/ILS, VORTAC, and TACAN) VOR class (e.g. LOW ALTITUDE, HIGH ALTITUDE, TERMINAL)



Figure 5-44 VOR Information Page

### Selecting the VOR Information Page:

- 1) Select the WPT page group.
- 2) Select the fourth rectangular page icon.

The VOR Information page allows the following operations:

- Selecting a VOR by identifier

- Selecting a VOR by name
- Selecting a VOR by city
- Selecting and loading of frequency into standby navigation box
- Returning to the previous page

**Selecting a VOR by Identifier, Name, or City:**

- 1) With the VOR Information Page displayed, press the **FMS** Knob to activate the cursor.
- 2) Highlight the desired selection field (identifier, name or closest city).
- 3) Enter an identifier, name or city.
- 4) Press the **ENT** Key.
- 5) Press the **FMS** Knob to remove the flashing cursor.

**Selecting and loading a VOR frequency:**

- 1) With the Nearest VOR Page displayed, select the **FREQ** Softkey to highlight the VOR frequency in the 'FREQUENCY' field.
- 2) Press the **ENT** Key. The selected VOR frequency is placed in the NAV standby frequency box.
- 3) Press the **FMS** Knob to remove the flashing cursor.

## 5.11 USER WAYPOINT INFORMATION (MFD)

### Selecting the User WPT Information Page (Figure 5-45):

- 1) Select the NRST page group.
- 2) Select the fifth rectangular page icon.

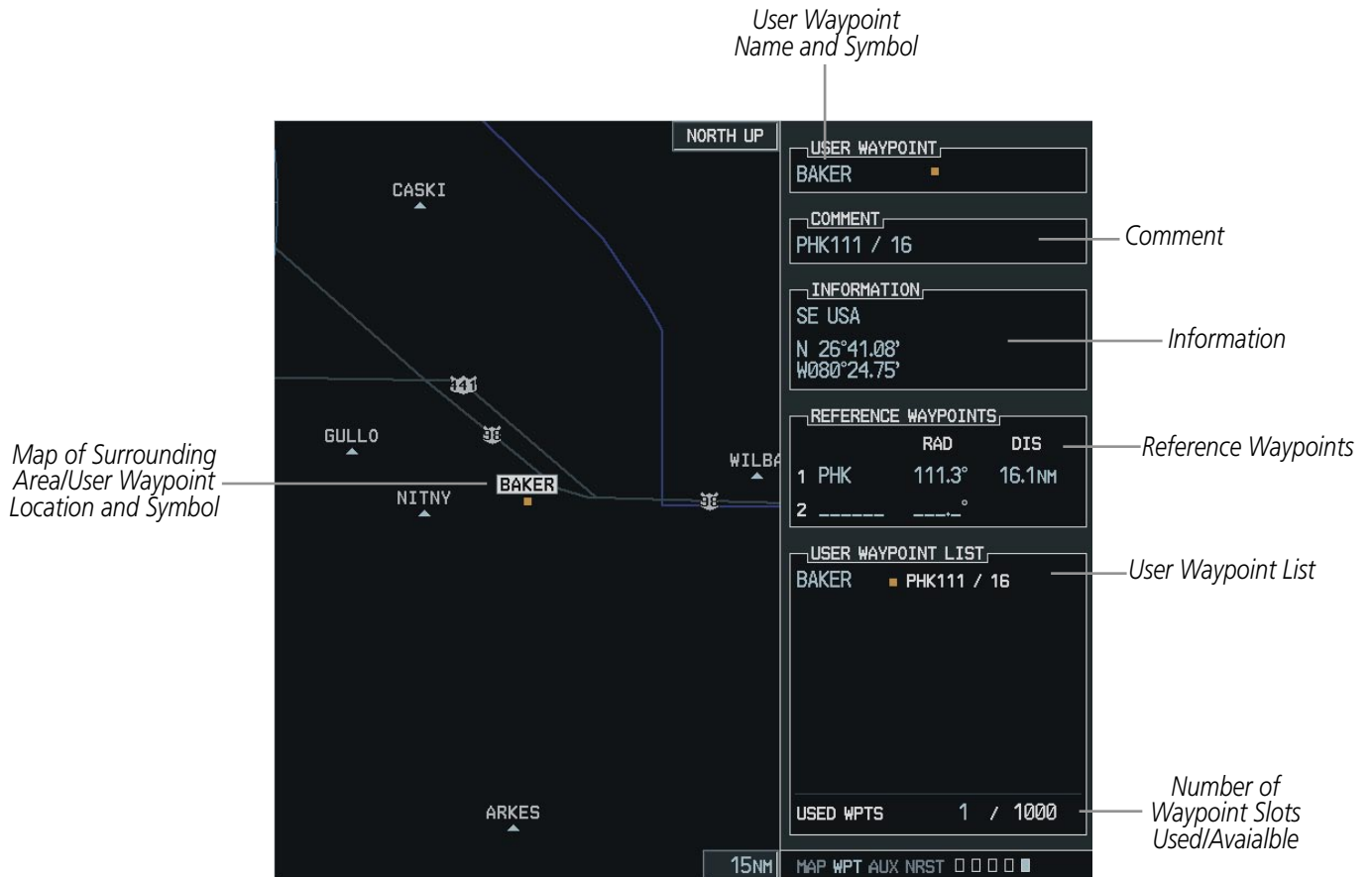

Figure 5-45 User Waypoint Information Page

User waypoints may be created from the User Waypoint Information Page or the Navigation Map Page. To create a new user waypoint from the User Waypoint Information Page, enter the name (identifier) and position, or reference another waypoint by radial and distance.

#### Creating a new user waypoint:

- 1) With the User Waypoint Information Page displayed, press the **FMS** Knob to activate the cursor.
- 2) Enter a name for the new waypoint.
- 3) Press the **ENT** Key. The message 'Are you sure you want to create the new user waypoint' is displayed.
- 4) With 'YES' highlighted, press the **ENT** Key.
- 5) Highlight the latitude/longitude field or the reference waypoints field, depending on how the waypoint is to be defined.

- 6) Enter the position coordinates or the radial and distance from the reference waypoint.
- 7) Press the **ENT** Key to accept the new waypoint.
- 8) Press the **FMS** Knob to remove the flashing cursor.

#### **Creating user waypoints from the Navigation Map Page:**

- 1) With the Navigation Map Page displayed, push the **Joystick** to activate the panning function. The Map Pointer is displayed at the present aircraft position.
- 2) After placing the pointer at the desired position, press the **ENT** Key. The User Waypoint Information Page is now displayed with the captured position.
- 3) Enter a waypoint name.
- 4) Press the **ENT** Key to accept the selected name. The first reference waypoint field is highlighted.
- 5) If desired, enter the identifier of the reference waypoint and the radial and distance to the reference waypoint.
- 6) Press the **ENT** Key to accept.
- 7) Press the **FMS** Knob to remove the flashing cursor.

#### **Modifying a user waypoint:**

- 1) With the User Waypoint Information Page displayed, press the **FMS** Knob to activate the cursor.
- 2) Move the cursor to the desired field.
- 3) Turn the small **FMS** Knob to make changes.
- 4) Press the **ENT** Key to accept the changes.
- 5) Press the **FMS** Knob to remove the flashing cursor.

**Deleting a user waypoint:**

- 1) Select the User Waypoint Information Page.
- 2) Press the **MENU** Key to display the User Waypoint Information Page options menu.
- 3) Select 'Delete User Waypoint'.
- 4) Press the **ENT** Key. The message 'Would you like to delete the user waypoint' is displayed.
- 5) With 'YES' highlighted, press the **ENT** Key.
- 4) Press the **ENT** Key.

**OR:**

- 1) Select the **DELETE** Softkey.
- 2) Press the **ENT** Key. The message 'Would you like to delete the user waypoint' is displayed.
- 3) With 'YES' highlighted, press the **ENT** Key.
- 4) Press the **ENT** Key.

**Deleting all user waypoints:**

- 1) Select the User Waypoint Information Page.
- 2) Press the **MENU** Key.
- 3) Select 'Delete All User Waypoints'
- 4) Press the **ENT** Key. A confirmation windows is displayed.
- 5) Press the **ENT** Key to accept 'YES' or highlight 'NO'.
- 6) Press the **ENT** Key.

'Present Position' when selected moves the currently selected user waypoint to the present position of the aircraft. The user waypoint is set to the airplane's position at the time when the option was selected.

**Moving the currently selected user waypoint to the present position of the aircraft:**

- 1) Select the User Waypoint Information Page and press the **MENU** Key.
- 2) Ensure waypoint is selected.
- 3) Select 'Use Present Position'.
- 4) Press the **ENT** Key.
- 5) Highlight the position and press the **ENT** Key.

'Auto Comment', when selected, overwrites the currently selected user waypoint comment with an automatically generated comment. Auto comments are in the same format as comments that are generated for user waypoints that have not specified unique user waypoint comments. The auto comment can be one of three styles:

- REF1BRG1 / DIS1 - if the user waypoint position is defined by a reference 1 waypoint radial and distance (this is generally the default case, but the default case could also be the blank case if there are no reference waypoints near the user waypoints position).
- REF1BRG1 / REF2BRG2 - if the user waypoint position is defined by a reference 1 waypoint radial and a reference 2 waypoint radial
- BLANK - if no reference waypoints are near the user waypoints position

#### **Overwriting the currently selected user waypoint's comment with an automatically generated comment:**

- 1) Select the desired waypoint on the User Waypoint Information Page.
- 2) Press the **MENU** Key. Select 'Auto Comment'.
- 3) Press the **ENT** Key.

'Create New Waypoint' creates a new user waypoint and 'Delete User Waypoint' deletes a user waypoint.

'Rename User Waypoint' renames a user waypoint.

#### **Renaming a user waypoint:**

- 1) Select the User Waypoint Information Page.
- 2) Press the **MENU** Key and select 'Rename User Waypoint'
- 3) Press the **ENT** Key.
- 3) The user waypoint field is highlighted. Rename the user waypoint.
- 4) Press the **ENT** Key.
- 5) The message 'Would you like to rename the user waypoint' is displayed. Select 'YES' to rename the new user waypoint.

#### **OR:**

- 1) Select the User Waypoint Information Page.
- 2) Select the **RENAME** Softkey.
- 3) The user waypoint field is highlighted. Rename the user waypoint.
- 4) Press the **ENT** Key.
- 5) The message 'Would you like to rename the user waypoint' is displayed. Select 'YES' to rename the new user waypoint.

## 5.12 NEAREST AIRPORTS (MFD)

Selecting the Nearest Airports Page (Figure 5-46):

- 1) Select the 'NRST' page group.
- 2) Select the first rectangular page icon.



Figure 5-46 Nearest Airports Page

### NEAREST AIRPORTS BOX

The Nearest Airports Box on the System Setup Page defines the minimum runway length and surface type used when determining the nine nearest airports to display on the MFD Nearest Airports Page. A minimum runway length and/or surface type can be entered to prevent airports with small runways or runways that are not of appropriate surface from being displayed. Default settings are 0 feet (or meters) for runway length and “any” for runway surface type.

Selecting nearest airport surface matching criteria (any, hard only, hard/soft, water):

- 1) Use the **FMS** Knob to select the System Setup Page.
- 2) Press the **FMS** Knob momentarily to activate the flashing cursor.
- 3) Turn the large **FMS** Knob to highlight the runway surface field in the Nearest Airports Box.
- 4) Turn the small **FMS** Knob to select the desired runway option (any, hard only, hard/soft, water).
- 5) Press the **ENT** Key.

**Selecting nearest airport minimum runway length matching criteria:**

- 1) Use the **FMS** Knob to select the System Setup Page.
- 2) Press the **FMS** Knob momentarily to activate the flashing cursor.
- 3) Turn the large **FMS** Knob to highlight the minimum length field in the Nearest Airport Box.
- 4) Use the **FMS** Knob to enter the minimum runway length (zero to 99,999 feet) and press the ENT Key.

**Selecting a nearest airport:**

- 1) With the Nearest Airport Page displayed, press the **FMS** Knob to activate the cursor.
- 2) Turn the **FMS** Knob to select the desired nearest airport.

**Accessing information for a specific airport:**

- 1) With the Nearest Airports Page displayed, select the **APT** Softkey or press the **FMS** Knob to place the cursor in the 'NEAREST AIRPORTS' field. The first airport in the nearest airports list is highlighted.
- 2) Press the **FMS** Knob.
- 3) Highlight the desired airport.
- 4) Press the **FMS** Knob to remove the flashing cursor.

**OR:**

- 1) With the Nearest Airports Page displayed, press the **MENU** Key.
- 2) Select the option 'Select Airport Window' and press the **ENT** Key. The cursor is placed in the 'NEAREST AIRPORTS' field.
- 3) Highlight the desired airport.
- 4) Press the **FMS** Knob to remove the flashing cursor.

**Accessing runway information for the selected airport:**

- 1) With the Nearest Airports Page displayed, select the **RNWX** Softkey to place the cursor in the 'RUNWAYS' field.
- 2) Select the desired runway.
- 3) Press the **FMS** Knob to remove the flashing cursor.

**OR:**

- 1) With the Nearest Airports Page displayed, press the **MENU** Key.
- 2) Select the option 'Select Runway Window' and press the **ENT** Key. The cursor is placed in the 'RUNWAYS' field.
- 3) Select the desired runway.
- 4) Press the **FMS** Knob to remove the flashing cursor.



**Quickly tuning the COM transceiver to a nearby airport frequency:**

- 1) With the Nearest Airports Page displayed, select the **FREQ** Softkey to place the cursor in the 'FREQUENCIES' field.
- 2) Turn either **FMS** Knob to select the desired frequency.
- 3) Press the **ENT** Key. The selected frequency is placed in the COM standby frequency tuning box.
- 4) Press the **Frequency Transfer** Key to place the frequency in the active field.
- 5) Press the **FMS** Knob to remove the flashing cursor.

**OR:**

- 1) With the Nearest Airports Page displayed, press the **MENU** Key.
- 2) Select the option 'Select Frequency Window' and press the **ENT** Key. The cursor is placed in the 'FREQUENCIES' field
- 3) Turn the **FMS** Knob to select the desired frequency.
- 4) Press the **ENT** Key. The selected frequency is placed in the COM standby frequency tuning box.
- 5) Press the **Frequency Transfer** Key to place the frequency in the active field.
- 6) Press the **FMS** Knob to remove the flashing cursor.



Figure 5-47 'Select Frequency Window' Option

## 5.13 NEAREST INTERSECTIONS (MFD)

### Selecting the Nearest Intersections Page (Figure 5-48):

- 1) Select the NRST page group. 'NRST' is displayed in the page group icon located in the lower right corner of the display.
- 2) Select the Nearest Intersections Page, the second page in the group.



Figure 5-48 Nearest Intersections Page

### Selecting a nearest intersection from the Nearest Intersections Page:

- 1) Press the **FMS** Knob to activate the cursor.
- 2) Select the desired intersection. The information on the Nearest Intersection Page pertains to the selected intersection.

## 5.14 NEAREST NDB (MFD)

### Selecting the Nearest NDB Page (Figure 5-49):

- 1) Select the NRST page group. 'NRST' is displayed in the page group icon located in the lower right corner of the display.
- 2) Select the Nearest NDB Page, the third page in the group.



Figure 5-49 Nearest NDB Page

### Selecting an NDB from the Nearest NDB Page:

- 1) Press the **FMS** Knob to activate the cursor.
- 2) Select the desired NDB. The information on the Nearest NDB Page pertains to the selected NDB.

## 5.15 NEAREST VOR (MFD)

Selecting the Nearest VOR Page (Figure 5-50):

- 1) Select the 'NRST' page group.
- 2) Select the fourth rectangular page icon.



Figure 5-50 Nearest VOR Page

Selecting a nearest VOR:

- 1) With the Nearest VOR Page displayed, press the **FMS** Knob to activate the cursor.
  - 2) Turn the **FMS** Knob to select the desired nearest VOR.
- OR:**
- 1) With the Nearest VOR Page displayed, select the **VOR** Softkey to place the cursor in the 'NEAREST VOR' window.
  - 2) Turn the **FMS** Knob to select a VOR.
  - 3) Press the **FMS** Knob to remove the flashing cursor.

**Selecting and loading a VOR frequency:**

- 1) With the Nearest VOR Page displayed, press the **FREQ** Softkey to highlight the VOR frequency in the 'FREQUENCY' field.
- 2) Press the **ENT** Key. The selected VOR frequency is placed in the NAV Standby Frequency Box.
- 3) Press the **FMS** Knob to remove the flashing cursor.

**Accessing information for a specific VOR:**

- 1) With the Nearest VOR Page displayed, press the **MENU** Key (Figure 5-51).
- 2) Select the option 'Select VOR Window' and press the **ENT** Key. The cursor is placed in the 'NEAREST VOR' field.
- 3) Highlight the desired VOR.
- 4) Press the **FMS** Knob to remove the flashing cursor.

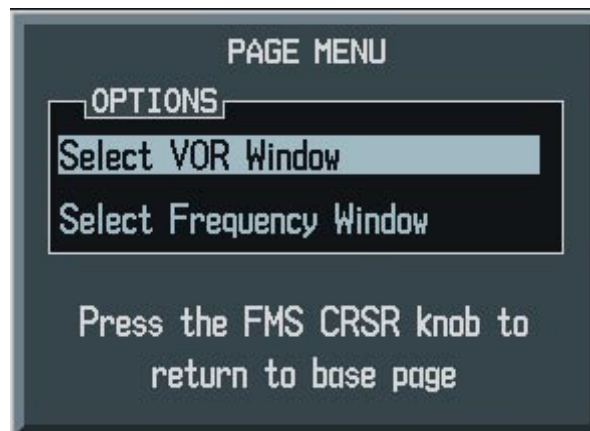

Figure 5-51 Nearest VOR Page Menu

**OR:**

- 1) With the Nearest VOR Page displayed, press the **MENU** Key.
- 2) Select the option 'Select Frequency Window' and press the **ENT** Key. The cursor is placed in the 'FREQUENCY' field.
- 3) Select the desired frequency.
- 4) Press the **FMS** Knob to remove the flashing cursor.

## 5.16 NEAREST USER WAYPOINT (MFD)

Selecting the Nearest User Waypoint Page (Figure 5-52):

- 1) Select the 'NRST' page group.
- 2) Select the fifth rectangular page icon.

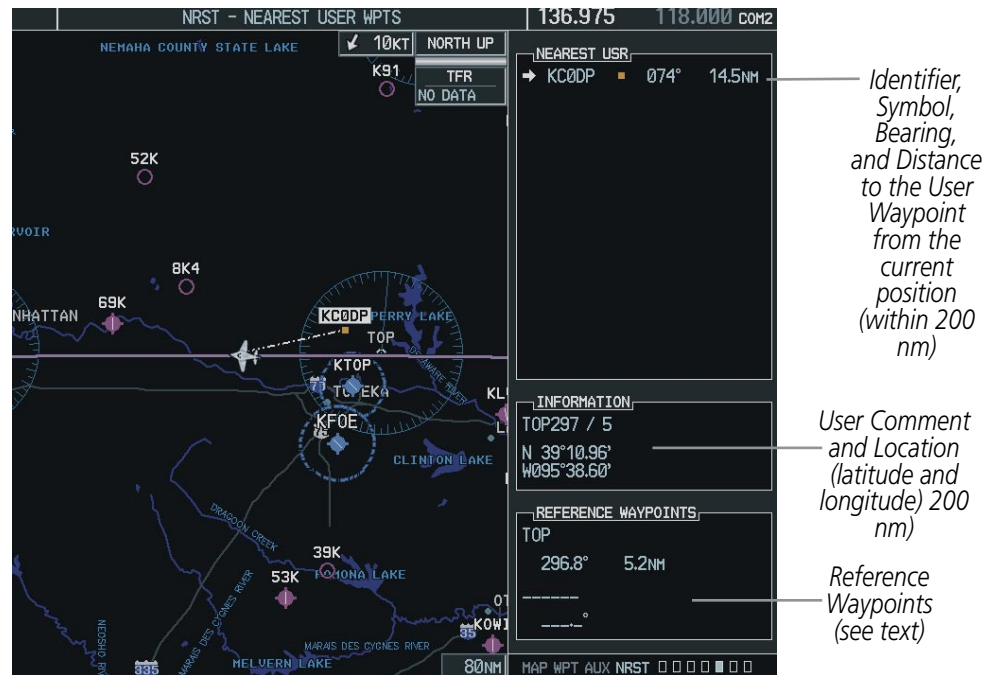

Figure 5-52 Nearest User Waypoint Page

The User Waypoint Page (Figure 5-52) displays a list of up to the 25 nearest user waypoints that are within 200 nm. Each list item includes the identifier, icon, bearing and distance to the user waypoint from the current position. An Map Pointer before the identifier indicates the selected user waypoint.

Up to eleven user waypoints are visible at a time. If more than eleven are available, there is an indication that the list can be scrolled down and/or up. If less than eleven the unused area matches the background color and the scroll bar is not visible. If there are no user waypoints in the list, text indicating that there are no nearest user waypoints is displayed.

Information about the selected user waypoint includes the user comment and location (latitude and longitude). If there are no user waypoints, the user comment is blank and the position data is dashed.

Reference Waypoints for the selected user waypoint are those specified when the user waypoint was created. If there is only one valid reference waypoint, the bearing and distance from the reference waypoint is stated and the second reference waypoint information is dashed. If there are no user waypoints or no valid reference waypoints, the reference waypoint fields are dashed.

If there are two valid reference waypoints, the bearings from the reference waypoints are stated and the first reference waypoint's distance field is dashed.

A map of the currently selected user waypoint and surrounding data is displayed which at a minimum shows the selected user waypoint and the current aircraft position. A line is drawn between the current position and the selected user waypoint.

**Selecting a nearest user waypoint:**

- 1) With the Nearest User Waypoint Page displayed, select the **FMS** Knob to activate the cursor. If any previously entered user waypoints are within 200 nm, these are displayed with the closest listed first.
- 2) Turn the **FMS** Knob to select the desired waypoint. The remaining information on the Nearest User Waypoint Page pertains to the selected Nearest User Waypoint.
- 3) Press the **FMS** Knob to remove the flashing cursor.

## 5.17 NEAREST FREQUENCIES (MFD)

Selecting the Nearest Frequencies Page (Figure 5-53):

- 1) Select the 'NRST' page group.
- 2) Select the sixth rectangular page icon.

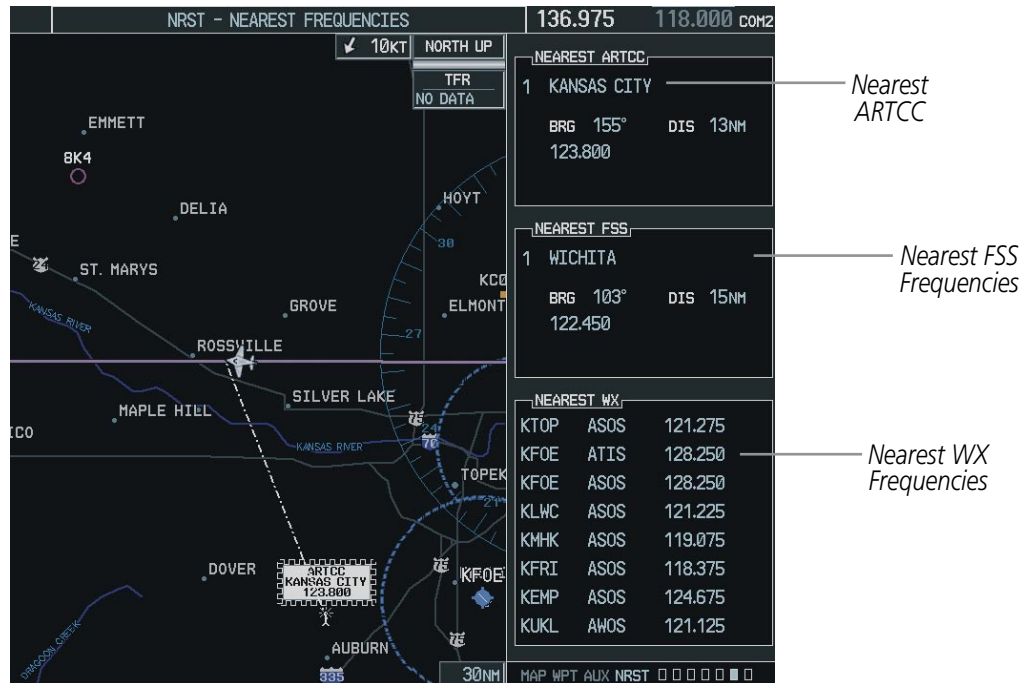

Figure 5-53 Nearest Frequencies Page

The Nearest Frequencies Page (Figure 5-53) displays a list of nearest ARTCCs. Only one ARTCC in the list is viewable at any given time and the user is able to change the currently viewed ARTCC. For each ARTCC the bearing, distance, and relevant frequencies are displayed. If there are more than two frequencies for any ARTCC then they are displayed inside of a scrollable list box with only two visible at any given time.

A list of nearest FSSs is displayed with only one FSS in the list viewable at any given time and the user is able to change the currently viewed FSS. For each FSS the bearing, distance, and relevant frequencies are displayed. If there is a NAV frequency for the given FSS then it is displayed in the list with its corresponding identifier so as to differentiate it from COM frequencies. If there are more than two frequencies of any type for a certain FSS then they are displayed inside of a scrollable list box with only two visible at any given time.

A list of nearest weather stations is displayed in a scrollable list box with a maximum of eight stations viewable at any time. Each line displays the call letters, type, and frequency of the given weather station.

A map of the currently selected item (ARTCC, FSS or weather station) and surrounding data, is displayed with a line between it and the current position. If there is no database loaded or if there are no stations in range, then any or all of the lists may be empty with the display indicating as such.



**Selecting a nearest ARTCC and frequency:**

- 1) With the Nearest Frequencies Page displayed, press the **FMS** Knob to activate the cursor.
- 2) Turn the small **FMS** Knob to select the desired nearest ARTCC.
- 3) Turn the large **FMS** Knob to select the desired ARTCC frequency.
- 4) Press the **ENT** Key to load the frequency into the COM frequency standby field.

**OR:**

- 1) With the Nearest ARTCC Page displayed, select the **ARTCC** Softkey to place the cursor in the 'NEAREST ARTCC' window.
- 2) Turn the small **FMS** Knob to select the desired nearest ARTCC.
- 3) Turn the large **FMS** Knob to select the desired ARTCC frequency.
- 4) Press the **ENT** Key to load the frequency into the COM frequency standby field.

**OR:**

- 1) With the Nearest Frequencies Page displayed, press the **MENU** Key (Figure 5-54).
- 2) Select the option 'Select ARTCC Window' and press the **ENT** Key. The cursor is placed in the 'NEAREST ARTCC' field.
- 3) Turn the small **FMS** Knob to select the desired nearest ARTCC.
- 4) Turn the large **FMS** Knob to select the desired ARTCC frequency.
- 5) Press the **ENT** Key to load the frequency into the COM frequency standby field.

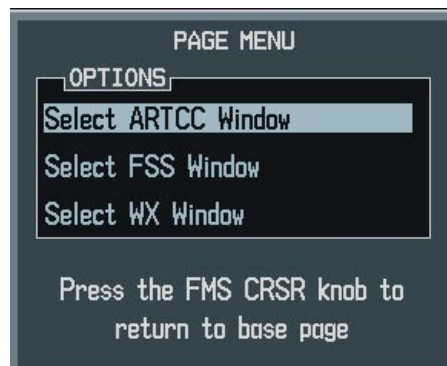

Figure 5-54 Nearest Frequencies Page Menu

**Selecting a nearest FSS and frequency:**

- 1) With the Nearest ARTCC Page displayed, select the **FSS** Softkey to place the cursor in the 'NEAREST FSS' window.
- 2) Turn the small **FMS** Knob to select the desired nearest FSS.
- 3) Turn the large **FMS** Knob to select the desired FSS frequency.
- 4) Press the **ENT** Key to load the frequency into the COM frequency standby field.

**OR:**

- 1) With the Nearest ARTCC Page displayed, press the **MENU** Key.
- 2) Select the option 'Select FSS Window' and press the **ENT** Key. The cursor is placed in the 'NEAREST FSS' window.
- 3) Turn the small **FMS** Knob to select the desired nearest FSS.
- 4) Turn the large **FMS** Knob to select the desired FSS frequency.
- 5) Press the **ENT** Key to load the FSS frequency into the COM frequency standby field.

**Selecting a nearest weather frequency:**

- 1) With the Nearest Frequencies Page displayed, select the **WX Softkey** to highlight the frequency in the 'WX FREQUENCY' field.
- 2) Turn the **FMS** Knob to select the desired weather frequency.
- 3) Press the **ENT** Key. The selected weather frequency is placed in the COM standby frequency field.
- 4) Press the **FMS** Knob to remove the flashing cursor.

**OR:**

- 1) With the Nearest ARTCC Page displayed, press the **MENU** Key.
- 2) Select the option 'Select WX Window' and press the **ENT** Key. The cursor is placed in the 'NEAREST WX window'.
- 3) Turn the **FMS** Knob to select the desired nearest WX frequency.
- 4) Press the **ENT** Key to load the WX frequency into the COM frequency standby field.
- 5) Press the **FMS** Knob to remove the flashing cursor.

## 5.18 NEAREST AIRSPACES (MFD)

The G1000 displays as many as nine controlled or special use airspaces (three at the most at one time) near or in the flight path. The airspace name, class, controlling agency, vertical limits and associated frequencies are displayed for the selected airspace.



**NOTE:** Softkeys and page menu options are the method for the user to switch between the airspace alerts box and the frequencies box, with the airspace alerts box being the default. The selection of these options are mutually exclusive and only one list is actively selectable at any given time. The **ALERTS** softkey is always displayed. If the **ALERTS** softkey is selected then the airspace alerts box becomes active and open to user selection.

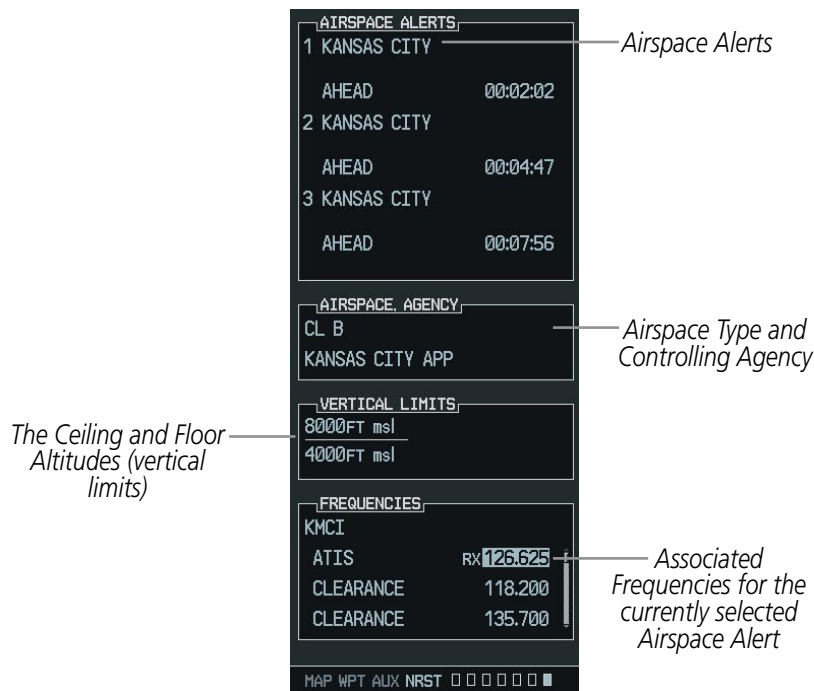

Figure 5-55 Nearest Airspaces Window

### Selecting and viewing an Airspace Alert with its associated information:

- 1) Select the Nearest Airspace Page by selecting the 'NRST;' page group and then select the seventh page in the group.
- 2) Select the **ALERTS** Softkey to place the cursor in the 'AIRSPACE ALERTS' box (Figure 5-55).
- 3) Select the desired airspace.
- 4) Press the **FMS** Knob to remove the flashing cursor.

**OR:**

- 1) With the Nearest Airspace Page displayed, press the **MENU** Key.
- 2) Highlight 'Select Alerts Window'.
- 3) Press the **ENT** Key. The cursor is placed in the 'AIRSPACE ALERTS' Box.
- 4) Select the desired airspace.
- 5) Press the **FMS** Knob to remove the flashing cursor.

**OR:**

- 1) With the Nearest Airspace Page displayed, press the **FMS** Knob. The cursor is placed in the 'AIRSPACE ALERTS' Box.
- 2) Select the desired airspace.
- 3) Press the **FMS** Knob to remove the flashing cursor.

## GENERAL NOTES ON AIRSPACE ALERTS

---

Once an airspace alert has been selected, associated information concerning the specific airspace is provided. The information includes Airspace Name, Status, and Time to Entry. The status and time to entry (if applicable) are based on the following conditions:

- If the projected course takes the aircraft inside an airspace within the next ten minutes, the status field shows the airspace as 'Ahead'.
- If the aircraft is within two nautical miles of an airspace and the current course takes the aircraft inside, the status field shows the airspace as 'Ahead < 2 nm'.
- If the aircraft is within two nautical miles of an airspace and the current course does not take the aircraft inside, the status field shows 'Within 2 nm'.
- If the aircraft has entered an airspace, the status field shows 'Inside'.

The airspace alerts are based on three-dimensional data (latitude, longitude, and altitude) to avoid nuisance alerts. The alert boundaries for controlled airspace are also sectorized to provide complete information on any nearby airspace. Once the described conditions exist, the status and time of entry is shown if the airspace alert messages are enabled on the System Setup Page. The Airspace Alerts Box allows the pilot to turn the controlled/special-use airspace message alerts on or off. This does not affect the alerts listed on the Nearest Airspaces Page or the airspace boundaries depicted on the Navigation Map Page. It simply turns on/off the warning provided when the aircraft is approaching or near an airspace. Alerts for the following airspaces can be turned on/off in the Airspace Alerts Box:

- Class B/TMA
- Class C/TCA
- Class D
- Restricted
- MOA (Military)
- Other airspaces

An altitude buffer is also provided which “expands” the vertical range above or below an airspace. For example, if the buffer is set at 500 feet, and the aircraft is more than 500 feet above/below an airspace, an alert message will not be generated, but if the aircraft is less than 500 feet above/below an airspace and projected to enter it, the pilot is notified with an alert message. The default setting for the altitude buffer is 200 feet.

**Changing the altitude buffer distance setting:**

- 1) Use the **FMS** Knob to select the AUX - System Setup Page.
- 2) Press the **FMS** Knob momentarily to activate the flashing cursor.
- 3) Turn the large **FMS** Knob to highlight the altitude buffer field in the Airspace Alerts Box.
- 4) Use the **FMS** Knob to enter an altitude buffer value and press the **ENT** Key.

**Turning an airspace alert on or off:**

- 1) Use the **FMS** Knob to select the AUX - System Setup Page.
- 2) Press the **FMS** Knob momentarily to activate the flashing cursor.
- 3) Turn the large **FMS** Knob to highlight the desired field in the Airspace Alerts Box.
- 4) Turn the small **FMS** Knob clockwise to turn the airspace alert ON or counterclockwise to turn the alert OFF.

At most three airspace alerts are displayed at any given time. The user can change the airspace alerts that are currently visible. For each airspace alert the name of the airspace, the proximity status (Inside, Ahead < 2nm, Ahead, Within 2nm), and the time until the current path of the aircraft intercepts the airspace (only when the airspace is Ahead, or Ahead < 2nm, otherwise “\_\_:\_\_:\_\_” is used) is displayed. If there are more than three airspace alerts they are displayed in a scrollable list box with only three visible at one time.

**AIRSPACE TYPE AND CONTROLLING AGENCY**

The following types of airspaces (information shown in the Airspace Agency Box, Figure 5-46) are on the Nearest Airspaces Page:

- ICAO control area
- Mode C tower area
- Alert area
- Caution area
- Danger area
- Prohibited area
- Restricted area
- Training area
- Unknown area
- Warning area
- Class B airspaces
- Class C airspaces
- Class D airspaces
- MOA airspaces

The Vertical Limits Box displays the floor and ceiling limits of the airspace alert. The following are examples of what may appear as vertical limits for an airspace:

- 5000 ft MSL (5,000 feet mean sea level)
- 5000 ft AGL (5,000 feet above ground level)
- MSL (at mean sea level)
- NOTAM (see Notice to Airmen)
- Unknown
- Unlimited
- See Chart
- Surface



---

**NOTE:** All airspace alerts, except for prohibited areas, may be turned on or off from the System Setup Page. An altitude buffer is also provided on the System Setup Page to provide an extra margin of safety above or below the published limits. See the System Overview Section for additional details.

---

The Vertical Limits Box section displays the floor and ceiling limits of the airspace alert. The following are examples of what may appear as vertical limits for an airspace:

- 5,000 ft MSL (5,000 feet mean sea level)
- 5,000 ft AGL (5,000 feet above ground level)
- MSL (at mean sea level)
- Notam (see Notice to Airmen)
- Unknown
- Unlimited
- See Chart
- Surface

**Selecting and quickly tuning an associated frequency for the currently selected airspace alert:**

- 1) Select the Nearest Airspaces Page.
- 2) Press the **FREQ** Softkey.
- 3) Select the desired frequency.
- 4) Press the **ENT** Key to load the frequency into the COM frequency standby field.
- 5) Press the **FMS** Knob to remove the flashing cursor.

**OR:**

- 1) Select the Nearest Airspaces Page.
- 2) Press the **MENU** Key.
- 3) Highlight 'Select Frequency Window'.
- 4) Press the **ENT** Key.
- 5) Select the desired frequency.
- 6) Press the **ENT** Key to load the frequency into the COM frequency standby field.
- 7) Press the **FMS** Knob to remove the flashing cursor.

### **GENERAL NOTES ON ASSOCIATED FREQUENCIES**

---

For each frequency the frequency type (ATIS, Ground, Tower, ILS, etc.) and the frequency are displayed on the same list row. For a frequency which has a "frequency information page", an "i" symbol is displayed on the list row between the frequency type and the frequency. If there are more than three frequencies for an airport waypoint index then they are displayed in a scrollable list box with only three visible at a time.

## 5.19 NEAREST AIRPORTS (PFD)

The Nearest Airports window on the PFD displays the 25 nearest airports along with the information shown in Figure 5-56:

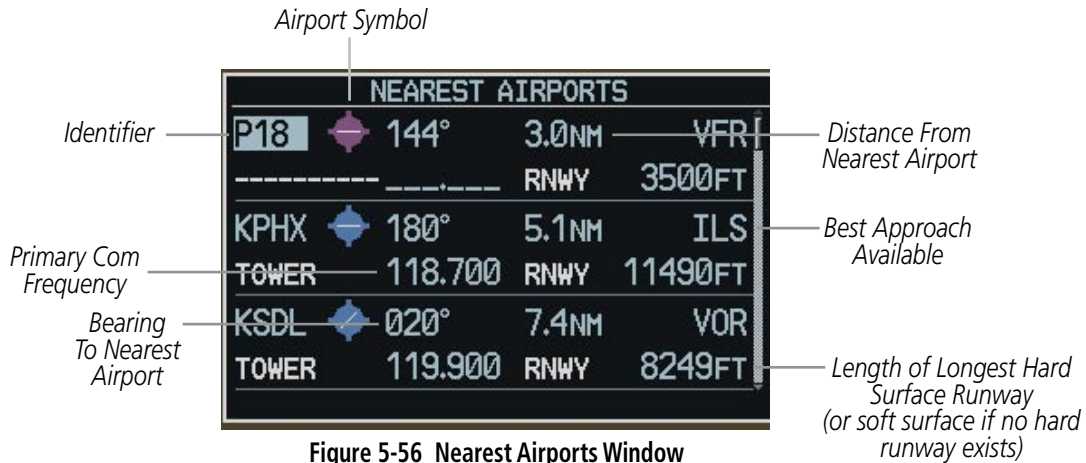

Figure 5-56 Nearest Airports Window

## OPERATIONS

The Nearest Airports Window is enabled and disabled by selecting the **NRST** Softkey. From the Nearest Airports Window, information for a selected airport can be viewed, the active primary communications frequency can be selected, and direct-to navigation can be activated.

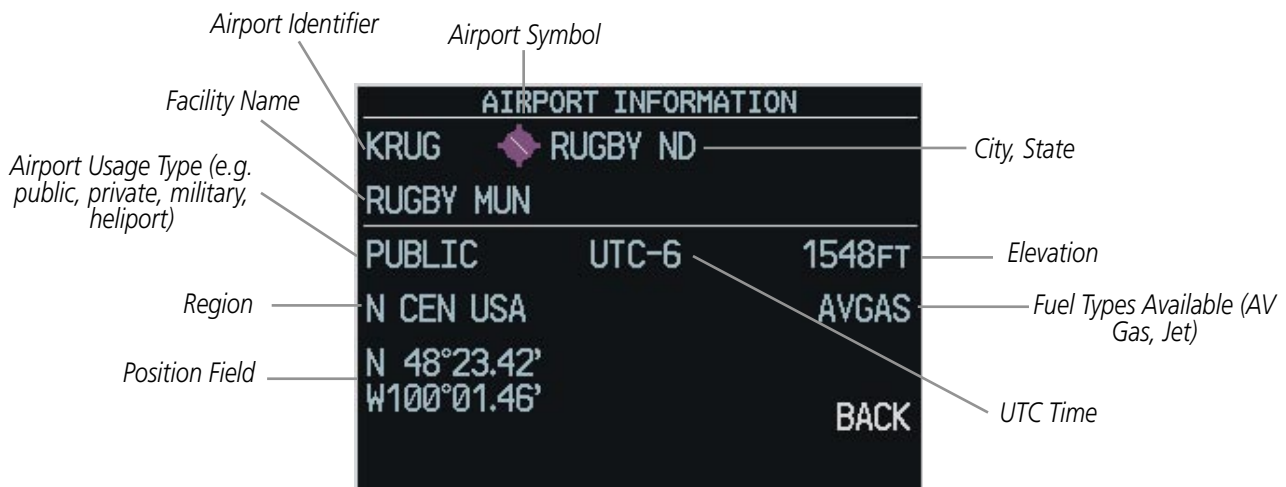

Figure 5-57 Airport Information Window



**Viewing information about an airport:**

- 1) Select the **NRST** Softkey to display a list of the nearest airports.
- 2) Select the desired airport.
- 3) Press the **ENT** Key.
- 4) The airport information is displayed with 'BACK' highlighted at the bottom of the window (Figure 5-58).
- 5) When finished viewing the airport information, press the **ENT** Key to return to the nearest airports list.

**Activating a direct-to:**

From the Nearest Airports Window, highlight the desired airport, then press the **Direct-to** Key. The Direct-to Window appears. Press the **ENT** Key twice to activate.



Figure 5-58 Airport Information Window

**Selecting a COM frequency:**

From the Nearest Airports Window, highlight the desired frequency, then press the **ENT** Key. The frequency is placed in the standby COM frequency field in the COM Tuning Box.



Figure 5-59 COM Frequency

## 5.20 FLIGHT PLANNING (MFD)

### FLIGHT PLANNING OPERATIONS

#### Creating a new flight plan:

- 1) From the Flight Plan Catalog Page, select the **NEW** Softkey. The Stored Flight Plan Page is displayed with a blank field for the first empty storage location.
- 2) Enter the identifier, facility, or city name of the departure waypoint (Figure 5-60).



Figure 5-60 Creating a Flight Plan

- 3) Press the **ENT** Key.
- 4) Enter the identifier for each additional flight plan waypoint.
- 5) Once all waypoints have been entered, press the **FMS** Knob to store the flight plan and return to the Flight Plan Catalog Window.

#### OR:

- 1) Press the **FPL** Key.
- 2) Turn the small **FMS** Knob to display the Flight Plan Catalog Window.
- 3) Press the **MENU** Key.
- 4) Highlight 'Create New Flight Plan'.
- 5) Press the **ENT** Key. The Stored Flight Plan Page is displayed. A blank flight plan page is displayed for the first empty storage location. Enter the identifier, facility, or city name of the departure waypoint and press the **ENT** Key.

- 6) Enter the identifier for each additional flight plan waypoint.
- 7) Once all waypoints have been entered, press the **FMS** Knob to store the flight plan and return to the Flight Plan Catalog Window.

**Viewing flight plan information:**

- 1) Select the Flight Plan Catalog Page.
- 2) Highlight the desired flight plan from the list.
- 3) The Flight Plan Information is displayed showing departure, destination, total distance, and enroute safe altitude information for the selected Flight Plan (Figure 5-61).

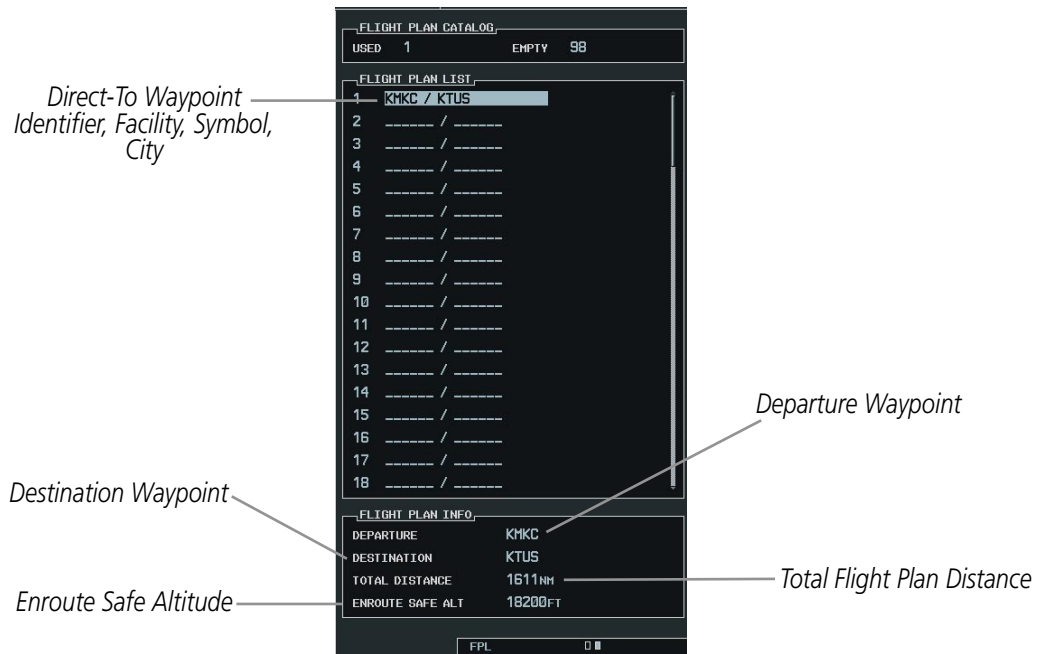

**Figure 5-61 Flight Plan Information**

**Adding a waypoint to a stored flight plan:**

- 1) From the Flight Plan Catalog Page, press the **FMS** Knob to activate the cursor.
- 2) Highlight the desired flight plan.
- 3) Select the **EDIT** Softkey.
- 4) To add a waypoint to the flight plan, select the point in the plan where the new waypoint is to be added. If an existing waypoint is highlighted, the new waypoint is placed directly in front of this waypoint.
- 5) Enter the identifier, facility, or city of the new waypoint.
- 6) Press the **ENT** Key. The new waypoint now exists in the flight plan.

**OR:**

- 1) From the Flight Plan Catalog Page, press the **FMS** Knob to activate the cursor.
- 2) Highlight the desired flight plan.
- 3) Press the **ENT** Key.
- 4) To add a waypoint to the flight plan, select the point in the plan where the new waypoint is to be added. If an existing waypoint is highlighted, the new waypoint is placed directly in front of this waypoint.
- 5) Enter the identifier, facility, or city of the new waypoint.
- 6) Press the **ENT** Key. The new waypoint now exists in the flight plan.

**Removing individual waypoints from the flight plan, except waypoints in the final approach segment:**

- 1) From the Active Flight Plan Window, select the waypoint that is to be deleted.
- 2) Press the **CLR** Key. A confirmation window is displayed listing the waypoint.
- 3) With 'OK' highlighted, press the **ENT** Key. To cancel the removal request, highlight 'CANCEL' and press the **ENT** Key.



Figure 5-62 Confirmation Window

**Switching waypoint data between leg-to-leg waypoint information and cumulative waypoint information:**

- 1) Press the **FPL** Key.
- 2) Select the **CUM** Softkey to view cumulative waypoint information or select the **LEG-LEG** Softkey to view leg-to-leg waypoint information (Figure 5-63).



Figure 5-63 Flight Plan Displaying Cumulative Distance

**Switching views between wide and narrow to show more or less leg data:**

- 1) Press the **FPL** Key.
- 2) Select the **WIDE** Softkey to view additional leg data or select the **NARROW** Softkey to less leg data.

### Changing the flight plan title:

- 1) Press the **FMS** Knob from the Active Flight Plan Page.
- 2) Highlight the Flight Plan Title Field.
- 3) Turn the **FMS** Knobs to change/edit the title (Figure 5-66).
- 4) Press the **ENT** Key. Note that title only changes on the Active Flight Planning page, not the Flight Planning Catalog page.

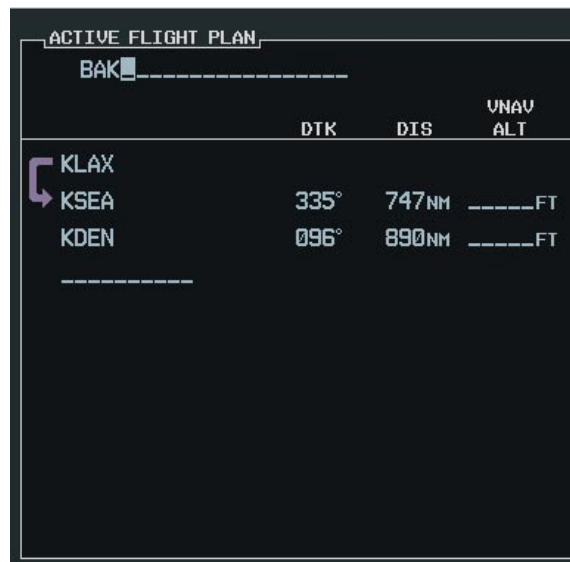

Figure 5-64 Flight Plan Title/Comment Field

'Activate Leg' selects the highlighted leg as the "active leg" (the flight plan leg which is currently used for navigation guidance).

### Activating a Flight Plan Leg:

- 1) From the Active Flight Plan Page, highlight the desired destination waypoint.
- 2) Select the **ACT LEG** Softkey. An 'Activate' window is displayed (Figure 5-65).
- 3) With 'Activate' highlighted, press the **ENT** Key. To cancel the operation, select 'CANCEL' and press the **ENT** Key.



Figure 5-65 Activate Window

OR:

- 1) From the Active Flight Plan Page, highlight the desired destination waypoint.
- 2) Press the **MENU** Key. Select 'Activate Leg' (Figure 5-66).
- 3) Press the **ENT** Key. An 'Activate' window is displayed.
- 4) With 'Activate' highlighted, press the **ENT** Key.



Figure 5-66 Activate Leg Menu Option

Whenever an approach, departure, or arrival is loaded into the active flight plan, a set of approach, departure or arrival waypoints is inserted into the flight plan along with a header line describing the instrument procedure the pilot selected. The original enroute portion of the flight plan remains active (unless an instrument procedure is activated) when the procedure is loaded.

Flight plans can also be stored with an approach, departure, or arrival. The active flight plan is erased when the system is turned off and overwritten when another flight plan is activated. When storing flight plans with an approach, departure or arrival, the G1000 uses the waypoint information from the current database to define the waypoints. If the database is changed or updated, the G1000 automatically updates the information if the procedure has not been modified. If an approach, departure or arrival procedure is no longer available, the procedure is deleted from the flight plan and an alert is displayed.

#### Storing an active flight plan from the Active Flight Plan Window:

- 1) Press the **MENU** Key.
- 2) Highlight 'Store Flight Plan'. Press the **ENT** Key.
- 3) With 'OK' highlighted, press the **ENT** Key. The flight plan is stored in the next available position in the flight plan list on the Flight Plan Catalog Page.



Figure 5-67 Store Confirmation Window

After navigating along a flight plan, the route can be reversed for navigation guidance back to the original departure waypoint.

#### Inverting and Activating a stored flight plan:

- 1) Highlight desired flight plan.
- 2) Select the **INVERT** Softkey from the Flight Plan Catalog Page. The 'Invert and activate stored flight plan?' Window is displayed.
- 3) With 'OK' highlighted, press the **ENT** Key. To cancel the operation, highlight 'CANCEL' and press the **ENT** Key.

#### OR:

- 1) Select the **FPL** Key.
- 2) Turn the small **FMS** Knob to display the Flight Plan Catalog Page.
- 3) Press the **FMS** Knob to activate the cursor.
- 4) Highlight the desired flight plan.
- 5) Press the **MENU** Key.
- 6) Highlight 'Invert & Activate FPL'.
- 7) Press the **ENT** Key. The 'Invert and activate stored flight plan?' Window is displayed.
- 8) With 'OK' highlighted, press the **ENT** Key. To cancel the operation, highlight 'CANCEL' and press the **ENT** Key.

'Closest Point of FPL' calculates the bearing and closest distance at which a flight plan passes from a reference waypoint. It can also be used to create a new user waypoint along the flight plan at the location closest to a chosen reference waypoint.

#### Determining the closest point along the active flight plan to a selected waypoint:

- 1) From the Active Flight Plan page, press the **MENU**.
- 2) Select 'Closest Point of FPL'.
- 3) Press the **ENT** Key. A window is displayed with the reference waypoint field highlighted.
- 4) Enter the identifier of the reference waypoint.
- 5) Press the **ENT** Key.
- 6) The G1000 displays the location, lat/lon, bearing (BRG), and distance (DIST) to the closest point along the flight plan from the selected reference waypoint. To create a user waypoint at this location and add it to the flight plan, highlight 'LOAD' and press the **ENT** Key. The name for the new user waypoint is derived from the identifier of the reference waypoint.



**Copying a stored flight plan into another storage slot:**

- 1) From the Flight Plan Catalog Page, press the **FMS** Knob to activate the cursor.
- 2) Highlight the desired flight plan.
- 3) Press the **MENU** Key.
- 4) Highlight 'Copy Flight Plan'.
- 5) Press the **ENT** Key. A 'Copy to flight plan?' confirmation window is displayed.
- 6) With 'OK' highlighted, press the **ENT** Key to copy the flight plan. To cancel, highlight 'CANCEL' and press the **ENT** Key.

**OR:**

- 1) From the Flight Catalog Page, press the **FMS** Knob to activate the cursor.
- 2) Highlight the desired flight plan.
- 3) Select the **COPY** Softkey. A 'Copy to flight plan?' confirmation window is displayed.
- 4) With 'OK' highlighted, press the **ENT** Key to copy the flight plan. To cancel, highlight 'CANCEL' and press the **ENT** Key.



**Figure 5-68 Active Flight Plan Page Wide View**

The 'Sort by Comment' menu option sorts flight plans alphanumerically based upon the comment assigned to each flight plan. Procedures on how to enter a comment (flight plan name) are described in the Active Flight Plan Window section.

**Sorting by comment (flight plan name):**

- 1) From the Flight Plan Catalog Page, select the **MENU** Key.

- 2) Highlight 'Sort By Comment' and press the **ENT** Key. A confirmation window is displayed.
- 3) With OK highlighted, press the **ENT** Key to change flight plan ordering. To cancel, highlight 'CANCEL' and press the **ENT** Key.

#### **Deleting a flight plan (stop navigating):**

- 1) From the Flight Plan Catalog Page, press the **FMS** Knob to activate the cursor.
- 2) Highlight the flight plan to delete.
- 2) Select the **MENU** Key.
- 3) Highlight 'Delete Flight Plan'.
- 4) Press the **ENT** Key. A 'Delete flight plan?' confirmation window is displayed.
- 5) With 'OK' highlighted, press the **ENT** Key to delete the flight plan. To cancel, highlight 'CANCEL' and press the **ENT** Key.

#### **OR:**

- 1) Highlight the desired destination waypoint.
- 2) Press the **DELETE** Softkey from the Flight Plan Catalog Page. A confirmation window is displayed.
- 3) With 'Activate' highlighted, press the **ENT** Key. To cancel the operation, select 'CANCEL' and press the **ENT** Key.

#### **OR:**

- 1) From the Active Flight Plan Page, press the **MENU** Key.
- 3) Highlight 'Delete Flight Plan'.
- 4) Press the **ENT** Key. A 'Delete flight plan?' confirmation window is displayed.
- 5) With 'OK' highlighted, press the **ENT** Key to delete the flight plan. To cancel, highlight 'CANCEL' and press the **ENT** Key.

**Deleting all stored flight plans:**

- 1) From the Flight Plan Catalog Page, press the **MENU** Key.
- 2) Highlight 'Delete All' and press the **ENT** Key. A 'Delete all flight plans?' confirmation window is displayed.
- 3) With 'OK' highlighted, press the **ENT** Key to delete all flight plans. To cancel, highlight 'CANCEL' and press the **ENT** Key.

**Creating user waypoints using the Active Flight Plan Page Map:**

- 1) With the Active Flight Plan Page displayed, push the **Joystick** to activate the panning function. The target pointer is displayed at the present aircraft position.
- 2) After placing the pointer at the desired position, press the **ENT** Key. The User Waypoint Information Window is displayed with the captured position. At this point, the User Waypoint is added to the flight plan list. If a waypoint in the list is highlighted, the new user waypoint is placed before that waypoint, if there is no highlight, the new user waypoint is placed at the end of the list.
- 3) Enter a waypoint name.
- 4) Select the **ENT** Key to accept the selected name. The first reference waypoint field is highlighted.
- 5) If desired, enter the identifier of the reference waypoint and the radial and distance to the reference waypoint.
- 6) Select the **ENT** Key to accept.
- 7) Press the **FMS** Knob to remove the flashing cursor.

## AUX - TRIP PLANNING PAGE

The Trip Planning Page (Figure 5-69) calculates information for the any selected flight plan or route and allows the pilot to manually analyze a future trip.



Figure 5-69 AUX-Trip Planning Page

The Trip Planning Page displays the following:

- An Inset Map showing the selected flight plan or flight leg. The map has an appropriate scale in order to see the selection.
- The selected flight plan number and selected leg number (if in flight plan mode). The selected leg number may be the entire flight plan.
- The selected start and end waypoints.
  - If in waypoint mode these are the selected waypoints.
  - If in flight plan mode with a specific leg selected then the waypoints shown are the endpoints of the selected leg.
  - If in flight plan mode with the entire flight plan selected then the waypoints shown are the start and end waypoints of the selected flight plan.
  - In automatic flight plan mode with active flight plan selected, the ‘from’ waypoint is the present position and the ‘to’ waypoint is the end of the selected leg.
- Departure time (DEP TIME) - This defaults to the current time
- Ground speed (GS)
- Fuel flow (FUEL FLOW)
- Fuel onboard (FUEL ONBOARD)

- Calibrated airspeed (CALIBRATED AS) - If in auto mode, the primary source of information is from the air data system, and the secondary source of information is the GPS ground speed.
- Indicated altitude (IND ALTITUDE) - If in auto mode, the primary source of information is the barometric altitude, and the secondary source of information is the GPS altitude.
- Barometric pressure (PRESSURE)
- Total air temperature (TOTAL AIR TEMP)

## TRIP STATISTICS (TRIP STATS)

---

- Desired track (DTK)
- Distance (DIS):
- Estimated time enroute (ETE). This time will either be shown as minutes:seconds, if the time enroute is less than an hour it is shown as hours:minutes.
- Estimated time of arrival (ETA).
- If in waypoint mode then the ETA is the ETE added to the departure time.
- If a flight plan other than the active flight plan is selected it shows the ETA by adding to the departure time all of the ETEs of the legs up to the selected leg. If the entire flight plan is selected, then the ETA is calculated as if the last leg of the flight plan was selected.
- If the active flight plan is selected the ETA reflects the current position of the aircraft and the current leg being flown. The ETA is calculated by adding to the current time the ETEs of the current leg up to the selected leg. If the entire flight plan is selected, then the ETA is calculated as if the last leg of the flight plan was selected.
- Enroute safe altitude (ESA). This value reflects either the ESA for the selected leg, for the route between two selected waypoints, or for the entire flight plan, depending on what is currently selected.
- Destination sunrise and sunset times (SUNRISE, SUNSET)

## FUEL STATISTICS (FUEL STATS)

---

- Fuel efficiency (EFFICIENCY)- This value is calculated by dividing the current ground speed by the current fuel flow.
- Time of fuel endurance (TOTAL ENDUR) - This time is shown as hours:minutes. This value is obtained by dividing the amount of fuel on board by the current fuel flow.
- Fuel on board upon reaching end of selected leg (REM FUEL) - This value is calculated by taking the amount of fuel onboard and subtracting the fuel required for trip.
- Fuel endurance remaining at end of selected leg (REM ENDUR) - This value is calculated by subtracting the time of fuel endurance by the amount of time to go.
- Fuel required for trip (FUEL REQ) - This value is calculated by multiplying the time to go by the fuel flow. See fuel endurance for an explanation of how time to go is calculated.
- Total range at entered fuel flow (TOTAL RANGE) - This value is calculated by multiplying the time of fuel endurance by the ground speed.

## OTHER STATISTICS (OTHER STATS)

---

- Density altitude (DENSITY ALT)
- True airspeed (TRUE AIRSPEED)
- Wind direction (WIND DIRECTION)
- Wind speed (WIND SPEED)
- Head wind (HEAD WIND; only if in Auto Mode). The head wind is shown as a tail wind value if appropriate

## TRIP PLANNING PAGE OPERATIONS

---

### AUTO MODE

Automatic mode is the simplest to use in flight, since in automatic mode the system enters current groundspeed, fuel flow, and remaining fuel on board automatically to calculate when the aircraft will arrive at the destination. In automatic mode, the G1000 also generates fuel statistics showing how much fuel will be remaining at arrival.

#### Selecting automatic mode:

- 1) Press the **AUTO** Softkeys.

#### OR:

- 1) Press the **MENU** Key. The Page Menu is displayed.
- 2) Select 'Auto Mode'.
- 3) Press the **ENT** Key.

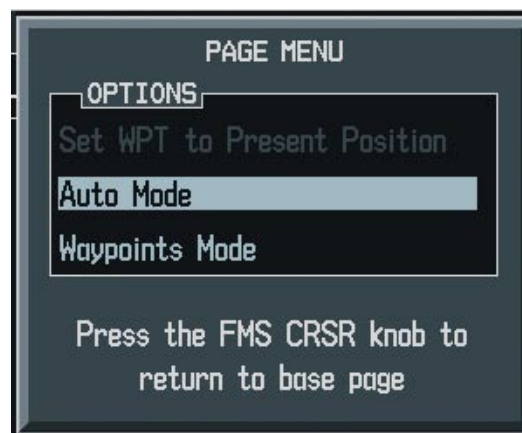

Figure 5-70 Trip Planning Page Menu

**Analyzing the active flight plan in auto mode:**

1) Press the **FPL** Softkey, and follow steps 2-7 below.

**OR:**

- 1) Press the **MENU** Key. The Page Menu is displayed.
- 2) Select 'Flight Plan Mode'.
- 3) Press the **ENT** Key.
- 4) Press the small **FMS** Knob to activate the cursor in the flight plan number field.
- 5) Turn the small **FMS** Knob to select the desired flight plan number. If 'CUM', (cumulative), is showing all the data shown in the 'TRIP STATS' box is for the entire flight plan.
- 6) If desired, turn the small **FMS** Knob to change the number of the stored flight plan being displayed.
- 7) Turn the large **FMS** Knob to highlight 'CUM'. The 'TRIP STATS' for each leg can be viewed by turning the small **FMS** Knob to select the desired leg. The Inset Map also displays the selected data.

In addition to analyzing flight plans, waypoints may be entered to analyze a flight plan segment:

- 1) Press the **WPTS** Softkey.
- 2) Use the FMS knob to enter the first and second waypoint.



**Figure 5-71 Waypoint Mode**

Or if the pilot wants to specify the present position as the first waypoint:

- 1) Press the **MENU** Key. The Page Menu is displayed.
- 2) Select 'Set WPT to Present Position'.
- 3) Use the **FMS** Knob to enter the second waypoint.

## MANUAL MODE

In manual mode, the pilot enters a variety of parameters to see the results.

- 1) Press the **MANUAL** Softkey.
- 2) Select a flight plan or waypoints as described in the auto mode section.
- 3) Turn the large **FMS** Knob to move the cursor and turn the small **FMS** knob to change any of the following values:
  - Departure time (DEP TIME)
  - Ground speed (GS)
  - Fuel flow (FUEL FLOW)
  - Fuel onboard (FUEL ONBOARD)
  - Calibrated airspeed (CALIBRATED AS)
  - Indicated altitude (IND ALTITUDE)
  - Barometric pressure (PRESSURE)
  - Total air temperature (TOTAL AIR TEMP)
- 3) Press the **ENT** Key to view the new TRIP, FUEL STATS, and OTHER STATS..

## UTILITY PAGE

---

The AUX-Utility Page (Figure 5-72) displays timers, trip statistics, and a scheduler.

### TIMERS AND DEPARTURE TIME

The Utility Page contains two timers, one a general purpose type, and one that records actual flight time. It also shows departure time.

#### To use the Generic Timer:

- 1) Press the **FMS** Knob and highlight the first Generic Timer field. Use the **FMS** knobs and select UP or DOWN.
- 2) Press the **ENT** Key. The second field is highlighted.
- 3) Press the **ENT** Key and select 'START?', 'STOP?', or 'RESET?'
- 4) Once the selection is made, press the **ENT** Key.
- 5) Highlight the third field and use the **FMS** Knob to preset the counter with the desired starting time.





Figure 5-72 AUX-Utility Page

**To use the Flight Timer:**

- 1) Press the **FMS** Knob and highlight the first Flight Timer field.
- 2) Use the small **FMS** Knob to select 'PWR-ON' or 'IN-AIR'.
- 3) Once the selection made, press the **ENT** Key.
- 4) Highlight the third field and use the **FMS** Knobs to preset the counter with desired starting time.
- 5) Press the **ENT** Key.

**To select departure time criteria**

- 1) Press the **FMS** Knob and highlight the first Departure Time Field.
- 2) Use the small **FMS** Knob to select 'PWR-ON' or 'IN-AIR'.
- 3) Press the **ENT** Key.

**RESETTING OPTIONS**

The Pilot can reset the following items using the Utility Page Options Menu (Figure 5-73):

- Flight Timer
- Departure Time
- Trip Odometer/Average Ground Speed
- Odometer
- Maximum Speed
- All



Figure 5-73 Utility Page Options Menu

**To reset any of the items:**

- 1) Press the **MENU** Key.
- 2) Select the desired reset option.
- 3) Press the **ENT** Key.

## TRIP STATISTICS

The following items are displayed in the 'TRIP STATISTICS' Box:

- ODOMETER
- TRIP ODOMETER
- TRIP AVERAGE GS (GROUND SPEED)
- MAXIMUM GS (GROUND SPEED)

**To reset any of trip statistic item:**

- 1) Press the **MENU** Key
- 2) Select the desired option.
- 3) Press the **ENT** Key.

## SCHEDULER

The scheduler portion of the Utility Page allows the pilot to program reminder messages based on elapsed time or a particular time and date.

Time-based messages can be periodic. Event messages are based on specific date and month. The scheduler uses GPS time so it should not be used for events such as oil changes (tach time). When an event is due, the ALERTS Softkey on the PFD flashes. Pressing the softkey displays the message programmed into the scheduler.

### To use the scheduler:

- 1) Press the **FMS** Knob.
- 2) Highlight the first blank message field.
- 3) Use the **FMS** Knobs and enter reminder message (up to 20 characters allowed).
- 4) Press the **ENT** Key.
- 5) Highlight the TYPE field. Select one of the following:
  - Event: single message based on time and date
  - One Time: occurs after time expires each time G1000 powers on.
  - Periodic: recurs based on the amount of time specified
- 6) Highlight the next field and enter a date and time for a single message, one time event, or a periodic event.
- 7) Press the **ENT** Key. For one time and periodic events, the REM field displays the time remaining before the message is displayed.

## AIRWAYS/JETWAYS

**NOTE:** Refer to the Navigation Map Page setup section for details on how to customize the display of airways on the MFD.

Airways (called Low Altitude Airways in the G1000 and in this Pilot's Guide) serve primarily smaller piston-engine, propeller-driven airplanes on shorter routes and at lower altitudes. Airways start at 1,200 feet above ground level (AGL) and extend upward to an altitude of 18,000 feet mean sea level (MSL). Airways are 8 nautical miles wide. Airways are called "Victor" airways, because they run primarily between VORs, and the phonetic alphabet's term for "V" is Victor. Airways have names like V222 or V37.

Jetways (called High Altitude Airways in the G1000 and in this Pilot's Guide) are actually called jet routes, and serve primarily airliners, jets, turboprops, and turbocharged piston aircraft operating over longer distances above altitudes of 18,000 feet. Jet routes start at 18,000 feet mean sea level (MSL) and extend upward to an altitude of 45,000 feet MSL (altitudes above 18,000 feet are called "flight levels" and are described as FL450 for 45,000 feet MSL). Jet routes have names like J42 or J121.

**NOTE:** Airways are not selectable for display on the PFD Inset Map. The window is too small to be useful for this purpose.

The **AIRWAYS** Softkey allows the display of airways to be turned on or off. The softkey takes on one of four conditions to allow high and low altitude airways to be displayed in any combination.

In addition, an Airways group is a part of the map setup which allows an alternate method of selecting airways for the display as well as adjustment of maximum ranges for which high altitude and low altitude airways are shown. See the Map Setup section for more details.

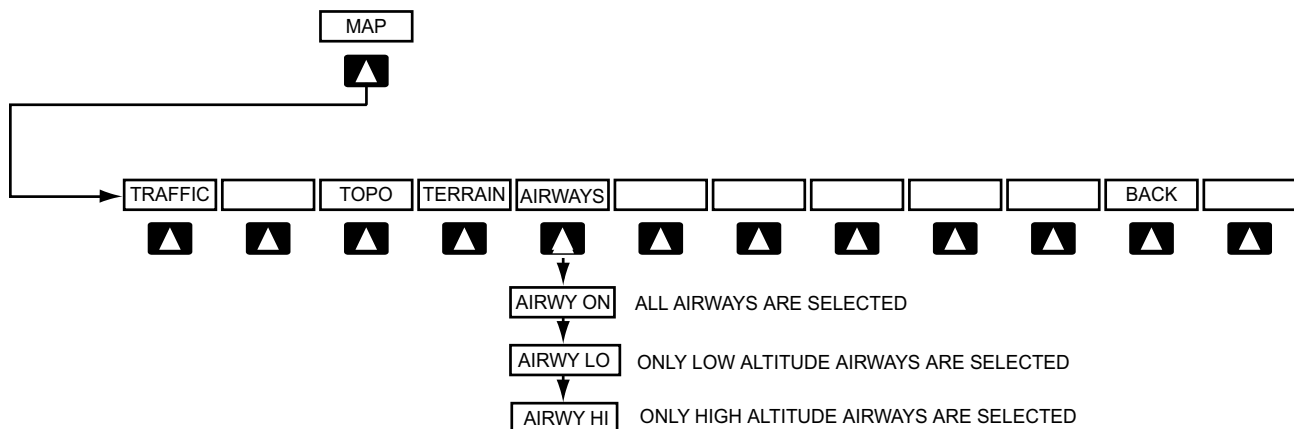

Figure 5-69 Airway Softkeys

After selecting the desired airway for display, it can be loaded into a flight plan. Loading an airway into a flight plan is done in six steps as follows:

1. Select the airway insertion point on the original flight plan
2. Access the Airway Loading Page
3. Select an airway from a list
4. Select an exit waypoint from a list
5. Preview the sequence of waypoints
6. Load the selected airway segment into the flight plan

**Select the airway insertion point on the original flight plan:**

Move the cursor to the spot after the desired airway entry waypoint. In the example given in Figure 5-74, join an airway after ANX, so the cursor is moved to the line just beyond ANX (which is over waypoint FRANC).



Figure 5-74 Airway Insertion Point

**Access the Airway Loading Page:**

Press the **MENU** Key and select "Load Airway" from the Flight Plan Page Menu (Figure 5-75).

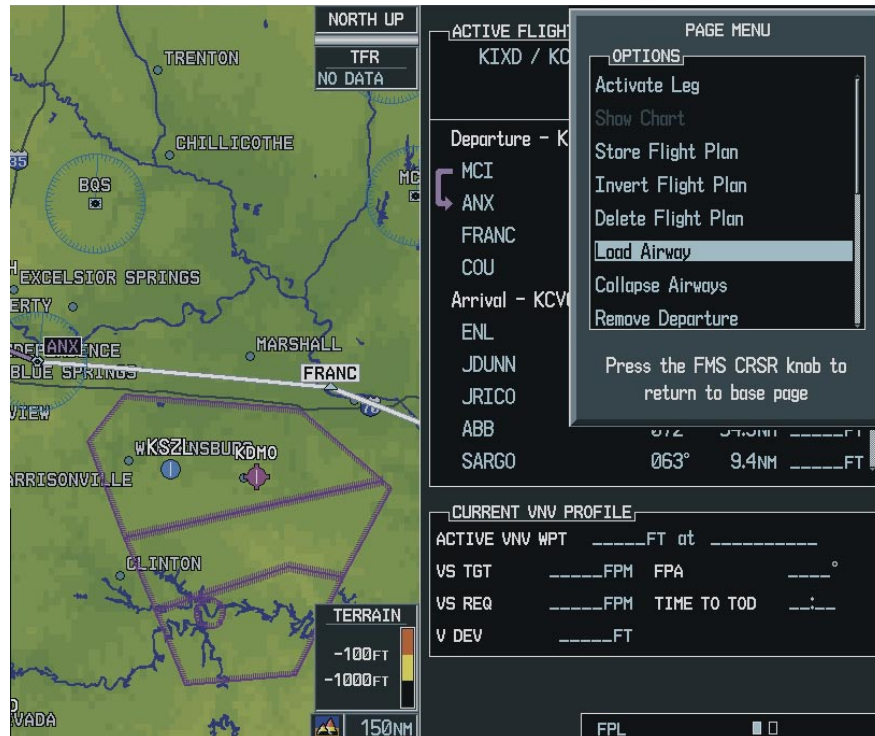

Figure 5-75 Load Airway Menu Option

Note: the “Load Airway” menu item is selectable only when an acceptable airway entry waypoint has been indicated (the waypoint ahead of the cursor position). Thus the “Load Airway” menu item is disabled in the following instances:

- An airway entry waypoint has not been established (there is no waypoint ahead of the cursor position)
- The airway entry waypoint is on an arrival or an approach procedure (it is OK if the airway insertion point is on a departure or an airway)
- There are no selectable airways in the database starting from the airway entry waypoint.

#### Select an Airway from the list:

Use the **FMS** Knob and the **ENT** Key to select one of the airways from the list (V12 in this example).

Whenever the Airway Loading Page is accessed, it is initialized to select the airway from the list of airways available from the selected airway entry point. In the example, there are seven airways selectable given the entry waypoint (ANX). The Airway Loading page selects an airway and exit waypoint based on the waypoints that are already in the flight plan.



Figure 5-76 Selecting an Airway

The Airway Loading Page provides the list of the airways that are selectable from the airway entry waypoint. The list of airways is sorted such that low altitude airways are presented at the top of the list, followed by “all” altitude airways, followed by high altitude airways. In this example, only low altitude airways are available at ANX.

On the airway list, the cursor is placed initially over an airway identifier selected by the system as follows:

- The system compares the list of airways selectable at the airway entry waypoint with the airways connecting with subsequent waypoints in the flight plan up to and including the first waypoint of the arrival or approach. If common airways exist, the airway that connects to the last waypoint in the flight plan is nominated.
- Otherwise, the cursor is positioned over the first airway on the list.

In the example, V12 is auto-selected because COU is the last waypoint in the flight plan on an airway that is selectable from ANX (V12). If we were loading the airway from FRANC we get the same result (V12-COU). If we were loading the airway from COU, V44 would be nominated because V44 (which is selectable from COU but not from ANX or FRANC) connects to the first waypoint in the arrival (ENL).

#### Select an exit waypoint from a list:

Use the **FMS** Knob and the **ENT** Key to select one of the exit waypoints from the list (TOY in this example).

The Airway Loading Window goes to this step immediately after the airway has been selected.

The Airway Loading Window provides a list of the available airway exit waypoints.

On the airway exit waypoint list, the cursor is placed initially over a waypoint nominated by the system.

Auto-selection of an exit waypoint is similar to the process of auto-selecting an airway (based on connecting with a waypoint later in the flight plan) except that the choice of airway is now constrained.

The list of airway exit waypoints is presented such that the waypoint nominated by the system is displayed below the selected entry waypoint (this could be opposite of the order that the waypoints occur in the database).

If there is no connecting waypoint that can be nominated based on the existing flight plan, the system tries to present the list of airway waypoints in the order most consistent with the direction of the existing flight plan and nominates the next airway waypoint after the entry waypoint.

If the list of waypoints is large enough that the list box must be scrolled, the list box is initially arranged such that the waypoint nominated by the system is as near the middle of the scroll box as practical (this allows adjacent waypoints on both sides of the nominated waypoint).

The entry waypoint is also shown on the list of exit waypoints but is not selectable.



Figure 5-77 Selecting an Exit Waypoint

In the example, airway V12 has 92 selectable waypoints on the segment that includes ANX, FRANC and COU. The list box is initialized to show 19 of those waypoints centered on COU which is the waypoint initially nominated by the system.



### PREVIEWING THE SEQUENCE OF WAYPOINTS

The airway segment is previewed during the course of selecting the exit waypoint. The preview consists of a graphical preview of the selected airway segment presented in the map display window as well as a text listing of the waypoint sequence with courses and distances shown in the Airway Loading window. The preview updates as the cursor is moved up or down over the list of exit waypoints. In this example, the pilot has moved the cursor down from COU to TOY which updates the graphical preview.



Figure 5-78 Previewing the Waypoint Sequence

The **FMS** Knob and the **ENT** Key are to select an exit waypoint from the list (TOY in this example).

If necessary, the cursor can be moved back to either the Airway or Exit waypoint fields to change the selected airway segment. Otherwise, press the **ENT** Key with the cursor over the LOAD prompt to load the airway into the flight plan.



**Figure 5-79 Loading the Airway into the Flight Plan**

Not all of the waypoints available in the database for an airway are actually needed to define the route. All of the airway waypoints are made available to choose as an exit waypoint, but when the airway is actually loaded into the flight plan, the “optional” waypoints are not included.

For the purpose of this discussion, “optional” waypoints on an airway are those waypoints that meet all of the following criteria:

- The waypoint is not a NAVAID (VOR or NDB)
- The waypoint is not needed to define a course change
- The waypoint is not an ATC compulsory reporting point

In the example, airway V12 was loaded after entry waypoint ANX ending with exit waypoint TOY. There are a total of 10 waypoints available in that segment: ANX, OCTAM, FRANC, HUCKS, COU, STITH, FTZ, AUGST, SNYDR and TOY, however only 5 are actually needed to define the route: ANX, FRANC, COU, FTZ and TOY.

It is possible that one of the “optional” waypoints (OCTAM, HUCKS, STITH, AUGST or SNYDR) could be needed later - see the discussion of inserting airway optional waypoints below for more about that.

When the **ENT** Key is pressed with the cursor over the LOAD prompt on the Airway Loading Page, the selected airway segment is loaded into the flight plan. The system returns to the Flight Plan Page with the cursor position placed on the line just after the exit waypoint of the airway segment.

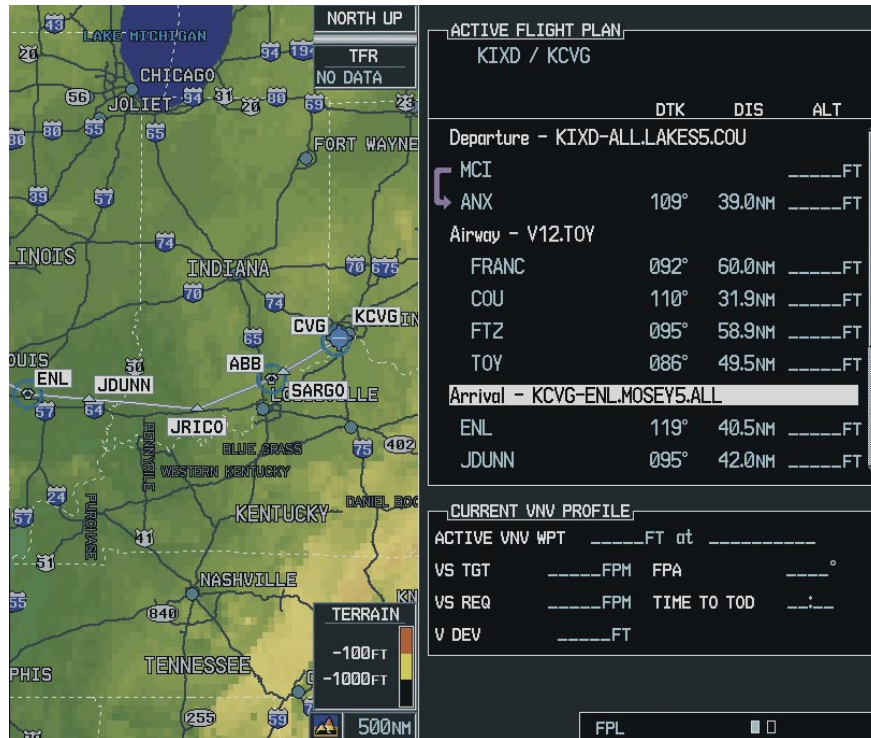

Figure 5-80 Returning to the Flight Plan Page

In the example, waypoints FRANC and COU were originally in the departure procedure. Because the airway was loaded after ANX, those waypoints were removed from the departure, but were then added back in because they were also on the selected airway (V12). Note that FRANC and COU would have been removed from the departure regardless of which airway was selected at ANX.

The rules for removing bypassed waypoints in the original flight plan are as follows:

1. Waypoints within an arrival or approach procedure are never removed during the load airway operation. Note that individual waypoints can be removed if necessary.
2. If there is a sequence of waypoints in the original flight plan starting with the entry waypoint that lines up with a sequence of waypoints in the new airway segment, that sequence is removed from the original flight plan (so it doesn't get duplicated). This rule applies only to the departure and enroute/airway parts of the flight plan (not the arrival or the approach).
3. If the airway was inserted at a departure waypoint, all the waypoints in the departure procedure following the insertion point is removed.
4. If the airway was inserted at an existing airway waypoint, the remaining waypoints in the airway is removed.

If there is not enough room in the flight plan to insert the airway segment, a pop-up message is displayed: "Flight Plan is full. Remove unnecessary waypoints." When this happens, the flight plan is not be changed. Determination of "flight plan full" accounts for the number of waypoints to be added with the new airway segment as well as the number of bypassed waypoints that would be removed from the original flight plan.

## DISPLAY OF AIRWAYS ON THE FLIGHT PLAN PAGE

When an airway segment has been inserted into the flight plan a white heading is displayed after the entry waypoint as shown in Figure 5-81.

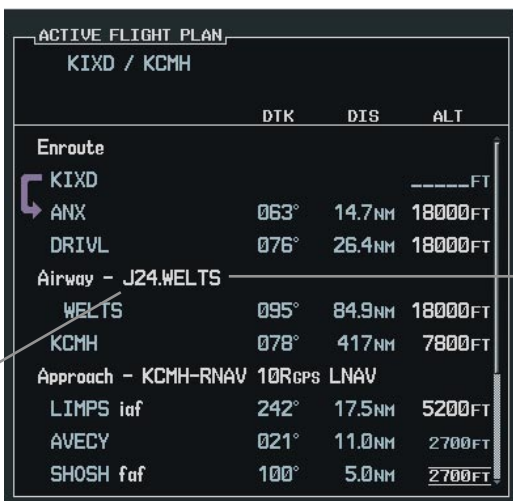

| ACTIVE FLIGHT PLAN                |      |        |         |
|-----------------------------------|------|--------|---------|
| KIXD / KCMH                       |      |        |         |
|                                   | DTK  | DIS    | ALT     |
| Enroute                           |      |        |         |
| KIXD                              |      |        | -----FT |
| ANX                               | 063° | 14.7NM | 18000FT |
| DRIVL                             | 076° | 26.4NM | 18000FT |
| Airway - J24.WELTS                |      |        |         |
| WELTS                             | 095° | 84.9NM | 18000FT |
| KCMH                              | 078° | 417NM  | 7800FT  |
| Approach - KCMH-RNAV 10R GPS LNAV |      |        |         |
| LIMPS iaf                         | 242° | 17.5NM | 5200FT  |
| AVECY                             | 021° | 11.0NM | 2700FT  |
| SHOSH faf                         | 100° | 5.0NM  | 2700FT  |

Figure 5-81 Airway Header

Airway – aaaaa.wwwwww, where aaaaa is the airway identifier and wwwwww is the exit waypoint identifier (Figure 5-81). Below the airway header, the waypoints of the airway are indented one space to create some visual separation between the airway and any subsequent off-airway waypoints that could be used on the flight plan. The PFD Flight Plan Window only displays the airway identifier and exit waypoint (Figure 5-82).



| FLIGHT PLAN |      |        |
|-------------|------|--------|
| KIXD / KCMH |      |        |
|             | DTK  | DIS    |
| KIXD        |      |        |
| ANX         | 063° | 34.8NM |
| DRIVL       | 076° | 26.4NM |
| J24.WELTS   |      |        |
| WELTS       | 095° | 84.9NM |

Figure 5-82 Airway Header on PFD

### Operations using the cursor:

- 1) On the MFD, bringing the cursor over the airway heading centers the map on the airway segment.
- 2) Pressing the **CLR** Key displays a prompt asking "Remove aaaaa.wwwwww from Flight Plan OK or CANCEL". If OK is pressed, the airway segment is removed (but not the entry waypoint). If the exit waypoint is the entry waypoint of a subsequent airway or if it overlaps an arrival or an approach, the exit waypoint is not removed.

- 3) 'Load Airway' can be selected with the cursor over the airway heading. That brings back the Airway Loading Page which is initialized to the airway segment that is currently in the flight plan.
- 4) A new waypoint can be entered with the cursor over the airway header. The new waypoint is inserted ahead of the airway header (after the airway entry waypoint).

**COLLAPSE AIRWAYS FEATURE**

'Collapse Airways' is selectable from the Flight Plan Menu if the flight plan contains at least one airway and the current state is "expanded" (Figure 5-83). In similar fashion, "Expand Airways" is selectable if the flight plan contains airways and the current state is "collapsed". When airways have been collapsed, it is indicated on the airway heading.

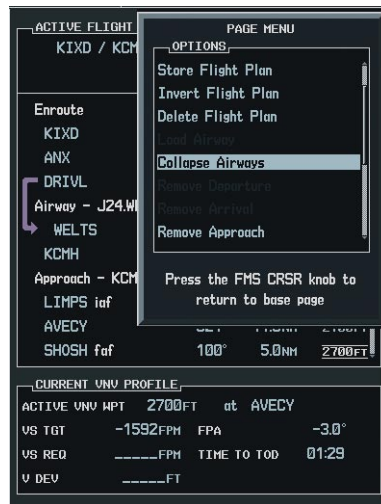

**Figure 5-83 Collapse Airway Feature**

**ACTIVE LEG DISPLAY WITH COLLAPSED AIRWAY ACTIVE**

The Flight Plan Page always keeps the following three waypoints visible:

- From Waypoint
- To Waypoint
- Next Waypoint (shows the next course)

To prevent one or more of these waypoints from being hidden in a collapsed airway segment, the airway segment that contains either the "To" or the "Next" waypoint is automatically expanded.

**INSERTING OPTIONAL AIRWAY WAYPOINTS**

To easily insert one of the "optional" airway waypoints into the flight plan. To make this easy, they are provided on a list like FPL, NRST and RECENT. The list is called AIRWAY. To add one of these to the flight plan, place the cursor over and turn the small **FMS** Knob to the left, selecting the list which has the desired waypoint, select one and press the **ENT** Key to insert it into the flight plan.



Figure 5-84 Inserting Optional Airspace Waypoints

## DIRECTIONAL AIRWAYS/INVERTING FLIGHT PLANS

Some airways have directional restrictions on all or part of the route. Airway “A2” in Europe has a directional restriction over the whole route such that it can be flown only in the direction MTD-ABB-BNE-DEVAL.

Airway “UR975” in North Africa has more complicated directional restrictions within the list of airway waypoints AMANO, VAKOR, LIBRO NELDA, DIRKA, GZO, KOSET and SARKI:

- Starting from AMANO, the airway can be flown only to LIBRO.
- Starting from SARKI, the airway can be flown only to LIBRO.
- Between NELDA and GZO, the airway can be flown in either direction.

The system inverts the airway waypoint sequence and removes all of the airway headers.



**NOTE:** In the US, airways that are “one-way” for specified hours of operation are not uncommon. These airways are always bi-directional in the G1000 database – this is an ARINC 424 limitation.

## AIRWAYS AND DATABASE UPDATES

Flight plans with airways can be saved; however, when the database is updated, the airways must be reloaded, similar to what must be done for procedures.

The basic process is that each airway segment is reloaded from the database given the entry waypoint, the airway identifier and the exit waypoint. This re-loads the sequence of waypoints between the entry and exit waypoints (the sequence may change when the database is updated).

If “optional” airway waypoints have been inserted within the airway sequence, those waypoints are included when the airway is updated whenever possible.

The update of an airway can fail during this process. If that happens, the airway is removed from the flight plan. The following things could cause the airway update to fail:

- Airway entry waypoint or exit waypoint not found in the new database
- Airway identifier not found in the new database
- Airway entry waypoint is not an acceptable entry waypoint for the airway – either the waypoint is no longer on the airway, or there is a new directional restriction that prevents it being used as an entry waypoint.

- Airway exit waypoint is not an acceptable exit waypoint for the airway – either the waypoint is no longer on the airway, or there is a new directional restriction that prevents it being used as an exit waypoint (given the entry waypoint)
- Loading the new airway sequence would exceed the capacity of the flight plan

## VERTICAL NAVIGATION (VNV)

---



**NOTE:** Refer to the Appendices for VNV Flight Planning definitions, abbreviations, and acronyms.

---

The G1000 System can use altitude constraints associated with lateral waypoints to give guidance for vertical navigation. These altitudes are, depending on the specific instance, entered or retrieved from the published altitudes in the navigation database.

The navigation database only contains altitudes for procedures that call for “Cross at” altitudes. If the procedure states “Expect to cross at,” then the altitude is not in the database. In this case the altitude may be entered manually.

When activating or loading an arrival or approach procedure into an active flight plan, the VNV ‘ALT’ fields are populated with any altitudes that can be retrieved from the navigation database.

To help interpret the meanings of how the altitudes are presented, keep the following points in mind:

- When the altitude is displayed in light blue, the system is using that altitude to determine vertical speed and deviation guidance.
- When the altitude is displayed in white, it is not being used by the system to determine the vertical speed and deviation guidance.
- An altitude displayed as small text is an altitude that is published in the navigation database.
- Altitudes displayed as a light blue halftone cannot be used in the current vertical navigation calculations.

Refer to Figure 5-85 and Table 5-3 for more detail regarding the significance of text size and color.

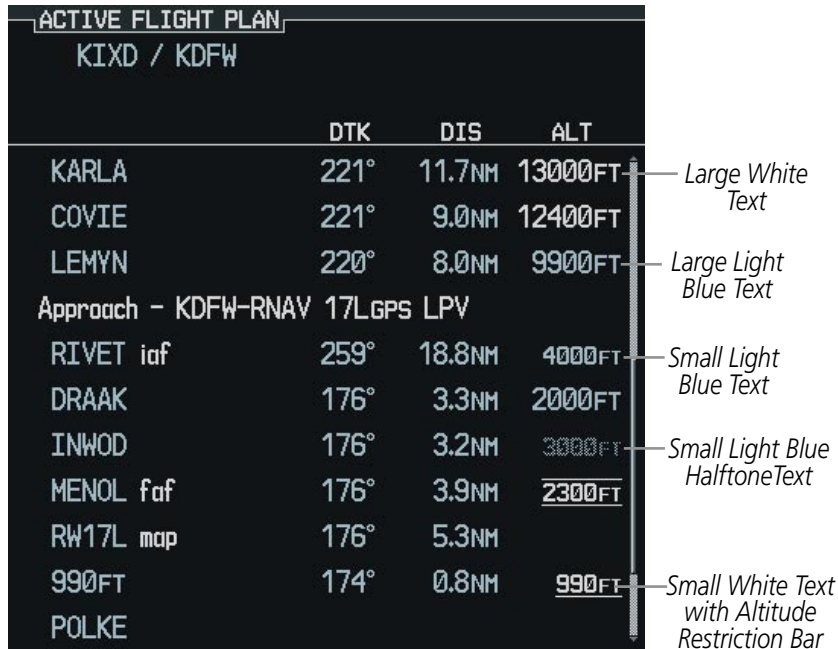

Figure 5-85 VNV Altitudes

|            | White Text   | Light Blue Text  | Light Blue Halftone Text  |
|------------|--|--|---|
| Large Text | Altitude calculated by the system estimating the altitude of the aircraft as it passes over the navigation point. This altitude is provided as a reference and is not being used by the system to determine vertical speed and deviation guidance. | Altitude has been entered by the pilot. Altitude is being used by the system for vertical speed and deviation guidance. Altitude does not match the published altitude in navigation database or no published altitude exists. | The system cannot use this altitude in determining vertical speed and deviation guidance. |
| Small Text | Altitude is not being used to determine vertical speed and deviation guidance. Altitude has been retrieved from the navigation database and is provided as a reference.  | Altitude is being used by the system for vertical speed and deviation guidance. Altitude has been retrieved from the navigation database or has been entered and matches a published altitude in the navigation database.      | The system cannot use this altitude in determining vertical speed and deviation guidance. |

Table 5-3 VNV Altitude Text Size and Color

Some altitudes retrieved from the database have associated restrictions indicating to stay ‘At’, ‘At or Above’, or ‘At or Below’ a specific altitude. These restrictions are indicated using a ‘bar’ above and/or below the appropriate altitude as shown in Figure 5-86.





Figure 5-86 Altitude Restrictions



*Note: Vertical constraints and along track offset waypoints are not retained in stored flight plans.*

#### Enabling/Canceling VNV guidance:

- 1) Select the Active Flight Plan Page.
- 2) Select the **CNCL VNV** Softkey. Canceling VNV results in VNV outputs V DEV (vertical deviation), VS REQ (vertical speed required), and TIME TO TOD/BOD (time to top of descent/bottom of descent) going invalid. As a result the non-numeric vertical deviation and VS REQ indicators on the PFD are removed. Additionally the V DEV, VS REQ, and TIME TO TOD displayed in the Current VNV Profile box on the Active Flight Plan Page is dashed.

Once cancelled, VNV remains disabled until manually enabled or a direct-to waypoint is entered while in reversionary mode. When cancelled the **CNCL VNV** Softkey changes to ENBL VNV. VNV can be enabled by selecting the **ENBL VNV** Softkey causing a VNV waypoint to be selected (if possible) and vertical navigation to resume.

## ALTITUDE CONSTRAINTS

The G1000 provides a means to enter altitude constraints associated with waypoints in the active flight plan so long as the waypoint is not the final approach fix, a waypoint after the FAF, or part of an unsupported lateral leg type.

Altitude constraints are displayed and entered in mean sea level (MSL) values to the nearest hundredth. An altitude constraint in above ground level (AGL) format is supported for airports. To convert the value to AGL, turn the **FMS** Knob when MSL is highlighted and press the **ENT** Key. When a database altitude restriction is displayed, the G1000 allows user entry of a different altitude when creating a waypoint, effectively overriding the database restriction (only before the FAF). The G1000 allows activation of a displayed database altitude restriction by highlighting the database constraint and pressing the **ENT** Key. When a database altitude restriction of type “AT or ABOVE” or “AT or BELOW” is activated, the G1000 uses the “AT” portion of the restriction to define the vertical profile.

The G1000 annunciates all constraints that cannot be used to calculate vertical guidance by displaying the value in halftone, light blue text. The following conditions constitute an invalid altitude constraint:

- Meeting the constraint requires the aircraft to climb
- Meeting the constraint requires the maximum flight path angle to be exceeded
- Meeting the constraint requires the maximum vertical speed to be exceeded
- The altitude constraint results in a TOD behind the aircraft present position
- The constraint is within a leg type for which altitude constraints are not supported

- To add an altitude constraint to the FAF or a waypoint past the FAF of an approach that provides vertical guidance (i.e. ILS or GPS WAAS approach)
- To add an altitude constraint to any waypoint past the FAF of an approach that does not provide vertical guidance (i.e. not an ILS or GPS WAAS approach).

To enter altitudes as a flight level, enter an “F” in the most significant digit by rotating the inner FMS Knob counter-clockwise past zero or clockwise past 9, the system automatically changes to show units of Flight Level.



**NOTE:** Vertical constraints and Along Track offset waypoints are not retained in stored flight plans.



**NOTE:** When an altitude constraint is subdued it means that the user has selected a vertical profile that cannot be flown. The computed FPA for adjacent vertical constraints is too steep.

#### Entering an altitude constraint:

- 1) Select the Active Flight Plan Page.
- 2) Highlight the desired waypoint altitude field (Figure 5-87).
- 3) Enter an altitude constraint value.
- 4) Press the **ENT** Key to accept the VNV altitude constraint.

| ACTIVE FLIGHT PLAN |      |        |         |
|--------------------|------|--------|---------|
| KDLH / KSEA        |      |        |         |
|                    | DTK  | DIS    | ALT     |
| Enroute            |      |        |         |
| KDLH               |      |        | -----FT |
| FAR                | 270° | 192NM  | 17300FT |
| Airway - J36.MLP   |      |        |         |
| DIK                | 270° | 244NM  | 17800FT |
| HILGR              | 270° | 263NM  | 17300FT |
| GTF                | 261° | 92.3NM | 17300FT |
| MLP                | 258° | 172NM  | 17300FT |
| Airway - J136.GEG  |      |        |         |
| GEG                | 260° | 80.8NM | 17300FT |
| KSEA               | 253° | 191NM  | 12500FT |

| CURRENT VNV PROFILE |          |             |           |
|---------------------|----------|-------------|-----------|
| ACTIVE VNV HPT      | 5000FT   | at          | ATEVE idf |
| VS TGT              | -----FPM | FPA         | -3.0°     |
| VS REQ              | -----FPM | TIME TO TOD | ---       |
| V DEV               | -----FT  |             |           |

VNV ALT Field

Figure 5-87 Entering an Altitude Constraint

## ALTITUDE CONSTRAINT MODIFICATION

An altitude constraint is deleted by highlighting the altitude and pressing the **CLR** Key followed by the **ENT** Key. In the event an altitude constraint is deleted and the navigation database contains an altitude restriction for the lateral waypoint, the G1000 displays the altitude restriction from the database provided no predicted altitude can be provided.

### Changing an altitude constraint:

- 1) Select the Active Flight Plan Page.
- 2) Highlight the desired altitude constraint.
- 3) Change the altitude constraint value.
- 4) Press the **ENT** Key to confirm the change.

### Deleting an altitude constraint:

- 1) Select the Active Flight Plan Page.
- 2) Highlight the desired altitude constraint.
- 3) Select the **CLR** Key.
- 4) Select the **ENT** Key.

## ALONG TRACK OFFSETS



---

**NOTE:** An along track offset waypoint cannot be created if it is not adjacent to its parent waypoint

---

Offset distances can be entered from 1 to 99 nautical miles in increments of 1 nautical mile before the offset waypoint (shown as a negative value) or after the offset waypoint (shown as a positive value).

A waypoint is allowed as long as the along track offset places the waypoint adjacent to its parent waypoint in the lateral flight plan.

An along track offset that places a waypoint after the final approach fix of an approach is not allowed. Along track offset waypoints lie along the great circle path of the existing lateral flight plan. Assigning an along track offset to a leg with indeterminate length is not permitted.

Entering a negative offset distance results in an along track offset waypoint inserted before the selected lateral waypoint, whereas entering a positive offset distance results in an along track offset waypoint inserted after the selected lateral waypoint. The creation of multiple along track offset waypoints is allowed.



---

**NOTE:** If the **CLR** Key is pressed prior to completing the definition of the along track offset waypoint, the along track offset waypoint is removed.

---



---

**NOTE:** An along track offset distance cannot be modified once entered. If the along track offset distance must be changed, the existing along track offset waypoint must be deleted and a new one created with the corrected offset distance.

---

### Entering an along track offset distance:

- 1) Select the Active Flight Plan Page.
- 2) Select the desired lateral waypoint.
- 3) Select the **OFST** Softkey.
- 4) Enter a positive or negative offset distance in the range of +/- 1 to 99 nautical miles (Figure 5-88 ). NOTE: The offset also cannot exceed the distance to the next or previous lateral non-ATK offset waypoint.

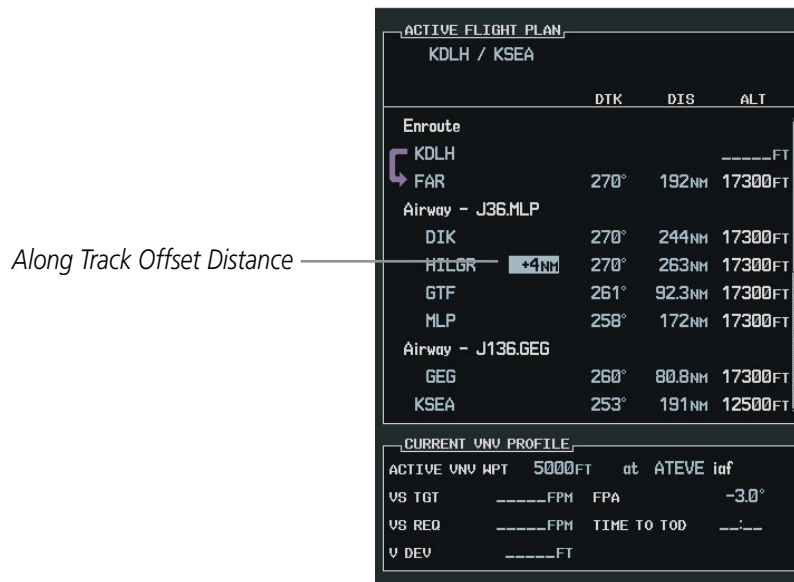

Figure 5-88 Along Track Offset Distance

## VNV PROFILE

The VNV profile can be changed by one of the following means:

- Changing the Flight Path Angle (FPA) for the descent segment
- Changing the target vertical speed for the descent segment

Changes to the VNV profile apply to the current active waypoint only. The VNV profile is not modifiable if there is no active waypoint. An invalid entry results in the previous value being restored. The VNV profile modification is invalid if it results in any of the following conditions:

- The maximum allowed FPA is exceeded
- The calculated target vertical speed exceeds the maximum allowed
- The TOD point is now located behind the aircraft's present position or an s-turn would be required to capture the modified vertical profile
- Modifying the vertical speed target for the current waypoint

The VS TGT is computed using the FPA and current ground speed and updated on the display periodically. If there is an active waypoint with a vertical component, a valid ground speed, and the system determines the aircraft is airborne. Updates to the field cease when the field is selected for modification.

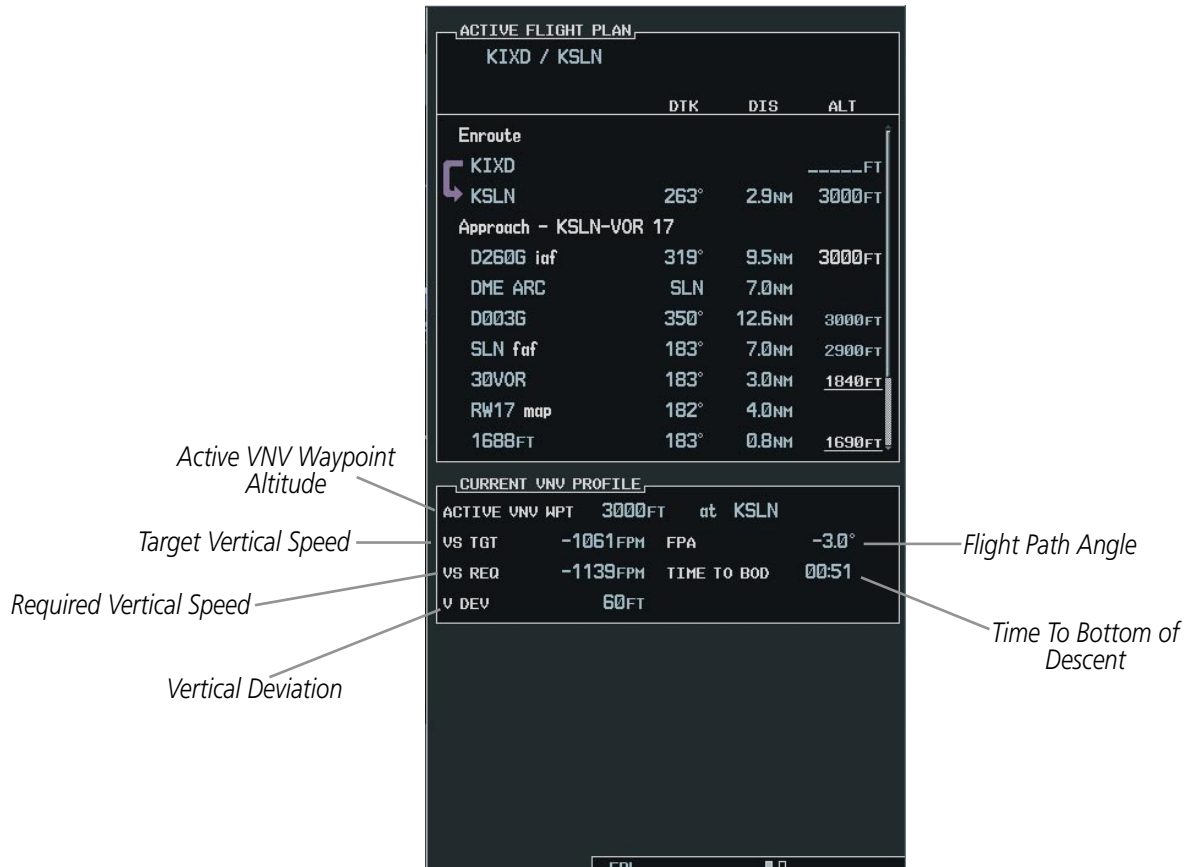

Figure 5-89 VNV Profile

The VS TGT may be changed using the following sequence of actions:

**Modifying the VS TGT from the Active Flight Plan Page:**

- 1) Select the **VNV PROF** Softkey.
- 2) Use the small **FMS** Knob, or enter the desired value or to modify the value.
- 3) Select the **VNV PROF** Softkey again when finished or press the **FMS** Knob to remove the cursor from the VNV Profile. VS TGT must be negative and cannot be less than the configured minimum value).

**Upon completion of entering a new VS TGT the G1000:**

- Periodically computes a new FPA using the selected VS TGT and current ground speed until the TOD is reached
- Uses the newly computed FPA for the active waypoint with a vertical component
- Resumes periodic updates of the VS TGT using the new FPA and current ground speed. VNV profile changes apply to the active waypoint only.

The active waypoint with a vertical component and its FPA is shown in the current VNV profile information box.

**Modifying the flight path angle from the Active Flight Plan Page:**

- 1) Select the FPA by selecting the **VNV PROF** Softkey followed by a clockwise turn of the large **FMS** Knob. It can also be selected by scrolling past the end of the active flight plan waypoint list.
- 2) Modify the value using the small **FMS** Knob. The FPA must be negative and cannot be less than the configured minimum value.

## NAVIGATING AN EXAMPLE FLIGHT PLAN

The following discussion is an example of navigating a flight plan with the WAAS capable GPS system while the G1000 provides vertical guidance through descents. A lateral flight plan (LNAV) would be navigated in much the same way, but would not include vertical guidance when the final approach course is active.

The example is a flight plan from KMKC to KCOS filed using the TIFTO2 departure, various Victor Airways, and the DBRY1 arrival with the transition at TBE. Enroute altitude is 12,000 feet. An LPV (WAAS) approach is selected for runway 35R. A missed approach is executed at the Missed Approach Point (MAP). A few enroute changes are demonstrated.

- 1) Prior to departure, the TIFTO2 departure, the airways, and the DBRY1 arrival at KCOS are loaded. See the Procedures section for loading departures and arrivals. Note the magenta Map Pointer in Figure 5-90 indicating the active departure leg. After takeoff, ATC assigns a heading of 240°.
- 2) Figure 5-90 shows the aircraft on the assigned heading of 240°. 'TERM' (Terminal) is the current CDI flight phase displayed on the HSI indicating 1.0 nm CDI scaling.

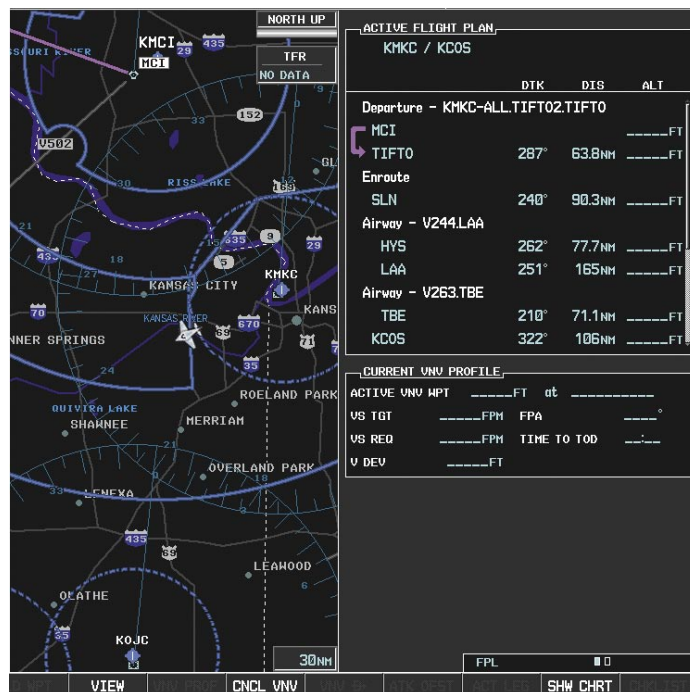

Figure 5-90 Assigned Heading of 240°

- 3) ATC now assigns routing to join V4. A heading of  $290^{\circ}$  is assigned to intercept V4. The aircraft turns to heading  $290^{\circ}$  as seen in Figure 5-91. Note the current CDI flight phase is now ENR (Enroute). When the aircraft reached 30 nautical miles from the departure point, the flight phase changed from TERM to ENR on the HSI and CDI scaling changed to 2.0 nm.

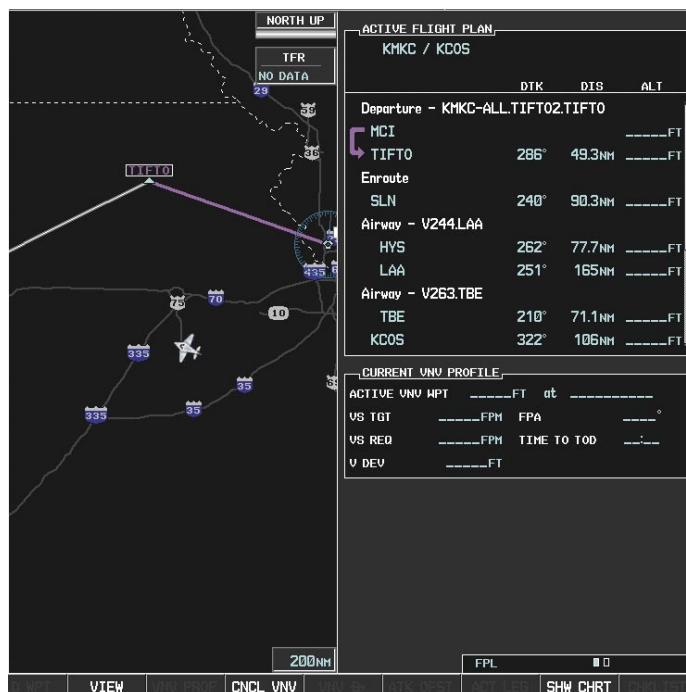

Figure 5-91 Assigned Heading of  $290^{\circ}$

- 4) V4 is now entered into the flight plan.
- Press the **FMS** Knob to activate the cursor.
  - Turn the large **FMS** Knob to highlight the point that proceeds V4 is entered as shown in Figure 5-92.



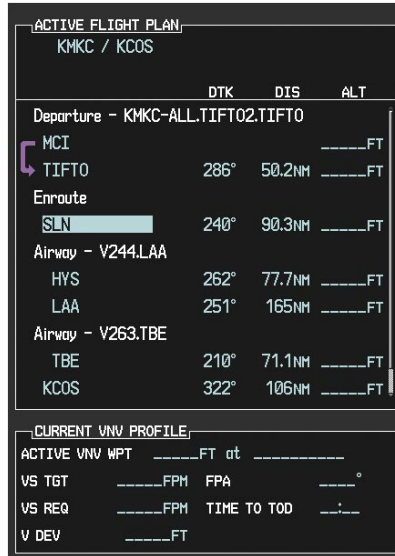

Figure 5-92 Begin Adding V4 to the Flight Plan

- c) Turn the small **FMS** Knob to display the Waypoint Information Window. Enter the desired entry point for V4, in this case Topeka VOR (TOP) is used as shown in Figure 5-93.

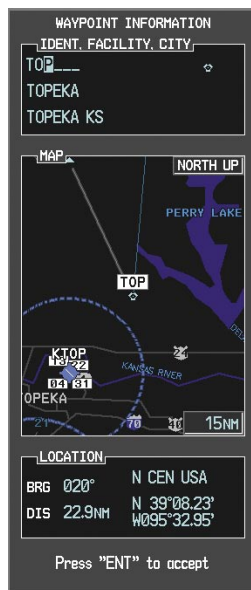

Figure 5-93 Entering V4 Entry Point

- d) Press the **ENT** Key. TOP is now inserted into the flight plan as in Figure 5-94.

| ACTIVE FLIGHT PLAN |      |        |         |
|--------------------|------|--------|---------|
| KMKC / KCOS        |      |        |         |
|                    | DTK  | DIS    | ALT     |
| MCI                |      |        | _____FT |
| TIFTO              | 286° | 47.0NM | _____FT |
| Enroute            |      |        |         |
| TOP                | 146° | 32.3NM | _____FT |
| SLN                | 260° | 97.7NM | _____FT |
| Airway - V244.LAA  |      |        |         |
| HYS                | 262° | 77.7NM | _____FT |
| LAA                | 251° | 165NM  | _____FT |
| Airway - V263.TBE  |      |        |         |
| TBE                | 210° | 71.1NM | _____FT |
| KCOS               | 322° | 106NM  | _____FT |

| CURRENT VNV PROFILE |          |             |        |
|---------------------|----------|-------------|--------|
| ACTIVE VNV WPT      | _____FT  | at          | _____  |
| VS TGT              | _____FPM | FPA         | _____° |
| VS REQ              | _____FPM | TIME TO TOD | __:'   |
| V DEV               | _____FT  |             |        |

Figure 5-94 TOP Inserted into the Flight Plan

- e) With SLN still highlighted as in Figure 5-94, turn the small **FMS** Knob to the right. The Waypoint Information Page is displayed and the **LD AIRWY** Softkey is now available.
- f) Select the **LD AIRWY** Softkey to display the list of available airways for TOP as seen in Figure 5-95.

| ENTRY  |             |
|--------|-------------|
| TOP    |             |
| AIRWAY |             |
| V4     |             |
| V131   |             |
| V280   |             |
| V4     |             |
| V508   |             |
| V71    |             |
| V77    |             |
| SLN    | 260° 97.7NM |
| LOAD?  |             |

Figure 5-95 List of Available Airways for TOP

- g) Turn either **FMS** Knob to highlight V4 in the list as seen in Figure 5-95.
- h) Press the **ENT** Key. The list of available exits for V4 is now displayed as in Figure 5-96.

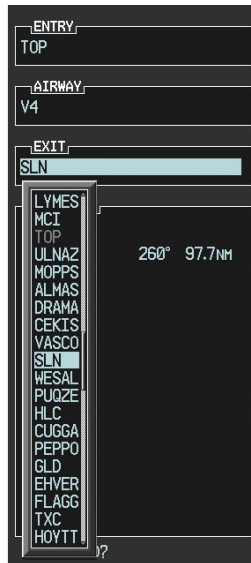

Figure 5-96 List of Available Exits for V4

- i) If necessary, turn either FMS Knob to select the desired exit. In this case Salina VOR (SLN) is selected as seen in Figure 5-97.
- j) Press the **ENT** Key. The selected airway and exit are displayed the prompt "LOAD?" highlighted as in Figure 5-98.

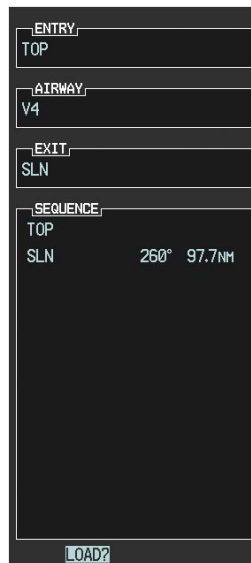

Figure 5-98 Ready to Load V4

- k) Press the **ENT** Key.
- l) V4 is now loaded into the flight plan as shown in Figure 5-99.

| ACTIVE FLIGHT PLAN                |      |        |         |
|-----------------------------------|------|--------|---------|
| KMKC / KCOS                       |      |        |         |
|                                   | DTK  | DIS    | ALT     |
| Departure - KMKC-ALL.TIFT02.TIFT0 |      |        |         |
| MCI                               |      |        | _____FT |
| TIFT0                             | 286° | 46.9NM | _____FT |
| Enroute                           |      |        |         |
| TOP                               | 146° | 32.3NM | _____FT |
| Airway - V4.SLN                   |      |        |         |
| SLN                               | 260° | 97.7NM | _____FT |
| Airway - V244.LAA                 |      |        |         |
| HYS                               | 262° | 77.7NM | _____FT |
| LAA                               | 251° | 165NM  | _____FT |
| Airway - V263.TBE                 |      |        |         |

| CURRENT VNV PROFILE |          |             |         |
|---------------------|----------|-------------|---------|
| ACTIVE VNV WPT      | _____FT  | at          | _____   |
| VS TGT              | _____FPM | FPA         | _____°  |
| VS REQ              | _____FPM | TIME TO TOD | ___:___ |
| V DEV               | _____FT  |             |         |

Figure 5-99 V4 is Loaded in the Flight Plan

- 5) V4 is now made the active leg of the flight plan.
  - a) Press the **FMS** Knob to activate the cursor.
  - b) Turn the large **FMS** Knob to highlight SLN. The TO waypoint of the leg is selected in order to activate the leg.
  - c) Select the **ACT LEG** Softkey. The confirmation window is now displayed as in Figure 5-100. Note the TOP to SLN leg is actually part of V4.



Figure 5-100 Confirm Active Leg

- d) Verify the displayed leg is the desired leg and press the **ENT** Key. Note in Figure 5-101, the magenta Map Pointer in the flight plan window and magenta line on the map indicating V4 is now the active flight plan leg. Note also, the crosstrack (XTK) distance on the HSI indicating 16.9 nm to the intercept point.

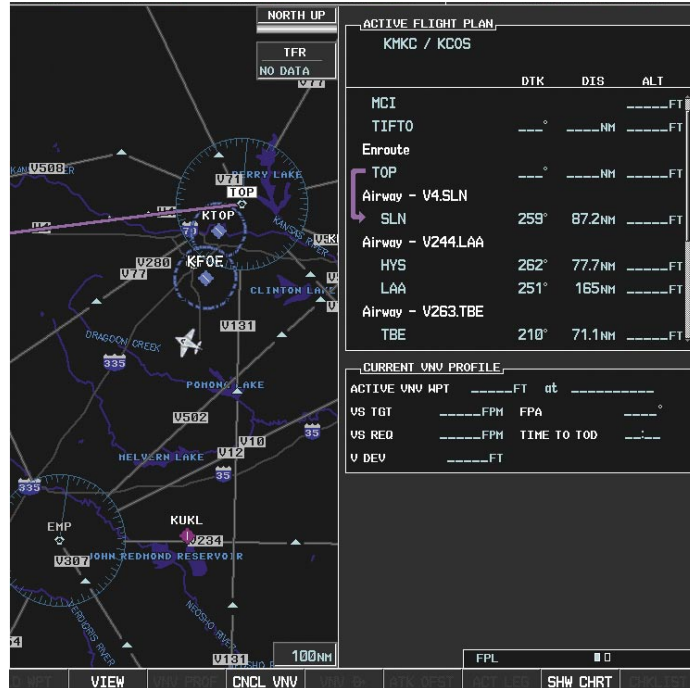

Figure 5-101 V4 Now Active Leg

- 6) The aircraft continues on heading 290°. When 2.0 nm from the intercept, the XTK disappears from the HSI and the CDI are positioned on the last dot indicating a 2.0 nm distance from the centerline of the next course.

7) As the CDI approaches center, the aircraft turns onto the active leg as seen in Figure 5-102.

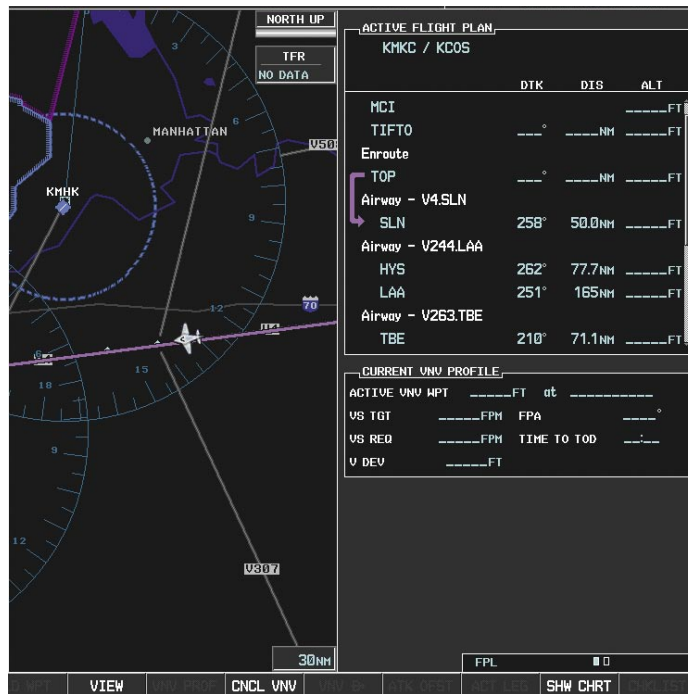

Figure 5-102 Turn on to Active Leg

- 8) At SLN, Victor Airway 244 (V244) is intercepted. Turn prompts are displayed in the PFD Navigation Status Box as seen in Figure 5-103.

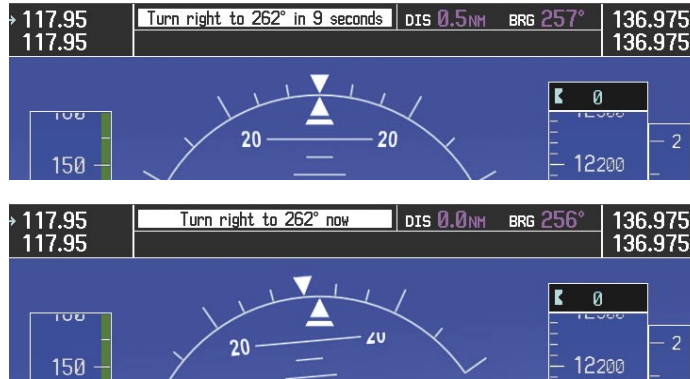

Figure 5-103 Turn to Intercept V244

- 9) As seen in Figure 5-104, V244 is now the active flight plan leg.



Figure 5-104 V244 Now Active Leg

10) At Lamar VOR (LAA) V263 is intercepted. See Figure 5-105.

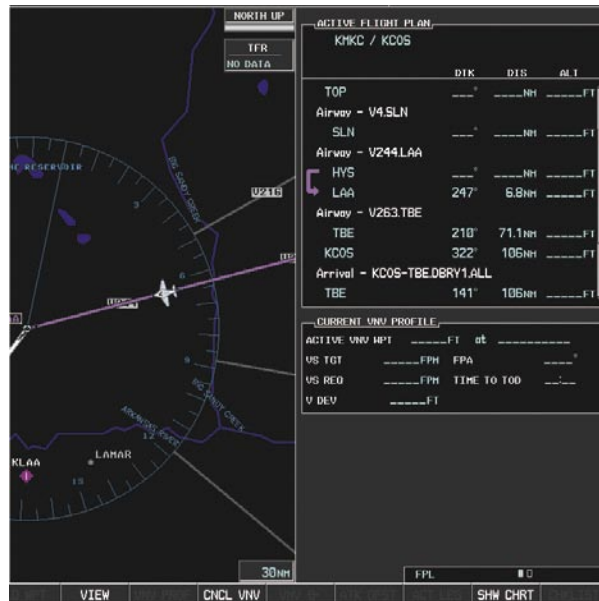

Figure 5-105 HYS to LAA Leg Active

11) ATC grants clearance to proceed direct to OPSHN intersection to begin the arrival procedure. ATC advises to expect an altitude of 10,000 feet at OPSHN.

- Press the **FMS** Knob to activate the cursor.
- Turn the large **FMS** Knob to select OPSHN in the flight plan list.
- Press the **Direct-to** (D▶) Key. The Direct-to Window is now displayed as shown in Figure 5-106.



Figure 5-106 Direct To OPSHN



d) Turn the large **FMS** Knob to place the cursor in the VNV altitude field as shown in Figure 5-107.



Figure 5-107 Enter VNV Altitude

e) An altitude of 10,000 feet is entered as requested by ATC.

f) Press the **ENT** Key. The cursor is now displayed in the VNV offset field as shown in Figure 5-108.



Figure 5-108 Enter VNV Offset Distance

g) Enter the offset, or distance from the waypoint at which the selected altitude is reached. In this case, three miles prior to OPSHN is entered. In other words, the G1000 gives vertical guidance so the aircraft arrives at an altitude of 10,000 feet three miles prior to OPSHN.

- h) Press the **ENT** Key twice to activate the direct-to. Note, in Figure 5-109, the magenta Map Pointer indicating the direct-to OPSHN after the offset waypoint for OPSHN. The preceding offset waypoint indicates the offset distance and altitude that was previously entered. The remaining waypoints in the loaded arrival procedure have no database specified altitudes, therefore, dashes are displayed. Keep the CDI centered and maintain a track along the magenta line to OPSHN.



**NOTE:** If the loaded arrival procedure has waypoints with altitude constraints retrieved from the database that is used as is, the altitude must be manually accepted by placing the cursor over the desired altitude, then pressing the **ENT** Key. The altitude is now displayed as light blue meaning which is now used by the system to determine vertical speed and deviation guidance.

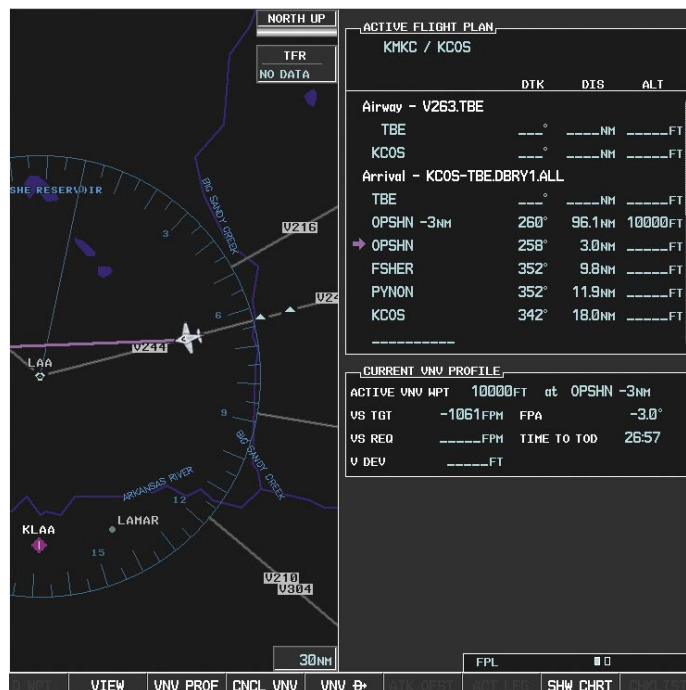

Figure 5-109 Direct-to Active

- 12) While proceeding to OPSHN, the LPV approach to runway 35R is preferred and is used.
- Press the **PROC** Key to display the Procedures Window.
  - 'SELECT APPROACH' should be highlighted as shown in Figure 5-109.

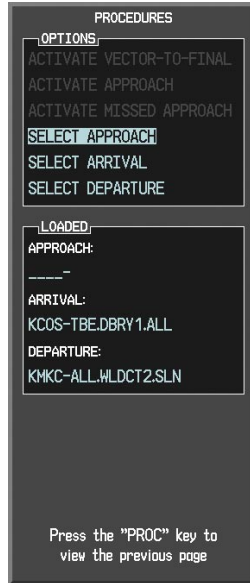

Figure 5-110 Procedures Window

c) Press the **ENT** Key. A list of available approaches for the destination airport is displayed as in Figure 5-111.



Figure 5-111 List of Available Approaches

d) Turn either **FMS** Knob to select the LPV approach for 35R as shown in Figure 5-111.

e) Press the **ENT** Key. A list of available transitions for the selected approach is displayed as shown on Figure 5-112.

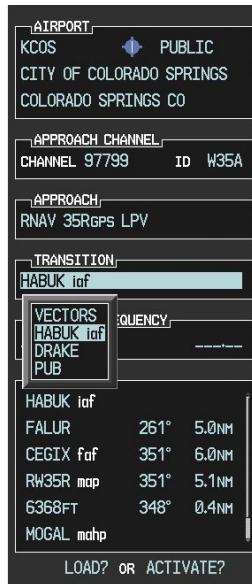

Figure 5-112 List of Available Transitions

- e) Turn either **FMS** Knob to select the desired transition. In this case, the Initial Approach Fix (IAF) at HABUK is used.
- f) Press the **ENT** Key.
- g) With 'LOAD?' highlighted, again press the **ENT** Key. The selected approach is added to the flight plan as seen in Figure 5-113.

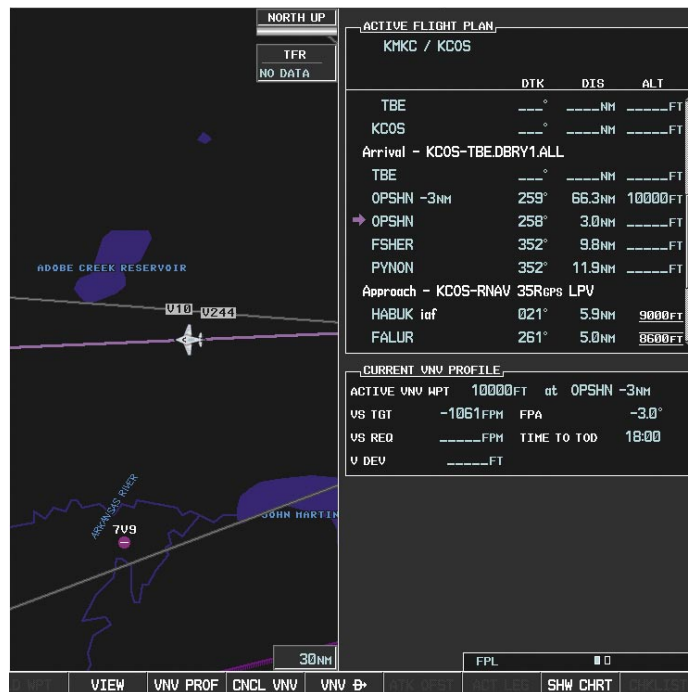

Figure 5-113 Loaded Approach

- 13) Note the altitude constraints associated with each of the approach waypoints as seen in Figure 5-114. These altitudes are loaded from the database and are initially displayed as white text, indicating these values are not be used in computing vertical deviation guidance. The altitude values must be designated for use if they are to be used in computing vertical guidance.
  - a) Press the **FMS** Knob to activate the cursor.
  - b) Turn the large **FMS** Knob to place the cursor in the altitude field associated with the IAF at HABUK as in Figure 5-115.

| ACTIVE FLIGHT PLAN               |          |             |            |
|----------------------------------|----------|-------------|------------|
| KMKC / KCOS                      |          |             |            |
|                                  | DTK      | DIS         | ALT        |
| FSHER                            | 352°     | 9.8NM       | _____FT    |
| PYNON                            | 352°     | 11.9NM      | _____FT    |
| Approach - KCOS-RNAV 35R GPS LPV |          |             |            |
| HABUK iaf                        | 021°     | 5.9NM       | 9000FT     |
| FALUR                            | 261°     | 5.0NM       | 8600FT     |
| CEGIX faf                        | 351°     | 6.0NM       | 7800FT     |
| RW35R map                        | 351°     | 5.1NM       |            |
| 6368FT                           | 348°     | 0.4NM       | 6370FT     |
| MOGAL mahp                       |          |             | 10000FT    |
| HOLD                             | 168°     | 6.0NM       |            |
| -----                            |          |             |            |
| CURRENT VNV PROFILE              |          |             |            |
| ACTIVE VNV WPT                   | 10000FT  | at          | OPSHN -3NM |
| VS TGT                           | -796FPM  | FPA         | -3.0°      |
| VS REQ                           | _____FPM | TIME TO TOD | 30:50      |
| V DEV                            | _____FT  |             |            |

**Figure 5-115 Designate HABUK Altitude Constraint**

- c) Press the **ENT** Key. Note the altitude is now displayed as light blue text, indicating that the value is now used in computing vertical guidance. The G1000 uses baro corrected altitude when giving vertical guidance to these waypoints.
- d) Turn the large **FMS** Knob to select the altitude constraint associated with FALUR as seen in Figure 5-115.

| ACTIVE FLIGHT PLAN               |          |             |            |
|----------------------------------|----------|-------------|------------|
| KMKC / KCOS                      |          |             |            |
|                                  | DTK      | DIS         | ALT        |
| FSHER                            | 352°     | 9.8NM       | 10000FT    |
| PYNON                            | 352°     | 11.9NM      | 10000FT    |
| Approach - KCOS-RNAV 35R GPS LPV |          |             |            |
| HABUK iaf                        | 021°     | 5.9NM       | 9000FT     |
| FALUR                            | 261°     | 5.0NM       | 8600FT     |
| CEGIX faf                        | 351°     | 6.0NM       | 7800FT     |
| RW35R map                        | 351°     | 5.1NM       |            |
| 6368FT                           | 348°     | 0.4NM       | 6370FT     |
| MOGAL mahp                       |          |             | 10000FT    |
| HOLD                             | 168°     | 6.0NM       |            |
| -----                            |          |             |            |
| CURRENT VNV PROFILE              |          |             |            |
| ACTIVE VNV WPT                   | 10000FT  | at          | OPSHN -3NM |
| VS TGT                           | -796FPM  | FPA         | -3.0°      |
| VS REQ                           | _____FPM | TIME TO TOD | 29:57      |
| V DEV                            | _____FT  |             |            |

**Figure 5-115 Designate FALUR Altitude Constraint**

- e) Press the **ENT** Key to designate this altitude constraint value for use in computing vertical guidance. This altitude value is now displayed as light blue text. Note that altitude values are now filled in for waypoints back to where the previous altitude value was entered for OPSHN.

Altitude constraint values associated with the Final Approach Fix (FAF) and waypoints beyond the FAF cannot be designated for vertical guidance. These altitude values are always displayed as white text, as in Figure 5-116. Vertical guidance to the FAF and on to the Missed Approach Point (MAP) is given using the WAAS GPS altitude source, therefore, the displayed altitude values are for reference only.

| ACTIVE FLIGHT PLAN               |      |        |         |
|----------------------------------|------|--------|---------|
| KMKC / KCOS                      |      |        |         |
|                                  | DTK  | DIS    | ALT     |
| FSHER                            | 352° | 9.8NM  | 10000FT |
| PYNON                            | 352° | 11.9NM | 10000FT |
| Approach - KCOS-RNAV 35R GPS LPV |      |        |         |
| HABUK iaf                        | 021° | 5.9NM  | 9000FT  |
| FALUR                            | 261° | 5.0NM  | 8600FT  |
| CEGIX faf                        | 351° | 6.0NM  | 7800FT  |
| RW35R map                        | 351° | 5.1NM  |         |
| 6368FT                           | 348° | 0.4NM  | 6370FT  |
| MOGAL mahp                       |      |        | 10000FT |
| HOLD                             | 168° | 6.0NM  |         |

| CURRENT VNV PROFILE |                       |             |       |
|---------------------|-----------------------|-------------|-------|
| ACTIVE VNV WPT      | 10000FT at OPSHN -3NM |             |       |
| VS TGT              | -796FPM               | FPA         | -3.0° |
| VS REQ              | _____FPM              | TIME TO TOD | 29:49 |
| V DEV               | _____FT               |             |       |

Figure 5-116 Vertical Guidance is Active to the FAF

- 14) As the aircraft approaches OPSHN, it may be desirable to adjust the quickness, or steepness, of the upcoming descent is. The default Flight Path Angle (FPA) is -3.0 degrees and a required vertical speed is computed to maintain the -3.0 FPA. To change the vertical flight path, perform the following steps.
- Select the **VNV PROF** Softkey to place the cursor in the target vertical speed field (VS TGT) as shown in Figure 5-112.
  - At this point, the descent vertical speed can be selected, or the FPA can be selected. Turn the large **FMS** Knob to select the desired selection field, then turn the small **FMS** Knob to enter the desired value.

Note the information now displayed in the 'CURRENT VNV PROFILE' box. Also, note the offset waypoint and gray circle are now displayed on the map. The gray circle marks the Top of Descent (TOD). In this example, vertical guidance is provided at the TOD that results in a -3.0 degree FPA descent to an altitude of 10,000 feet upon reaching the offset waypoint.



Figure 5-117 Adjusting the Descent

c) Press the **ENT** Key.

- As seen in Figure 5-118, the aircraft is approaching TOD. Note the target vertical speed required to reach the selected altitude. The Vertical Deviation Indicator (VDI) and the Required Vertical Speed Indicator (RVSI) are now displayed on the PFD as shown in Figure 5-119.

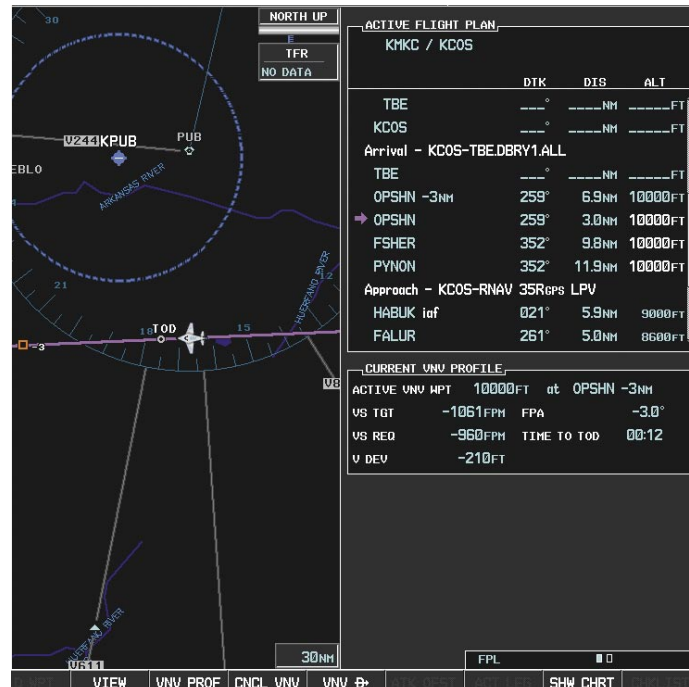

Figure 5-118 Approaching Top of Descent (TOD)

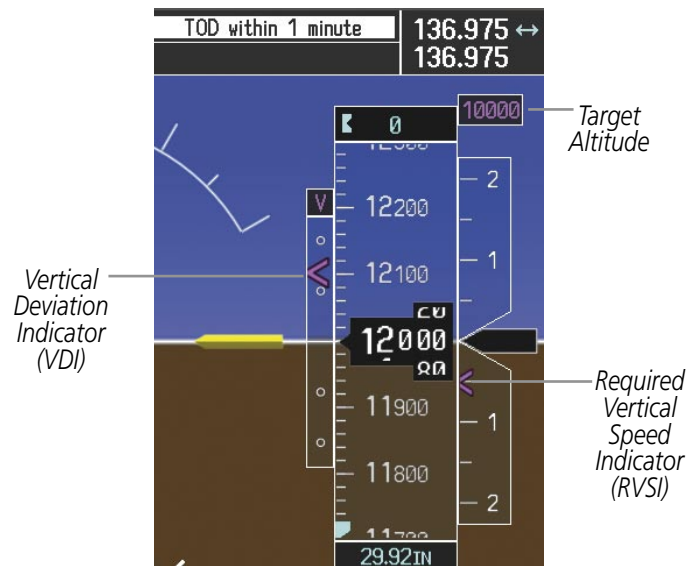

Figure 5-119 VDI & RVSI Upon Reaching Top of Descent (TOD)

- 16) Upon reaching TOD, a descent vertical speed is established which places the VSI pointer in line with the RVSI as shown in Figure 5-120.

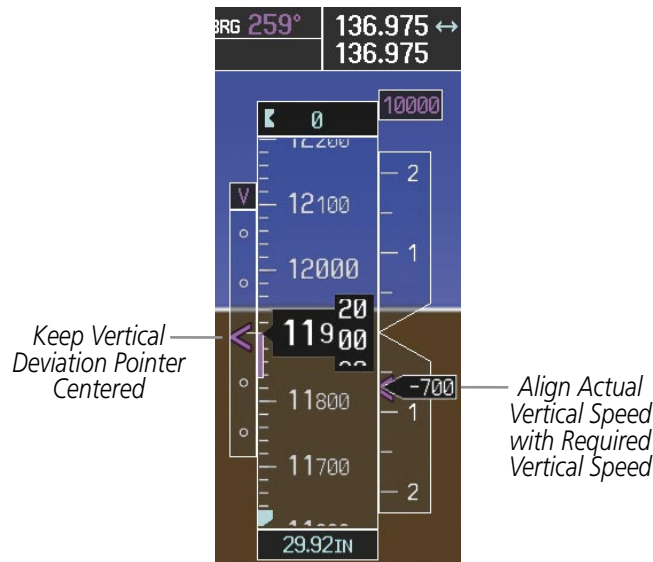

Figure 5-120 VDI & RVSI Showing Correctly Established Descent

- 17) When the aircraft is one minute from the bottom of descent (BOD) this is annunciated as shown in Figure 5-121. Upon reaching the offset waypoint for OPSHN, the aircraft is at 10,000 feet.



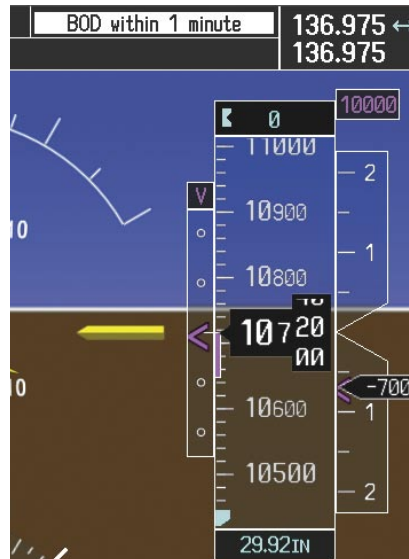

Figure 5-121 Approaching Bottom of Descent (BOD) at OPSHN Offset Waypoint

- 18) The aircraft is approaching OPSHN. The upcoming turn and next heading is annunciated at the top left of the PFD as seen in Figure 5-122. Initiate the turn and maneuver the aircraft on a track through the turn radius to intercept the magenta line for the OPSHN to FSHER leg and center the CDI.

- 19) After passing OPSHN, the next leg of the arrival turns magenta as shown in Figure 5-123. The magenta Map Pointer in the flight plan list now indicates the OPSHN to FSHER leg of the arrival procedure is now active.

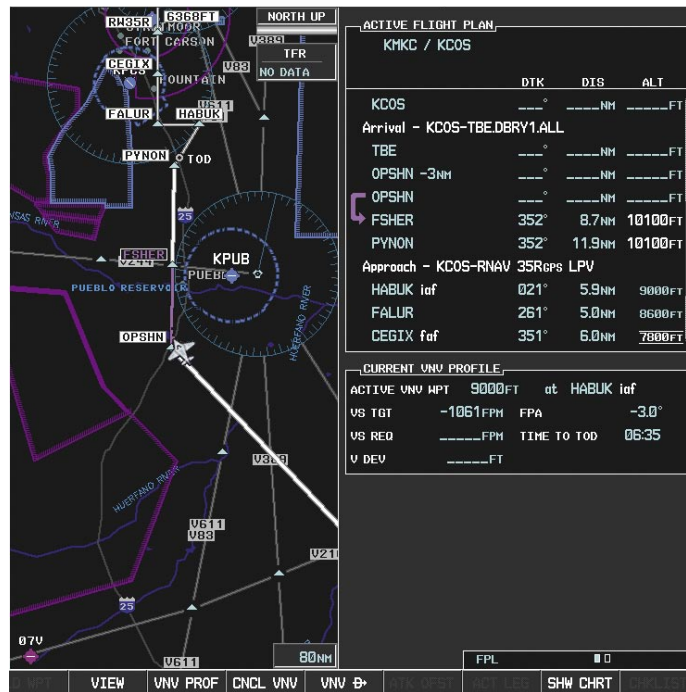

Figure 5-123 Tracking the OPSHN to FSHER Leg

- 20) The flight continues through the arrival procedure to PYNON (see Figure 5-124). At a point 31 nautical miles from the destination airport, the phase of flight scaling for the CDI changes to Terminal Mode and is annunciated by displaying 'TERM' on the HSI.

The next leg contains a descent to HABUK. Note the TOD point on the map. Annunciations for the upcoming turn and descent, as well as the VDI and RVSI, appear on the PFD as the flight progresses.

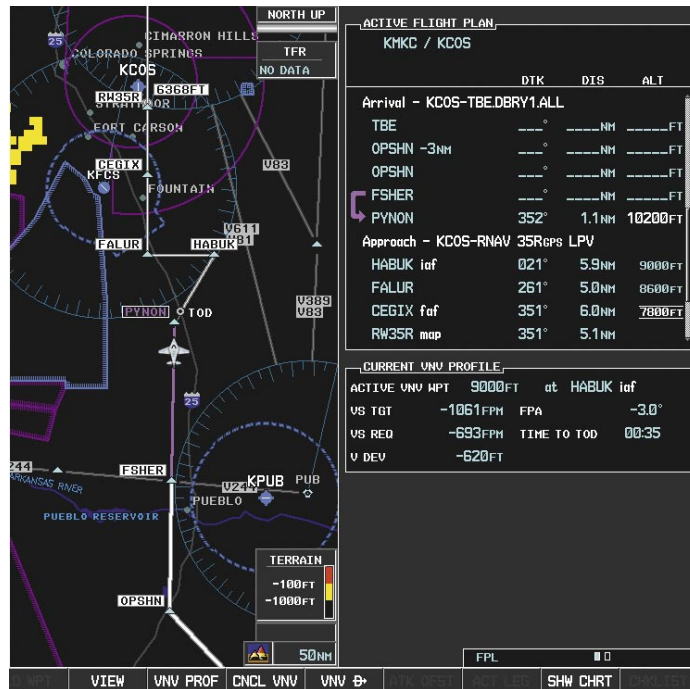
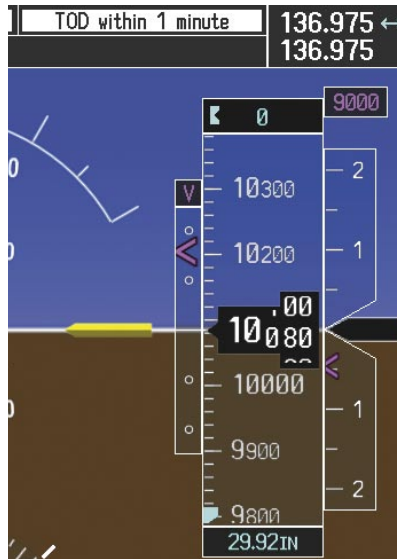

Figure 5-124 Approaching PYNON

- 21) Upon passing PYNON the approach procedure automatically becomes active. The approach may be activated at any point to proceed directly to the IAF. In this example, the aircraft has progressed through the final waypoint of the arrival and the flight plan has automatically sequenced to the IAF as the active leg, activating the approach procedure (see Figure 5-125).

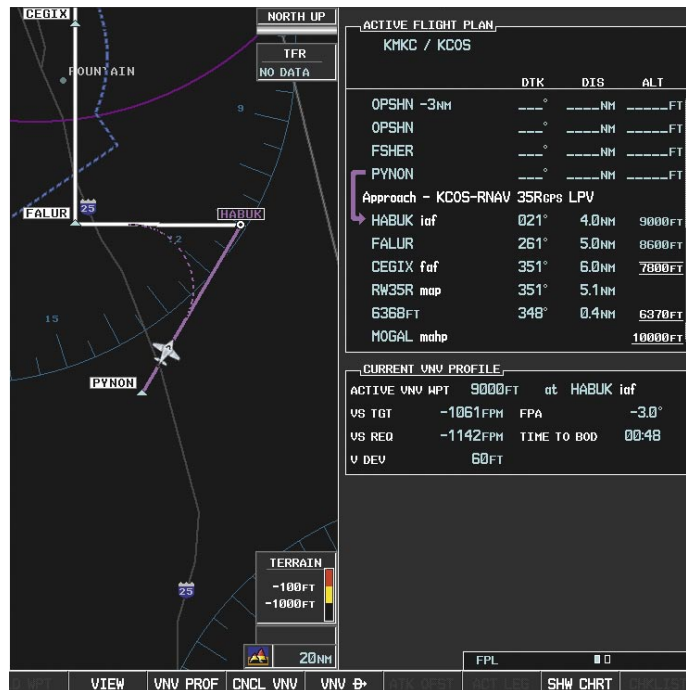

Figure 5-125 Approach is Now Active

To manually activate the approach procedure, perform the following steps:

- Press the **PROC** Key.
- Turn the large **FMS** Knob to highlight 'ACTIVATE APPROACH' as shown in Figure 5-126.

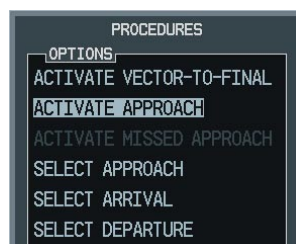

Figure 5-126 Manually Activate Approach

- Press the **ENT** Key to activate the approach.
- 22) The IAF is the next waypoint. At the TOD, establish a descent vertical speed as previously discussed in Step 16. The aircraft altitude is 9,000 feet upon reaching HABUK.

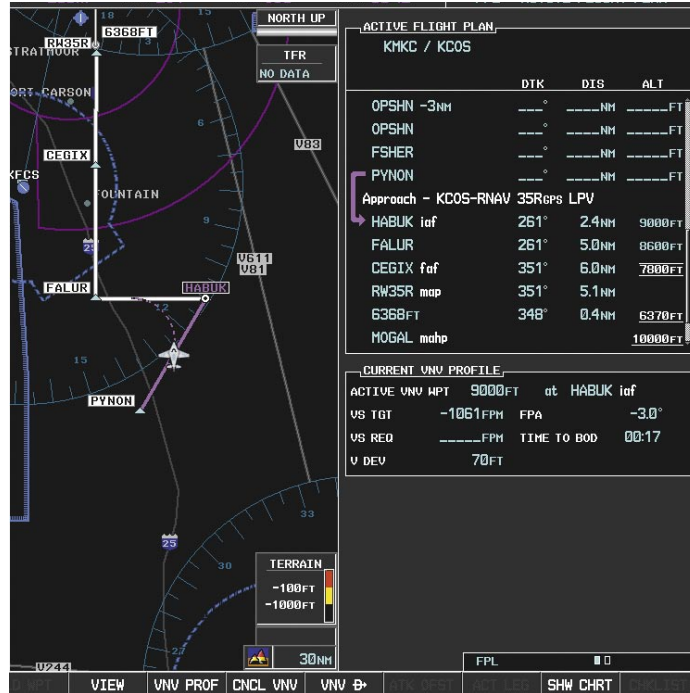

Figure 5-127 Descending Turn to the Initial Approach Fix (IAF)

- 23) After crossing FALUR the next waypoint is the FAF. The flight phase changes to LPV on the HSI indicating the current phase of flight is in Approach Mode and the approach type is LPV. CDI scaling changes accordingly and is used much like a localizer when flying an ILS approach. The RVSI is no longer displayed and the VDI changes to the Glidepath Indicator (as shown in Figure 5-128) when the final approach course becomes active.

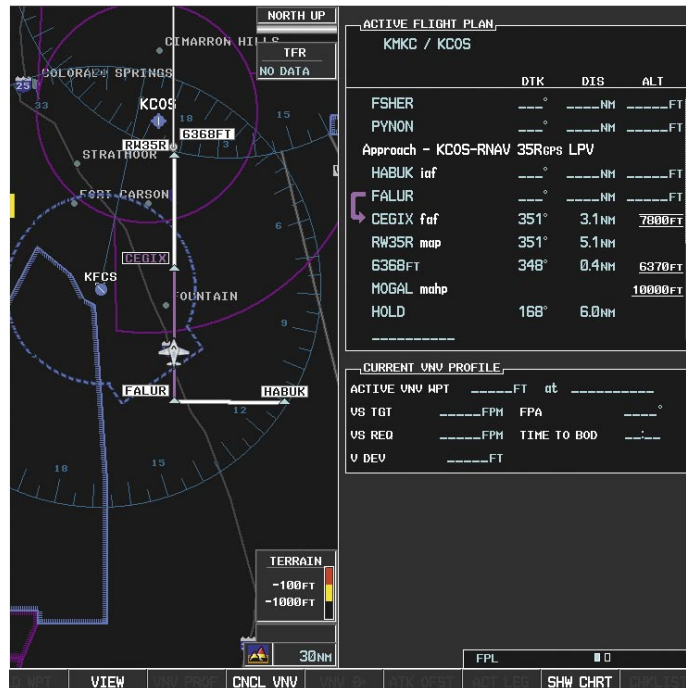

Figure 5-128 Descending to the FAF

The descent continues through the FAF (CEGIX) using the Glidepath Indicator, as one would use a glideslope indicator, to obtain an altitude "AT" 7,800 feet at the FAF. Note the altitude restriction lines over and under (At) the altitude in the 'ALT' field.

- 24) After crossing CEGIX, the aircraft continues following the glidepath to maintain the descent to "AT or ABOVE" 6,370 feet at the Missed Approach Point (MAP) (RW35R) as seen in Figure 5-129.

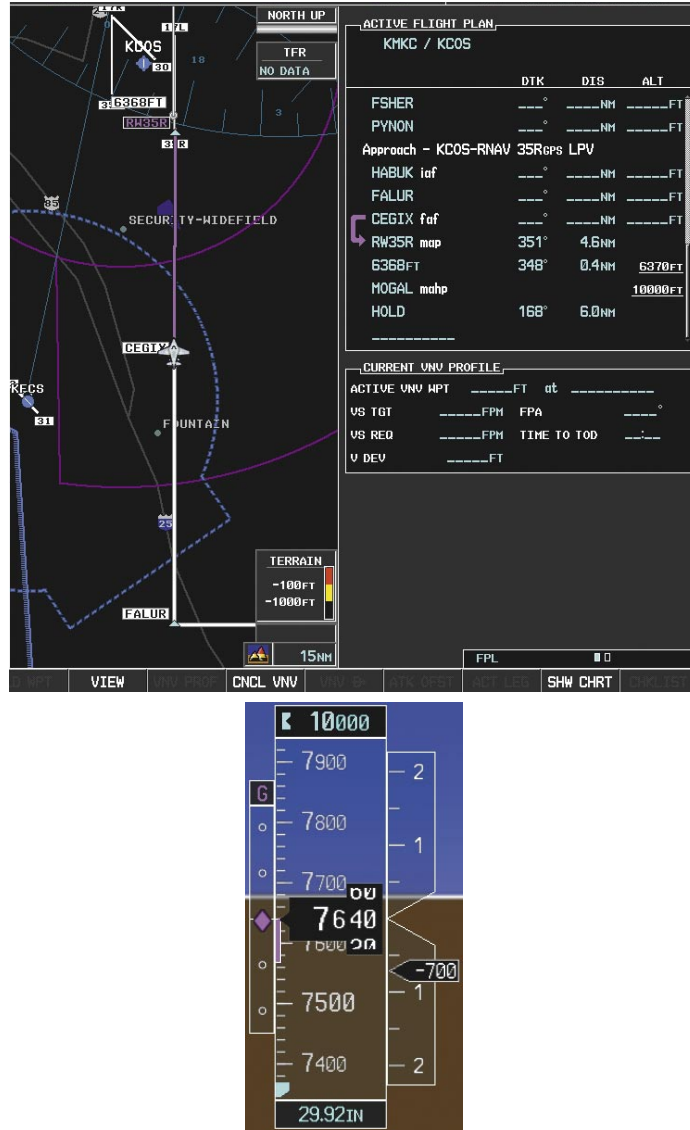

Figure 5-129 Descending to the Missed Approach Point

In this missed approach procedure, the fix immediately following the MAP (in this case '6368FT') is not part of the published procedure. It is simply a fix that defines a leg which guides the aircraft along the runway centerline until the required altitude to make the first turn on the missed approach is exceeded. In this case, if the aircraft altitude is below the specified altitude (6,368 feet) after crossing the MAP, a direct-to is established to this fix until an altitude of 6,368 feet reached. After reaching 6,368 feet, a direct-to is established to the published fix (in this case MOGAL). If the aircraft altitude is above the specified altitude after crossing the MAP, a direct-to is established to the published fix (MOGAL) to begin the missed approach procedure. The altitude constraint value defaults to 400 feet AGL when the fix is not part of the published procedure.

In some missed approach procedures this altitude fix may be part of the published procedure. For example, the procedure dictates a climb to 5,500 feet, then turn left and proceed to the Missed Approach Hold Point (MAHP). In this case, the altitude fix would be labeled '5500FT'. Again, if the aircraft altitude is lower than this prescribed altitude, a direct-to is established to this fix when the missed approach procedure is activated.

- 25) Upon reaching the MAP, it is decided to execute a missed approach. Automatic waypoint sequencing is suspended past the MAP. Select the **SUSP** Softkey on the PFD to resume automatic waypoint sequencing through the missed approach procedure.

A direct-to is initiated to MOGAL, which is the Missed Approach Hold Point (MAHP) as seen in Figure 5-130. The aircraft is climbing to 10,000 feet. The CDI flight phase now changes from LPV to MAPR as seen on the HSI.

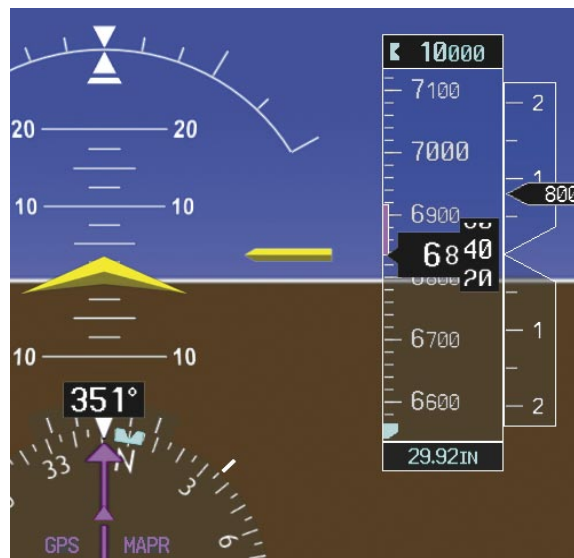
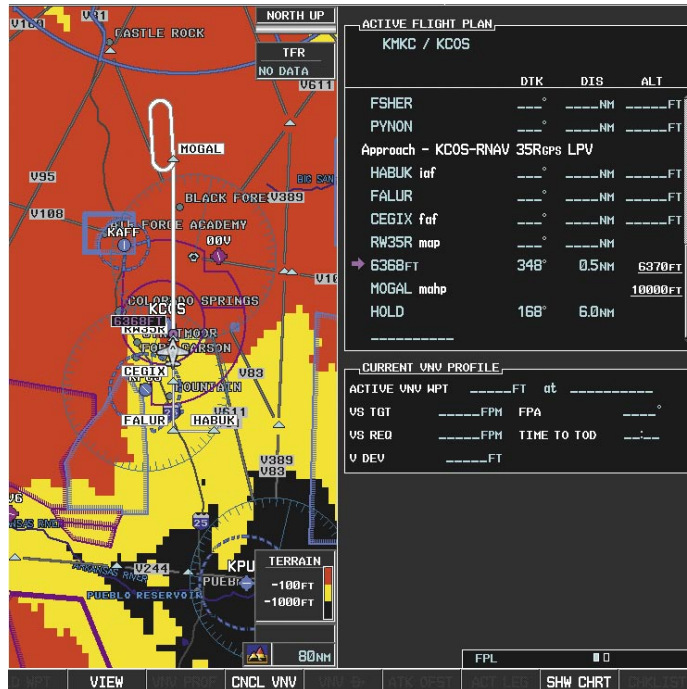

Figure 5-130 Missed Approach Active



- 26) The aircraft continues climbing to "AT or ABOVE" 10,000 feet at MOGAL. A holding pattern is established at the MAHP (MOGAL) as shown in Figure 5-131.



Figure 5-131 Establishing the Holding Pattern

- 27) The aircraft maintains 10,000 feet while following the magenta line through the hold as in Figure 5-132.

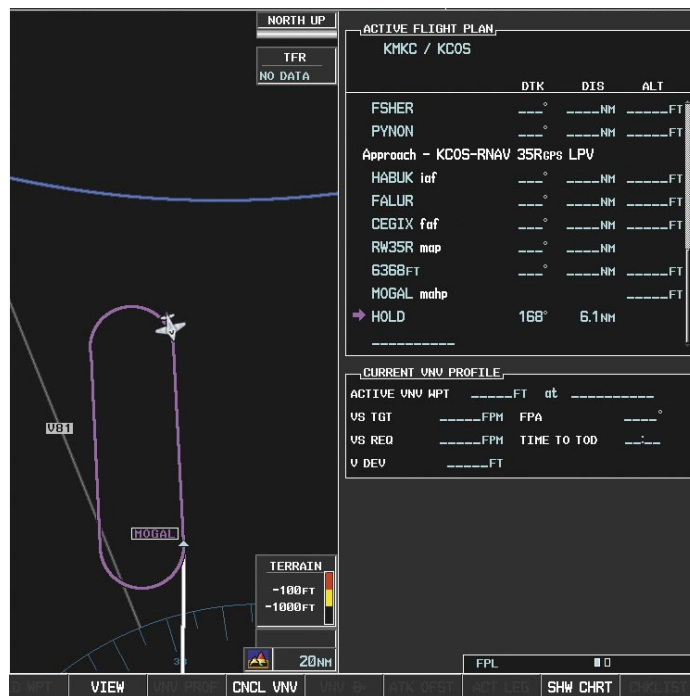

Figure 5-132 Hold Established

## PARALLEL TRACK (PTK)



**NOTE:** Enroute/Terminal VNV (baro-VNV) is disabled when parallel track is active. This causes vertical deviation to flag and the autopilot to uncouple from VNV. Parallel track disregards all vertical aspects of the flight plan; that is, parallel track ignores baro-VNV.

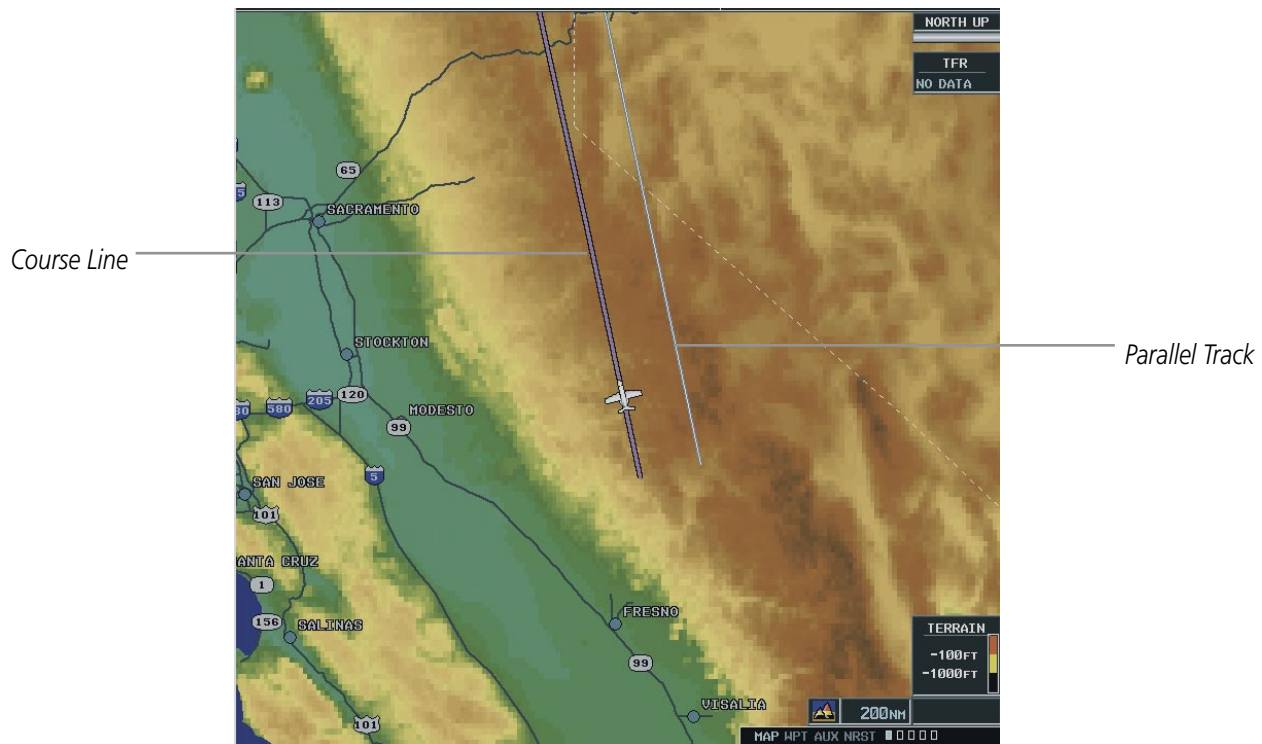

Figure 5-133 Navigation Map Showing Parallel Track

The Parallel Track (PTK) menu option allows a parallel course offset of 1 to 99 nm to the left or right of the current flight plan. Parallel Track cannot be activated if a course is set using Direct-to or if the active leg is the first leg of the departure procedure, or the Initial Approach Fix (IAF) has been passed. Attempting to activate parallel track with these conditions results in the message 'PARALLEL TRACK UNAVAILABLE INVALID ROUTE GEOMETRY'.



Figure 5-134 Parallel Track Menu Option

When Parallel Track is activated, the course line drawn on the map pages shows the parallel course, and waypoint names will have a lower case “p” placed after the identifier.

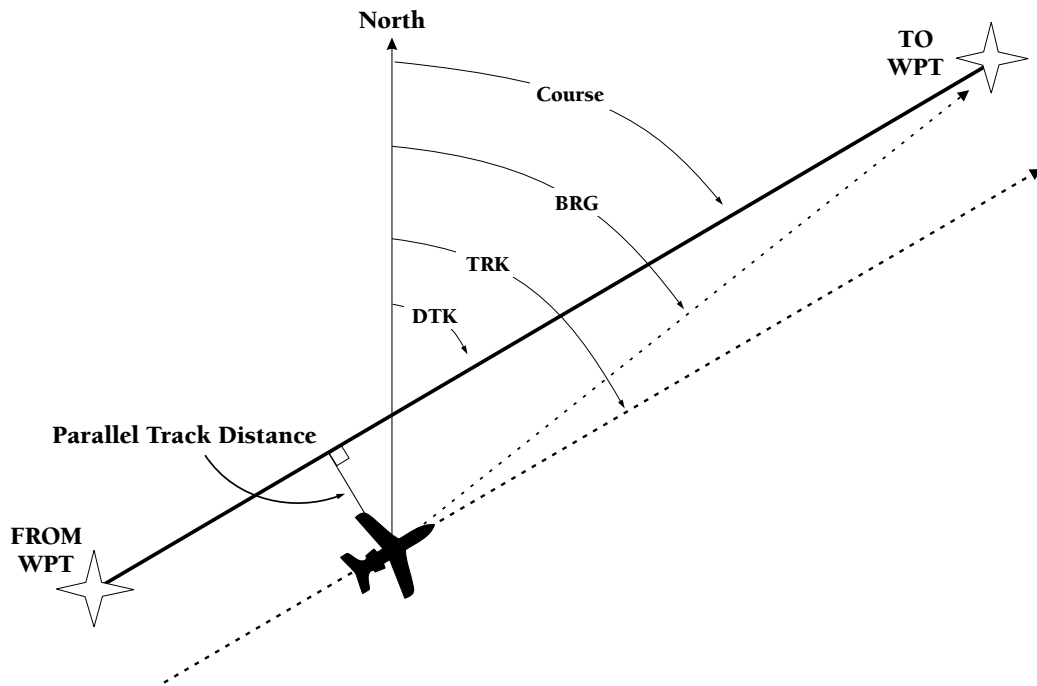

Figure 5-135 Parallel Track

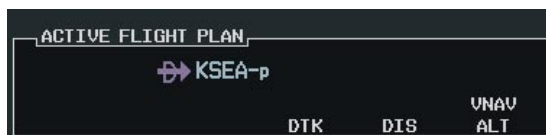

Figure 5-136 Parallel Track “p” Designation

Using Direct-to, loading an approach, holding pattern, or editing and executing the flight plan automatically cancels Parallel Track. Parallel track is cancelled if a course change occurs greater than 120° or the parallel tracks overlap as a result of the course change.

### Activating parallel track:

- 1) Select the **MENU** Key from the Active Flight Plan Page.
- 2) Select 'Parallel Track'.
- 3) Press the **ENT** Key. The direction field is highlighted.
- 4) Select 'Left' or 'Right'.
- 5) Press the **ENT** Key. The 'DISTANCE' field is highlighted.
- 6) Enter a distance from 1-99 nm.
- 7) Press the **ENT** Key.
- 8) With 'ACTIVATE PARALLEL TRACK' highlighted, press the **ENT** Key (Figure 5-132).
- 9) Press the **FMS** Knob or the **CLR** Key to remove the Parallel Track Window.



Figure 5-137 Activate PT Option

## ARRIVAL ALERTS

---

The Arrival Alert Box on the System Setup Page allows arrival alerts to be turned on/off and the alert trigger distance set. An arrival alert can be set to notify the pilot with a message upon reaching a user-specified distance from the final destination (the direct-to waypoint or the last waypoint in a flight plan). Once the set distance (up to 99.9 units) has been reached, an “Arrival at [waypoint]” message is displayed in the PFD Navigation Status Box.

### Enabling/disabling an arrival alert:

- 1) Use the **FMS** Knob to select the AUX - System Setup Page.
- 2) Press the **FMS** Knob momentarily to activate the flashing cursor.
- 3) Turn the large **FMS** Knob to select the ON/OFF field in the Arrival Alert Box.
- 4) Turn the small **FMS** Knob clockwise to turn the airspace alert ON or counterclockwise to turn the alert OFF.

### Changing the arrival alert trigger distance:

- 1) Use the **FMS** Knob to select the AUX - System Setup Page.
- 2) Press the **FMS** Knob momentarily to activate the flashing cursor.
- 3) Turn the large **FMS** Knob to highlight the distance field in the Arrival Alert Box.
- 4) Use the **FMS** Knob to enter a trigger distance and press the **ENT** Key.

## 5.21 FLIGHT PLANNING (PFD)

Flight planning on the PFD centers around the Flight Plan Window where flight plans can be created, edited, and activated. The Flight Plan Window is enabled and disabled by pressing the **FPL** Key.



Figure 5-138 Flight Plan Window

### OPERATIONS

The following operations can be performed using the Flight Plan Window Menu.

- Activate leg
- Store, invert, or delete flight plan
- Load or remove departure, arrival, or approach
- Closest Point of FPL
- Restore defaults
- Parallel track

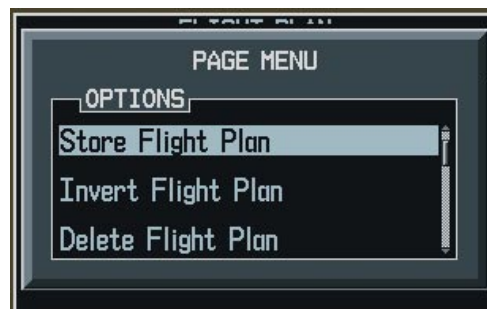

Figure 5-139 Flight Plan Page Menu

## CREATE NEW FLIGHT PLAN

Up to 99 flight plans with up to 99 waypoints in each flight plan can be created and stored in memory.

### Creating a new flight plan:

- 1) Press the **FPL** Key.
- 2) Press the **FMS** Knob to activate the cursor. The waypoint field is highlighted.
- 3) Enter the identifier, city/state, or facility name of the airport/waypoint.
- 4) Press the **ENT** Key. The cursor flashes on the next empty waypoint field.
- 5) Enter the identifier for each additional waypoint.
- 6) Press the **FPL** Key to remove the window.

## ACTIVATE LEG

'Activate Leg' selects the highlighted leg as the "active leg" (the flight plan leg which is currently used for navigation guidance).

### Activating a flight plan along a specific leg:

- 1) From the Flight Plan Window, press the **FMS** Knob to activate the cursor.
- 2) Highlight the desired destination waypoint.
- 3) Press the **MENU** Key.
- 4) Highlight 'Activate Leg'.
- 5) Press the **ENT** Key. A confirmation window is displayed with 'ACTIVATE' highlighted.
- 6) Press the **ENT** Key.

## STORE FLIGHT PLAN

The active flight plan is erased when the G1000 is powered off or when another flight plan is activated. When storing flight plans with an approach, departure or arrival, the G1000 uses the waypoint information from the current database to define the waypoints in the flight plan. If the navigation database is changed or updated, the G1000 automatically updates the information if the procedure has not been modified. If an approach, departure or arrival procedure is no longer available, the flight plan becomes "locked" until the procedure is deleted from the flight plan or until the correct navigation database is installed.

### Storing a flight plan:

- 1) From the Flight Plan Window (once all of the waypoints have been entered), press the **MENU** Key to display the page menu.
- 2) Select 'Store Flight Plan'.
- 3) Press the **ENT** Key. The Store Flight Plan Window is displayed with 'OK' highlighted.
- 4) Press the **ENT** Key to store the flight plan in the next available memory slot.
- 5) Press the **ENT** Key.

## INVERT FLIGHT PLAN

### Activating an existing flight plan in reverse:

- 1) From the Flight Plan window, press the **MENU** Key.
- 2) Highlight 'Invert Flight Plan'.
- 3) Press the **ENT** Key. A confirmation window is displayed.
- 4) Select 'OK'.
- 5) Press the **ENT** Key. The flight plan is now reversed and activated.

## DELETE FLIGHT PLAN

The entire flight plan or selected waypoints within the flight plan may be deleted.

### Deleting the entire flight plan:

- 1) From the Flight Plan Window, press the **MENU** Key.
- 2) Highlight 'Delete Flight Plan'.
- 3) Press the **ENT** Key.
- 4) Press the **ENT** Key to delete all waypoints in the flight plan.

### Deleting selected waypoints in the flight plan:

- 1) From the Flight Plan Window, select the desired waypoint.
- 2) Press the **CLR** Key. The 'Remove Waypoint Name?' Window is displayed with 'OK' highlighted.
- 3) Press the **ENT** Key.

## CLOSEST POINT OF FPL

'Closest Point of FPL' calculates the bearing and closest distance at which a flight plan passes a reference waypoint. It may also be used to create a new user waypoint along the flight plan at the location closest to a chosen reference waypoint.

### Determining the closest point along the active flight plan to a selected waypoint:

- 1) From the Flight Plan Window, press the **MENU** Key.
- 2) Highlight 'Closest Point of FPL'. Press the **ENT** Key. A window appears with the reference waypoint field highlighted.
- 3) Enter the identifier of the reference waypoint.
- 4) Press the **ENT** Key. The G1000 displays the bearing (BRG) and distance (DIS) to the closest point along the flight plan from the selected reference waypoint.
- 5) To create a user waypoint at this location and add it to the flight plan, press the **ENT** Key. The name for the new user waypoint is derived from the identifier or the reference waypoint.



### PARALLEL TRACK (PFD)

The Parallel Track (PTK) function allows a parallel course offset of 1 to 99 nm to the left or right of the current flight plan. Parallel Track cannot be activated if a course is set using Direct-To or if the active leg is the first leg of the departure procedure, or the Initial Approach Fix (IAF) has been passed. Attempting to activate Parallel Track with these conditions results in the message 'PARALLEL TRACK UNAVAILABLE INVALID ROUTE GEOMETRY'. When Parallel Track is activated, the course line drawn on the map pages shows the parallel course, and waypoint names will have a lower case "p" located after the identifier (Figure 5-140).

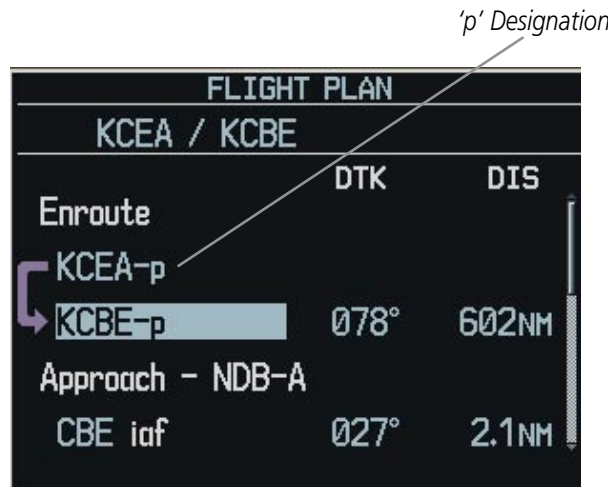

Figure 5-140 Parallel Track 'p' Designation

Using Direct-To, loading an approach, holding pattern, or editing and executing the flight plan automatically cancels Parallel Track. Parallel track is cancelled if a course change occurs greater than 120° or the parallel tracks overlap as a result of the course change.

#### Activating parallel track:

- 1) Press the **MENU** Key from the Active Flight Plan Page.
- 2) Select 'Parallel Track'.
- 3) Press the **ENT** Key. The Direction field is highlighted.
- 4) Select 'Left' or 'Right'.
- 5) Press the **ENT** Key. The 'Distance' field is highlighted.
- 6) Enter a distance from 1-99 nm.
- 7) Press the **ENT** Key.
- 8) With 'ACTIVATE PARALLEL TRACK' highlighted, press the **ENT** Key.

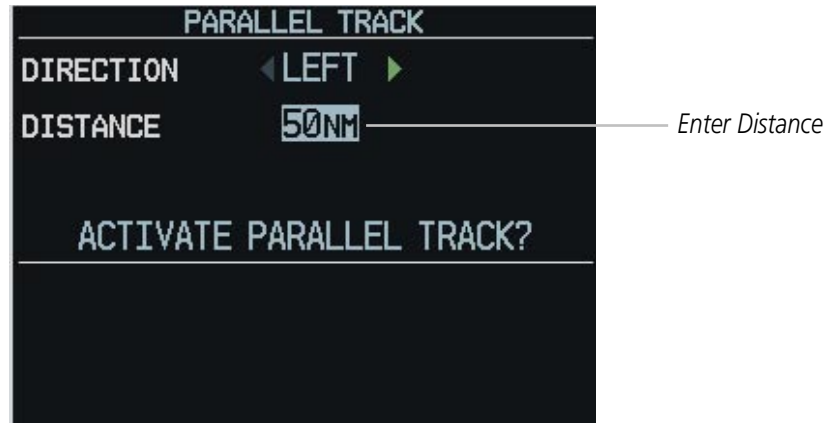

Figure 5-141 Parallel Track Distance Field

**Cancelling parallel track:**

- 1) Press the **MENU** Key from the Active Flight Plan Page.
- 2) Select 'Parallel Track'.
- 2) Select 'CANCEL PARALLEL TRACK'.
- 3) Press the **ENT** Key.

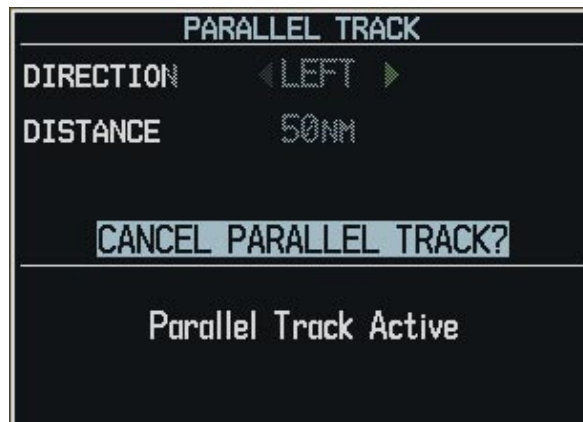

Figure 5-142 Cancelling Parallel Track

## 5.22 PROCEDURES (MFD)



**NOTE:** If any portion of an arrival procedure is the active leg of a flight plan, the existing arrival procedure must be deleted before changing to a different arrival procedure.

### LEG TYPES SUPPORTED BY THE G1000

There are currently 23 different database leg types. All 23 published procedures and leg types are supported by the G1000.

- AF - DME arc to a fix
- CF – Course to a fix
- DF – Direct to a fix
- FA – Course from fix to an altitude
- FC – Course from fix to distance
- FD – Course from fix to DME distance
- FM – Course from fix to manual termination
- HA – Hold terminating at altitude
- HF – Hold terminating at a fix
- HM – Hold with manual termination
- IF – Initial fix
- PI – Procedure turn to course intercept
- RF – Constant radius turn to fix
- TF – Track between two fixes
- CA – Course to an altitude
- CD – Course to a DME distance
- CI – Course to an intercept
- CR – Course to a radial
- VA – Heading vector to an altitude
- VD – Heading vector to DME distance
- VI – Heading vector to an intercept
- VM – Heading vector to manual termination
- VR – Heading vector to a radial



**NOTE:** The G1000 supports vertical navigation for all lateral leg types except for CA, CI, FA, FM, HA, HM, PI, VA, VD, VI, VR, and VM.

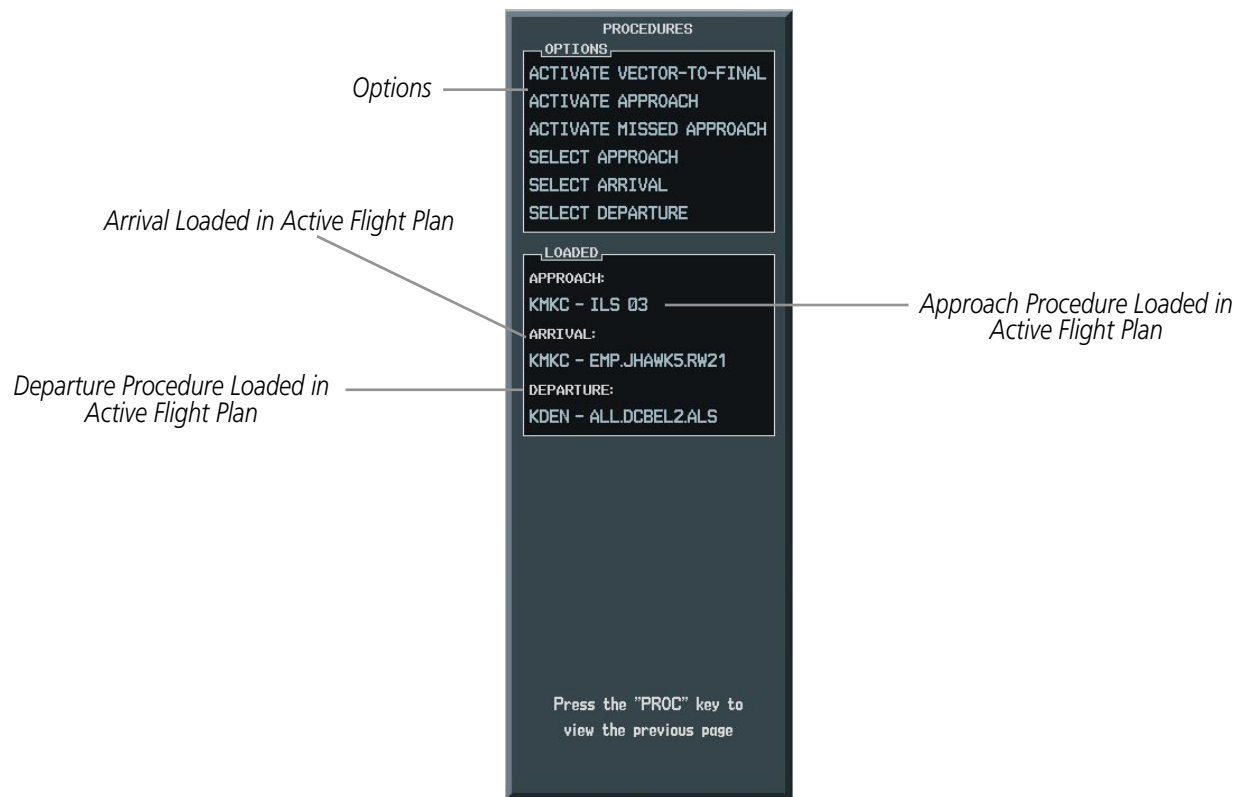

Figure 5-143 Procedures Window

## DEPARTURES

### Loading and activating a departure procedure:

- 1) Press the **PROC** Key. The Procedures Window is displayed.
- 2) Highlight 'SELECT DEPARTURE'.
- 3) Press the **ENT** Key. The DEPARTURE window is displayed on the 'PROC – DEPARTURE LOADING Page.
- 4) Select a departure.
- 5) Press the **ENT** Key. The RUNWAY window may be displayed.
- 6) Select a runway.
- 7) Press the **ENT** Key. The TRANSITION window may be displayed.
- 8) Select a transition.
- 9) Press the **ENT** Key.
- 10) With 'LOAD' highlighted, press the **ENT** Key. The departure procedure is displayed as part of the overall flight plan and is placed in front of the enroute flight plan.

### OR:

- 1) With the Departure Information Page displayed, press the **FMS** Knob to activate the cursor.
- 2) Enter an identifier, facility name or city location field.

- 3) Press the **ENT** Key until the DEPARTURE window is displayed.
- 4) Select a departure.
- 5) Press the **ENT** Key. The RUNWAY window may be displayed.
- 6) Select a runway.
- 7) Press the **ENT** Key. The TRANSITION window may be displayed.
- 8) Select a transition.
- 9) Press the **ENT** Key. The departure is now ready to load.
- 10) Press the **FMS** Knob to remove the cursor.

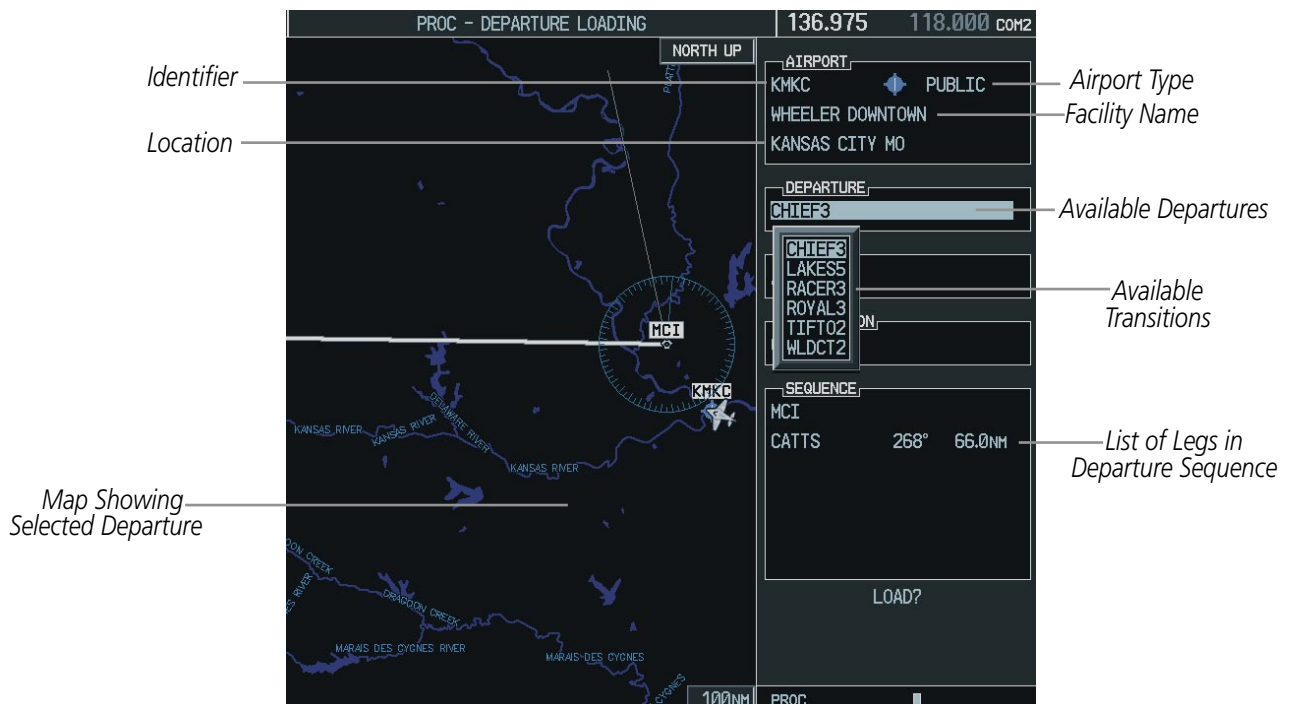

**Figure 5-144 Departure Information Page**

**Activating a departure leg:**

- 1) Select the **FPL** Key.
- 2) Press the **FMS** Knob to activate the cursor.
- 3) Turn the large **FMS** Knob to highlight the desired waypoint within the departure.
- 4) Press the **ACT LEG** Softkey. A confirmation window showing the selected leg is displayed.
- 5) With 'ACTIVATE' highlighted, press the **ENT** key.



Figure 5-145 Activate Leg Option

**Viewing a departure airport:**

- 1) Select the first page in the Waypoint Page Group.
- 2) Press the **MENU** Key.
- 3) Highlight 'View Departure Airport'.
- 4) Press the **ENT** Key. The Departure Airport Page is displayed.

**OR:**

- 1) Select the first page in the Waypoint Page Group.
- 2) Press the **MENU** Key.
- 3) Highlight 'View Departure Airport'.
- 4) Press the **ENT** Key. The Departure Information Page is displayed.
- 5) Enter an identifier, facility, or city name for the departure airport.

**Removing a departure:**

- 1) From the Active Flight Plan Page, press the **MENU** Key.
- 2) Select the 'Remove Departure' option.
- 3) Press the **ENT** Key. A confirmation window is displayed listing the procedure.
- 4) With 'OK' highlighted, press the **ENT** Key. To cancel the removal request, highlight 'CANCEL' and press the **ENT** Key.

ARRIVAL OPERATIONS

Loading an arrival procedure:

- 1) Select the 'WPT' page group.
- 2) Select the first rectangular page icon.
- 3) Press the **STAR** Softkey.

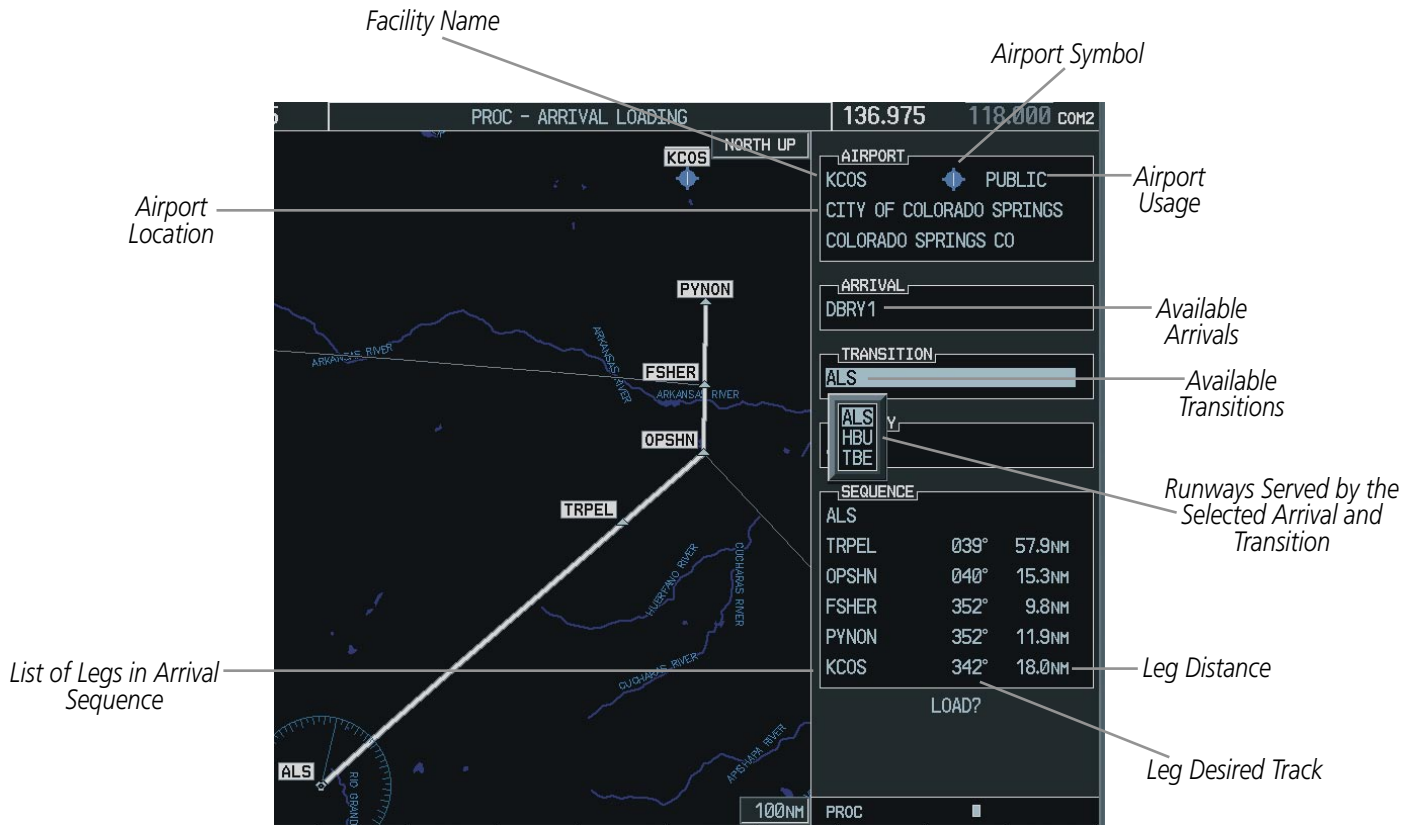

Figure 5-146 Arrival Information Page

- 4) Select an arrival.
- 5) Press the **ENT** Key. The TRANSITION window is displayed.
- 6) Select a transition.
- 7) Press the **ENT** Key. The RUNWAY window may be displayed. If so, select a runway.
- 8) Press the **ENT** Key.
- 9) With 'LOAD' highlighted, press the **ENT** Key. The arrival procedure is displayed as part of the overall flight plan and is placed at the end of the enroute flight plan.

OR:

- 1) Press the **PROC** Softkey.
- 2) Highlight 'SELECT ARRIVAL'.

- 3) Press the **ENT** Key. The ARRIVAL window is displayed on the 'PROC – ARRIVAL LOADING' Page.
- 4) Select an arrival.
- 5) Press the **ENT** Key. The TRANSITION window is displayed.
- 6) Select a transition.
- 7) Press the **ENT** Key. The RUNWAY window may be displayed. If so, select a runway.
- 8) Press the **ENT** Key.
- 9) With 'LOAD' highlighted, press the **ENT** Key. The arrival procedure is displayed as part of the overall flight plan and is placed at the end of the enroute flight plan.

**OR:**

- 1) Select the first page in the Waypoint Information Group.
- 2) Press the **MENU** Key.
- 3) Highlight 'Load Arrival'.
- 4) Press the **ENT** Key. The Active Flight Plan Page is displayed. The arrival procedure is displayed as part of the overall flight plan and is placed at the end of the enroute flight plan.

**Removing an arrival:**

- 1) From the Active Flight Plan Page, press the **MENU** Key.
- 2) Select the 'Remove Approach', 'Remove Arrival' or 'Remove Departure' option.
- 3) Press the **ENT** Key. A confirmation window is displayed listing the procedure.
- 4) With 'OK' highlighted, press the **ENT** Key. To cancel the removal request, highlight 'CANCEL' and press the **ENT** Key.



## APPROACH OPERATIONS

Not all approaches in the database are approved for GPS use. When selecting an approach, a “GPS” designation to the right of the procedure name indicates the procedure can be flown using the GPS receiver. Some procedures do not have this designation, meaning the GPS receiver can be used for supplemental navigation guidance only. If the GPS receiver cannot be used for primary guidance, the appropriate navigation receiver must be used for the selected approach (e.g., VOR or ILS). The final course segment of ILS approaches, for example, must be flown by tuning the NAV receiver to the proper frequency and selecting that NAV receiver on the CDI.

The G1000 WAAS GPS allows for flying LNAV, LNAV/VNAV, and LPV approaches according to the published chart. The active approach type is annunciated on the HSI as shown in Table 5-4:

| HSI ANNUNCIATION | DESCRIPTION   |
|------------------|---|
| LNAV             | GPS approach using published LNAV minima.   |
| LNAV+V           | GPS approach using published LNAV minima. Advisory vertical guidance is provided. |
| L/VNAV           | GPS approach using published LNAV/VNAV minima.                                    |
| LPV              | GPS approach using published LPV minima.  |

Table 5-4 HSI WAAS Approach Annunciations



Figure 5-147 Selecting an Approach

#### Load and/or activate an approach procedure:

- 1) Press the **PROC** Key.
- 2) Highlight 'SELECT APPROACH'.
- 3) Press the **ENT** Key. A list of available approaches for the destination airport is displayed.
- 4) Turn the **FMS** Knob to highlight the desired approach. The WAAS channel and ID for the selected approach procedure are displayed in the 'APPROACH CHANNEL' field.
- 5) Press the **ENT** Key. A list of available transitions for the selected approach procedure is now displayed.
- 6) Turn either **FMS** Knob to selected the desired transition. The "Vectors" option assumes vectors are received to the final course segment of the approach and provides navigation guidance relative to the final approach course.

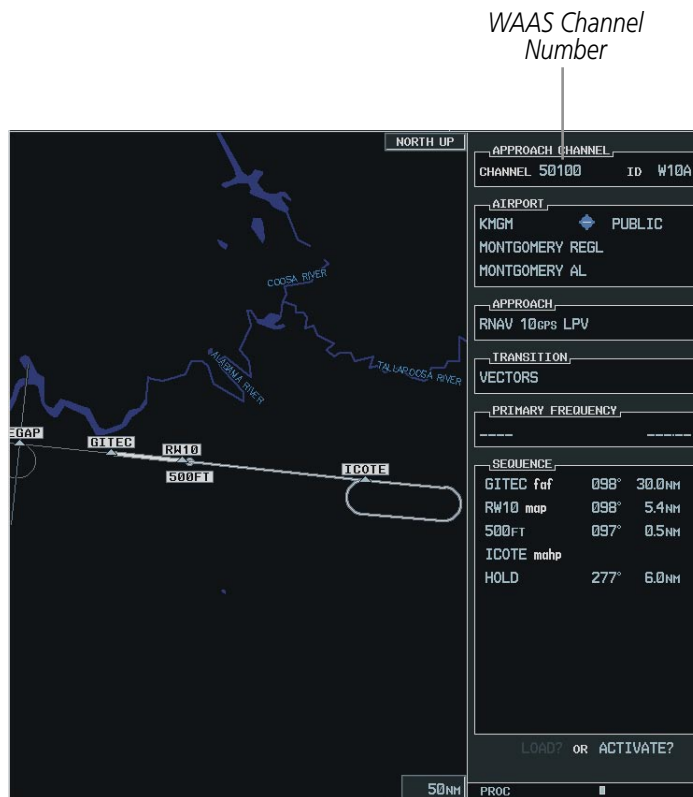

Figure 5-148 WAAS Channel Number and ID

- 7) Press the **ENT** Key. 'ACTIVATE?' is now displayed. Selecting 'LOAD?' enters the selected approach procedure into the active flight plan, without activating it. Selecting 'ACTIVATE?' enters the selected approach procedure into the active flight plan and makes it immediately active.
- 8) Turn the large **FMS** Knob to select either 'LOAD?' or 'ACTIVATE?'.
- 9) Press the **ENT** Key.



Figure 5-149 Not Approved for GPS Message

OR:

- 1) Select the Nearest Airports Page.
- 2) Select the desired nearest airport.
- 3) Press the **APR** Softkey located at the bottom of the display. The **LD APR** (load approach) Softkey becomes available.

- 4) Select the desired approach.
- 5) Select the **LD APR** Softkey. The Approach Loading Page is displayed with the transitions field highlighted.
- 6) Select the desired transition.
- 7) Press the **ENT** Key. The 'LOAD?' field is highlighted.
- 8) Press the **ENT** Key to load the approach. If navigating a flight plan previous to loading this approach, the G1000 continues navigating the flight plan until the approach is activated.
- 9) Highlight the 'ACTIVATE' field.
- 10) Press the **ENT** Key to activate the approach and begin navigating to the IAP.
- 11) If the approach is not approved for GPS, a 'NOT APPROVED FOR GPS' message is displayed with 'YES' highlighted. Press the **ENT** Key to acknowledge the message (or select 'NO').
- 12) Press the **ENT** Key to return to the Approach Loading Page.

**OR:**

- 1) From any page, press the **PROC** Key.
- 2) Highlight 'SELECT APPROACH'.
- 3) Press the **ENT** Key. The APPROACH window is displayed on the 'PROC – APPROACH LOADING' Page.
- 4) Select an approach.
- 5) Press the **ENT** Key. The TRANSITION window is displayed.
- 6) Select a transition (the 'VECTORS' option assumes vectors are received to the final course segment of the approach and provides navigation guidance relative to the final approach course.)
- 7) Press the **ENT** Key.

- 8) Highlight 'LOAD?' or 'ACTIVATE?'. 'LOAD' adds the approach to the flight plan without immediately using the approach for navigation guidance. This allows for the original flight plan to continue navigating until cleared for the approach, but keeps the approach available for quick activation when needed. 'ACTIVATE' adds the approach to the flight plan and begins navigating the approach course.
  - 9) If the approach is not approved for GPS, a 'NOT APPROVED FOR GPS' message is displayed with 'YES' highlighted. Press the **ENT** Key to acknowledge the message. To cancel the approach, select 'NO' and press the **ENT** Key.
- OR:**
- 1) From the Approach Loading Page, highlight the 'CHANNEL' field.



Figure 5-150 WAAS Channel Selection

- 2) Enter the desired channel number.
- 3) Press the **ENT** Key. The TRANSITION window is displayed.
- 4) Select a transition (the 'VECTORS' option assumes vectors are received to the final course segment of the approach and provides navigation guidance relative to the final approach course).
- 5) Press the **ENT** Key.

- 6) Highlight 'LOAD?' or 'ACTIVATE?'. 'LOAD' adds the approach to the flight plan without immediately using the approach for navigation guidance. This allows for the original flight plan to continue navigating until cleared for the approach, but keeps the approach available for quick activation when needed. 'Activate' adds the approach to the flight plan and begins navigating the approach course.

#### **Removing an approach from a direct-to or active flight plan:**

- 1) From the Flight Plan Page, press the **MENU** Key.
- 2) Highlight 'Remove Departure', 'Remove Arrival', or 'Remove Approach'
- 3) Press the **ENT** Key. A confirmation window appears listing the procedure that is about to be removed with 'OK' highlighted.
- 4) Press the **ENT** Key.

Another Procedures Window option allows vectors to the final approach course.

#### **Activating a (previously loaded) approach, with vectors to final:**

- 1) Press the **PROC** Key to display the Procedures Window.
- 2) Highlight 'ACTIVATE VECTOR-TO-FINAL' and press the **ENT** Key.

In many cases, it may be easiest to "Load" the full approach while still some distance away, enroute to the destination airport. Later, if vectored to final, use the steps above to select 'Activate Vector-To-Final' — which makes the inbound course to the FAF waypoint active. Otherwise, activate the full approach using the 'ACTIVATE APPROACH' option.

#### **Activating a missed approach in the active flight plan:**

- 1) Press the **PROC** Key.
- 2) Highlight 'ACTIVATE MISSED APPROACH'.
- 3) Press the **ENT** Key. A confirmation window is displayed.
- 4) With 'ACTIVATE' highlighted, press the **ENT** Key.

### COURSE TO FIX

In certain missed approach procedures, a fix appears immediately following the MAP (Figure 5-151, '990 ft'). This is not necessarily part of the published procedure, it simply represents a course to an altitude fix.

In certain cases, if the aircraft altitude is below the specified altitude (990 feet) after crossing the MAP, a direct-to is established to this fix until an altitude of 990 feet reached. After reaching 990 feet, a direct-to is established to the published fix (in this case POLKE).

If the aircraft altitude is above the specified altitude after crossing the MAP, a direct-to is established to the published fix (POLKE) to begin the missed approach procedure. The altitude constraint defaults to 400 feet AGL when the fix is not part of the published procedure.

In some missed approach procedures this altitude fix may be part of the published procedure. For example, the procedure dictates a climb to 5,500 feet, then turn left and proceed to the Missed Approach Hold Point (MAHP). In this case, the altitude fix would be labeled '5500 ft'. Again, if the aircraft altitude is lower than this prescribed altitude, a direct-to is established to this fix when the missed approach procedure is activated.



Figure 5-151 Course to Altitude Fix Special Condition

## 5.23 PROCEDURES (PFD)

The Procedures Window (Figure 5-147) provides direct access to departures, arrivals and approaches — based upon the active flight plan or direct-to destination. In either case, the departure and destination airports must have published procedures associated with them. The Procedures Window is displayed and removed by pressing the **PROC** Key .

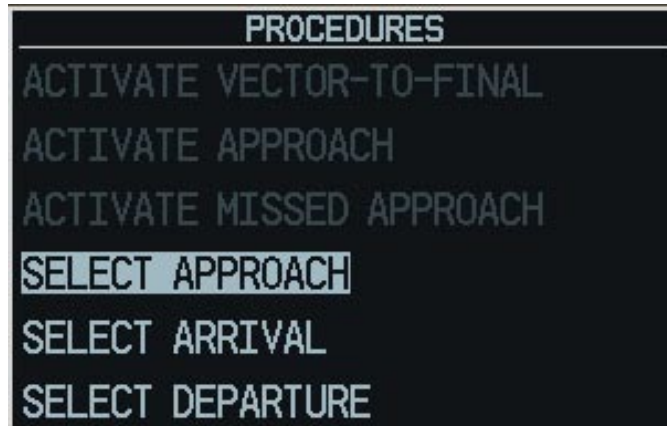

Figure 5-152 Procedures Window

The following operations can be performed from the Procedures Window:

- Activate Vector-To-Final or approach
- Select approach, arrival, or departure
- Select missed approach

### SELECT DEPARTURE

‘Select Departure’ selects a published standard instrument departure (SID) for the departure airport or replaces the current departure with a new selection. When using a direct-to, the G1000 uses the nearest airport as a reference when displaying available departures.

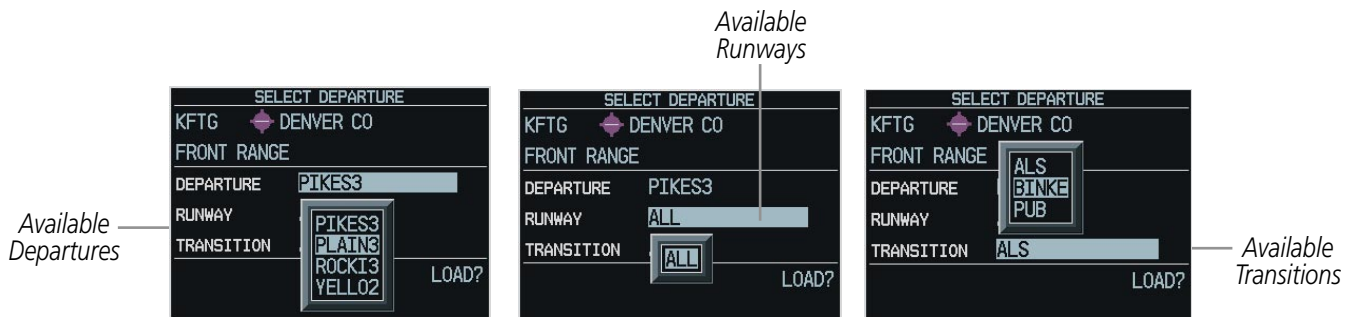

Figure 5-153 Selecting a Departure



**Selecting a departure for the departure airport:**

- 1) Display the Procedures Window by pressing the **PROC** Key.
- 2) Highlight 'SELECT DEPARTURE'.
- 3) Press the **ENT** Key.
- 4) Enter an identifier, city, or facility name.
- 5) Press the **ENT** Key until the departure field is highlighted.
- 6) Select the desired departure.
- 7) Press the **ENT** Key. A window appears listing the available transitions for the departure.
- 8) Select the desired transition or vectors.
- 9) Press the **ENT** Key. A window appears listing the available runways for the departure.
- 10) Select the desired runway.
- 11) With 'LOAD?' highlighted, press the **ENT** Key to load the departure.

**SELECT ARRIVAL**

'SELECT ARRIVAL' selects a published standard terminal arrival route (STAR) for the destination airport or replaces a current arrival with a new selection.



Figure 5-154 Selecting an Arrival

**Selecting an arrival for a direct-to or flight plan destination airport:**

- 1) Display the Procedures Window by pressing the **PROC** Key.
- 2) Highlight 'SELECT ARRIVAL'.
- 3) Press the **ENT** Key.
- 4) Enter an identifier, city, or facility name.
- 5) Press the **ENT** Key until the arrival field is highlighted.
- 6) Select the desired arrival.

- 7) Press the **ENT** Key. A window appears listing the available transitions for the arrival.
- 8) Select the desired transition or vectors.
- 9) Press the **ENT** Key. A window appears listing the available runways for the arrival.
- 10) Select the desired runway.
- 11) With 'LOAD?' highlighted, press the **ENT** Key to load the arrival.

## SELECT APPROACH

'SELECT APPROACH' selects a published instrument approach for the destination airport or replaces the current approach with a new selection.

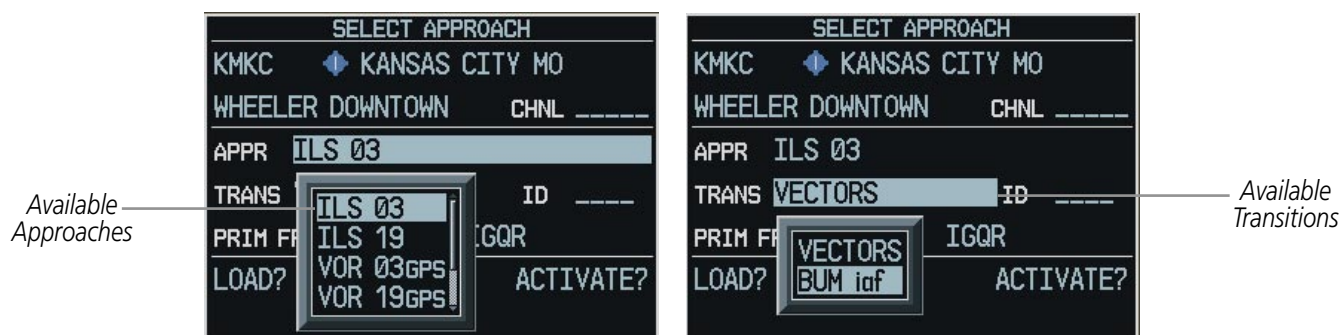

Figure 5-155 Selecting an Approach

### Selecting an approach for a direct-to or flight plan destination airport:

- 1) Display the Procedures Window by pressing the **PROC** Key.
- 2) Highlight 'SELECT APPROACH'.
- 3) Press the **ENT** Key.
- 4) Enter an identifier, city, or facility name.
- 5) Press the **ENT** Key until the approach field is highlighted.
- 6) Select the desired approach.
- 7) Press the **ENT** Key. A window appears listing the available transitions for the approach.
- 8) Select the desired transition or vectors.
- 9) Press the **ENT** Key.
- 10) With 'LOAD?' highlighted, press the **ENT** Key to load the approach OR: to activate the approach, highlight 'ACTIVATE?'. If the approach is not approved for GPS, a 'NOT APPROVED FOR GPS' message is displayed with 'YES' highlighted. Press the **ENT** Key to acknowledge the message. To cancel the approach, select 'NO' and press the ENT Key.

## ACTIVATE APPROACH

'ACTIVATE APPROACH' activates the approach.

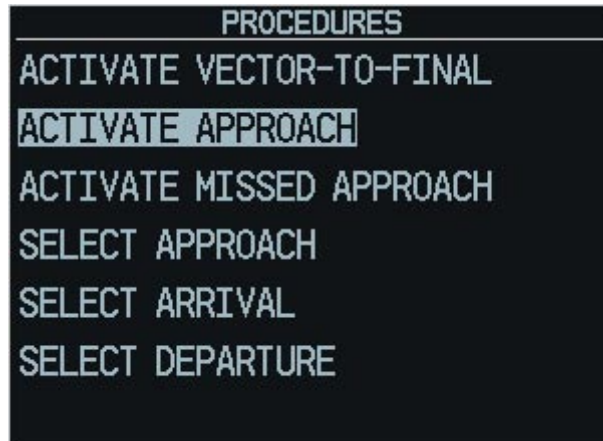

Figure 5-156 Activate Approach Selection

### Activating the approach for a direct-to or flight plan destination airport:

- 1) Press the **PROC** Key to display the Procedures Window.
- 2) Highlight 'ACTIVATE APPROACH'.
- 3) Press the **ENT** Key.

## ACTIVATE VECTOR-TO-FINAL

'ACTIVATE VECTOR-TO-FINAL' vectors to the final approach course.

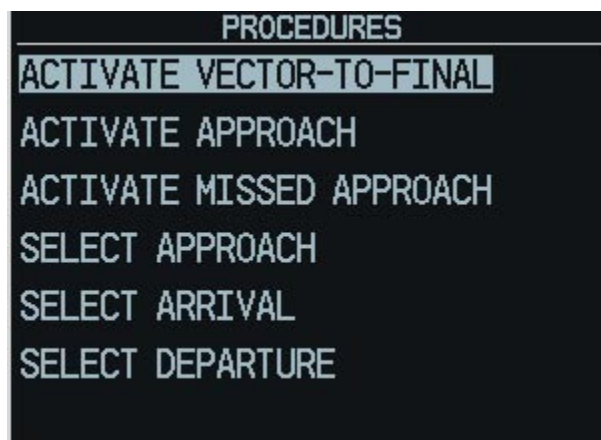

Figure 5-157 Activate Vector-To-Final Selection

**Activating the approach with vectors to final:**

- 1) Select the **PROC** Key to display the Procedures Options Window.
- 2) Highlight 'ACTIVATE VECTOR-TO-FINAL'.
- 3) Press the **ENT** Key.

**ACTIVATE MISSED APPROACH**

'ACTIVATE MISSED APPROACH' vectors to the final approach course.

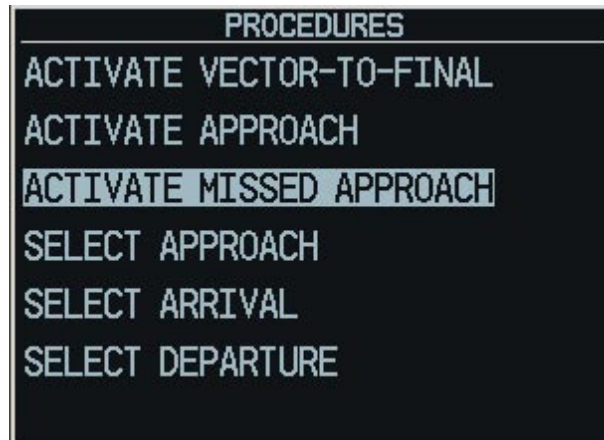



Figure 5-158 Activate Missed Approach Selection

**Activating a missed approach:**

- 1) Press the **PROC** Key to display the Procedures Window.
- 2) Highlight 'ACTIVATE MISSED APPROACH'.
- 3) Press the **ENT** Key.

## 5.24 ABNORMAL OPERATION

### DEAD RECKONING

 **NOTE:** Dead Reckoning Mode only functions in Enroute (ENR) or Oceanic (OCN) phase of flight. In all other phases, an invalid GPS solution produces a “NO GPS POSITION” annunciation on the map and the G1000 stops navigating in GPS Mode.

While in Enroute or Oceanic phase of flight, if the G1000 detects an invalid GPS solution or is unable to calculate a GPS position, the system will automatically revert to Dead Reckoning (DR) Mode. In DR Mode, the G1000 uses its last-known position combined with continuously updated airspeed and heading data (when available) to calculate and display the aircraft’s current estimated position.

‘DR’ is prominently displayed, in yellow, on the HSI slightly above and to the right of the aircraft symbol on the CDI as shown in Figure 5-159. Also, the CDI deviation bar is removed from the display. In addition, DR Mode is indicated on the G1000 by the appearance of the letters ‘DR’ superimposed in yellow over the ‘own aircraft’ symbol. Lastly, but at the same time, a ‘GPS NAV LOST’ alert message appears on the PFD. Normal navigation using GPS/WAAS source data resumes automatically once a valid GPS solution is restored.



Figure 5-159 CDI ‘DR’ Indication on PFD

It is important to note that estimated navigation data supplied by the G1000 in DR Mode may become increasingly unreliable and must not be used as a sole means of navigation. If while in DR Mode airspeed and/or heading data is also lost or not available, the DR function may not be capable of accurately tracking your estimated position and, consequently, the system may display a path that is different than the actual movement of the aircraft. Estimated position information displayed by the G1000 through DR while there is no heading and/or airspeed data available should not be used for navigation.

DR Mode is inherently less accurate than the standard GPS/WAAS Mode due to the lack of satellite measurements needed to determine a position. Changes in wind speed and/or wind direction will compound the relative inaccuracy of DR Mode. Because of this degraded accuracy, the crew must maintain position awareness using other navigation equipment until GPS-derived position data is restored.

As a result of operating in DR Mode, all GPS-derived data is computed based upon an estimated position and is displayed as yellow text on the display to denote degraded navigation source information. This data includes the following:

- Navigation Status Box fields except Active Leg, TAS, and DTK
- GPS Bearing Pointer
- Wind data and pointers in the Wind Data Box on the PFD
- Track Bug
- All Bearing Pointer Distances
- Active Flight Plan distances, bearings, and ETE values

Also, while the G1000 is in DR Mode, the autopilot does not couple to GPS, and both TAWS and Terrain Proximity is disabled. Additionally, the accuracy of all nearest information (airports, airspaces, and waypoints) is questionable. Finally, airspace alerts will continue to function, but with degraded accuracy.

## SECTION 6 HAZARD AVOIDANCE

The hazard avoidance features available for the G1000 system are designed to provide advisory information of potential hazards to flight safety associated with weather, terrain, and air traffic.

This section is divided into the following groups:

### Weather

- GDL 69/69A XM<sup>®</sup> Satellite Weather
- L-3 STORMSCOPE<sup>®</sup> WX-500 Series II Weather Mapping Sensor

### Terrain Avoidance

- Terrain Proximity (non-TSO-C151b-certified)
- TAWS (Terrain Awareness Warning System - TSO-C151b certified)

### Traffic

- TIS (Traffic Information Service)
- Avidyne TAS600<sup>®</sup> Traffic Advisory System (optional)

## 6.1 XM SATELLITE WEATHER (OPTIONAL)



---

**NOTE:** XM Satellite Weather data provides information for avoiding hazardous weather. It is not meant for use to penetrate hazardous weather.

---

XM Satellite Weather is provided through the GDL 69A, a remote-mounted data-link satellite receiver. Received graphical weather information and associated text is displayed on the Multi Function Display (MFD) and the Primary Flight Display (PFD) Inset Map. The GDL 69A can also receive XM Satellite Radio<sup>®</sup> entertainment services. Both weather data and entertainment programming operate in the S-band frequency range to provide continuous reception capabilities at any altitude throughout North America.

XM Satellite Radio services are subscription-based. For more information on specific service packages, visit [www.xmradio.com](http://www.xmradio.com). Refer to the Additional Features Section for information about XM Radio Entertainment.

### ACTIVATING SERVICES

---

Before XM Satellite Weather can be used, the service must be activated. Service is activated by providing XM Satellite Radio with coded IDs unique to the installed GDL 69A. XM Satellite Radio and XM Satellite Weather services each have coded IDs. The Audio and Data Radio IDs must be provided to XM Satellite Radio to activate the weather service and entertainment subscriptions, respectively. These IDs are located on:

- The label on the back of the Data Link Receiver
- The XM Information Page on the MFD (Figure 6-1)
- The XM Satellite Radio Activation Instructions included with the unit (available at [www.garmin.com](http://www.garmin.com), P/N 190-00355-04)

Contact the installer if the Audio and Data Radio IDs cannot be located.

XM Satellite Radio uses the coded IDs to send an activation signal that allows the G1000 to display weather data and/or entertainment programming provided through the GDL 69A.

**Activating the XM Satellite Weather and XM Satellite Radio Services:**

- 1) Contact XM Satellite Radio by email (address listed on their website, www.xmradio.com) or by the customer service phone number listed on the website. Follow the instructions provided by XM Satellite Radio services.
- 2) Select the next-to-last page in the AUX page group.
- 3) Press the **INFO** Softkey to display the XM Information Page.
- 4) Verify that the desired services are activated.
- 5) Press the **LOCK** Softkey to lock subscription information.
- 6) Turn the large **FMS** Knob to highlight YES.
- 7) To complete activation, press the **ENT** Key.



Figure 6-1 XM Information Page



**USING XM SATELLITE WEATHER PRODUCTS**

The primary map for viewing XM Weather data is the Weather Data Link Page in the Map Page Group. This is the only G1000 map display capable of showing information for all available XM weather products.

**Viewing the Weather Data Link Page:**

- 1) Turn the large **FMS** Knob to select the Map Page Group.
- 2) Turn the small **FMS** Knob to select the third rectangular page icon.

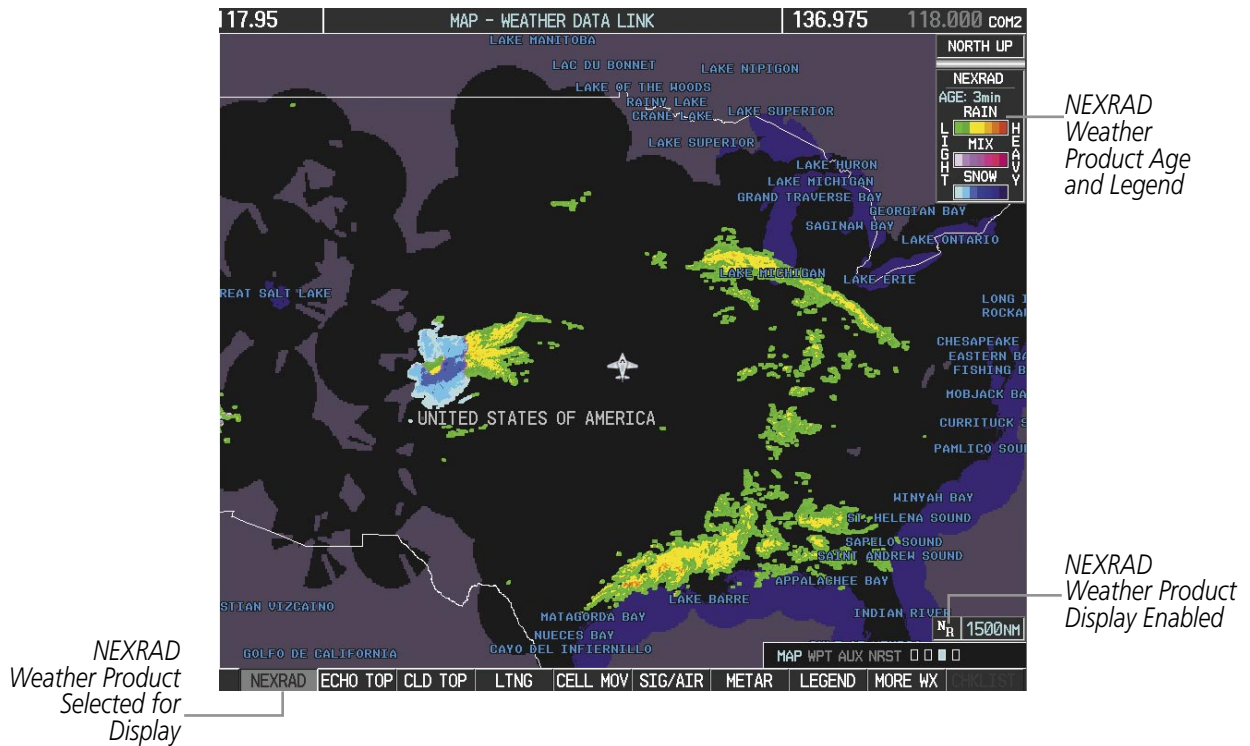

**Figure 6-2 Weather Data Link Page**

When a weather product is active on the Weather Data Link Page or the Navigation Map Page, the age of the data is displayed on the screen. The age of the product is based on the time difference between when the data was assembled on the ground and the current GPS time. Weather products are refreshed at specific intervals (defined in the Refresh Rate column in Table 6-1).

If for any reason, a weather product is not refreshed within the 30-, 60-, or 90-minute Expiration Time intervals, the data is considered expired and is removed from the display. This ensures that the displayed data is consistent with what is currently being broadcast by XM Satellite Radio services. If more than half of the expiration time has elapsed, the color of the product age displayed changes to yellow.

This table shows the weather product symbols, the expiration time and the refresh rate. The refresh rate represents the interval at which XM Satellite Radio broadcasts new signals that may or may not contain new weather data. It does not represent the rate at which weather data is updated or new content is received by the Data Link Receiver. Weather data is updated at intervals that are defined and controlled by XM Satellite Radio and its data vendors.













| Weather Product                          | Symbol  | Expiration Time (Minutes) | Refresh Rate (Minutes) |
|--|---|---------------------------|------------------------|
| Next-generation Radar (NEXRAD)           |    | 30                        | 5                      |
| Cloud Top (CLD TOP)                      |    | 60                        | 15                     |
| Echo Top (ECHO TOP)                      |    | 30                        | 7.5                    |
| XM Lightning (LTNG)                      |    | 30                        | 5                      |
| Cell Movement (CELL MOV)                 |    | 30                        | 12                     |
| SIGMETs/AIRMETs (SIG/AIR)                |   | 60                        | 12                     |
| Meteorological Aerodrome Report (METARs) |  | 90                        | 12                     |
| City Forecast (CITY)                     |  | 60                        | 12                     |
| Surface Analysis (SFC)                   |  | 60                        | 12                     |
| Freezing Levels (FRZ LVL)                |  | 60                        | 12                     |
| Winds Aloft (WIND)                       |  | 60                        | 12                     |
| County Warnings (COUNTY)                 |  | 60                        | 5                      |
| Cyclone Warnings (CYCLONE)               |  | 60                        | 12                     |
| Radar Coverage (RADAR CVRG)              | No product image  | 30                        | 5                      |
| Temporary Flight Restrictions (TFRs)     | No product image  | 60                        | 12                     |
| Terminal Aerodrome Reports (TAFs)        | No product image  | 60                        | 12                     |

Table 6-1 Weather Product Symbols and Data Timing

This table shows which XM products can be displayed (indicated with a '+' symbol) on specific maps.

| Weather Product            | PFD Inset Map | Navigation Map Page | Weather Data Link Page | Weather Information Page | AUX - Trip Planning Page | Nearest Page Group | Flight Plan Pages |
|----------------------------|---------------|---------------------|------------------------|--------------------------|--------------------------|--------------------|-------------------|
| NEXRAD                     | +             | +                   | +                      |                          | +                        | +                  | +                 |
| Cloud Top (CLD TOP)        |               |                     | +                      |                          |                          |                    |                   |
| Echo Top (ECHO TOP)        |               |                     | +                      |                          |                          |                    |                   |
| XM Lightning (LTNG)        | +             | +                   | +                      |                          | +                        | +                  | +                 |
| Cell Movement (CELL MOV)   | +             | +                   | +                      |                          | +                        | +                  | +                 |
| SIGMETs/AIRMETs (SIG/AIR)  |               |                     | +                      |                          |                          |                    |                   |
| METARs                     |               |                     | +                      | +                        |                          |                    |                   |
| City Forecast (CITY)       |               |                     | +                      |                          |                          |                    |                   |
| Surface Analysis (SFC)     |               |                     | +                      |                          |                          |                    |                   |
| Freezing Levels (FRZ LVL)  |               |                     | +                      |                          |                          |                    |                   |
| Winds Aloft (WIND)         |               |                     | +                      |                          |                          |                    |                   |
| County Warnings (COUNTY)   |               |                     | +                      |                          |                          |                    |                   |
| Cyclone Warnings (CYCLONE) |               |                     | +                      |                          |                          |                    |                   |
| Radar Coverage             |               | +                   | +                      |                          |                          |                    |                   |
| TFRs                       | +             | +                   | +                      | +                        | +                        | +                  | +                 |
| TAFs                       |               |                     | +                      | +                        |                          |                    |                   |

**Table 6-2 Weather Product Display Maps**

## WEATHER SOFTKEYS ON THE WEATHER DATA LINK PAGE

Softkeys control the display of weather information on most MFD pages and the PFD Inset Map (The figure shows the weather product softkeys for the Weather Data Link Page). When a weather product is selected for display, the corresponding softkey label changes to gray to indicate the product is enabled. Unavailable weather products have subdued softkey labels (softkeys are disabled from selection).

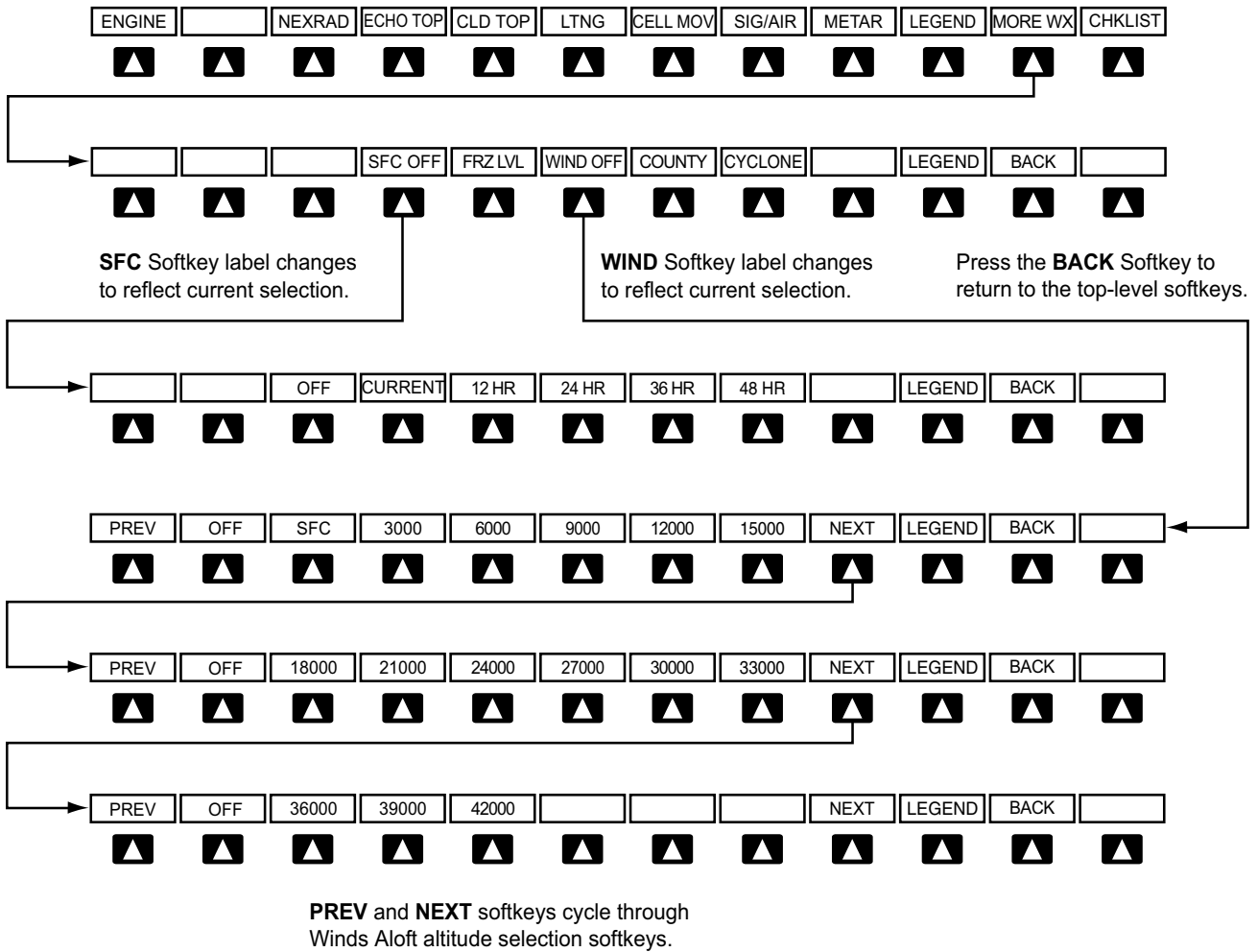
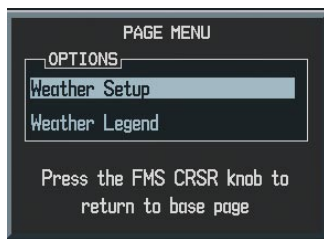

Figure 6-3 Weather Softkeys

The setup menus for the Navigation Map Page and the Weather Data Link Page control the map range settings above which weather products data are decluttered from the display. If a map range larger than the weather product map range setting is selected, the weather product data is removed from the map. The menus also provide a means in addition to the softkeys for enabling/disabling display of weather products.

**Setting up and customizing the Weather Data Link Page:**

- 1) Select the Weather Data Link Page.
- 2) Press the **MENU** Key.
- 3) With 'Weather Setup' highlighted, press the **ENT** Key (Figure 6-4).
- 4) Turn the large **FMS** Knob or press the **ENT** Key to scroll through product selections (Figure 6-5).
- 5) Turn the small **FMS** Knob to scroll through options for each product (ON/OFF, range settings, etc.).
- 6) Press the **ENT** Key to select an option.
- 7) Press the **FMS** Knob or **CLR** Key to return to the Weather Data Link Page with the changed settings.



**Figure 6-4 Weather Data Link Page Menu**

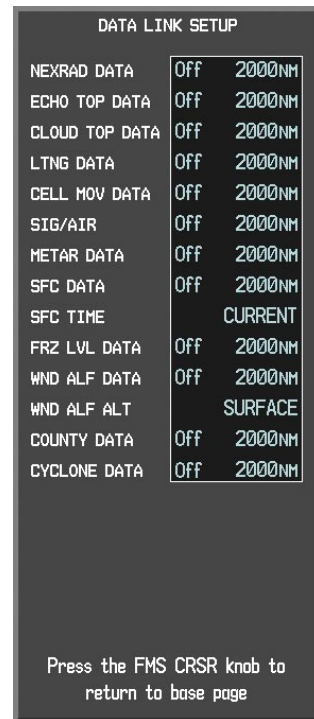

**Figure 6-5 Weather Data Link Page Setup Menu**

**Restoring default Weather Data Link Page settings:**

- 1) Select the Weather Data Link Page.
- 2) Press the **MENU** Key.
- 3) With 'Weather Setup' highlighted, press the **ENT** Key.
- 4) Press the **MENU** Key.
- 5) Highlight the desired default(s) to restore (all or for selection) and press **ENT** Key.

Maps besides the Weather Data Link Page use settings based on those selected for the Navigation Map Page.

### Setting up and customizing weather data for the Navigation Map Page:

- 1) Select the Navigation Map Page.
- 2) Press the **MENU** Key.
- 3) With 'Map Setup' highlighted, press the **ENT** Key (Figure 6-6).
- 4) Turn the small **FMS** Knob to select the 'Weather' Group and press the **ENT** Key (Figure 6-7).
- 5) Turn the large **FMS** Knob or press the **ENT** Key to scroll through product selections (Figure 6-8).
- 6) Turn the small **FMS** Knob to scroll through options for each product (ON/OFF, range settings).
- 7) Press the **ENT** Key to select an option.
- 8) Press the **FMS** Knob or **CLR** Key to return to the Navigation Map Page with the changed settings.



Figure 6-6 Navigation Map Page Menu



Figure 6-7 Navigation Map Page Setup Menu

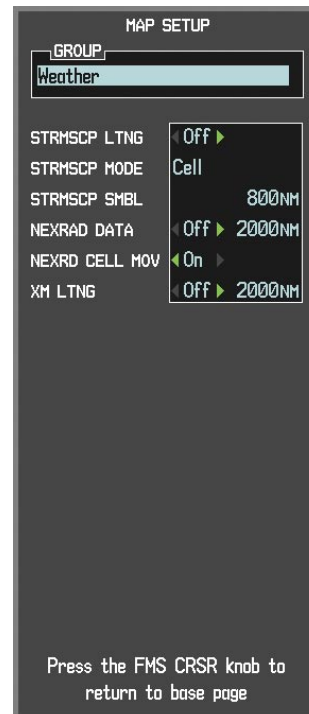

Figure 6-8 Navigation Map Page Setup Menu, Weather Group

Each active weather product has an associated legend which can be displayed on the Weather Data Link Page. Weather product legends are not interchangeable.

**Viewing legends for displayed weather products**

- 1) Select the Weather Data Link Page.
- 2) Press the **LEGEND** Softkey to display the legends for the displayed weather products.
- OR:
  - a) Press the **MENU** Key.
  - b) Select 'Weather Legend' and press the **ENT** Key.
- 3) Turn the **FMS** Knob to scroll through the legends if more are available than fit in the window.
- 4) To remove the Legend Window, press the **LEGEND** Softkey, the **ENT** or the **CLR** Key, or press the **FMS** Knob.

Additional information about the following can be displayed by panning over the display on the map:

- Echo Tops
- Cell Movement
- SIGMETs
- AIRMETs
- METARs
- County Warnings
- TFRs

The map panning feature is enabled by pressing the **Joystick**. The map range is adjusted by turning the **Joystick**. If the map range is adjusted while panning is enabled, the map is re-centered on the Map Pointer.

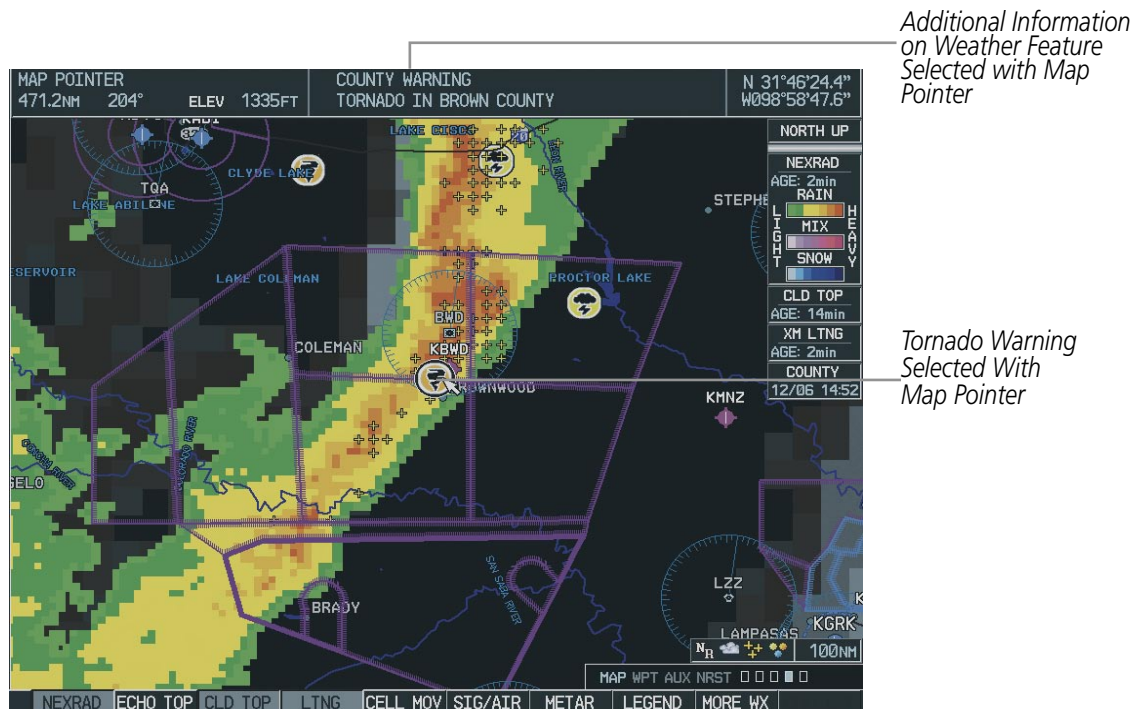

Figure 6-9 Panning on the Weather Data Link Page

## NEXRAD



**NOTE:** NEXRAD cannot be displayed at the same time as map topography and/or terrain.

WSR-88D, or NEXRAD (NEXt-generation RADar), is a network of 158 high-resolution Doppler radar systems that are operated by the National Weather Service (NWS). NEXRAD data provides centralized meteorological information for the continental United States and selected overseas locations. The maximum range of a single NEXRAD radar site is 250 nm. In addition to a wide array of services, the NEXRAD network provides important information about severe weather for air traffic safety.

NEXRAD data is not real-time. The lapsed time between collection, processing, and dissemination of NEXRAD images can be significant and may not reflect the current radar synopsis. Due to the inherent delays and the relative age of the data, it should be used for long-range planning purposes only. Never use NEXRAD data or any radar data to penetrate hazardous weather. Rather, use it in an early-warning capacity of pre-departure and enroute evaluation.



Figure 6-10 NEXRAD Data on the Weather Data Link Page

NEXRAD data can be displayed on the following maps:

- PFD Inset Map
- Navigation Map Page
- Weather Data Link Page
- Airport Information Page
- Trip Planning Page
- Nearest Pages
- Flight Plan Pages



**Displaying NEXRAD weather information:**

- 1) Press the **MAP** Softkey (for the PFD Inset Map, press the **INSET** Softkey). This step is not necessary on the Weather Data Link Page.
- 2) Press the **NEXRAD** Softkey.

Composite data from all the NEXRAD radar sites in the United States is shown. This data is composed of the maximum reflectivity from the individual radar sweeps. The display of the information is color-coded to indicate the weather severity level. All weather product legends can be viewed on the Weather Data Link Page. For the NEXRAD legend, select the **LEGEND** Softkey when NEXRAD is selected for display.

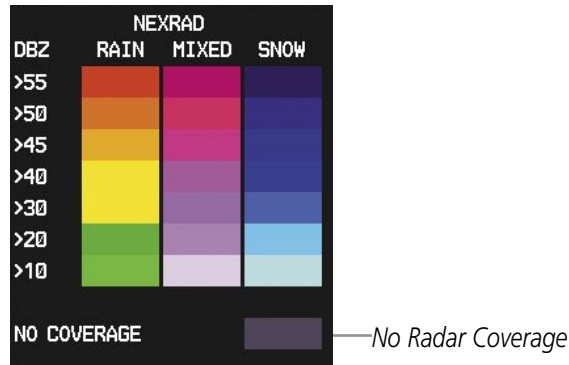

**Figure 6-11 NEXRAD Data with Legend**

The display of radar coverage is always active when either NEXRAD or ECHO TOPS is selected. Areas where NEXRAD radar coverage and Echo Tops information is not currently available or is not being collected are indicated in grayish-purple. Radar capability exists in these areas, but it is not active or is off-line.

**REFLECTIVITY**

Reflectivity is the amount of transmitted power returned to the radar receiver. Colors on the NEXRAD display are directly correlated to the level of detected reflectivity. Reflectivity as it relates to hazardous weather can be very complex.

The role of radar is essentially to detect moisture in the atmosphere. Simply put, certain types of weather reflect radar better than others. The intensity of a radar reflection is not necessarily an indication of the weather hazard level. For instance, wet hail returns a strong radar reflection, while dry hail does not. Both wet and dry hail can be extremely hazardous.

The different NEXRAD echo intensities are measured in decibels (dB) relative to reflectivity (Z). NEXRAD measures the radar reflectivity ratio, or the energy reflected back to the radar receiver (designated by the letter Z). The value of Z increases as the returned signal strength increases.

## NEXRAD LIMITATIONS

NEXRAD radar images may have certain limitations:

- NEXRAD base reflectivity does not provide sufficient information to determine cloud layers or precipitation characteristics (wet hail vs. rain). For example, it is not possible to distinguish between wet snow, wet hail, and rain.
- NEXRAD base reflectivity is sampled at the minimum antenna elevation angle. An individual NEXRAD site cannot depict high altitude storms at close ranges. It has no information about storms directly over the site.
- When zoomed in to a range of 30 nm, each square block on the display represents an area of four square kilometers. The intensity level reflected by each square represents the highest level of NEXRAD data sampled within the area.

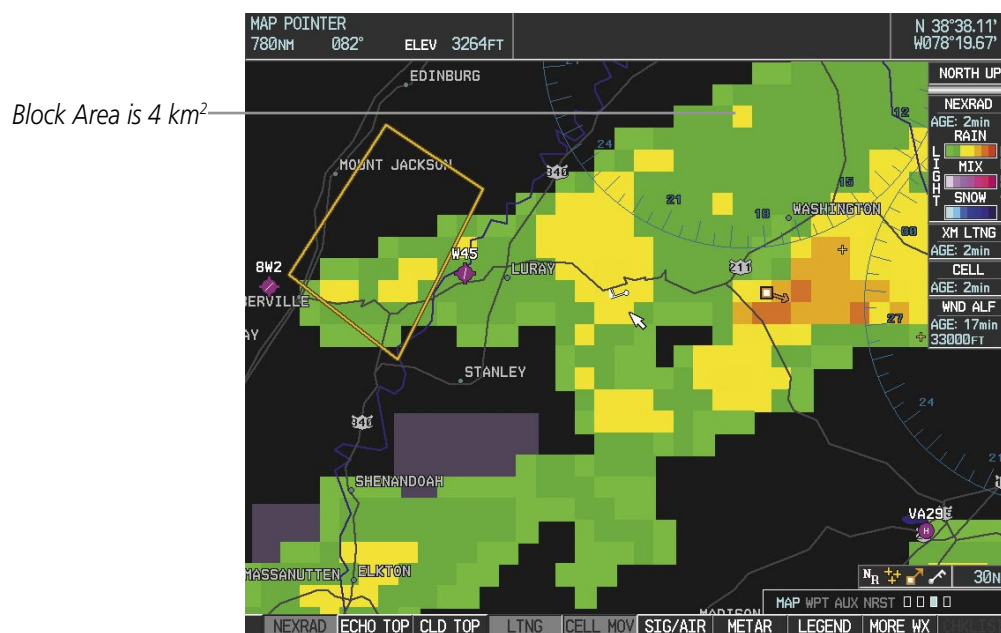

Figure 6-12 NEXRAD Data - Zoomed

The following may cause abnormalities in displayed NEXRAD radar images:

- Ground clutter
- Strokes and spurious radar data
- Sun strokes (when the radar antenna points directly at the sun)
- Interference from buildings or mountains, which may cause shadows
- Metallic dust from military aircraft, which can cause alterations in radar scans

ECHO TOPS

**NOTE:** Display of Echo Tops is mutually exclusive with Cloud Tops and NEXRAD.

Echo Tops data shows the location, elevation, and direction of the highest radar echo. The highest radar echo does not indicate the top of a storm or clouds; rather it indicates the highest altitude at which precipitation is detected. Information is derived from NEXRAD data.

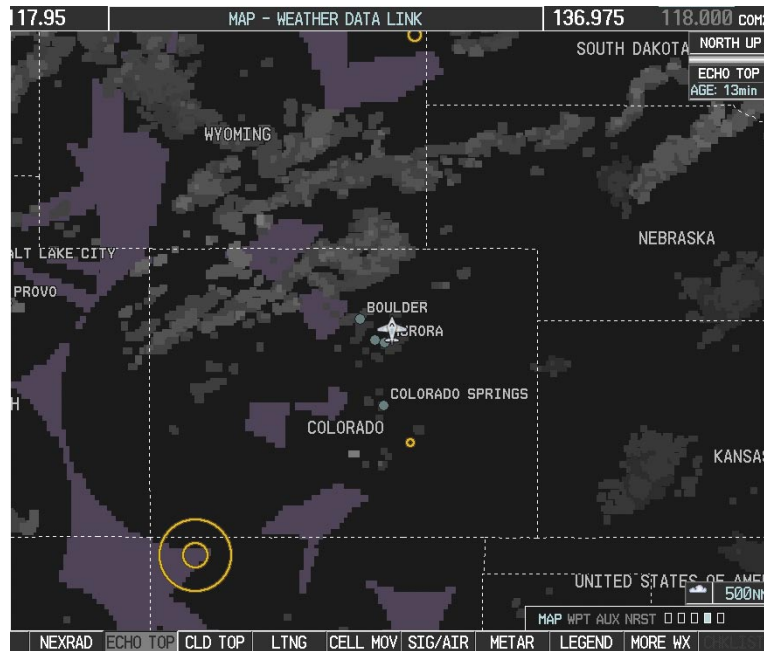

Figure 6-13 Echo Tops Data

**Displaying Echo Tops information:**

- 1) Select the Weather Data Link Page.
- 2) Press the **ECHO TOPS** Softkey.

To display the Echo Tops legend, press the **LEGEND** Softkey when Echo Tops is selected for display. Since Echo Tops and Cloud Tops use the same color scaling to represent altitude, display of these weather products is mutually exclusive. When Echo Tops is activated, NEXRAD and Cloud Tops data are removed.

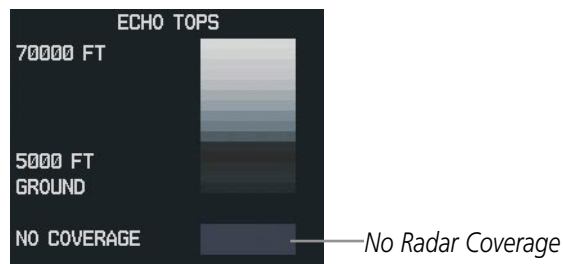

Figure 6-14 ECHO TOPS Legend

The display of radar coverage is always active when either NEXRAD or ECHO TOPS is selected. Areas where NEXRAD radar coverage and Echo Tops information is not currently available or is not being collected are indicated in grayish-purple. Radar capability exists in these areas, but it is not active or is off-line.

## CLOUD TOPS



**NOTE:** *Cloud Tops and Echo Tops cannot be displayed at the same time.*

Cloud Tops data depicts cloud top altitudes as determined from satellite imagery.

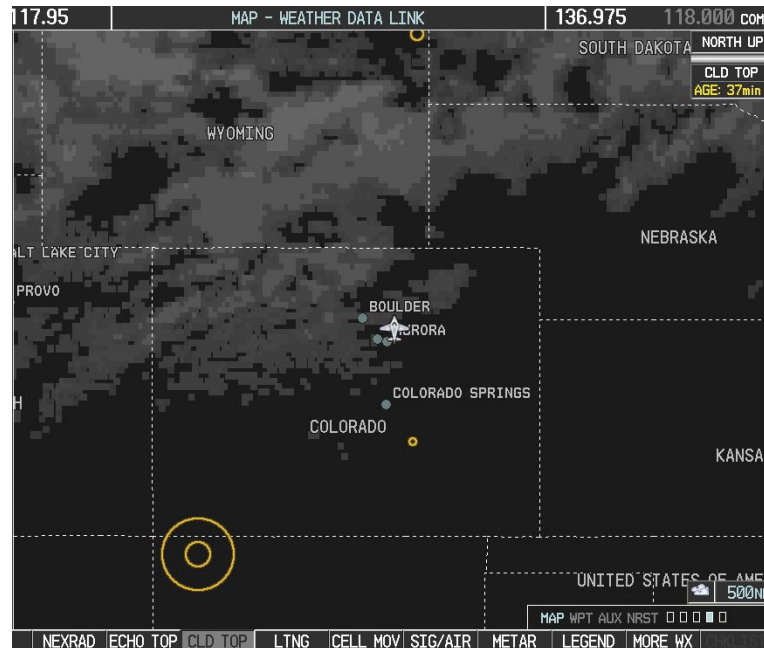

Figure 6-15 Cloud Tops Data

### Displaying Cloud Tops information:

- 1) Select the Weather Data Link Page.
- 2) Press the **CLOUD TOPS** Softkey.

To display the Cloud Tops legend, select the **LEGEND** Softkey when Cloud Tops is selected for display. Since Cloud Tops and Echo Tops use the same color scaling to represent altitude, display of these weather products is mutually exclusive. When Cloud Tops is activated, Echo Tops data is removed.

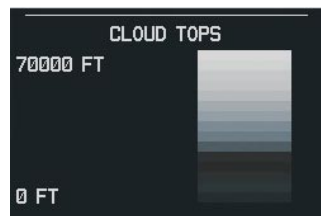

Figure 6-16 Cloud Tops Legend

## XM LIGHTNING

Lightning data shows the approximate location of cloud-to-ground lightning strikes. A strike icon represents a strike that has occurred within a two-kilometer region. The exact location of the lightning strike is not displayed.

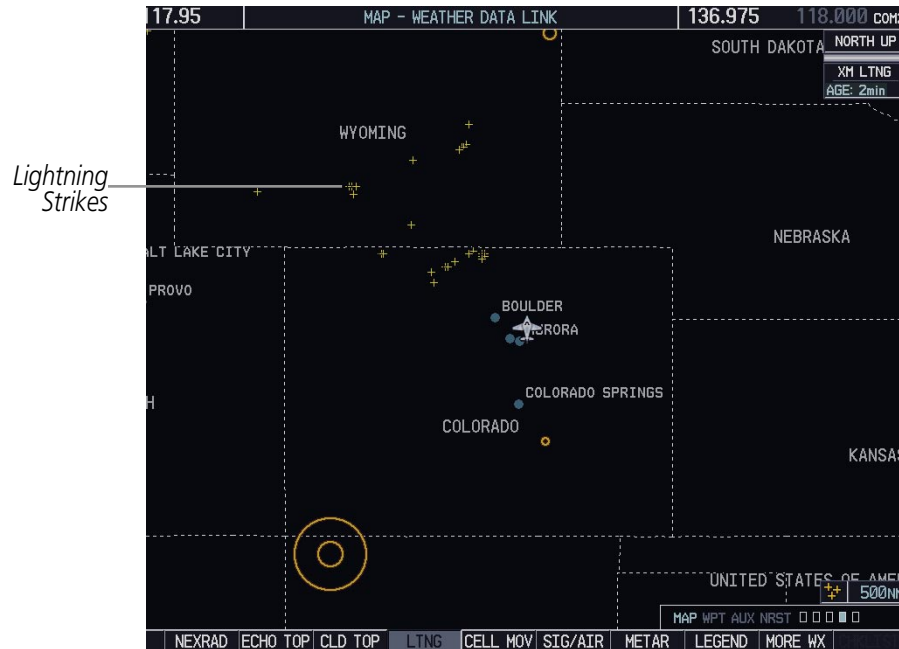

Figure 6-17 Lightning Data

XM Lightning data displays on the following maps:

- PFD Inset Map
- Navigation Map Page
- Weather Data Link Page
- Trip Planning Page
- Nearest Pages
- Flight Plan Pages

### Displaying XM Lightning information:

- 1) Press the **MAP** Softkey (for the PFD Inset Map, press the **INSET** Softkey). This step is not necessary on the Weather Data Link Page.
- 2) Press the **XM LTNG** Softkey (**LTNG** Softkey on the Weather Data Link Page).

To display the XM Lightning legend on the Weather Data Link Page, select the **LEGEND** Softkey when XM Lightning is selected for display.

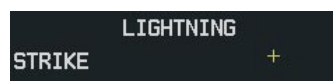

Figure 6-18 Lightning Legend

## CELL MOVEMENT

Cell Movement data shows the location and movement of storm cells as identified by the ground-based system. Cells are represented by yellow squares, with direction of movement indicated with short, orange arrows.

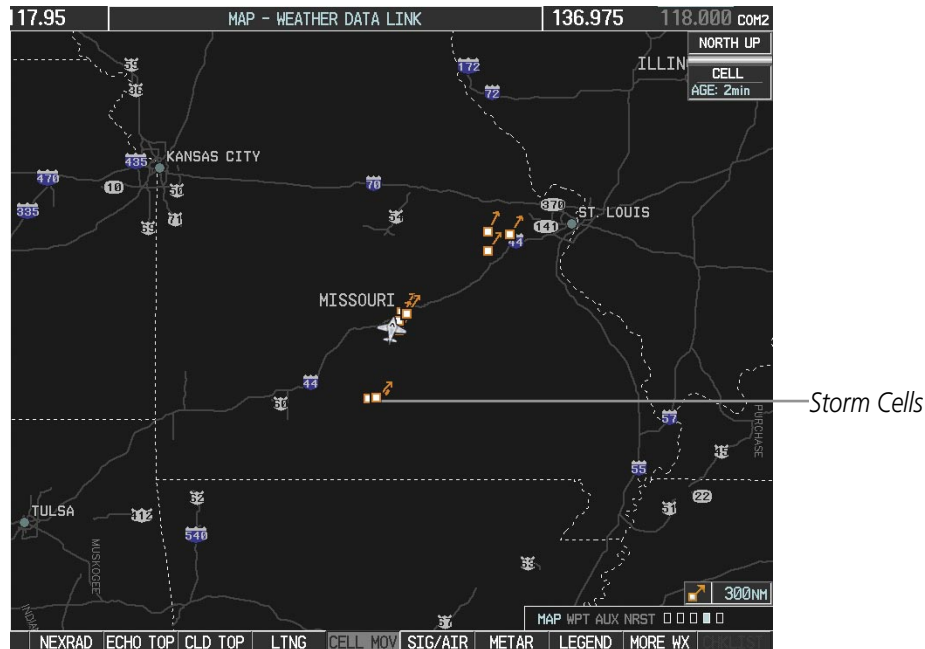

Figure 6-19 Cell Movement Data

On most applicable maps, Cell Movement data is selected for display along with NEXRAD. On the Weather Data Link Page, Cell Movement data can be selected independently. Cell Movement data can be displayed on the following maps:

- PFD Inset Map
- AUX - Trip Planning Page
- Navigation Map
- Nearest Pages

### Displaying Cell Movement information:

- 1) Press the **MAP** Softkey (for the PFD Inset Map, press the **INSET** Softkey). This step is not necessary on the Weather Data Link Page.
- 2) Press the **NEXRAD** Softkey (**CEL MOV** Softkey on the Weather Data Link Page). For Cell Movement to be displayed on maps other than the Weather Data Link Page, Cell Movement must be turned on in the Navigation Map Setup Menu (see "Setting Up XM Satellite Weather").

To display the Cell Movement legend on the Weather Data Link Page, press the **LEGEND** Softkey when Cell Movement is selected for display.



Figure 6-20 Cell Movement Legend

### SIGMETS AND AIRMETS

SIGMETs (SIGnificant METeorological Information) and AIRMETS (AIRmen’s METeorological Information) are broadcast for potentially hazardous weather considered of extreme importance to all aircraft. A Convective SIGMET is issued for hazardous convective weather. A localized SIGMET is a significant weather condition occurring at a localized geographical position.

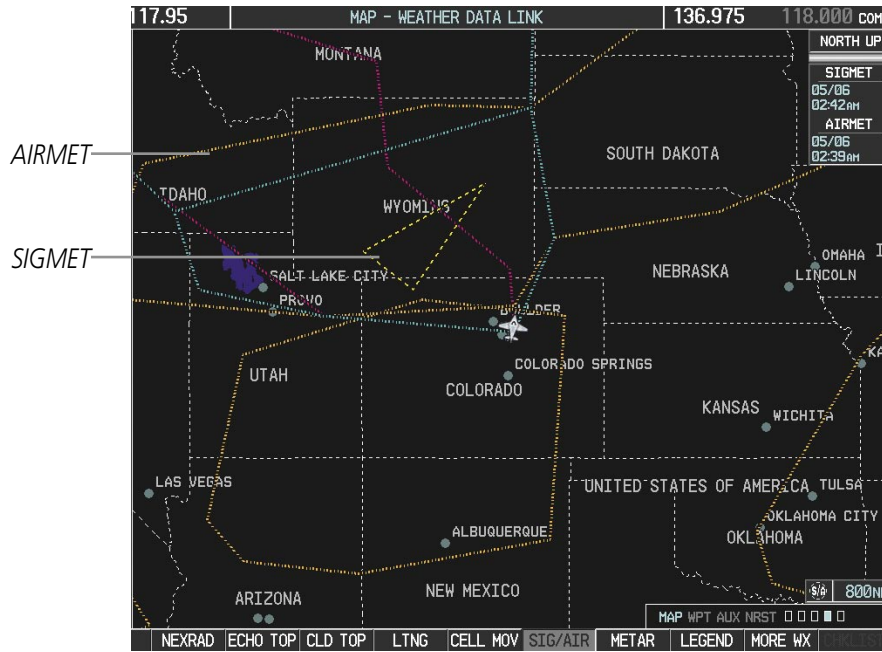

Figure 6-21 SIGMET/AIRMET Data

#### Displaying SIGMETs and AIRMETS:

- 1) Select the Weather Data Link Page.
- 2) Press the **SIG/AIR** Softkey.
- 3) To view the text of the SIGMET or AIRMET, press the **Joystick** and move the Map Pointer over the icon.
- 4) Press the **ENT** key. The figure below shows a sample of SIGMET text.

To display the SIGMET and AIRMET legend, select the **LEGEND** Softkey when SIGMETs and AIRMETS are selected for display.

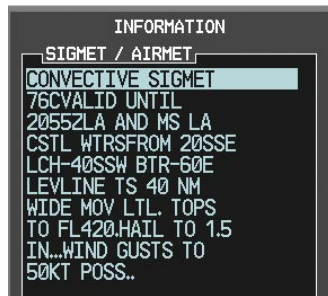

Figure 6-22 Sample SIGMET Text



Figure 6-23 SIGMET/AIRMET Legend

## METARS AND TAFS



**NOTE:** Atmospheric pressure as reported for METARs is given in hectopascals (hPa), except in the United States, where it is reported in inches of mercury (in Hg). Temperatures are reported in Celsius.



**NOTE:** METAR information is only displayed within the installed aviation database service area.

METAR (METEorological Aerodrome Report) is the standard format for pre-flight weather briefings. METARs are updated hourly and are considered current. METARs typically contain information about the temperature, dewpoint, wind, precipitation, cloud cover, cloud heights, visibility, and barometric pressure. They can also contain information on precipitation amounts, lightning, and other critical data. METARs are shown as colored flags at airports that provide them.

Instructions for Viewing  
METAR and TAF Text

Selected Airport

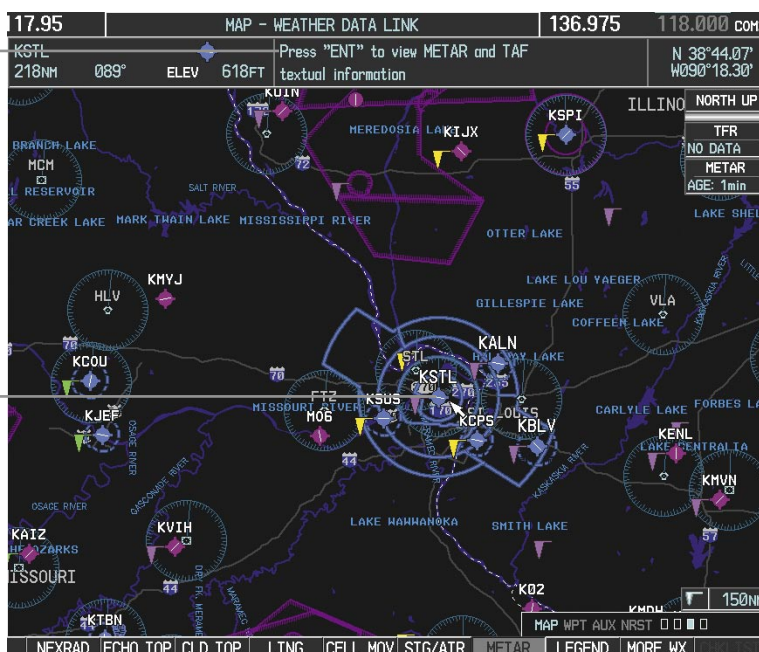

Figure 6-24 METAR Flags on the Weather Data Link Page

TAF (Terminal Aerodrome Report) is the standard format for 24-hour weather forecasts. TAFs may contain some METAR data, but generally cover a smaller area. It typically forecasts significant weather changes, temporary changes, probable changes, and expected changes in weather conditions.

METAR and TAF text are displayed on the Weather Information Page. METAR data is displayed first in a decoded fashion, then as raw text. TAF information is displayed only in its raw form.

#### Displaying METAR and TAF text:

- 1) On the Weather Data Link Page, press the **METAR** Softkey.
- 2) Press the **Joystick** and pan to the desired airport.
- 3) Press the **ENT** Key. The Weather Information Page is shown with METAR and TAF text.



- 4) Use the **FMS** Knob or the **ENT** Key to scroll through the METAR and TAF text. METAR text must be completely scrolled through before scrolling through the TAF text.
  - 5) Press the **FMS** Knob or the **CLR** Key to return to the Weather Data Link Page.
- OR:**
- 1) Select the Weather Information Page.
    - a) Select the first rectangular page in the Waypoint Page Group.
    - b) Press the **WX** Softkey to select the Weather Information Page.
  - 2) Press the **FMS** Knob to display the cursor.
  - 3) Use the **FMS** Knob to enter the desired airport and press the **ENT** Key.
  - 4) Use the **FMS** Knob or the **ENT** Key to scroll through the METAR and TAF text. Note that the METAR text must be completely scrolled through before scrolling through the TAF text.

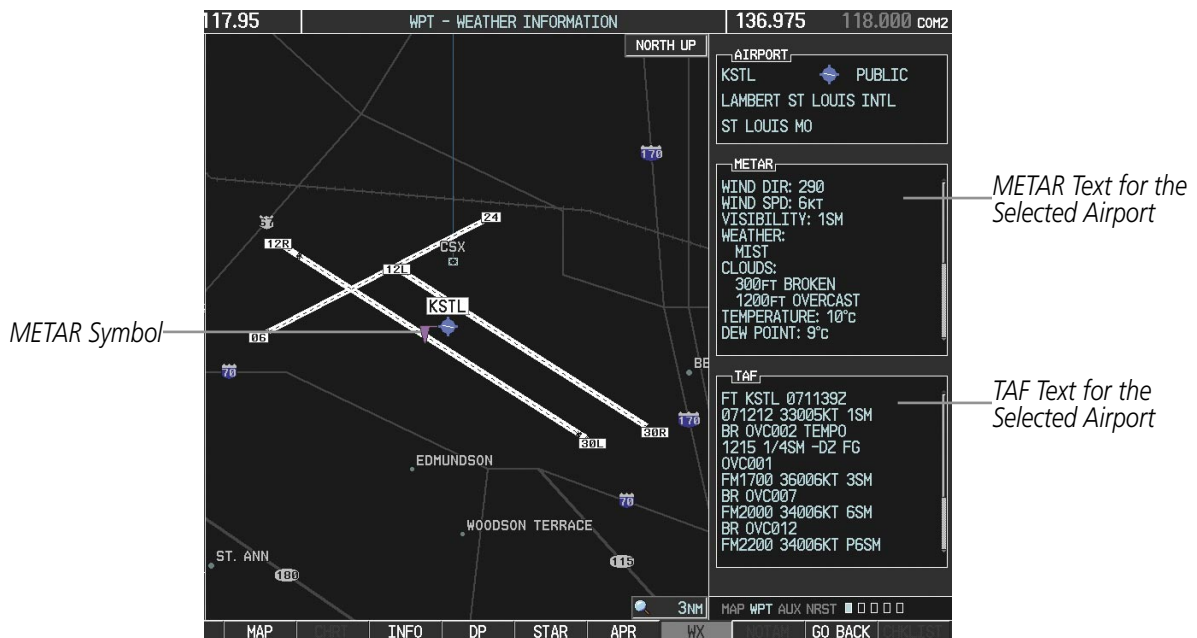

Figure 6-25 METAR and TAF Text on the Weather Information Page

To display the METAR legend on the Weather Data Link Page, press the **LEGEND** Softkey when METARs are selected for display.



Figure 6-26 METAR Legend

## SURFACE ANALYSIS AND CITY FORECAST



**NOTE:** Surface Analysis and City Forecast data are displayed only within the installed Aviation Database service area.

Surface Analysis and City Forecast information is available for current and forecast weather conditions. Forecasts are available for intervals of 12, 24, 36, and 48 hours.

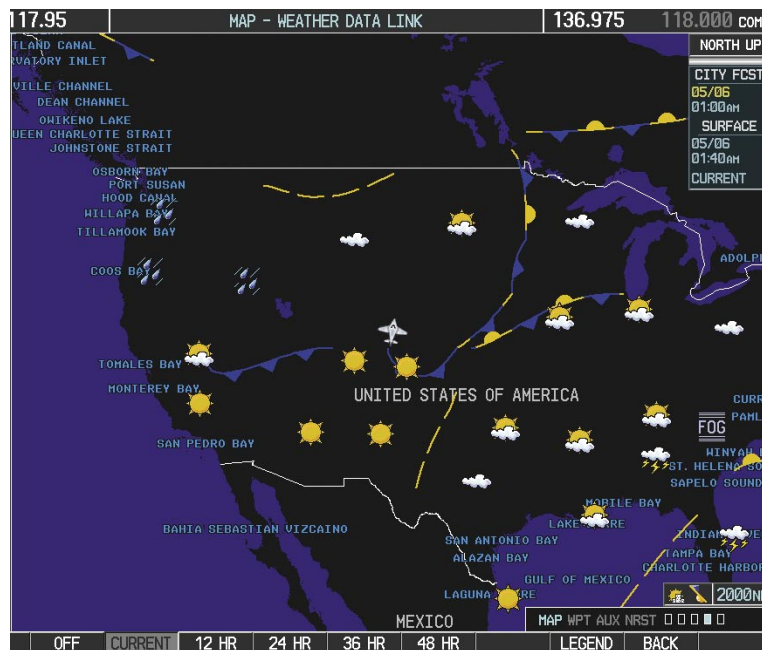

Figure 6-27 Current Surface Analysis Data

### Displaying Surface Analysis and City Forecast information:

- 1) Select the Weather Data Link Page.
- 2) Press the **MORE WX** Softkey.
- 3) Press the **SFC** Softkey.
- 4) Select the desired forecast time: **CURRENT**, **12 HR**, **24 HR**, **36 HR**, or **48 HR**. The **SFC** Softkey label changes to reflect the forecast time selected.

To display the Surface Analysis and City Forecast legend, press the **LEGEND** Softkey when Surface Analysis and City Forecast are selected to be displayed.

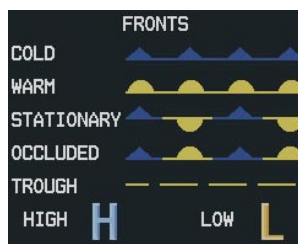

Figure 6-28 Surface Analysis Legend

**FREEZING LEVELS**

Freezing Level data shows the color-coded contour lines for the altitude and location at which the first isotherm is found. When no data is displayed for a given altitude, the data for that altitude has not been received, or is out of date and has been removed from the display. New data appears at the next update.

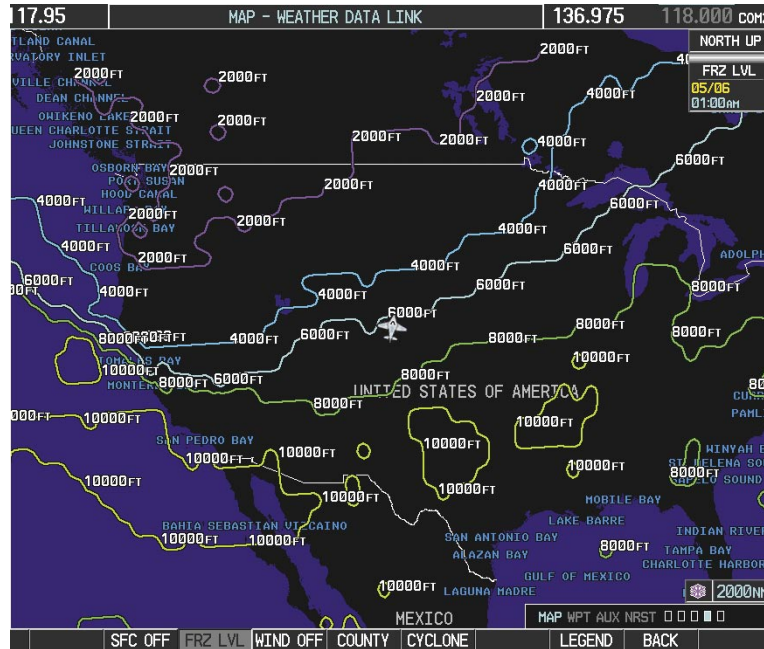

Figure 6-29 Freezing Level Data

**Displaying Freezing Level information:**

- 1) Select the Weather Data Link Page.
- 2) Press the **MORE WX** Softkey.
- 3) Press the **FRZ LVL** Softkey.

To display the Freezing Level legend, press the **LEGEND** Softkey when Freezing Level data is selected to be displayed.



Figure 6-30 Freezing Level Legend

## WINDS ALOFT

Winds Aloft data shows the forecasted wind speed and direction at the surface and at selected altitudes. Altitude can be displayed in 3,000-foot increments up to 42,000 feet MSL.

### Displaying Winds Aloft data:

- 1) Select the Weather Data Link Page.
- 2) Press the **MORE WX** Softkey.
- 3) Press the **WIND** Softkey.
- 4) Select the desired altitude level: SFC (surface) up to 42,000 feet. Press the **NEXT** or **PREV** Softkey to cycle through the altitude softkeys. The **WIND** Softkey label changes to reflect the altitude selected.

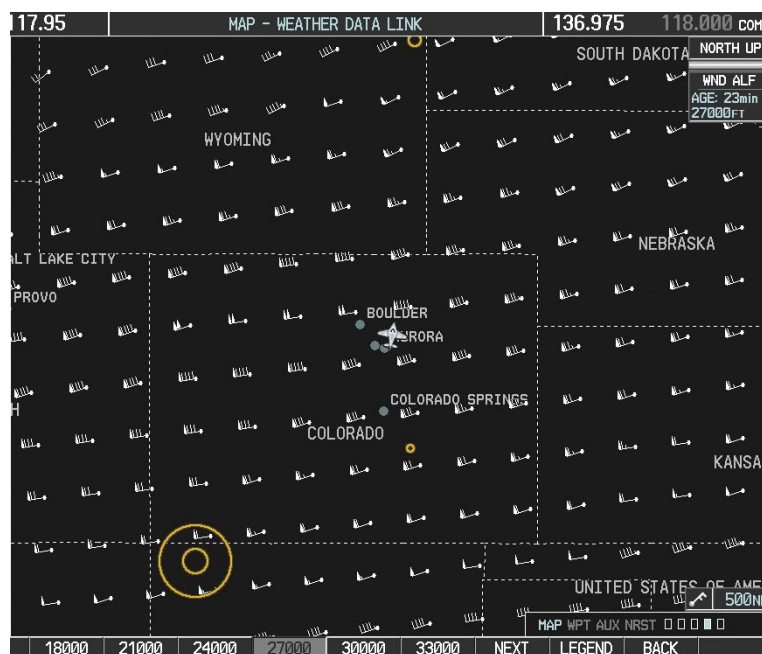

Figure 6-31 Winds Aloft Data at 27,000 Feet

To display the Winds Aloft legend, press the **LEGEND** Softkey when Winds Aloft is selected for display.

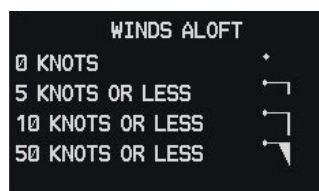
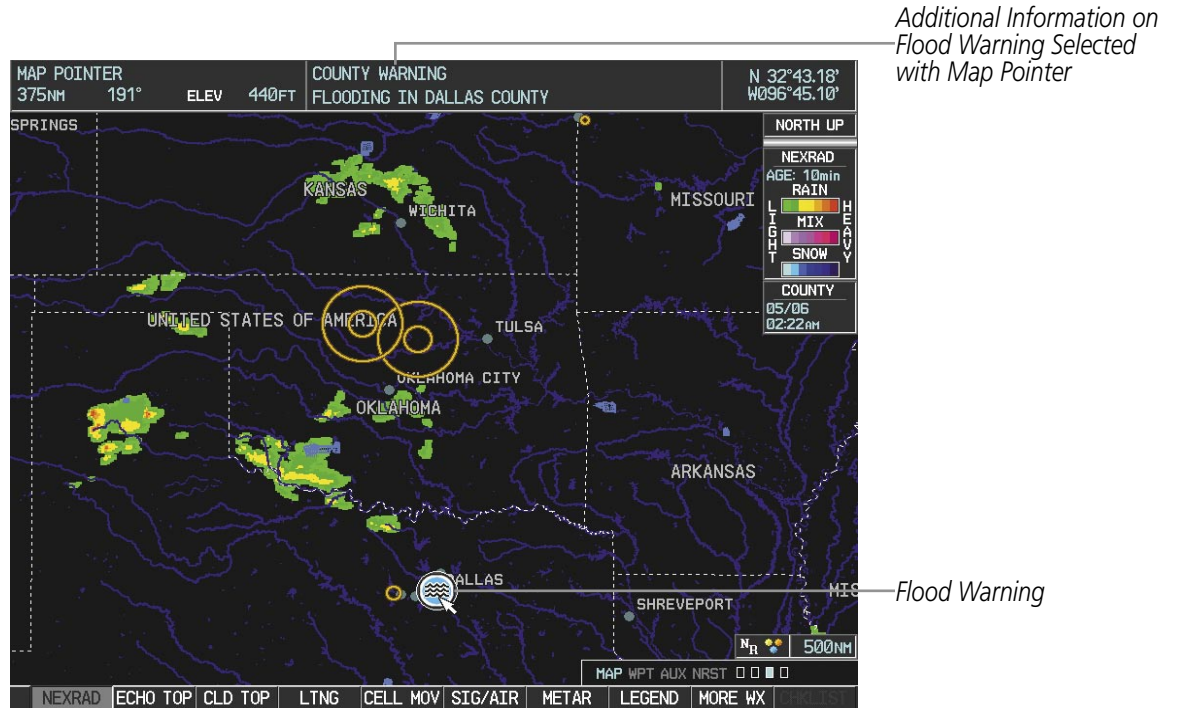

Figure 6-32 Winds Aloft Data with Legend

**COUNTY WARNINGS**

County data provides specific public awareness and protection weather warnings from the National Weather Service (NWS). This can include information on fires, tornadoes, severe thunderstorms, flood conditions, and other natural disasters.



**Figure 6-33 County Flood Warning**

**Displaying County Warning information:**

- 1) Select the Weather Data Link Page.
- 2) Select the **MORE WX** Softkey.
- 3) Select the **COUNTY** Softkey.

To display the County Warnings legend, select the **LEGEND** Softkey when County Warnings are selected to be displayed.



**Figure 6-34 County Warnings Legend**

## CYCLONE

The Cyclone weather product shows the current location of cyclones (hurricanes) and their projected tracks.



Figure 6-35 Cyclone Data Selected for Display

### Displaying cyclone (hurricane) track information:

- 1) Select the Weather Data Link Page.
- 2) Select the **MORE WX** Softkey.
- 3) Select the **CYCLONE** Softkey.

To display the Cyclone legend, press the **LEGEND** Softkey when Cyclones are selected to be displayed.



Figure 6-36 Cyclone Legend

## 6.2 WX-500 STORMSCOPE (OPTIONAL)



**NOTE:** *The Stormscope system is not intended for hazardous thunderstorm penetration. Weather information on the G1000 MFD is approved for weather avoidance only. Refer to the WX-500 User's Guide for a detailed description of Stormscope operation.*

The following pages can display Stormscope data:

- Stormscope Page
- Navigation Map
- AUX - Trip Planning Page
- Nearest Pages

To display Stormscope data on the Navigation Map, AUX - Trip Planning Page, or any of the Nearest Pages, press the **MAP** Softkey, then press the **STRMSCP** Softkey. These pages can also display cell or strike data using the yellow lightning strike symbology shown below.

| Lightning Age                          | Symbol |
|--|--------|
| Strike is less than 6 seconds old      |        |
| Strike is between 6 and 60 seconds old |        |
| Strike is between 1 and 2 minutes old  |        |
| Strike is between 2 and 3 minutes old  |        |

Table 6-3 Lightning Age and Symbols

### SETTING UP STORMSCOPE ON THE NAVIGATION MAP

- 1) On the Navigation Map Page, press the **MENU** Key.
- 2) Select the Map Setup option (Figure 6-37) and press the **ENT** Key.
- 3) Select the Weather group (Figure 6-38).
- 4) Press the **ENT** Key.
- 5) Turn the large **FMS** Knob to select STRMSCP LTNG.
- 6) Turn the small **FMS** Knob to select ON.
- 7) Press the **FMS** Knob to return to the Navigation Map Page (Figure 6-39).

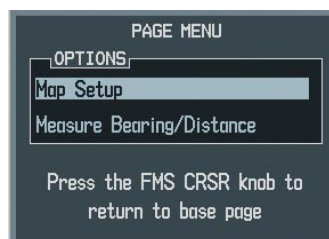

Figure 6-37 Page Menu

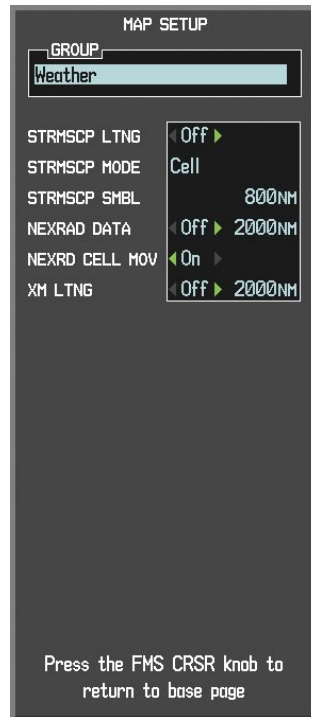

Figure 6-38 Map Setup Menu

## CELL AND STRIKE MODE ON THE NAVIGATION MAP

On the Navigation Map, cell mode identifies cells of lightning activity (Figure 6-39). Stormscope identifies clusters of electrical activity that indicate cells. Strike mode indicates the approximate location of lightning strikes.

### Selecting the Cell or Strike mode on the Navigation Map:

- 1) Press the **MENU** Key.
- 2) With Map Setup selected, press the **ENT** Key.
- 3) Select the Weather group.
- 4) Press the **ENT** Key. The cursor flashes on STRMSCP LTNG.
- 5) Turn the large **FMS** Knob to select STRMSCP MODE.
- 6) Turn the small **FMS** Knob to change between CELL and STRIKE options. When an item is selected, press the **ENT** Key.
- 7) Press the **FMS** Knob to return to the Navigation Map Page.



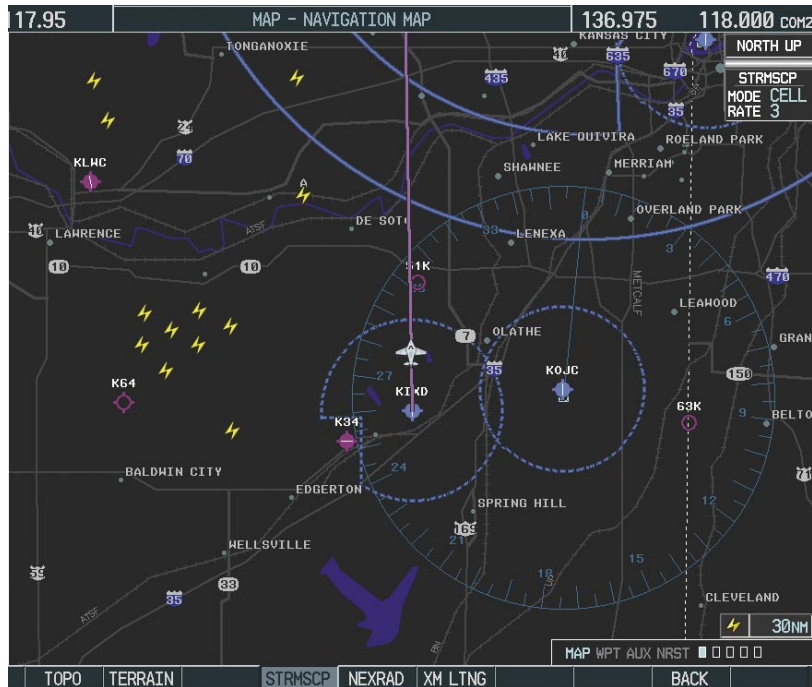
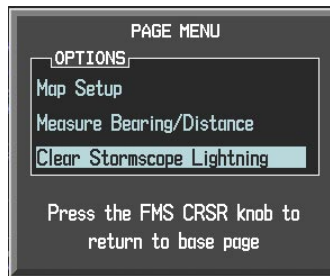

**Figure 6-39 Navigation Map Page with Stormscope Lightning Data**

If heading input is lost, strikes and/or cells must be cleared manually after the execution of each turn. This is to ensure that the strike and/or cell positions are depicted accurately in relation to the nose of the aircraft.

**Manually clearing Stormscope data on the Navigation Map:**

- 1) Press the **MENU** Key.
- 2) Select Clear Stormscope Lightning.
- 3) Press the **ENT** Key.



**Figure 6-40 Navigation Map Page Options Menu**

## ZOOM RANGE ON THE NAVIGATION MAP

Stormscope lightning data can be displayed up to 800 nm zoom range (in North up mode) on the Navigation Map Page. However, in the track up mode at the 500 nm range, a portion of Stormscope lightning data can be behind the aircraft and therefore not visible on the Navigation Map. Since the range for Stormscope data is 400 nm diameter total (200 nm in front and 200 nm behind), the 500 nm range in North up mode shows all the data.

At a map range of less than 25 nm, Stormscope lightning data is not displayed, but can still be present. The presence of Stormscope lightning data is indicated by the annunciation LTNG < 25 nm in the upper right corner.

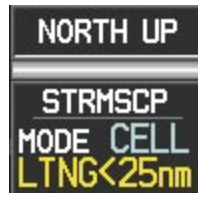

Figure 6-41 Lightning Display Range Annunciation

The maximum zoom range can also be set on the Navigation Map. Note that Stormscope data above the selected maximum zoom range is decluttered.

### Selecting a Stormscope range on the Navigation Map:

- 1) Press the **MENU** Key.
- 2) Select MAP SETUP.
- 3) Select the Weather group.
- 4) Press the **ENT** Key.
- 5) Turn the large **FMS** Knob to select STRMSCP SMBL.
- 6) Turn the small **FMS** Knob to select the maximum display range.
- 7) Press the **ENT** Key.
- 8) Press the **FMS** Knob to return to the Navigation Map Page.

To change the display range on the Navigation Map Page, turn the **Joystick** clockwise to zoom out or counter-clockwise to zoom in.

## SELECTING THE STORMSCOPE PAGE

If Stormscope is installed, the Stormscope Page is the third rectangular icon in the Map group of pages. Stormscope lightning data can be displayed at the ranges of 25 nm, 50 nm, 100 nm, and 200 nm. Lightning data can be displayed in CELL or STRIKE mode in the 360° or 120° view.



Figure 6-42 Stormscope Page

### Changing between Cell and Strike mode on the Stormscope Page:

- 1) Select the Stormscope Page.
- 2) Press the **MODE** Softkey. The **CELL** and **STRIKE** softkeys are displayed.
- 3) Press the **CELL** Softkey to display CELL data or press the **STRIKE** Softkey to display STRIKE data. CELL or STRIKE is displayed in the mode box in the upper left corner of the Stormscope Page.
- 4) Press the **BACK** Softkey to return to the main Stormscope page.

### Changing the viewing mode between 360° and 120° on the Stormscope Page:

- 1) Select the Stormscope Page.
- 2) Press the **VIEW** Softkey. The **360** and **ARC** softkeys are displayed. Press the **360** Softkey to display a 360° viewing area or press the **ARC** Softkey to display a 120° viewing area.
- 3) Press the **BACK** Softkey to return to the main Stormscope page.

## 6.3 TERRAIN PROXIMITY



**WARNING:** Do not use Terrain Proximity information for primary terrain avoidance. Terrain Proximity is intended only to enhance situational awareness.



**NOTE:** Terrain data is not displayed when the aircraft latitude is greater than 75° North or 60° South.

G1000 Terrain Proximity is a non-TSO-C151b-certified terrain awareness system. It increases situational awareness and aids in reducing controlled flight into terrain (CFIT). Do not confuse Terrain Proximity with Terrain Awareness and Warning System (TAWS). TAWS is more sophisticated and robust, and it is TSO-C151b certified. Terrain Proximity does not provide warning annunciations or voice alerts. It only provides color indications on map displays when terrain and obstacles are within a certain altitude threshold from the aircraft. Although the terrain and obstacle color map displays are the same, TAWS uses more sophisticated algorithms to assess aircraft distance from terrain and obstacles.

Terrain Proximity requires the following components to operate properly:

- Valid 3-D GPS position
- Valid terrain/obstacle database

Terrain Proximity displays altitudes of terrain and obstructions relative to the aircraft position and altitude with reference to a database that may contain inaccuracies. Terrain and obstructions are shown only if they are in the database. Terrain and obstacle information should be used as an aid to situational awareness. They should never be used to navigate or maneuver around terrain.

Note that all obstructions may not be available in the terrain and obstacle database. No terrain and obstacle information is shown without a valid 3-D GPS position.

The G1000 GPS receiver provides the horizontal position and altitude. GPS altitude is derived from satellite position. GPS altitude is then converted to a mean sea level (MSL)-based altitude (GPS-MSL altitude) and is used to determine terrain and obstacle proximity. GPS-MSL altitude accuracy is affected by satellite geometry, but is not subject to variations in pressure and temperature that normally affect pressure altitude sensors. GPS-MSL altitude does not require local altimeter settings to determine MSL altitude. It is a widely-used MSL altitude source.

Terrain and obstacle databases are referenced to MSL. Using the GPS position and altitude, the Terrain Proximity feature portrays a 2-D picture of the surrounding terrain and obstacles relative to the position and altitude of the aircraft. GPS position and GPS-MSL altitude are used to calculate and predict the aircraft's flight path in relation to the surrounding terrain and obstacles. In this way, the pilot can view predicted dangerous terrain and obstacle conditions.

## DISPLAYING TERRAIN PROXIMITY DATA

The symbols and colors shown in the figure and table below are used to represent obstacles and aircraft altitude when the Terrain Proximity Page is selected for display. Terrain Proximity uses black, yellow, and red to represent terrain information relative to aircraft altitude. The color of each obstacle is associated with the altitude of the aircraft.

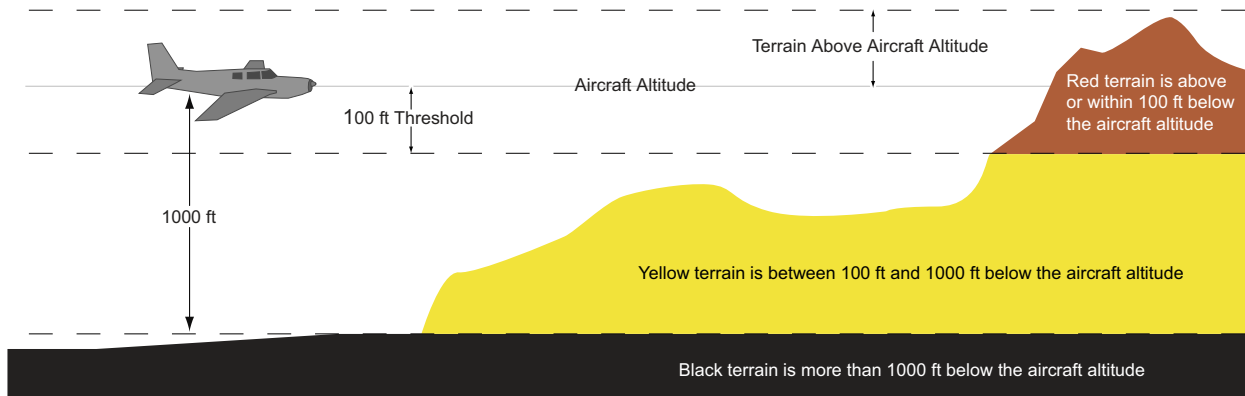

Figure 6-43 Terrain Altitude/Color Correlation for Terrain Proximity

| Unlighted Obstacle |             | Lighted Obstacle |             | Obstacle Location   |
|--------------------|-------------|------------------|-------------|---|
| < 1000' AGL        | > 1000' AGL | < 1000' AGL      | > 1000' AGL |   |
|                    |             |                  |             | Red obstacle is above or within 100 ft below the aircraft altitude        |
|                    |             |                  |             | Yellow obstacle is between 100 ft and 1000 ft below the aircraft altitude |

Table 6-4 Terrain Proximity Terrain/Obstacle Colors and Symbology

Terrain and obstacle information can be displayed on the following pages:

- PFD Inset Map
- Navigation Map Page
- Terrain Proximity Page
- Trip Planning Page
- Flight Plan Page

### Displaying terrain and obstacle information (maps other than the Terrain Proximity Page):

- 1) Press the **MAP** Softkey (for the PFD Inset Map, select the **INSET** Softkey).
- 2) Press the **TERRAIN** Softkey to display terrain and obstacle data.

When Terrain Proximity is selected on maps other than the Terrain Proximity Page, an icon to indicate the feature is enabled for display and a legend for Terrain Proximity colors is shown.

The Navigation Map Page Setup Menu provides a means in addition to the softkey for enabling/disabling display of terrain and obstacles. The setup menu also controls the map range settings above which terrain and obstacle data are decluttered from the display. If a map range larger than the map range setting is selected, the data is removed from the map.

Terrain data can be selected for display independently of obstacle data; however, obstacles recognized by Terrain Proximity as yellow or red are shown when terrain is selected for display and the map range is within the setting limit.

Maps besides the Terrain Proximity Page use settings based on those selected for the Navigation Map Page. The maximum display ranges for obstacles on each map are dependent on the range setting made for the Navigation Map. If the maximum range for obstacle display on the Navigation Map is adjusted to below 20 nm, the highest obstacle display range settings on the other applicable maps are also adjusted proportionally.

### Customizing terrain and obstacle display on the Navigation Map Page:

- 1) Select the Navigation Map Page.
- 2) Press the **MENU** Key.
- 3) With 'Map Setup' highlighted, press the **ENT** Key (Figure 6-44).
- 4) Turn the small **FMS** Knob to select the 'Map' Group and press the **ENT** Key (Figure 6-45).
- 5) Turn the large **FMS** Knob or press the **ENT** Key to scroll through product selections (Figure 6-46).
  - TERRAIN DATA – Turns the display of terrain data on or off and sets maximum range at which terrain is shown
  - OBSTACLE DATA – Turns the display of obstacle data on or off and sets maximum range at which obstacles are shown
- 6) Turn the small **FMS** Knob to scroll through options for each product (ON/OFF, range settings).
- 7) Press the **ENT** Key to select an option.
- 8) Press the **FMS** Knob or **CLR** Key to return to the Navigation Map Page with the changed settings.

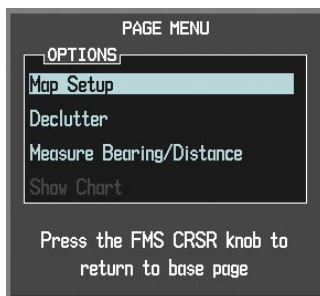

Figure 6-44 Navigation Map Page Menu

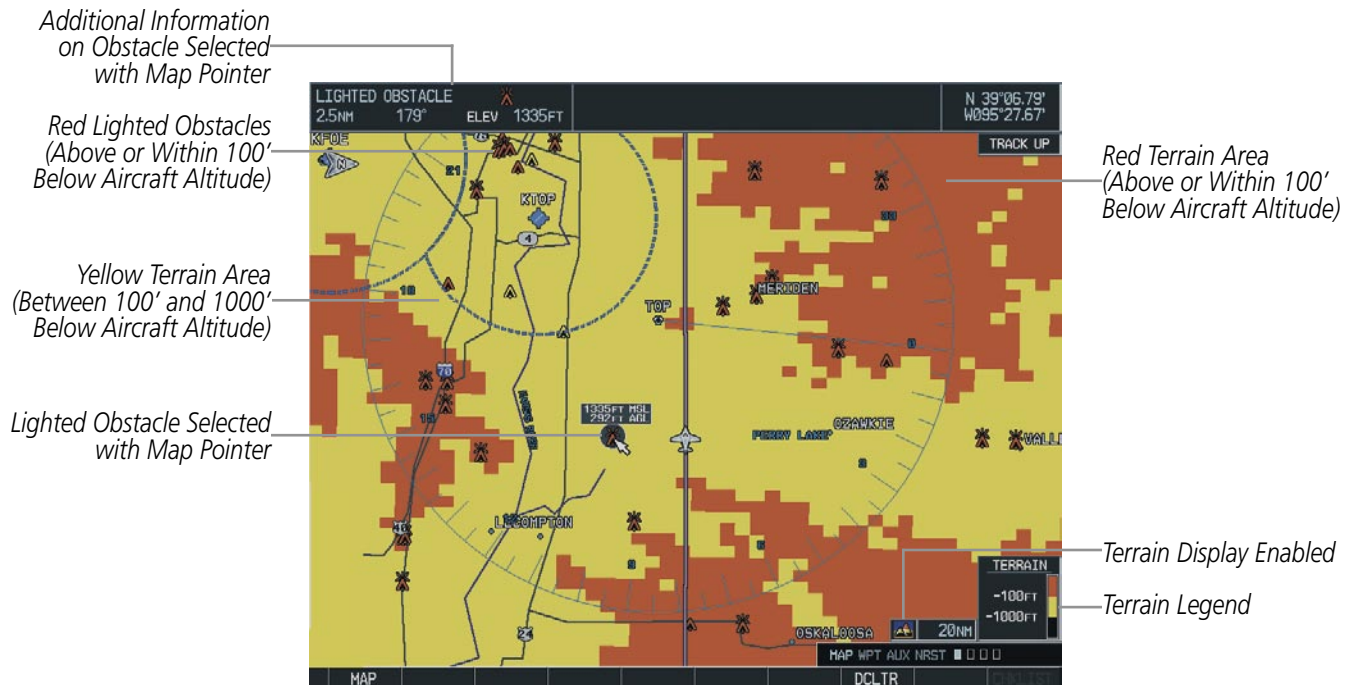

Figure 6-45 Navigation Map Page Setup Menu



Figure 6-46 Navigation Map Page Setup Menu, Map Group

Additional information about obstacles can be displayed by panning over the display on the map. The map panning feature is enabled by pressing the **Joystick**. The map range is adjusted by turning the **Joystick**. If the map range is adjusted while panning is enabled, the map is re-centered on the Map Pointer.



**Figure 6-47 Terrain Information on the Navigation Map Page**

## **TERRAIN PROXIMITY PAGE**

The Terrain Proximity Page is specialized to show terrain and obstacle data in relation to the aircraft's current altitude, without clutter from the basemap. Aviation data (airports, VORs, and other NAVAIDs) can be displayed for reference.

Aircraft orientation on this map is always heading up unless there is no valid heading. Two views are available relative to the position of the aircraft: the 360° default display and the radar-like ARC (120°) display. Map range is adjustable with the **Joystick** from 1 to 200 nm, as indicated by the map range rings (or arcs).

### **Displaying the Terrain Proximity Page:**

- 1) Turn the large **FMS** Knob to select the Map Page Group.
  - 2) Turn the small **FMS** Knob to select the last rectangular page icon.
  - 3) To change the view,
    - a) Press the **VIEW** Softkey.
    - b) Press the **360** or **ARC** Softkey to select the desired view.
- OR:**
- a) Press the **MENU** Key.
  - b) Select 'View 120°' or 'View 360°' (choice dependent on current state) and press the **ENT** Key to change the view.

Showing/hiding aviation information on the Terrain Proximity Page:

- 1) Press the **MENU** Key.
- 2) Select 'Show Aviation Data' or 'Hide Aviation Data' (choice dependent on current state) and press the **ENT** Key.



Figure 6-48 Terrain Proximity Page

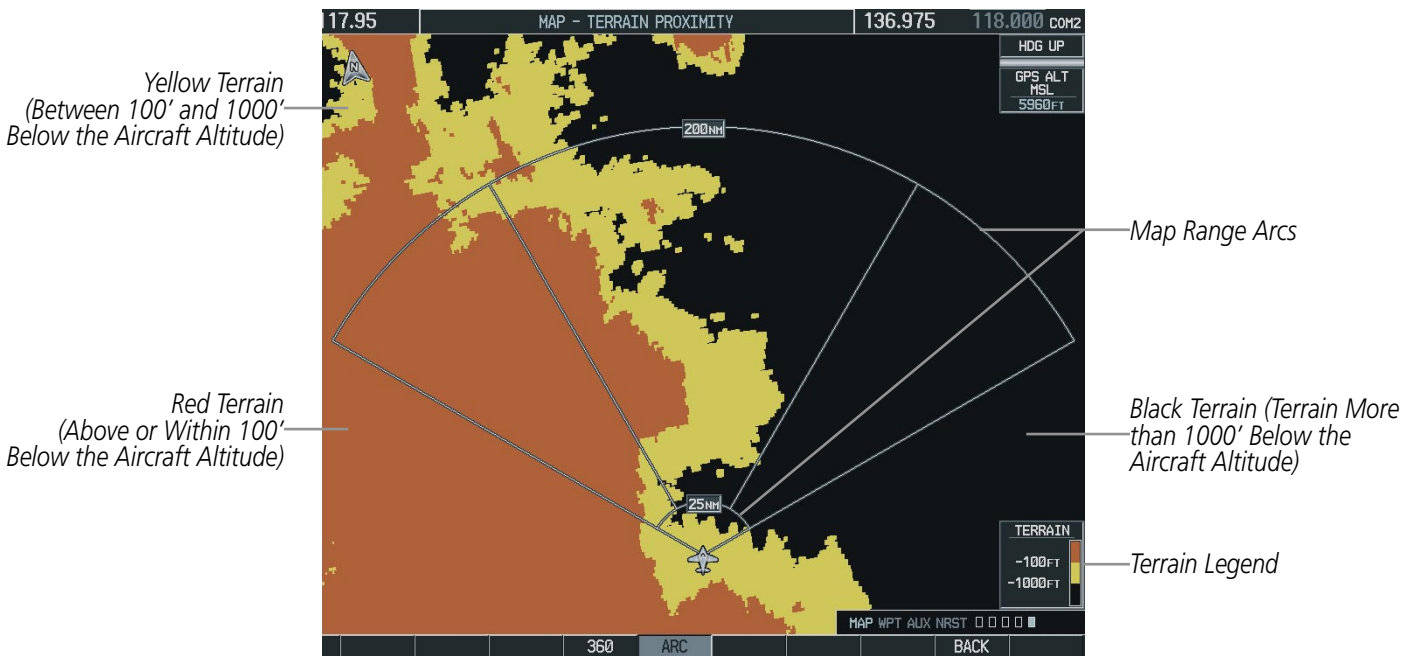

Figure 6-49 Terrain Proximity Page (ARC View)



## 6.4 TERRAIN AWARENESS AND WARNING SYSTEM (TAWS - OPTIONAL)



**NOTE:** *The data contained in the TAWS databases comes from government agencies. Garmin accurately processes and cross-validates the data but cannot guarantee the accuracy and completeness of the data.*

TAWS (Terrain Awareness and Warning System) is an optional feature to increase situational awareness and aid in reducing controlled flight into terrain (CFIT). TAWS provides visual and aural annunciations when terrain and obstacles are within the given altitude threshold from the aircraft. The displayed alerts and warnings are advisory in nature only.

Terrain information should be used as an aid to situational awareness. Never use it for navigation or to maneuver to avoid terrain. Never use this information for navigation or to maneuver to avoid obstacles.

TAWS satisfies TSO-C151b Class B requirements for certification. Class B TAWS is required for all Part 91 aircraft operations with six or more passenger seats and for Part 135 turbine aircraft operations with six to nine passenger seats (FAR Parts 91.223, 135.154).

TAWS requires the following to operate properly:

- A valid terrain/obstacle/airport terrain database
- A valid 3-D GPS position solution

TAWS uses terrain and obstacle information supplied by government sources. Terrain information is based on terrain elevation information in a database that may contain inaccuracies. Individual obstructions may be shown if available in the database. The data undergoes verification by Garmin to confirm accuracy of the content, per TSO-C151b. However, the displayed information should never be understood as being all-inclusive and data may be inaccurate.

TAWS uses information provided from the GPS receiver to provide a horizontal position and altitude. GPS altitude is derived from satellite measurements. GPS altitude is converted to a mean sea level (MSL)-based altitude (GPS-MSL altitude) and is used to determine TAWS alerts. GPS-MSL altitude accuracy is affected by factors such as satellite geometry, but it is not subject to variations in pressure and temperature that normally affect pressure altitude devices. GPS-MSL altitude does not require local altimeter settings to determine MSL altitude. Therefore, GPS altitude provides a highly accurate and reliable MSL altitude source to calculate terrain and obstacle alerts.

The terrain and obstacle databases used by TAWS are referenced to mean sea level (MSL). Using the GPS position and GPS-MSL altitude, TAWS displays a 2-D picture of the surrounding terrain and obstacles relative to the position and altitude of the aircraft. Furthermore, the GPS position and GPS-MSL altitude are used to calculate and “predict” the aircraft’s flight path in relation to the surrounding terrain and obstacles. In this manner, TAWS can provide advanced alerts of predicted dangerous terrain conditions.

Baro-corrected altitude (or indicated altitude) is derived by adjusting the altimeter setting for local atmospheric conditions. The most accurate baro-corrected altitude can be achieved by frequently updating the altimeter setting to the nearest reporting station along the flight path. However, because actual atmosphere conditions seldom match the standard conditions defined by the International Standard Atmosphere (ISA) model (where pressure, temperature, and lapse rates have fixed values), it is common for the baro-corrected altitude (as read from the altimeter) to differ from the GPS-MSL altitude. This variation results in the aircraft’s true altitude differing from the baro-corrected altitude.

## DISPLAYING TAWS DATA

TAWS uses yellow (caution) and red (warning) to depict terrain and obstacles (with heights greater than 200 feet above ground level, AGL) alerts relative to aircraft altitude. Colors are adjusted automatically as the aircraft altitude changes. The colors and symbols shown in the figure and table below are used to represent terrain, obstacles, and potential impact points.

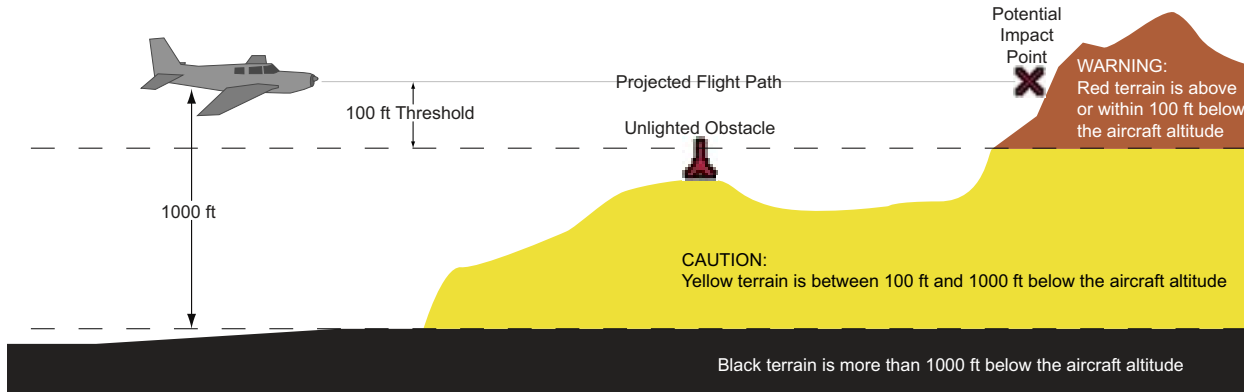

Figure 6-50 Terrain Altitude/Color Correlation for TAWS

| Unlighted Obstacle |             | Lighted Obstacle |             | Potential Impact Points | Obstacle Location  |
|--------------------|-------------|------------------|-------------|-------------------------|--|
| < 1000' AGL        | > 1000' AGL | < 1000' AGL      | > 1000' AGL |                         |  |
|                    |             |                  |             |                         | WARNING: Red obstacle is above or within 100' below current aircraft altitude      |
|                    |             |                  |             |                         | CAUTION: Yellow obstacle is between 100' and 1000' below current aircraft altitude |

Table 6-5 TAWS Obstacle Colors and Symbology

TAWS information can be displayed on the following maps:

- PFD Inset Map
- Navigation Map Page
- TAWS Page
- Trip Planning Page
- Flight Plan Pages

### Displaying terrain and obstacle information (maps other than the TAWS Page):

- 1) Press the **MAP** Softkey (for the PFD Inset Map, select the **INSET** Softkey).
- 2) Press the **TERRAIN** Softkey to display terrain and obstacle data.

When TAWS is selected on maps other than the TAWS Page, an icon to indicate the feature is enabled for display and a legend for TAWS terrain colors is shown.

The Navigation Map Page Setup Menu provides a means in addition to the softkey for enabling/disabling display of terrain and obstacles. The setup menu also controls the map range settings above which terrain and obstacle data are decluttered from the display. If a map range larger than the map range setting is selected, the data is removed from the map.

Terrain data can be selected for display independently of obstacle data; however, obstacles for which warnings and cautions are issued are shown when terrain is selected for display and the map range is within the setting limit.

Maps besides the TAWS Page use settings based on those selected for the Navigation Map Page. The maximum display ranges for obstacles on each map are dependent on the range setting made for the Navigation Map. If the maximum range for obstacle display on the Navigation Map is adjusted to below 20 nm, the highest obstacle display range settings on the other applicable maps are also adjusted proportionally.

**Customizing terrain and obstacle display on the Navigation Map Page:**

- 1) Select the Navigation Map Page.
- 2) Press the **MENU** Key.
- 3) With 'Map Setup' highlighted, press the **ENT** Key (Figure 6-51).
- 4) Turn the small **FMS** Knob to select the 'Map' Group and press the **ENT** Key (Figure 6-52).
- 5) Turn the large **FMS** Knob or press the **ENT** Key to scroll through product selections (Figure 6-53).
  - TERRAIN DATA – Turns the display of terrain data on or off and sets maximum range at which terrain is shown
  - OBSTACLE DATA – Turns the display of obstacle data on or off and sets maximum range at which obstacles are shown
- 6) Turn the small **FMS** Knob to scroll through options for each product (ON/OFF, range settings).
- 7) Press the **ENT** Key to select an option.
- 8) Press the **FMS** Knob or **CLR** Key to return to the Navigation Map Page with the changed settings.

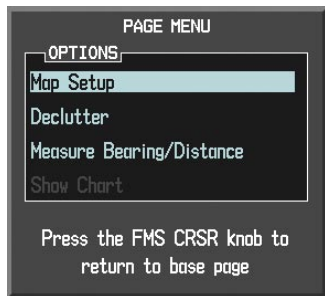

Figure 6-51 Navigation Map Page Menu



Figure 6-52 Navigation Map Page Setup Menu



Figure 6-53 Navigation Map Page Setup Menu, Map Group

## TAWS PAGE

---

The TAWS Page is specialized to show terrain, obstacle, and potential impact point data in relation to the aircraft's current altitude, without clutter from the basemap. Aviation data (airports, VORs, and other NAVAIDs) can be displayed for reference. If an obstacle and the projected flight path of the aircraft intersect, the display automatically zooms in to the closest potential point of impact on the TAWS Page.

Aircraft orientation on this map is always heading up unless there is no valid heading. Two views are available relative to the position of the aircraft: the 360° default display and the radar-like ARC (120°) display. Map range is adjustable with the **Joystick** from 1 to 200 nm, as indicated by the map range rings (or arcs).

### Displaying the TAWS Page:

- 1) Turn the large **FMS** Knob to select the Map Page Group.
  - 2) Turn the small **FMS** Knob to select the last rectangular page icon.
  - 3) To change the view,
    - a) Press the **VIEW** Softkey.
    - b) Press the **360** or **ARC** Softkey to select the desired view.
- OR:**
- a) Press the **MENU** Key.
  - b) Select 'View 120°' or 'View 360°' (choice dependent on current state) and press the **ENT** Key to change the view.

### Showing/hiding aviation information on the TAWS Page:

- 1) Press the **MENU** Key.
- 2) Select 'Show Aviation Data' or 'Hide Aviation Data' (choice dependent on current state) and press the **ENT** Key.

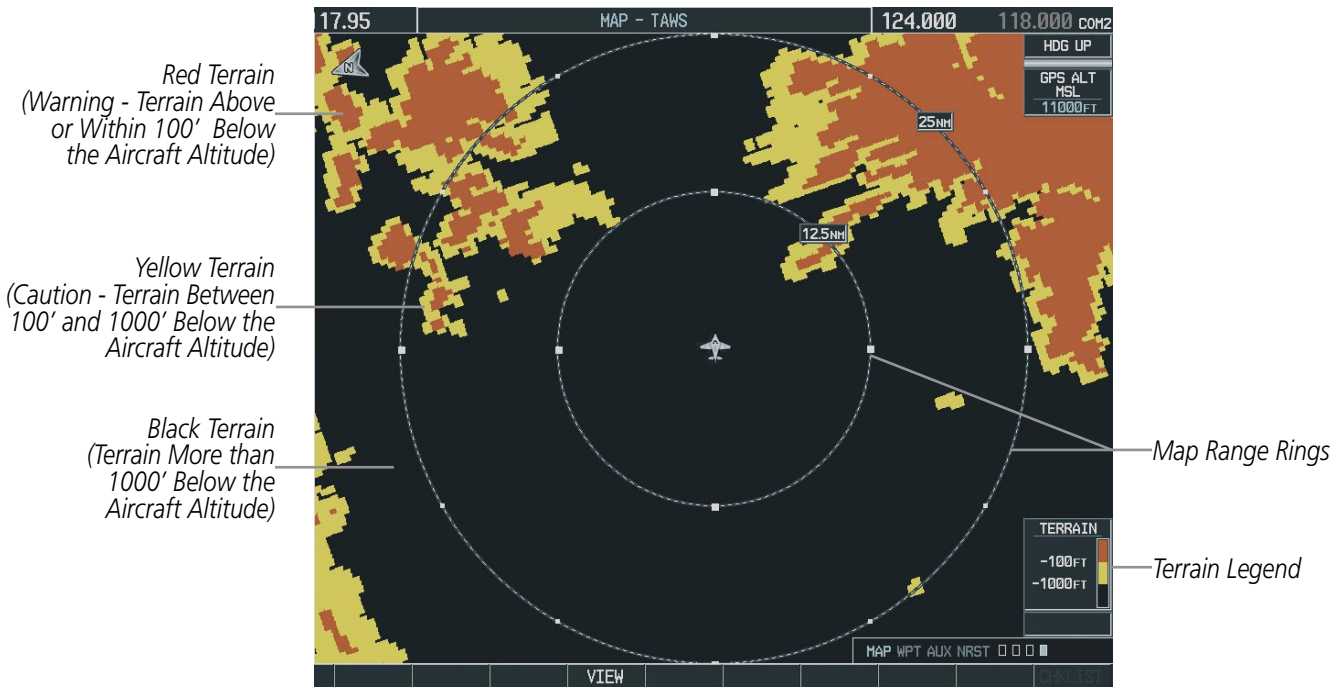

Figure 6-54 TAWS Page

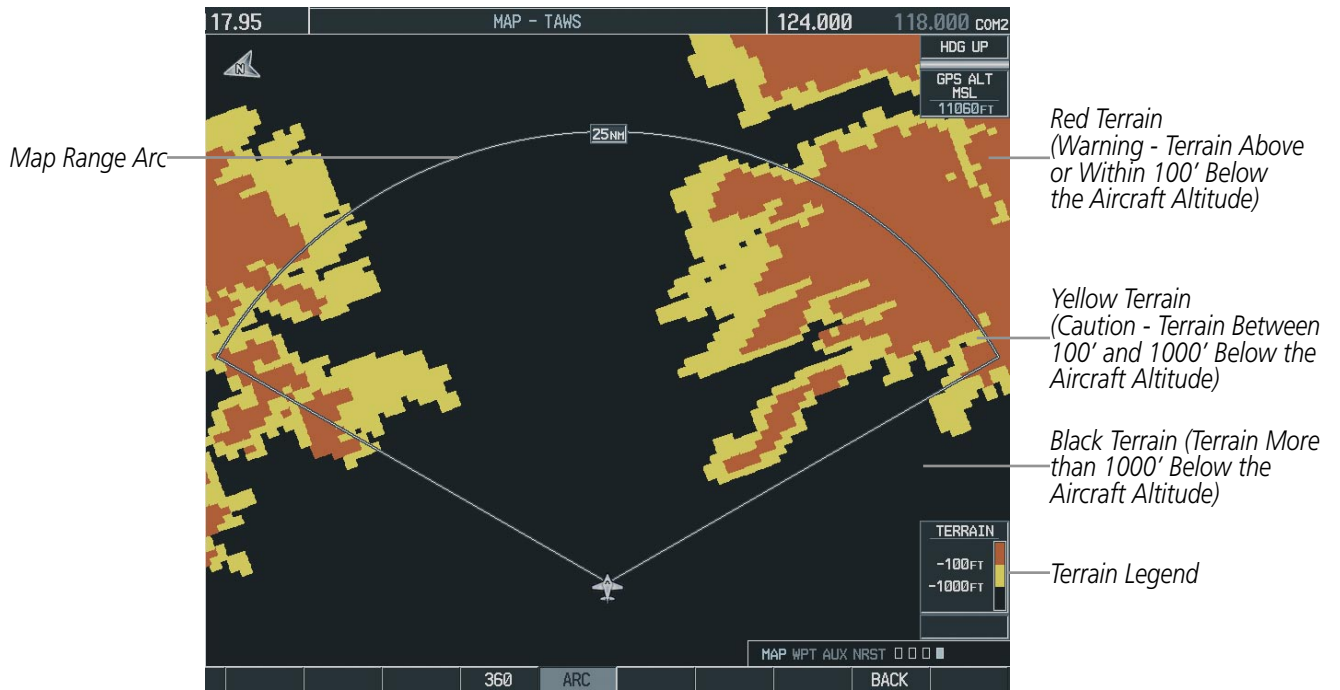

Figure 6-55 TAWS Page (ARC View)

## TAWS ALERTS

Alerts are issued when flight conditions meet parameters that are set within TAWS software algorithms. TAWS alerts typically employ a CAUTION or a WARNING alert severity level, or both. When an alert is issued, visual annunciations are displayed and aural alerts are simultaneously issued. Table 6-6 shows TAWS alert types with corresponding annunciations and aural messages.

When an alert is issued, annunciations appear on the PFD and MFD. The TAWS Alert Annunciation is shown to the upper left of the Altimeter on the PFD and below the Terrain Legend on the MFD. If the TAWS Page is not displayed at the time, a pop-up alert appears on the MFD. To acknowledge the pop-up alert:

- Press the **CLR** Key (returns to the currently viewed page), or
- Press the **ENT** Key (accesses the TAWS Page)

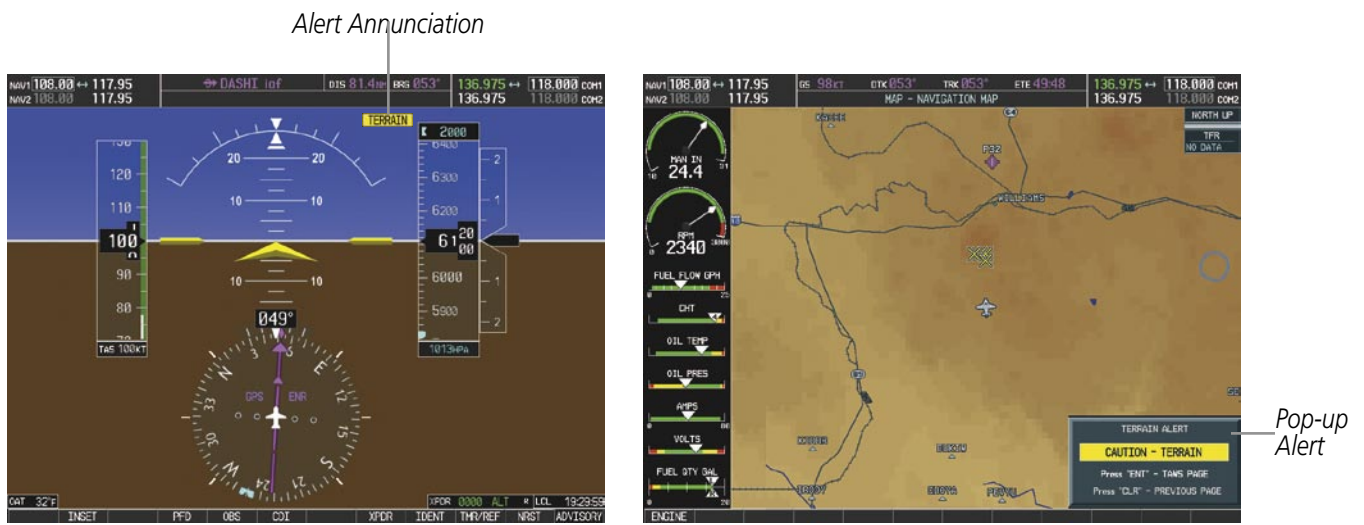

Figure 6-56 TAWS Alert Annunciations

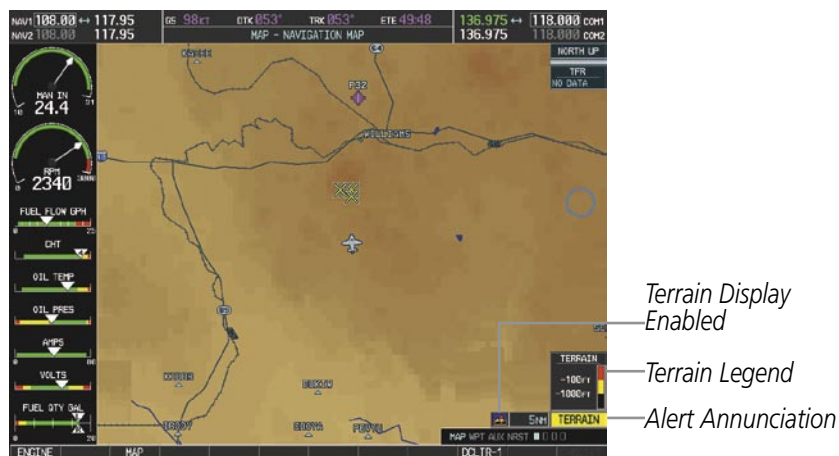

Figure 6-57 Navigation Map Page (After TAWS Pop-up Alert Acknowledgment)

| Alert Type  | PFD/MFD Alert Annunciation | MFD Pop-Up Alert   | Aural Message  |
|---|----------------------------|--|--|
| Excessive Descent Rate Warning (EDR)              | <b>PULL UP</b>             | <b>PULL-UP</b>   | "Pull Up"  |
| Reduced Required Terrain Clearance Warning (RTC)  | <b>PULL UP</b>             | <b>TERRAIN - PULL-UP</b> *<br>or<br><b>TERRAIN AHEAD - PULL-UP</b>   | "Terrain, Terrain; Pull Up, Pull Up" *<br>or<br>"Terrain Ahead, Pull Up; Terrain Ahead, Pull Up"     |
| Imminent Terrain Impact Warning (ITI)             | <b>PULL UP</b>             | <b>TERRAIN AHEAD - PULL-UP</b> *<br>or<br><b>TERRAIN - PULL-UP</b>   | Terrain Ahead, Pull Up; Terrain Ahead, Pull Up' *<br>or<br>"Terrain, Terrain; Pull Up, Pull Up"      |
| Reduced Required Obstacle Clearance Warning (ROC) | <b>PULL UP</b>             | <b>OBSTACLE - PULL-UP</b> *<br>or<br><b>OBSTACLE AHEAD - PULL-UP</b> | "Obstacle, Obstacle; Pull Up, Pull Up" *<br>or<br>"Obstacle Ahead, Pull Up; Obstacle Ahead, Pull Up" |
| Imminent Obstacle Impact Warning (IOI)            | <b>PULL UP</b>             | <b>OBSTACLE AHEAD - PULL-UP</b> *<br>or<br><b>OBSTACLE - PULL-UP</b> | "Obstacle Ahead, Pull Up; Obstacle Ahead, Pull Up"<br>or<br>"Obstacle, Obstacle; Pull Up, Pull Up"   |
| Reduced Required Terrain Clearance Caution (RTC)  | <b>TERRAIN</b>             | <b>CAUTION - TERRAIN</b> *<br>or<br><b>TERRAIN AHEAD</b>             | "Caution, Terrain; Caution, Terrain" *<br>or<br>"Terrain Ahead; Terrain Ahead"                       |
| Imminent Terrain Impact Caution (ITI)             | <b>TERRAIN</b>             | <b>TERRAIN AHEAD</b> *<br>or<br><b>CAUTION - TERRAIN</b>             | "Terrain Ahead; Terrain Ahead" *<br>or<br>"Caution, Terrain; Caution, Terrain"                       |
| Reduced Required Obstacle Clearance Caution (ROC) | <b>TERRAIN</b>             | <b>CAUTION - OBSTACLE</b> *<br>or<br><b>OBSTACLE AHEAD</b>           | "Caution, Obstacle; Caution, Obstacle" *<br>or<br>"Obstacle Ahead; Obstacle Ahead"                   |
| Imminent Obstacle Impact Caution (IOI)            | <b>TERRAIN</b>             | <b>OBSTACLE AHEAD</b> *<br>or<br><b>CAUTION - OBSTACLE</b>           | "Obstacle Ahead; Obstacle Ahead" *<br>or<br>"Caution, Obstacle; Caution, Obstacle"                   |
| Premature Descent Alert Caution (PDA)             | <b>TERRAIN</b>             | <b>TOO LOW - TERRAIN</b>   | "Too Low, Terrain"   |
| Altitude Callout "500"                            | None                       | None   | "Five-Hundred"   |
| Excessive Descent Rate Caution (EDR)              | <b>TERRAIN</b>             | <b>SINK RATE</b>   | "Sink Rate"  |
| Negative Climb Rate Caution (NCR)                 | <b>TERRAIN</b>             | <b>DON'T SINK</b> *<br>or<br><b>TOO LOW - TERRAIN</b>                | "Don't Sink" *<br>or<br>"Too Low, Terrain"   |

\* Alerts with multiple messages are configurable at installation and are installation-dependent. Alerts for the default configuration are indicated with asterisks.

**Table 6-6 TAWS Alerts Summary**

## EXCESSIVE DESCENT RATE ALERT

The purpose of the **Excessive Descent Rate (EDR)** alert is to provide suitable notification when the aircraft is determined to be closing (descending) upon terrain at an excessive speed. The figure below shows the parameters for the alert as defined by TSO-C151b.

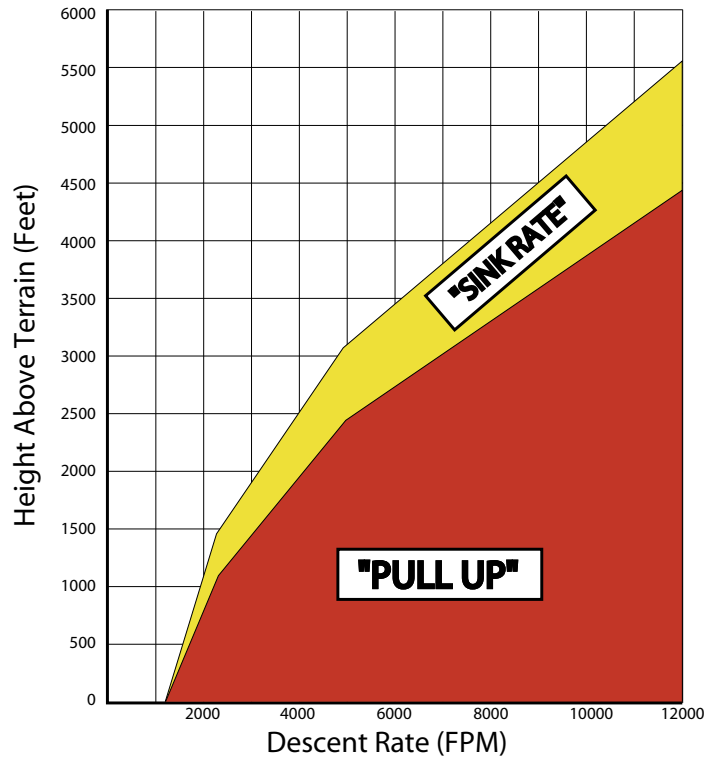

Figure 6-58 Excessive Descent Rate Alert Criteria



**FORWARD LOOKING TERRAIN AVOIDANCE**

**Reduced Required Terrain Clearance (RTC)** and **Reduced Required Obstacle Clearance (ROC)** alerts are issued when the aircraft flight path is above terrain, yet is projected to come within the minimum clearance values shown in the table. When an RTC alert is issued, a potential impact point is displayed on the TAWS Page.

**Imminent Terrain Impact (ITI)** and **Imminent Obstacle Impact (IOI)** alerts are issued when the aircraft is below the elevation of a terrain or obstacle cell in the aircraft’s projected path. ITI and IOI alerts are accompanied by a potential impact point displayed on the TAWS Page. The alert is annunciated when the projected vertical flight path is calculated to come within minimum clearance altitudes.

| Flight Phase | Minimum Clearance Altitude (ft) |            |
|--------------|---------------------------------|------------|
|              | Level Flight                    | Descending |
| Enroute      | 700                             | 500        |
| Terminal     | 350                             | 300        |
| Approach     | 150                             | 100        |
| Departure    | 100                             | 100        |

**Table 6-7 FLTA Alert Minimum Terrain and Obstacle Clearance Values**

During final approach, FLTA alerts are automatically inhibited when the aircraft is below 200 feet AGL while within 0.5 nm of the approach runway or below 125 feet AGL while within 1.0 nm of the runway threshold.

## PREMATURE DESCENT ALERTING

A **Premature Descent Alert (PDA)** is issued when the system detects that the aircraft is significantly below the normal approach path to a runway.

PDA alerting begins when the aircraft is within 15 nm of the destination airport and ends when the aircraft is either 0.5 nm from the runway threshold OR is at an altitude of 125 feet AGL while within 1.0 nm of the threshold. During the final descent, algorithms will set a threshold for alerting based on speed, distance, and other parameters.

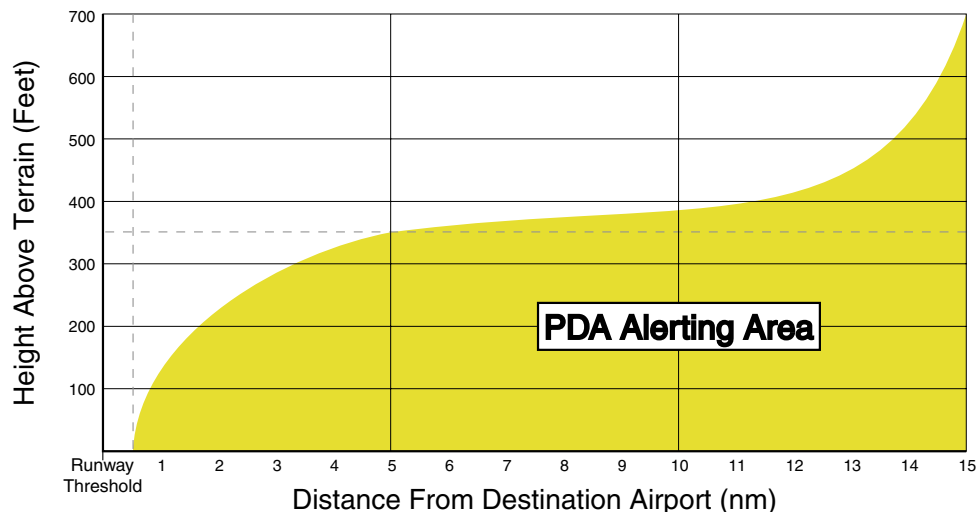

Figure 6-59 PDA Alerting Threshold

PDA and FLTA aural and visual alerts can be manually inhibited. Discretion should be used when inhibiting TAWS and the system should be enable when appropriate. When TAWS is inhibited, the alert annunciation 'TAWS INHB' is shown on the PFD and MFD.

TAWS INHB

Figure 6-60 TAWS Alerting Disabled  
(TAWS Inhibited) Annunciation

### Inhibiting/enabling TAWS alerting:

- 1) Select the TAWS Page.
- 2) Press the **MENU** Key.
- 3) Select 'Inhibit TAWS' or 'Enable TAWS' (choice dependent on current state) and press the **ENT** Key.

If TAWS alerts are inhibited when the Final Approach Fix is the active waypoint in a GPS WAAS approach, a 'LOW ALT' annunciation may appear on the PFD next to the Altimeter if the current aircraft altitude is at least 164 feet below the prescribed altitude at the Final Approach Fix. See the Flight Instruments Section for details.

### FIVE-HUNDRED AURAL ALERT

The purpose of the aural alert message **“Five-hundred”** is to provide an advisory alert that the aircraft is 500 feet above terrain. When the aircraft descends within 500 feet of terrain, the aural message “Five-hundred” is generated. There are no display annunciations or pop-up alerts that accompany the aural message.

### NEGATIVE CLIMB RATE AFTER TAKEOFF ALERT (NCR)

The **Negative Climb Rate (NCR) After Takeoff** alert (also referred to as “Altitude Loss After Takeoff”) provides alerts when the system determines the aircraft is losing altitude (closing upon terrain) after takeoff. The aural message “Don’t Sink” is given for NCR alerts, accompanied by an annunciation and a pop-up terrain alert on the display. NCR alerting is only active when departing from an airport and when the following conditions are met:

- Height above the terrain is less than 700 feet
- Distance from the departure airport is 2 nm or less
- Heading change from the departure heading is less than 110 degrees

The figure below shows the NCR alerting parameters as defined by TSO-C151b.

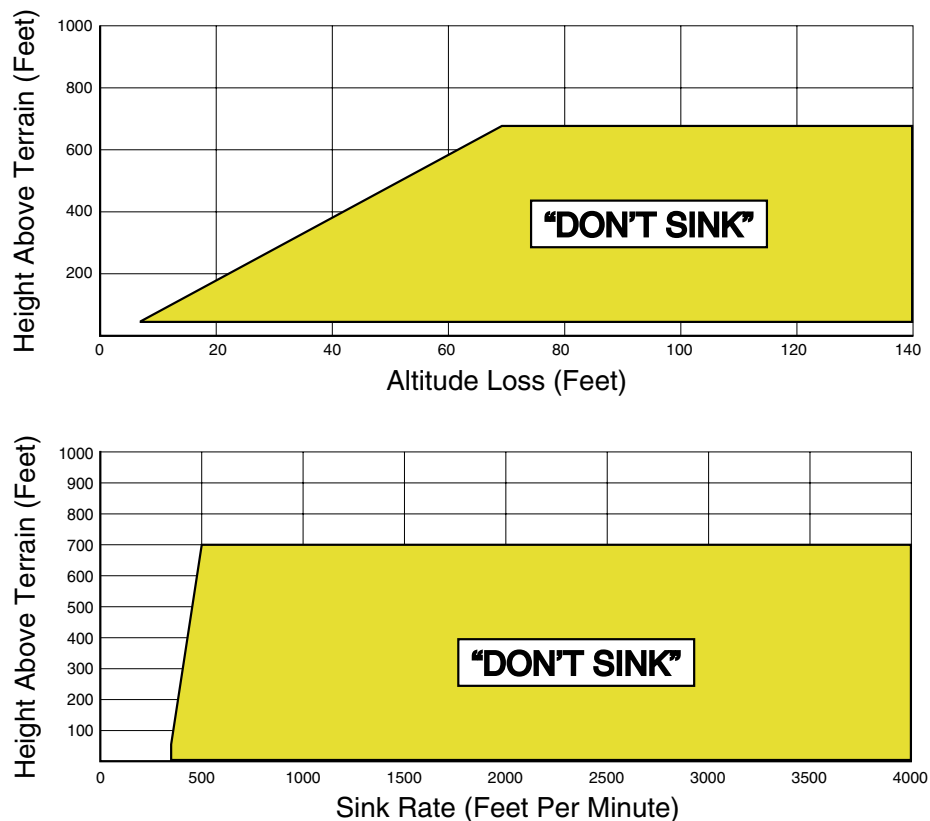

Figure 6-61 Negative Climb Rate (NCR) Alert Criteria

## SYSTEM STATUS

During G1000 power-up, TAWS conducts a self-test of its aural and visual annunciations. The system test can also be manually initiated. An aural alert is issued at test completion. TAWS System Testing is disabled when ground speed exceeds 30 knots.

| Alert Type              | PFD/MFD Alert Annunciation | TAWS Page Annunciation | Aural Message         |
|-------------------------|----------------------------|------------------------|-----------------------|
| System Test in Progress | TAWS TEST                  | TAWS TEST              | None                  |
| System Test Pass        | None                       | None                   | "TAWS System Test OK" |
| TAWS System Test Fail   | TAWS FAIL                  | TAWS FAIL              | "TAWS System Failure" |

Table 6-8 TAWS System Test Status Annunciations

### Manually testing the TAWS System:

- 1) Select the TAWS Page.
- 2) Press the **MENU** Key.
- 3) Select 'Test TAWS' and press the **ENT** Key to confirm the selection.



Figure 6-62 TAWS Page Menu

TAWS continually monitors several system-critical items such as database validity, hardware status, and GPS status. If the terrain/obstacle database is not available, the aural message "**TAWS System Failure**" is generated along with the 'TAWS FAIL' alert annunciation.

TAWS requires a 3-D GPS navigation solution along with specific vertical accuracy minimums. Should the navigation solution become degraded or if the aircraft is out of the database coverage area, the annunciation 'TAWS N/A' is generated in the annunciation window and on the TAWS Page. The aural message "**TAWS Not Available**" is generated. When the GPS signal is re-established and the aircraft is within the database coverage area, the aural message "TAWS Available" is generated.

| Alert Type   | PFD/MFD Alert Annunciation | TAWS Page Annunciation | Aural Message        |
|--|----------------------------|------------------------|----------------------|
| No GPS position<br>Excessively degraded GPS signal | TAWS N/A                   | NO GPS POSITION        | "TAWS Not Available" |
| GPS signal re-established                          | None                       | None                   | "TAWS Available"     |

Table 6-9 TAWS Status Annunciations

## 6.5 TRAFFIC INFORMATION SERVICE (TIS)



**WARNING:** The Traffic Information Service (TIS) is intended for advisory use only. TIS is intended to help the pilot locate traffic visually. It is the responsibility of the pilot to see and maneuver to avoid traffic.



**NOTE:** TIS is available only when the aircraft is within the service volume of a TIS-capable terminal radar site. Aircraft without an operating transponder are invisible to both Traffic Advisory Systems (TAS) and TIS. Aircraft without altitude reporting capability are shown without altitude separation data or climb descent indication.



**NOTE:** TIS is disabled if a Traffic Advisory System (TAS) is installed.

Traffic Information Service (TIS) is designed to help in detection and avoidance of other aircraft. TIS uses the Mode S transponder for the traffic data link. TIS receives traffic information from ground stations, and is updated every 5 seconds. The G1000 displays up to eight traffic targets within a 7.5-nm radius, from 3000 feet below to 3500 feet above the requesting aircraft. Traffic is displayed according to TCAS symbology using four different symbols.





| TIS Symbol  | Description                |
|---|----------------------------|
|   | Non-Threat Traffic         |
|  | Proximity Advisory (PA)    |
|  | Traffic Advisory (TA)      |
|  | Traffic Advisory Off Scale |

Table 6-10 TIS Traffic Symbols

Proximity Advisories (PAs) are defined as traffic within the 5.0-nm range, within  $\pm 1200$  feet of altitude separation. They are not Traffic Advisories (TA), that alert the crew to intruding aircraft. When traffic meets the advisory criteria for the TA, a solid yellow circle symbol is generated. A TA that is detected but is outside the range of the map on which traffic is displayed are indicated with a message in the lower left corner of the map.

TIS also provides a vector line showing the direction in which the traffic is moving, to the nearest 45°. Traffic information for which TIS is unable to determine the bearing (non-bearing traffic) is displayed in the center of the Traffic Map Page or in a banner at the lower left corner of maps other than the Traffic Map Page on which traffic can be displayed.

The altitude difference between the requesting aircraft and other intruder aircraft is displayed above/below the traffic symbol in hundreds of feet. If the other aircraft is above the requesting aircraft, the altitude separation appears above the traffic symbol; if below, the altitude separation appears below. Altitude trend is displayed as an up/down arrow (for speeds greater than 500 fpm in either direction) to the right of the target symbol. Traffic

symbols for aircraft without altitude reporting capability appear without altitude separation or climb/descent information.

## DISPLAYING TRAFFIC DATA

Traffic information can be displayed on the following maps (when TIS is operating):

- PFD Inset Map
- Navigation Map Page
- Traffic Map Page
- VOR Information Page
- Trip Planning Page
- Nearest Pages
- Active Flight Plan Page

### Displaying traffic information (maps other than the Traffic Map Page):

- 1) Press the **MAP** Softkey (for the PFD Inset Map, select the **INSET** Softkey).
- 2) Press the **TRAFFIC** Softkey to display terrain and obstacle data.

When traffic is selected on maps other than the Traffic Map Page, an icon is shown to indicate the feature is enabled for display.



Figure 6-63 TIS Traffic on the Navigation Map Page

The Navigation Map Page Setup Menu provides a means in addition to the softkey for enabling/disabling display of traffic. The setup menu also controls the map range settings above which traffic data (symbols and labels) are decluttered from the display. If a map range larger than the map range setting is selected, the data is removed from the map. Maps besides the Traffic Map Page use settings based on those selected for the Navigation Map Page.

**Customizing traffic display on the Navigation Map Page:**

- 1) Select the Navigation Map Page.
- 2) Press the **MENU** Key.
- 3) With 'Map Setup' highlighted, press the **ENT** Key (Figure 6-64).
- 4) Turn the small **FMS** Knob to select the 'Traffic' Group and press the **ENT** Key (Figure 6-65).
- 5) Turn the large **FMS** Knob or press the **ENT** Key to scroll through product selections (Figure 6-66).
  - TRAFFIC – Turns the display of traffic data on or off
  - TRAFFIC MODE – Selects the traffic mode for display; select from:
    - All Traffic - Displays all traffic
    - TA/PA - Displays Traffic Alerts and Proximity Advisories
    - TA ONLY - Displays Traffic Alerts only
  - TRAFFIC SMBL – Selects the maximum range at which traffic symbols are shown
  - TRAFFIC LBL – Selects the maximum range at which traffic labels are shown (with the option to turn off)
- 6) Turn the small **FMS** Knob to scroll through options for each product (ON/OFF, range settings, etc.).
- 7) Press the **ENT** Key to select an option.
- 8) Press the **FMS** Knob or **CLR** Key to return to the Navigation Map Page with the changed settings.



Figure 6-64 Navigation Map Page Menu



Figure 6-65 Navigation Map Page Setup Menu



Figure 6-66 Navigation Map Page Setup Menu, Traffic Group

## TRAFFIC MAP PAGE

The Traffic Map Page is specialized to show surrounding TIS traffic data in relation to the aircraft's current position and altitude, without clutter from the basemap. Aircraft orientation on this map is always heading up unless there is no valid heading. Map range is adjustable with the **Joystick** from 2 to 12 nm, as indicated by the map range rings.

The traffic mode is annunciated in the upper left corner of the Traffic Map Page. When the aircraft is on the ground, TIS automatically enters Standby Mode. Once the aircraft is airborne, TIS switches from Standby to Operating Mode and the G1000 begins to display traffic information. Refer to the System Status discussion for more information.

### Displaying traffic on the Traffic Map Page:

- 1) Turn the large **FMS** Knob to select the Map Page Group.
- 2) Turn the small **FMS** Knob to select the second rectangular page icon.
- 3) Confirm TIS is in Operating Mode:

Press the **OPERATE** Softkey to begin displaying traffic.

**OR:**

- a) Press the **MENU** Key.
- b) Select 'Operate Mode' (shown if TIS is in Standby Mode) and press the **ENT** Key.



Figure 6-67 Traffic Map Page



## TIS ALERTS

When the number of TAs on the Traffic Map Page increases from one scan to the next, the following occur:

- A single **“Traffic”** voice alert is generated.
- A ‘TRAFFIC’ Annunciation appears to the top left of the Attitude Indicator on the PFD, flashing for 5 seconds and remaining displayed until no TAs are detected in the area.
- The PFD Inset Map is automatically displayed with traffic.

To reduce the number of nuisance alerts due to proximate aircraft, the **“Traffic”** voice alert is generated only when the number of TAs increases. For example, when the first TA is displayed, a voice and visual annunciation are generated. As long as a single TA remains on the display, no additional voice alerts are generated. If a second TA appears on the display or if the number of TAs initially decreases and then subsequently increases, another voice alert is generated.

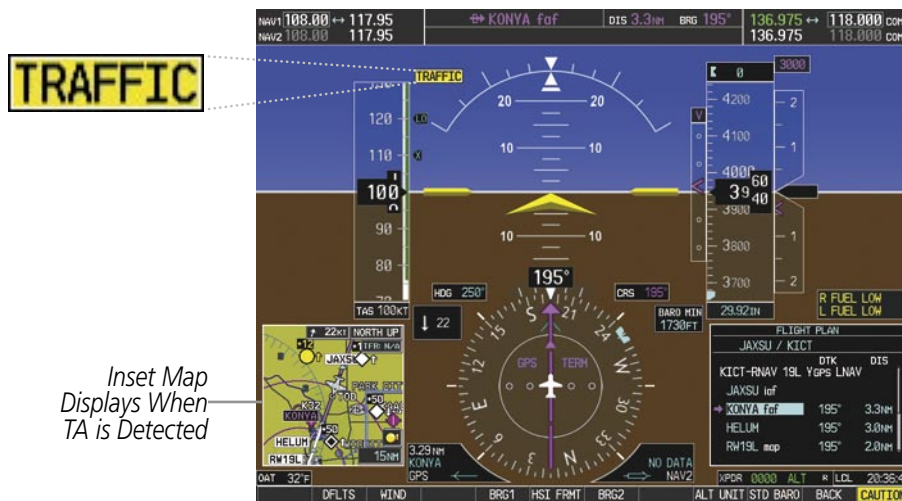

Figure 6-68 Traffic Annunciation (PFD)

A **“Traffic Not Available”** (TNA) voice alert is generated when the TIS service becomes unavailable or is out of range. TIS may be unavailable in the radar coverage area due to the following:

- Radar site TIS Mode S sensor is not operational or is out of service
- Traffic or requesting aircraft is beyond the maximum range of the TIS-capable Mode S radar site.
- Traffic or requesting aircraft is above the radar site in the cone of silence and out of range of an adjacent site.
- Traffic or requesting aircraft is below radar coverage. In flat terrain, the coverage extends from about 3000 feet upward at 55 miles. Terrain and obstacles around the radar site can further decrease radar coverage in all directions.
- Traffic does not have an operating transponder.

The **“Traffic Not Available”** (TNA) voice alert can be manually muted to reduce nuisance alerting. TNA muting status is shown in the upper left corner of the Traffic Map Page.

### Muting the "Traffic Not Available" voice alert:

- 1) Select the Traffic Map Page.
- 2) Press the **TNA MUTE** Softkey. The status is displayed in the upper left corner of the Traffic Map Page.

**OR:**

- a) Press the **MENU** Key.
- b) Select "'Not Available" Mute On' (shown if TNA muting is currently off) and press the **ENT** Key.

## SYSTEM STATUS

The G1000 performs an automatic test of TIS during power-up. If TIS passes the test, TIS enters Standby Mode (on the ground) or Operating Mode (in the air). If TIS fails the power up test, an annunciation is shown in the center of the Traffic Map Page.

| Traffic Map Page Annunciation | Description   |
|-------------------------------|---|
| <b>NO DATA *</b>              | Data is not being received from the transponder   |
| <b>DATA FAILED *</b>          | Data is being received from the transponder, but a failure is detected in the data stream |
| <b>FAILED *</b>               | The transponder has failed  |
| <b>UNAVAILABLE</b>            | TIS is unavailable or out of range  |

\* Contact a service center or Garmin dealer for corrective action

**Table 6-11 TIS Failure Annunciations**



Figure 6-69 TIS Power-up Test Failure

The traffic mode is annunciated in the upper left corner of the Traffic Map Page. When the aircraft is on the ground, TIS automatically enters Standby Mode. If traffic is selected for display on another map while Standby Mode is selected, the traffic display enabled icon is crossed out (also the case when TIS has failed). Once the aircraft is airborne, TIS switches to Operating Mode and traffic information is displayed. The mode can be changed manually using softkeys or the page menu.

| Mode          | Traffic Mode Annunciation (Traffic Map Page)              | Traffic Display Enabled Icon (Other Maps) |
|---------------|---|---|
| TIS Operating | <b>OPERATING</b>  |   |
| TIS Standby   | <b>STANDBY</b><br>(also shown in white in center of page) |   |
| TIS Failed*   | <b>FAIL</b>   |   |

\* See Table 6-11 for additional failure annunciations

Table 6-12 TIS Modes

### Switching between TIS modes:

- 1) Select the Traffic Map Page.
- 2) Press the **STANDBY** or **OPERATE** Softkey to switch between modes. The mode is displayed in the upper left corner of the Traffic Map Page.

**OR:**

- a) Press the **MENU** Key.
- b) Select 'Operate Mode' or 'Standby Mode' (choice dependent on current state) and press the **ENT** Key.

The annunciations to indicate the status of traffic information appear in a banner at the lower left corner of maps on which traffic can be displayed.

| Traffic Status Banner Annunciation | Description   |
|------------------------------------|---|
| <b>TA OFF SCALE*</b>               | A Traffic Advisory is outside the selected display range<br>Annunciation is removed when traffic comes within the selected display range  |
| <b>TA X.X ± XX ↓↑**</b>            | System cannot determine bearing of Traffic Advisory<br>Annunciation indicates distance in nm, altitude separation in hundreds of feet, and altitude trend arrow (climbing/descending)   |
| <b>AGE MM:SS</b>                   | Appears if traffic data is not refreshed within 6 seconds<br>If after another 6 seconds data is not received, traffic is removed from the display<br>The quality of displayed traffic information is reduced as the age increases |
| <b>TRFC COAST</b>                  | The displayed data is not current (12 to 60 seconds since last message)<br>The quality of displayed traffic information is reduced when this message is displayed   |
| <b>TRFC RMVD</b>                   | Traffic is removed because it is too old for coasting (12 to 60 seconds since last message)<br>Traffic may exist within the selected display range, but it is not displayed   |
| <b>TRFC FAIL</b>                   | Traffic data has failed   |
| <b>NO TRFC DATA</b>                | Traffic has not been detected   |
| <b>TRFC UNAVAIL</b>                | The traffic service is unavailable or out of range  |

\*Shown as symbol on Traffic Map Page

\*\*Shown in center of Traffic Map Page





**Table 6-13 TIS Traffic Status Annunciations**

## 6.6 AVIDYNE TAS600 SERIES TRAFFIC ADVISORY SYSTEM (OPTIONAL)



**NOTE:** Errors indicated by a failed screen prevent continued use of the TAS interface. See the applicable Pilot's Guide for detailed information on Failure Response.

The G1000 provides an optional display for Avidyne TAS600 Series Traffic Advisory Systems. See the Avidyne TAS600 Series Pilot's Guide for more information. Traffic is displayed according to TCAS symbology, however track vector information is not displayed. The G1000 uses the symbols given in the table for traffic information from the TAS600 Series.

| Traffic Symbol  | Description                |
|---|----------------------------|
|  | Non-Threat Traffic         |
|  | Proximity Advisory (PA)    |
|  | Traffic Advisory (TA)      |
|  | Traffic Advisory Off Scale |

**Table 6-14 TAS Traffic Symbols**

Proximity Advisories (PAs) are defined as traffic within the 5.0-nm range, within  $\pm 1200$  feet of altitude separation. They are not Traffic Advisories (TA), which alert the crew to intruding aircraft. When traffic meets the advisory criteria for the TA, a solid yellow circle symbol is generated.

Traffic information for which the TAS unit is unable to determine the bearing (non-bearing traffic) is displayed in the center of the Traffic Map Page or in a banner at the lower left corner of maps other than the Traffic Map Page on which traffic can be displayed.

The altitude difference between the requesting aircraft and other intruder aircraft is displayed above/below the traffic symbol in hundreds of feet. If the other aircraft is above the requesting aircraft, the altitude separation appears above the traffic symbol; if below, the altitude separation appears below. Altitude trend is displayed as an up/down arrow (for speeds greater than 500 fpm in either direction) to the right of the target symbol.

## DISPLAYING TRAFFIC DATA

Traffic information can be displayed on the following maps (when the TAS600-series unit is operating):

- PFD Inset Map
- Navigation Map Page
- Traffic Map Page
- VOR Information Page
- Trip Planning Page
- Nearest Pages
- Active Flight Plan Page

### Displaying traffic information (maps other than the Traffic Map Page):

- 1) Press the **MAP** Softkey (for the PFD Inset Map, press the **INSET** Softkey).
- 3) Press the **TRAFFIC** Softkey to display terrain and obstacle data.

When traffic is selected on maps other than the Traffic Map Page, an icon is shown to indicate the feature is enabled for display.



Figure 6-70 TAS Traffic on the Navigation Map Page

The Navigation Map Page Setup Menu provides a means in addition to the softkey for enabling/disabling display of traffic. The setup menu also controls the map range settings above which traffic data (symbols and labels) are decluttered from the display. If a map range larger than the map range setting is selected, the data is removed from the map. Maps besides the Traffic Map Page use settings based on those selected for the Navigation Map Page.

**Customizing traffic display on the Navigation Map Page:**

- 1) Select the Navigation Map Page.
- 2) Press the **MENU** Key.
- 3) With 'Map Setup' highlighted, press the **ENT** Key (Figure 6-71).
- 4) Turn the small **FMS** Knob to select the 'Traffic' Group and press the **ENT** Key (Figure 6-72).
- 5) Turn the large **FMS** Knob or press the **ENT** Key to scroll through product selections (Figure 6-73).
  - TRAFFIC – Turns the display of traffic data on or off
  - TRAFFIC MODE – Selects the traffic mode for display; select from:
    - All Traffic - Displays all traffic
    - TA/PA - Displays Traffic Alerts and Proximity Advisories
    - TA ONLY - Displays Traffic Alerts only
  - TRAFFIC SMBL – Selects the maximum range at which traffic symbols are shown
  - TRAFFIC LBL – Selects the maximum range at which traffic labels are shown (with the option to turn off)
- 6) Turn the small **FMS** Knob to scroll through options for each product (ON/OFF, range settings, etc.).
- 7) Press the **ENT** Key to select an option.
- 8) Press the **FMS** Knob or **CLR** Key to return to the Navigation Map Page with the changed settings.

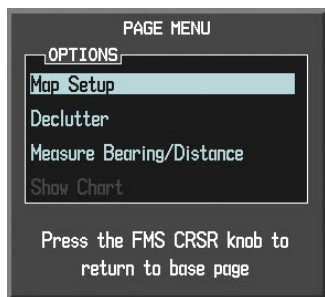

Figure 6-71 Navigation Map Page Menu



Figure 6-72 Navigation Map Page Setup Menu



Figure 6-73 Navigation Map Page Setup Menu, Traffic Group

## TRAFFIC MAP PAGE

**NOTE:** Refer to the TAS600 documentation for information on effective ranges and altitude display modes.

The Traffic Map Page shows surrounding TAS traffic data in relation to the aircraft's current position and altitude, without clutter from the basemap. Aircraft orientation on this map is always heading up unless there is no valid heading. Map range is adjustable with the **Joystick** from 2 to 40 nm, as indicated by the map range rings.

The traffic mode and altitude display mode are announced in the upper left corner of the Traffic Map Page.



Figure 6-74 Traffic Map Page (TAS)



**Displaying traffic on the Traffic Map Page:**

- 1) Turn the large **FMS** Knob to select the Map Page Group.
  - 2) Turn the small **FMS** Knob to select the second rectangular page icon.
  - 3) Confirm that the TAS unit is in Operating Mode:
  - 4) Select an altitude volume to display traffic.
    - a) Press the **ALT MODE** Softkey.
    - b) Select the desired altitude display volume:
      - **BELOW** - Displays only traffic within +2,700 ft to -9,000 ft altitude of requesting aircraft
      - **NORMAL** - Displays only traffic within ± 2,700 ft altitude of requesting aircraft
      - **ABOVE** - Displays only traffic within -2,700 ft to +9,000 ft altitude of requesting aircraft
      - **UNREST** - Displays all detected traffic
- OR:**
- a) Press the **MENU** Key.
  - b) Select the desired altitude display volume and press the **ENT** Key.
    - 'Below' - Displays only traffic within +2,700 ft to -9,000 ft altitude of requesting aircraft
    - 'Normal' - Displays only traffic within ± 2,700 ft altitude of requesting aircraft
    - 'Above' - Displays only traffic within -2,700 ft to +9,000 ft altitude of requesting aircraft
    - 'Unrestricted' - Displays all detected traffic

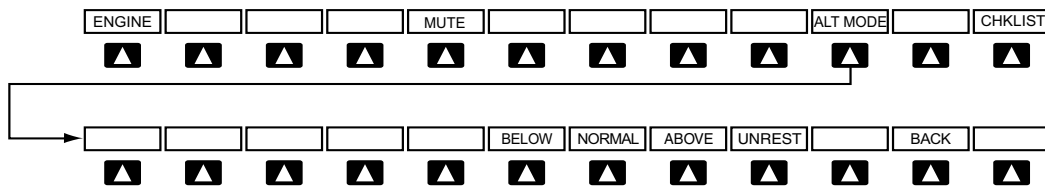



Figure 6-75 Traffic Map Page Softkeys (TAS)

## TAS ALERTS

 **NOTE:** Refer to the TAS600 documentation for information on alerts generated by the TAS equipment.

When the number of TAs on the Traffic Map Page increases from one scan to the next, the following occur:

- A 'TRAFFIC' Annunciation appears to the top left of the Attitude Indicator on the PFD, flashing for 5 seconds and remaining displayed until no TAs are detected in the area.
- The PFD Inset Map is automatically displayed with traffic.

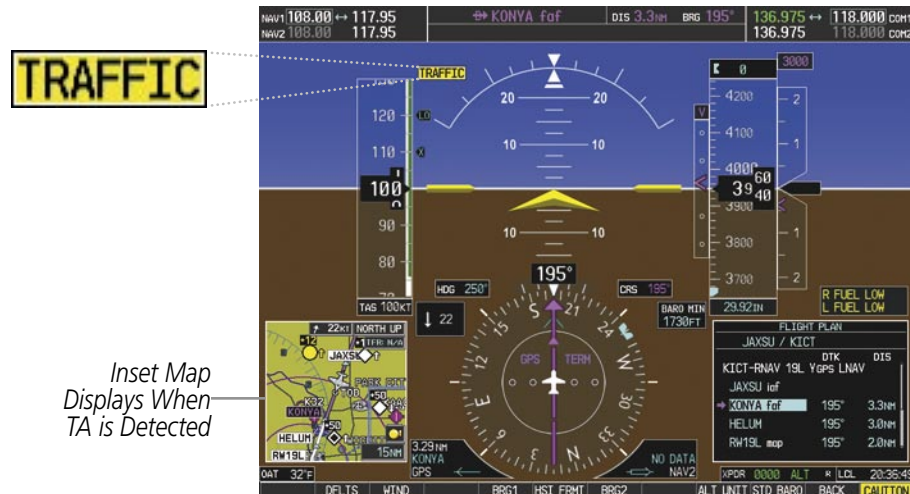

Figure 6-76 Traffic Annunciation (PFD)

Aural traffic alerts generated by the TAS600-series, even those in progress, can be suspended manually. If muting is turned off, the system annunciates all traffic voice alerts which were issued while the system was muted.

### Muting/generating TAS voice alerts:

- 1) Select the Traffic Map Page.
- 2) Press the **MUTE** Softkey.
 

**OR:**

  - a) Press the **MENU** Key.
  - b) Press 'Mute On' (shown if muting is currently off) and press the **ENT** Key.
- 3) Press the **MUTE** Softkey again to turn traffic voice alerting on and annunciate all muted traffic voice alerts issued during system muting.
 





**OR:**

  - a) Press the **MENU** Key.
  - b) Press 'Mute Off' (shown if muting is currently on) and press the **ENT** Key.

**SYSTEM STATUS**

 **NOTE:** Refer to the TAS600 documentation for information on the self-test and operating modes.

The traffic mode is annunciated in the upper left corner of the Traffic Map Page.

| Mode                    | Traffic Mode Annunciation<br>(Traffic Map Page)           | Traffic Display Enabled Icon<br>(Other Maps)  |
|-------------------------|---|---|
| TAS Self-test Initiated | <b>TEST</b>   |  |
| TAS Operating           | <b>OPERATING</b>  |  |
| TAS Standby             | <b>STANDBY</b><br>(also shown in white in center of page) |  |
| TAS Failed*             | <b>FAIL</b>   |  |

\* See Table 6-16 for additional failure annunciations

**Table 6-15 TAS Modes**

If the unit fails, an annunciation as to the cause of the failure is shown in the center of the Traffic Map Page.

| Traffic Map Page<br>Annunciation | Description  |
|----------------------------------|--|
| <b>NO DATA</b>                   | Data is not being received from the TAS unit                                       |
| <b>DATA FAILED</b>               | Data is being received from the TAS unit, but the unit is self-reporting a failure |
| <b>FAILED</b>                    | Incorrect data format received from the TAS unit                                   |

**Table 6-16 TAS Failure Annunciations**

The annunciations to indicate the status of traffic information appear in a banner at the lower left corner of maps on which traffic can be displayed.

| Traffic Status Banner Annunciation | Description  |
|------------------------------------|--|
| <b>TA OFF SCALE*</b>               | A Traffic Advisory is outside the selected display range. Annunciation is removed when traffic comes within the selected display range.  |
| <b>TA X.X ± XX ↑/↓**</b>           | System cannot determine bearing of Traffic Advisory. Annunciation indicates distance in nm, altitude separation in hundreds of feet, and altitude trend arrow (climbing/descending). |
| <b>TRFC FAIL</b>                   | TAS unit has failed (unit is self-reporting a failure or sending incorrectly formatted data).  |
| <b>NO TRFC DATA</b>                | Data is not being received from the TAS unit.  |

\*Shown as symbol on Traffic Map Page

\*\*Shown in center of Traffic Map Page

**Table 6-17 TAS Traffic Status Annunciations**

## SECTION 7 AUTOMATIC FLIGHT CONTROL SYSTEM



**NOTE:** The approved Aircraft Flight Manual Supplement (AFMS) always supersedes the information in this Pilot's Guide.



**NOTE:** A failure of the primary (#1) Integrated Avionics Unit (IAU) results in loss of the flight director. Any IAU failure results in loss of the autopilot and manual electric trim.

The GFC 700 is a digital Automatic Flight Control System (AFCS), fully integrated within the G1000 System avionics architecture. The System Overview section provides a block diagram (Figure 1-1) to support this system description. GFC 700 AFCS functionality in Diamond DA40/40F aircraft is distributed across the following Line Replaceable Units (LRUs):

- GDU 1040 Primary Flight Display (PFD)
- GDU 1044 Multi-Function Display (MFD)
- GIA 63/63W Integrated Avionics Units (2)
- GSA 81 AFCS Servo (3)
- GSM 85 Servo Mounts (3)

The GFC 700 AFCS can be divided into these main operating functions:

- **Flight Director (FD)** — Flight director operation takes place within the primary (#1) IAU. Flight director commands are displayed on the PFD. The flight director provides:
  - Command Bars showing pitch/roll guidance
  - Pitch/roll mode selection and processing
  - Autopilot communication
- **Autopilot (AP)** — Autopilot operation occurs within the pitch, roll, and pitch trim servo and provides servo monitoring and automatic flight control in response to flight director steering commands, AHRS attitude and rate information, and airspeed.
- **Manual Electric Trim (MET)** — The pitch trim servo provides manual electric trim capability when the autopilot is not engaged.

## 7.1 AFCS CONTROLS

The following dedicated AFCS keys are located on the bezels of the PFD and MFD:

- ① **AP Key** Engages/disengages the autopilot
- ② **FD Key** Activates/deactivates the flight director only  
Pressing once turns on the flight director in the default pitch and roll modes. Pressing again deactivates the flight director and removes the Command Bars. If the autopilot is engaged, the key is disabled.
- ③ **NAV Key** Selects/deselects Navigation Mode
- ④ **ALT Key** Selects/deselects Altitude Hold Mode
- ⑤ **VS Key** Selects/deselects Vertical Speed Mode
- ⑥ **FLC Key** Selects/deselects Flight Level Change Mode
- ⑦ **HDG Key** Selects/deselects Heading Select Mode
- ⑧ **APR Key** Selects/deselects Approach Mode
- ⑨ **VNV Key** Selects/deselects Vertical Path Tracking Mode for Vertical Navigation flight control
- ⑩ **NOSE UP/NOSE DN Keys** Control the mode reference in Pitch Hold, Vertical Speed, and Flight Level Change modes

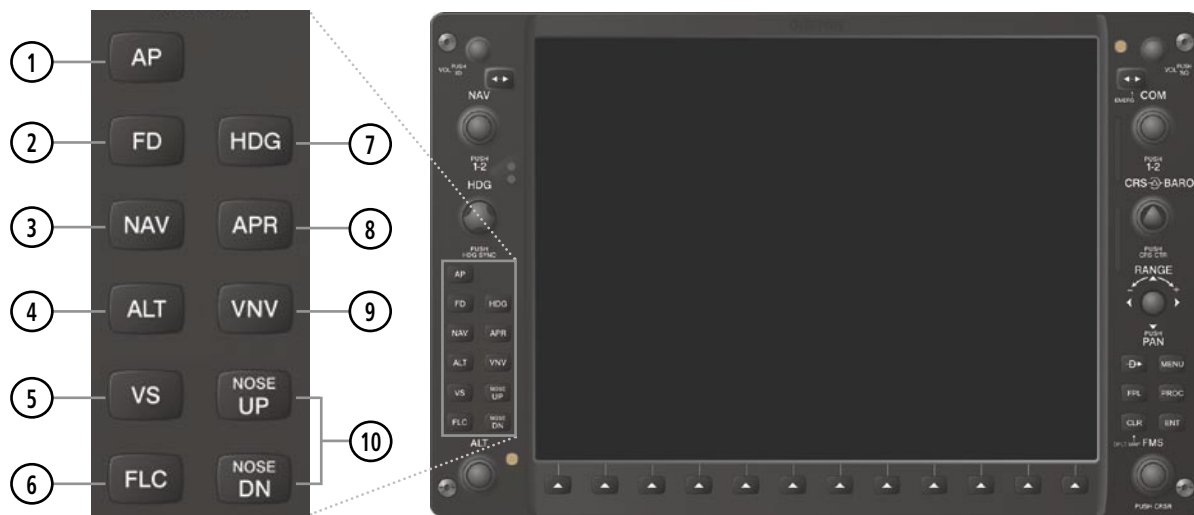

Figure 7-1 Dedicated MFD AFCS Controls

The following AFCS controls are located in the cockpit separately from the MFD:

- AP DISC Switch (Autopilot Disconnect)** Disengages the autopilot and flight director; interrupts pitch trim operation  
 This switch may be used to acknowledge an autopilot disconnect and mute the associated aural tone.  
 A red **AP DISC** Switch is located on each control stick.
- CWS Button (Control Wheel Steering)** While pressed, allows manual control of the aircraft while the autopilot is engaged and synchronizes the flight director's Command Bars with the current aircraft pitch (if not in a Vertical Navigation, Glideslope, or Glidepath Mode) and roll (if in Roll Hold Mode)  
 Upon release of the **CWS** Button, the flight director may establish new reference points, depending on the current pitch and roll modes. CWS operation details are discussed in the flight director modes section.  
 The **CWS** Button is located on the top of the left control stick.
- GA Switch (Go Around)** Disengages the autopilot and selects flight director Go Around Mode  
 This switch also activates the missed approach when the selected navigation source is GPS or when the navigation source is VOR/LOC and a valid frequency has been tuned.  
 The **GA** Switch is located on the left side of the throttle handle.
- AP TRIM Switch (Autopilot Trim)** Used to command manual electric trim  
 This composite switch is split into left and right sides. The left switch is the ARM contact and the right switch controls the DN (forward) and UP (rearward) contacts. The **AP TRIM** ARM switch can be used to disengage the autopilot and to acknowledge an autopilot disconnect alert and mute the associated aural tone.  
 Manual trim commands are generated only when both sides of the switch are operated simultaneously. If either side of the switch is active separately for more than three seconds, MET function is disabled and 'PTRM' (Pitch Trim Failure) is displayed as the AFCS Status Annunciation on the PFD. The function remains disabled until both sides of the switch are inactivated.  
 The **AP TRIM** Switch is located on the left control stick.

## 7.2 FLIGHT DIRECTOR OPERATION

The flight director function provides pitch and roll commands to the AFCS and displays them on the PFD. With the flight director activated, the aircraft can be hand-flown to follow the path shown by the Command Bars. Maximum commanded pitch (+20°/-15°) and bank (22°) angles, vertical acceleration, and roll rate are limited to values established during AFCS certification. The flight director also provides commands to the autopilot.

### ACTIVATING THE FLIGHT DIRECTOR

Pressing the **FD** or **AP** Key (when the flight director is not active) activates the flight director in default pitch/roll modes. Pushing the **GA** Switch or any flight director mode key activates the flight director in the respective mode(s). The flight director may be turned off by pressing the **FD** Key. The **FD** Key is disabled when the autopilot is engaged.

Flight director mode annunciations are displayed on the PFD when the flight director is active. Flight director roll modes are shown on the left and pitch on the right. Armed modes are annunciated in white and active in green. Autopilot status is displayed in the center of the AFCS Status Box.

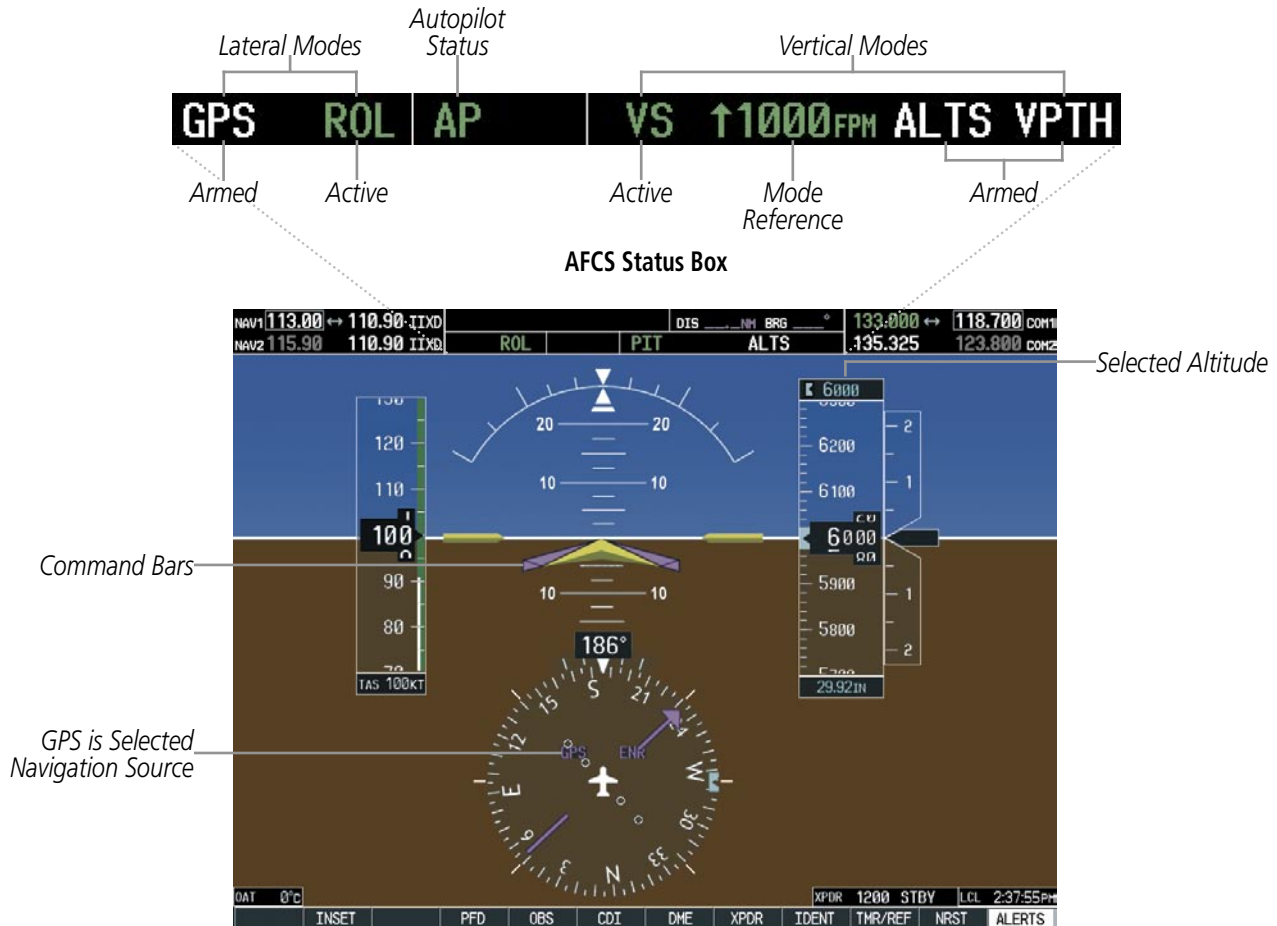

Figure 7-2 PFD AFCS Display



**COMMAND BARS**

Upon activation of the flight director, Command Bars are displayed on the PFD as a single magenta cue. The Command Bars move together vertically to indicate pitch commands and bank left or right to indicate roll commands. The Command Bars do not override the aircraft symbol.

If the attitude information sent to the flight director becomes invalid or unavailable, the Command Bars are removed from the display. The flight director Command Bars also disappear if the pitch exceeds +30°/-20° or bank exceeds 65°.

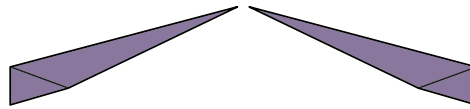

**Figure 7-3 Command Bars**

**FLIGHT DIRECTOR MODES**

Flight director modes are normally selected independently for the pitch and roll axes. Unless otherwise specified, all mode keys are alternate action (i.e., press on, press off). In the absence of specific mode selection, the flight director reverts to the default pitch and/or roll mode(s).

Armed modes are annunciated in white and active in green in the AFCS Status Box. Under normal operation, when the control for the active flight director mode is pressed, the flight director reverts to the default mode(s) for the axis(es). Automatic transition from armed to active mode is indicated by the white armed mode annunciation moving to the green active mode field and flashing for 10 seconds.

If the information required to compute a flight director mode becomes invalid or unavailable, the flight director automatically reverts to the default mode for that axis. A flashing yellow mode annunciation and annunciator light indicate loss of sensor (AHRS, ADC, IAU) or navigation data (VOR, LOC, GPS, VNV, WAAS) required to compute commands. When such a loss occurs, the system automatically begins to roll the wings level (enters Roll Hold Mode) or maintain the pitch angle (enters Pitch Hold Mode), depending on the affected axis. The flashing annunciation stops when the affected mode key is pressed or another mode for the axis is selected. If after 10 seconds no action is taken, the flashing annunciation stops.



**Figure 7-4 Loss of VOR Signal**

The flight director is automatically disabled if the attitude information required to compute the default flight director modes becomes invalid or unavailable.

### 7.3 PITCH MODES

Table 7-1 lists the pitch modes with their corresponding controls and annunciations. The mode reference is displayed next to the active mode annunciation for Altitude Hold, Vertical Speed, and Flight Level Change modes. The **NOSE UP/NOSE DN** keys can be used to change the pitch mode reference while operating under Pitch Hold, Vertical Speed, or Flight Level Change Mode. Increments of change and acceptable ranges of values for each of these references using the **NOSE UP/NOSE DN** keys are also listed in the table.

| Pitch Mode                  | Description  | Control          | Annunciation   | Reference Range    | Reference Change Increment |
|-----------------------------|--|------------------|----------------|--------------------|----------------------------|
| Pitch Hold                  | Holds aircraft pitch attitude; may be used to climb/descend to the Selected Altitude   | (default)        | PIT            | -15° to +20°       | 0.5°                       |
| Selected Altitude Capture   | Captures the Selected Altitude   | *                | ALTS           |                    |                            |
| Altitude Hold               | Holds current Altitude Reference   | <b>ALT</b> Key   | ALT   nnnnn FT |                    |                            |
| Vertical Speed              | Holds aircraft vertical speed; may be used to climb/descend to the Selected Altitude   | <b>VS</b> Key    | VS   nnnn FPM  | -3000 to +1500 fpm | 100 fpm                    |
| Flight Level Change         | Holds aircraft airspeed while aircraft is climbing/descending to the Selected Altitude | <b>FLC</b> Key   | FLC   nnn KT   | 70 to 165 kt       | 1 kt                       |
| Vertical Path Tracking      | Captures and tracks descent legs of an active vertical profile                         | <b>VNV</b> Key   | VPTH           |                    |                            |
| VNV Target Altitude Capture | Captures the Vertical Navigation (VNV) Target Altitude                                 | **               | ALTV           |                    |                            |
| Glidepath***                | Captures and tracks the WAAS glidepath on approach                                     | <b>APR</b> Key   | GP             |                    |                            |
| Glideslope                  | Captures and tracks the ILS glideslope on approach                                     |                  | GS             |                    |                            |
| Go Around                   | Disengages the autopilot and commands a constant pitch angle and wings level           | <b>GA</b> Switch | GA             | 7°                 |                            |

\* *ALTS is armed automatically when PIT, VS, FLC, or GA is active, and under VPTH when the Selected Altitude is to be captured instead of the VNV Target Altitude.*

\*\* *ALTV is armed automatically under VPTH when the VNV Target Altitude is to be captured instead of the Selected Altitude.*

\*\*\* *GP is available in installations with GIA 63W IAUs when WAAS is available.*

**Table 7-1 Flight Director Pitch Modes**

**PITCH HOLD MODE (PIT)**

When the flight director is activated (the **FD** Key is pressed), Pitch Hold Mode is selected by default. Pitch Hold Mode is indicated as the active pitch mode by the green annunciation ‘PIT’. This mode may be used for climb or descent to the Selected Altitude (shown above the Altimeter), since Selected Altitude Capture Mode is automatically armed when Pitch Hold Mode is activated.

In Pitch Hold Mode, the flight director maintains a constant pitch attitude, the pitch reference. The pitch reference is set to the aircraft pitch attitude at the moment of mode selection. If the aircraft pitch attitude exceeds the flight director pitch command limitations, the flight director commands a pitch angle equal to the nose-up/down limit.

**CHANGING THE PITCH REFERENCE**

When operating in Pitch Hold Mode, the pitch reference can be adjusted by:

- Using the **NOSE UP/NOSE DN** keys
- Pressing the **CWS** Button, hand-flying the aircraft to establish a new pitch reference, then releasing the **CWS** Button

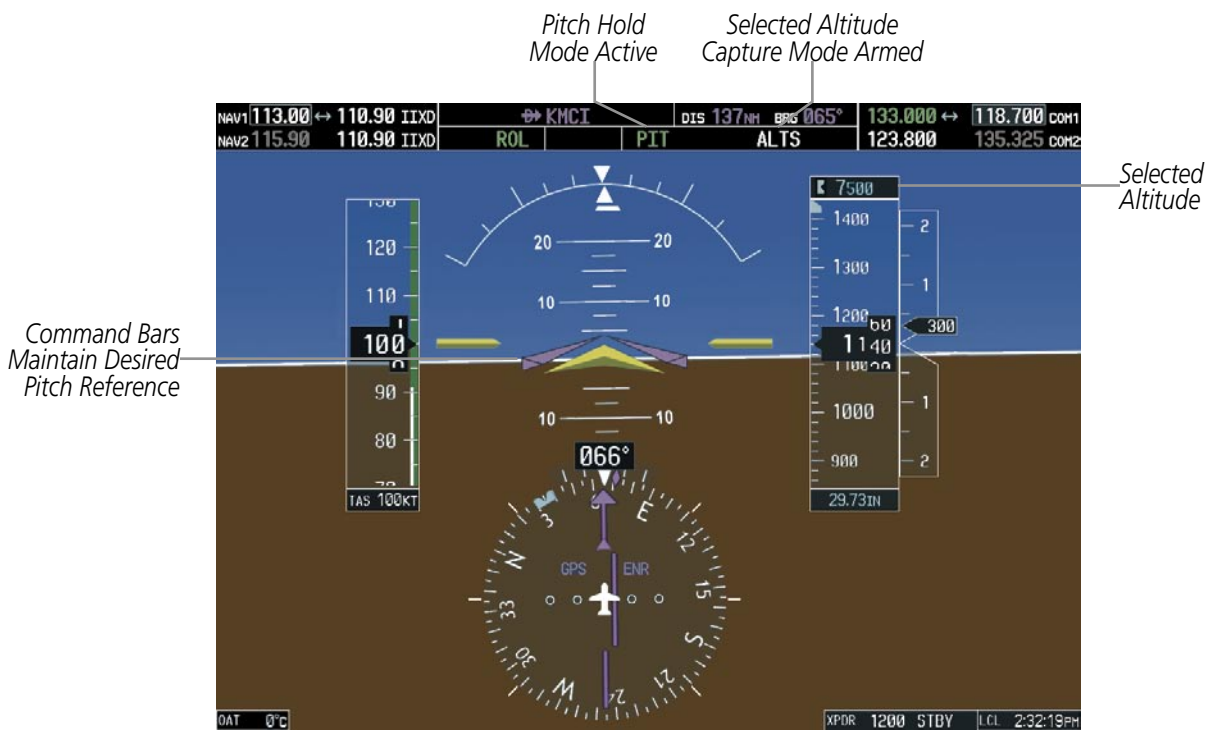

Figure 7-5 Pitch Hold Mode

## SELECTED ALTITUDE CAPTURE MODE (ALTS)

Selected Altitude Capture Mode is automatically armed with activation of the following modes:

- Pitch Hold
- Vertical Speed
- Flight Level Change
- Go Around
- Vertical Path Tracking (if the Selected Altitude is to be captured instead of the VNV Target Altitude)

The white 'ALTS' annunciation indicates Selected Altitude Capture Mode is armed (see Figure 7-5 for example). The **ALT** Knob is used to set the Selected Altitude (shown above the Altimeter) until Selected Altitude Capture Mode becomes active.

As the aircraft nears the Selected Altitude, the flight director automatically transitions to Selected Altitude Capture Mode with Altitude Hold Mode armed (Figure 7-6). This automatic transition is indicated by the green 'ALTS' annunciation flashing for up to 10 seconds and the appearance of the white 'ALT' annunciation. The Selected Altitude is shown as the Altitude Reference beside the 'ALTS' annunciation.

At 50 feet from the Selected Altitude, the flight director automatically transitions from Selected Altitude Capture to Altitude Hold Mode and holds the Selected Altitude (shown as the Altitude Reference). As Altitude Hold Mode becomes active, the white 'ALT' annunciation moves to the active pitch mode field and flashes green for 10 seconds to indicate the automatic transition.

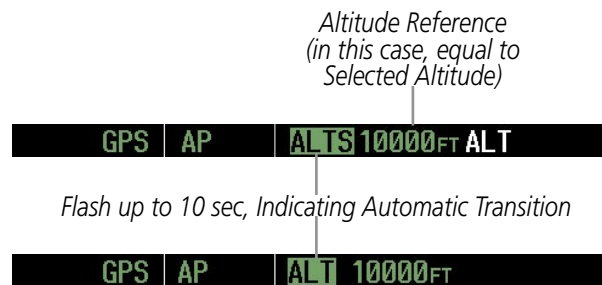

Figure 7-6 Automatic Mode Transitions During Altitude Capture

## CHANGING THE SELECTED ALTITUDE



**NOTE:** Pressing the **CWS** Button while in Selected Altitude Capture Mode does not cancel the mode.

Use of the **ALT** Knob to change the Selected Altitude while Selected Altitude Capture Mode is active causes the flight director to revert to Pitch Hold Mode with Selected Altitude Capture Mode armed for the new Selected Altitude.

**ALTITUDE HOLD MODE (ALT)**

Altitude Hold Mode can be activated by pressing the **ALT** Key; the flight director maintains the current aircraft altitude (to the nearest 10 feet) as the Altitude Reference. The flight director's Altitude Reference, shown in the AFCS Status Box, is independent of the Selected Altitude, displayed above the Altimeter. Altitude Hold Mode active is indicated by a green 'ALT' annunciation in the AFCS Status Box.

Altitude Hold Mode is automatically armed when the flight director is in Selected Altitude Capture Mode (see Figure 7-6). Selected Altitude Capture Mode automatically transitions to Altitude Hold Mode when the altitude error is less than 50 feet. In this case, the Selected Altitude becomes the flight director's Altitude Reference.

**CHANGING THE ALTITUDE REFERENCE**



**NOTE:** Turning the **ALT** Knob while in Altitude Hold Mode changes the Selected Altitude, but not the flight director's Altitude Reference, and does not cancel the mode.

With the **CWS** Button depressed, the aircraft can be hand-flown to a new Altitude Reference. When the **CWS** Button is released at the desired altitude, the new altitude is established as the Altitude Reference.

If the Selected Altitude is reached during CWS maneuvering, the Altitude Reference is not changed. To adjust the Altitude Reference in this case, the **CWS** Button must be pressed again after the Selected Altitude is reached.



Figure 7-7 Altitude Hold Mode

## **VERTICAL SPEED MODE (VS)**

In Vertical Speed Mode, the flight director acquires and maintains a Vertical Speed Reference. Current aircraft vertical speed (to the nearest 100 fpm) becomes the Vertical Speed Reference at the moment of Vertical Speed Mode activation. This mode may be used for climb or descent to the Selected Altitude (shown above the Altimeter) since Selected Altitude Capture Mode is automatically armed when Vertical Speed Mode is selected.

When Vertical Speed Mode is activated by pressing the **VS** Key, 'VS' is annunciated in green in the AFCS Status Box along with the Vertical Speed Reference. The Vertical Speed Reference is also displayed above the Vertical Speed Indicator. A Vertical Speed Reference Bug corresponding to the Vertical Speed Reference is shown on the indicator.

### **CHANGING THE VERTICAL SPEED REFERENCE**

The Vertical Speed Reference (shown both in the AFCS Status Box and above the Vertical Speed Indicator) may be changed by:

- Using the **NOSE UP/NOSE DN** keys
- Pressing the **CWS** Button, hand-flying the aircraft to attain a new Vertical Speed Reference, then releasing the **CWS** Button



**Figure 7-8 Vertical Speed Hold Mode**

**FLIGHT LEVEL CHANGE MODE (FLC)**

**NOTE:** *The Selected Altitude should be set before selecting Flight Level Change Mode.*

Flight Level Change Mode is selected by pressing the **FLC** Key. This mode acquires and maintains the Airspeed Reference while climbing or descending to the Selected Altitude (shown above the Altimeter). When Flight Level Change Mode is active, the flight director continuously monitors Selected Altitude, airspeed, and altitude.

The Airspeed Reference is set to the current airspeed upon mode activation. Flight Level Change Mode is indicated by a green 'FLC' annunciation beside the Airspeed Reference in the AFCS Status Box. The Airspeed Reference is also displayed directly above the Airspeed Indicator, along with a bug corresponding to the Airspeed Reference along the tape.

Engine power must be adjusted to allow the autopilot to fly the aircraft at a pitch attitude corresponding to the desired flight profile (climb or descent) while maintaining the Airspeed Reference. The flight director maintains the current altitude until either engine power or the Airspeed Reference are adjusted and does not allow the aircraft to climb or descend away from the Selected Altitude.

**CHANGING THE AIRSPEED REFERENCE**

The Airspeed Reference (shown in both the AFCS Status Box and above the Airspeed Indicator) may be adjusted by:

- Using the **NOSE UP/NOSE DN** keys
- Pressing the **CWS** Button, hand-flying the aircraft to a new airspeed, then releasing the **CWS** Button to establish the new Airspeed Reference



Figure 7-9 Flight Level Change Mode (IAS)

## **VERTICAL NAVIGATION MODES (VPTH, ALTV)**

**NOTE:** VNV is disabled when parallel track is active.

**NOTE:** The Selected Altitude takes precedence over any other vertical constraints.

Vertical Navigation (VNV) flight control is available for enroute/terminal cruise and descent operations any time that VNV flight planning is available. Refer to the GPS Navigation Section for more information on VNV flight plans. Conditions for availability include, but are not limited to:

- The selected navigation source is GPS.
- A VNV flight plan (with at least one altitude-constrained waypoint) or vertical direct-to is active.
- VNV is enabled (**VNV ENBL** Softkey pressed on the MFD).
- Crosstrack error is valid and within certain limits.
- Desired/actual track are valid or track angle error is within certain limits.
- The VNV Target Altitude of the active waypoint is no more than 250 ft above the current aircraft altitude.

The flight director may be armed for VNV at any time, but no target altitudes are captured during a climb. The Command Bars provide vertical profile guidance based on specified altitudes (entered manually or loaded from the database) at waypoints in the active flight plan or vertical direct-to. The appropriate VNV flight control modes are sequenced by the flight director to follow the path defined by the vertical profile. Upon reaching the last waypoint in the VNV flight plan, the flight director transitions to Altitude Hold Mode and cancels any armed VNV modes.

## **VERTICAL PATH TRACKING MODE (VPTH)**

**NOTE:** If another pitch mode key is pressed while Vertical Path Tracking Mode is selected, Vertical Path Tracking Mode reverts to armed.

**NOTE:** Pressing the **CWS** Button while Vertical Path Tracking Mode is active does not cancel the mode. The autopilot guides the aircraft back to the descent path upon release of the **CWS** Button.

When a vertical profile (VNV flight plan) is active and the **VNV** Key is pressed, Vertical Path Tracking Mode is armed in preparation for descent path capture. 'VPTH' (or 'V' when Glidepath or Glideslope Mode is concurrently armed) is annunciated in white in addition to previously armed modes. If applicable, the appropriate altitude capture mode is armed for capture of the next VNV Target Altitude (ALTV) or the Selected Altitude (ALTS), whichever is greater.



**Figure 7-10 Vertical Path Tracking Armed Annunciations**



Prior to descent path interception, the Selected Altitude must be set below the current aircraft altitude by at least 75 feet. For the flight director to transition from Altitude Hold to Vertical Path Tracking Mode, acknowledgment is required within 5 minutes of descent path interception by:

- Pressing the **VNV** Key
- Adjusting the Selected Altitude

If acknowledgment is not received within 1 minute of descent path interception, the white 'VPTH' annunciation starts to flash. Flashing continues until acknowledged or the descent path is intercepted. If the descent is not confirmed by the time of interception, Vertical Path Tracking Mode remains armed and the descent is not captured.

In conjunction with the "TOD [top of descent] within 1 minute" annunciation in the Navigation Status Box and the "Vertical track" voice message, VNV indications (VNV Target Altitude, vertical deviation, and vertical speed required) appear on the PFD in magenta (Figure 7-11).

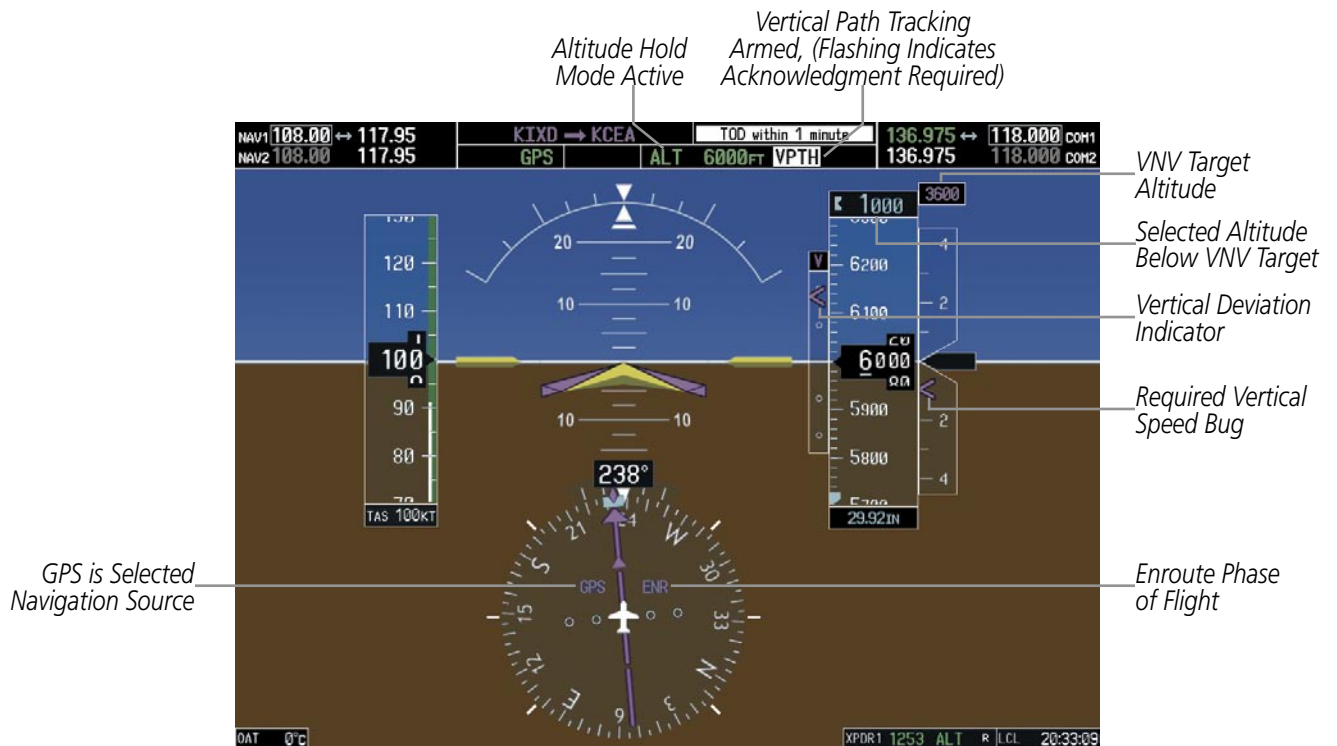

**Figure 7-11 Vertical Path Capture**

When a descent leg is captured (i.e., vertical deviation becomes valid), Vertical Path Tracking becomes active and tracks the descent profile (Figure 7-12). An altitude capture mode ('ALTS' or 'ALTV') is armed as appropriate.



**Figure 7-12 Vertical Path Tracking Mode**

If the Altimeter's barometric setting is adjusted while Vertical Path Tracking is active, the flight director increases/decreases the descent rate by up to 500 fpm to re-establish the aircraft on the descent path (without commanding a climb). Adjusting the altimeter barometric setting creates discontinuities in VNV vertical deviation, moving the descent path. For large adjustments, it may take several minutes for the aircraft to re-establish on the descent path. If the change is made while nearing a waypoint with a VNV Target Altitude, the aircraft may not re-establish on the descent path in time to meet the vertical constraint.

**AUTOMATIC REVERSION TO PITCH HOLD MODE**

Several situations can occur while Vertical Path Tracking Mode is active which cause the flight director to revert to Pitch Hold Mode:

- Vertical deviation exceeds 200 feet during an overspeed condition.
- Vertical deviation experiences a discontinuity that both exceeds 200 feet in magnitude and results in the vertical deviation exceeding 200 feet in magnitude. Such discontinuities are usually caused by flight plan changes that affect the vertical profile.
- Vertical deviation becomes invalid (the Vertical Deviation Indicator is removed from the PFD).
- A display enters Reversionary Mode (this does not apply to an active vertical direct-to).

Unless VNV is disabled, Vertical Path Tracking Mode and the appropriate altitude capture mode become armed following the reversion to Pitch Hold Mode to allow for possible profile recapture.

**NON-PATH DESCENTS**

Pitch Hold, Vertical Speed, and Flight Level Change modes can also be used to fly non-path descents while VNV flight control is selected. If the **VS** or **FLC** Key is pressed while Vertical Path Tracking Mode is selected, Vertical Path Tracking Mode reverts to armed along with the appropriate altitude capture mode to allow profile re-capture.



**Figure 7-13 Flight Level Change VNV Non-Path Descent**

To prevent immediate profile re-capture, the following must be satisfied:

- At least 10 seconds have passed since the non-path transition was initiated
- Vertical deviation from the profile has exceeded 250 feet, but is now less than 200 feet

Pressing the **VNV** Key twice re-arms Vertical Path Tracking for immediate profile re-capture.

## VNV TARGET ALTITUDE CAPTURE MODE (ALTV)



**NOTE:** Armed VNV Target Altitude and Selected Altitude capture modes are mutually exclusive. However, Selected Altitude Capture Mode is armed implicitly (not annunciated) whenever VNV Target Altitude Capture Mode is armed.

VNV Target Altitude Capture is analogous to Selected Altitude Capture Mode and is armed automatically after the **VNV** Key is pressed and the next VNV Target Altitude is to be intercepted before the Selected Altitude. The annunciation ‘ALTV’ indicates that the VNV Target Altitude is to be captured. VNV Target Altitudes are shown in the active flight plan or vertical direct-to, and can be entered manually or loaded from a database (see the GPS Navigation Section for details). At the same time as “TOD within 1 minute” is annunciated in the Navigation Status Box, the active VNV Target Altitude is displayed above the Vertical Speed Indicator (see Figure 7-11).

As the aircraft nears the VNV Target Altitude, the flight director automatically transitions to VNV Target Altitude Capture Mode with Altitude Hold Mode armed. This automatic transition is indicated by the green ‘ALTV’ annunciation flashing for up to 10 seconds and the appearance of the white ‘ALT’ annunciation. The VNV Target Altitude is shown as the Altitude Reference beside the ‘ALTV’ annunciation and remains displayed above the Vertical Speed Indicator. The Required Vertical Speed Indication (RSVI) is removed once VNV Target Altitude Capture Mode becomes active.

At 50 feet from the VNV Target Altitude, the flight director automatically transitions from VNV Target Altitude Capture to Altitude Hold Mode and tracks the level leg. As Altitude Hold Mode becomes active, the white ‘ALT’ annunciation moves to the active vertical mode field and flashes green for 10 seconds to indicate the automatic transition. The flight director automatically arms Vertical Path Tracking, allowing upcoming descent legs to be captured and subsequently tracked.

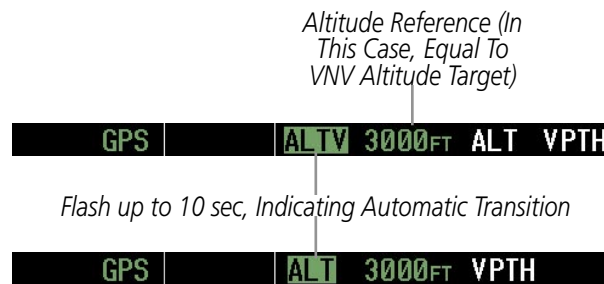

Figure 7-14 Automatic Mode Transitions During Altitude Capture

### CHANGING THE VNV TARGET ALTITUDE



**NOTE:** Pressing the **CWS** Button while in VNV Target Altitude Capture Mode does not cancel the mode.

Changing the current VNV Target Altitude while VNV Target Altitude Capture Mode is active causes the flight director to revert to Pitch Hold Mode. Vertical Path Tracking and the appropriate altitude capture mode are armed in preparation to capture the new VNV Target Altitude or the Selected Altitude, depending on which altitude is to be intercepted first.

VNV target altitudes can be changed while editing the active flight plan (see the GPS Navigation Section for details).

**GLIDEPATH MODE (GP)**

**NOTE:** Pressing the **CWS** Button while *Glidepath Mode* is active does not cancel the mode. The autopilot guides the aircraft back to the glidepath upon release of the **CWS** Button.

Glidepath Mode is available only in installations with GIA 63W IAUs when WAAS is available. Glidepath Mode is used to track the WAAS-based glidepath. When Glidepath Mode is armed, 'GP' is annunciated in white in the AFCS Status Box.

**Selecting Glidepath Mode:**

- 1) Ensure a GPS approach is loaded into the active flight plan. The active waypoint must be part of the flight plan (cannot be a direct-to a waypoint not in the flight plan).
- 2) Ensure that GPS is the selected navigation source (use the **CDI** Softkey to cycle through navigation sources).
- 3) Press the **APR** Key.

Upon reaching the glidepath, the flight director transitions to *Glidepath Mode* and begins to capture and track the glidepath.



**Figure 7-15 Glidepath Mode Armed**

Once the following conditions have been met, the glidepath can be captured:

- The active waypoint is at or after the final approach fix (FAF).
- Vertical deviation is valid.
- The CDI is at less than full scale deviation
- Automatic sequencing of waypoints has not been suspended (no 'SUSP' annunciation on the HSI)



**Figure 7-16 Glidepath Mode**

**GLIDESLOPE MODE (GS)**

**NOTE:** Pressing the **CWS** Button while Glideslope Mode is active does not cancel the mode. The autopilot guides the aircraft back to the glideslope upon release of the **CWS** Button.

Glideslope Mode is available for LOC/ILS approaches to capture and track the glideslope. When Glideslope Mode is armed (annunciated as ‘GS’ in white), LOC Approach Mode is armed as the lateral flight director mode.

**Selecting Glideslope Mode:**

- 1) Ensure a valid localizer frequency is tuned.
- 2) Ensure that LOC is the selected navigation source (use the **CDI** Softkey to cycle through navigation sources).
- 3) Press the **APR** Key.

**OR:**

- 1) Ensure that GPS is the selected navigation source (use the **CDI** Softkey to cycle through navigation sources).
- 2) Ensure a LOC/ILS approach is loaded into the active flight plan.
- 3) Ensure the corresponding LOC frequency is tuned.
- 4) Press the **APR** Key.



**Figure 7-17 Glideslope Mode Armed**

Once LOC is the navigation source, the localizer and glideslope can be captured. Upon reaching the glideslope, the flight director transitions to Glideslope Mode and begins to capture and track the glideslope.



**Figure 7-18 Glideslope Mode**

**GO AROUND (GA) MODE**

Pushing the **GA** Switch engages the flight director in a wings-level, pitch-up attitude, allowing the execution of a missed approach or a go around. This mode is a coupled pitch and roll mode and is annunciated as 'GA' in both the active pitch and roll mode fields. Go Around Mode disengages the autopilot and arms Selected Altitude Capture Mode automatically. Subsequent autopilot engagement is allowed. Attempts to modify the aircraft attitude (i.e., with the **CWS** Button or **NOSE UP/NOSE DN** keys) result in reversion to Pitch and Roll Hold modes.

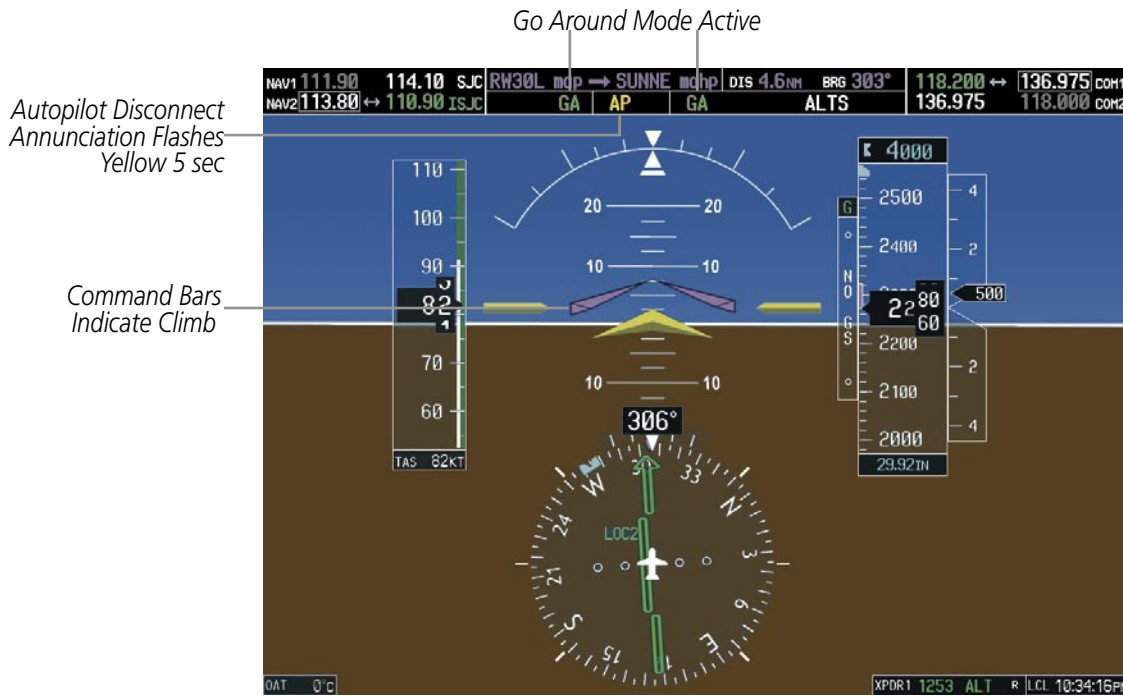

Figure 7-19 Go Around Mode

## 7.4 ROLL MODES

The GFC 700 offers the lateral modes listed in Table 7-3. Refer to the pitch modes section for information regarding Go Around Mode.

| Roll Mode   | Description  | Control          | Annunciation   |
|---|--|------------------|--|
| Roll Hold   | Holds the current aircraft roll attitude or rolls the wings level, depending on the commanded bank angle | (default)        | ROL  |
| Heading Select  | Captures and tracks the Selected Heading   | <b>HDG</b> Key   | HDG  |
| Navigation, GPS Arm/Capture/Track                                     | Captures and tracks the selected navigation source (GPS, VOR, LOC)                                       | <b>NAV</b> Key   | GPS  |
| Navigation, VOR Enroute Arm/Capture/Track                             |  |                  | VOR  |
| Navigation, LOC Arm/Capture/Track (No Glideslope)                     |  |                  | LOC  |
| Navigation, Backcourse Arm/Capture/Track                              |  |                  | Captures and tracks a localizer signal for backcourse approaches |
| Approach, GPS Arm/Capture/Track                                       | Captures and tracks the selected navigation source (GPS, VOR, LOC)                                       | <b>APR</b> Key   | GPS  |
| Approach, VOR Arm/Capture/Track                                       |  |                  | VAPP   |
| Approach, ILS Arm/Capture/Track (Glideslope Mode automatically armed) |  |                  | LOC  |
| Go Around   | Disengages the autopilot and commands a constant pitch angle and wings level                             | <b>GA</b> Switch | GA   |

**Table 7-2 Roll Modes**

The **CWS** Button does not change lateral references for Heading Select, Navigation, Backcourse, or Approach modes. The autopilot guides the aircraft back to the Selected Heading/Course upon release of the **CWS** Button.



**ROLL HOLD MODE (ROL)**



**NOTE:** *If Roll Hold Mode is activated as a result of a mode reversion, the flight director rolls the wings level.*

When the flight director is activated, Roll Hold Mode is selected by default. This mode is annunciated as ‘ROL’ in the AFCS Status Box. The current aircraft bank angle is held, subject to the bank angle conditions listed in Table 7-3.



**Figure 7-20 Roll Hold Mode Annunciation**

| <b>Bank Angle</b> | <b>Flight Director Response</b>          |
|-------------------|--|
| < 6°              | Rolls wings level                        |
| 6 to 22°          | Maintains current aircraft roll attitude |
| > 22°             | Limits bank to 22°                       |

**Table 7-3 Roll Hold Mode Responses**

**CHANGING THE ROLL REFERENCE**

The roll reference can be changed by pressing the **CWS** Button, establishing the desired bank angle, then releasing the **CWS** Button.

## HEADING SELECT MODE (HDG)

Heading Select Mode is activated by pressing the **HDG** Key. Heading Select Mode acquires and maintains the Selected Heading. The Selected Heading is shown by a light blue bug on the HSI and in the box to the upper left of the HSI.

### CHANGING THE SELECTED HEADING



**NOTE:** Pressing the **HDG** Knob synchronizes the Selected Heading to the current heading.

The Selected Heading is adjusted using the **HDG** Knob. Pressing the **CWS** Button and hand-flying the aircraft does not change the Selected Heading. The autopilot guides the aircraft back to the Selected Heading upon release of the **CWS** Button.

Turns are commanded in the same direction as Selected Heading Bug movement, even if the bug is turned more than 180° from the present heading (e.g., a 270° turn to the right). However, Selected Heading changes of more than 340° at a time result in turn reversals.



Figure 7-21 Heading Select Mode

**NAVIGATION MODE (GPS, VOR, LOC, BC)**

 **NOTE:** The selected navigation receiver must have a valid VOR or LOC signal or active GPS course for the flight director to enter Navigation Mode.

 **NOTE:** When intercepting a flight plan leg, the flight director will give commands to capture the active leg at approximately a 45° angle to the track between the waypoints defining the active leg. The flight director will not give commands to fly to the starting waypoint of the active leg.

 **NOTE:** When making a backcourse approach, set the Selected Course to the localizer front course.

Pressing the **NAV** Key selects Navigation Mode. Navigation Mode acquires and tracks the selected navigation source (GPS, VOR, LOC). The flight director follows GPS roll steering commands when GPS is the selected navigation source. When the navigation source is VOR or LOC, the flight director creates roll steering commands from the Selected Course and deviation. Navigation Mode can also be used to fly non-precision GPS and LOC approaches where glideslope capture is not required.

Backcourse Navigation Mode is selected when the localizer front course is greater than 105° from the aircraft heading. The annunciation 'BC' in the AFCS Status Box indicates Backcourse Navigation Mode.

If the Course Deviation Indicator (CDI) shows greater than one dot when the **NAV** Key is pressed, the selected mode is armed. The armed annunciation appears in white to the left of the active roll mode. For cases where the projected course is offset a large distance from the present course for turn anticipation, GPS Navigation Mode can be activated with crosstrack error up to 10 nm.



**Figure 7-22 GPS Navigation Mode Armed**

When the CDI has automatically switched from GPS to LOC during a LOC/ILS approach, GPS Navigation Mode remains active, providing GPS steering guidance until the localizer signal is captured. LOC Navigation Mode is armed automatically when the navigation source switch takes place if the **APR** Key is not pressed prior to the automatic source switch.

If Navigation Mode is active and either of the following occur, the flight director reverts to Roll Hold Mode (wings rolled level):

- Different VOR tuned while in VOR Navigation Mode (VOR Navigation Mode reverts to armed)
- Navigation source manually switched (with the **CDI** Softkey)
- FAF crossed while in GPS Navigation Mode after the automatic navigation source switch from GPS to LOC

### CHANGING THE SELECTED COURSE

The Selected Course is controlled using the **CRS** Knob (while in VOR, LOC, or OBS Mode). Pressing the **CWS** Button and hand-flying the aircraft does not change the Selected Course while in Navigation Mode. The autopilot guides the aircraft back to the Selected Course (or GPS flight plan) when the **CWS** Button is released.



Figure 7-23 Navigation Mode

**APPROACH MODE (GPS, VAPP, LOC)**

 **NOTE:** *The selected navigation receiver must have a valid VOR or LOC signal or active GPS course for the flight director to enter Approach Mode.*

Approach Mode is activated when the **APR** Key is pressed. Approach Mode acquires and tracks the selected navigation source (GPS, VOR, or LOC), depending on loaded approach. This mode uses the selected navigation receiver deviation and desired course inputs to fly the approach. Pressing the **APR** Key when the CDI is greater than one dot arms the selected approach mode (annunciated in white to the left of the active lateral mode).

VOR Approach Mode (VAPP) provides greater sensitivity for signal tracking than VOR Navigation Mode.

**Selecting VOR Approach Mode:**

- 1) Ensure a valid VOR frequency is tuned.
- 2) Ensure that VOR is the selected navigation source (use the **CDI** Softkey to cycle through navigation sources if necessary).
- 3) Press the **APR** Key.

When GPS Approach Mode is armed, Glidepath Mode is also armed. If GPS Approach Mode is selected while in GPS Navigation Mode, capture can occur with crosstrack error of up to 2 nm.

**Selecting GPS Approach Mode:**

- 1) Ensure a GPS approach is loaded into the active flight plan. The active waypoint must be part of the flight plan (cannot be a direct-to a waypoint not in the flight plan).
- 2) Ensure that GPS is the selected navigation source (use the **CDI** Softkey to cycle through navigation sources if necessary).
- 3) Press the **APR** Key.

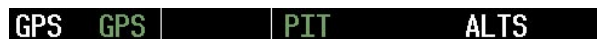

**Figure 7-24 GPS Approach Mode Armed**

LOC Approach Mode allows the autopilot to fly a LOC/ILS approach with a glideslope. When LOC Approach Mode is armed, Glideslope Mode is also armed automatically. LOC captures are inhibited if the difference between aircraft heading and localizer course exceeds 105°.

#### Selecting LOC Approach Mode:

- 1) Ensure a valid localizer frequency is tuned.
- 2) Ensure that LOC is the selected navigation source (use the **CDI** Softkey to cycle through navigation sources if necessary).
- 3) Press the **APR** Key.

#### OR:

- 1) Ensure that GPS is the selected navigation source (use the **CDI** Softkey to cycle through navigation sources if necessary).
- 2) Ensure a LOC/ILS approach is loaded into the active flight plan.
- 3) Ensure the corresponding LOC frequency is tuned.
- 4) Press the **APR** Key.

If the following occurs, the flight director reverts to Roll Hold Mode (wings rolled level):

- Approach Mode is active and a Vectors-To-Final is activated
- Approach Mode is active and Navigation source is manually switched
- GPS Navigation Mode is active and the FAF is crossed after the automatic navigation source switch from GPS to LOC

#### CHANGING THE SELECTED COURSE

The Selected Course is controlled using the **CRS** Knob (while in VOR, LOC, or OBS Mode). Pressing the **CWS** Button and hand-flying the aircraft does not change the Selected Course while in Approach Mode. The autopilot guides the aircraft back to the Selected Course (or GPS flight plan) when the **CWS** Button is released.

## 7.5 AUTOPILOT OPERATION



**NOTE:** Refer to the AFM for specific instructions regarding emergency procedures.

The autopilot operates flight control surface servos to provide automatic flight control. Pitch and roll commands are provided to the servos, based on the active flight director modes. The autopilot uses pitch and roll rates to stabilize the aircraft attitude during upsets and flight director maneuvers. Flight director commands are rate- and attitude-limited, combined with pitch and roll damper control, and sent to the pitch and roll servo motors.

Pitch autotrim provides trim commands to the pitch trim servo to relieve any sustained effort required by the pitch servo. The pitch servo measures the output effort (torque) and provides this signal to the pitch trim servo. The pitch trim servo commands the motor to reduce the average pitch servo effort.

When the autopilot is not engaged, the pitch trim servo may be used to provide manual electric trim (MET). This allows the aircraft to be trimmed using a control wheel switch rather than the trim wheel. Manual trim commands are generated only when both halves of the **AP TRIM** Switch are operated simultaneously. Trim speeds are scheduled with airspeed to provide more consistent response.

Servo motor control limits the maximum servo speed and torque. The servo mounts are equipped with slip-clutches set to certain values. This allows the servos to be overridden in case of an emergency.

### ENGAGING THE AUTOPILOT



**NOTE:** Autopilot engagement/disengagement is not equivalent to servo engagement/disengagement. Use the **CWS** Button to disengage the pitch and roll servos while the autopilot remains active.

When the **AP** Key is pressed, the autopilot and flight director (if not already engaged) are activated. Engagement is indicated by a green 'AP' annunciation in the center of the AFCS Status Box. The flight director engages in Pitch and Roll Hold modes when initially activated.



Figure 7-25 Autopilot and Yaw Damper Engaged

## **CONTROL WHEEL STEERING**

During autopilot operation, the aircraft may be hand-flown without disengaging the autopilot. Pressing and holding the **CWS** Button disengages the pitch and roll servos from the flight control surfaces and allows the aircraft to be hand-flown. At the same time, the flight director is synchronized to the aircraft attitude during the maneuver. The ‘AP’ annunciation is temporarily replaced by ‘CWS’ in white for the duration of CWS maneuvers.

In most scenarios, releasing the **CWS** Button reengages the autopilot with a new reference. Refer to the flight director modes section for specific CWS behavior in each mode.



**Figure 7-26 CWS Annunciation**

## **DISENGAGING THE AUTOPILOT**

The autopilot is manually disengaged by pushing the **AP DISC** Switch, **GA** Switch, **AP TRIM ARM** Switch, or the **AP** Key on the MFD. Manual disengagement is indicated by a five-second flashing yellow ‘AP’ annunciation and a two-second autopilot disconnect aural alert. After manual disengagement, the autopilot disconnect aural alert may be cancelled by pushing the **AP TRIM ARM** or **AP DISC** Switch (**AP DISC** Switch also cancels the flashing ‘AP’ annunciation).

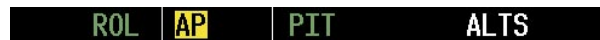

**Figure 7-27 Manual Autopilot Disengagement**

Automatic autopilot disengagement is indicated by a flashing red ‘AP’ annunciation and by the autopilot disconnect aural alert, which continue until acknowledged by pushing the **AP DISC** or **AP TRIM ARM** Switch. Automatic disengagement occurs due to:

- System failure
- Invalid sensor data
- Inability to compute default flight director modes (FD also disengages automatically)
- Stall warning



**Figure 7-28 Automatic Autopilot Disengagement**



## 7.6 EXAMPLE FLIGHT PLAN



**NOTE:** The diagrams in this section are for instructional purposes only and should not be used for navigation. Numbered portions of accompanying diagrams correspond to numbered procedure steps.

This section provides a scenario-based set of procedures showing various GFC 700 AFCS modes used during a flight. In this scenario, the aircraft departs Charles B. Wheeler Downtown Airport (KMKC), enroute to Colorado Springs Airport (KCOS). After departure, the aircraft climbs to 12,000 ft and airway V4 is intercepted, following ATC vectors.

Airway V4 is flown to Salina VOR (SLN) using VOR navigation, then airway V244 is flown using a GPS flight plan. The ILS approach for runway 35L and LPV (WAAS) approach for runway 35R are shown and a missed approach is executed.

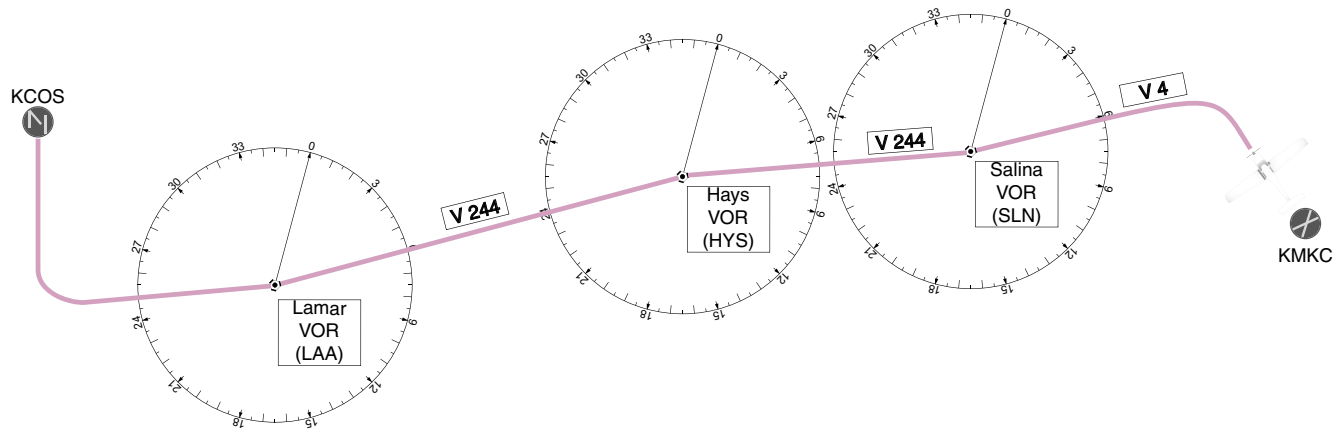

Figure 7-29 Flight Plan Overview

## DEPARTURE

### Climbing to the Selected Altitude and flying an assigned heading:

- 1) Before takeoff, set the Selected Altitude to 12,000 feet using the **ALT** Knob.
- 2) In this example, Vertical Speed Mode is used to capture the Selected Altitude (Pitch Hold, Vertical Speed, or Flight Level Change Mode may be used).
  - a) Adjust the aircraft's vertical speed to the desired 1,000 fpm.
  - b) Press the **VS** Key to activate Vertical Speed and Roll Hold modes and arm Selected Altitude Capture Mode.

**ROL** | **VS ↑1000<sub>FPM</sub>** **ALTS**

The Vertical Speed Reference may be adjusted after Vertical Speed Mode is selected using the **NOSE UP/NOSE DN** keys or pushing the **CWS** Button while hand-flying the aircraft to establish a new Vertical Speed Reference.

- c) Press the **AP** Key to engage the autopilot in a climb using Vertical Speed Mode.

**ROL** | **AP** | **VS ↑1000<sub>FPM</sub>** **ALTS**

- 3) Use the **HDG** Knob to set the Selected Heading, complying with ATC vectors to intercept Airway V4.  
Press the **HDG** Key to activate Heading Select Mode while the autopilot is engaged in the climb. The autopilot follows the Selected Heading Bug on the HSI and turns the aircraft to the desired heading.

**HDG** | **AP** | **VS ↑1000<sub>FPM</sub>** **ALTS**

- 4) As the aircraft nears the Selected Altitude, the flight director transitions to Selected Altitude Capture Mode, indicated by the green 'ALTS' annunciation flashing for up to 10 seconds.

**HDG** | **AP** | **ALTS 12000<sub>FT</sub>** **ALT**

At 50 feet from the Selected Altitude, the green 'ALT' annunciation flashes for up to 10 seconds; the autopilot transitions to Altitude Hold Mode and levels the aircraft.

**HDG** | **AP** | **ALT 12000<sub>FT</sub>**

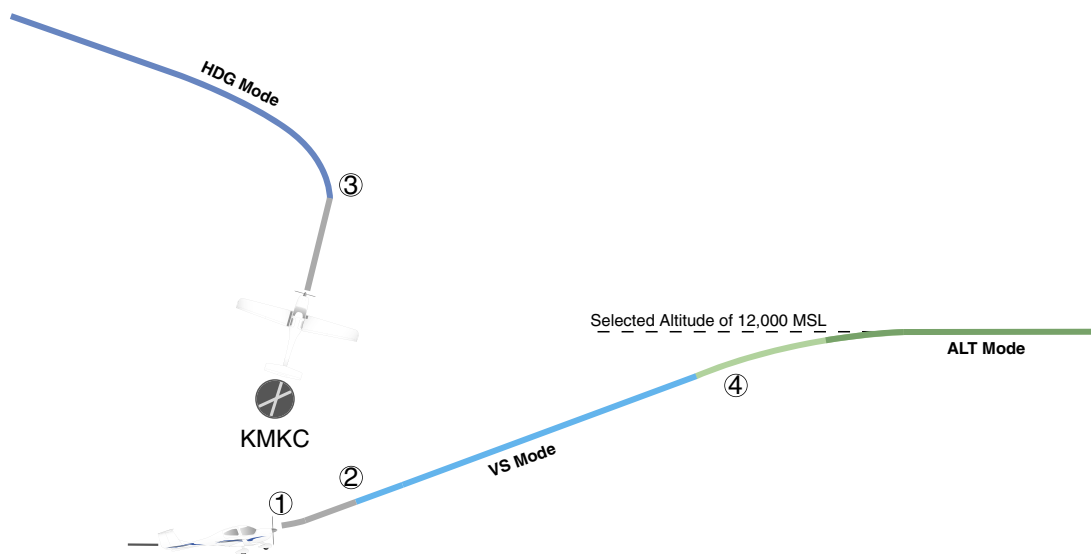

Figure 7-30 Departure

**INTERCEPTING A VOR RADIAL**

During climb-out, the autopilot continues to fly the aircraft in Heading Select Mode. Airway V4 to Salina VOR (SLN) should now be intercepted. Since the enroute flight plan waypoints correspond to VORs, flight director Navigation Mode using either VOR or GPS as the navigation source may be used. In this scenario, VOR Navigation Mode is used for navigation to the first VOR waypoint in the flight plan.

**Intercepting a VOR radial:**

- 1) Arm VOR Navigation Mode:
  - a) Tune the VOR frequency.
  - b) Press the **CDI** Softkey to set the navigation source to VOR.
  - c) Use the **CRS** Knob to set the Selected Course to the desired value, 290°. Note that at this point, the flight director is still in Heading Select Mode and the autopilot continues to fly the Selected Heading, 240°.
  - d) Press the **NAV** Key. This arms VOR Navigation Mode and the white 'VOR' annunciation appears to the left of the active lateral mode.



- 2) As the aircraft nears the Selected Course, the flight director transitions from Heading Select to VOR Navigation Mode and the 'VOR' annunciation flashes green. The autopilot begins turning to intercept the Selected Course.



- 3) The autopilot continues the turn until the aircraft is established on the Selected Course.

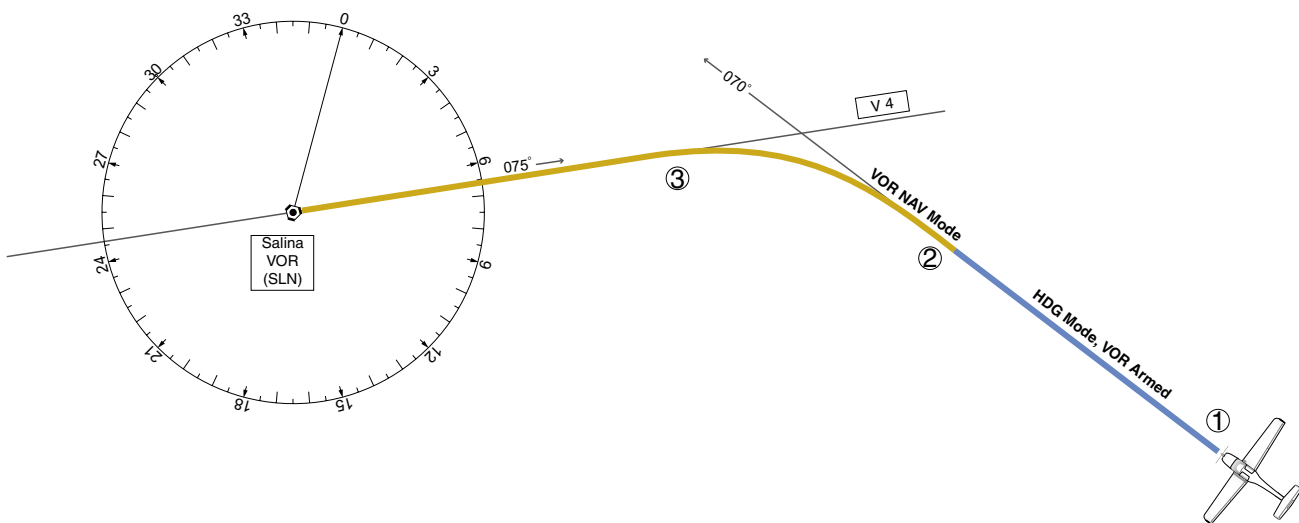

**Figure 7-31 Intercepting a VOR Radial**

**FLYING A FLIGHT PLAN/GPS COURSE**

**NOTE:** Changing the navigation source cancels Navigation Mode and causes the flight director to revert back to Roll Hold Mode (wings rolled level).

As the aircraft closes on Salina VOR, GPS is used to navigate the next leg, airway V244. The aircraft is currently tracking inbound on Airway V4.

**Flying a GPS flight plan:**

- 1) Enter Salina VOR (SLN) into the GPS flight plan.
- 2) Transition from VOR to GPS Navigation Mode:
  - a) Press the **CDI** Softkey until GPS is the selected navigation source. Due to VOR signal loss, VOR Navigation Mode is cancelled. The 'VOR' annunciation flashes yellow.

*Flashes 10 sec, Transitions to Roll Hold Mode Unless NAV Key is Pressed*



- b) Press the **NAV** Key to activate GPS Navigation Mode. The autopilot guides the aircraft along the active flight plan leg.

If the **NAV** Key is not pressed within 10 seconds of VOR signal loss, the flight director reverts to Roll Hold Mode (wings rolled level).



- 3) Following the flight plan, the autopilot continues to steer the aircraft under GPS guidance. Note that in GPS Navigation Mode, course changes defined by the flight plan are automatically made without pilot action required.

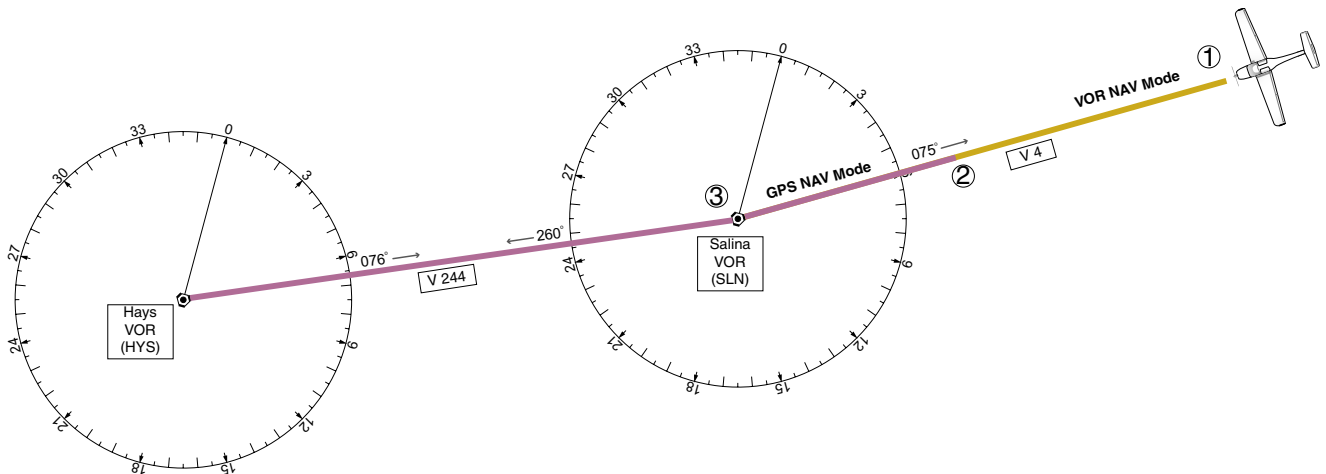

Figure 7-32 Transition to GPS Flight Plan

## DESCENT

While flying the arrival procedure, the aircraft is cleared for descent in preparation for the approach to KCOS. Three methods are presented for descent:

- Flight Level Change descent – Flight Level Change Mode can be used to descend to the Selected Altitude at a constant airspeed. This descent method does not account for flight plan waypoint altitude constraints.
- Vertical Path Tracking descent – Vertical Path Tracking Mode is used to follow the vertical descent path defined in the GPS flight plan. Altitude constraints correspond to waypoints in the flight plan. Before VNV flight control can provide vertical profile guidance, a VNV flight plan must be entered and enabled.
- Non-path descent in a VNV scenario – While the flight director is following VNV guidance for descent, Pitch Hold, Vertical Speed, or Flight Level Change Mode can be used to descend to the VNV Target Altitude prior to reaching the planned TOD. Flight Level Change Mode is used in the example.

### Flight Level Change descent:

#### 1) Select Flight Level Change Mode:

a) Using the **ALT** Knob, set the Selected Altitude to 10,000 feet.

b) Press the **FLC** Key to activate Flight Level Change Mode. The annunciation 'FLC' appears next to the Airspeed Reference, which defaults to the current aircraft airspeed. Selected Altitude Capture Mode is armed automatically.

GPS | AP | FLC 142KT ALTS

2) Use the **NOSE UP/NOSE DN** keys or push the **CWS** Button while hand-flying the aircraft to adjust the commanded airspeed while maintaining the same power, or reduce power to allow descent in Flight Level Change Mode while the autopilot maintains the current airspeed.

3) As the aircraft nears the Selected Altitude, the flight director transitions to Selected Altitude Capture Mode, indicated by the green 'ALTS' annunciation flashing for up to 10 seconds.

GPS | AP | ALTS 10000FT ALT

The green 'ALT' annunciation flashes for up to 10 seconds upon reaching 50 feet from the Selected Altitude; the autopilot transitions to Altitude Hold Mode and levels the aircraft.

GPS | AP | ALT 10000FT

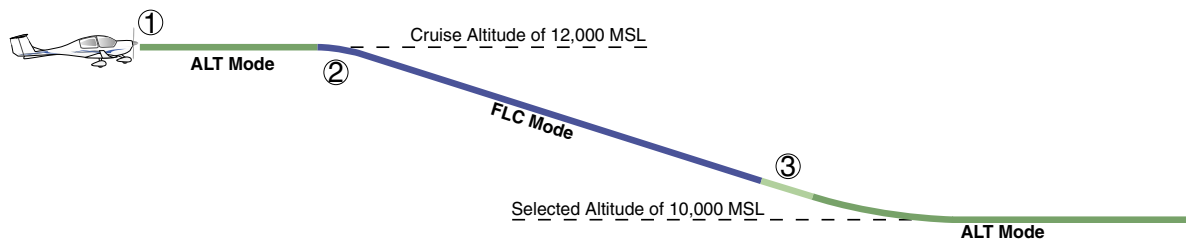

Figure 7-33 FLC Descent

**Vertical Path Tracking descent to VNV Target Altitude:**

- 1) Select VNV flight control:
  - a) Press the **VNV** Key to arm Vertical Path Tracking Mode. The white annunciation 'VPTH' appears.



- b) Using the **ALT** Knob, set the Selected Altitude at least 75 feet below the flight plan's VNV Target Altitude of 10,000 feet.

If the Selected Altitude is not adequately adjusted below the VNV Target Altitude, the flight director will command descent to the Selected Altitude rather than the VNV Target Altitude once Vertical Path Tracking Mode becomes active (ALTS will be armed rather than ALTV).

- c) If Vertical Path Tracking Mode is armed more than 5 minutes prior to descent path capture, acknowledgment is required for the flight director to transition from Altitude Hold to Vertical Path Tracking Mode. To proceed with descent path capture if the white 'VPTH' annunciation begins flashing, do one of the following
        - Press the **VNV** Key
        - Turn the **ALT** Knob to adjust the Selected Altitude

If the descent is not confirmed by the time of interception, Vertical Path Tracking Mode remains armed and the descent is not captured.

- 2) When the top of descent (TOD) is reached, the flight director transitions to Vertical Path Tracking Mode and begins the descent to the VNV Target Altitude. Intention to capture the VNV Target Altitude is indicated by the white 'ALTV' annunciation.



- 3) As the aircraft nears the VNV Target Altitude, the flight director transitions to VNV Target Altitude Capture Mode, indicated by the green 'ALTV' annunciation flashing for up to 10 seconds.



The green 'ALT' annunciation flashes for up to 10 seconds upon reaching 50 feet from the VNV Target Altitude; the autopilot transitions to Altitude Hold Mode and levels the aircraft at the vertical waypoint.

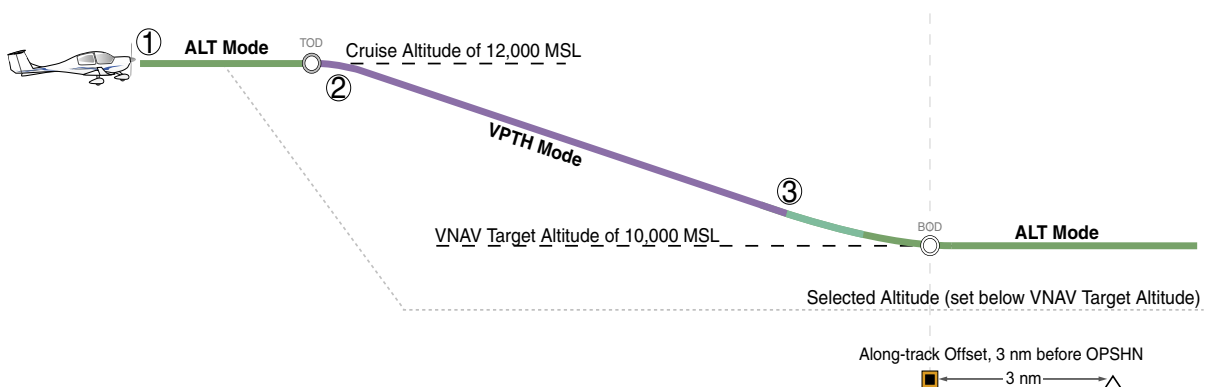

Figure 7-34 VPTH Descent

**Non-path descent using Flight Level Change Mode:**

- 1) Command a non-path descent using Flight Level Change Mode:
  - a) Using the **ALT** Knob, set the Selected Altitude below the current aircraft altitude to an altitude (in this case, 9,400 feet) at which to level off between VNV flight plan altitudes.
  - b) Press the **FLC** Key before the planned TOD during an altitude hold while VPTH is armed. The Airspeed Reference defaults to the current aircraft airspeed. Vertical Path Tracking and Selected Altitude Capture Mode are armed automatically.

**GPS | AP | FLC | 142KT | ALTS | VPTH**

- 2) Reduce power to allow descent in Flight Level Change Mode. The autopilot maintains the Airspeed Reference.
- 3) As the aircraft nears the Selected Altitude, the flight director transitions to Selected Altitude Capture Mode, indicated by the green 'ALTS' annunciation flashing for up to 10 seconds.

**GPS | AP | ALTS | 9400FT | ALT | VPTH**

The green 'ALT' annunciation flashes for up to 10 seconds upon reaching 50 feet from the Selected Altitude; the autopilot transitions to Altitude Hold Mode and levels the aircraft.

**GPS | AP | ALT | 9400FT | VPTH**

- 4) When the next TOD is reached, Vertical Path Tracking becomes active (may require acknowledgment to allow descent path capture).

**GPS | AP | VPTH | ALTV**

- 5) As the aircraft nears the VNV Target Altitude, the flight director transitions to VNV Target Altitude Capture Mode, indicated by the green 'ALTV' annunciation flashing for up to 10 seconds.

**GPS | AP | ALTV | 9000FT | ALT**

The green 'ALT' annunciation flashes for up to 10 seconds upon reaching 50 feet from the VNV Target Altitude; the autopilot transitions to Altitude Hold Mode and levels the aircraft at the vertical waypoint.

**GPS | AP | ALT | 9000FT**



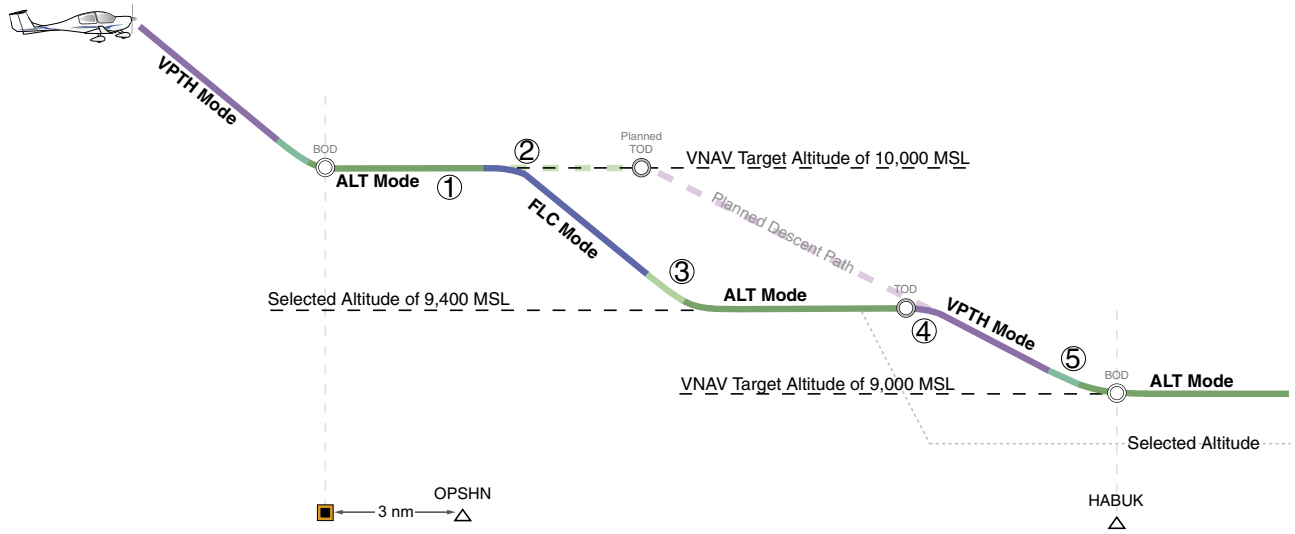

**Figure 7-35 Non-path Descent**

**APPROACH**

**Flying an ILS approach:**

- 1) Transition from GPS Navigation Mode to Heading Select Mode.
  - a) Load the Runway 35L ILS approach for KCOS into the flight plan and select 'VECTORS' for the transition.
  - b) Use the **HDG** Knob to set the Selected Heading after getting vectors from ATC.
  - c) Press the **HDG** Key. The autopilot turns the aircraft to the desired heading.
  - d) Use Heading Select Mode to comply with ATC vectors as requested.



- 2) Arm LOC Approach and Glideslope modes.
  - a) Ensure the appropriate localizer frequency is tuned.
  - b) Press the **APR** Key when cleared for approach to arm Approach and Glideslope modes. 'LOC' and 'GS' appear in white as armed mode annunciations.



- c) The navigation source automatically switches to LOC. After this switch occurs, the localizer signal can be captured and the autopilot and flight director determine when to begin the turn to intercept the final approach course.
- 3) There are two options available at this point, as the autopilot flies the ILS approach:
  - Push the **AP DISC** Switch at the decision height and land the aircraft.
  - Use the **GA** Switch to execute a missed approach.

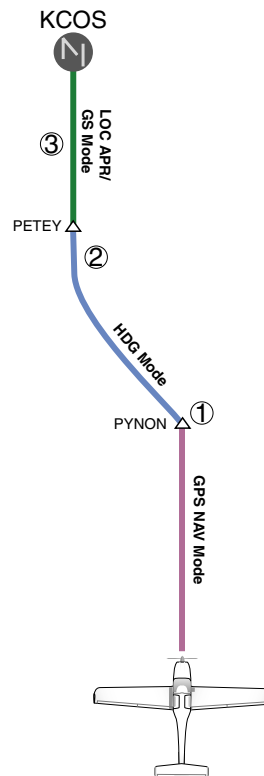

Figure 7-36 ILS Approach to KCOS



**NOTE:** Support for WAAS precision approaches is available only in installations with GIA 63W IAUs when WAAS is available.

**Flying a WAAS precision approach:**

- 1) Arm flight director modes for a precision approach:
  - a) Make sure the navigation source is set to GPS (use **CDI** Softkey to change navigation source).
  - b) Load the Runway 35R LPV approach for KCOS into the flight plan.
- 2) Press the **APR** Key once clearance for approach has been acquired. GPS Approach Mode is activated and Glidepath Mode is armed.

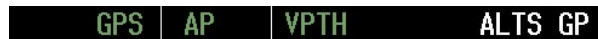

- 3) Once the glidepath is captured, Glidepath Mode becomes active.



- 4) There are two options available at this point, as the autopilot flies the approach:
  - Push the **AP DISC** Switch at the Decision height and land the aircraft.
  - Use the **GA** Switch to execute a missed approach.

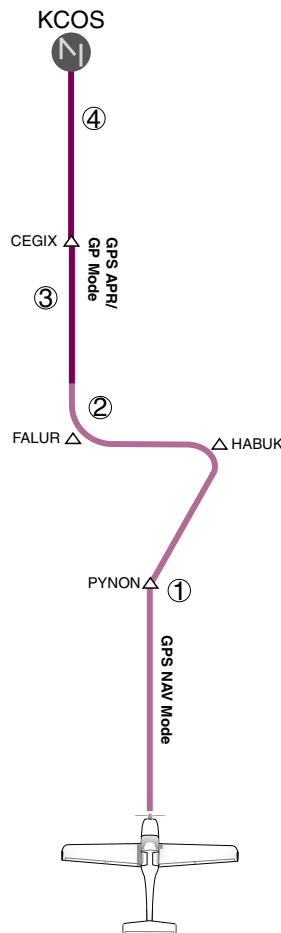

Figure 7-37 LPV Approach to KCOS

**GO AROUND/MISSED APPROACH**



**NOTE:** As a result of calculations performed by the system while flying the holding pattern, the display may re-size automatically and the aircraft may not precisely track the holding pattern.

**Flying a missed approach:**

- 1) Push the **GA** Switch at the Decision height and apply full power to execute a missed approach. The flight director Command Bars establish a nose-up climb to follow.

Note that when the **GA** Switch is pushed, the missed approach is activated and the autopilot disconnects, indicated by the 'AP' annunciation flashing yellow for 5 seconds and the autopilot disconnect aural alert.



- 2) Start the climb to the prescribed altitude in the published Missed Approach Procedure (in this case, 10,000 ft).
  - a) Press the **AP** Key to re-engage the autopilot.
  - b) Press the **CDI** Softkey to select GPS as the navigation source.
  - c) Press the **NAV** Key to have the autopilot fly to the hold.



- 3) Use the **ALT** Knob to set a Selected Altitude to hold.

To hold the current airspeed during the climb, press the **FLC** Key.



As the aircraft nears the Selected Altitude, the flight director transitions to Selected Altitude Capture Mode, indicated by the green 'ALTS' annunciation flashing for up to 10 seconds.



The green 'ALT' annunciation flashes for up to 10 seconds upon reaching 50 feet from the Selected Altitude; the autopilot transitions to Altitude Hold Mode and levels the aircraft.



- 4) The autopilot flies the holding pattern after the missed approach is activated. Annunciations are displayed in the Navigation Status Box, above the AFCS Status Box.



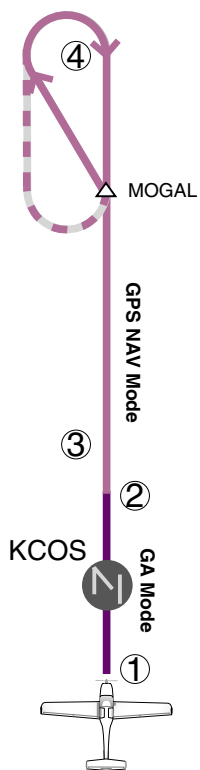

Figure 7-38 Go Around/Missed Approach

## 7.7 AFCS ANNUNCIATIONS AND ALERTS

### AFCS STATUS ALERTS

The annunciations in Table 7-4 (listed in order of increasing priority) can appear on the PFD above the Airspeed and Attitude indicators. Only one annunciation may occur at a time, and messages are prioritized by criticality.



Figure 7-39 AFCS Status Annunciation

| Alert Condition  | Annunciation | Description  |
|--|--------------|--|
| Aileron Mistrim Right                                  | <b>AIL →</b> | Roll servo providing sustained force in the indicated direction  |
| Aileron Mistrim Left                                   | <b>←AIL</b>  |  |
| Elevator Mistrim Down                                  | <b>↓ELE</b>  | Pitch servo providing sustained force in the indicated direction   |
| Elevator Mistrim Up                                    | <b>↑ELE</b>  |  |
| Pitch Trim Failure<br>(or stuck <b>AP TRIM</b> Switch) | <b>PTRM</b>  | If AP engaged, take control of the aircraft and disengage AP<br>If AP disengaged, move <b>AP TRIM</b> switches separately to unstick   |
| Roll Failure   | <b>ROLL</b>  | Roll axis control failure; AP inoperative  |
| Pitch Failure  | <b>PTCH</b>  | Pitch axis control failure; AP inoperative   |
| System Failure   | <b>AFCS</b>  | AP and MET are unavailable; FD may still be available  |
| Preflight Test   | <b>PFT</b>   | Performing preflight system test; aural alert sounds at completion<br>Do not press the <b>AP DISC</b> Switch during servo power-up and preflight system tests as this may cause the preflight system test to fail or never to start (if servos fail their power-up tests). Power must be cycled to the servos to remedy the situation. |
|  | <b>PFT</b>   | Preflight system test failed; aural alert sounds at failure  |

Table 7-4 AFCS Status Field Alerts

**OVERSPEED PROTECTION**

While Pitch Hold, Vertical Speed, Flight Level Change, Vertical Path Tracking, or an altitude capture mode is active, airspeed is monitored by the flight director and pitch commands are limited for overspeed protection. Overspeed protection is provided in situations where the flight director cannot acquire and maintain the mode reference for the selected vertical mode without exceeding the certified maximum autopilot airspeed.

When an autopilot overspeed condition occurs, the Airspeed Reference appears in a box above the Airspeed Indicator, flashing a yellow 'MAXSPD' annunciation. Engine power should be reduced and/or the pitch reference adjusted to slow the aircraft. The annunciation disappears when the overspeed condition is resolved.



**Figure 7-40 Overspeed Annunciation**

**BLANK PAGE**



## SECTION 8 ADDITIONAL FEATURES



**NOTE:** *The availability of SafeTaxi, ChartView, or FliteCharts in electronic form does not preclude the requirement to carry paper charts aboard the aircraft. See AC 120-76A for more information.*

Additional features of the G1000 include SafeTaxi™ diagrams, ChartView and FliteCharts™ electronic charts, and XM Radio entertainment.

SafeTaxi diagrams provide detailed taxiway, runway, and ramp information at more than 700 airports in the United States. By zooming in on an airport that has a SafeTaxi diagram available, a close up view of the airport layout can be seen.

The optional ChartView and FliteCharts provide on-board electronic terminal procedures charts. Electronic charts offer the convenience of rapid access to essential information. Either ChartView or FliteCharts may be configured in the system, but not both.

The optional XM Radio entertainment audio feature of the GDL 69A Data Link Receiver offers more than 170 channels of music, news, and sports. XM Radio offers more entertainment choices and longer range coverage than commercial broadcast stations.

### 8.1 SAFETAXI

SafeTaxi is an enhanced feature that gives greater map detail when zooming in on airports at close range. The maximum map ranges for enhanced detail are pilot configurable. When zoomed in close enough to show the airport detail, the map reveals runways with numbers, taxiways with identifying letters/numbers, and airport landmarks including ramps, buildings, control towers, and other prominent features. Resolution is greater at lower map ranges. When the aircraft location is within the screen boundary, including within SafeTaxi ranges, an airplane symbol is shown on any of the navigation map views for enhanced position awareness.

Any map page that displays the navigation view can also show the SafeTaxi airport layout within the maximum configured range. The following is a list of pages where the SafeTaxi feature can be seen:

- Navigation Map Page
- Inset Map (PFD)
- Weather Datalink Page
- Airport Information Page
- Intersection Information Page
- NDB Information Page
- VOR Information Page
- User Waypoint Information Page
- Trip Planning Page
- Nearest Pages

During ground operations the aircraft's position is displayed in reference to taxiways, runways, and airport features. In the example shown in Figure 8-1, the aircraft is on Taxiway Charlie approaching the beginning of runway 03.



Figure 8-1 SafeTaxi Depiction on the Navigation Map Page

The **DCLTR** Softkey (declutter) label advances to DCLTR-1, DCLTR -2, and DCLTR-3 each time the softkey is pressed for easy recognition of decluttering level. Pressing the **DCLTR** Softkey removes the taxiway markings and airport identification labels. Pressing the **DCLTR-1** Softkey removes VOR station ID, the VOR symbol, and intersection names if within the airport plan view. Pressing the **DCLTR-2** Softkey removes the airport runway layout, unless the airport in view is part of an active route structure. Pressing the **DCLTR-3** Softkey cycles back to the original map detail. Refer to Map Declutter Levels in the GPS Navigation Section.

**Configuring SafeTaxi range:**

- 1) While viewing the Navigation Map Page, press the **MENU** Key to display the PAGE MENU.
- 2) Turn the large **FMS** Knob to highlight the 'Map Setup' Menu Option and press the **ENT** Key.



**Figure 8-2 Navigation Map PAGE MENU, Map Setup Option**

- 3) Turn the **FMS** Knob to select the Aviation Group and press the **ENT** Key.
- 4) Turn the large **FMS** Knob to scroll through the Aviation Group options to 'SAFETAXI'.
- 5) Turn the small **FMS** Knob to display the range of distances.
- 6) Turn either **FMS** Knob to select the desired distance for maximum SafeTaxi display range.
- 7) Press the **ENT** Key to complete the selection.
- 8) Press the **FMS** Knob to return to the Navigation Map Page.

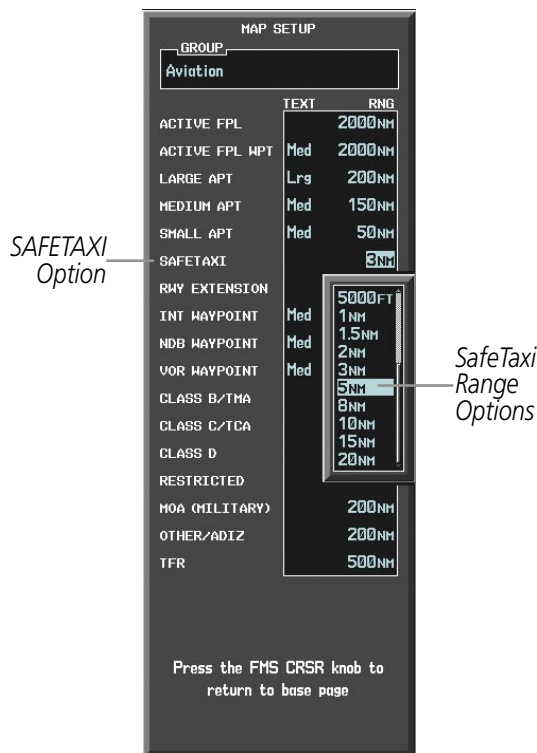

**Figure 8-3 MAP SETUP Menu, Aviation Group, SAFETAXI Range Options**

### SAFETAXI CYCLE NUMBER AND REVISION

The SafeTaxi database is revised every 56 days. SafeTaxi is always available for use after the expiration date. When turning on the G1000, the Power-up Page indicates whether the databases are current, out of date, or not available. The Power-up Page shows the SafeTaxi database is current when the ‘SafeTaxi Expires’ date is shown in white. When the SafeTaxi cycle has expired, the ‘SafeTaxi Expires’ date appears in yellow. The message ‘SafeTaxi: N/A’ appears in white if no SafeTaxi data is available on the database card (Figure 8-4).



SafeTaxi Database is Current



SafeTaxi Database has Expired



SafeTaxi Database Not Available

Figure 8-4 Power-up Page, SafeTaxi Database

The SafeTaxi Region, Version, Cycle, Effective date, and Expires date of the database cycle can also be found on the AUX - System Status page. SafeTaxi information appears in blue and yellow text. The 'EXPIRES' date appears in blue when data is current and in yellow when expired (Figures 8-5 and 8-6). SafeTaxi 'REGION NOT AVAILABLE' appears in blue if SafeTaxi data is not available on the database card (Figure 8-6). Expired SafeTaxi data is never disabled.

Press the **DBASE** Softkey for scrolling through the database information. Scroll through the database with the **FMS** knob or **ENT** Key.

The SafeTaxi database cycle number shown in Figure 8-5, '07S1' is broken down as follows:

07 – Indicates the year 2007

S – Indicates the data is for SafeTaxi

1 – Indicates the first issue of the SafeTaxi database for the year

The SafeTaxi 'EFFECTIVE' date '18-JAN-07' is the beginning date for the current database cycle. SafeTaxi 'EXPIRES' date '15-MAR-07' is the revision date for the next database cycle.

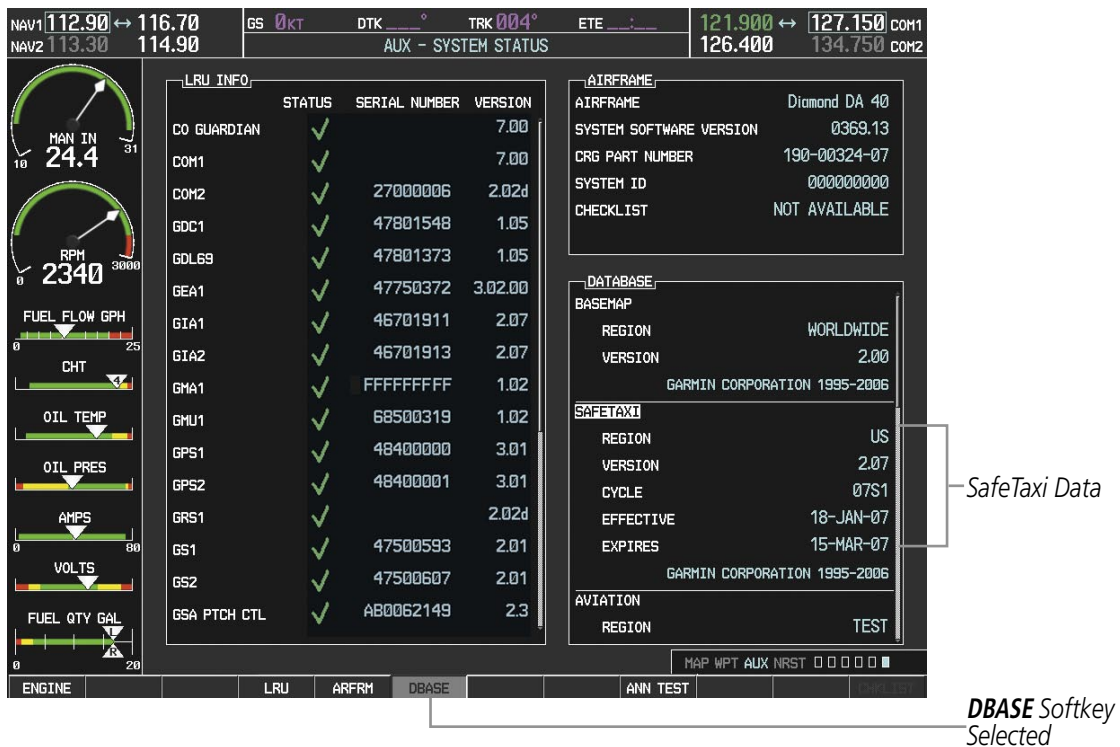

**Figure 8-5 AUX – System Status Page, SafeTaxi Current Information**

The SafeTaxi database is provided by Garmin. Refer to Updating Garmin Databases in Appendix B for instructions on revising the SafeTaxi database.

The other two possible AUX - System Status page conditions are shown in Figure 8-6. The 'EFFECTIVE' date is the beginning date for this database cycle. 'EXPIRES' date is the revision date for the next database cycle. 'NOT AVAILABLE' indicates that SafeTaxi is not available on the database card or no database card is inserted.

| DATABASE                              |           |
|---------------------------------------|-----------|
| BASEMAP                               |           |
| REGION                                | WORLDWIDE |
| VERSION                               | 2.00      |
| GARMIN CORPORATION 1995-2006          |           |
| SAFETAXI                              |           |
| REGION                                | US        |
| VERSION                               | 2.07      |
| CYCLE                                 | 07S1      |
| EFFECTIVE                             | 18-JAN-07 |
| EXPIRES                               | 15-MAR-07 |
| GARMIN LTD. AND ITS SUBSIDIARIES 2006 |           |
| AVIATION                              |           |
| REGION                                | TEST      |

*SafeTaxi Database has Expired*

| DATABASE                     |               |
|------------------------------|---------------|
| BASEMAP                      |               |
| REGION                       | WORLDWIDE     |
| VERSION                      | 2.00          |
| GARMIN CORPORATION 1995-2006 |               |
| SAFETAXI                     |               |
| REGION                       | NOT AVAILABLE |
| VERSION                      |               |
| CYCLE                        |               |
| EFFECTIVE                    | -- -- --      |
| EXPIRES                      | -- -- --      |
| AVIATION                     |               |
| REGION                       | TEST          |

*SafeTaxi Database Not Installed*

**Figure 8-6 AUX – System Status Page, SafeTaxi Expired, SafeTaxi Not Available**

## 8.2 CHARTVIEW

ChartView resembles the paper version of Jeppesen terminal procedures charts. The charts are displayed in full color with high-resolution. The MFD depiction shows the aircraft position on the moving map in the plan view of approach charts and on airport diagrams.

The ChartView database subscription is available from Jeppesen, Inc. Available data includes:

- Arrivals (STAR)
- Departure Procedures (DP)
- Approaches
- Airport Diagrams
- NOTAMs

### CHARTVIEW SOFTKEYS

ChartView functions are displayed on three levels of softkeys. While on the Navigation Map Page, Flight Plan Page, or Nearest Airports Page, pressing the **SHW CHRT** Softkey displays the available terminal chart and advances to the chart selection level of softkeys: **CHRT OPT**, **CHRT**, **INFO**, **DP**, **STAR**, **APR**, **WX**, **NOTAM**, and **GO BACK**. The chart selection softkeys (Figure 8-7) appear on the Airport Information Page.

Pressing the **GO BACK** Softkey reverts to the top level softkeys and previous page.

Pressing the **CHRT OPT** Softkey advances to the next level of softkeys: **ALL**, **HEADER**, **PLAN**, **PROFILE**, **MINIMUMS**, **FIT WDTN**, **FULL SCN**, and **BACK**.

While viewing the **CHRT OPT** Softkeys, after 45 seconds of softkey inactivity, the system reverts to the chart selection softkeys.

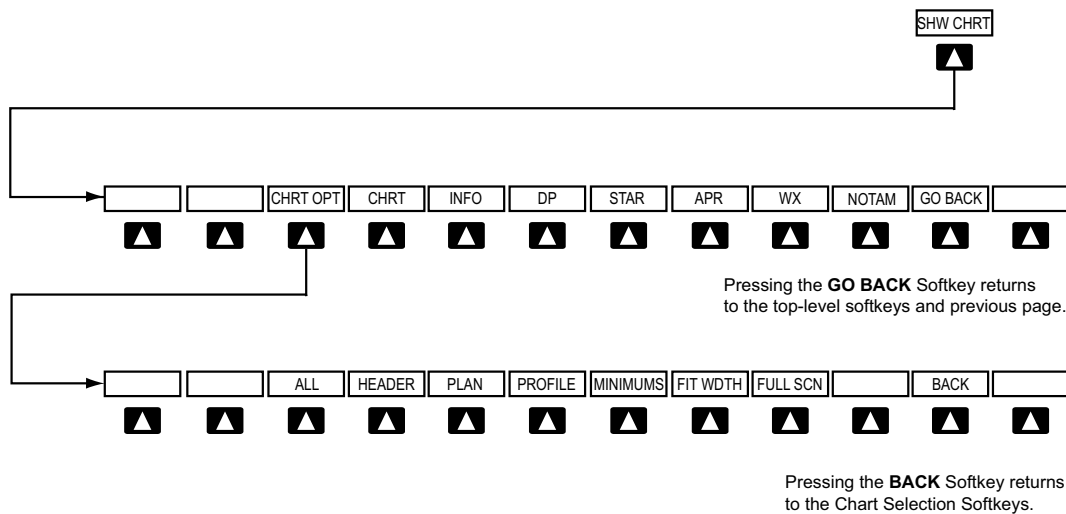

Figure 8-7 ChartView SHW CHRT, Chart Selection, and Chart Option Softkeys

## TERMINAL PROCEDURES CHARTS

### Selecting Terminal Procedures Charts:

- 1) While viewing the Navigation Map Page, Nearest Airport Page, or Flight Plan Page, press the **SHW CHRT** Softkey.

OR:

- 2) Press the **MENU** Key to display the PAGE MENU.
- 3) Turn the large **FMS** Knob to scroll through the OPTIONS Menu to 'Show Chart'.
- 4) Press the **ENT** Key to display the chart.

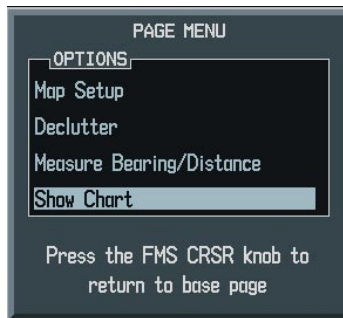

Figure 8-8 Navigation Map Page OPTIONS Menu

When no terminal procedure chart is available, the banner 'CHART NOT AVAILABLE' appears on the screen. The 'CHART NOT AVAILABLE' banner does not refer to the Jeppesen subscription, but rather the availability of a particular airport chart selection or procedure for a selected airport.



Figure 8-9 Chart Not Available Banner

If there is a problem in rendering the data (such as a data error or a failure of an individual chart), the banner 'UNABLE TO DISPLAY CHART' is then displayed.



Figure 8-10 Unable To Display Chart Banner



When a chart is not available from the Navigation Map Page by pressing the **SHW CHRT** Softkey or selecting a Page Menu Option, charts may be obtained from the WPT Pages or Flight Plan Pages.



**Figure 8-11** Waypoint Information Page **OPTIONS** Menu

If a chart is available for the destination airport, or the airport selected in the flight plan, it appears on the screen. When no flight plan is active, or when not flying to a direct-to destination, pressing the **SHW CHRT** Softkey displays the chart for the nearest airport, if available.

The chart shown will be one associated with the WPT – Airport Information page. Usually this is the airport runway diagram. Where no runway diagram exists, but Take Off Minimums or Alternate Minimums are available, that page will appear. If Airport Information pages are unavailable, the Approach Chart for the airport is shown.

Selecting a chart:

- 1) While viewing the Navigation Map Page, Flight Plan Page, or Nearest Airports Page, press the **SHW CHRT** Softkey. The airport diagram will be displayed on the Airport Information Page.
- 2) Press the **FMS** Knob to activate the cursor.
- 3) Turn the large **FMS** Knob to select either the Airport Identifier Box or the Approach Box.
- 4) Turn the small and large **FMS** Knob to enter the desired airport identifier.
- 5) Press the **ENT** Key to complete the airport selection.
- 6) Turn the large **FMS** Knob to select the Approach Box.
- 7) Turn the small **FMS** Knob to show the approach chart selection choices.
- 8) Turn either **FMS** Knob to scroll through the available charts.
- 9) Press the **ENT** Key to complete the chart selection.

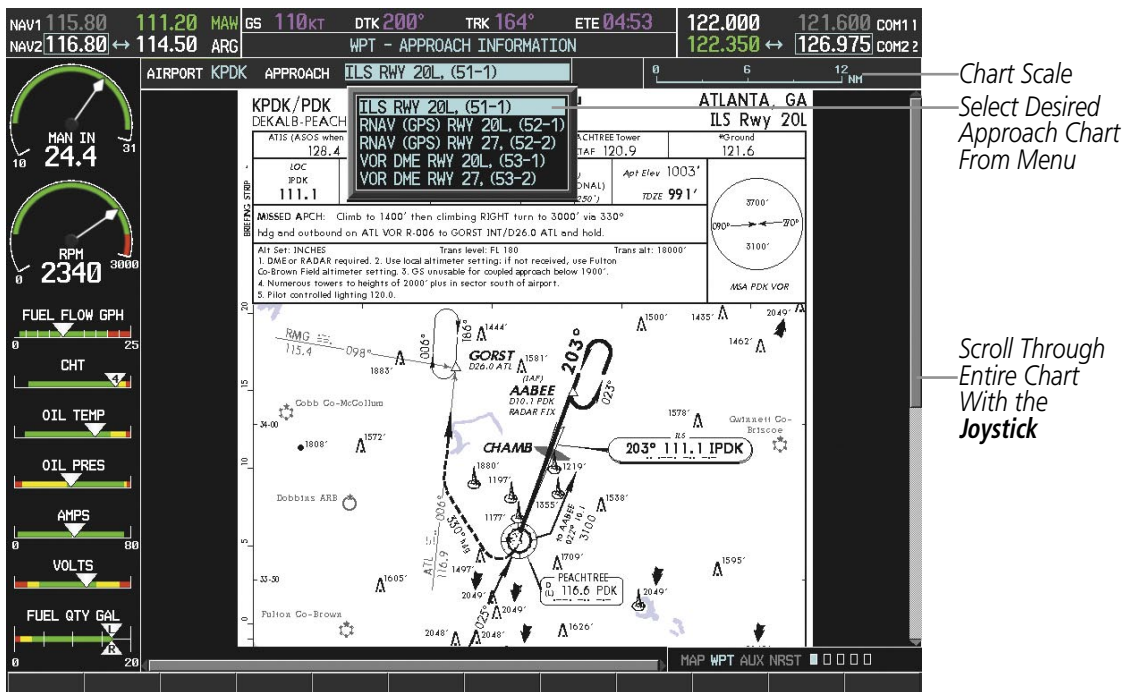

Figure 8-12 Approach Information Page, Chart Selection

While the APPROACH Box is selected using the **FMS** Knob, the G1000 softkeys are blank. Once the desired chart is selected, the chart scale can be changed and the chart page can be scrolled using the **Joystick**. Pressing the **Joystick** centers the chart on the screen.

The aircraft symbol is shown on the chart only if the chart is to scale and the aircraft position is within the boundaries of the chart. The aircraft symbol is not displayed when the Aircraft Not Shown Icon appears (Figure 8-16). If the Chart Scale Box displays a banner 'CHART NOT TO SCALE', the aircraft symbol will not be shown. The Aircraft Not Shown Icon may appear at certain times, even if the chart is displayed to scale.

Pressing the **CHRT** Softkey switches between the ChartView diagram and the associated map in the WPT page group. In the example shown, the **CHRT** Softkey switches between the Colorado Springs, CO (KCOS) Airport Diagram and the navigation map on the WPT – Airport Information page.

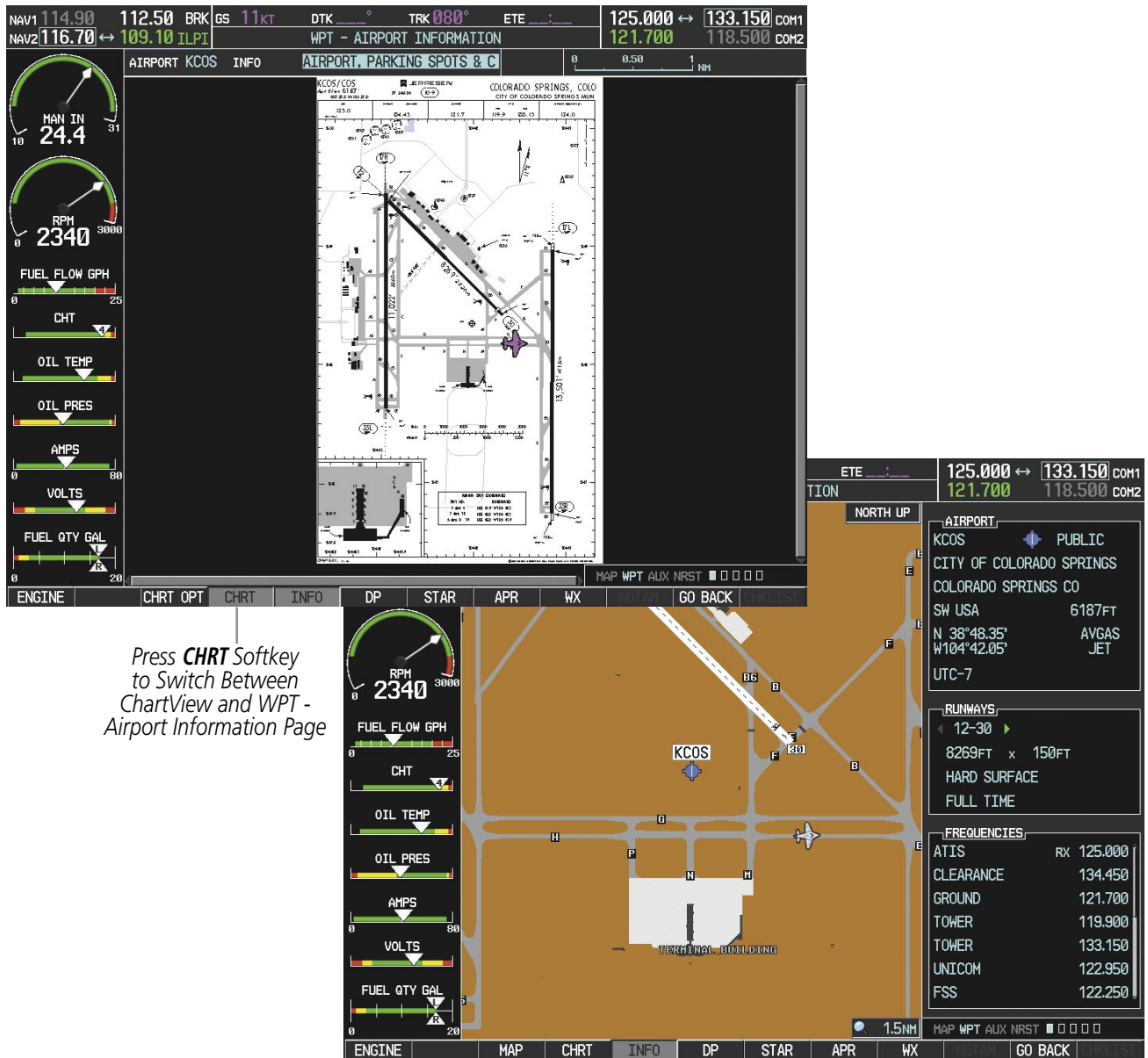

Figure 8-13 CHRT Softkey, Airport Information Page

Pressing the **INFO** Softkey returns to the airport diagram when the view is on a different chart. If the displayed chart is the airport diagram, the **INFO** Softkey will have no effect.

The aircraft position is shown in magenta on the ChartView diagrams when the location of the aircraft is within the chart boundaries. In the example shown, the aircraft is turning onto Taxiway Romeo on the Charlotte, NC (KCLT) airport.

Another source for additional airport information is from the INFO Box above the chart for certain airports. This information source is not related to the **INFO** Softkey. When the INFO Box is selected using the **FMS** Knob, the G1000 softkeys are blank. The Charlotte, NC airport has five additional charts offering information; the Airport Diagram, Take-off Minimums, Class B Airspace, Airline Parking Gate Coordinates, and Airline Parking Gate Location. (The numbers in parentheses after the chart name are Jeppesen designators.)



Figure 8-14 Airport Information Page, INFO View, Full Screen Width

In the example shown in Figure 8-14, the Class B Chart is selected. Pressing the **ENT** Key displays the Charlotte Class B Airspace Chart (Figure 8-15).

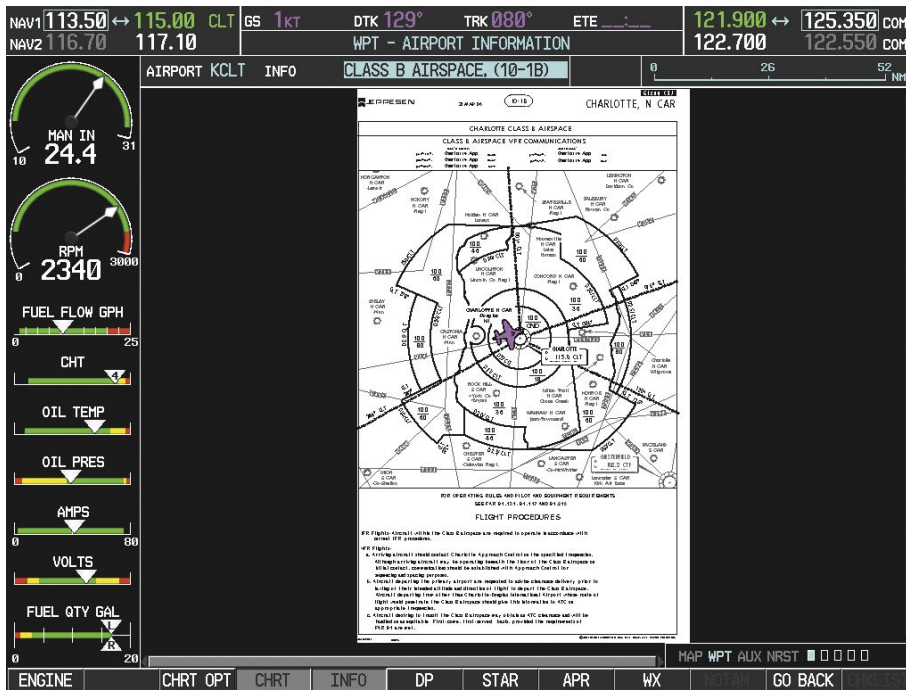

**Figure 8-15 Airport Information Page, Class B Chart Selected from INFO View**

Pressing the **DP** Softkey displays the Departure Procedure Chart if available.

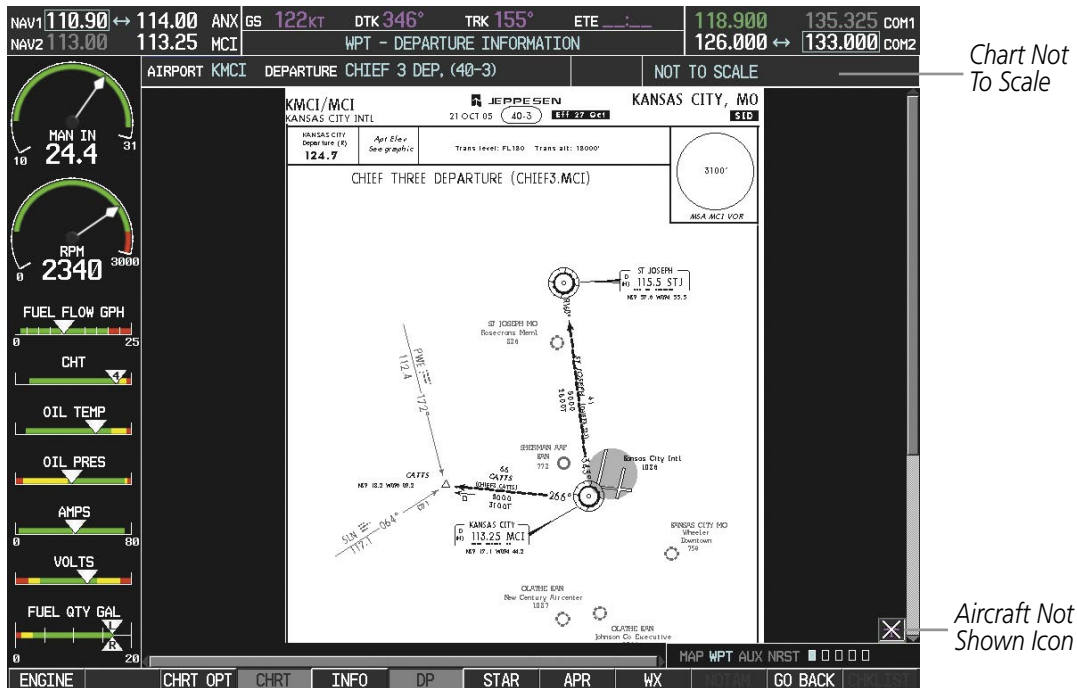

**Figure 8-16 Departure Information Page**

Pressing the **STAR** Softkey displays the Standard Terminal Arrival Chart if available.

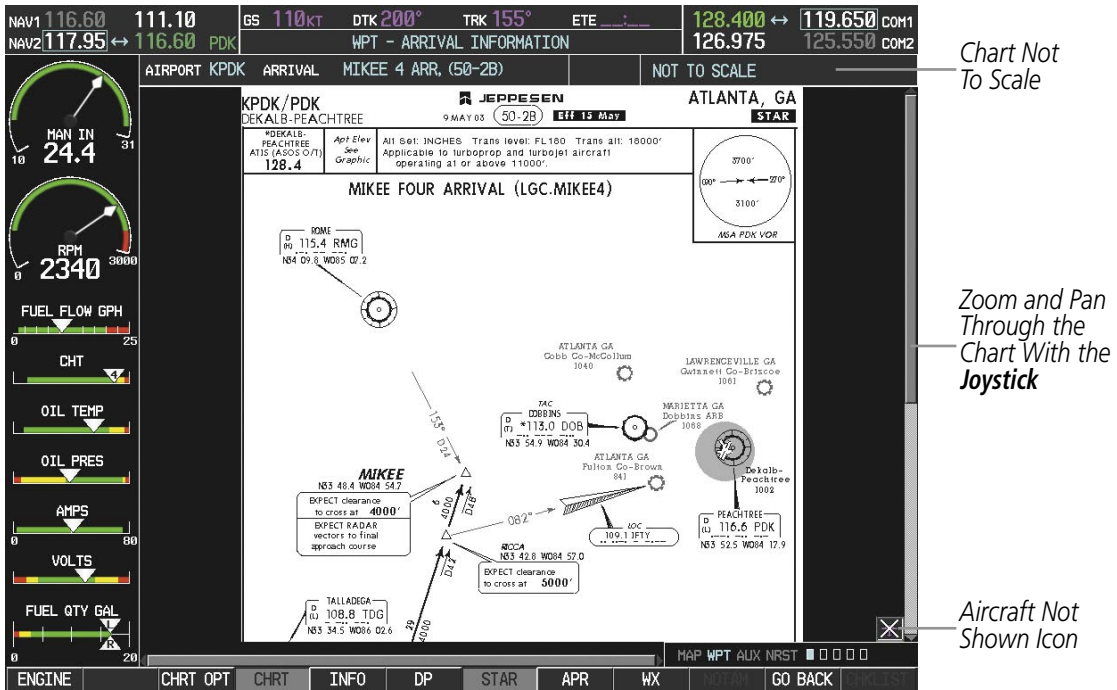

Figure 8-17 Arrival Information Page

Pressing the **APR** Softkey displays the approach chart for the airport if available.



Figure 8-18 Approach Information Page

Pressing the **WX** Softkey shows the airport weather frequency information, and includes weather data such as METAR and TAF from the XM Data Link Receiver, when available. Weather information is available only when an XM Data Link Receiver is installed and the XM Weather subscription is current.

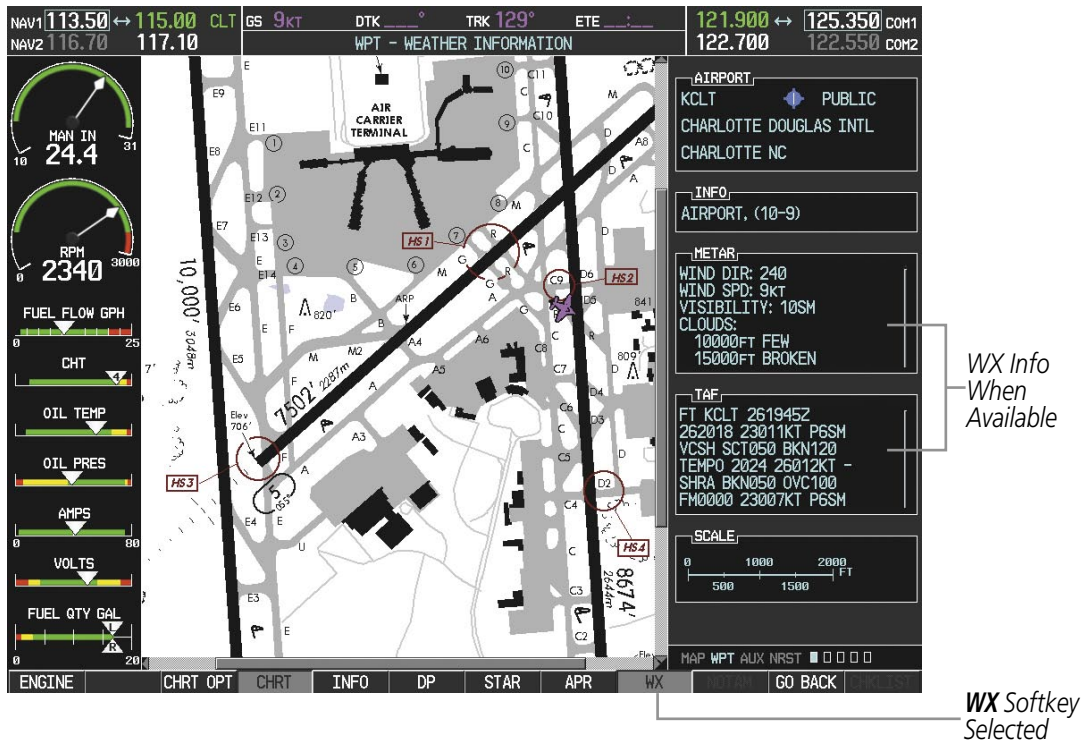
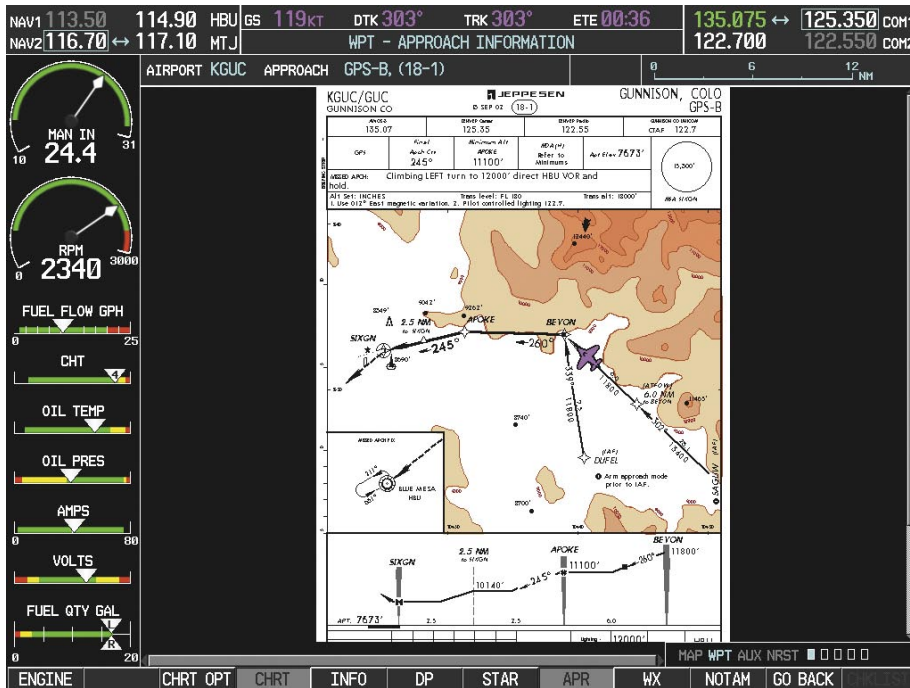

Figure 8-19 Weather Information Page



**NOTE:** A subdued softkey label indicates the function is disabled.

Recent NOTAMS applicable to the current ChartView cycle are included in the ChartView database. Pressing the **NOTAM** Softkey shows the local NOTAM information for selected airports, when available. When NOTAMS are not available, the **NOTAM** Softkey label appears subdued and is disabled as shown in Figure 8-19. The **NOTAM** Softkey may appear on the Airport Information Page, the Navigation Map Page, and all of the chart page selections.



*NOTAM  
Softkey  
Appears for  
Selected  
Airports*

Figure 8-20 NOTAM Softkey Highlighted



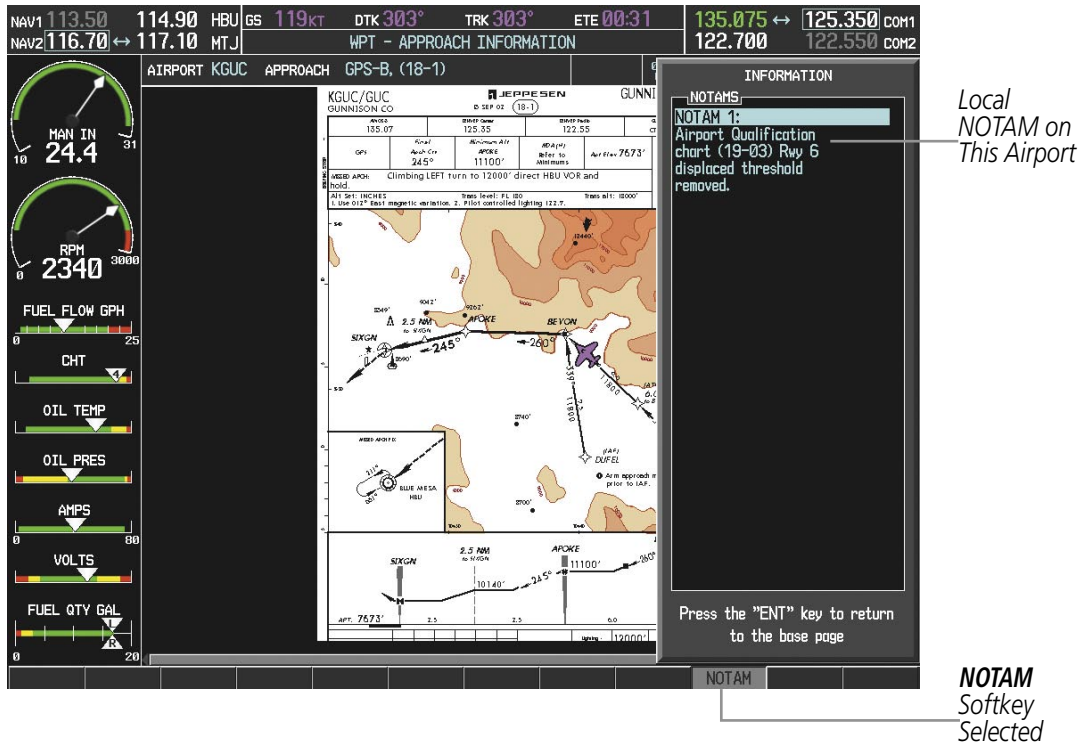

**Figure 8-21 Airport Information Page, Local NOTAMS**

Pressing the **NOTAM** Softkey again removes the NOTAMS information.

Pressing the **GO BACK** Softkey reverts to the previous page (Navigation Map Page, Nearest Pages, or Flight Plan Page).

## CHART OPTIONS

Pressing the **CHRT OPT** Softkey displays the next level of softkeys, the chart options level (Figure 8-7).

Pressing the **ALL** Softkey shows the entire approach chart on the screen.

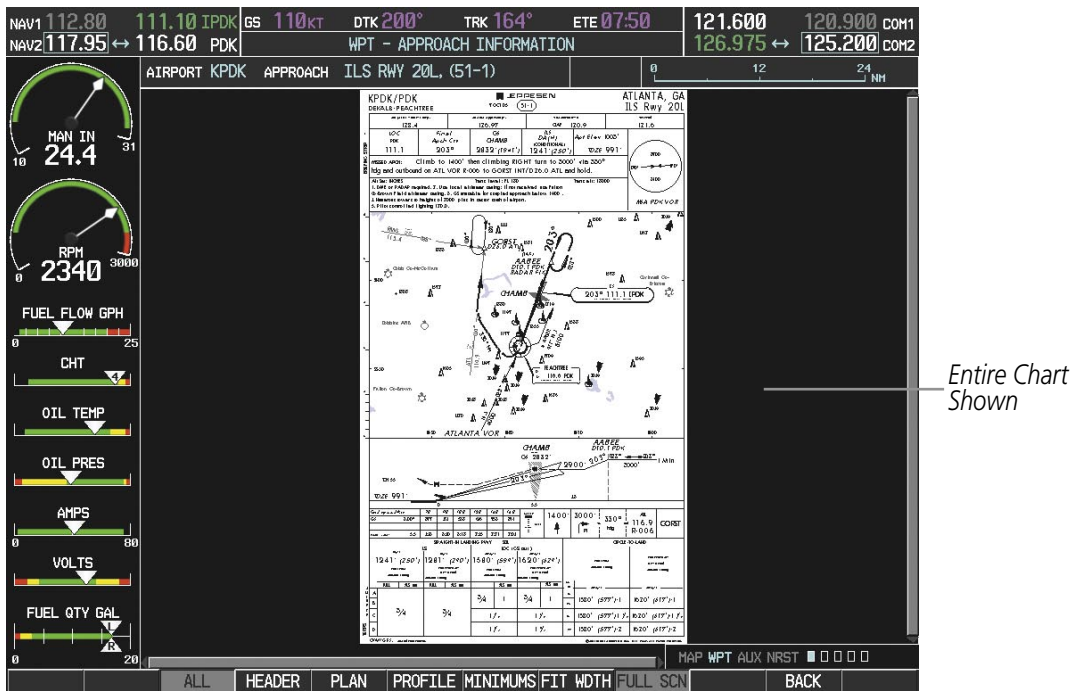
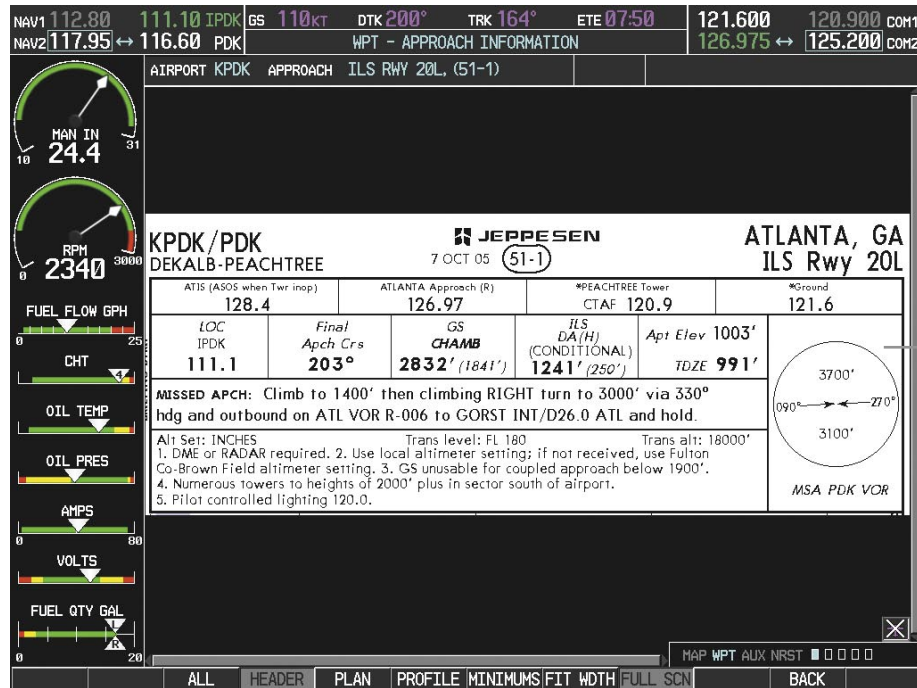

Figure 8-22 Approach Information Page, ALL View

Pressing the **HEADER** Softkey shows the header view (approach chart briefing strip) on the screen.



Approach Chart Briefing Strip

Figure 8-23 Approach Information Page, Header View

Pressing the **PLAN** Softkey shows the approach chart two dimensional plan view.

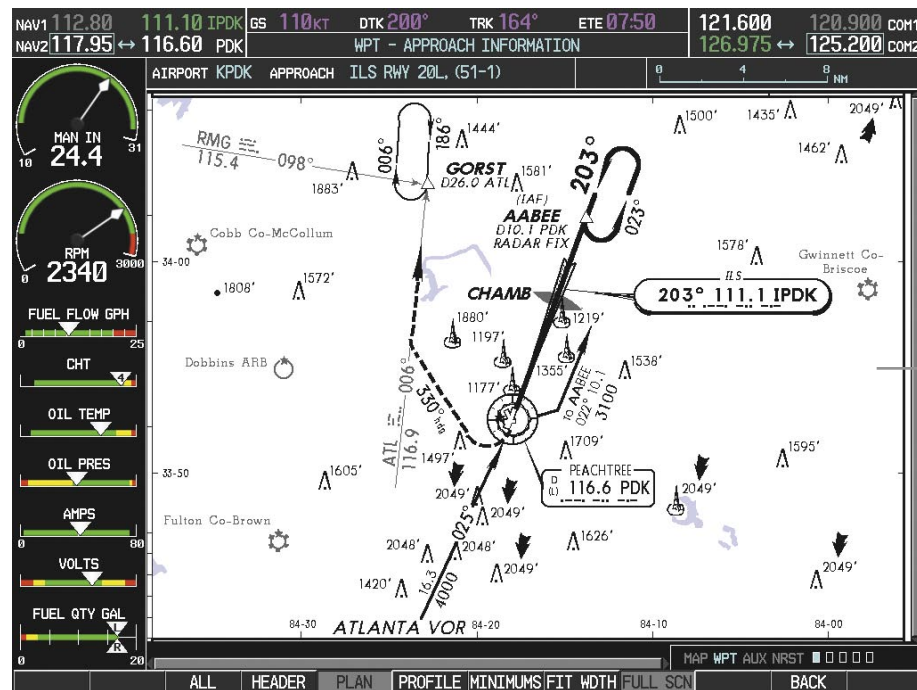

Approach Chart Plan View

Figure 8-24 Approach Information Page, Plan View

Pressing the **PROFILE** Softkey displays the approach chart descent profile strip.

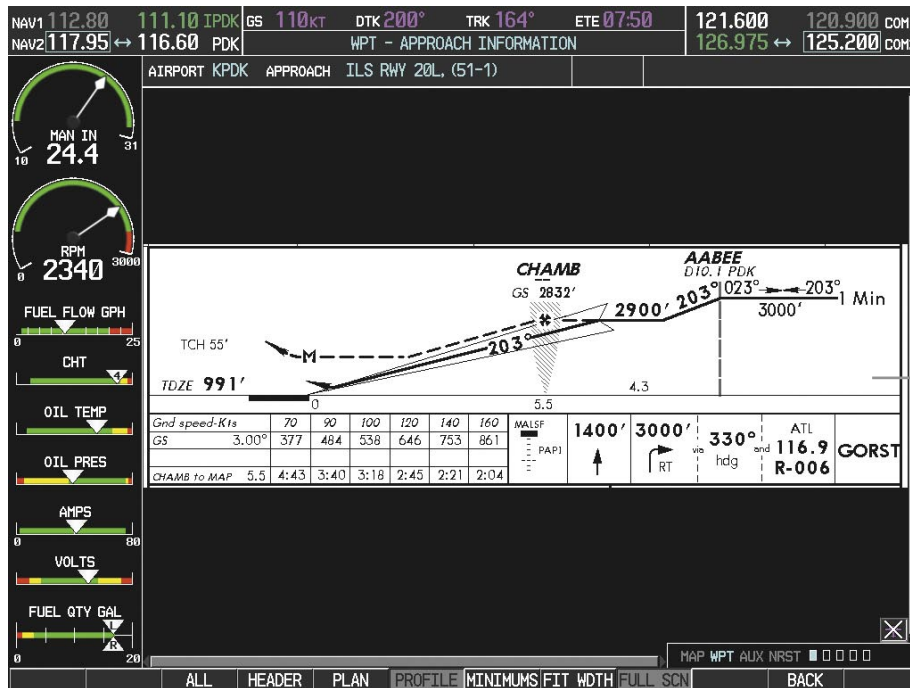

Figure 8-25 Approach Information Page, Profile View, Full Screen Width

Pressing the **MINIMUMS** Softkey displays the minimum descent altitude/visibility strip at the bottom of the approach chart.

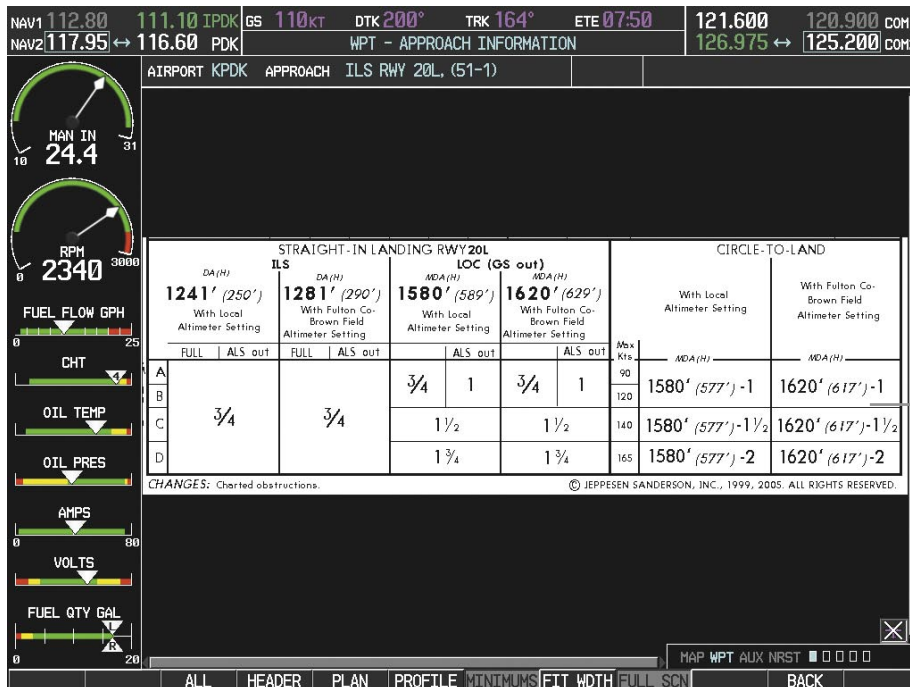

Figure 8-26 Approach Information Page, Minimums View, Full Screen Width

If the chart scale has been adjusted to view a small area of the chart, pressing the **FIT WIDTH** Softkey changes the chart size to fit the available screen width.



Press **FIT WIDTH** Softkey to Show Full Chart Width

**Figure 8-27 Airport Information Page, FIT WIDTH Softkey Selected**

Pressing the **FULL SCN** Softkey alternates between removing and replacing the data window to the right.

**Selecting Additional Information:**

- 1) While viewing the Airport Taxi Diagram, press the **FULL SCN** Softkey to display the information windows (AIRPORT, INFO).
- 2) Press the **FMS** Knob to activate the cursor.
- 3) Turn the large **FMS** Knob to highlight the AIRPORT, INFO, or FREQUENCIES Box (INFO Box shown.)
- 4) Turn the small **FMS** Knob to select the INFO Box choices. If multiple choices are available, scroll to the desired choice with the large **FMS** Knob and press the **ENT** Key to complete the selection.
- 5) Press the **FMS** Knob again to deactivate the cursor.

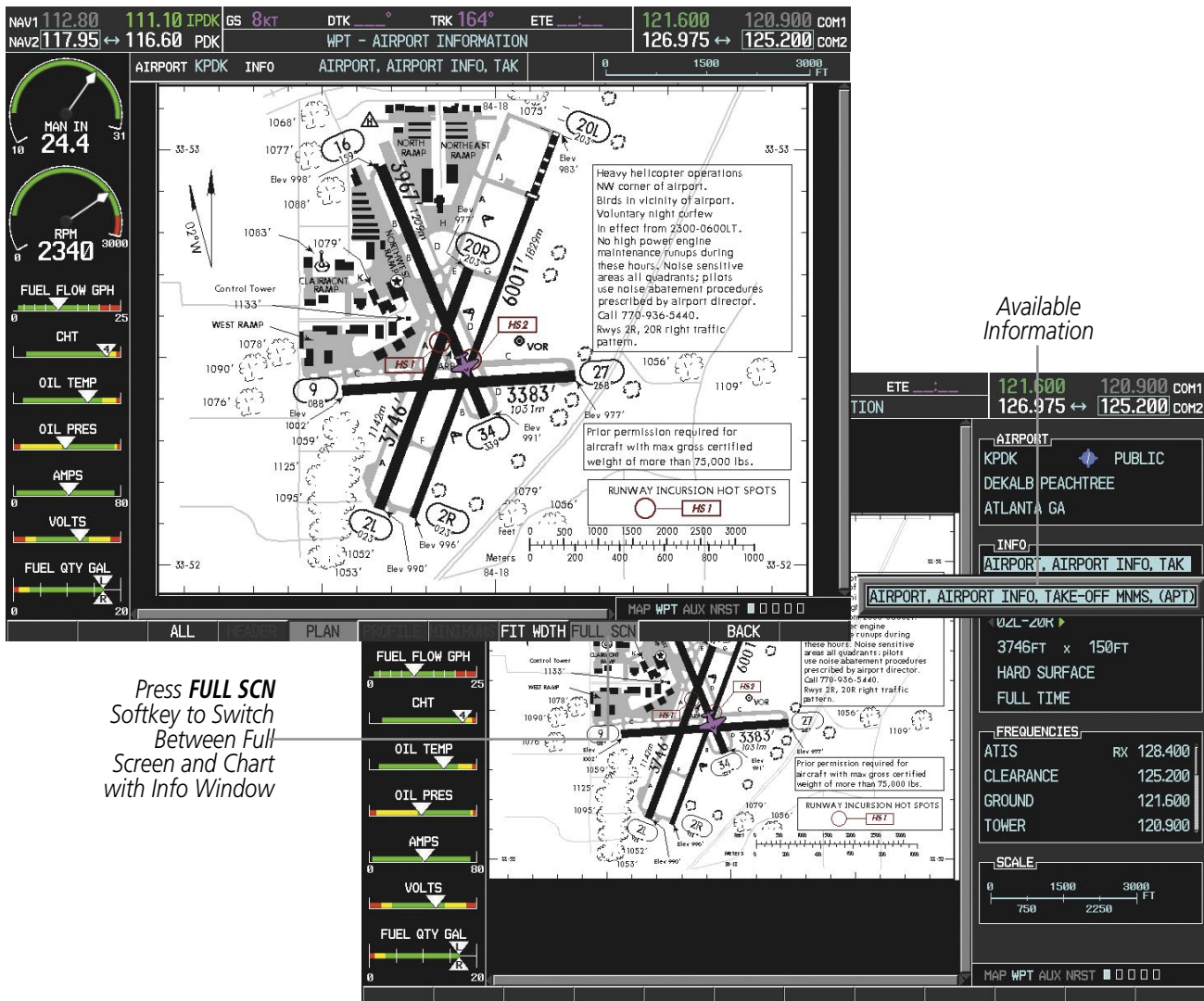

Press **FULL SCN** Softkey to Switch Between Full Screen and Chart with Info Window

Figure 8-28 Airport Information Page, Full Screen and Info Window

Pressing the **BACK** Softkey, or waiting for 45 seconds reverts to the chart selection softkeys.

**DAY/NIGHT VIEW**

ChartView can be displayed on a white or black background for day or night viewing. The Day View offers a better presentation in a bright environment. The Night View gives a better presentation for viewing in a dark environment. When the CHART SETUP Box is selected the G1000 softkeys are blank.

**Selecting Day, Night, or Automatic View:**

- 1) While viewing a terminal chart press the **MENU** Key to display the Page Menu OPTIONS.
- 2) Turn the large **FMS** Knob to highlight the 'Chart Setup' Menu Option and press the **ENT** Key.



**Figure 8-29** Waypoint Information Page, OPTIONS Menu

- 3) Turn the large **FMS** Knob to move between the 'FULL SCREEN' and 'COLOR SCHEME' Options (Figure 8-30).
- 4) Turn the small **FMS** Knob to choose between the 'On' and 'Off' Full Screen Options.
- 5) Turn the small **FMS** Knob to choose between 'Day', 'Auto', and 'Night' Options.
- 6) In Auto Mode, turn the large **FMS** Knob to select the percentage field and change percentage with the small **FMS** Knob. The percentage of change is the day/night crossover point based on backlighting intensity.



**NOTE:** Once an adjustment is made to the percentage field in Auto mode, the chart must be redrawn (zoomed in or out, or another chart selected) before the switch from Day to Night is seen.

- 7) Press the **FMS** Knob when finished to remove the Chart Setup Menu.

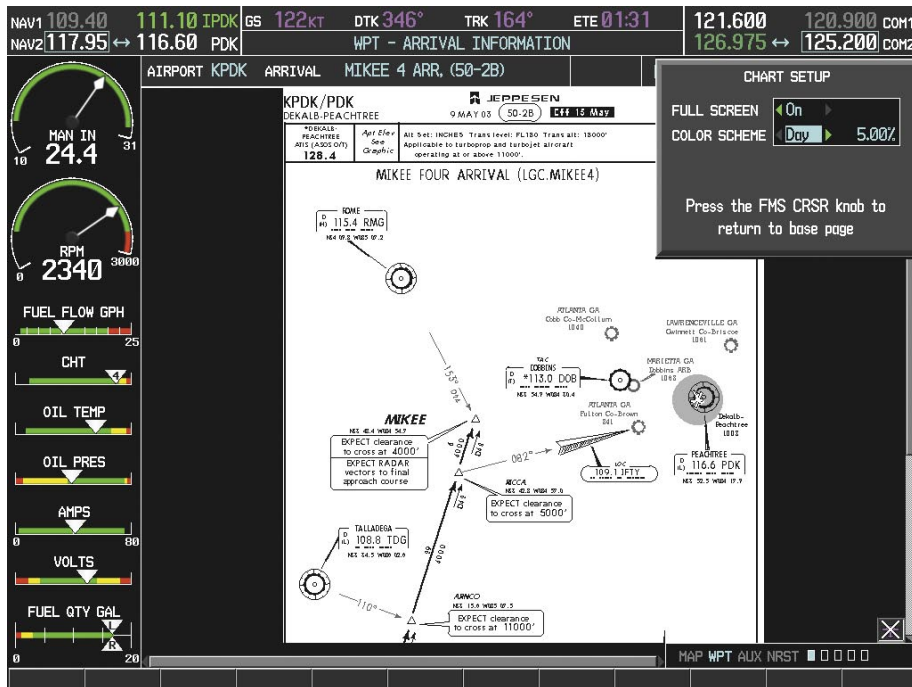

Figure 8-30 Arrival Information Page, Day View

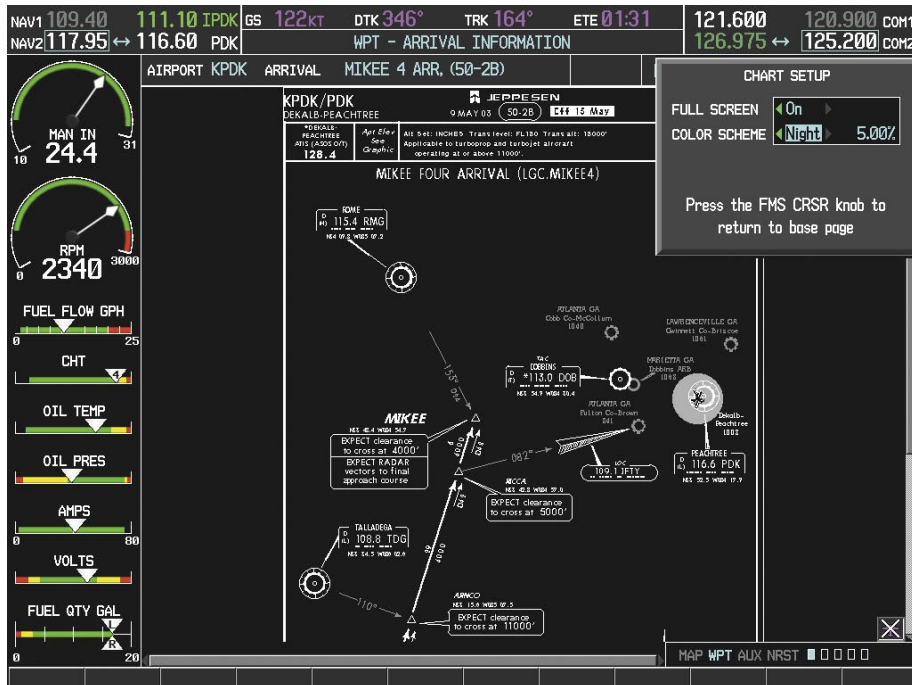

Figure 8-31 Arrival Information Page, Night View



## CHARTVIEW CYCLE NUMBER AND EXPIRATION DATE

ChartView database is revised every 14 days. Charts are still viewable during a period that extends from the cycle expiration date to the disables date. ChartView is disabled 70 days after the expiration date and is no longer available for viewing upon reaching the disables date. When turning on the G1000, the Power-up Page indicates any of nine different possible criteria for ChartView availability. See Table 8-1 for the various ChartView Power-up Page displays and the definition of each.









| Power-up Page Display   | Definition  |
|---|---|
|    | Blank Line. G1000 system is not configured for ChartView. Contact a Garmin-authorized service center for configuration.                               |
|    | System is configured for ChartView but no chart database is installed. Contact Jeppesen for a ChartView database.                                     |
|    | Normal operation. ChartView database is valid and within current cycle.   |
|    | ChartView database is within 1 week after expiration date. A new cycle is available for update.   |
|    | ChartView database is beyond 1 week after expiration date, but still within the 70 day viewing period.  |
|   | ChartView database has timed out. Database is beyond 70 days after expiration date. ChartView database is no longer available for viewing.            |
|  | System time is not available. GPS satellite data is unknown or G1000 has not yet locked onto satellites. Check database cycle number for effectivity. |
|  | System is verifying chart database when new cycle is installed for the first time.  |
|  | After verifying, chart database is found to be corrupt. ChartView will not be available.  |

Table 8-1 ChartView Power-up Page Annunciations and Definitions

Examples of four possible Power-up Page conditions are shown in Figure 8-32. 'ChartView Disables' plus a date in white, indicates chart data is current. This indication for normal operation shows how long the charts may be viewed. 'Chart data update available.' in white, indicates the chart data cycle has expired within the past week and the next chart cycle is available. 'Chart data is out of date!' in yellow, indicates charts are still viewable, but approaching the disable date. 'Chart data is disabled.' in yellow, indicates the chart cycle has expired and is no longer viewable.

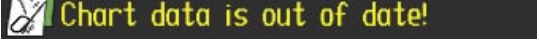
**DATABASE**

- Checklist File: N/A
- Basemap Land 2.00
- SafeTaxi Expires 15-MAR-2007
- Terrain 2.04
- Airport Terrain 2.04
- Obstacle Expires 23-NOV-2006
- Aviation Expires 28-SEP-2006
- ChartView Disables 14-DEC-2006

All map and terrain data provided is only to be used as a general reference to your surrounding and as an aid to situational awareness.

*ChartView Database is Current and Available*

**DATABASE**

- Checklist File: N/A
- Basemap Land 2.00
- SafeTaxi Expires 15-MAR-2007
- Terrain 2.04
- Airport Terrain 2.04
- Obstacle Expires 23-NOV-2006
- Aviation Expires 28-SEP-2006
- Chart data update available.

All map and terrain data provided is only to be used as a general reference to your surrounding and as an aid to situational awareness.

*Chart Cycle has Expired, Next Cycle is Available*

**DATABASE**

- Checklist File: N/A
- Basemap Land 2.00
- SafeTaxi Expires 15-MAR-2007
- Terrain 2.04
- Airport Terrain 2.04
- Obstacle Expires 23-NOV-2006
- Aviation Expires 28-SEP-2006
- Chart data is out of date!

All map and terrain data provided is only to be used as a general reference to your surrounding and as an aid to situational awareness.

*Chart Cycle has Expired but is Still Viewable for 70 Days from Expiration Date*

**DATABASE**

- Checklist File: N/A
- Basemap Land 2.00
- SafeTaxi Expires 15-MAR-2007
- Terrain 2.04
- Airport Terrain 2.04
- Obstacle Expires 23-NOV-2006
- Aviation Expires 28-SEP-2006
- Chart data is disabled.

All map and terrain data provided is only to be used as a general reference to your surrounding and as an aid to situational awareness.

*Chart Cycle is No Longer Viewable*

**Figure 8-32 Examples of Power-up Page, ChartView Database**

 **NOTE:** A subdued softkey label indicates the function is disabled.

The ChartView time critical information can also be found on the AUX - System Status page. The database 'CYCLE' number, 'EXPIRES', and 'DISABLES' dates of the ChartView subscription appear in either blue or yellow text. When the ChartView 'EXPIRES' date is reached, ChartView becomes inoperative 70 days later. This is shown as the 'DISABLES' date. When the 'DISABLES' date is reached, charts are no longer available for viewing. The **SHW CHRT** Softkey label then appears subdued and is disabled until a revised issue of ChartView is installed.

Press the **DBASE** Softkey for scrolling through the database information. Scroll through the database with the **FMS** knob or **ENT** Key.

The ChartView database cycle number shown in Figure 8-33, '0619' is broken down as follows:

06 – Indicates the year 2006

19 – Indicates the 19th issue of the ChartView database for the year

The 'EXPIRES' date "05-OCT-06" is the date that this database should be replaced with the next issue.

The 'DISABLES' date "14-DEC-06" is the date that this database becomes inoperative.



**Figure 8-33 AUX – System Status Page, ChartView Current and Available**

The ChartView database is provided directly from Jeppesen. Refer to Updating Jeppesen Databases in Appendix B for instructions on revising the ChartView database.

The other three possible AUX - System Status page conditions are shown in Figure 8-34. The 'EXPIRES' date, in yellow, is the revision date for the next database cycle. The 'DISABLES' date, in yellow, is the date that this database cycle is no longer viewable. 'REGION' and 'CYCLE' 'NOT AVAILABLE' in blue, indicate that no ChartView data is available on the database card or no database card is inserted.

| DATABASE                                       |                    |
|--|--------------------|
| OBSTACLE                                       |                    |
| REGION   | US/EUROPE          |
| VERSION  | 2.08               |
| CYCLE  | 06B5               |
| EFFECTIVE                                      | 28-SEP-06          |
| EXPIRES  | 23-NOV-06          |
| Copyright 2006 Garmin Ltd. or its subsidiaries |                    |
| CHART  |                    |
| CHART  | Jeppesen ChartView |
| CYCLE  | 0619               |
| EXPIRES  | 05-OCT-06          |
| DISABLES                                       | 14-DEC-06          |
| Copyright 2006. Jeppesen Sanderson, Inc.       |                    |

ChartView Database has Expired, but is not Disabled

| DATABASE                                       |                    |
|--|--------------------|
| OBSTACLE                                       |                    |
| REGION   | US/EUROPE          |
| VERSION  | 2.08               |
| CYCLE  | 06B5               |
| EFFECTIVE                                      | 28-SEP-06          |
| EXPIRES  | 23-NOV-06          |
| Copyright 2006 Garmin Ltd. or its subsidiaries |                    |
| CHART  |                    |
| CHART  | Jeppesen ChartView |
| CYCLE  | 0619               |
| EXPIRES  | 05-OCT-06          |
| DISABLES                                       | 14-DEC-06          |
| Copyright 2006. Jeppesen Sanderson, Inc.       |                    |

ChartView Database is Disabled

| DATABASE                                       |                    |
|--|--------------------|
| VERSION  | 2.08               |
| CYCLE  | 06B5               |
| EFFECTIVE                                      | 28-SEP-06          |
| EXPIRES  | 23-NOV-06          |
| Copyright 2006 Garmin Ltd. or its subsidiaries |                    |
| CHART  |                    |
| CHART  | Jeppesen ChartView |
| REGION   | NOT AVAILABLE      |
| CYCLE  | NOT AVAILABLE      |
| EFFECTIVE                                      | __-__-__-__        |
| EXPIRES  | __-__-__-__        |
| DISABLES                                       | __-__-__-__        |

System is Configured for ChartView but Database is not Available

ChartView Database is Not Available

Figure 8-34 AUX – System Status Page, ChartView Expired, ChartView Disabled, ChartView Not Available

### 8.3 FLITECHARTS

FliteCharts resemble the paper version of National Aeronautical Charting Office (NACO) terminal procedures charts. The charts are displayed with high-resolution and in color for applicable charts. FliteCharts database subscription is available from Garmin. Available data includes:

- Arrivals (STAR)
- Departure Procedures (DP)
- Approaches
- Airport Diagrams

#### FLITECHARTS SOFTKEYS

FliteCharts functions are displayed on three levels of softkeys. While on the Navigation Map Page or Nearest Airports Page, pressing the **SHW CHRT** Softkey displays the available terminal chart and advances to the chart selection level of softkeys: **CHRT OPT**, **CHRT**, **INFO**, **DP**, **STAR**, **APR**, **WX**, and **GO BACK**. The chart selection softkeys (Figure 8-35) appear on the Airport Information Page.

Pressing the **GO BACK** Softkey reverts to the top level softkeys and previous page.

Pressing the **CHRT OPT** Softkey displays the available terminal chart and advances to the next level of softkeys: **ALL**, **FIT WDTH**, **FULL SCN**, and **BACK**.

While viewing the **CHRT OPT** Softkeys, after 45 seconds of softkey inactivity, the system reverts to the chart selection softkeys.

NOTAMs are not available with FliteCharts. The NOTAM Softkey label appears subdued and is disabled.

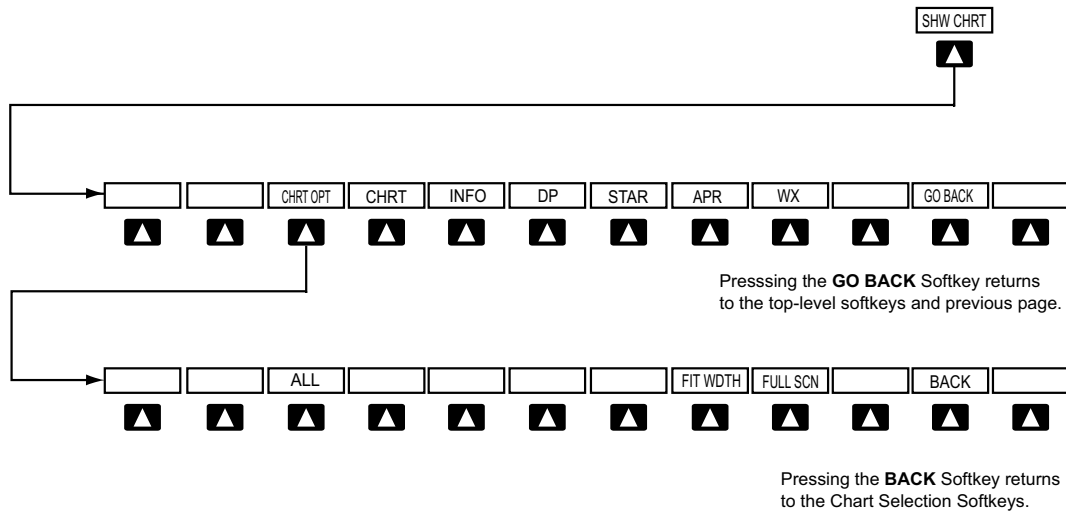

Figure 8-35 FliteCharts SHW CHRT, Chart Selection, and Chart Option Softkeys

TERMINAL PROCEDURES CHARTS

Selecting Terminal Procedures Charts:

1) While viewing the Navigation Map Page, Nearest Airport Page, or Flight Plan Page, press the **SHW CHRT** Softkey.

OR:

- 2) Press the **MENU** Key to display the PAGE MENU.
- 3) Turn the large **FMS** Knob to scroll through the OPTIONS Menu to 'Show Chart'.
- 4) Press the **ENT** Key to display the chart.



Figure 8-36 Navigation Map Page OPTIONS Menu

When no terminal procedure chart is available, the banner 'CHART NOT AVAILABLE' appears on the screen. The 'CHART NOT AVAILABLE' banner does not refer to the FliteCharts subscription, but rather the availability of a particular airport chart selection or procedure for a selected airport.



Figure 8-37 Chart Not Available Banner

If there is a problem in rendering the data (such as a data error or a failure of an individual chart), the banner 'UNABLE TO DISPLAY CHART' is then displayed.



Figure 8-38 Unable To Display Chart Banner

When a chart is not available from the Navigation Map Page by pressing the **SHW CHRT** Softkey or selecting a Page Menu Option, charts may be obtained from the WPT Pages or Flight Plan Pages.



Figure 8-39 Waypoint Information Page OPTIONS Menu

If a chart is available for the destination airport, or the airport selected in the flight plan, it appears on the screen. When no flight plan is active, or when not flying to a direct-to destination, pressing the **SHW CHRT** Softkey displays the chart for the nearest airport, if available.

The chart shown will be one associated with the WPT – Airport Information page. Usually this is the airport runway diagram. Where no runway diagram exists, but Take Off Minimums or Alternate Minimums are available, that page will appear. If Airport Information pages are unavailable, the Approach Chart for the airport is shown.

**Selecting a chart:**

- 1) While viewing the Navigation Map Page, Flight Plan Page, or Nearest Airports Page, press the **SHW CHRT** Softkey. The airport diagram will be displayed on the Airport Information Page.
- 2) Press the **FMS** Knob to activate the cursor.
- 3) Turn the large **FMS** Knob to select either the Airport Identifier Box or the Approach Box.
- 4) Turn the small and large **FMS** Knob to enter the desired airport identifier.
- 5) Press the **ENT** Key to complete the airport selection.
- 6) Turn the large **FMS** Knob to select the Approach Box.
- 7) Turn the small **FMS** Knob to show the approach chart selection choices.
- 8) Turn either **FMS** Knob to scroll through the available charts.
- 9) Press the **ENT** Key to complete the chart selection.

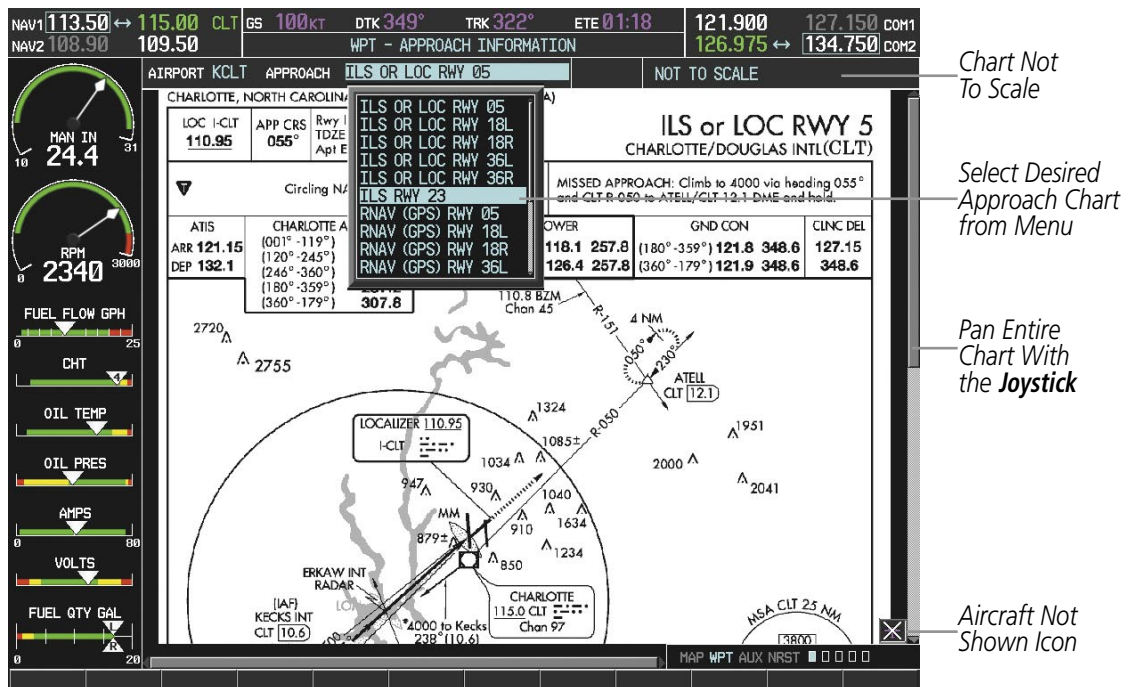

Figure 8-40 Approach Information Page, Chart Selection

While the APPROACH Box is selected using the **FMS** Knob, the G1000 softkeys are blank. Once the desired chart is selected, the chart scale can be changed and the chart can be panned using the **Joystick**. Pressing the **Joystick** centers the chart on the screen.

The aircraft symbol is not shown on FliteCharts. The Chart Scale Box displays a banner 'CHART NOT TO SCALE', and the Aircraft Not Shown Icon is displayed in the lower right corner of the screen.



Pressing the **CHRT** Softkey alternates between the FliteCharts diagram and the associated map in the WPT page group. In the example shown, the **CHRT** Softkey switches between the Charlotte, NC (KCLT) Airport Diagram and the navigation map on the WPT – Airport Information page.



Figure 8-41 CHRT Softkey, Airport Information Page

Pressing the **INFO** Softkey returns to the airport diagram when the view is on a different chart. If the displayed chart is the airport diagram, the **INFO** Softkey will have no effect.

Another source for additional airport information is from the INFO Box above the chart (Figure 8-41) or to the right of the chart (Figure 8-42) for certain airports. This information source is not related to the **INFO** Softkey. When the INFO Box is selected using the **FMS** Knob, the G1000 softkeys are blank. The Charlotte, NC airport has three additional charts offering information; the Airport Diagram, Alternate Minimums, and Take-off Minimums.



Figure 8-42 Airport Information Page, INFO View with Airport Information

In the example shown in Figure 8-42, 'TAKE OFF MINIMUMS' is selected. Pressing the **ENT** Key displays the Take-off Minimums and Departure Procedures Chart (Figure 8-43).

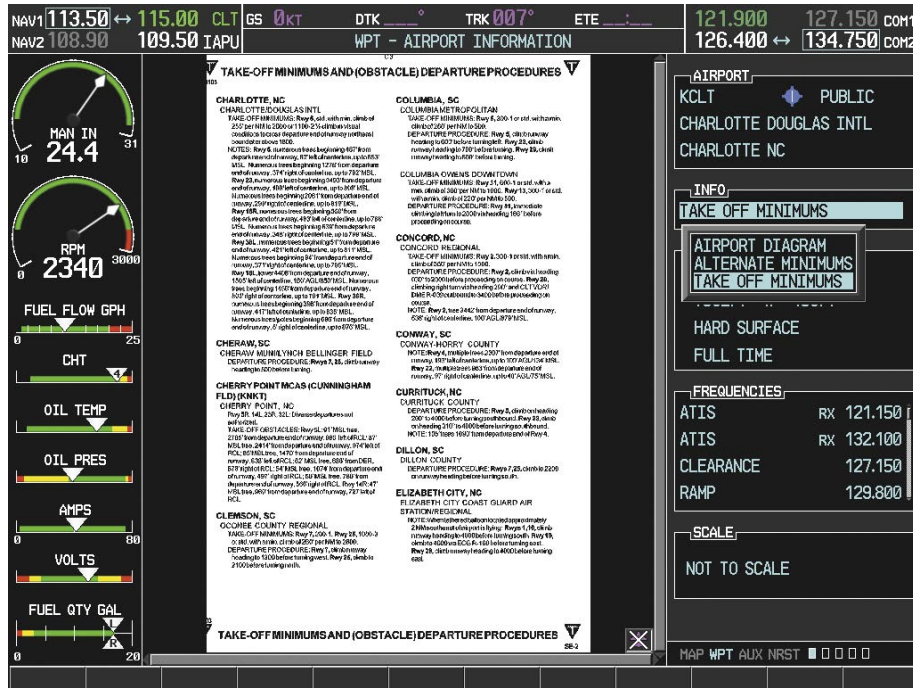

Figure 8-43 Airport Information Page, TAKE OFF MINIMUMS Selected from INFO View

Pressing the **DP** Softkey displays the Departure Procedure Chart if available.

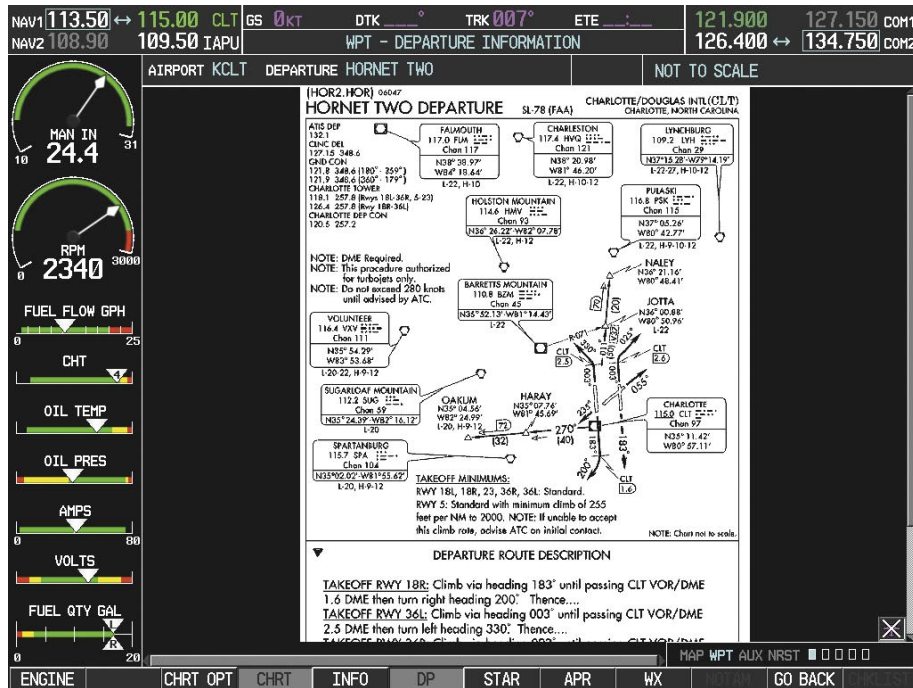

Figure 8-44 Departure Information Page

Pressing the **STAR** Softkey displays the Standard Terminal Arrival Chart if available.

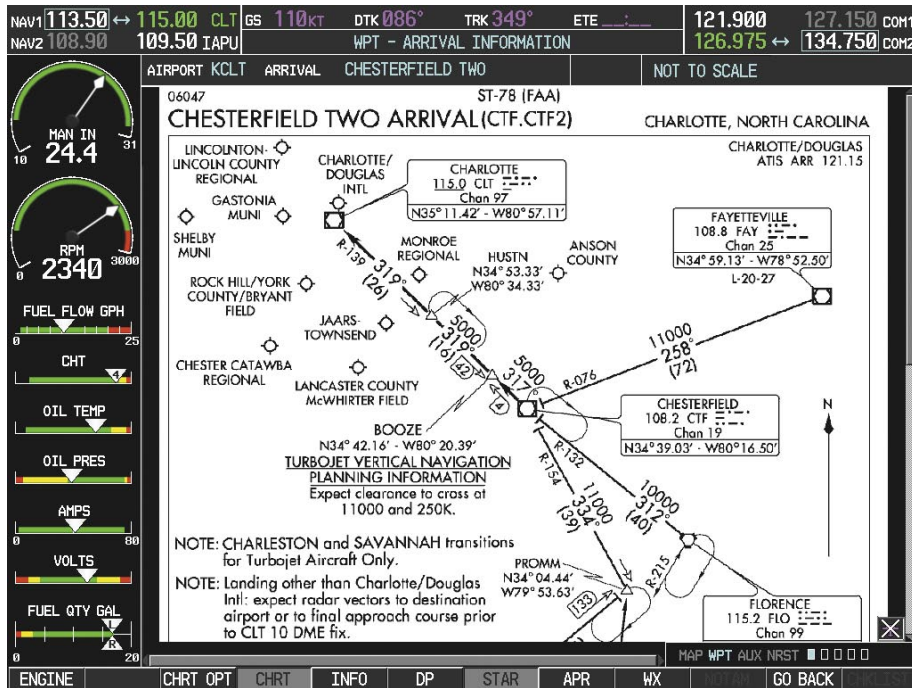

Figure 8-45 Arrival Information Page

Pressing the **APR** Softkey displays the approach chart for the airport if available.

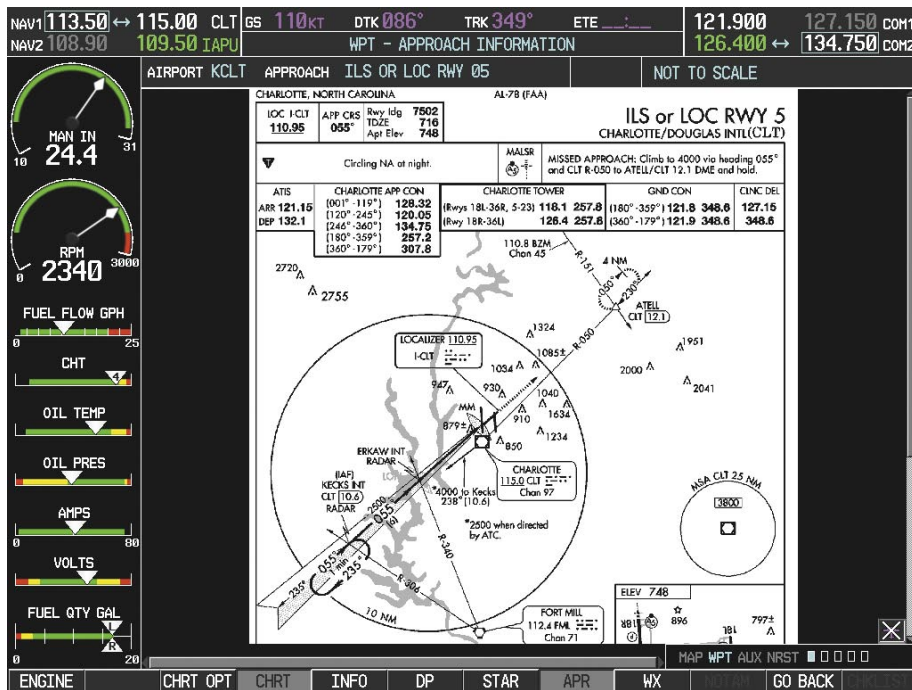

Figure 8-46 Approach Information Page

Pressing the **WX** Softkey shows the airport weather frequency information, when available, and includes weather data such as METAR and TAF from the XM Data Link Receiver. Weather information is available only when an XM Data Link Receiver is installed and the XM Weather subscription is current.

**Selecting Additional Information:**

- 1) While viewing the Airport Taxi Diagram, press the **WX** Softkey to display the information windows (AIRPORT, INFO).
- 2) Press the **FMS** Knob to activate the cursor.
- 3) Turn the large **FMS** Knob to highlight the INFO Box.
- 4) Turn the small **FMS** Knob to select the INFO Box choices. When the INFO Box is selected the G1000 softkeys are blank. If multiple choices are available, scroll to the desired choice with the large **FMS** Knob and press the **ENT** Key to complete the selection.
- 5) Press the **FMS** Knob again to deactivate the cursor.



**Figure 8-47 Weather Information Page**

Pressing the **GO BACK** Softkey reverts to the previous page (Navigation Map Page or Flight Plan Page).

## CHART OPTIONS

Pressing the **CHRT OPT** Softkey displays the next level of softkeys, the chart options level (Figure 8-35). Pressing the **ALL** Softkey shows the entire chart on the screen.



Figure 8-48 Airport Information Page, ALL View Selected

Pressing the **FIT WIDTH** Softkey fits the width of the chart in the display viewing area. In the example shown, the zoomed-in chart is replaced with the full width chart.

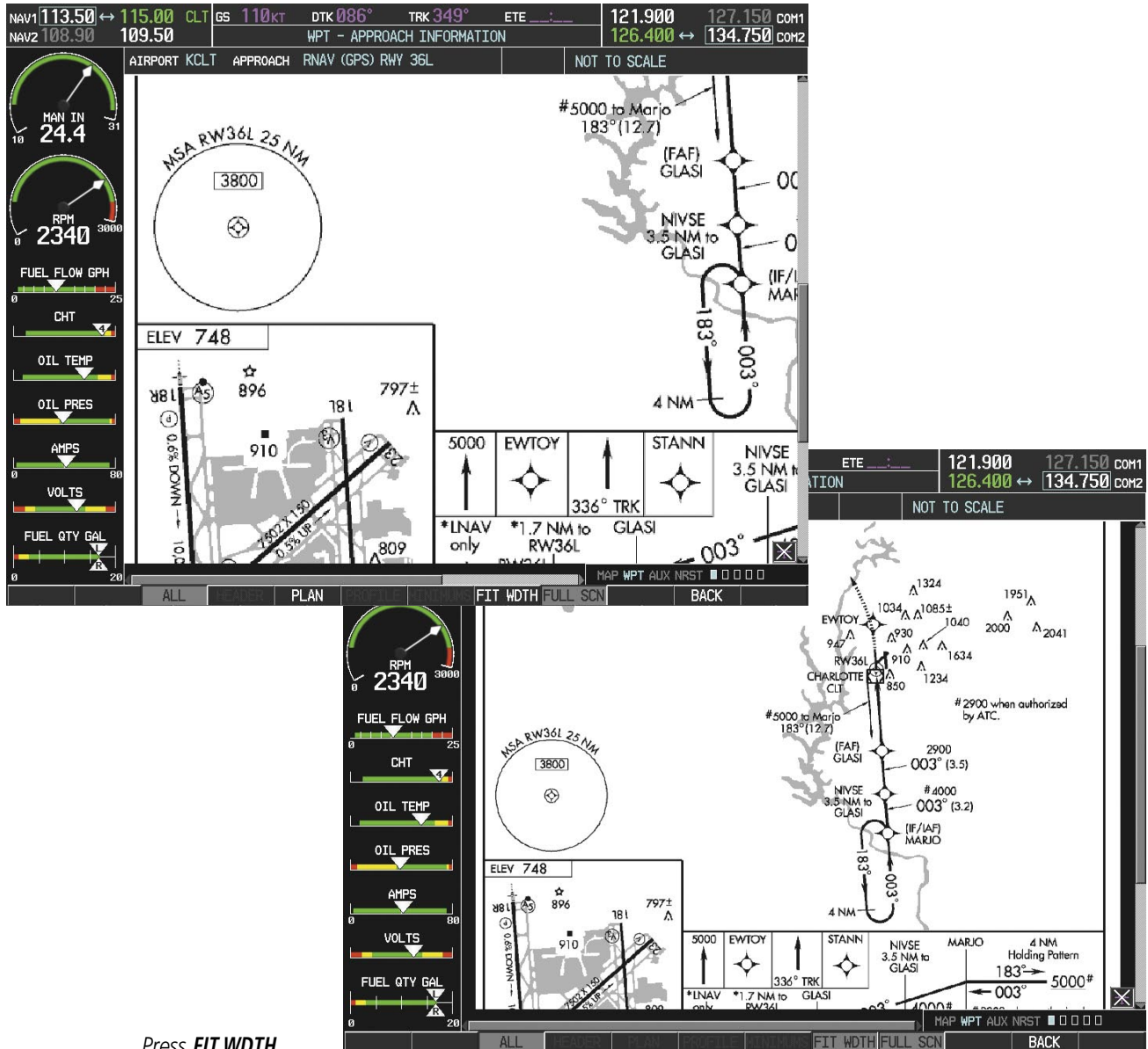

Press **FIT WIDTH** Softkey to Show Full Chart Width

**Figure 8-49** Approach Information Page, FIT WIDTH Softkey Selected

Pressing the **FULL SCN** Softkey alternates between removing and replacing the data window to the right.



Figure 8-50 Airport Information Page, Full Screen and Info Window

Pressing the **BACK** Softkey, or waiting for 45 seconds reverts to the chart selection softkeys.



## DAY/NIGHT VIEW

FliteCharts can be displayed on a white or black background for day or night viewing. The Day View offers a better presentation in a bright environment. The Night View gives a better presentation for viewing in a dark environment. When the CHART SETUP Box is selected the G1000 softkeys are blank.

### Selecting Day, Night, or Automatic View:

- 1) While viewing a terminal chart press the **MENU** Key to display the Page Menu OPTIONS.
- 2) Turn the large **FMS** Knob to highlight the 'Chart Setup' Menu Option and press the **ENT** Key.

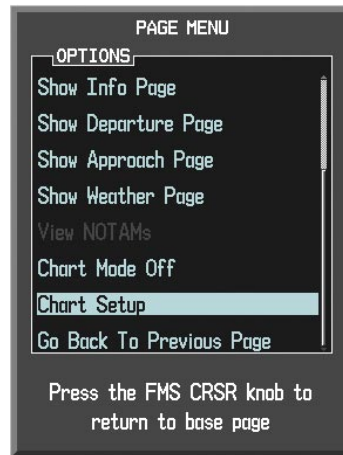

Figure 8-51 Waypoint Information Page, OPTIONS Menu

- 3) Turn the large **FMS** Knob to move between the 'FULL SCREEN' and 'COLOR SCHEME' Options.
- 4) Turn the small **FMS** Knob to choose between the 'On' and 'Off' Full Screen Options.
- 5) Turn the small **FMS** Knob to choose between 'Day', 'Auto', and 'Night' Options.
- 6) In Auto Mode, turn the large **FMS** Knob to select the percentage field and change percentage with the small **FMS** Knob. The percentage of change is the day/night crossover point based on backlighting intensity.



**NOTE:** Once an adjustment is made to the percentage field in Auto mode, the chart must be redrawn (zoomed in or out, or another chart selected) before the switch from Day to Night is seen.

- 7) Press the **FMS** Knob when finished to remove the Chart Setup Menu.

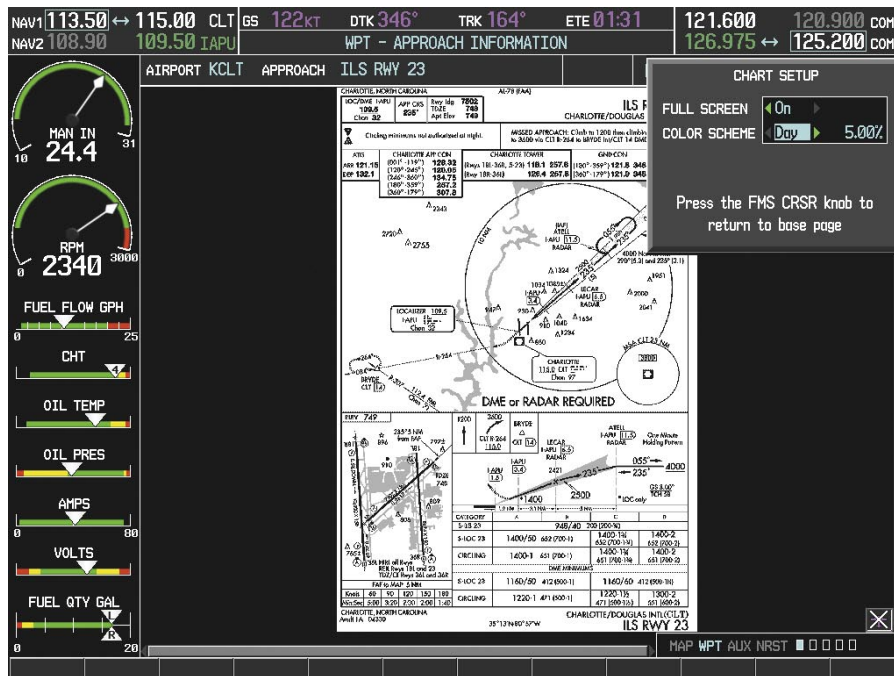







Figure 8-52 Approach Information Page, Day View



Figure 8-53 Approach Information Page, Night View

**FLITECHARTS CYCLE NUMBER AND EXPIRATION DATE**

FliteCharts data is revised every 28 days. Charts are still viewable during a period that extends from the cycle expiration date to the disables date. FliteCharts is disabled 180 days after the expiration date and are no longer available for viewing upon reaching the disables date. When turning on the G1000, the Power-up Page indicates any of five different possible criteria for chart availability. These indications are whether the databases are not configured, not available, current, out of date, or disabled. See Table 8-2 for the various FliteCharts Power-up Page displays and the definition of each.

| Power-up Page Display  | Definition   |
|--|--|
|   | Blank Line. G1000 system is not configured for FliteCharts. Contact a Garmin-authorized service center for configuration.                              |
|   | System is configured for FliteCharts but no chart database is installed. Refer to Updating Garmin Databases in Appendix B for the FliteCharts database |
|   | Normal operation. FliteCharts database is valid and within current cycle.  |
|   | FliteCharts database is beyond the expiration date, but still within the 180 day viewing period.   |
|  | FliteCharts database has timed out. Database is beyond 180 days after expiration date. FliteCharts database is no longer available for viewing.        |

**Table 8-2 FliteCharts Power-up Page Annunciations and Definitions**

Examples of four possible Power-up Page messages are shown in Figure 8-54. 'FliteCharts Expires' plus a date in white, indicates the chart database is current. 'Chart data is out of date!' in yellow, indicates charts are still viewable, but approaching the disable date.

When the 180 day grace period has expired, 'Chart data is disabled.' in yellow indicates that the FliteCharts database has expired and is no longer viewable. 'Chart Data: N/A' appears in white if no FliteCharts data is available on the database card or no database card is inserted.



*FliteCharts Database is Current and Available*



*FliteCharts Database is Expired but Still Available*



*FliteCharts Database is Disabled*



*FliteCharts Database is Not Available*

Figure 8-54 FliteCharts Power-up Page Messages



**NOTE:** A subdued softkey label indicates the function is disabled.

FliteCharts time critical information can also be found on the AUX - System Status page. The FliteCharts database 'REGION', 'CYCLE' number, 'EFFECTIVE', 'EXPIRES', and 'DISABLES' dates of the subscription appear in either blue or yellow text. Dates shown in blue are current data. Dates shown in yellow indicate the data is not within the current subscription period.

FliteCharts becomes inoperative 180 days after the FliteCharts 'EXPIRES' date is reached, and is no longer available for viewing. This date is shown as the 'DISABLES' date. After the disable date the **SHW CHRT** Softkey label appears subdued and is unavailable until a revised issue of FliteCharts is installed.

Press the **DBASE** Softkey for scrolling through the database information. Scroll through the database with the **FMS** knob or **ENT** Key.

The FliteCharts database cycle number shown in Figure 8-55, '0604' is broken down as follows:

06 – Indicates the year 2006

04 – Indicates the fourth issue of the FliteCharts database for the year

The FliteCharts 'EFFECTIVE' date "13-APR-06" is the first date that this database is current.

The FliteCharts 'EXPIRES' date "11-MAY-06" is the last date that this database is current.

The 'DISABLES' date "07-NOV-06" is the date that this database becomes inoperative.



**Figure 8-55 AUX – System Status Page, FliteCharts Current and Available**

The FliteCharts database is provided from Garmin. Refer to Updating Garmin Databases in Appendix B for instructions on revising the FliteCharts database.

The other three possible AUX - System Status page conditions are shown in Figure 8-56. The 'EXPIRES' date, in yellow, is the revision date for the next database cycle. The 'DISABLES' date, in yellow, is the date that this database cycle is no longer viewable. 'REGION' and 'CYCLE' 'NOT AVAILABLE' in blue, indicate that FliteCharts database is not available on the database card or no database card is inserted.

| DATABASE  |                |
|---|----------------|
| VERSION   | 2.08           |
| CYCLE   | 06B3           |
| EFFECTIVE                                       | 08-JUN-06      |
| EXPIRES   | 03-AUG-06      |
| Copyright 2006 Garmin Ltd. or its subsidiaries  |                |
| CHART   |                |
| CHART   | FliteCharts    |
| REGION  | Test Worldwide |
| CYCLE   | 0604           |
| EFFECTIVE                                       | 13-APR-06      |
| EXPIRES   | 11-MAY-06      |
| DISABLES  | 07-NOV-06      |
| Copyright 2006. Garmin Ltd. or its subsidiaries |                |

*FliteCharts Database has Expired, but is not Disabled*

| DATABASE  |                |
|---|----------------|
| VERSION   | 2.08           |
| CYCLE   | 06B3           |
| EFFECTIVE                                       | 08-JUN-06      |
| EXPIRES   | 03-AUG-06      |
| Copyright 2006 Garmin Ltd. or its subsidiaries  |                |
| CHART   |                |
| CHART   | FliteCharts    |
| REGION  | Test Worldwide |
| CYCLE   | 0604           |
| EFFECTIVE                                       | 13-APR-06      |
| EXPIRES   | 11-MAY-06      |
| DISABLES  | 07-NOV-06      |
| Copyright 2006. Garmin Ltd. or its subsidiaries |                |

*FliteCharts Database is Disabled*

| DATABASE                                       |               |
|--|---------------|
| VERSION  | 2.08          |
| CYCLE  | 06B3          |
| EFFECTIVE                                      | 08-JUN-06     |
| EXPIRES  | 03-AUG-06     |
| Copyright 2006 Garmin Ltd. or its subsidiaries |               |
| CHART  |               |
| CHART  | FliteCharts   |
| REGION   | NOT AVAILABLE |
| CYCLE  | NOT AVAILABLE |
| EFFECTIVE                                      | -- -- -- --   |
| EXPIRES  | -- -- -- --   |
| DISABLES                                       | -- -- -- --   |

*System is Configured for FliteCharts but Database is not Installed*

*FliteCharts Database is Not Available*

**Figure 8-56 AUX – System Status Page, FliteCharts Expired, FliteCharts Disabled, FliteCharts Not Available**

## 8.4 XM RADIO ENTERTAINMENT (OPTIONAL)



**NOTE:** Refer to the Hazard Avoidance Section for information about XM Weather products.

The optional XM Radio entertainment feature of the GDL 69A Data Link Receiver is available for the pilot's and passengers' enjoyment. The GDL 69A can receive XM Satellite Radio® entertainment services at any altitude throughout the Continental U.S. Entertainment audio is not available on the GDL 69 Data Link Receiver.

XM Satellite Radio offers a variety of radio programming over long distances without having to constantly search for new stations. Based on signals from satellites, coverage far exceeds land-based transmissions. XM Satellite Radio services are subscription-based. For more information on specific service packages, visit [www.xmradio.com](http://www.xmradio.com).

### ACTIVATING XM SATELLITE RADIO SERVICES

The service is activated by providing XM Satellite Radio with either one or two coded IDs, depending on the equipment. Either the Audio Radio ID or the Data Radio ID, or both, must be provided to XM Satellite Radio to activate the entertainment subscription.

It is not required to activate both the entertainment and weather service subscriptions with the GDL 69A. Either or both services can be activated. XM Satellite Radio uses one or both of the coded IDs to send an activation signal that, when received by the GDL 69A, allows it to play entertainment programming.

These IDs are located:

- On the label on the back of the Data Link Receiver
- On the XM Information Page on the MFD (Figure 8-57)
- On the XM Satellite Radio Activation Instructions included with the unit (available at [www.garmin.com](http://www.garmin.com), P/N 190-00355-04)

Contact the installer if the Data Radio ID and the Audio Radio ID cannot be located.



**NOTE:** The **LOCK** Softkey on the XM Information Page (Auxiliary Page Group) is used to save GDL 69A activation data when the XM services are initially set up. It is not used during normal XM Radio operation, but there should be no adverse effects if inadvertently pressed during flight. Refer to the GDL 69/69A XM Satellite Radio Activation Instructions (190-00355-04, Rev F or later) for further information.

**Activating the XM Satellite Radio services:**

- 1) Contact XM WX Satellite Radio through the email address listed on their website (www.xmradio.com) or by the customer service phone number listed on the website. Follow the instructions provided by XM Satellite Radio services.
- 2) Select the Auxiliary Page Group.
- 3) Select the next to last page in the AUX Page Group.
- 4) Press the **INFO** Softkey to display the XM Information Page.
- 5) Verify that the desired services are activated.
- 6) Press the **LOCK** Softkey.
- 7) Turn the large **FMS** Knob to highlight YES.
- 8) To complete activation, press the **ENT** Key.



Figure 8-57 XM Information Page

If XM weather services have not been activated, all the weather product boxes are cleared on the XM Information Page and a yellow Activation Required message is displayed in the center of the Weather Data Link Page (Map Page Group). The Service Class refers to the groupings of weather products available for subscription.



**USING XM RADIO**

The XM Radio Page provides information and control of the audio entertainment features of the XM Satellite Radio.

**Selecting the XM Radio Page:**

- 1) Turn the large **FMS** Knob to select the Auxiliary Page Group.
- 2) Turn the small **FMS** Knob to select the displayed AUX - XM Information Page.
- 3) Press the **RADIO** Softkey to show the XM Radio Page where audio entertainment is controlled.

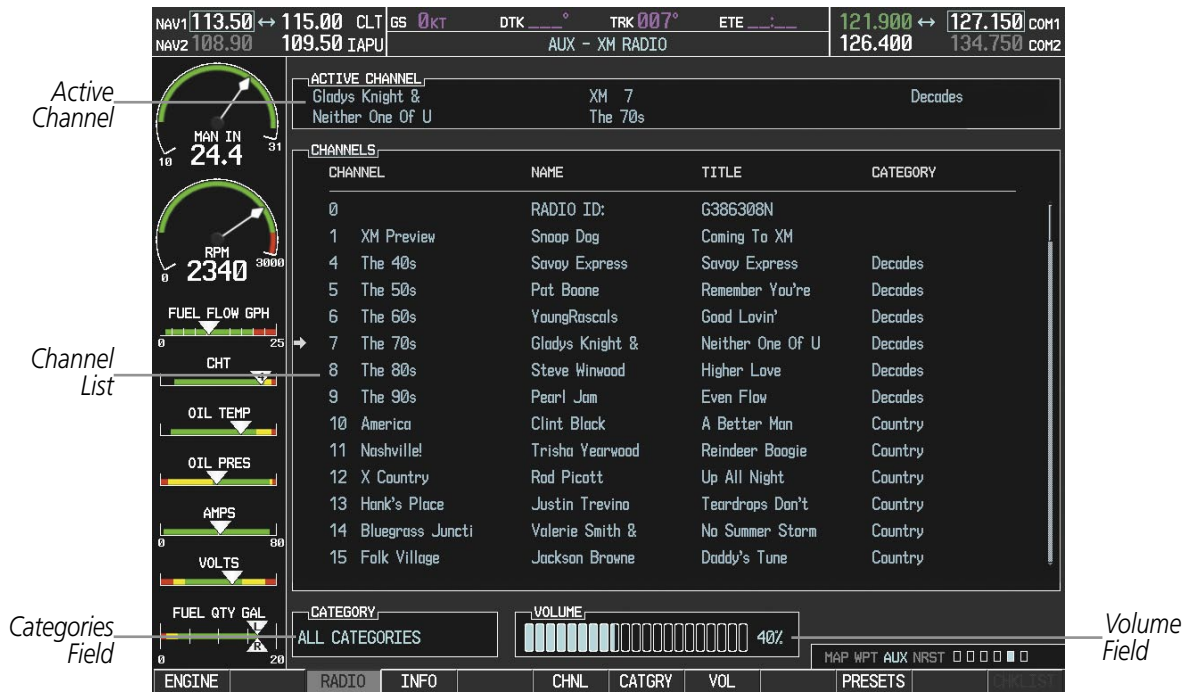

**Figure 8-58 XM Radio Page**

## ACTIVE CHANNEL AND CHANNEL LIST

The Active Channel Box on the XM Radio Page displays the currently selected channel that the XM Radio is using.

The Channels List Box of the XM Radio Page shows a list of the available channels for the selected category. Channels can be stepped through one at a time or may be selected directly by channel number.

### Stepping through channels one at a time:

1) While on the XM Radio Page, press the **CHNL** Softkey.

**OR:**

- 2) Press the **FMS** Knob to highlight the channel list and turn the large **FMS** Knob to scroll through the channels.
- 3) Press the **CH +** Softkey to go up through the list in the Channel Box, or move down the list with the **CH –** Softkey.

### Selecting a channel directly:

- 1) While on the XM Radio Page, press the **CHNL** Softkey.
- 2) Press the **DIR CH** Softkey. The channel number in the Active Channel Box will be highlighted.
- 3) Press the numbered softkeys located on the bottom of the display to directly select the desired channel number.
- 4) Press the **ENT** Key to activate the selected channel.

## CATEGORY

The Category Box of the XM Radio Page displays the currently selected category of audio. Categories of channels such as jazz, rock, or news can be selected to list the available channels for a type of music or other contents. One of the optional categories is 'PRESETS' to view channels that have been programmed.

### Selecting a category:

- 1) Press the **CATGRY** Softkey on the XM Radio Page.
- 2) Press the **CAT +** and **CAT -** Softkeys to cycle through the categories.

### OR:

- 3) Turn the small **FMS** Knob to display the 'Categories' list. Highlight the desired category with the small **FMS** Knob and press the **ENT** Key. Selecting 'All Categories' places all channels in the list.



Figure 8-59 Categories List

## PRESETS

Up to 15 channels from any category can be assigned a preset number. The preset channels are selected by pressing the **PRESETS** and **MORE** Softkeys. Then the preset channel can be selected directly and added to the channel list for the Presets category.

### Setting a preset channel number:

- 1) On the XM Radio Page, while listening to an Active Channel that is wanted for a preset, press the **PRESETS** Softkey to access the first five preset channels (**PS1 - PS5**).
- 2) Press the **MORE** Softkey to access the next five channels (**PS6 – PS10**), and again to access the last five channels (**PS11 – PS15**). Pressing the **MORE** Softkey repeatedly cycles through the preset channels.
- 3) Press any one of the (**PS1 - PS15**) softkeys to assign a number to the active channel.
- 4) Press the **SET** Softkey on the desired channel number to save the channel as a preset.

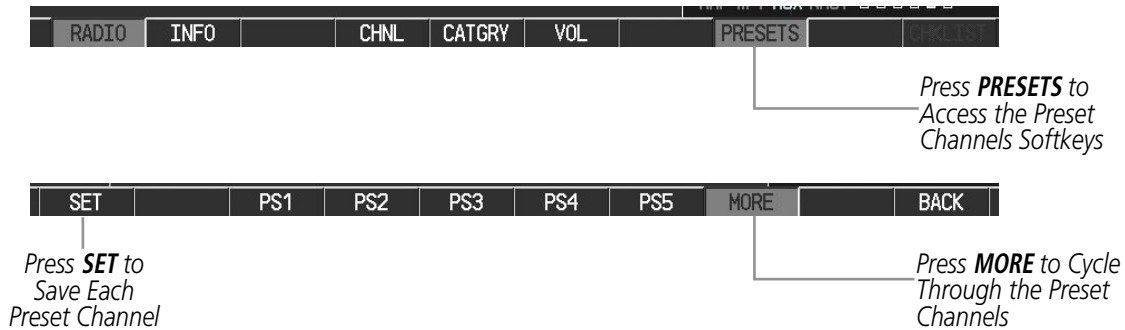

Figure 8-60 Accessing and Selecting XM Preset Channels

Pressing the **BACK** Softkey, or waiting during 45 seconds of softkey inactivity, returns the system to the top level softkeys.

## VOLUME

Radio volume is shown as a percentage. Volume level is controlled by pressing the **VOL** Softkey, which brings up the **MUTE** Softkey and the volume increase and decrease softkeys.

### Adjusting the volume:

- 1) With the XM Radio Page displayed, press the **VOL** Softkey.
- 2) Press the **VOL –** Softkey to reduce volume or press the **VOL +** Softkey to increase volume. (Once the **VOL** Softkey is pressed, the volume can also be adjusted using the small **FMS** Knob.)
- 3) Press the **MUTE** Softkey to mute the audio. Press the **MUTE** Softkey again to un-mute the audio.

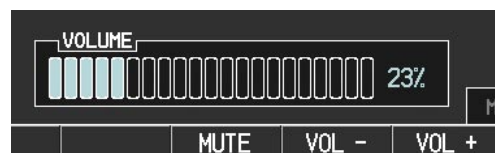

Figure 8-61 Volume Control

## AUTOMATIC AUDIO MUTING

XM Radio audio is muted automatically when the aircraft groundspeed exceeds approximately 30 knots and the airspeed is less than approximately 80 knots. The audio will not be unmuted automatically. The audio must be manually unmuted once the aircraft is airborne and outside the applicable speed range. Automatic Audio Muting has been implemented to meet regulatory requirements that the aural stall warning be heard.

When the aircraft is operating within the automute airspeed range, the **MUTE** Softkey and the volume softkeys are subdued, and the Unmute selection of the Page Menu is unavailable, preventing the audio from being unmuted at this time.

Audio availability conforms to the following three states:

- Audio is available on the ground until the aircraft exceeds 30 knots
- Audio is automatically muted (not available) from Airborne Status up to 80 knots airspeed
- Audio is available when airspeed is over 80 knots

### Unmuting XM audio:

- 1) With the XM Radio Page displayed, press the **VOL** Softkey.
- 2) Press the **MUTE** Softkey to restore (unmute) XM Audio.



Figure 8-62 Unmuting XM Audio Using Softkeys

OR:

- 3) While on either the XM – Radio Page or the XM – Information Page, press the **MENU** Key to display the PAGE MENU.
- 4) Turn the large **FMS** Knob to select the Unmute option.
- 5) Press the **ENT** Key to restore (unmute) XM Audio.

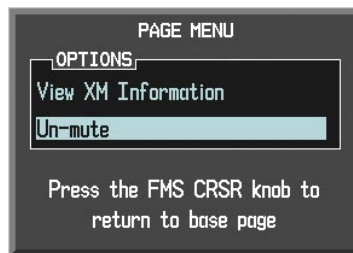

Figure 8-63 Unmuting XM Audio with the Page Menu

## 8.5 ABNORMAL OPERATION

### GDL 69/69A DATA LINK RECEIVER TROUBLESHOOTING

Some quick troubleshooting steps listed below can be performed to find the possible cause of a failure.

- Ensure the owner/operator of the aircraft in which the Data Link Receiver is installed has subscribed to XM
- Ensure the XM subscription has been activated
- Perform a quick check of the circuit breakers to ensure that power is applied to the Data Link Receiver

For troubleshooting purposes, check the LRU Information Box on the AUX - System Status Page for Data Link Receiver (GDL 69/69A) status, serial number, and software version number. If a failure has been detected in the GDL 69/69A the status will be marked with a red X.

#### Selecting the System Status Page:

- 1) Turn the large **FMS** Knob to select the AUX Page Group.
- 2) Turn the small **FMS** Knob to select the System Status Page (the last page in the AUX Page Group).

| LRU INFO     |        |               |         |
|--------------|--------|---------------|---------|
|              | STATUS | SERIAL NUMBER | VERSION |
| CO GUARDIAN  | ✓      |               | 7.00    |
| COM1         | ✓      |               | 7.00    |
| COM2         | ✓      | 27000006      | 2.02d   |
| GDC1         | ✓      | 47801548      | 1.05    |
| GDL69        | ✓      | 47801373      | 1.05    |
| GEA1         | ✓      | 47750372      | 3.02.00 |
| GIA1         | ✓      | 46701911      | 2.07    |
| GIA2         | ✓      | 46701913      | 2.07    |
| GMA1         | ✓      | FFFFFFFF      | 1.02    |
| GMU1         | ✓      | 68500319      | 1.02    |
| GPS1         | ✓      | 48400000      | 3.01    |
| GPS2         | ✓      | 48400001      | 3.01    |
| GRS1         | ✓      |               | 2.02d   |
| GS1          | ✓      | 47500593      | 2.01    |
| GS2          | ✓      | 47500607      | 2.01    |
| GSA PTCH CTL | ✓      | AB0062149     | 2.3     |

Figure 8-64 LRU Information Window on System Status Page

If a failure still exists, the following messages may provide insight as to the possible problem:

| Message                          | Message Location   | Description  |
|----------------------------------|--|--|
| <b>CHECK ANTENNA</b>             | XM Radio Page - active channel field   | Data Link Receiver antenna error; service required             |
| <b>UPDATING</b>                  | XM Radio Page - active channel field   | Data Link Receiver updating encryption code                    |
| <b>NO SIGNAL</b>                 | XM Radio Page - active channel field<br>Weather Datalink Page - center of page | Loss of signal; signal strength too low for receiver           |
| <b>LOADING</b>                   | XM Radio Page - active channel field   | Acquiring channel audio or information                         |
| <b>OFF AIR</b>                   | XM Radio Page - active channel field   | Channel not in service   |
| <b>---</b>                       | XM Radio Page - active channel field   | Missing channel information                                    |
| <b>WEATHER DATA LINK FAILURE</b> | Weather Datalink Page - center of page   | No communication from Data Link Receiver within last 5 minutes |
| <b>ACTIVATION REQUIRED</b>       | Weather Datalink Page - center of page   | XM subscription is not activated                               |

**Table 8-3 GDL 69/69A Data Link Receiver Error Messages**

**BLANK PAGE**



# ANNUNCIATIONS AND ALERTS



**NOTE:** *The Aircraft Flight Manual (AFM) supersedes information found in this document.*

The G1000 Alerting System conveys alerts using the following:

- **Annunciation Window:** The Annunciation Window displays abbreviated annunciation text. Text color is based on alert levels described in the following section. The Annunciation Window is located to the right of the Altimeter and Vertical Speed Indicator. All aircraft annunciations can be displayed simultaneously in the Annunciation Window. A white horizontal line separates annunciations that are acknowledged from annunciations that are not yet acknowledged. Higher priority annunciations are displayed towards the top of the window.
- **Alerts Window:** The Alerts Window displays text messages for up to 64 prioritized alert messages. Pressing the **ALERTS** Softkey displays the Alerts Window. Pressing the **ALERTS** Softkey a second time removes the Alerts Window from the display. When the Alerts Window is displayed, the **FMS** Knob can be used to scroll through the alert message list.
- **Softkey Annunciation:** During certain alerts, the **ALERTS** Softkey may appear as a flashing annunciation to accompany an alert. The **ALERTS** Softkey assumes a new label consistent with the alert level (WARNING, CAUTION, or ADVISORY). By selecting the softkey when flashing an annunciation, the alert is acknowledged. The softkey label then returns to **ALERTS**. If alerts are still present, the **ALERTS** label is displayed in white with black text. Selecting the **ALERTS** Softkey a second time views the alert text messages.
- **System Annunciations:** Typically, a large red 'X' appears over instruments whose information is supplied by a failed Line Replaceable Unit (LRU). See the G1000 System Annunciations Section for more information.

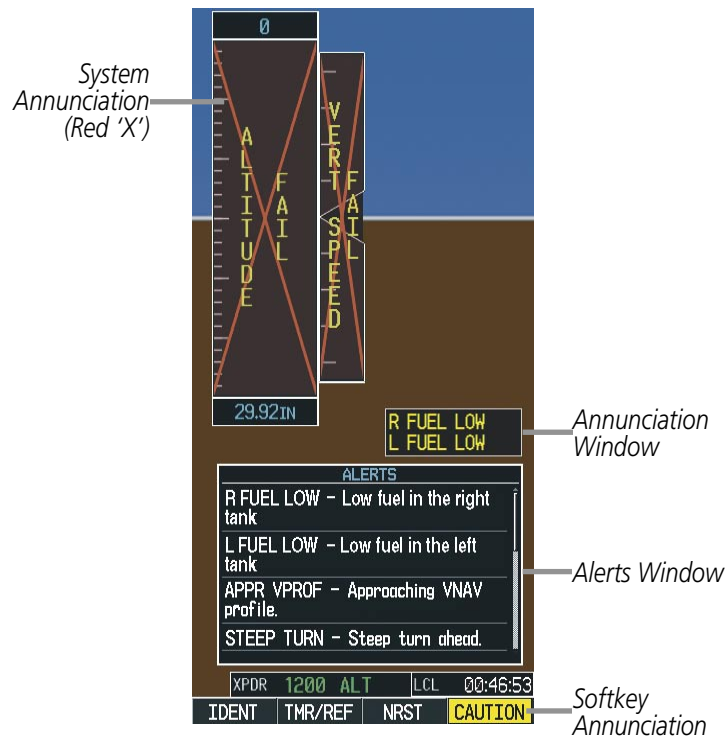

Figure A-1 G1000 Alerting System

- **Audio Alerting System:** The G1000 System issues audio alert tones when specific system conditions are met. See the Alert Level Definitions Section for more information. The annunciation tone may be tested from the AUX - System Status Page.

**Testing the system annunciation tone:**

- 1) Use the **FMS** Knob to select the AUX - System Status Page.
- 2) Select the **ANN TEST** Softkey.

**OR:**

- a) Press the **MENU** Key.
- b) Highlight 'Enable Annunciator Test Mode' and press the **ENT** Key.



*Press to Test Annunciation Tone*

**Figure A-2 System Status Page, Annunciation Tone Testing**

## ALERT LEVEL DEFINITIONS

The G1000 Alerting System, as installed in Diamond DA40/40F aircraft, uses three alert levels.

- **WARNING:** This level of alert requires immediate attention.

Warning alert text is shown in red in the Annunciation Window and is accompanied by a continuous chime and a flashing 'WARNING' Softkey annunciation (see Figure A-2). Pressing the **WARNING** Softkey acknowledges the presence of the warning alert and stops the aural chime.

- **CAUTION:** This level of alert indicates the existence of abnormal conditions on the aircraft that may require intervention.

Caution alert text is shown in yellow in the Annunciation Window and is accompanied by a single chime and a flashing 'CAUTION' Softkey annunciation (see Figure A-2). Pressing the **CAUTION** Softkey acknowledges the presence of the caution alert.

- **ANNUNCIATION OR MESSAGE ADVISORY:** This level of alert provides general information.

Annunciation alert text is shown in white in the Annunciation Window; no aural tone is generated. An annunciation alert is accompanied by a flashing **ADVISORY** Softkey annunciation (see Figure A-2). Pressing the **ADVISORY** Softkey acknowledges the presence of the annunciation alert.

Message advisory alerts do not issue annunciations in the Annunciation Window. Instead, message advisory alerts only issue a flashing 'ADVISORY' Softkey annunciation (see Figure A-2). Selecting the **ADVISORY** Softkey acknowledges the presence of the message advisory alert and displays the alert text message in the Alerts Window.



Figure A-3 Softkey Annunciation (ALERTS Softkey Labels)

## AIRCRAFT ALERTS

The following alerts are configured specifically for the Diamond DA40/40F. Red annunciation window text signifies warnings and yellow, cautions. See the Aircraft Flight Manual Supplement (AFMS) for recommended pilot actions.

| Annunciation Window Text | Alerts Window Message  | Audio Alert           |
|--------------------------|--|-----------------------|
| <b>OIL PRES LO</b>       | Oil pressure is below 25 psi.                                      | Continuous Aural Tone |
| <b>FUEL PRES LO*</b>     | Fuel pressure is below 14 psi.                                     |                       |
| <b>FUEL PRES HI*</b>     | Fuel pressure is greater than 35 psi.                              |                       |
| <b>ALTERNATOR</b>        | Alternator failed. Battery is only electrical source.              |                       |
| <b>STARTER ENGD</b>      | Starter is engaged.  |                       |
| <b>DOOR OPEN</b>         | Canopy and/or rear door is not closed and locked.                  |                       |
| <b>TRIM FAIL</b>         | Autopilot automatic trim is inoperative.                           | Single Aural Tone     |
| <b>L FUEL LOW</b>        | Left fuel quantity is less than 3 gallons.                         |                       |
| <b>R FUEL LOW</b>        | Right fuel quantity is less than 3 gallons                         |                       |
| <b>LOW VOLTS</b>         | On-board voltage is below 24 V.                                    |                       |
| <b>PITOT FAIL</b>        | Pitot heat is inoperative.   |                       |
| <b>PITOT OFF</b>         | Pitot heat is off.   | None                  |
| None                     | <b>PFD FAN FAIL</b> – The cooling fan for the PFD is inoperative.  |                       |
|                          | <b>MFD FAN FAIL</b> – The cooling fan for the MFD is inoperative.  |                       |
|                          | <b>GIA FAN FAIL</b> – The cooling fan for the GIAs is inoperative. |                       |

\* Values differ for the DA40F; refer to the Aircraft Flight Manual Supplement (AFMS) for more information.

## VOICE ALERTS

The following audio alerts are announced by the system using a voice of male or female gender (see the AUX - System Setup Page for the default configured voice gender; contact a Garmin-authorized service center to change the audio alert voice). If the optional Terrain Awareness and Warning System is installed, voice alerts are also generated (refer to the TAWS Alerts section).

| Voice Alert             | Alert Trigger  |
|-------------------------|--|
| "Minimums, Minimums"    | Issued when the aircraft transitions through the minimum descent altitude/decision height (MDA/DH) |
| "Vertical Track"        | Aircraft is one minute from Top of Descent - issued only when vertical navigation is enabled       |
| "Traffic"               | TIS voice alert - issued when a Traffic Advisory (TA) is issued                                    |
| "Traffic Not Available" | TIS voice alert - issued when the traffic system fails or cannot communicate                       |

**G1000 SYSTEM ANNUNCIATIONS**

**NOTE:** Upon power-up, certain windows remain invalid as G1000 equipment begins to initialize. All windows should be operational within one minute of power-up. If any window continues to remain flagged, the G1000 System should be serviced by a Garmin-authorized repair facility.

When an LRU or an LRU function fails, a large red 'X' is typically displayed on windows associated with the failed data (refer to Figure B-1 for all possible flags and the responsible LRUs). Refer to the Aircraft Flight Manual (AFM) for additional information regarding pilot responses to these annunciations.

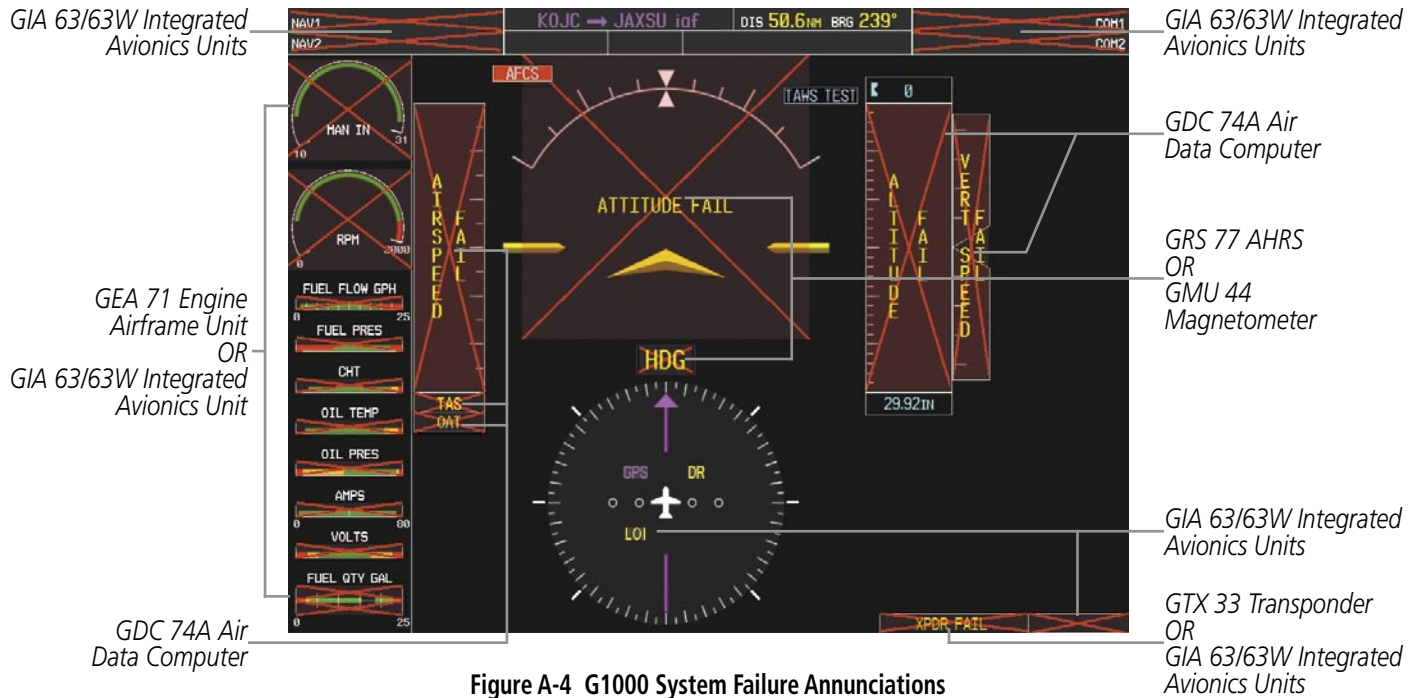













**Figure A-4 G1000 System Failure Annunciations**

The status of detected LRUs can be checked on the AUX - System Status Page (Figure A-2). Active LRUs are indicated by green check marks; failed, by red 'X's. Failed LRUs should be noted and a service center or Garmin-authorized dealer informed.

**Viewing LRU information:**

- 1) Use the **FMS** Knob to select the AUX - System Status Page.
- 2) To place the cursor in the 'LRU Info' Box,
  - a) Select the **LRU** Softkey.
  - OR:**
  - a) Press the **MENU** Key.
  - b) With 'Select LRU Window' highlighted, press the **ENT** Key.
- 3) Use the **FMS** Knob to scroll through the box to view LRU status information.

| System Annunciation   | Comment  |
|---|--|
|    | Attitude and Heading Reference System is aligning.   |
|    | Display system is not receiving attitude information from the AHRS.  |
|    | AHRS calibration incomplete or configuration module failure.   |
|  | This annunciation is seen only when the autopilot is engaged. The annunciation indicates an AHRS monitor has detected an abnormal flight parameter, possibly caused by strong turbulence. In this case, the situation should correct itself within a few seconds. If there is an actual failure, a red "X" soon appears over the Attitude Indicator. |
|  | GPS information is either not present or is invalid for navigation use. Note that AHRS utilizes GPS inputs during normal operation. AHRS operation may be degraded if GPS signals are not present (see POH).   |

| System Annunciation  | Comment   |
|--|---|
|     | Display system is not receiving airspeed input from air data computer.  |
|     | Display system is not receiving vertical speed input from the air data computer.  |
|    | Display system is not receiving valid heading input from AHRS.  |
|    | Display system is not receiving altitude input from the air data computer.  |
|  | Display system is not receiving valid true airspeed information from air data computer.   |
|  | Display system is not receiving valid OAT information from air data computer.   |
|  | Display system is not receiving valid transponder information.  |
| Other Various Red X Indications  | A red 'X' through any other display field (such as engine instrumentation fields) indicates that the field is not receiving valid data. |

## G1000 SYSTEM MESSAGE ADVISORIES



**NOTE:** This section provides information regarding G1000 message advisories that may be displayed by the system. Knowledge of the aircraft, systems, flight conditions, and other existing operational priorities must be considered when responding to a message.

This section describes various G1000 System message advisories. Certain messages are issued due to an LRU or LRU function failure. Such messages are normally accompanied by a corresponding red 'X' annunciation as shown previously in the G1000 System Annunciations section.

### GDU 104X PRIMARY FLIGHT DISPLAY/MULTI FUNCTION DISPLAY

| Message Advisory  | Comments   |
|---|--|
| <b>DATA LOST</b> – Pilot stored data was lost. Recheck settings.    | The pilot profile data was lost. System reverts to default pilot profile and settings. The pilot may reconfigure the MFD & PFD with preferred settings, if desired.  |
| <b>XTALK ERROR</b> – A flight display crosstalk error has occurred. | The MFD and PFD are not communicating with each other. The G1000 system should be serviced.  |
| <b>PFD1 SERVICE</b> – PFD1 needs service. Return unit for repair.   | The PFD and/or MFD self-test has detected a problem. The G1000 system should be serviced.  |
| <b>MFD1 SERVICE</b> – MFD1 needs service. Return unit for repair.   |  |
| <b>MANIFEST</b> – PFD1 software mismatch, communication halted.     | The PFD and/or MFD has incorrect software installed. The G1000 system should be serviced.  |
| <b>MANIFEST</b> – MFD1 software mismatch, communication halted.     |  |
| <b>PFD1 CONFIG</b> – PFD1 config error. Config service req'd.       | The PFD configuration settings do not match backup configuration memory. The G1000 system should be serviced.  |
| <b>MFD1 CONFIG</b> – MFD1 config error. Config service req'd.       | The MFD configuration settings do not match backup configuration memory. The G1000 system should be serviced.  |
| <b>SW MISMATCH</b> – GDU software version mismatch. Xtalk is off.   | The MFD and PFD have different software versions installed. The G1000 system should be serviced.   |
| <b>PFD1 COOLING</b> – PFD1 has poor cooling. Reducing power usage.  | The PFD and/or MFD is overheating and is reducing power consumption by dimming the display. If problem persists, the G1000 system should be serviced.                |
| <b>MFD1 COOLING</b> – MFD1 has poor cooling. Reducing power usage.  |  |
| <b>PFD1 KEYSTK</b> – PFD1 [key name] is stuck.                      | A key is stuck on the PFD and/or MFD bezel. Attempt to free the stuck key by pressing it several times. The G1000 system should be serviced if the problem persists. |
| <b>MFD1 KEYSTK</b> – MFD1 [key name] is stuck.                      |  |
| <b>CNFG MODULE</b> – PFD1 configuration module is inoperative.      | The PFD1 configuration module backup memory has failed. The G1000 system should be serviced.   |
| <b>PFD1 VOLTAGE</b> – PFD1 has low voltage. Reducing power usage    | The PFD1 voltage is low. The G1000 system should be serviced.  |
| <b>MFD1 VOLTAGE</b> – MFD1 has low voltage. Reducing power usage    | The MFD voltage is low. The G1000 system should be serviced.   |

## DATABASES

| Message Advisory   | Comments   |
|--|--|
| <b>MFD1 DB ERR</b> – MFD1 aviation database error exists.              | The MFD and/or PFD detected a failure in the aviation database. Attempt to reload the aviation database. If problem persists, the G1000 system should be serviced.   |
| <b>PFD1 DB ERR</b> – PFD1 aviation database error exists.              |  |
| <b>MFD1 DB ERR</b> – MFD1 basemap database error exists.               | The MFD and/or PFD detected a failure in the basemap database.   |
| <b>PFD1 DB ERR</b> – PFD1 basemap database error exists.               |  |
| <b>MFD1 DB ERR</b> – MFD1 terrain database error exists.               | The MFD and/or PFD detected a failure in the terrain database. Ensure that the terrain card is properly inserted in display. Replace terrain card. If problem persists, The G1000 system should be serviced.       |
| <b>PFD1 DB ERR</b> – PFD1 terrain database error exists.               |  |
| <b>MFD1 DB ERR</b> – MFD1 obstacle database error exists.              | The MFD and/or PFD detected a failure in the obstacle database. Ensure that the data card is properly inserted. Replace data card. If problem persists, The G1000 system should be serviced.                       |
| <b>PFD1 DB ERR</b> – PFD1 obstacle database error exists.              |  |
| <b>MFD1 DB ERR</b> – MFD1 airport terrain database error exists.       | The MFD and/or PFD detected a failure in the airport terrain database. Ensure that the data card is properly inserted. Replace data card. If problem persists, The G1000 system should be serviced.                |
| <b>PFD1 DB ERR</b> – PFD1 airport terrain database error exists.       |  |
| <b>MFD1 DB ERR</b> – MFD1 Safe Taxi database error exists.             | The MFD and/or PFD detected a failure in the Safe Taxi database. Ensure that the data card is properly inserted. Replace data card. If problem persists, The G1000 system should be serviced.                      |
| <b>PFD1 DB ERR</b> – PFD1 Safe Taxi database error exists.             |  |
| <b>MFD1 DB ERR</b> – MFD1 Chartview database error exists.             | The MFD and/or PFD detected a failure in the ChartView database (optional feature). Ensure that the data card is properly inserted. Replace data card. If problem persists, The G1000 system should be serviced.   |
| <b>MFD1 DB ERR</b> – MFD1 FliteCharts database error exists.           | The MFD and/or PFD detected a failure in the FliteCharts database (optional feature). Ensure that the data card is properly inserted. Replace data card. If problem persists, The G1000 system should be serviced. |
| <b>DB MISMATCH</b> – Aviation database version mismatch. Xtalk is off. | The PFD and MFD have different aviation database versions installed. Crossfill is off. Install correct aviation database version in both displays.   |
| <b>DB MISMATCH</b> – Aviation database type mismatch. Xtalk is off.    | The PFD and MFD have different aviation database types installed (Americas, European, etc.). Crossfill is off. Install correct aviation database type in both displays.  |
| <b>DB MISMATCH</b> – Terrain database version mismatch.                | The PFD and MFD have different terrain database versions installed. Install correct terrain database version in both displays.   |
| <b>DB MISMATCH</b> – Terrain database type mismatch.                   | The PFD and MFD have different terrain database types installed. Install correct terrain database type in both displays.   |
| <b>DB MISMATCH</b> – Obstacle database version mismatch.               | The PFD and MFD have different obstacle database versions installed. Install correct obstacle database version in both displays.   |
| <b>DB MISMATCH</b> – Airport Terrain database mismatch.                | The PFD and MFD have different airport terrain databases installed. Install correct airport terrain database in both displays.   |



**GMA 1347 AUDIO PANEL**

| Message Advisory  | Comments  |
|---|---|
| <b>GMA1 FAIL</b> – GMA1 is inoperative.                           | The audio panel self-test has detected a failure. The audio panel is unavailable. The G1000 system should be serviced.  |
| <b>GMA1 CONFIG</b> – GMA1 config error. Config service req'd.     | The audio panel configuration settings do not match backup configuration memory. The G1000 system should be serviced.   |
| <b>MANIFEST</b> – GMA1 software mismatch, communication halted.   | The audio panel has incorrect software installed. The G1000 system should be serviced.  |
| <b>GMA1 SERVICE</b> – GMA1 needs service. Return unit for repair. | The audio panel self-test has detected a problem in the unit. Certain audio functions may still be available, and the audio panel may still be usable. The G1000 system should be serviced when possible. |

**GIA 63 INTEGRATED AVIONICS UNIT**

| Message   | Comments  |
|---|---|
| <b>GIA1 CONFIG</b> – GIA1 config error. Config service req'd.         | The GIA1 and/or GIA2 configuration settings do not match backup configuration memory. The G1000 system should be serviced.  |
| <b>GIA2 CONFIG</b> – GIA2 config error. Config service req'd.         |   |
| <b>GIA1 CONFIG</b> – GIA1 audio config error. Config service req'd.   | The GIA1 and/or GIA2 have an error in the audio configuration. The G1000 system should be serviced.   |
| <b>GIA2 CONFIG</b> – GIA2 audio config error. Config service req'd.   |   |
| <b>GIA1 COOLING</b> – GIA1 temperature too low.                       | The GIA1 and/or GIA2 temperature is too low to operate correctly. Allow units to warm up to operating temperature.  |
| <b>GIA2 COOLING</b> – GIA2 temperature too low.                       |   |
| <b>GIA1 COOLING</b> – GIA1 over temperature.                          | The GIA1 and/or GIA2 temperature is too high. If problem persists, the G1000 system should be serviced.   |
| <b>GIA2 COOLING</b> – GIA2 over temperature.                          |   |
| <b>GIA1 SERVICE</b> – GIA1 needs service. Return the unit for repair. | The GIA1 and/or GIA2 self-test has detected a problem in the unit. The G1000 system should be serviced.   |
| <b>GIA2 SERVICE</b> – GIA2 needs service. Return the unit for repair. |   |
| <b>MANIFEST</b> – GIA1 software mismatch, communication halted.       | The GIA1 and/or GIA 2 has incorrect software installed. The G1000 system should be serviced.  |
| <b>MANIFEST</b> – GIA2 software mismatch, communication halted.       |   |
| <b>COM1 TEMP</b> – COM1 over temp. Reducing transmitter power.        | The system has detected an over temperature condition in COM1 and/or COM2. The transmitter will operate at reduced power. If the problem persists, the G1000 system should be serviced. |
| <b>COM2 TEMP</b> – COM2 over temp. Reducing transmitter power.        |   |

## GIA 63 (CONT.)

| Message  | Comments   |
|--|--|
| <b>COM1 SERVICE</b> – COM1 needs service. Return unit for repair.      | The system has detected a failure in COM1 and/or COM2. COM1 and/or COM2 may still be usable. The G1000 system should be serviced when possible.  |
| <b>COM2 SERVICE</b> – COM2 needs service. Return unit for repair.      |  |
| <b>COM1 PTT</b> – COM1 push-to-talk key is stuck.                      | The COM1 and/or COM2 external push-to-talk switch is stuck in the enable (or “pressed”) position. Press the PTT switch again to cycle its operation. If the problem persists, the G1000 system should be serviced. |
| <b>COM2 PTT</b> – COM2 push-to-talk key is stuck.                      |  |
| <b>COM1 RMT XFR</b> – COM1 remote transfer key is stuck.               | The COM1 and/or COM2 transfer switch is stuck in the enabled (or “pressed”) position. Press the transfer switch again to cycle its operation. If the problem persists, the G1000 system should be serviced.        |
| <b>COM2 RMT XFR</b> – COM2 remote transfer key is stuck.               |  |
| <b>RAIM UNAVAIL</b> – RAIM is not available from FAF to MAP waypoints. | GPS satellite coverage is insufficient to perform Receiver Autonomous Integrity Monitoring (RAIM) from the FAF to the MAP waypoints.   |
| <b>LOI</b> – GPS integrity lost. Crosscheck with other NAVS.           | Loss of GPS integrity monitoring.  |
| <b>GPS NAV LOST</b> – Loss of GPS navigation. Insufficient satellites. | Loss of GPS navigation due to insufficient satellites.   |
| <b>GPS NAV LOST</b> – Loss of GPS navigation. Position error.          | Loss of GPS navigation due to position error.  |
| <b>GPS NAV LOST</b> – Loss of GPS navigation. GPS fail.                | Loss of GPS navigation due to GPS failure.   |
| <b>ABORT APR</b> – Loss of GPS navigation. Abort approach.             | Abort approach due to loss of GPS navigation.  |
| <b>TRUE APR</b> – True north approach. Change HDG reference to TRUE.   | Displayed after passing the first waypoint of a true north approach when the nav angle is set to ‘AUTO’.   |
| <b>GPS1 FAIL</b> – GPS1 is inoperative.                                | A failure has been detected in the GPS1 and/or GPS2 receiver. The receiver is unavailable. The G1000 system should be serviced.  |
| <b>GPS2 FAIL</b> – GPS2 is inoperative.                                |  |
| <b>GPS1 SERVICE</b> – GPS1 needs service. Return unit for repair.      | A failure has been detected in the GPS1 and/or GPS2 receiver. The receiver may still be available. The G1000 system should be serviced.  |
| <b>GPS2 SERVICE</b> – GPS2 needs service. Return unit for repair.      |  |
| <b>NAV1 SERVICE</b> – NAV1 needs service. Return unit for repair.      | A failure has been detected in the NAV1 and/or NAV2 receiver. The receiver may still be available. The G1000 system should be serviced.  |
| <b>NAV2 SERVICE</b> – NAV2 needs service. Return unit for repair.      |  |
| <b>NAV1 RMT XFR</b> – NAV1 remote transfer key is stuck.               | The remote NAV1 and/or NAV2 transfer switch is stuck in the enabled (or “pressed”) state. Press the transfer switch again to cycle its operation. If the problem persists, the G1000 system should be serviced.    |
| <b>NAV2 RMT XFR</b> – NAV2 remote transfer key is stuck.               |  |

**GIA 63 (CONT.)**

| Message  | Comments  |
|--|---|
| <b>G/S1 FAIL</b> – G/S1 is inoperative.                              | A failure has been detected in glideslope receiver 1 and/or receiver 2. The G1000 system should be serviced.  |
| <b>G/S2 FAIL</b> – G/S2 is inoperative.                              |   |
| <b>G/S1 SERVICE</b> – G/S1 needs service.<br>Return unit for repair. | A failure has been detected in glideslope receiver 1 and/or receiver 2. The receiver may still be available. The G1000 system should be serviced when possible. |
| <b>G/S2 SERVICE</b> – G/S2 needs service.<br>Return unit for repair. |   |

**GIA 63W INTEGRATED AVIONICS UNIT**

| Message Advisory   | Comments   |
|--|--|
| <b>GIA1 CONFIG</b> – GIA1 config error.<br>Config service req'd.         | The GIA1 and/or GIA2 configuration settings do not match backup configuration memory. The G1000 system should be serviced. |
| <b>GIA2 CONFIG</b> – GIA2 config error.<br>Config service req'd.         |  |
| <b>GIA1 CONFIG</b> – GIA1 audio config error.<br>Config service req'd.   | The GIA1 and/or GIA2 have an error in the audio configuration. The G1000 system should be serviced.                        |
| <b>GIA2 CONFIG</b> – GIA2 audio config error.<br>Config service req'd.   |  |
| <b>GIA1 COOLING</b> – GIA1 temperature too low.                          | The GIA1 and/or GIA2 temperature is too low to operate correctly. Allow units to warm up to operating temperature.         |
| <b>GIA2 COOLING</b> – GIA2 temperature too low.                          |  |
| <b>GIA1 COOLING</b> – GIA1 over temperature.                             | The GIA1 and/or GIA2 temperature is too high. If problem persists, the G1000 system should be serviced.                    |
| <b>GIA2 COOLING</b> – GIA2 over temperature.                             |  |
| <b>GIA1 SERVICE</b> – GIA1 needs service.<br>Return the unit for repair. | The GIA1 and/or GIA2 self-test has detected a problem in the unit. The G1000 system should be serviced.                    |
| <b>GIA2 SERVICE</b> – GIA2 needs service.<br>Return the unit for repair. |  |
| <b>HW MISMATCH</b> – GIA hardware mismatch. GIA1 communication halted.   | A GIA mismatch has been detected, where only one is WAAS capable.  |
| <b>HW MISMATCH</b> – GIA hardware mismatch. GIA2 communication halted.   |  |
| <b>MANIFEST</b> – GIA1 software mismatch, communication halted.          | The GIA1 and/or GIA 2 has incorrect software installed. The G1000 system should be serviced.                               |
| <b>MANIFEST</b> – GIA2 software mismatch, communication halted.          |  |

## GIA 63W (CONT.)

| Message Advisory   | Comments  |
|--|---|
| <b>COM1 TEMP</b> – COM1 over temp.<br>Reducing transmitter power.      | The system has detected an over temperature condition in COM1 and/or COM2. The transmitter operates at reduced power. If the problem persists, the G1000 system should be serviced.                                   |
| <b>COM2 TEMP</b> – COM2 over temp.<br>Reducing transmitter power.      |   |
| <b>COM1 SERVICE</b> – COM1 needs service. Return unit for repair.      | The system has detected a failure in COM1 and/or COM2. COM1 and/or COM2 may still be usable. The G1000 system should be serviced when possible.   |
| <b>COM2 SERVICE</b> – COM2 needs service. Return unit for repair.      |   |
| <b>COM1 PTT</b> – COM1 push-to-talk key is stuck.                      | The COM1 and/or COM2 external push-to-talk switch is stuck in the enable (or “pressed”) position. Press the PTT switch again to cycle its operation.<br>If the problem persists, the G1000 system should be serviced. |
| <b>COM2 PTT</b> – COM2 push-to-talk key is stuck.                      |   |
| <b>COM1 RMT XFR</b> – COM1 remote transfer key is stuck.               | The COM1 and/or COM2 transfer switch is stuck in the enabled (or “pressed”) position. Press the transfer switch again to cycle its operation. If the problem persists, the G1000 system should be serviced.           |
| <b>COM2 RMT XFR</b> – COM2 remote transfer key is stuck.               |   |
| <b>LOI</b> – GPS integrity lost. Crosscheck with other NAVS.           | GPS integrity is insufficient for the current phase of flight.  |
| <b>GPS NAV LOST</b> – Loss of GPS navigation. Insufficient satellites. | Loss of GPS navigation due to insufficient satellites.  |
| <b>GPS NAV LOST</b> – Loss of GPS navigation. Position error.          | Loss of GPS navigation due to position error.   |
| <b>GPS NAV LOST</b> – Loss of GPS navigation. GPS fail.                | Loss of GPS navigation due to GPS failure.  |
| <b>ABORT APR</b> – Loss of GPS navigation. Abort approach.             | Abort approach due to loss of GPS navigation.   |
| <b>APR DWNGRADE</b> – Approach downgraded.                             | Use LNAV minima when approach is downgraded.  |
| <b>TRUE APR</b> – True north approach. Change HDG reference to TRUE.   | Displayed after passing the first waypoint of a true north approach when the nav angle is set to ‘MAGNETIC’.  |
| <b>GPS1 SERVICE</b> – GPS1 needs service. Return unit for repair.      | A failure has been detected in the GPS1 and/or GPS2 receiver. The receiver may still be available. The G1000 system should be serviced.   |
| <b>GPS2 SERVICE</b> – GPS2 needs service. Return unit for repair.      |   |
| <b>NAV1 SERVICE</b> – NAV1 needs service. Return unit for repair.      | A failure has been detected in the NAV1 and/or NAV2 receiver. The receiver may still be available. The G1000 system should be serviced.   |
| <b>NAV2 SERVICE</b> – NAV2 needs service. Return unit for repair.      |   |

**GIA 63W (CONT.)**

| Message Advisory  | Comments  |
|---|---|
| <b>NAV1 RMT XFR</b> – NAV1 remote transfer key is stuck.          | The remote NAV1 and/or NAV2 transfer switch is stuck in the enabled (or “pressed”) state. Press the transfer switch again to cycle its operation. If the problem persists, the G1000 system should be serviced. |
| <b>NAV2 RMT XFR</b> – NAV2 remote transfer key is stuck.          |   |
| <b>G/S1 FAIL</b> – G/S1 is inoperative.                           | A failure has been detected in glideslope receiver 1 and/or receiver 2. The G1000 system should be serviced.  |
| <b>G/S2 FAIL</b> – G/S2 is inoperative.                           |   |
| <b>G/S1 SERVICE</b> – G/S1 needs service. Return unit for repair. | A failure has been detected in glideslope receiver 1 and/or receiver 2. The receiver may still be available. The G1000 system should be serviced when possible.   |
| <b>G/S2 SERVICE</b> – G/S2 needs service. Return unit for repair. |   |

**GDC 74A AIR DATA COMPUTER**

| Message Advisory  | Comments   |
|---|--|
| <b>MANIFEST</b> – GDC1 software mismatch, communication halted. | The GDC 74A has incorrect software installed. The G1000 system should be serviced. |

**GEA 71 ENGINE/AIRFRAME UNIT**

| Message Advisory  | Comments  |
|---|---|
| <b>GEA1 CONFIG</b> – GEA1 config error. Config service req'd.   | The GEA1 configuration settings do not match those of backup configuration memory. The G1000 system should be serviced. |
| <b>MANIFEST</b> – GEA1 software mismatch, communication halted. | The #1 GEA 71 has incorrect software installed. The G1000 system should be serviced.                                    |

**GTX 33 TRANSPONDER**

| Message Advisory   | Comments   |
|--|--|
| <b>XPDR1 CONFIG</b> – XPDR1 config error. Config service req'd.  | The transponder configuration settings do not match those of backup configuration memory. The G1000 system should be serviced. |
| <b>MANIFEST</b> – GTX1 software mismatch, communication halted.  | The transponder has incorrect software installed. The G1000 system should be serviced.   |
| <b>XPDR1 SRVC</b> – XPDR1 needs service. Return unit for repair. | The #1 transponder should be serviced when possible.   |
| <b>XPDR1 FAIL</b> – XPDR1 is inoperative.                        | There is no communication with the #1 transponder.   |

### GMU 44 MAGNETOMETER

| Message Advisory  | Comments  |
|---|---|
| <b>HDG FAULT</b> – AHRS1 magnetometer fault has occurred.       | A fault has occurred in the #1 GMU 44. Heading is flagged as invalid. The AHRS uses GPS for backup mode operation. The G1000 system should be serviced. |
| <b>MANIFEST</b> – GMU1 software mismatch, communication halted. | The GMU 44 has incorrect software installed. The G1000 system should be serviced.   |

### GRS 77 ATTITUDE AND HEADING REFERENCE SYSTEM

| Message Advisory  | Comments  |
|---|---|
| <b>AHRS1 TAS</b> – AHRS1 not receiving airspeed.                    | The #1 AHRS is not receiving true airspeed from the air data computer. The AHRS relies on GPS information to augment the lack of airspeed. The G1000 system should be serviced. |
| <b>AHRS1 GPS</b> – AHRS1 using backup GPS source.                   | The #1 AHRS is using the backup GPS path. Primary GPS path has failed. The G1000 system should be serviced when possible.   |
| <b>AHRS1 GPS</b> – AHRS1 not receiving any GPS information.         | The #1 AHRS is not receiving any or any useful GPS information. Check AFMS limitations. The G1000 system should be serviced.  |
| <b>AHRS1 GPS</b> – AHRS1 not receiving backup GPS information.      | The #1 AHRS is not receiving backup GPS information. The G1000 system should be serviced.   |
| <b>AHRS1 GPS</b> – AHRS1 operating exclusively in no-GPS mode.      | The #1 AHRS is operating exclusively in no-GPS mode. The G1000 system should be serviced.   |
| <b>AHRS1 SRVC</b> – AHRS1 Magnetic-field model needs update.        | The #1 AHRS earth magnetic field model is out of date. Update magnetic field model when practical.  |
| <b>GEO LIMITS</b> – AHRS1 too far North/South, no magnetic compass. | The aircraft is outside geographical limits for approved AHRS operation. Heading is flagged as invalid.   |
| <b>MANIFEST</b> – GRS1 software mismatch, communication halted.     | The #1 AHRS has incorrect software installed. The G1000 system should be serviced.  |

### GDL 69/69A SATELLITE DATALINK RECEIVER

| Message Advisory   | Comments  |
|--|---|
| <b>GDL69 CONFIG</b> – GDL 69 config error. Config service req'd. | GDL 69 configuration settings do not match those of backup configuration memory. The G1000 system should be serviced. |
| <b>GDL69 FAIL</b> – GDL 69 has failed.                           | A failure has been detected in the GDL 69. The receiver is unavailable. The G1000 system should be serviced.          |
| <b>MANIFEST</b> – GDL software mismatch, communication halted.   | The GDL 69 has incorrect software installed. The G1000 system should be serviced.                                     |

**MISCELLANEOUS**

| Message Advisory  | Comments   |
|---|--|
| <b>FPL WPT LOCK</b> – Flight plan waypoint is locked.                 | Upon power-up, the G1000 system detects that a stored flight plan waypoint is locked. This occurs when an aviation database update eliminates an obsolete waypoint. The flight plan cannot find the specified waypoint and flags this message. This can also occur with user waypoints in a flight plan that is deleted.<br>Remove the waypoint from the flight plan if it no longer exists in any database, OR<br>update the waypoint name/identifier to reflect the new information. |
| <b>FPL WPT MOVE</b> – Flight plan waypoint moved.                     | The system has detected that a waypoint coordinate has changed due to a new aviation database update. Verify that stored flight plans contain correct waypoint locations.  |
| <b>TIMER EXPIRD</b> – Timer has expired.                              | The system notifies the pilot that the timer has expired.  |
| <b>DB CHANGE</b> – Database changed. Verify user modified procedures. | This occurs when a stored flight plan contains procedures that have been manually edited. This alert is issued only after an aviation database update. Verify that the user-modified procedures in stored flight plans are correct and up to date.   |
| <b>DB CHANGE</b> – Database changed. Verify stored airways.           | This occurs when a stored flight plan contains an airway that is no longer consistent with the aviation database. This alert is issued only after an aviation database update. Verify use of airways in stored flight plans and reload airways as needed.  |
| <b>FPL TRUNC</b> – Flight plan has been truncated.                    | This occurs when a newly installed aviation database eliminates an obsolete approach or arrival used by a stored flight plan. The obsolete procedure is removed from the flight plan. Update flight plan with current arrival or approach.   |
| <b>LOCKED FPL</b> – Cannot navigate locked flight plan.               | This occurs when the pilot attempts to activate a stored flight plan that contains locked waypoint. Remove locked waypoint from flight plan. Update flight plan with current waypoint.   |
| <b>WPT ARRIVAL</b> – Arriving at waypoint -[xxxx]                     | Arriving at waypoint [xxxx], where [xxxx] is the waypoint name.  |
| <b>STEEP TURN</b> – Steep turn ahead.                                 | A steep turn is 15 seconds ahead. Prepare to turn.   |
| <b>INSIDE ARSPC</b> – Inside airspace.                                | The aircraft is inside the airspace.   |
| <b>ARSPC AHEAD</b> – Airspace ahead less than 10 minutes.             | Special use airspace is ahead of aircraft. The aircraft will penetrate the airspace within 10 minutes.   |
| <b>ARSPC NEAR</b> – Airspace near and ahead.                          | Special use airspace is near and ahead of the aircraft position.   |
| <b>ARSPC NEAR</b> – Airspace near – less than 2 nm.                   | Special use airspace is within 2 nm of the aircraft position.  |
| <b>LEG UNSMOOTH</b> – Flight plan leg will not be smooth.             | The approaching flight plan waypoints are too close to allow for smooth turns. Prepare for steep turns ahead and expect noticeable course deviations.  |
| <b>APR INACTV</b> – Approach is not active.                           | The system notifies the pilot that the loaded approach is not active. Activate approach when required.   |
| <b>SLCT FREQ</b> – Select appropriate frequency for approach.         | The system notifies the pilot to load the approach frequency for the appropriate NAV receiver. Select the correct frequency for the approach.  |

### MISCELLANEOUS (CONT.)

| Message Advisory   | Comments  |
|--|---|
| <b>SLCT NAV</b> – Select NAV on CDI for approach.                        | The system notifies the pilot to set the CDI to the correct NAV receiver. Set the CDI to the correct NAV receiver.  |
| <b>PTK FAIL</b> – Parallel track unavailable: bad geometry.              | Bad parallel track geometry.  |
| <b>PTK FAIL</b> – Parallel track unavailable: invalid leg type.          | Invalid leg type for parallel offset.   |
| <b>PTK FAIL</b> – Parallel track unavailable: past IAF.                  | IAF waypoint for parallel offset has been passed.   |
| <b>UNABLE V WPT</b> – Can't reach current vertical waypoint.             | The current vertical waypoint can not be reached within the maximum flight path angle and vertical speed constraints. The system automatically transitions to the next vertical waypoint.                             |
| <b>VNV</b> – Unavailable. Unsupported leg type in flight plan.           | The lateral flight plan contains a procedure turn, vector, or other unsupported leg type prior to the active vertical waypoint. This prevents vertical guidance to the active vertical waypoint.                      |
| <b>VNV</b> – Unavailable. Excessive crosstrack error.                    | The current crosstrack exceeds the limit, causing vertical deviation to go invalid.   |
| <b>VNV</b> – Unavailable. Excessive track angle error.                   | The current track angle error exceeds the limit, causing the vertical deviation to go invalid.  |
| <b>VNV</b> – Unavailable. Parallel course selected.                      | A parallel course has been selected, causing the vertical deviation to go invalid.  |
| <b>NO WGS84 WPT</b> – Non WGS 84 waypoint for navigation -[xxxx]         | The selected waypoint [xxxx] does not use the WGS 84 datum. Cross-check position with alternate navigation sources.   |
| <b>TRAFFIC FAIL</b> – Traffic device has failed.                         | The G1000 is no longer receiving data from the traffic system. The traffic device should be serviced.   |
| <b>STRMSCP FAIL</b> – Stormscope has failed.                             | Stormscope has failed. The G1000 System should be serviced.   |
| <b>FAILED PATH</b> – A data path has failed.                             | A data path connected to the GDU or the GIA 63/63W has failed.  |
| <b>MAG VAR WARN</b> – Large magnetic variance. Verify all course angles. | The GDU's internal model cannot determine the exact magnetic variance for geographic locations near the magnetic poles. Displayed magnetic course angles may differ from the actual magnetic heading by more than 2°. |
| <b>SCHEDULER [#]</b> – <message>.  | Message criteria entered by the user.   |



## AFCS STATUS ANNUNCIATIONS

The following annunciations (listed in order of increasing priority) can appear on the PFD above the Airspeed and Attitude indicators. Only one annunciation may occur at a time, and messages are prioritized by criticality.



Figure A-5 AFCS Status Annunciation

| Alert Condition  | Annunciation | Description  |
|--|--------------|--|
| Aileron Mistrim Right                                  | <b>AIL →</b> | Roll servo providing sustained force in the indicated direction  |
| Aileron Mistrim Left                                   | <b>← AIL</b> |  |
| Elevator Mistrim Down                                  | <b>↓ ELE</b> | Pitch servo providing sustained force in the indicated direction   |
| Elevator Mistrim Up                                    | <b>↑ ELE</b> |  |
| Pitch Trim Failure<br>(or stuck <b>AP TRIM</b> Switch) | <b>PTRM</b>  | If AP engaged, take control of the aircraft and disengage AP<br>If AP disengaged, move <b>AP TRIM</b> switches separately to unstick   |
| Roll Failure   | <b>ROLL</b>  | Roll axis control failure; AP inoperative  |
| Pitch Failure  | <b>PTCH</b>  | Pitch axis control failure; AP inoperative   |
| System Failure   | <b>AFCS</b>  | AP and MET are unavailable; FD may still be available  |
| Preflight Test   | <b>PFT</b>   | Performing preflight system test; aural alert sounds at completion<br>Do not press the <b>AP DISC</b> Switch during servo power-up and preflight system tests as this may cause the preflight system test to fail or never to start (if servos fail their power-up tests). Power must be cycled to the servos to remedy the situation. |
|  | <b>PFT</b>   | Preflight system test failed; aural alert sounds at failure  |

## TERRAIN AWARENESS AND WARNING SYSTEM (TAWS) ALERTS

Annunciations appear on the PFD and MFD. Pop-up alerts appear only on the MFD. For more information on TAWS, refer to the Hazard Avoidance Section.

| Alert Type  | Annunciation<br>(PFD/MFD<br>TAWS Page) | Pop-Up Alert<br>(MFD Navigation Map<br>Page)         | Aural Message  |
|---|--|--|--|
| Excessive Descent Rate Warning (EDR)              | PULL UP                                | PULL-UP  | "Pull Up"  |
| Reduced Required Terrain Clearance Warning (RTC)  | PULL UP                                | TERRAIN - PULL-UP<br>or<br>TERRAIN AHEAD - PULL-UP   | "Terrain, Terrain; Pull Up, Pull Up"<br>or<br>"Terrain Ahead, Pull Up; Terrain Ahead, Pull Up"     |
| Imminent Terrain Impact Warning (ITI)             | PULL UP                                | TERRAIN AHEAD - PULL-UP<br>or<br>TERRAIN - PULL-UP   | Terrain Ahead, Pull Up; Terrain Ahead, Pull Up"<br>or<br>"Terrain, Terrain; Pull Up, Pull Up"      |
| Reduced Required Obstacle Clearance Warning (ROC) | PULL UP                                | OBSTACLE - PULL-UP<br>or<br>OBSTACLE AHEAD - PULL-UP | "Obstacle, Obstacle; Pull Up, Pull Up"<br>or<br>"Obstacle Ahead, Pull Up; Obstacle Ahead, Pull Up" |
| Imminent Obstacle Impact Warning (IOI)            | PULL UP                                | OBSTACLE AHEAD - PULL-UP<br>or<br>OBSTACLE - PULL-UP | "Obstacle Ahead, Pull Up; Obstacle Ahead, Pull Up"<br>or<br>"Obstacle, Obstacle; Pull Up, Pull Up" |
| Reduced Required Terrain Clearance Caution (RTC)  | TERRAIN                                | CAUTION - TERRAIN<br>or<br>TERRAIN AHEAD             | "Caution, Terrain; Caution, Terrain"<br>or<br>"Terrain Ahead; Terrain Ahead"                       |
| Imminent Terrain Impact Caution (ITI)             | TERRAIN                                | TERRAIN AHEAD<br>or<br>CAUTION - TERRAIN             | "Terrain Ahead; Terrain Ahead"<br>or<br>"Caution, Terrain; Caution, Terrain"                       |
| Reduced Required Obstacle Clearance Caution (ROC) | TERRAIN                                | CAUTION - OBSTACLE<br>or<br>OBSTACLE AHEAD           | "Caution, Obstacle; Caution, Obstacle"<br>or<br>"Obstacle Ahead; Obstacle Ahead"                   |
| Imminent Obstacle Impact Caution (IOI)            | TERRAIN                                | OBSTACLE AHEAD<br>or<br>CAUTION - OBSTACLE           | "Obstacle Ahead; Obstacle Ahead"<br>or<br>"Caution, Obstacle; Caution, Obstacle"                   |
| Premature Descent Alert Caution (PDA)             | TERRAIN                                | TOO LOW - TERRAIN                                    | "Too Low, Terrain"   |
| Altitude Callout "500"                            | None                                   | None   | "Five-Hundred"   |
| Excessive Descent Rate Caution (EDR)              | TERRAIN                                | SINK RATE  | "Sink Rate"  |
| Negative Climb Rate Caution (NCR)                 | TERRAIN                                | DON'T SINK<br>or<br>TOO LOW - TERRAIN                | "Don't Sink"<br>or<br>"Too Low, Terrain"   |

**TAWS SYSTEM STATUS ANNUNCIATIONS**

| Alert Type   | Annunciation (PFD/MFD TAWS Page) | Pop-Up Alert (MFD Navigation Map Page) | Aural Message   |
|--|----------------------------------|--|---|
| TAWS System Test Fail                              | <b>TAWS FAIL</b>                 | None                                   | "TAWS System Failure"   |
| TAWS Alerting is disabled                          | <b>TAWS INHB</b>                 | None                                   | None  |
| No GPS position or excessively degraded GPS signal | <b>TAWS N/A</b>                  | None                                   | "TAWS Not Available"<br>("TAWS Available" will be heard when sufficient GPS signal is re-established) |
| System Test in progress                            | <b>TAWS TEST</b>                 | None                                   | None  |
| System Test pass                                   | None                             | None                                   | "TAWS System Test OK"   |

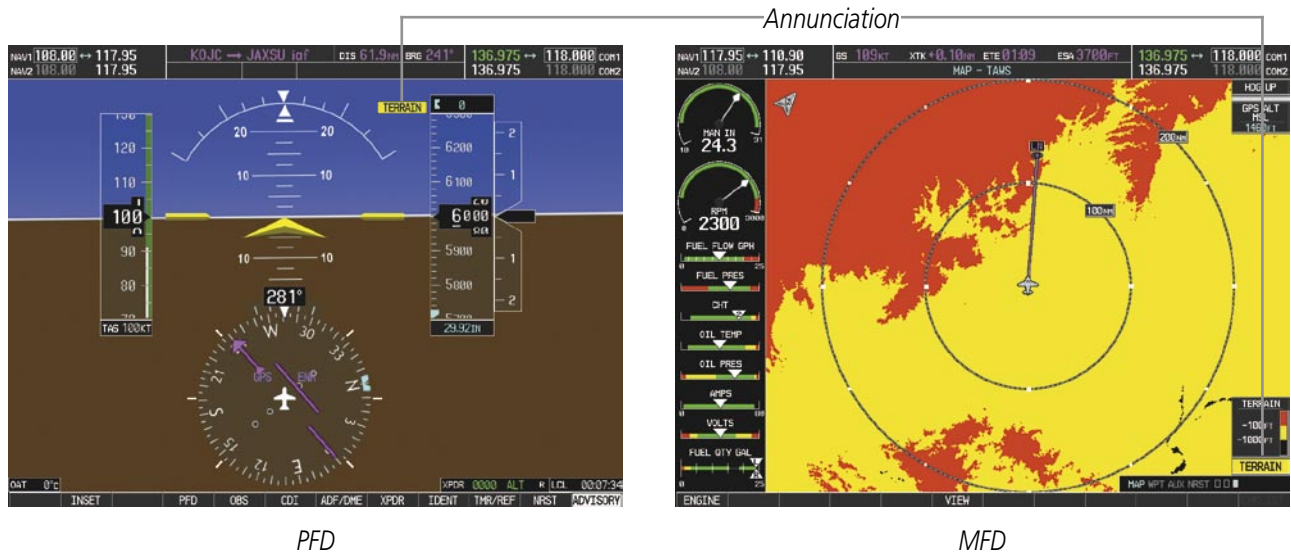

**Figure A-6 TAWS Annunciation Locations**

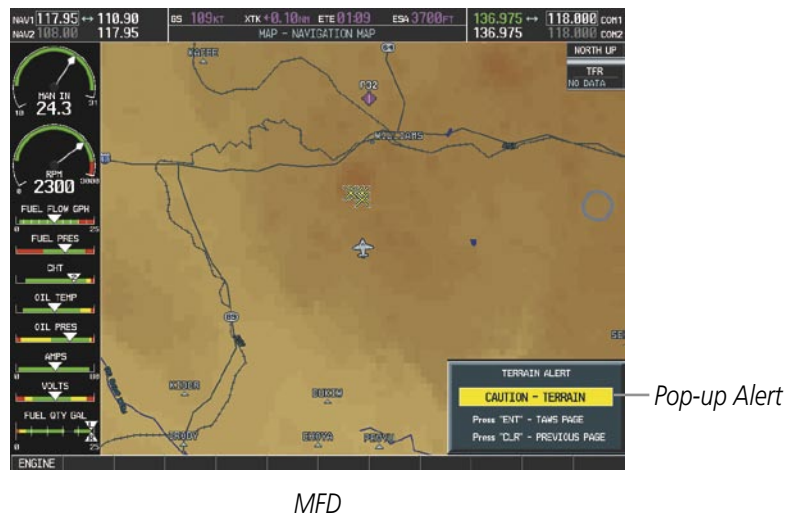

**Figure A-7 TAWS Pop-up Alert**

## GDL 69/69A DATA LINK RECEIVER TROUBLESHOOTING

Some quick troubleshooting steps can be performed to find the possible cause of a failure:

- Ensure the owner/operator of the aircraft in which the Data Link Receiver is installed has subscribed to XM
- Ensure the XM subscription has been activated
- Perform a quick check of the circuit breakers to ensure that power is applied to the Data Link Receiver

For troubleshooting purposes, check the LRU Information Box on the AUX - System Status Page for Data Link Receiver (GDL 69/69A) status, serial number, and software version number (Figure A-2).

If a failure still exists, the following messages may provide insight as to the possible problem:

| Message                          | Message Location   | Description  |
|----------------------------------|--|--|
| <b>CHECK ANTENNA</b>             | XM Radio Page - active channel field   | Data Link Receiver antenna error; service required             |
| <b>UPDATING</b>                  | XM Radio Page - active channel field   | Data Link Receiver updating encryption code                    |
| <b>NO SIGNAL</b>                 | XM Radio Page - active channel field<br>Weather Datalink Page - center of page | Loss of signal; signal strength too low for receiver           |
| <b>LOADING</b>                   | XM Radio Page - active channel field   | Acquiring channel audio or information                         |
| <b>OFF AIR</b>                   | XM Radio Page - active channel field   | Channel not in service   |
| <b>---</b>                       | XM Radio Page - active channel field   | Missing channel information                                    |
| <b>WEATHER DATA LINK FAILURE</b> | Weather Datalink Page - center of page   | No communication from Data Link Receiver within last 5 minutes |
| <b>ACTIVATION REQUIRED</b>       | Weather Datalink Page - center of page   | XM subscription is not activated                               |

## SD CARD USE AND DATABASES

The G1000 System uses Secure Digital (SD) cards to load and store various types of data. For basic flight operations, SD cards are required for database storage as well as Jeppesen aviation and ChartView database updates.

### JEPPESEN DATABASES

The Jeppesen aviation database is updated on a 28-day cycle. The optional ChartView database is updated on a 14-day cycle. If the ChartView database is not updated within 70 days of the expiration date, ChartView no longer functions.

Both these databases are provided directly from Jeppesen. The ChartView database should be copied to the Garmin-supplied Supplemental Data Card which resides in the bottom card slot on the MFD. The aviation database may be installed from the Jeppesen-supplied SD data card or copied to one of the Garmin-supplied Supplemental Data Cards. Contact Jeppesen ([www.jeppesen.com](http://www.jeppesen.com)) for subscription and update information.

The aviation database may be programmed to only one of the Supplemental Data Cards. This card must then be used to update the PFD and the MFD. After the aviation database is installed, the card may be removed after loading the update to each LRU.

#### Updating the Jeppesen aviation database:

- 1) With the G1000 System OFF, insert the SD card containing the aviation database update into the top card slot of the PFD to be updated (label of SD card should face left).
- 2) Turn the G1000 System ON. A prompt similar to the following is displayed in the upper left corner of the PFD:

```
DO YOU WANT TO UPDATE THE AVIATION DATABASE?
      FROM           TO
REGION:  WORLDWIDE  WORLDWIDE
CYCLE:   0604        0605
EFFECTIVE: 13-APR-2006  11-MAY-2006
EXPIRES:  11-MAY-2006  08-JUN-2006
NO WILL BE ASSUMED IN 8 SECONDS.
```

**Figure B-1 Database Update Prompt**

- 3) Press the **ENT** Key to start the database update. A prompt similar to the following is displayed:

```
DO YOU WANT TO UPDATE THE AVIATION DATABASE?
      FROM           TO
REGION:  WORLDWIDE  WORLDWIDE
CYCLE:   0604        0605
EFFECTIVE: 13-APR-2006  11-MAY-2006
EXPIRES:  11-MAY-2006  08-JUN-2006
NO WILL BE ASSUMED IN 8 SECONDS.
UPDATING AVIATION DATABASE, PLEASE WAIT.
.
UPDATED 1 FILES SUCCESSFULLY!
PRESS ANY KEY TO CONTINUE.
CONTINUING IN 8 SECONDS.
```

**Figure B-2 Database Update Confirmation**

- 4) After the update completes, the PFD continues to power-up normally.
- 5) Turn the G1000 System OFF and remove the SD card.
- 6) Repeat steps 1 through 4 for the MFD. The MFD and PFD databases are now updated. Remove the SD card when finished.
- 7) Verify the correct update cycle is loaded during MFD power-up.

## GARMIN DATABASES

---



**NOTE:** *The data contained in the terrain and obstacle databases comes from government agencies. Garmin accurately processes and cross-validates the data, but cannot guarantee the accuracy and completeness of the data.*

---

The following G1000 databases are stored on Supplemental Data Cards provided by Garmin:

- Expanded basemap – The basemap database contains data for the topography and land features, such as rivers, lakes, and towns. It is updated only periodically, with no set schedule. There is no expiration date.
- Terrain – The terrain database contains terrain mapping data. It is updated periodically and has no expiration date.
- Airport terrain – The airport terrain database contains airport diagram data. It is updated periodically and has no expiration date.
- Obstacle – The obstacle database contains data for obstacles, such as towers, that pose a potential hazard to aircraft. Obstacles 200 feet and higher are included in the obstacle database. It is very important to note that not all obstacles are necessarily charted and therefore may not be contained in the obstacle database. This database is updated on a 56-day cycle.
- SafeTaxi – The SafeTaxi database contains detailed airport diagrams for selected airports. These diagrams aid in following ground control instructions by accurately displaying the aircraft position on the map in relation to taxiways, ramps, runways, terminals, and services. This database is updated on a 56-day cycle.
- FliteCharts – The FliteCharts database contains procedure charts for the United States only. This database is updated on a 28-day cycle. If not updated within 180 days of the expiration date, FliteCharts no longer functions.

Since these databases are not stored internally in the PFD or MFD, a Supplemental Data Card containing identical database versions must be kept in each display unit. After subscribing to the desired databases product, these database products will be downloaded to two Supplemental Data Cards (with the exception of FliteCharts, which is loaded on only one card). Insert each Supplemental Data Card into the correct location shown in Figure B-3. If one of the Supplemental Data Cards contains the ChartView database, or the FliteCharts database, this card must be inserted into the bottom card slot on the MFD. These cards must not be removed except to update the databases stored on each card.

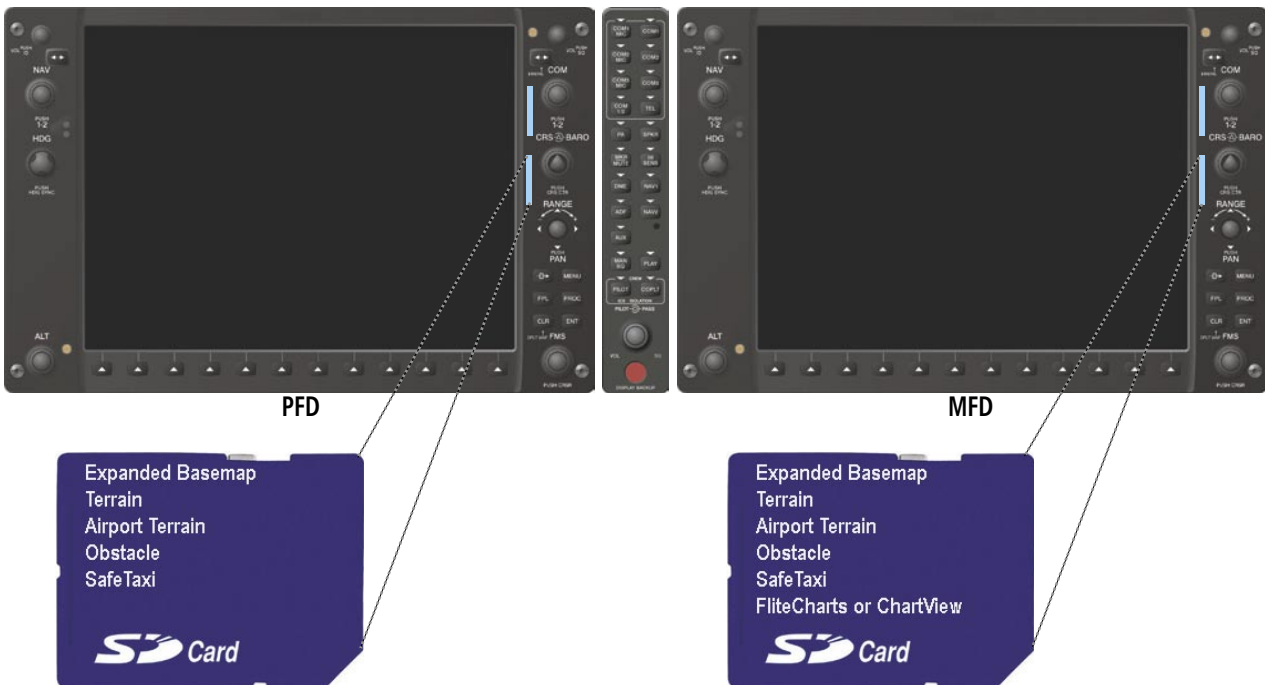

Figure B-3 Correct Database Locations

The Garmin database updates can be obtained by following the instructions detailed in the ‘Aviation Databases’ section of the Garmin website ([www.garmin.com](http://www.garmin.com)). Once the updated files have been downloaded from the website, a PC equipped with an appropriate SD card reader is used to unpack and program the new databases onto the existing Supplemental Data Cards. The following equipment is required to perform the update:

- Windows-compatible PC computer (Windows 2000 or XP recommended)
- SanDisk SD Card Reader, P/Ns SDDR-93 or SDDR-99 or equivalent card reader
- Updated database obtained from the Garmin website
- Existing 010-00330-42 Supplemental Database SD Cards from both PFD and MFD

In some cases it may be necessary to obtain an unlock code from Garmin in order to make the database product functional. It may also be necessary to have the system configured by a Garmin authorized service facility in order to use some database features.

**Updating Garmin databases:**

- 1) Copy the data to the appropriate data cards.
- 2) Insert one SD card in the bottom card slot of the MFD and one in the bottom card slot of each PFD. The SD card containing the ChartView or FliteCharts database must be inserted into the bottom slot on the MFD.

- 3) Apply power to the G1000 System. View the MFD power-up splash screen. Check that the databases are initialized and displayed on the splash screen. When updating the terrain and FliteCharts databases, an 'in progress' message may be seen. If this message is present, wait for the system to finish loading before verifying the correct databases are initialized, then proceed to step 3.



Figure B-4 Database Information on the Splash Screen

- 4) Acknowledge the Power-up Page agreement by pressing the **ENT** Key or the right most softkey.
- 5) Use the **FMS** Knob to select the AUX - System Setup Page.
- 6) Select the **DBASE** Softkey to place the cursor in the 'DATABASE' box.
- 7) Turn the **FMS** Knob to scroll through the list and check that all databases are current and there are no errors.
- 8) Power down the G1000.



## GLOSSARY

|           |  |                     |   |
|-----------|--|---------------------|---|
| ACC       | accuracy                               | Bearing             | The compass direction from the present position to a destination waypoint   |
| ACT, ACTV | active, activate                       | BFO                 | beat frequency oscillator   |
| ADC       | air data computer                      | BKSP                | backspace   |
| ADF       | Automatic Direction Finder             | BRG                 | bearing   |
| ADI       | Attitude Direction Indicator           | C                   | center runway   |
| AF        | Arc to fix                             | °C                  | degrees Celsius   |
| AFCS      | Automatic Flight Control System        | CA                  | Course to Altitude  |
| AFM       | Airplane Flight Manual                 | CALC                | calculator  |
| AFMS      | Airplane Flight Manual Supplement      | Calibrated Airspeed | Indicated airspeed corrected for installation and instrument errors.  |
| AFRM      | airframe                               | CD                  | Course to DME distance  |
| AGL       | Above Ground Level                     | CDI                 | Course Deviation Indicator  |
| AHRS      | Attitude and Heading Reference System  | CDU                 | Control Display Unit  |
| AIM       | Airman's Information Manual            | CF                  | Course to Fix   |
| AIRMET    | Airman's Meteorological Information    | CHT                 | Cylinder Head Temperature   |
| ALRT      | alert                                  | CHKLIST             | checklist   |
| ALT       | altitude                               | CHNL                | channel   |
| ALT, ALTN | alternator                             | CI                  | Course to Intercept   |
| AMPS      | amperes                                | CLD                 | cloud   |
| ANNUNC    | annunciation                           | CLR                 | clear   |
| ANT       | antenna                                | cm                  | centimeter  |
| AP        | autopilot                              | CNS                 | Communication, Navigation, & Surveillance   |
| AP DISC   | autopilot disconnect                   | CO                  | carbon monoxide   |
| APR       | approach                               | COM                 | communication radio   |
| APT       | airport, aerodrome                     | CONFIG              | configuration   |
| ARINC     | Aeronautical Radio Incorporated        | COOL                | coolant   |
| ARSPC     | airspace                               | COPLT               | co-pilot  |
| ARTCC     | Air Route Traffic Control Center       | Course              | The line between two points to be followed by the aircraft  |
| ARV       | arrival                                | Course to Steer     | The recommended direction to steer in order to reduce course error or stay on course. Provides the most efficient heading to get back to the desired course and proceed along the flight plan |
| AS        | airspeed                               | CR                  | Course to Radial  |
| ASB       | Aviation Support Branch                | CRG                 | Cockpit Reference Guide   |
| ASOS      | Automated Surface Observing System     | CRNT                | current   |
| ATC       | Air Traffic Control                    | Crosstrack Error    | The distance the aircraft is off a desired course in either direction, left or right  |
| ATCRBS    | ATC Radar Beacon System                | CRS                 | course  |
| ATIS      | Automatic Terminal Information Service | CRS                 | Course to Steer   |
| ATK       | along-track                            | CRSR                | cursor  |
| AUTOSEQ   | automatic sequence                     | CTA                 | Control Area  |
| AUX       | auxiliary                              | CTRL                | control   |
| AWOS      | Automated Weather Observing System     |                     |   |
| B ALT     | barometric altitude                    |                     |   |
| BARO      | barometric setting                     |                     |   |
| BATT      | battery                                |                     |   |
| BC        | backcourse                             |                     |   |

|                       |  |                           |   |
|-----------------------|--|---------------------------|---|
| Cumulative            | The total of all legs in a flight plan.  | Endurance                 | Flight endurance, or total possible flight time based on available fuel on board  |
| CVR                   | Cockpit Voice Recorder   |                           |   |
| CVRG                  | coverage   |                           |   |
| CWS                   | control wheel steering   | ENG                       | engine  |
| CYL                   | cylinder   | ENGD                      | engaged   |
|                       |  | ENR                       | enroute   |
| D ALT                 | density altitude   | Enroute Safe Altitude     | The recommended minimum altitude within ten miles left or right of the desired course on an active flight plan or direct-to |
| DB, DBASE             | database   |                           |   |
| dBZ                   | decibels 'Z' (radar return)  |                           |   |
| DCLTR, DECLTR         | declutter  |                           |   |
| DEC FUEL              | decrease fuel  | ENT                       | enter   |
| deg                   | degree   | EPE                       | Estimated Position Error  |
| DEIC, DEICE           | de-icing   | EPU                       | Estimated Position Uncertainty  |
| DEP                   | departure  | ERR                       | error   |
| Desired Track         | The desired course between the active "from" and "to" waypoints  | ESA                       | Enroute Safe Altitude   |
|                       |  | Estimated Position Error  | A measure of horizontal GPS position error derived by satellite geometry conditions and other factors                       |
| DEST                  | destination  |                           |   |
| DF                    | Direct to Fix  |                           |   |
| DFLT                  | default  |                           |   |
| DGRD                  | degrade  | Estimated Time of Arrival | The estimated time at which the aircraft should reach the destination waypoint, based upon current speed and track          |
| DH                    | decision height  |                           |   |
| Dilution of Precision | A measure of GPS satellite geometry quality on a scale of one to ten (lower numbers equal better geometry, where higher numbers equal poorer geometry) | Estimated Time Enroute    | The estimated time it takes to reach the destination waypoint from the present position, based upon current ground speed    |
|                       |  |                           |   |
| DIR                   | direction  | ETA                       | Estimated Time of Arrival   |
| DIS                   | distance   | ETE                       | Estimated Time Enroute  |
| Distance              | The 'great circle' distance from the present position to a destination waypoint  | EXPIRD                    | expired   |
|                       |  |                           |   |
| DME                   | Distance Measuring Equipment   | °F                        | degrees Fahrenheit  |
| DOP                   | Dilution of Precision  | FA                        | Course From Fix to Altitude   |
| DP                    | Departure Procedure  | FAA                       | Federal Aviation Administration   |
| DPRT                  | departure  | FADEC                     | Full Authority Digital Engine Control   |
| DR                    | dead reckoning   | FAF                       | Final Approach Fix  |
| DSBL                  | disabled   | FAIL                      | failure   |
| DTK                   | Desired Track  | FC                        | Course From Fix to Distance   |
|                       |  | FCC                       | Federal Communication Commission  |
|                       |  | FCST                      | forecast  |
| E                     | empty, east  | FD                        | Course From Fix to DME Distance   |
| ECU                   | Engine Control Unit  | FD                        | flight director   |
| Efficiency            | A measure of fuel consumption, expressed in distance per unit of fuel  | FDE                       | Fault Detection and Exclusion   |
|                       |  | FFLOW                     | fuel flow   |
| EGT                   | Exhaust Gas Temperature  | FIS-B                     | Flight Information Services-Broadcast   |
| EIS                   | Engine Indication System   |                           |   |
| ELEV                  | elevation  | FISDL                     | Flight Information Service Data Link  |
| ELEV                  | elevator   | FL                        | flight level  |
| EMERGCY               | emergency  | FLC                       | Flight Level Change   |
| EMI                   | Electromagnetic Interference   | FM                        | Course From Fix to Manual Termination   |
| ENDUR                 | endurance  |                           |   |

|               |  |                            |   |
|---------------|--|----------------------------|---|
| FMS           | Flight Management System   | Heading                    | The direction an aircraft is pointed, based upon indications from a magnetic compass or a properly set directional gyro |
| FOB           | Fuel On Board  |                            |   |
| FPL           | flight plan  |                            |   |
| fpm           | feet per minute  |                            |   |
| FREQ          | frequency  | HF                         | Hold Terminating at Fix   |
| FRZ           | freezing   | HFOM                       | Horizontal Figure of Merit  |
| FSS           | Flight Service Station   | Hg                         | mercury   |
| ft            | foot/feet  | HI                         | high  |
| Fuel Flow     | The fuel flow rate, expressed in units of fuel per hour  | HI SENS                    | High Sensitivity  |
| Fuel On Board | The total amount of usable fuel on board the aircraft  | HM                         | Hold with Manual Termination  |
|               |  | Horizontal Figure of Merit | A measure of the uncertainty in the aircraft's horizontal position  |
|               |  | hPa                        | hectopascal   |
| G/S, GS       | glideslope   | HPL                        | Horizontal Protection Level   |
| GA            | go-around  | hr                         | hour  |
| gal, gl       | gallon(s)  | HSDB                       | High-Speed Data Bus   |
| GBOX          | gearbox  | HSI                        | Horizontal Situation Indicator  |
| GDC           | Garmin Air Data Computer   | HT                         | heat  |
| GDL           | Garmin Satellite Data Link   | HUL                        | Horizontal Uncertainty Level  |
| GDU           | Garmin Display Unit  | Hz                         | Hertz   |
| GEA           | Garmin Engine/Airframe Unit  | I                          | Inner Marker  |
| GEO           | geographic   | IAF                        | Initial Approach Fix  |
| GFC           | Garmin Flight Control  | IAT                        | Indicated Air Temperature   |
| GIA           | Garmin Integrated Avionics Unit  | IAU                        | Integrated Avionics Unit  |
| GLS           | Global Navigation Satellite Landing System   | ICAO                       | International Civil Aviation Organization   |
| GMA           | Garmin Audio Panel System  | ICS                        | Intercom System   |
| GMT           | Greenwich Mean Time  | ID                         | Identification/Morse Code Identifier  |
| GMU           | Garmin Magnetometer Unit   | IDENT, IDNT                | identification  |
| GND           | ground   | IF                         | Initial Fix   |
| gph           | gallons per hour   | IFR                        | Instrument Flight Rules   |
| GPS           | Global Positioning System  | IG                         | Imperial gallon   |
| Grid MORA     | Grid Minimum Off-Route Altitude; one degree latitude by one degree longitude in size and clears the highest elevation reference point in the grid by 1000 feet for all areas of the grid | ILS                        | Instrument Landing System   |
|               |  | IMC                        | Instrument Meteorological Conditions  |
|               |  | in                         | inch  |
| Groundspeed   | The velocity that the aircraft is travelling relative to a ground position   | INACTV                     | inactive  |
|               |  | INC FUEL                   | increase fuel   |
|               |  | IND                        | indicated   |
| Ground Track  | <i>see Track</i>   | Indicated                  | Information provided by properly calibrated and set instrumentation on the aircraft panel                               |
| GRS           | Garmin Reference System  | INFO                       | information   |
| GS            | Ground speed   | in HG                      | inches of mercury   |
| GTX           | Garmin Transponder   | INT                        | intersection(s)   |
|               |  | INTEG                      | integrity (RAIM unavailable)  |
| HA            | Hold Terminating at Altitude   | IrDA, IRDA                 | Infrared Data Association   |
| HDG           | heading  |                            |   |
|               |  | KEYSTK                     | key stuck   |
|               |  | kg                         | kilogram  |

|                         |  |                       |  |
|-------------------------|--|-----------------------|--|
| kHz                     | kilohertz  | MEPT                  | manual electric pitch trim   |
| km                      | kilometer  | MFD                   | Multi Function Display   |
| kt                      | knot   | MGRS                  | Military Grid Reference System   |
|                         |  | MHz                   | megahertz  |
| L                       | left, left runway  | MIC                   | microphone   |
| LAT                     | latitude   | MIN                   | minimum  |
| LBL                     | label  | Minimum Safe Altitude | Uses Grid MORAs to determine a safe altitude within ten miles of the aircraft present position |
| lb                      | pound  |                       |  |
| LCD                     | Liquid Crystal Display   | MKR                   | marker beacon  |
| LCL                     | local  | MOA                   | Military Operations Area   |
| LED                     | Light Emitting Diode   | MOV                   | movement   |
| Left Over Fuel On Board | The amount of fuel remaining on board after the completion of one or more legs of a flight plan or direct-to   | mpm                   | meters per minute  |
| Left Over Fuel Reserve  | The amount of flight time remaining, based on the amount of fuel on board after the completion of one or more legs of a flight plan or direct-to, and a known consumption rate | MSA                   | Minimum Safe Altitude  |
|                         |  | MSG                   | message  |
| Leg                     | The portion of a flight plan between two waypoints   | MSL                   | Mean Sea Level   |
|                         |  | MT                    | meter  |
| LIFR                    | Low Instrument Flight Rules  | mV                    | millivolt(s)   |
| LNAV                    | Lateral Navigation   | MVFR                  | Marginal Visual Flight Rules   |
| LO                      | low  |                       |  |
| LOC                     | localizer  | N                     | north  |
| LOI                     | loss of integrity (GPS)  | NAV                   | navigation   |
| LON                     | longitude  | NAVAID                | NAVigation AID   |
| LPV                     | Localizer Performance with Vertical guidance   | NDB                   | Non-directional Beacon   |
|                         |  | NEXRAD                | Next Generation Radar  |
| LRU                     | Line Replacement Unit  | nm                    | nautical mile(s)   |
| LT                      | left   | NPT                   |  |
| LTNG                    | lightning  | NRST                  | nearest  |
| LVL                     | level  |                       |  |
|                         |  | O                     | Outer Marker   |
| M                       | Middle Marker  | OAT                   | Outside Air Temperature  |
| m                       | meter  | OBS                   | Omni Bearing Selector  |
| MAG                     | Magnetic   | OFST                  | offset   |
| MAG VAR                 | Magnetic Variation   | OXY                   | oxygen   |
| MAHP                    | Missed Approach Hold Point   |                       |  |
| MAN IN                  | manifold pressure (inches Hg)  | P ALT                 | pressure altitude  |
| MAN SQ                  | Manual Squelch   | PA                    | Passenger Address  |
| MAP                     | Missed Approach Point  | PA                    | Proximity Advisory   |
| MASQ                    | Master Avionics Squelch  | PASS                  | passenger(s)   |
| MAX                     | maximum  | PC                    | personal computer  |
| MAXSPD                  | maximum speed (overspeed)  | PDF                   | Primary Flight Display   |
| MDA                     | barometric minimum descent altitude  | PI                    | Procedure Turn to Course Intercept   |
|                         |  | PIT, PTCH             | pitch  |
| MET                     | manual electric trim   | POSN                  | position   |
| METAR                   | Meteorological Aviation Routine  | PPM                   | parts per million  |
|                         |  | P. POS                | Present Position   |
|                         |  | PRES, PRESS           | pressure   |
|                         |  | PROC                  | procedure(s), procedure turn   |
|                         |  | psi                   | pounds per square inch   |
|                         |  | PT                    | Procedure Turn   |

|           |  |                   |   |
|-----------|--|-------------------|---|
| PTK       | parallel track                           | SMBL              | symbol  |
| PTT       | Push-to-Talk                             | SPD               | speed   |
| PWR       | power                                    | SPI               | Special Position Identification   |
|           |  | SPKR              | speaker   |
| QTY       | quantity                                 | SQ                | squelch   |
|           |  | SRVC, SVC         | service   |
| R         | right, right runway                      | STAL              | stall   |
| RAD       | radial                                   | STAR              | Standard Terminal Arrival Route   |
| RAIM      | Receiver Autonomous Integrity Monitoring | STATS             | statistics  |
|           |  | STBY              | standby   |
| RAM       | random access memory                     | STD               | standard  |
| REF       | reference                                | STRMSCP           | Stormscope  |
| REM       | remaining (fuel remaining)               | SUA               | Special Use Airspace  |
| REQ       | required                                 | SUSP              | suspend   |
| RES       | reserve (fuel reserve entered by pilot)  | SW                | software  |
|           |  | SYS               | system  |
| REV       | reverse, revision, revise                |                   |   |
| RF        | Constant Radius Turn to Fix              | T                 | true  |
| RMI       | Radio Magnetic Indicator                 | TA                | Traffic Advisory  |
| RMT       | remote                                   | TACAN             | Tactical Air Navigation System  |
| RNG       | range                                    | TAF               | Terminal Aerodrome Forecast   |
| RNWX      | runway                                   | TAS               | True Airspeed   |
| ROL       | roll                                     | TAS               | Traffic Advisory System   |
| ROM       | read only memory                         | TAT               | Total Air Temperature   |
| rpm       | revolutions per minute                   | TAWS              | Terrain Awareness and Warning System  |
| RST FUEL  | reset fuel                               |                   |   |
| RSV       | reserve (fuel reserve entered by pilot)  | TCA               | Terminal Control Area   |
|           |  | TCAS              | Traffic Collision Avoidance System  |
| RT        | right                                    | TEL               | telephone   |
| RVRSNRY   | reversionary                             | TEMP              | temperature   |
| RX        | receive                                  | TERM              | terminal  |
|           |  | TF                | Track Between Two Fixes   |
| S         | south                                    | TFR               | Temporary Flight Restriction  |
| SA        | Selective Availability                   | T HDG             | True Heading  |
| SAT       | Static Air Temperature                   | TIS               | Traffic Information System  |
| SBAS      | Satellite-Based Augmentation System      | TIT               | Turbine Inlet Temperature   |
|           |  | TKE               | Track Angle Error   |
| SCIT      | Storm Cell Identification and Tracking   | TMA               | Terminal Maneuvering Area   |
|           |  | TMR/REF           | Timer/Reference   |
| SD        | Secure Digital                           | Topo              | topographic   |
| sec       | second(s)                                | Track             | Direction of aircraft movement relative to a ground position; also 'Ground Track' |
| SEL, SLCT | select                                   |                   |   |
| SFC       | surface                                  | Track Angle Error | The angle difference between the desired track and the current track              |
| SIAP      | Standard Instrument Approach Procedures  |                   |   |
|           |  | TRG               | target  |
| SID       | Standard Instrument Departure            | TRK               | track   |
| SIGMET    | Significant Meteorological Information   | TRSA              | Terminal Radar Service Area   |
|           |  | TRUNC             | truncated   |
| Sim       | simulator                                | TTL               | total   |
| SLP/SKD   | slip/skid                                |                   |   |

|                          |  |           |   |
|--------------------------|--|-----------|---|
| TURN                     | procedure turn   | VMC       | Visual Meteorological Conditions  |
| TX                       | transmit   | VNAV, VNV | vertical navigation   |
|                          |  | VOL       | volume  |
| UNAVAIL                  | unavailable  | VOR       | VHF Omni-directional Range  |
| USR                      | user   | VORTAC    | very high frequency omnidirectional range station and tactical air navigation |
| UTC                      | Coordinated Universal Time   |           |   |
| UTM/UPS                  | Universal Transverse Mercator/<br>Universal Polar Stereographic Grid   | VPL       | Vertical Protection Level   |
|                          |  | VPROF     | VNV profile, vertical profile   |
| V, Vspeed                | velocity (airspeed)  | VPTH      | VNV path, vertical path   |
| VA                       | Heading Vector to Altitude   | VR        | Heading Vector to Radial  |
| VAPP                     | VOR approach   | VS        | vertical speed  |
| VAR                      | variation  | VSI       | Vertical Speed Indicator  |
| VD                       | Heading Vector to DME Distance   | VSR       | Vertical Speed Required   |
| Vdc                      | volts, direct current  | VTF       | vector to final   |
| VERT                     | vertical   |           |   |
| Vertical Figure of Merit | A measure of the uncertainty in the aircraft's vertical position   | W         | watt(s), west   |
| Vertical Speed Required  | The vertical speed necessary to descend/climb from a current position and altitude to a defined target position and altitude, based upon current groundspeed | WAAS      | Wide Area Augmentation System   |
|                          |  | WARN      | warning (GPS position error)  |
|                          |  | WGS-84    | World Geodetic System - 1984  |
|                          |  | WPT       | waypoint(s)   |
|                          |  | WW        | world wide  |
|                          |  | WX        | weather   |
| VFOM                     | Vertical Figure of Merit   |           |   |
| VFR                      | Visual Flight Rules  | XFER, XFR | transfer  |
| VHF                      | Very High Frequency  | XPDR      | transponder   |
| VI                       | Heading Vector to Intercept  | XTALK     | cross-talk  |
| VLOC                     | VOR/Localizer Receiver   | XTK       | cross-track   |
| VM                       | Heading Vector to Manual Termination   |           |   |

## FREQUENTLY ASKED QUESTIONS

If a particular aspect of G1000 operational capability is not addressed by these commonly asked questions or in the index, contact Garmin (see the copyright page or back cover for contact information) or a Garmin-authorized dealer. Garmin is dedicated to supporting its products and customers.

### WHAT IS WAAS?

The Wide Area Augmentation System (WAAS) uses a system of ground stations to correct any GPS signal errors. These ground stations correct for errors caused by ionospheric disturbances, timing, and satellite orbit errors. It also provides vital integrity information regarding the health of each GPS satellite. The signal correction is then broadcast through one of two geostationary satellites. This correction information can then be received by any WAAS-enabled GPS receiver.

WAAS is designed to provide the additional accuracy, availability, and integrity necessary to enable users to rely on GPS for all phases of flight. WAAS is currently available in the United States, including Alaska and Hawaii.

### HOW DOES WAAS AFFECT APPROACH OPERATIONS?

Both LNAV/VNAV and LPV approaches use the accuracy of WAAS to include vertical (glide path) guidance capability. The additional accuracy and vertical guidance capability allows improved instrument approaches to an expanded number of airports throughout the U.S.

The implementation of LPV approaches further improves precision approach capabilities. LPV approaches are designed to make full use of the improved GPS signal from the WAAS. This approach combines the LNAV/VNAV vertical accuracy with lateral guidance similar to the typical Instrument Landing System (ILS). LPV approaches allow lower approach minimums.

If WAAS is not available for the final approach course, the approach downgrades, as indicated by the “Approach downgraded. Use LNAV minima.” message.

### WHAT IS RAIM AND HOW DOES IT AFFECT APPROACH OPERATIONS?

When WAAS is unavailable, the GPS receivers use Receiver Autonomous Integrity Monitoring (RAIM) to perform the following functions:

- Monitor and verify integrity and geometry of tracked GPS satellites
- Notify pilot when satellite conditions do not provide necessary coverage to support a certain phase of flight
- Predict satellite coverage of a destination area to determine whether the number of available satellites is sufficient to satisfy requirements (refer to the System Overview Section for instructions on RAIM prediction)
- Detect and exclude bad satellites from the navigation solution (Fault Detection and Exclusion, FDE)

RAIM ensures that satellite geometry allows for a navigation solution calculation within a specified protection limit (4.0 nm for oceanic, 2.0 nm for enroute, 1.0 nm for terminal, and 0.3 nm for non-precision approaches). Without WAAS or RAIM, GPS position accuracy integrity cannot be monitored.

## WHY MIGHT THERE BE NO APPROACHES AVAILABLE FOR A FLIGHT PLAN?

Approaches are available for the final destination airport in a flight plan or as a direct-to (keep in mind that some VOR/VORTAC identifiers are similar to airport identifiers). If a destination airport does not have a published approach, the G1000 indicates “NONE” for the available procedures.

## WHAT HAPPENS WHEN AN APPROACH IS SELECTED? CAN A FLIGHT PLAN WITH AN APPROACH, A DEPARTURE, OR AN ARRIVAL BE STORED?

When an approach, departure, or arrival is loaded into the active flight plan, a set of approach, departure, or arrival waypoints is inserted into the flight plan, along with a header line showing the title of the selected instrument procedure. The original enroute portion of the flight plan remains active, unless the instrument procedure is activated. This may be done either when the procedure is loaded or at a later time.

Flight plans can also be stored with an approach, a departure, or an arrival. Note that the active flight plan is erased when the system is turned off. Also, the active flight plan is overwritten when another flight plan is activated. When storing flight plans with an approach, a departure, or an arrival, the G1000 uses the waypoint information from the current database to define the waypoints. If the database is changed or updated, the G1000 System automatically updates the information, provided the procedure has not been modified. Should an approach, departure, or arrival procedure no longer be available, the flight plan becomes locked until the procedure is deleted from the flight plan.

## CAN “SLANT GOLF” (“/G”) BE FILED USING THE G1000?

“/G” may be filed for a flight plan. The G1000 System meets the requirements of TSO-C129 Class A1 or A2 installation. GPS approaches are not to be flown with an expired database. See the approved Airplane Flight Manual (AFM) as well as the Aeronautical Information Manual (AIM) for more information.

## WHAT DOES THE OBS SOFTKEY DO?

The **OBS** Softkey is used to select manual sequencing of waypoints. Activating OBS mode sets the current active-to waypoint as the primary navigation reference and prevents the system from sequencing to the next waypoint in a flight plan. When OBS mode is cancelled, automatic waypoint sequencing is continued, and the G1000 automatically activates the next waypoint in the flight plan once the aircraft has crossed the present active waypoint.

### Normal (OBS not activated)

- Automatic sequencing of waypoints
- Manual course change on HSI not possible
- Always navigates ‘TO’ the active waypoint
- Must be in this mode for final approach course

### OBS

- Manual sequencing - ‘holds’ on selected waypoint
- Manually select course to waypoint from HSI
- Indicates ‘TO’ or ‘FROM’ waypoint
- Cannot be set for final approach course or published holding patterns



When OBS mode is active, the G1000 allows the pilot to set a desired course to/from a waypoint using the **CRS/BARO** Knob and HSI (much like a VOR).

The most common application for using the **OBS** Softkey is the missed approach. The G1000 suspends automatic waypoint sequencing (indicated by a 'SUSP' annunciation placed on the HSI) when the missed approach point (MAP) is crossed. This prevents the G1000 from automatically sequencing to the missed approach holding point (MAHP). During this time, the **OBS** Softkey designation changes to **SUSP**. Selecting the **SUSP** Softkey reactivates automatic waypoint sequencing. The **OBS** Softkey then resumes its normal functionality.

### WHY MIGHT THE G1000 NOT AUTOMATICALLY SEQUENCE TO THE NEXT WAYPOINT?

The G1000 only sequences flight plan waypoints when automatic sequencing is enabled (i.e., no 'OBS' or 'SUSP' annunciation on the HSI). For automatic sequencing to occur, the aircraft must also cross the *bisector* of the turn being navigated. The bisector is a line passing through the waypoint common to two flight plan legs at an equal angle from each leg.

### HOW CAN A WAYPOINT BE SKIPPED IN AN APPROACH, A DEPARTURE, OR AN ARRIVAL?

The G1000 allows the pilot to manually select any approach, departure, or arrival leg as the active leg of the flight plan. This procedure is performed on the MFD from the Active Flight Plan Page by highlighting the desired waypoint and selecting the **ACT LEG** Softkey then the **ENT** Key to approve the selection. The GPS then provides navigation along the selected flight plan leg.

### WHEN DOES TURN ANTICIPATION BEGIN?

The G1000 smooths adjacent leg transitions based on a normal 15° bank angle (with the ability to roll up to 30°) and provides three pilot cues for turn anticipation:

- A waypoint alert ('Next DTK ###° in # seconds' or 'Next HDG ###° in # seconds') appears on the PFD 10 seconds before the turn point and flashes as it counts down to zero.
- A flashing turn advisory ('Turn [right/left] to ###° in # seconds') appears on the PFD 10 seconds before the turn and flashes as it counts down to zero. 'Turn [right/left] to ###° now' or 'Next [DTK/HDG] to ###° now' is displayed when the pilot is to begin the turn and the HSI (GPS mode) automatically sequences to the next DTK or HDG value.
- The To/From indicator on the HSI flips momentarily to indicate that the midpoint of the turn has been crossed.

### WHEN DOES THE CDI SCALE CHANGE?

Once a departure is activated, the G1000 Course Deviation Indicator (CDI) full scale deflection is set to 0.3 nm. The CDI scale changes to 1.0 nm (terminal mode) then ramps up to 2.0 nm (enroute mode) at 30 nm from the departure airport. When 31 nm from the destination, the CDI scale smoothly transition from 2.0 nm back to 1.0 nm (terminal mode). At 2.0 nm before the FAF during an active approach, the CDI scale transitions down further based on the type of approach activated (LNAV, LNAV/VNAV, LPV). When a missed approach is activated, the CDI is set to 0.3 nm. See the Flight Instruments Section for more details on CDI scaling.

### WHY DOES THE HSI NOT RESPOND LIKE A VOR WHEN OBS MODE IS ACTIVE?

Unlike a VOR, the CDI scale used on GPS equipment is based on the crosstrack distance to the desired course, not on the angular relationship to the destination. Therefore, the CDI deflection on the GPS is constant regardless of the distance to the destination and does not become less sensitive when further away from the destination.

### WHAT IS THE CORRECT MISSED APPROACH PROCEDURE? HOW IS THE MISSED APPROACH HOLDING POINT SELECTED?

To comply with TSO specifications, the G1000 does not automatically sequence past the MAP. The first waypoint in the missed approach procedure becomes the active waypoint when the **SUSP** Softkey is selected *after* crossing the MAP. All published missed approach procedures must be followed, as indicated on the approach plate.

To execute the missed approach procedure prior to the MAP (not recommended), select the Active Flight Plan Page and use the **ACT LEG** Softkey to activate the missed approach portion of the procedure.

### AFTER A MISSED APPROACH, HOW CAN THE SAME APPROACH BE RE-SELECTED? HOW CAN A NEW APPROACH BE ACTIVATED?



---

**NOTE:** Do not attempt to reactivate the current approach prior to crossing the missed approach point (MAP). If an attempt to do so is made, an alert message “Are you sure you want to discontinue the current approach?” appears. The G1000 directs the pilot back to the transition waypoint and does not take into consideration any missed approach procedures, if the current approach is reactivated.

---

After flying the missed approach procedure, the pilot may reactivate the same approach for another attempt by pressing the **PROC** Key. Once the clearance is given for another attempt, activate the approach by highlighting ‘ACTIVATE APPROACH’ using the large **FMS** Knob and pressing the **ENT** Key. The G1000 provides navigation along the desired course to the waypoint and rejoins the approach in sequence from that point.

To activate a new approach for the same airport, select the new procedure by pressing the **PROC** Key. Choose ‘SELECT APPROACH’, select the desired approach from the list shown, and press the **ENT** Key. Select the desired transition, then activate the approach using the **ENT** Key.

To activate a new approach to a different airport, press the **Direct-to** Key and select the desired airport using the **FMS** Knobs. Press the **ENT** Key to accept the selected airport, then follow the steps in the preceding paragraph to select an approach for the new airport.

## GENERAL TIS INFORMATION



---

**NOTE:** Aircraft without an operating transponder are invisible to TIS.

---



---

**NOTE:** TIS is not intended to be used as a collision avoidance system and does not relieve the pilot of the responsibility to “see and avoid” other aircraft. TIS should not be used for avoidance maneuvers during instrument meteorological conditions (IMC) or when there is no visual contact with the intruder aircraft.

---

The Traffic Information Service (TIS) provides traffic advisory information to non-TAS/TCAS-equipped aircraft. TIS is a ground-based service providing the relative locations of all ATCRBS Mode-A and Mode-C transponder equipped aircraft within a specified service volume. The TIS ground sensor uses real-time track reports to generate traffic notification. The G1000 System displays TIS traffic information on the Traffic Map Page of the MFD. TIS information may also be displayed for overlay on the MFD Navigation Map Page, as well as on the PFD Inset Map. Surveillance data includes all transponder-equipped aircraft within the coverage volume. The G1000 System displays up to eight traffic targets within a 7.5-nm radius, from 3,000 feet below, to 3,500 feet above the requesting aircraft.

The main difference between the Traffic Information System (TIS) and Traffic Advisory (TAS) or Traffic Collision Avoidance Systems (TCAS) is the source of surveillance data. TAS/TCAS uses an airborne interrogator with a half-second update rate, while TIS utilizes the terminal Mode-S ground interrogator and accompanying data link to provide a five-second update rate. TIS and TAS/TCAS have similar ranges.

TIS relies on surveillance of the Mode-S radar system, which is a “secondary surveillance” radar system similar to that used by ATCRBS. Many limitations are inherent in secondary radar surveillance. Information provided by TIS is neither better nor more accurate than the information used by ATC. TIS is intended only to assist in visual acquisition of other aircraft in visual meteorological conditions (VMC). While TIS is a useful aid for visual traffic avoidance, system limitations must be considered to ensure proper use. No recommended avoidance maneuvers are given, nor authorized, as a direct result of a TIS intruder display or TIS advisory.

- TIS operation may be intermittent during turns or other maneuvering.
- TIS is dependent on two-way, line-of-sight communications between the aircraft and the Mode-S radar antenna. Whenever the structure of the aircraft comes between the transponder antenna and the ground-based radar antenna, the signal may be temporarily interrupted.



---

**NOTE:** Refer to the TIS Limitations section of the Aeronautical Information Manual (AIM) for a more comprehensive explanation of limitations and anomalies associated with TIS.

---



---

**NOTE:** TIS is unavailable at low altitudes in many areas of the United States. This is often the case in mountainous regions.

---



**WARNING:** *Garmin is not responsible for Mode S geographical coverage. Operation of the ground stations is the responsibility of the FAA. Refer to the AIM for a Terminal Mode S radar site map.*

TIS information is collected during a single radar sweep. Collected information is then sent through the Mode S uplink on the next radar sweep. Because of this, the surveillance information is approximately five seconds old. TIS ground station tracking software uses prediction algorithms to compensate for this delay. These algorithms use track history data to calculate expected intruder positions consistent with the time of display. Occasionally, aircraft maneuvering may cause variations in this calculation and create slight errors on the Traffic Map Page which affect relative bearing information and the target track vector and may delay display of the intruder information. However, intruder distance and altitude typically remain relatively accurate and may be used to assist in spotting traffic. The following errors are common examples:

- When the client or intruder aircraft maneuvers excessively or abruptly, the tracking algorithm may report incorrect horizontal position until the maneuvering aircraft stabilizes.
- When a rapidly closing intruder is on a course that intercepts the client aircraft course at a shallow angle (either overtaking or head-on) and either aircraft abruptly changes course within 0.25 nm, TIS may display the intruder aircraft on the incorrect side of the client aircraft.

These are rare occurrences and are typically resolved within a few radar sweeps once the client/intruder aircraft course stabilizes.

Pilots using TIS can provide valuable assistance in the correction of malfunctions by reporting observations of undesirable performance. Reports should identify the time of observation, location, type and identity of the aircraft, and describe the condition observed. Reports should also include the type of transponder and transponder software version. Since TIS performance is monitored by maintenance personnel, not ATC, malfunctions should be reported in the following ways:

- By telephone to the nearest Flight Service Station (FSS) facility
- By FAA Form 8000-7, Safety Improvement Report (postage-paid card can be obtained at FAA FSSs, General Aviation District Offices, Flight Standards District Offices, and General Aviation Fixed Base Operators)

## MAP SYMBOLS

### AIRPORTS

| Item                              | Symbol |
|-----------------------------------|--------|
| Unknown Airport                   |        |
| Non-towered, Non-serviced Airport |        |
| Towered, Non-serviced Airport     |        |
| Non-towered, Serviced Airport     |        |
| Towered, Serviced Airport         |        |
| Restricted (Private) Airport      |        |
| Heliport                          |        |

### NAVAIDS

| Item                                  | Symbol |
|---------------------------------------|--------|
| Intersection                          |        |
| LOM (compass locator at outer marker) |        |
| NDB (non-directional radio beacon)    |        |
| VOR                                   |        |
| VOR/DME                               |        |
| VOR/ILS                               |        |
| VORTAC                                |        |
| TACAN                                 |        |

### BASEMAP

| Item                  | Symbol |
|-----------------------|--------|
| Interstate Highway    |        |
| State Highway         |        |
| US Highway            |        |
| National Highway      |        |
| City                  |        |
| State/Province Border |        |
| International Border  |        |
| Road                  |        |
| Railroad              |        |
| Latitude/Longitude    |        |

### AIRSPACE BOUNDARIES

| Item                           | Symbol |
|--------------------------------|--------|
| ICAO Control Area              |        |
| Class B Airspace               |        |
| Mode C Tower Area              |        |
| Warning Area                   |        |
| Alert Area                     |        |
| Caution Area                   |        |
| Danger Area                    |        |
| Prohibited Area                |        |
| Restricted Area                |        |
| Training Area                  |        |
| Unknown Area                   |        |
| Class C                        |        |
| Terminal Radar Service Area    |        |
| Mode C Area                    |        |
| Military Operations Area (MOA) |        |

### HAZARD AVOIDANCE FEATURES

| Feature   | Symbol |
|---|--------|
| Terrain Proximity/TAWS display enabled                  |        |
| Traffic display enabled                                 |        |
| NEXRAD display enabled                                  |        |
| Cloud Top display enabled                               |        |
| Echo Top display enabled                                |        |
| XM Lightning display enabled                            |        |
| Cell Movement display enabled                           |        |
| SIGMETs/AIRMETs display enabled                         |        |
| METARs display enabled                                  |        |
| City Forecast display enabled                           |        |
| Surface Analysis display enabled                        |        |
| Freezing Levels display enabled                         |        |
| Winds Aloft display enabled                             |        |
| County Warnings display enabled                         |        |
| Cyclone Warnings display enabled                        |        |
| Loss of hazard avoidance feature (loss of GPS position) |        |

### TRAFFIC

| Item                           | Symbol |
|--------------------------------|--------|
| Non-threat Traffic             |        |
| Proximity Advisory             |        |
| Traffic Advisory, Out of Range |        |
| Traffic Advisory               |        |

### MISCELLANEOUS

| Item   | Symbol |
|--|--------|
| ARTCC Frequency or FSS Frequency                     |        |
| Map Pointer (when panning)                           |        |
| Elevation Pointer (on Topography Scale when panning) |        |
| Measuring Pointer                                    |        |
| Wind Vector  |        |
| Overzoom Indicator                                   |        |
| User Waypoint  |        |
| Vertical Navigation Along Track Waypoint             |        |
| Parallel Track Waypoint                              |        |
| Unanchored Flight Path Waypoint                      |        |
| Top of Descent (TOD)                                 |        |
| Bottom of Descent (BOD)                              |        |
| Navigating using Dead Reckoning                      |        |

OBSTACLE DATABASE

| Unlighted Obstacle |             | Lighted Obstacle |             | Obstacle Location   |
|--------------------|-------------|------------------|-------------|---|
| < 1000' AGL        | > 1000' AGL | < 1000' AGL      | > 1000' AGL |   |
|                    |             |                  |             | Red obstacle is above or within 100 ft below the aircraft altitude        |
|                    |             |                  |             | Yellow obstacle is between 100 ft and 1000 ft below the aircraft altitude |
|                    |             |                  |             | Gray obstacle is more than 1000 ft below aircraft altitude                |

Table G-1 Obstacle Colors

TERRAIN AVOIDANCE COLORS AND SYMBOLS

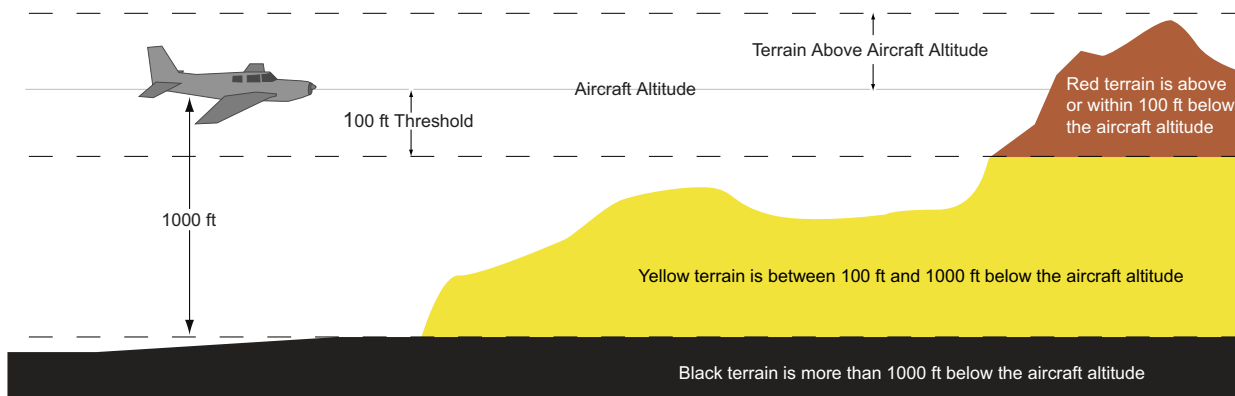

Figure G-1 Terrain Altitude/Color Correlation



Figure G-2 TAWS Potential Impact Points

**BLANK PAGE**



**SYMBOLS**

360 HSI-----2-10

**A**

 Active channel-----8-50  
 Active frequency -----4-6, 4-15  
     ADF-----4-24  
 ADF  
     ADF mode-----4-24, 4-26  
     ANT mode-----4-26  
     Volume-----4-24  
 ADF/BFO -----4-26  
 ADF/DME tuning-----4-27  
 ADF volume-----4-26  
 AFCS Status Box -----2-2  
 AHRS-----A-14  
 Airport  
     Frequency -----5-59  
     Information -----5-58, 5-63, 5-75  
     Nearest -----5-57–5-60, 5-74–5-75  
     Runway-----5-58  
 Airspace  
     Boundary-----5-14  
 Airspeed Indicator -----2-2, 2-4–2-5  
 Airspeed Reference-----7-11  
 Airspeed Trend Vector -----2-4  
 Air Data Computer (ADC) -----1-3  
 Alerting system-----A-1  
 Alerts -----A-1  
     Aircraft-----A-4  
     Audio voice -----A-4  
 Alerts Window-----2-25  
 Alert levels-----A-3  
 ALT -----5-136  
 Altimeter -----2-2, 2-7–2-8  
 Altimeter barometric setting -----2-2  
 Altitude alerting-----2-27  
 Altitude capture-----7-8, 7-16  
 Altitude constraints-----5-105, 5-124  
 Altitude Hold Mode (ALT)-----7-9  
 Altitude Reference-----7-8, 7-9, 7-16  
 Altitude restrictions-----5-107  
 Altitude Trend Vector -----2-8  
 Ammeter -----3-2, 3-4, 3-12  
 Annunciations  
     AFCS Status-----A-17  
     G1000 System-----1-10, A-5–A-6  
     TAWS Status-----A-19  
     Test tone-----1-12, A-2  
 Annunciations, softkey-----2-25  
 Annunciation Window -----2-3, 2-25  
 Annunciator lights-----4-35

 ANT/BFO-----4-26  
 Approach-----D-2  
     Activate-----5-165  
     ILS -----7-38  
     Missed -----7-40  
     Select-----5-164  
     WAAS -----7-39  
 Approach box -----8-32  
 Approach Mode, AFCS -----7-25, 7-38, 7-39  
 APR softkey-----5-157  
 Arc HSI-----2-11  
 Arrival  
     Remove-----5-160  
     Select-----5-163  
 Assist, engine leaning-----3-8, 3-12  
 Attitude and Heading Reference System (AHRS) 1-3, 1-8, 1-13–1-14  
 Attitude Indicator -----2-2, 2-6–2-7  
 Audio alerting system-----A-2  
 Audio Panel-----1-2, 1-10  
 Audio panel controls  
     SPKR -----4-35  
 Audio panel fail-safe operation-----4-41  
 Auto-tuning-----4-22  
 Auto-tuning, COM-----4-9  
 Auto-tuning, NAV-----4-18  
 Automatic audio muting-----8-53  
 Automatic Flight Control System (AFCS)--1-1, 7-1–7-44  
     Controls -----7-2–7-3  
     Example procedures -----7-29–7-36  
     Status Annunciations-----7-42  
     Status Box-----7-4  
 Automatic squelch-----4-14  
 Autopilot -----7-1, 7-27–7-28  
     Disconnect -----7-3, 7-19, 7-28  
 Auto zoom-----5-5  
 Auxiliary Pages (AUX)-----1-31  
 AUX - System Status page-----8-5, 8-6, 8-27, 8-28, 8-45, 8-46  
 Aviation map data-----5-13–5-14

**B**

 Backlighting -----1-44  
 Barometric setting, Altimeter-----2-2, 2-8–2-9  
 Bearing/distance, measuring-----5-26  
 Bearing information -----2-13–2-14  
 Bearing Information Windows -----2-3  
 Bearing source -----2-14

**C**

 CDI-----5-113, 5-124, 5-131, 5-138  
 ChartView-----8-1, 8-7, 8-27, 5-27

ChartView database-----8-25, 8-26, 8-27, 8-28  
 ChartView functions----- 8-7  
 ChartView plan view-----8-19  
 ChartView profile View-----8-20  
 ChartView softkeys----- 8-7  
 ChartView subscription-----8-27  
 Chart Not Available-----8-8, 8-30  
 Chart Not To Scale----- 8-10, 8-32  
 Chart options-----8-18, 8-38  
 Chart setup box-----8-23, 8-41  
 Chart setup menu-----8-23, 8-41  
 Checklists-----1-42–1-43  
 Command Bars, flight director-----7-5  
 Communication (COM) Frequency Box-----2-2  
 COM channel spacing-----4-13  
 COM frequency  
   Select-----5-75  
 COM frequency box-----4-3, 4-6  
 COM tuning failure-----4-41  
 Controls  
   AFCS-----7-2–7-3  
   PFD/MFD-----1-18–1-19, 1-28  
   Softkeys-----1-20–1-23  
 Control Wheel Steering (CWS)-----7-3, 7-28  
 Course Deviation Indicator (CDI)-----2-15–2-16, 5-39  
   Changing scale-----D-3  
 Cylinder Head Temperature (CHT)-----3-2, 3-4, 3-11

**D**

Databases-----1-7, 1-8, 1-12, B-1  
 Data entry-----1-27–1-28  
 Data Link Receiver-----1-4  
 Data Link Receiver troubleshooting-----8-54, A-20  
 Date and time-----1-34  
 Day/Night views-----8-23, 8-41  
 Day view-----8-23, 8-24, 8-41, 8-42  
 Dead Reckoning-----2-30  
 Decision Height (DH)-----2-3, 2-28  
 Declutter-----5-29, 8-2  
   Levels-----5-20  
 Declutter, display-----2-31  
 Declutter maps-----1-21, 1-26  
 Departure  
   Select-----5-150, 5-162  
   Timer-----1-40  
 Departure procedure chart-----8-13, 8-35  
 Dilution of Precision (DOP)-----1-17  
 Direct-to-----5-37, 5-38, 5-122, 5-124  
 Direct-to navigation-----5-75  
   Cancel-----5-35  
   Select course-----5-35  
 Display backup-----1-10, 4-5, 4-41  
 Display controls-----1-18–1-25

DME  
   HOLD mode-----4-27  
   NAV1 mode-----4-27  
   NAV2 mode-----4-27  
   Tuning mode-----4-24, 4-27  
 DME Information Window-----2-14

**E**

EIS Display-----3-2  
 Electronic checklists-----1-42–1-43  
 Emergency frequency-----4-41  
 Endurance, calculated-----3-4, 3-6  
 Engine Airframe Unit-----1-3  
 Engine Indication System (EIS)-----3-1–3-14  
 Engine Manifold Pressure-----3-2, 3-4, 3-11, 3-12  
 Engine Page-----3-4  
 Entering Flight ID-----4-28  
 Entertainment inputs-----4-39  
 Estimated Position Error (EPE)-----1-17  
 Exhaust Gas Temperature (EGT)-----3-4, 3-8, 3-11

**F**

Flight director-----7-1, 7-4–7-5  
   Pitch modes-----7-6–7-12  
   Roll modes-----7-20–7-35  
 Flight ID-----4-34  
 Flight Level Change Mode (FLC)-----7-11, 7-34, 7-36  
 Flight plan  
   Active-----5-13  
   Closest point to reference-----5-146  
   Storing-----D-2  
 Flight timer-----1-39  
 FliteCharts-----8-1, 8-29, 8-43, B-2  
 FliteCharts database-----8-29, 8-45  
 FliteCharts functions-----8-29  
 FliteCharts softkeys-----8-29  
 Frequency  
   COM-----5-75  
   Nearest-----5-64  
   VOR-----5-52, 5-63  
 Frequency spacing-----4-13  
 Frequency transfer arrow-----4-7  
 Frequently asked questions-----D-1  
 Fuel  
   Calculations-----3-6–3-7, 3-12–3-13  
   Flow-----3-2, 3-4, 3-11, 3-12  
   Planning-----5-29  
   Pressure-----3-2, 3-4, 3-13  
   Quantity-----3-2, 3-4  
   Range ring-----5-12  
   Reserve-----3-7  
 Fuel Range Ring-----3-7

**G**

|                                 |                        |
|---------------------------------|------------------------|
| GDL 69/69A                      | 6-1                    |
| GFC 700 AFCS                    | 7-1–7-44               |
| Glidepath                       | 5-136                  |
| Glidepath Indicator             | 2-9                    |
| Glidepath Mode (GP)             | 7-17, 7-25, 7-39       |
| Glideslope                      | 5-136                  |
| Glideslope Indicator            | 2-9                    |
| Glideslope Mode (GS)            | 7-18, 7-38             |
| Global Positioning System (GPS) |                        |
| Navigation                      | 5-31–5-136, 5-39–5-144 |
| Go Around Mode (GA)             | 7-3, 7-19, 7-40–7-41   |
| GTX 33 Transponder              | 4-1, 4-28              |

**H**

|                                      |                |
|--------------------------------------|----------------|
| Heading                              | 2-2            |
| Heading Select Mode (HDG)            | 7-22, 7-30     |
| HI SENS                              | 4-23           |
| Horizontal Situation Indicator (HSI) | 2-2, 2-10–2-21 |
| HSI double green arrow               | 4-15           |
| HSI magenta arrow                    | 4-15           |
| HSI single green arrow               | 4-15           |

**I**

|                                |           |
|--------------------------------|-----------|
| IDENT function                 | 4-34      |
| ID indicator                   | 4-17      |
| ILS approach                   | 7-38      |
| Info Box                       | 8-34      |
| Inset Map                      | 5-28–5-29 |
| Inset Map, PFD                 | 2-3       |
| Integrated Avionics Unit (IAU) | 1-2       |
| Intercom system (ICS)          | 4-39      |
| Intersection                   |           |
| Information                    | 5-48–5-49 |
| Nearest                        | 5-60      |
| IOI                            | 6-41      |

**J**

|                            |            |
|----------------------------|------------|
| Jeppesen aviation database | B-1        |
| Joystick                   | 8-10, 8-32 |

**L**

|                              |               |
|------------------------------|---------------|
| Land map data                | 5-18          |
| LD APR softkey               | 5-158         |
| Lean Display                 | 3-10–3-12     |
| Line Replaceable Units (LRU) | 1-2–1-5, 1-11 |
| LNAV                         | 5-113         |
| Low Altitude Annunciation    | 2-28          |
| LO SENS                      | 4-23          |
| LPV                          | 5-113, 5-138  |
| LPV approach                 | 7-29          |

**M**

|   |            |
|---|------------|
| Manual Electric Trim (MET)  | 7-1, 7-27  |
| Map Pages (MAP)   | 1-30       |
| Map scale   | 5-20       |
| Map symbols   | G-1        |
| Marker beacon   | 4-23       |
| Marker Beacon Annunciations   | 2-26       |
| MASQ processing   | 4-1        |
| Measurement units, changing displayed                               | 1-35       |
| Menus   | 1-27       |
| Messages  |            |
| Reminder  | 1-40       |
| Message advisories A-3, A-7, A-8, A-9, A-12, A-13, A-14, A-15, A-16 |            |
| Minimum Descent Altitude (MDA)                                      | 2-3, 2-28  |
| Missed approach   | 7-40       |
| Mode S  | 4-28, 4-29 |
| Morse code identifier   | 4-17       |
| Multi Function Display (MFD)  | 1-2        |
| Controls  | 1-18–1-19  |
| Softkeys  | 1-25       |
| Music 1   | 4-39       |
| Music 2   | 4-39       |

**N**

|                                |                        |
|--------------------------------|------------------------|
| National Weather Service       | 6-23                   |
| Navigation (NAV) Frequency Box | 2-2                    |
| Navigation database            | 5-105, 5-106           |
| Navigation Data Bar            | 5-25                   |
| Navigation Map                 | 5-36                   |
| Setup                          | 5-3–5-17               |
| Navigation Mode, AFCS          | 7-23–7-24, 7-32–7-33   |
| Navigation mode selection      | 4-15                   |
| Navigation source              | 2-15–2-17              |
| Navigation Status Box          | 2-2                    |
| NAV frequency box              | 4-3                    |
| Nav radio selection            | 4-15                   |
| NAV tuning knob                | 4-17                   |
| NDB                            |                        |
| Nearest                        | 5-61                   |
| Nearest                        |                        |
| Airports                       | 5-57–5-60              |
| Intersection                   | 5-60                   |
| NDB                            | 5-61                   |
| VOR                            | 5-62–5-63              |
| Nearest Airports Page          | 5-53                   |
| Nearest Pages (NRST)           | 1-31                   |
| Night view                     | 8-23, 8-24, 8-41, 8-42 |
| Non-path descent               | 7-15, 7-36–7-37        |
| Normal display operation       | 1-9                    |
| NOTAMs                         | 8-16                   |
| NRST softkey                   | 5-75                   |

**O**

Obstacles-----A-8, A-11  
 Obstacle map data -----5-11  
 OBS Mode -----2-20–2-21  
 Oil  
   Pressure -----3-2, 3-4, 3-12  
   Temperature -----3-2, 3-4, 3-12  
 Omni Bearing Selector (OBS)-----D-2–D-3  
 Orientation, map-----5-4  
 Outside Air Temperature (OAT) -----2-2, 2-22  
 Overspeed protection, autopilot-----7-43

**P**

Page groups -----1-29–1-32  
 Page menus-----1-27  
 Pan map-----5-22, 5-29  
 Passenger address -----4-38  
 PA system -----4-38  
 Pilot profiles -----1-36–1-37  
 Pitch Hold Mode (PIT)-----7-7  
 Pitch indication-----2-6  
 Pitch modes, flight director-----7-6–7-12  
 Pitch Reference-----7-7  
 Power-up, system -----1-8  
 Power-up page -----8-26, 8-44  
 Primary Flight Display (PFD)-----1-2  
   Controls -----1-18–1-19  
   Softkeys-----1-20–1-22  
 Procedures --5-162–5-165, 5-163–5-166, 5-164–5-167  
 Procedure examples, AFCS -----7-29–7-41  
 Procedure Loading Pages (PROC)-----1-32

**Q**

Quick tuning 121.500 MHz -----4-8

**R**

RAIM-----1-16, D-1  
 Range-----5-9  
 Receiver Autonomous Integrity Monitoring (RAIM) -----1-16–1-17  
 Reminder messages -----1-40  
 Required Obstacle Clearance -----6-41  
 Required Vertical Speed-----5-129  
 Required Vertical Speed Indicator -----5-129  
 Reserve fuel-----3-7  
 Reversionary Mode -----1-9–1-10, 3-9–3-13  
 Roll Hold Mode (ROL)-----7-21  
 Roll modes, flight director -----7-20–7-23  
 Roll Reference-----7-21  
 Runway  
   Information -----5-58

RVSI-----5-129, 5-130  
 RX Indicator -----4-7

**S**

SafeTaxi-----8-1, 8-2, 8-4, 8-5, B-2  
 SafeTaxi database-----8-5, 8-6  
 SafeTaxi range-----8-3  
 Scheduler-----1-40–1-41  
 Secure Digital (SD) card-----1-7, 1-42, B-1  
 Selected Altitude --2-2, 2-7, 2-27, 7-8, 7-10, 7-12, 7-16, 7-30  
 Selected Altitude Bug -----2-2  
 Selected Altitude Capture Mode (ALTS) ---7-8, 7-9, 7-10, 7-12  
 Selected Course-----2-3, 2-11, 7-24, 7-26  
 Selected Heading -----2-3, 2-11, 7-22  
 Selecting a COM radio -----4-6  
 Selecting terminal procedures charts -----8-8, 8-30  
 Sequencing, automatic-----D-3  
 Sequencing waypoints, suspend-----2-21  
 Service Class-----8-48  
 Servos-----1-4, 7-27  
 Slip/Skid Indicator-----2-2, 2-6  
 Softkeys  
   EIS -----1-25, 3-4  
   EIS (Reversionary Mode) -----3-10  
   MFD -----1-25  
   PFD-----1-20–1-22, 2-2  
 Softkey annunciations-----2-25  
 Speaker-----4-35  
 Splash screen, power-up-----1-8  
 Standby frequency-----4-6, 4-9, 4-15  
   ADF-----4-24  
 Standby frequency field-----4-6  
 Stereo headsets -----4-35  
 Stuck microphone-----4-41  
 Symbols, map-----G-1  
 System annunciations -----1-10, A-1  
 System Display (EIS) -----3-12–3-13  
 System power-up -----1-8  
 System time-----2-2

**T**

Tachometer -----3-2, 3-4, 3-11, 3-12  
 TAS-----A-14  
 TAWS -----6-35, 6-36, 6-38, 6-39, A-18, A-19  
 Terrain -----A-8  
   Color indications -----G-3  
 Terrain Awareness and Warning System (TAWS)----2-27, A-18  
 Terrain map data-----5-10–5-11  
 Timer

- Departure----- 1-40
- Flight----- 1-39
- Timer, PFD generic----- 1-38
- Timer, total service----- 3-4, 3-13
- TOD----- 5-128, 5-129, 5-130, 5-134
- Topographic map data----- 5-9–5-10, 5-23
- Top of Descent----- 5-128, 5-129, 5-130
- Track----- 2-10
- Track vector----- 5-7
- Traffic advisory (TA)----- 2-26
- Traffic Advisory Systems----- 6-55
- Traffic Annunciation----- 2-3
- Traffic Information Service (TIS)----- F-1–F-2
  - Voice alerts----- 2-26
- Transponder----- 1-3
- Transponder code entry----- 4-31
- Transponder data box----- 4-1, 4-3
- Transponder ground mode----- 4-29
- Transponder mode field----- 4-29, 4-30
- Transponder softkeys----- 4-29
- Transponder standby mode----- 4-30
- Transponder Status Box----- 2-2
- Trend Vector
  - Turn Rate----- 2-13
- Trend Vector, Airspeed----- 2-4
- Trim, Manual Electric----- 7-1, 7-3, 7-27
- True airspeed----- 2-2, 2-4
- Tuning ADF frequencies----- 4-25
- Turn anticipation----- D-3
- Turn Rate Indicator----- 2-2, 2-13
- TX indicator----- 4-7

## U

- Unable to display chart----- 8-8, 8-30
- Updating Garmin databases----- 8-5
- Updating Jeppesen databases----- 8-27

## V

- VDI----- 5-129, 5-130
- Vector-To-Final----- 5-165, 5-166
- Vertical Descent Indicator----- 5-129
- Vertical deviation----- 2-8, 7-14
- Vertical deviation guidance----- 5-105, 5-106
- Vertical Deviation Indicator (VDI)----- 2-9
- Vertical navigation----- 5-105
- Vertical Navigation (VNV)
  - Flight control----- 7-12–7-16
- Vertical Path Tracking Mode (VPTH)----- 7-12–7-13, 7-35
- vertical speed guidance----- 5-105, 5-106
- Vertical Speed Indicator (VSI)----- 2-2, 2-8
- Vertical Speed Mode (VS)----- 7-10
- Vertical Speed Reference----- 7-10

- VFR code----- 4-32
- VNAV----- 5-32, 5-40, 5-105, 5-106
- VNV----- 5-128, A-16, C-6
- VNV indications, PFD----- 2-24
- VNV Target Altitude----- 2-9, 7-12–7-15
- VNV Target Altitude Capture Mode (ALTV)----- 7-16
- Voice alerts, TIS Traffic----- 2-26, 6-51
- Voice alerts, TIS traffic----- A-4
- Voltmeter----- 3-2, 3-4, 3-12
- Volume level
  - ADF----- 4-24, 4-26
- VOL annunciation----- 4-37
- VOR
  - Frequency----- 5-52, 5-63
  - Information----- 5-51–5-52
  - Nearest----- 5-62–5-63
- VOR selection----- 4-15
- VSI----- 5-130
- Vspeed references----- 2-3, 2-5

## W

- WAAS----- 5-113, 5-156, 7-29, A-11
- WAAS precision approach----- 7-39
- Warranty----- i
- Waypoint
  - Automatic sequencing----- D-2, D-3
  - Skipping----- D-3
- Waypoint, user
  - Comment----- 5-56
  - Information----- 5-31–5-36
- Waypoint Pages (WPT)----- 1-30
- Waypoint sequencing, suspend----- 2-21
- Wind data----- 2-3
- Wind vector----- 5-8

## X

- XM
  - radio----- 6-1, 8-47
  - Receiver troubleshooting----- 8-54, A-20
- XM channel list----- 8-49
- XM radio entertainment----- 4-39
- XM radio volume----- 8-52
- XM Satellite Radio----- 1-4, 8-47
- XM satellite radio----- 8-49, 8-50, 8-52

## Z

- Zoom
  - Auto----- 5-5
  - Range----- 5-29

**BLANK PAGE**