

US

QUICK LOCATOR GUIDE

Belts	891
Capacitors	883
Car Signal Components	880-886
Button Assemblies	880-881
Contact Blocks	881
Emergency Stop Switches	881
Gongs	883
Key Switches and Keys	884-885
Lantern and Hall Stations	882
Position Indicator Assemblies	883
Contact Kits	891
Fuses	886
Hatch Equipment	892-893
Door Keys	893
Gibs and Guide Shoe	893
Limit Switches	892
Magnetic Switches	892
Lamps	886
Printed Circuit Boards	887-888
Photo Cell Sensor, Amplifier and Receiver	887
Reverse Phase Amplifier	888
Relays	888-889
Resistors	890
Timers	887-888
Transformers	890
Seals, Packing	891
Selector Tape Guide	893
Starter, Reversing Contactor	888
Valve Kits	891
Wheels and Rollers	894
Roller Guide Assemblies	894

Car Signal Components

US



1
(1-3/8" Wide)

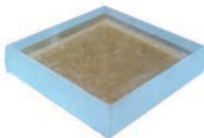
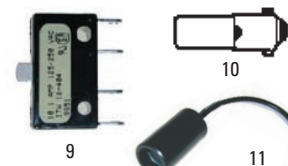

US-B19C



1
(1-3/4" Dia.)

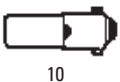
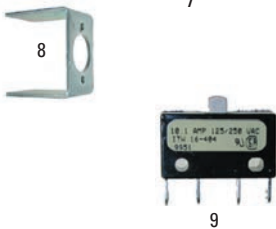

10



2



3



4



5



6

Square Pushbutton Assembly

Item	S.E.E.S. #	O.E.M. #	Description
1	US-B32A-	167-03017-100	Pushbutton assembly complete , square black housing, 167-03010-100 white button insert, specify marking: i.e. US-B32A-Door Open
2	US-B14	467-01006-007	Clear Cap , square plastic button cap
3	US-B23-	467-01012-007	Insert , square white button insert, specify marking i.e. US-B23-Door Open
4	US-B19	467-01005-007	Body , square white molded plastic button body
5	US-B25	920-36001-000	Spring , 1/2" x .088" O.D. x .010" (4 required/assy.)
6	US-B20	467-01001-007	Housing , square black molded plastic button housing
7	US-B22A	167-02014-700	Clamp , pushbutton "L" clamp
8	US-B22B		Clamp , pushbutton "U" clamp
9	US-B26	467-00026-007	Micro switch licon subminiature
10	ML-8	930-27004-000	Lamp , 60 MB, 60 V
11	US-B24	940-31001-000	Lamp socket mini bayonet .575" O.D.
	US-B19C	167-03014-002	Spacer , clear, for square button, to California code



3



4



5



6

Round Pushbutton Assembly

Item	S.E.E.S. #	O.E.M. #	Description
1	US-B40-	167-03011-100	Pushbutton Assembly complete , round black housing, white button insert, specify marking, i.e. US-B40-Alarm
	US-B40-SPECIAL		Pushbutton Assembly , special engraving
	US-B40- * -ADA		Pushbutton Assembly , round, ADA, California, specify marking, i.e. US-B40-1-ADA
	US-B40-SPECIAL-ADA		Pushbutton Assembly , round, ADA, California, special marking
2	US-B38	467-05006-007	Clear cap , round plastic button cap
3	US-B23A-	467-01012-007	Insert , round white button insert, specify marking i.e. US-B23A-Alarm
4	US-B39	467-05005-007	Body , round white molded plastic button body
	US-B39-SPECIAL		Body , Special Marking for US-B40 Assemblies
	US-B39C	167-03014-001	Spacer , for round button, California code
5	US-B25	920-36001-000	Spring , 1/2" x .088" O.D. x .010" (4 required / assy.)
	US-B25A		Spring , heavy-duty, 1/2" fire service switch, California code
6	US-B37	467-05001-007	Housing , round black molded plastic button housing
7	US-B22A	167-02014-700	Clamp , pushbutton "L" clamp
8	US-B22B		Clamp , pushbutton "U" clamp
9	US-B26	467-00026-007	Microswitch , licon subminiature
10	ML-8	930-27004-000	Lamp , 60 MB, 60V
11	US-B24	940-31001-000	Lamp socket , mini bayonet .575" O.D.

Stop Switches

S.E.E.S. #	O.E.M. #	Description
US-B15A	167-03012-100	Stop Switch Assembly , Square black molded plastic housing with red insert marked "PULL-EMERGENCY-STOP"
US-B15B	167-03013-100	Stop Switch Assembly , Round black molded plastic housing with red insert marked "PULL-EMERGENCY-STOP"
US-B15C	467-05010-007	Button , round, and actuator for stop switch assembly US-B15B
US-B15D	467-05008-007	Mount , for stop switch assembly US-B15B
US-B16	467-01003-007	Housing , Square, black stop switch housing for US-B15A
US-B17	167-02013-700	Arm Actuator Assembly , Includes: Body, Insert and Clear Cap
US-B18	467-00002-007	Toggle Switch , for US-B15A and US-B15B
US-B23-STOP	467-01012-007	Insert for Square Emergency Stop Switch, red insert marked "Pull Emergency Stop"
US-B23A-STOP	467-05012-007	Insert for Round Emergency Stop Switch, red insert marked "Pull Emergency Stop"

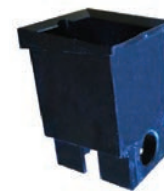

US-B16



US-B18

Contact Blocks

S.E.E.S. #	Description
US-B50C	Contact Block , 110V PB Red Illumination DMG
US-B50F	Contact Block , 24V PB Blue Illumination DMG
US-B50K	Contact Block , 6V PB Red Illumination DMG
US-B50M	Contact Block , 6-120Volt PB Red Illumination DMG



US-B50F



US-B15B



US-B15A

US-B23A-STOP

US-B23-STOP

"Soft Touch" Button

S.E.E.S. #	O.E.M. #	Description
US-B50-BLANK	166-01020-702, 166-10034-100	Button Assembly , Soft Touch Style, 24 VDC if used in series, 48 VDC if used alone, blank
US-PC14	146-05054-300	P.C. Board , for car, used on Soft Touch series
US-PC15	146-05055-300	P.C. Board , for hall, used on Soft Touch series
US-B50-CAR-HALL-RING		Soft Touch Car/Hall Ring , vandal proof, tough metal
US-B50-CAR		Pushbutton Assembly , complete for car
US-B50-CAR-ALARM		Pushbutton Assembly , "Alarm"
US-B50-HALL		Pushbutton Assembly , complete for hall
US-B50-ALARM		Pushbutton Assembly , marked "Alarm"
US-B50-OPEN-DOOR	9991098	US Button Assembly , "Open Door"
US-B50-CLOSE-DOOR	9991086	US Button Assembly , "Close Door"
US-B51	466-00166-001	Soft touch button bezel Rect.
US-B51A		Adapter Kit , for US-B51 key switch mount
US-B51B-SPECIAL		Soft Touch Bezel , Engraved Specify Markings
US-B53-CAR		US Bezel Insert , Car PH2 ON-OFF-FIRE
US-B53-HALL		US Bezel Insert , Hall PH1 BYPASS-OFF-ON-FIRE
US-B53-ALARM		US Bezel Insert , Alarm with bell
US-B53-SPECIAL		US Bezel Insert , Special Specify Marking and Color
US-B53-INDEP		US Bezel Insert , Independent OFF-ON
US-B53-CALL-CANCEL		US Bezel Insert , Call Cancel
US-B53-LIGHT-FAN		US Bezel Insert , LIGHT-FAN LOW-OFF-HIGH
US-B50-SPACER-KIT		Pushbutton Spacer , to adapt old pushbutton to US PC14
US-B53-BLANK-BL		US Bezel Insert , blank, black
MIS-BR1.25-		Braille Plate , #11, 1.25" square, stainless steel, charcoal on black, specify marking

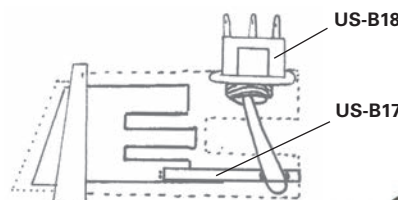

US-B18

US-B17



US-B50-CAR-HALL-RING



US-B51A

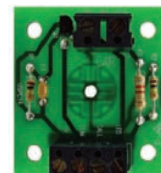

US-PC14

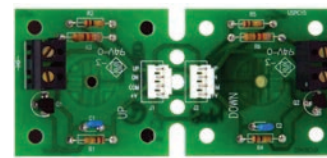

US-PC15



US-B50-BLANK

US-B50-HALL

US-B50-CAR

Car Signal Components



US-B4

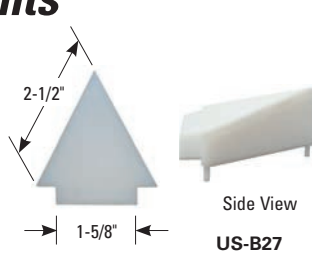

Side View

US-B27

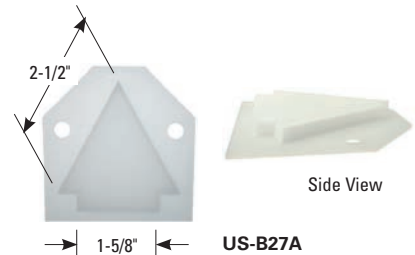

Side View

US-B27A

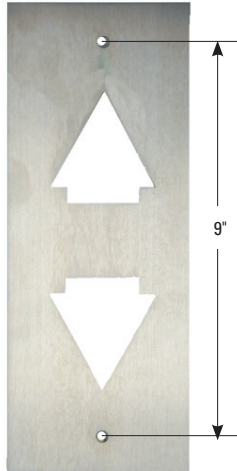

US-B4A

Lantern and Hall Station Plates – Arrows and Diffusers

S.E.E.S. #	O.E.M. #	Description
US-B3	167-30004-107	Lantern plate, Stainless Steel, 4-3/4" x 10-3/4", horizontal for single arrow, terminal floors
US-B3-COVER		Hall Plate Cover, No Arrow Holes, Horiz or Vertical
US-B3C-COVER		Hall Plate Cover, No Arrow Holes, 19.5 x 3.5
US-B4	167-30006-107	Lantern plate, Stainless Steel, 4-3/4" x 10-3/4", horizontal for double arrows, intermediate floors
US-B4A	167-30003-107	Lantern plate, Stainless Steel, 4-3/4" x 10-3/4", vertical for double arrows, intermediate floors
US-B5	167-30002-107	Lantern plate, Stainless Steel, 3-3/4" x 10-3/4", vertical for double arrows, intermediate floors
US-B27	467-00012-007	Arrow, extruded large plastic, 2-1/2" sides, 1-5/8" base, 3 mounting pins on back
US-B27A	467-00028-007	Lens, white flat lantern arrow on plastic mounting base
US-B28	167-03004-700	Diffuser, green, for lantern arrow for US-B27A
US-B29	167-03003-700	Diffuser, red, for lantern arrow for US-B27A

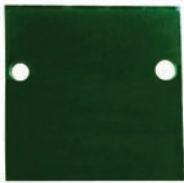

US-B28



US-B29



US-B9



US-B11



US-B12



US-B13

S.E.E.S. # Description

US-B9	Lantern plate, Stainless Steel, 4-3/4" x 10-3/4", Horizontal, Terminal Green
US-B9A	Lantern plate, Stainless Steel, 4-3/4" x 10-3/4", Horizontal, Terminal Red
US-B10	Lantern plate, Stainless Steel, 4-3/4" x 10-3/4", Vertical, Terminal Green
US-B11	Lantern plate, Stainless Steel, 4-3/4" x 10-3/4", Horizontal, Inter. Complete
US-B12	Lantern plate, Stainless Steel, 4-3/4" x 10-3/4", Vertical, Inter. Complete
US-B13	Lantern plate, Stainless Steel, 3-3/4" x 10-3/4", Vertical, Inter. Complete

■ All parts use US-B27.



US-B1A



US-B2



US-B2A

S.E.E.S. # O.E.M. # Description

US-B1	167-61001-107	Hall plate, Stainless Steel, 3" x 7", single square hole, for terminal floors
US-B1A	167-65001-107	Hall plate, Stainless Steel, 3" x 7", single round hole, for terminal floors
US-B2	167-61003-107	Hall plate, Stainless Steel, 3" x 7", double square holes, for intermediate floors
US-B2A	167-65003-107	Hall plate, Stainless Steel, 3" x 7", double round holes, for intermediate floors

Car Signal Components

Position Indicator Assembly

S.E.E.S. #	O.E.M. #	Description
US-B32A-PI*	167-03017-100	Square P.I. assembly, w/ black housing, specify marking
US-B24A	940-31002-000	Socket, .575" O.D. with clip
US-B40-PI*	167-03011-100	Round P.I. Assembly, black housing, specify marking

* Micro switch not used on these assemblies

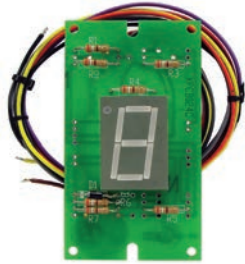

US-PC13G

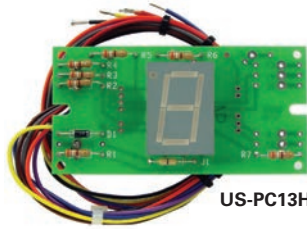

US-PC13H

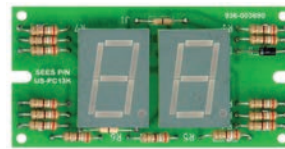

US-PC13K

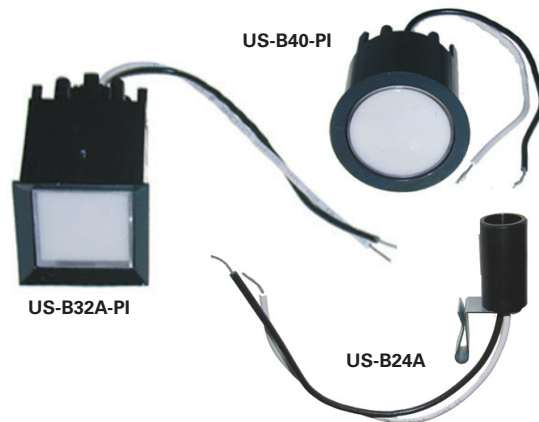

US-B32A-PI

US-B40-PI

US-B24A



US-B30

Digital Position Indicator Components

S.E.E.S. #	O.E.M. #	Description
US-PC13G	154-05006-301	P.C. board for vertical Digital P.I., single character
US-PC13H	145-05097-301	P.C. board for horizontal Digital P.I., single character
US-PC13J	145-05098-302	P.C. board for vertical Digital P.I., double character
US-PC13K	145-05097-302	P.C. board for horizontal Digital P.I., double character
US-B30	467-00022-007	Black Bezel retainer for Digital Position Indicator
US-B31	467-00020-007	Black Bezel for Digital Position Indicator
US-B31A	467-00021-007	Clear Bezel for Digital Position Indicator
US-B32	167-03005-700	Red Lens for Digital Position Indicator



US-B31



US-B32



US-B8B

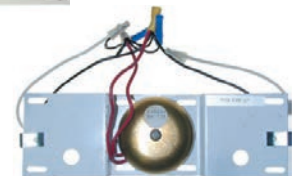

US-B8D



US-B8F

Gongs

S.E.E.S. #	O.E.M. #	Description
US-B8A	167-31002-001	Gong assembly, Horizontal, Single lamp, Relay Controller
US-B8B	167-31003-001	Gong assembly, Horizontal, Double lamp, Relay Controller
US-B8C	167-31002-002	Gong assembly, Horizontal, Single lamp, Microprocessor
US-B8D	167-31003-002	Gong assembly, Horizontal, Double lamp, Microprocessor
US-B8E	167-31000-001	Gong assembly, Vertical, Single lamp, Relay Controller
US-B8G	167-31000-002	Gong assembly, Vertical, Single lamp, Microprocessor
US-B8F	167-31001-001	Gong assembly, Vertical, Double lamp, Relay Controller
US-B8H	167-31001-002	Gong assembly, Vertical, Double lamp, Microprocessor
US-B24A	940-31002-000	Lamp Socket, .5" O.D. with clips, for gongs

Capacitors

S.E.E.S. #	O.E.M. #	Description
US-CAP1	936-50004-000	Capacitor 0.25Mfd, 600V
US-CAP2	936-10032-000	Capacitor 300Mfd, 150V
US-CAP3	936-60022-000	Capacitor 108-130Mfd, 330 VAC
US-CAP3A	936-60022-001	Capacitor 215-260Mfd, 330 VAC
US-CAP4	936-40003-000	Capacitor 320Mfd, 450 VDC
US-CAP5	936-10027-000	Capacitor 150Mfd, 150 VDC
US-CAP6	936-60042-000	Capacitor 5300Mfd, 100 VDC



US-CAP1



US-CAP2



US-CAP3, 3A



US-CAP4, 5, 6

Car Signal Components



US-KS1-HALL



US-KS1-CAR



US-KS1-OFF-ON



US-KS1-OFF-ON-PW



US-KS1-CAR-PW



US-KS1-HALL-PW



US-KS2-HALL



US-KS2-CAR



US-KS2-CAR-PW



US-KS2-2



US-KS2-2PW



US-KS2-3

Key Switches

S.E.E.S. #	O.E.M. #	Description
US-KS1-HALL		Fire Service Phase I , round key switch, BYPASS/OFF/ON, 3 Pos, remove 2, for hall use, BYPASS at 10, OFF at 12, ON at 2, Uses #1 key
US-KS1-CAR		Fire service Phase II , round key switch, OFF/HOLD/ON, 3 Pos, remove 2, for car use, OFF at 10, HOLD at 12, On at 2, Uses #1 key
US-KS1-OFF-ON		Key Switch , round, red, fire service, removable 2 position "OFF-ON", Uses #1 key
US-KS1-OFF-ON-PW		Fire Service Key Switch , Round, Red Key switch OFF, ON, Prewired
US-KS1-CAR-PW		Fire Service , PH1 Rnd Key switch HOLD, OFF, ON, Prewired
US-KS1-HALL-PW		Fire Service , PH1 Rnd Key switch BYPASS, OFF, ON, Prewired
US-KS1-SPECIAL		Fire Service Key Switch , Special #1 Key, Special Engraving
US-KS2-ACCESS		Key Switch , "Access" Off-On 2 Pos Rmv 2, Uses #2 Key
US-KS2-HALL		Fire service Phase I , square key switch, BYPASS at 10, OFF at 12, ON at 2, #1 Key
US-KS2-OFF-ON		Key Switch , Fire Service Red Square 2PR2, Off-On, #1 Key Pre Wired
US-KS2-HALL-PW		Key Switch , Fire Service PH1 Hall Pre Wired
US-KS2-CAR		Fire service Phase II , square key switch, OFF at 10, HOLD at 12, ON at 2, Uses #1 key
US-KS2-CAR-PW		Fire Service Key Switch , PH2 Sq Off - Hold-On, Uses #1 Key, Prewired
US-KS2-2	3199-153	Key Switch , 3 Position Spring Return to center, UP-OFF-DOWN, Uses #2 key
US-KS2-2PW		Key Switch , 3 Position Spring Return to center, Uses #2 key, Prewired
US-KS2-3	D3159-050	Key Switch , 2 Position Spring Return to off, Uses #2 key
US-KS2-3-PW		Key Switch , 2 Position Spring Return to Off, Uses #2 Key, Prewired
US-KS2-5		Key Switch , 3 Position Spring Return To CTR, UP-OFF-DN, Uses #5 Key
US-KS2A		Key , Uses #1 for Fire Service Phase 1 & 2
US-KS2B-ACCESS-PW		Key Switch , "Access" Up/Off/Down 3 Position Spring Return, Uses #2 Key, Wired
US-KS2B		Key , Uses #2 for Hall and Car Access and Inspection
US-KS2C		Key Switch , 3PR3 45° Index, Uses #2 Key
US-KS2B-1	D3158-053L	Key Switch , key switch 2 position, 2 Remove, ON-OFF DPDT, Uses #2 key
US-KS3	167-03046-001	Key Switch , Run/Stop, Black, 2 position round switch to replace stop switch, Uses #3 key



US-KS2-5



US-KS2A



US-KS2C



US-KS3

Key Switches

S.E.E.S. #	O.E.M. #	Description
US-KS3-ACCESS		Key Switch , round, black, Off-On Access 2Pos #3 Key, Pre-Wired
US-KS3-3	3199-153W/US	Key Switch , UP-OFF-DOWN, spring return center Uses # 3 key
US-KS3B		Direction Run Switch , 3 Position UP-OFF-DOWN. Spring return to center (OFF) position. Keyed to Use #3 key
US-KS3B-PW		Key Switch , 3 Position Up-Off-Down Spring Rtn to center, #3 Key, Prewired
US-KS3-R		Key Switch , Run/Stop, Red, 2 position round switch to replace stop switch
US-KS3A		Key , Uses #3 for Light, 1 & 2 Speed Fan, Fan and Light, Door Hold, Run Stop, Hall Park
US-KS3A-INDEP		Key Switch , "Indep Serv" Off-On 2 Pos SEES #3 Key, Square, Black, Pre-Wired
US-KS3-INDEP		Key Switch , "Indep Serv" Off-On 2 Pos #3 Key, Round, Black, Pre-Wired
US-KS3-LIGHT-FAN		Key Switch , "Light-Fan" Off-On 2 Pos #3 Key, Round, Black, Pre-Wired
US-KS3-STOP		Key Switch , "Off-On-Stop" 2 Pos #3 Key, Round, Black, Pre-Wired
US-KS4		Key Switch , Run/Stop, Black, DPDT, removeable both square switch to replace stop switch, Uses #4 key
US-KS-53A		Key Switch Assembly , Run-Stop 2 Pos, Rmv 2, Soft Touch Style
US-KS-53A-2011		Key Switch Assembly , Run-Stop 2 Pos, Rmv 2, H2011 Key
US-KS4-1	D3158-053S	Key Switch , 2 position key switch OFF-ON, Uses # 4 key
US-KS4A		Key , Uses #4 for Ind. Svc., Hospital Emergency, Lockout, Car Park
US-KS4-R		Key Switch , Run/Stop, Red, 2 position square switch to replace stop switch, Uses #3 key
US-KS5A		Key , Uses #5 for Car and Hall Floor Lockout
US-KS5A-LOCKOUT		Lockout Key Switch , Black, Sq Off-On, 2 Pos Remove both #5key
US-KS5-CALL		Call Key Switch , Black, Round OFF-ON, 2 Position spring return, Uses #5 key
US-KS5-LOCKOUT		Lockout Key Switch , Black, Round OFF-ON, 2 Position, Remove 2, Uses #5 key
US-KS6-1		Key Switch , 3 Position, Remove 3, Uses #3 Key, Prewired



US-KS3-3



US-KS3-ACCESS



US-KS3-R



US-KS3-INDEP



US-KS4



US-KS4-1



US-KS4-R



US-KS5-LOCKOUT

Car Signal Components



US-KS1-A



US-KS1-A-ACCESS



US-KS1-A-STOP-RUN



US-KS1-B-OFF-ON



US-KS1-B-CAR



US-KS1-B-HALL

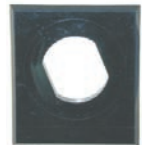

US-KS1-C

Bezels



US-KS1-D-HALL



US-KS1-E



US-KS1-F

S.E.E.S. #	O.E.M. #	Description
US-KS1-A	467-01014-001	Bezel, round black blank, 1-3/4" O.D., raised inner ring 1-9/16" O.D., 3/4" I.D., 2 straight sides
US-KS1-A-ACCESS		Bezel, round, black, Marked Off-On-Access
US-KS1-A-STOP-RUN		Bezel, round black as above, marked "RUN/STOP"
US-KS1-A-OFF-ON		Bezel, round, black, OFF @ 12:00 & ON @ 3:00
US-KS1-B-OFF-ON	M/F US-KS1-B	Bezel, round, red, OFF @ 12:00 & ON @ 3:00
US-KS1-B	467-01014-102	Bezel, round, red blank, 1-3/4" O.D., raised inner ring 1-9/16" O.D., 3/4" I.D., 2 straight sides
US-KS1-B-CAR		Bezel, round red, marked "OFF/HOLD/ON"
US-KS1-B-HALL		Bezel, round red, marked "BYPASS/OFF/ON"
US-KS1-C	467-01015-001	Bezel, square black, blank, 1-5/8" H x 1-7/16" W, raised inner ring 10/16" O.D. with 3/4" I.D. with 2 straight slanted inner sides
US-KS1-D	467-01015-102	Bezel, square red, blank, 1-5/8" H x 1-7/16" W, raised inner ring 10/16" O.D. with 3/4" I.D. with 2 straight inner sides
US-KS1-D-CAR		Bezel, square red marked "OFF/HOLD/ON"
US-KS1-D-HALL		Bezel, square red marked "BYPASS/OFF/ON"
US-KS1-E	467-05022-001	Backing plate, round black 2" O.D. 3/4" I.D., 2 flat outer sides (1-3/4" O.D.)
US-KS1-F		Bezel, square, black, 1-5/8" H x 1-7/16" W, raised inner ring 10/16" O.D. with 3/4" I.D. with 2 straight slanted inner sides marked "RUN/STOP"



F-5SB thru F-32SB



F-17A thru F-26



F-30 thru F-41

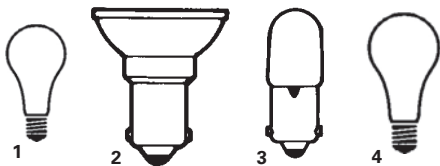

1

2

3

4

Fuses

S.E.E.S. #	O.E.M. #	Description
F-5SB	930-15016-000	Fuse, 0.1 amp, 250V, Slo-Blo
F-12SB	930-15001-000	Fuse, 0.30 amp, 250V, Slo-Blo
F-11SB	930-15020-000	Fuse, 1.25 amp, 250V, Slo-Blo
F-32SB	940-18009-000	Fuse, 5 amp, 125V, Slo-Blo
F-17A	930-15004-000	Fuse, 0.75 amp, 250V
F-19	930-15006-000	Fuse, 2 amp, 250V
F-20	930-15007-000	Fuse, 3 amp, 250V
F-23	930-15009-000	Fuse, 6 amp, 250V
F-26	930-15010-000	Fuse, 10 amp, 250V
F-30	940-18001-000	Fuse, 1 amp, 250V, one-time
F-33	940-18002-000	Fuse, 3 amp, 250V, one-time
F-36	940-18003-000	Fuse, 6 amp, 250V, one-time
F-38	940-18004-000	Fuse, 10 amp, 250V, one-time
F-40	940-18005-500	Fuse, 15 amp, 250V, one-time
F-41	940-18006-000	Fuse, 20 amp, 250V, one-time

Lamps

Fig.	S.E.E.S. #	O.E.M. #	Description
1	ML-8	930-27004-000	Lamp, 60MB, 60V
2	ML-27	930-27007-000	Lamp, 60RB, 60V
3	ML-68	940-24001-000	Lamp, 313, 28V
4	ML-141	940-24004-000	Lamp, 100 A/CL, utility lamp 100W, 230-250V
	US-B24	940-31001-000	Lamp, socket for buttons
	US-B24A	940-31002-000	Lamp, socket for gongs



Printed Circuit Boards and Timers



US-PC4

S.E.E.S. #	O.E.M. #	Description
US-PC4	144-00020-001	Amplifier, Photo Cell Sensor
US-PC5	144-00019-001	Receiver, Photo cell sensor
US-PC5A	144-00018-001	Lamp holder assembly, photo eye, for 60 RB Lamp.
US-PC6	144-00016-001	Hydro Control Board #1
US-PC7	144-00017-001	Hydro Control Board #2



US-PC5



US-PC5A

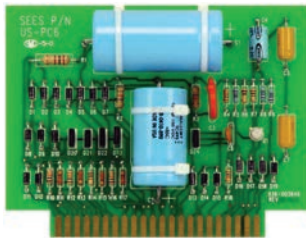

US-PC6

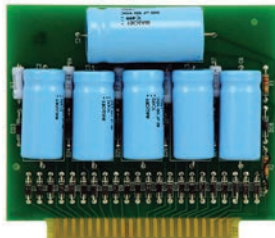

US-PC7

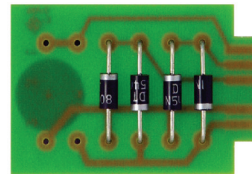

US-PC8

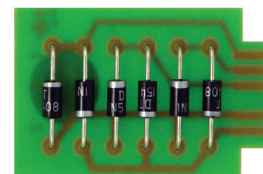

US-PC9

S.E.E.S. #	O.E.M. #	Description
US-PC8	144-00065-001	Rectifier Board
US-PC9	144-00066-001	Rectifier Board
US-PC9B	930-11059-000	Base, for US-PC9 rectifier
US-PC10	144-00035-001	Timer, External Relay .5-5 Sec.
US-PC11	144-00039-001	Timer, External Relay .5-60 Sec.
US-PC12	144-00041-001	Timer, Internal Relay N/O .5-60 Sec
US-PC13	144-00067-001	Timer, Internal Relay N/C .5-60 Sec
US-PC13G	154-05006-301	Position Indicator, PC Board Vertical, Single
US-PC13H	154-05005-301	Position Indicator, PC Board Horizontal, Single



US-PC9B



US-PC10

■ Octal base plug-in timer



US-PC12



US-PC13

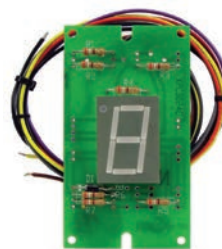

US-PC13G

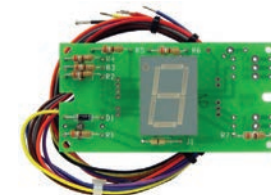

US-PC13H

Printed Circuit Boards and Timers



US-PC10A



US-PC13A



US-PC13B

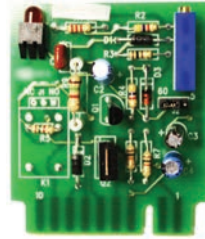

US-PC13F

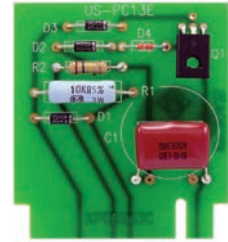

US-PC13E



US-PC13C



US-PC13D

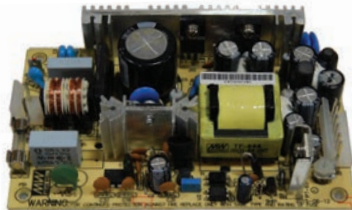

US-PC16



US-PC17



US-PC18

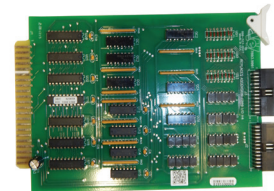

US-PC19



PR-20



AMT-1



AMT-2



AMT-3



AMT-4

Amtech

S.E.E.S. #	Description
AMT-1	Omega 1000 Peripheral
AMT-2	Stepper PC Solid State
AMT-3	Level Sensor Decoder
AMT-4	Door Operator Control Board

Relays



PR-38



US-R14



US-R18

S.E.E.S. #	O.E.M. #	Description
PR-20	930-35029-000	Starter, reversing contactor 3 PDT, 48 VDC
US-R12	930-35030-000	Relay, Type KUP, DPDT, 48 VDC
PR-38	930-35031-000, 930-35032-000	Relay, Flange mount, 3 PDT Type KUP 48 VDC
US-R14	930-35033-000, 930-35033-000	Relay, Flange mount Type KUP 3 PDT 240 VAC
US-R18	930-35053-000	Relay, Plug in Type K10-2P, 48 VDC

Relays

S.E.E.S. #	O.E.M. #	Description
US-R42	930-35051-000, 930-35037-000	Relay, Type R10-4 PDT, 48 VDC
US-R42A	930-37014-000	Base, Socket for 4 PDT, R10-relay
US-R43	930-35052-000	Relay, R10-6 PDT, 48 VDC
US-R43A	930-37015-000	Base, Socket for R10-6 PDT relay
US-R44A	930-02001-000	Base, Socket for R10-4P Latch
US-R44-S		Latching Relay, Solid State 4P 48 VDC
ORP-45	930-35056-000	Relay, VC152A2B-120 VAC
ORP-45A	930-35056-001	Relay, VC153A1B-120 VAC
ORP-45B	930-35056-002	Relay, VC154A-120 VAC

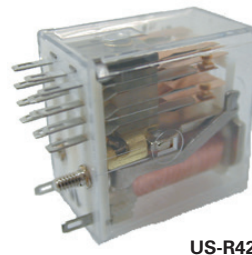

US-R42



US-R43

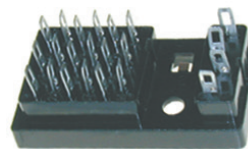

US-R43A



ORP-45

IBM Relays

S.E.E.S. #	O.E.M. #	Description
PR-28-BC	9710322	Clip, bottom hold down clip for relay
PR-28-TC	9710310	Clip, top hold down clip for relay
PR-30	930-35019-000, 769489	Relay, IBM 4 PDT, 48 VDC
PR-30S	769489	Relay, 48 VDC, 4 PDT with LED solid state, alternate to PR-30
PR-33	930-35017-000, 186685	Latching Relay, IBM 4 PDT, 45 VDC
PR-33S		Solid State Replacement for PR-33
PR-35	930-02000-000	Base, for 4 PDT IBM relays
PR-31S	769019	Solid State Replacement for PR-31
PR-35C	930-35018-000	Base, for IBM 6 PDT relay
PR-35E	136267	Arc Suppressor Assy, Diode 3A, 50V for PR-35
PR-34S	769488	Solid State Replacement for PR-34
PR-35D	930-02002-000, 159943	Base, for IBM 12 PDT relay
PR-35A	930-35004-000	Wire Contacts for all IBM Wire Relays
PR-35B		Taper pins for base wiring
PR-35T		Tool, IBM contact removal and insertion tool
PR-35-KIT	9730114	Relay, IBM 4 Pole Base and Top Clip



PR-28-TC



PR-28-BC

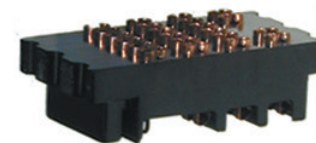

PR-35
IBM Relay Base

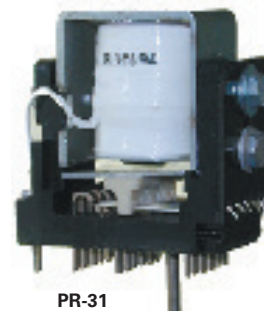

PR-31



No. of Contacts	A	B
4 PDT	2"	5/8"
6 PDT	2"	15/16"
12 PDT	2"	1-7/8"

Relay Dimensions listed for identification assistance.



PR-35T

See page 286 for more IBM sockets and relays.

Tube Base Relays

S.E.E.S. #	O.E.M. #	Description
US-R2	930-35009-000, 930-35012-000	Delay Relay, Amperite, 50V, N.O., 30 sec
US-R3	930-35010-000	Delay Relay, Amperite, 50V, N.O., 5 sec
US-R5	930-35013-000	Delay Relay, Amperite, 50V, N.O., 180 sec
US-R6	930-35015-000	Delay Relay, Amperite, 50V, N.O., 10 sec
US-R7	930-35026-000	Delay Relay, Amperite, 50V, N.O., 8 sec



US-R2



US-R3

Resistors



RES-53 thru RES-61



RES-71

Adjustable Resistor 10-1/2"

S.E.E.S. #	O.E.M. #	Description		
RES-53	934-10055-000	Resistor	10 Ohms	200 Watt
RES-54	934-10054-000	Resistor	25 Ohms	200 Watt
RES-55	934-10063-000	Resistor	50 Ohms	200 Watt
RES-56	934-10057-000	Resistor	100 Ohms	200 Watt
RES-58	934-20206-000	Resistor	200 Ohms	200 Watt
RES-59	934-10056-000	Resistor	250 Ohms	200 Watt
RES-60	934-10062-000	Resistor	500 Ohms	200 Watt
RES-61	934-10060-000	Resistor	1K Ohms	200 Watt

S.E.E.S. #	O.E.M. #	Description		
RES-71	934-10061-000	Resistor	500 Ohms	20W, fixed

Transformers

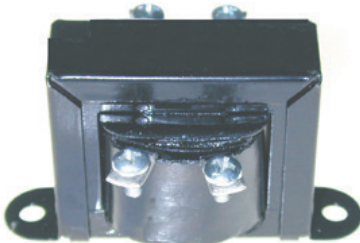

US-TR1

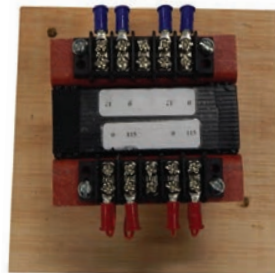

US-TR3



US-TR4



US-TR5



US-TR6

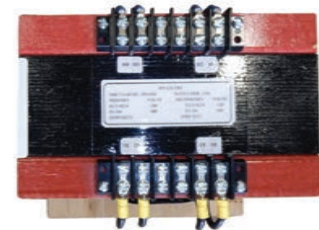

US-TR9

S.E.E.S. #	O.E.M. #	Description	Primary Voltage	Secondary Voltage
US-TR1	940-38001-000	Transformer, 5 VA, for Alarm Bell	120	10
US-TR2	940-38011-000	Transformer, 1.2A	115	6.3
US-TR3	930-45012-000	Transformer, 2-4A	115/230	12/24
US-TR4	940-38012-000	Transformer, 0.25 KVA	200/220/240	55
US-TR5	940-38008-000	Transformer, 0.25 KVA	240/480	120/240
US-TR6	940-38009-000	Transformer, 0.5 KVA	240/480	120/240
US-TR7	940-38010-000	Transformer, 1 KVA	110/120/130	55
US-TR8	940-38007-000	Transformer, 1 KVA	240/480	120/240
US-TR9	940-38004-000	Transformer, 3 KVA	240/480	120/240
US-TR10	448-05001-850	Transformer, 5 A for MDU	200/240	45
US-TR11	448-05004-850	Transformer, 4 A for MDU	220/260	100/100

Seals

Hydraulic Split Seal Stack Packing

S.E.E.S. #	O.E.M. #	Description
USPAC-26	437-00010-000	Packing Set , 4-1/2" x 5 1/2"
USPAC-27	437-00011-000	Packing Set , 5" x 6" x 1-1/2", Split
USPAC-27A	437-00023-000	Packing Set , 5-1/2" x 6-1/2", Split Autopak
USPAC-28	437-00012-000	Packing Set , 6" x 7" x 1/2", Soft Split Autopak
USPAC-29	437-00025-000	Packing Set , 7" x 8" x 1-1/2"
USPAC-30		Seal , worm shaft for #63 Machine



USPAC-26



USPAC-27

Valve Kits

S.E.E.S. #	O.E.M. #	Description
MIS-208G	995-00044-001	Repair Kit for UC-1, UC-2, UC-2A
MIS-208G1	995-00044-002	Repair Kit for UC-3A, UC-4



MIS-208G

Pump Belts

S.E.E.S. #	O.E.M. #	Description
MIS-BLT8	990-10105-000	V-Belt 3V375/3VX375
MIS-BLT14	990-10103-000	V-Belt 3V530/3VX530
MIS-BLT15	990-10102-000	V-Belt 3V560/3VX560
MIS-BLT16	990-10101-000	V-Belt 3V600/3VX600
MIS-BLT17	990-10000-000	V-Belt 3V630/3VX630
MIS-BLT17A		V-Belt 3V630
MIS-BLT18	990-10106-000	V-Belt 3V670/3VX670
MIS-BLT19	990-10107-000	V-Belt 3V710/3VX710



MIS-BLT8

Contact Kits

S.E.E.S. #	Description
CKGE-5	Size 1 , Contact Kit, 546-A301G-053, 546-A301G-002
CKGE-7	Size 2 , Contact Kit, 546-A780G-002, 546-A780G-051
CKGE-9	Size 3 , Contact Kit, 55-153677-G001, 55-153677-G002

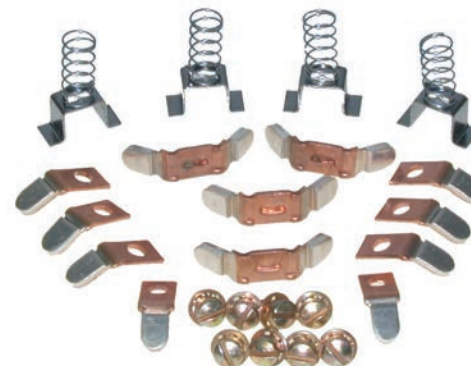

CKGE-5

Hatch Equipment



MIS-181B



MIS-181B-D



MIS-181H



MIS-181J



US-46



US-46A



US-46B



US-46C

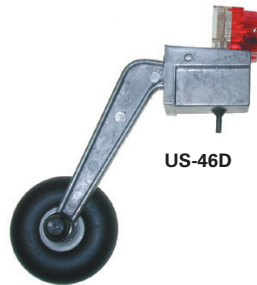

US-46D



US-46F

S.E.E.S. #	O.E.M. #	Description
MIS-181B	930-41014-000	Limit Switch, with roller, 1 N.O., 1 N.C.
MIS-181B-D	LS-1BD	Limit Switch, with Roller, 2 N.O., 2 N.C.
MIS-181H	GLDB03C	Limit Switch, DPDT, Roller Plunger, 10A, 600 VAC, 250 VDC
MIS-181J	534-351	Limit Switch, 534-351 600V 10A NEMA 4/12
MIS-181K	534-351	Limit Switch, Water Tight
MIS-181L		Limit Switch, N.C. Contact
MIS-184A	940-35011-000	Magnetic Switch, 1 N.O., 1 N.C.

Limit Switch

S.E.E.S. #	O.E.M. #	Description
US-46	150-00116-001	Limit Switch assembly, N.C.
US-46A	940-00012-000, 150-00280-001, 150-00142-007	Roller with clip, for Limit Switch US-46
US-46B	940-02004-000	Contact Block assembly, N.C., for limit switch
US-46F	940-02004-001	Contact Block assembly, N.O., for limit switch
US-46C	990-11405-000	Retaining Ring for roller 3/16" shaft
US-46D	150-00643-001	Limit Switch, N.C., new style, with air tire
US-46E	960-00062-000	Roller for limit switch US-46D
US-46T		Tire replacement for US-46A

Guide Assemblies

S.E.E.S. #	O.E.M. #	Description
MIS-119	990-00021-000	Door Key , with collar
MIS-119-P		Door Key , Flapper with Plastic Handle and flexible safety shaft
US-47		Guide Shoe Insert , 5-3/4" long, rounded back, for 8 & 16 lb. rails for assembly #960-00034-000
US-47A		Guide Shoe Insert , 5-3/4" long, slot .64" W x 1" deep, for Model 8ST for assy. #960-00036-000
US-47B		Clip , Replacement Shoe Retainer with Hardware Used on MIS-233
MIS-233		Guide Shoe Assembly , Esco fixed, 5/8" rail with insert
MIS-233B	815DS	Slide Guide Assembly , Double Swivle Self Aligning, 10,000 Lbs Cap, Base 9" x 4 3/4"
MIS-233C	816DS	Slide Guide Assembly , Double Swivle Self Aligning, 10,000 Lbs Cap, Base 5" x 6"
MIS-233F		Guide Shoe Insert , 5-7/8" x 1-11/64 x 63/64, M10 x 1.5
MIS-233H	18FR	Freight Duty Fixed Guide Assembly , For 3/4" Rail
MIS-233J		Guide Shoe Insert , 1-3/8" x 1-3/8" x 9" L for 5/8" Rail
MIS-233K	30SS	Guide Shoe , Freight Duty 1.25" Rail
MIS-233L	16SS	Guide , Slide 20K/Car SS 3x5.5 Mount
US-47C	960-0036-000	Gib Retaining Clips & Hardware , for US-47, 2 required per gib
USDS-001		Door Gib , 7/8" Offset Bracket with 15/32" Gib
USS-001	999-0733	Tape Guide , ASC 2000 Selector



MIS-119



MIS-119-P



US-47



US-47A



MIS-233

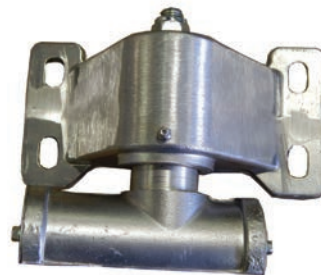

MIS-233B



MIS-233C



US-47B



US-47C



USDS-001



USS-001

Wheels



USW-1

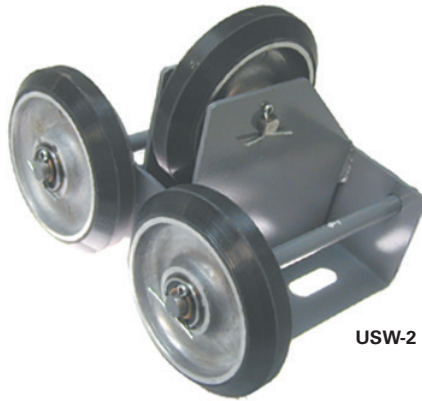

USW-2

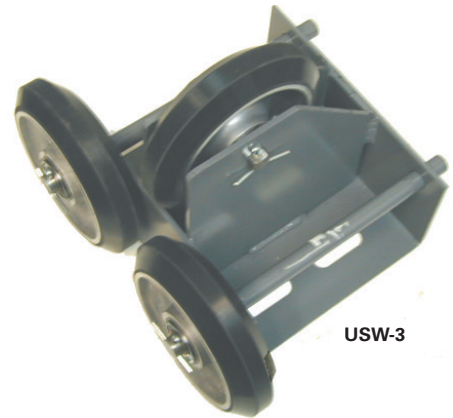

USW-3



USW-4



USW-7

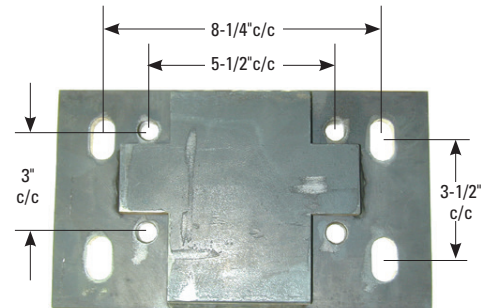

USW-36A

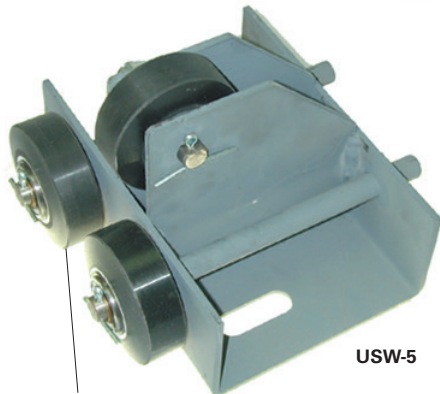

USW-5

USW-4

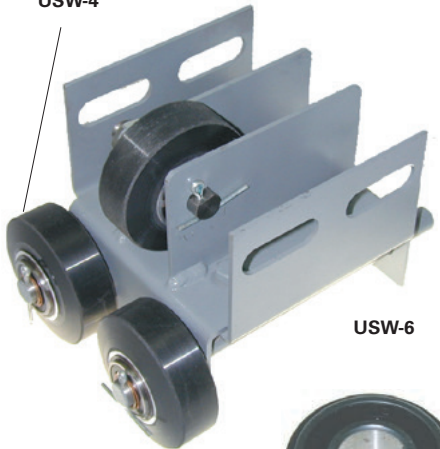

USW-6



USW-8

S.E.E.S. #	O.E.M. #	Description
USW-1	100-00080-001	Roller guide wheel, 6" diameter, polyurethane tire, (5-3/4")
USW-2	100-00054-001	Roller guide assembly for Car, with 6" diameter wheels USW-1. Mounting holes 5-1/2" c/c
USW-3	100-00075-001	Roller guide assembly, 6" dia. Original mounting holes 8-1/4" c/c. Replacement kit consists of USW-2 roller guide assembly and USW-36A adapter
USW-7	100-00100-001, 100-00100-002	Bolt and Bushing Kit for 3" and 6" roller replacement
USW-36A	100-00004-001	Adapter plate for USW-2 when used to replace old style 6" diameter roller guide assembly. Bolt mounting pattern (shown above)
USW-4	114-00009-007	Roller guide wheel, 3-1/4" .625" I.D., tire face 15/16" W, double bearing
USW-5	100-00057-001	Roller guide assembly for Hydro, with 3-1/4" diameter wheels (USW-4)
USW-6	114-00054-001	Roller guide assembly for counterweight, with 3-1/4" diameter wheels (USW-4)
USW-8	960-00011-000	Bearing for governor and roller guide wheels



SEES Universal Roller Guides page 494.