

Including



ADVANCED PRODUCT GROUP



Where **high performance** is the **standard**®



Integrated Manufacturing Solutions



Product Catalog 2016

www.maford.com



Where **high performance** is the **standard**®



For more than 95 years, M.A. FORD® has been at the cutting edge of tooling design and manufacturing and has developed an enviable global reputation for performance and precision in advanced solid carbide tooling, serving over 60 countries worldwide.

Our innovative cutting geometries, materials and coating technologies are providing effective manufacturing solutions to an expanding and increasingly diverse range of industries from agriculture and construction to aerospace, power generation and automotive, to name but a few.

M.A. FORD® – Where *high performance* is the *standard*.®



Series Number by Page

























Series No.	Page No.
60	409
61	409
61B	410
61T	411
64 Sets	412
67	413
71 Sets	452
78	413
79	414
79B	415
79T	416
79 Sets	417
80	424
83	421
84	421
86	422
87	422
92	418
92 Sets	418
111	253
112	248
113	249
114	259
116	268
116C	271
117	260
121	276
122	266
123	286
132	267
134	222
134N	223
134S	222
135	212
135B	218
135BN	219

























Series No.	Page No.
135N	214
136	220
138 / 138R	224
138B	237
138BN	238
138CE	235
138N / 138NR	231
140	287
145	291
150	292
156	239
157	244
158	243
163	262
164	282
165	289
166	295
169	272
169C	275
177 / 177W	199
177L	204
177S	205
178 / 178W	206
178N	209
179	210
179L	211
180	194
180CB	198
180N	197
192	247
200	88
200 Sets	95
200S	68, 132
204	96
205	98
206	105

Series No.	Page No.
207	107
207CE	75
209	111
210	114
224	115
226	117
229	77
230	463
230CE	460
231	463
231B	463
231BCE	460
231CE	460
231D	463
231DCE	460
231F	463
239	457
270	376
270L	376
270P	378
272	379
277 / 277W	174
277N	178
277 Sets	180
278 / 278W	181
278N	191
279	193
2MDCL	74
2XDCE	67
2XDCL	64
2XDCCR	59
2XDCCS	55
2XDSCR	50
2XDSS	45
300	119
302	123













Series No.	Page No.
305	81
306	128
402	131
403	69, 133
404	69, 133
405	134
850	423
851	423
880 / 882 / 883	419
890 / 892 / 893	420
CDACR	41
CXDCL	37
CXDCCR	32
CXDCCS	28
CXDSCR	24
CXDSS	19
HPDCR	70
HPDSR	70
SA	429
SB	431
SC	433
SD	435
SE	437
SF	439
SG	441
SH	443
SJ	445
SK	446
SL	447
SM	449
SN	451

Table of Contents

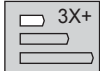



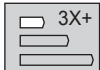







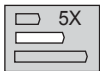





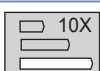

Cyclone HP Drills Page 16-43							
Series	Tool Illustration	Coolant	Length	Drill Point Angle	Helix Angle	Material Group	Page
CXDSS				140° - 142°	30°		19-23
CXDSR				140° - 142°	30°		24-27
CXDCCS				140° - 142°	30°		28-31
CXDCCR				140° - 142°	30°		32-36
CXDCL				140° - 142°	30°		37-40
CDACR				140° - 142°	30°		41-43
Technical Information							135

Twister XD® Page 44-67							
Series	Tool Illustration	Coolant	Length	Drill Point Angle	Helix Angle	Material Group	Page
2XDSS				140° - 142°	30°		45-49
2XDSCR				140° - 142°	30°		50-54
2XDCCS				140° - 142°	30°		55-58
2XDCCR				140° - 142°	30°		59-63
2XDCL				140° - 142°	30°		64-66
2XDCE	 Length varies depending on size			140° - 142°	30°		67
Technical Information							135



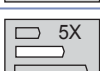

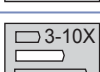





















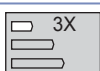

Twister® Spot Drills Page 68-69

Series	Tool Illustration	Coolant	Length	Drill Point Angle	Helix Angle	Material Group	Page
200S				145°	Straight Flute		68
403				120°	21°		69
404				90°	21°		69
Technical Information							135

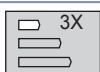
Twister® HP Drills Page 70-86

Series	Tool Illustration	Coolant	Length	Drill Point Angle	Helix Angle	Material Group	Page
HPDSR				140°	30°		70-73
HPDCR				140°	30°		70-73
2MDCL				140°	15°		74
207CE				—	35°		75-76
229				150°	30°		77-80
305	 Length varies depending on size			135°	12°		81-86
Technical Information							135

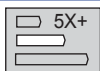
Twister® GP Drills Page 87-134

Series	Tool Illustration	Coolant	Length	Drill Point Angle	Helix Angle	Material Group	Page
200				135°	Straight Flute		88-94
200 Sets				135°	Straight Flute		95
204				118°	21°		96-97
205				135°	12°		98-104
206				118°	21°		105-106
207				35°	35°		107-110
209				135°	18°*		111-113









*Drills manufactured after 8-1-2012 have 30° helix angle

For product information, call your local distributor.

Twister® GP Drills Page 87-134 (continued)

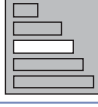
Series	Tool Illustration	Coolant	Length	Drill Point Angle	Helix Angle	Material Group	Page
210				135°	21°		114
224				118°	21°		115-116
226				118°	21°		117-118
300				118°	35°		119-122
302				130°	35°		123-127
306				165°	35°		128-130
402			—	—	—		131
200S				145°	Straight Flute		132
403				120°	21°		133
404				90°	21°		133
405			—	—	—		134
Technical Information							135

Tuff-Cut® HP End Mills Page 172-251

Series	Tool Illustration	Z	Length	Corner Type	Helix Angle	Material Group	Page
277 277W		4		Square End Corner Radius	38° / 41°		174-177
277 Sets		4		Square End Corner Radius	38° / 41°		180
277N		4		Square End Corner Radius Neck Relief	38° / 41°		178-180

Tuff-Cut® HP End Mills Page 172-251 (continued)

Series	Tool Illustration	Z	Length	Corner Type	Helix Angle	Material Group	Page
278 278W		5		Square End Corner Radius	40°		181-190
278N		5		Corner Radius Neck Relief	40°		191-192
279		4		Ball Nose	35° / 38°		193
180		7		Square End Corner Radius	38°		194-196
180N		7		Corner Radius Neck Relief	38°		197
180CB		7		Square End	38°		198
177 177W		4		Square End Corner Radius	35°/38°		199-203
177L		4		Corner Radius Neck Relief	35°/38°		204
177S		4		Square End Corner Radius Neck Relief	35°/38°		205
178 178W		5		Square End Corner Radius	38°		206-208
178N		5		Corner Radius Neck Relief	38°		209
179		4		Ball Nose	35°/38°		210
179L		4		Ball Nose Neck Relief	35°/38°		211
135		2		Corner Radius	30°		212-213

Tuff-Cut® HP End Mills Page 172-251 (continued)

Series	Tool Illustration	Z	Length	Corner Type	Helix Angle	Material Group	Page
135N		2		Square End Corner Radius Neck Relief	30°		214-217
135B		2		Ball Nose	37°		218
135BN		2		Ball Nose Neck Relief	37°		219
136		2		Square End	45°		220-221
134		3		Square End	45°		222
134S		3		Square End	45°		222
134N		3		Square End Neck Relief	45°		223
138 / 138R		3		Square End Corner Radius	36°		224-230
138N / 138NR		3		Square End Corner Radius Neck Relief	36°		231-234
138CE		3		Square End	36°		235-236
138B		3		Ball Nose	36°		237
138BN		3		Ball Nose Neck Relief	36°		238
156		2		Neck Relief Ball Nose	20°		239-242
158		4		Neck Relief Corner Radius	35° / 38°		243

Tuff-Cut® HP End Mills Page 172-251 (continued)

Series	Tool Illustration	Z	Length	Corner Type	Helix Angle	Material Group	Page
157		Multi		Square End Corner Radius	45°		244-246
192		Multi		Square End	20°		247
112		3		Square End	53°		248
113		6		Square End	53°		249-250
Technical Information							298















Tuff-Cut® GP End Mills Page 252-296

Series	Tool Illustration	Z	Length	Corner Type	Helix Angle	Material Group	Page
111	 • Micro sizes available.	4		Square End Corner Radius	30°		253-257
111 Coated		4		Square End	30°		258
114		4		Square End	30°		259
117		4		Square End	30°		260-261
163	 • Micro sizes available.	4		Square End	30°		262-264
163 Coated		4		Square End	30°		265
122		4		Square End	30°		266
132		4		Square End	30°		267
116		3		Square End	30°		268-269

Tuff-Cut® GP End Mills Page 252-296 (continued)

Series	Tool Illustration	Z	Length	Corner Type	Helix Angle	Material Group	Page
116 Coated		3		Square End	30°		270
116C Workhorse		3		Corner Radius	30°		271
169		3		Square End	30°		272-273
169 Coated		3		Square End	30°		274
169C Workhorse		3		Corner Radius	30°		275
121	 • Micro sizes available.	2		Square End Corner Radius	30°		276-280
121 Coated		2		Square End	30°		281
164	 • Micro sizes available.	2		Square End	30°		282-284
164 Coated		2		Square End	30°		285
123		2		Square End	30°		286
140		4		Ball Nose	30°		287
140 Coated		4		Ball Nose	30°		288
165		4		Ball Nose	30°		289-290
165 Coated		4		Ball Nose	30°		290
145		3		Ball Nose	30°		291







Tuff-Cut® GP End Mills Page 252-296 (continued)

Series	Tool Illustration	Z	Length	Corner Type	Helix Angle	Material Group	Page
145 Coated		3		Ball Nose	30°		291
150	 • Micro sizes available.	2		Ball Nose	30°		292-293
150 Coated		2		Ball Nose	30°		294
166		2		Ball Nose	30°		295-296
166 Coated		2		Ball Nose	30°		296
Technical Information							298

TrueSize® Reamer Page 375-401

Series	Tool Illustration	Z	Lead Cutting Angle	Material Group	Page
270 Straight Flute		4/6 RHC			376-377
270L Left Hand Spiral		4/6 LHS-RHC			376-377
270P Precision Tolerance OD		4 RHC			378
272		4/6 RHC			379-401
Technical Information					402









Countersinks Page 407-423

Series	Tool Illustration	Z	Material	Included Angle	Material Group	Page
60		1	C	60° 82° 90° 100°		409
61		1	HSS	60° 82° 90° 100° 120°		409
61B		1	HSS	60° 82° 90° 100° 120°		410



Countersinks Page 407-423 (continued)

Series	Tool Illustration	Z	Material	Included Angle	Material Group	Page
61T		1	HSS	60° 82° 90° 100° 120°		411
64 Sets		1	HSS	60° 82° 90° 100° 120°		412
67		0	HSS	60° 82° 90°		413
78		6	C	60° 82° 90° 100° 120°		413
79		6	HSS	60° 82° 90° 100° 120°		414
79B		6	HSS	60° 82° 90° 100° 120°		415
79T		6	HSS	60° 82° 90° 100° 120°		416
79 Sets		6	HSS	60° 82° 90° 100°		417
92		3	HSS	60° 82° 90° 100° 120°		418
92 Sets		3	HSS	60° 82° 90° 100° 120°		418
880 882 883		1	HSS	60° 82° 90°		419
890 892 893		3	HSS	60° 82° 90°		420
83		2	HSS	82° 90° 100° 120°		421

Countersinks Page 407-423 *(continued)*

Series	Tool Illustration	Z	Shank	Material	Included Angle	Material Group	Page
84		2	1/4 - 28	HSS	82° 90° 100° 120°		421
86		3	1/4 - 28	HSS	82° 90° 100° 120°		422
87		3	1/4 - 28	HSS	82° 90° 100° 120°		422
850			.086"	HSS			423
851			.093"	HSS			423
Technical Information							425











Micro-Stop Fixtures Page 424

Series	Tool Illustration	Material	Page
80000006/ 80000006E		Steel	424
80000007/ 80000007E		Plastic	424
80		Steel	424
Technical Information			425

Edge Hog® Burs Page 427-452

Series	Tool Illustration	Shape	Cut	Material Group	Page
SA		Cylindrical Flat End	Single Double Fine Shear	See page 428 of catalog	429-430
SB		Cylindrical Flat End with End Cut	Single Double Fine Shear	See page 428 of catalog	431-432

Edge Hog® Burs Page 427-452 (continued)

Series	Tool Illustration	Shape	Cut	Material Group	Page
SC		Cylindrical Radius End	Single Double Fine Shear	See page 428 of catalog	433-434
SD		Spherical	Single Double Fine Shear	See page 428 of catalog	435-436
SE		Elliptical	Single Double Fine Shear	See page 428 of catalog	437-438
SF		Tree Shape Radius End	Single Double Fine Shear	See page 428 of catalog	439-440
SG		Tree Shape Point End	Single Double Fine	See page 428 of catalog	441-442
SH		Flame	Single Double Fine	See page 428 of catalog	443-444
SJ		60° Angle Tool	Single Double Fine	See page 428 of catalog	445
SK		90° Angle Tool	Single Double	See page 428 of catalog	446
SL		Conical Radius End	Single Double Fine Shear	See page 428 of catalog	447-448
SM		Conical	Single Double Fine	See page 428 of catalog	449-450
SN		Back Taper	Single Double Fine	See page 428 of catalog	451
71	Bur Sets	Multiple Shapes per Set	Single Double Fine	See page 428 of catalog	452
Technical Information					453

Diamond Grind Routers Page 455-464

Series	Tool Illustration	End Grind	Cut	Coating	Material Group	Page
230		Safe	Down	—		463
231		End Mill	Down	—		463
231B		Bur	Down	—		463
231D		Drill	Down	—		463
231F		Fishtail	Down	—		463
239		Bur End Mill Safe Fishtail	Up	GemX		457-458
230CE		Safe	Down	CERAedge®		460
231CE		End Mill	Down	CERAedge®		460
231BCE		Bur	Down	CERAedge®		460
231DCE		Drill	Down	CERAedge®		460
Technical Information						459, 461, 464







Custom Tool Division Page 466-467

Coatings Page 472-473







Material Conversion Chart Page 474-479

Icon Glossary

Drill Icons









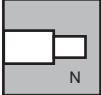

	Solid Carbide		Helix Angle 12°
	Coolant Fed		Coatings ALtima®
	Drill Length 3X		DIN Specs >3mm DIN 6537L
	Drill Point Angle 135°		

Workpiece Material Group







		Steels
		Hardened Steels (35-65Rc)
		Stainless Steels
		Cast Iron
		Special Alloys
		Non-Ferrous

HP Drill Selection Chart See Page 135.
Drill Terminology See Page 170.

End Mill Icons

	Number of Flutes Z3		Neck Relief N
	Center Cutting		Corner Radius
	Lengths		Shank
	Coatings ALtima®		Shank/DIN HB DIN6535
	Helix Angle 30°		Chipbreaker Chipbreaker
	Ball Nose		

Workpiece Material Group

		Steels
		Hardened Steels (35-65Rc)
		Stainless Steels
		Cast Iron
		Special Alloys
		Non-Ferrous

End Mill Terminology See Page 362.



The "Perfect Storm" for High Performance Drilling

Cyclone

Cyclone XD

Cyclone Series CXDSS
Cyclone Series CXDSR

Cyclone Series CXDCS
Cyclone Series CXDCR

NEW Cyclone Series CXDCL

Cyclone DA

Drill for Aluminum and Similar Materials

NEW Cyclone Series CDACR

Twister® XD

Xtreme High Performance Drilling

Twister XD® Series 2XDSS
Twister XD® Series 2XDSR
Twister XD® Series 2XDCS
Twister XD® Series 2XDCR
Twister XD® Series 2XDCL
Twister XD® Series 2XDCE
Twister® Series 200S, 403 & 404 - Spot Drills

All HP Drill shanks are manufactured to h6 nominal diameters for heat shrink shank applications.

For HP Drill Selection Chart,
See Page 135.

ISO 9001:2008 Certified

Twister® High Performance Drills

NEW Twister® HPD Series HPDCR & HPDSR

Twister® MD Series 2MDCL

NEW Twister® HP Series 207CE

Twister® AL Series 229

Twister® Micro-Tuff® Series 305

Twister® General Purpose Drills

Twister® GP Series 200/200 Sets

Twister® GP Series 204

Twister® GP Series 205

Twister® GP Series 206

Twister® GP Series 207

Twister® GP Series 209

Twister® GP Series 210

Twister® GP Series 224

Twister® GP Series 226

Twister® GP Series 300

Twister® GP Series 302

Twister® GP Series 306

Twister® GP Series 402

Twister® GP Series 200S

Twister® GP Series 403

Twister® GP Series 404

Twister® GP Series 405



Where *high performance* is the *standard*®

For product information, call your local distributor.

CYCLONE

The "Perfect Storm" for High Performance Drilling

CXD ADVANCED DRILLING FEATURES AND BENEFITS

- **New lower thrust point geometry**

- Refined edge protection for better performance in titanium and stainless steel (coolant through), and carbon steels



- **Enhanced double margin design**

- Back margin location allows for quicker engagement in hole
- Improved hole finishes
- Improved location when drilling through cross holes



- **ALtima® Plus AlTiN multi-layer coating**

- Higher heat resistance means higher RPM capabilities
- Optimized coating structure lengthens drill life and reduces chipping and wear

- **Enhanced surface finish technology pre and post coating**

- Pre-treatment enhances coating adhesion
- Post-treatment enhances chip evacuation

CXD Case Studies:

Size: .758" (19.25mm)
 Work material: 1018 steel plate
 Machine: Haas VF-5
 Competitor: X
 RPM (n): 1940
 vc-SFM: 385 m/min: 117
 (f) IPR: .0135 mm/Rev: .34
 Hole Depth: 1.5" (38mm)
M.A. Ford® Holes Produced: 3000
 Competitor X Holes Produced: 2000
Total Drill Cost Savings During Test: \$3,810

Size: 11/32"
 Work material: 304 stainless steel modified
 Machine: Mazak CNC lathe
 Competitor: Y
 RPM (n): 2228
 vc-SFM: 200 m/min: 61
 (f) IPR: .008 mm/Rev: .20
 Hole Depth: 1.8" (45mm)
M.A. Ford® Holes Produced: 382
(ran out of parts)
Customer was very pleased with the CXD drill.
 The CXD drill showed no chipping along cutting edges and flutes. The Competitor Y tool showed heavy chipping on cutting edges and flutes at same point of tool life.

ALtima® Plus Multi-Layer AlTiN Coating

M.A. Ford® 7/16" solid carbide drill
 Workpiece Material: 4140 Steel
 Coating: **M.A. Ford® ALtima® Plus**
 Competitor Coating: AlCrN

22.5% more

	M.A. Ford® ALtima® Plus	Competitor AlCrN
Number of Holes Produced	6468	5280

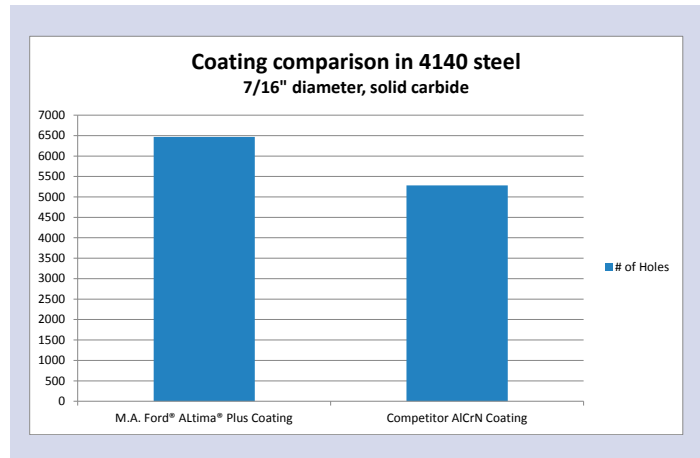

M.A. Ford® 7/16" coolant through carbide drill
 Workpiece Material: 4140 Steel
 Coating: **M.A. Ford® ALtima® Plus**
 Competitor Coating: AlCrN
 Competitor Coating: AlTiN

46% more

	M.A. Ford® ALtima® Plus	Competitor AlCrN	Competitor AlTiN
Number of Holes Produced	1890	1556	1296

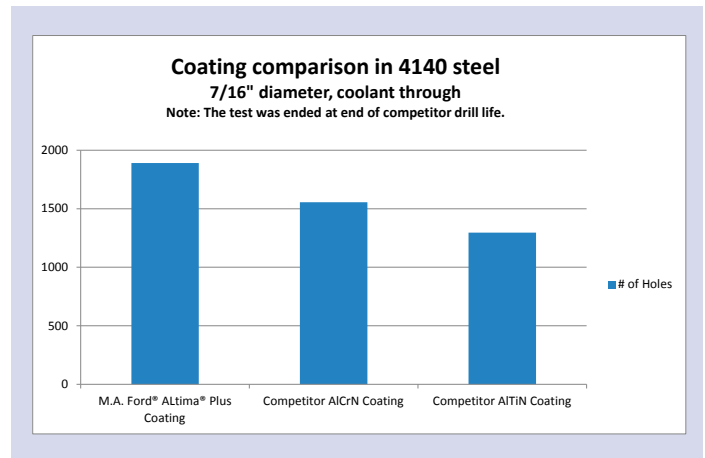

M.A. Ford® 7/16" coolant through carbide drill
 Workpiece Material: 304 Stainless Steel
 Coating: **M.A. Ford® ALtima® Plus**
 Competitor Coating: AlCrN

11% more

	M.A. Ford® ALtima® Plus	Competitor AlCrN
Number of Holes Produced	2484	2245

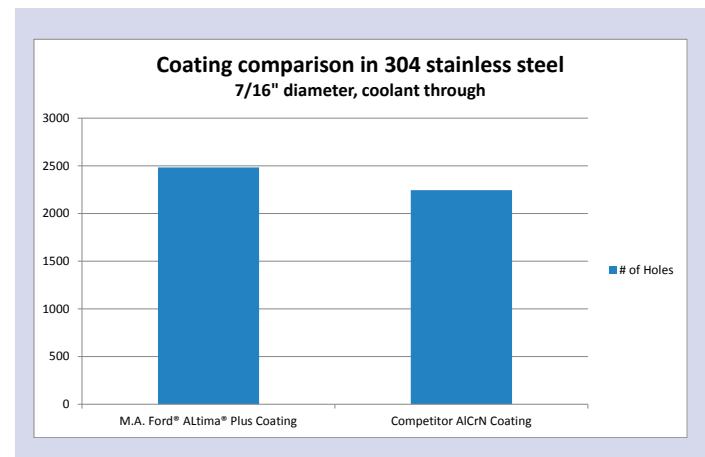

ALtima® Plus Multi-Layer AlTiN Coating

M.A. Ford® 1/4" coolant through carbide drill
 Workpiece Material: 4140 Steel
 Coating: **M.A. Ford® ALtima® Plus**
 Competitor Coating: AlTiN

10%
more

	M.A. Ford® ALtima® Plus	Competitor AlTiN
Number of Holes Produced	3284	3284

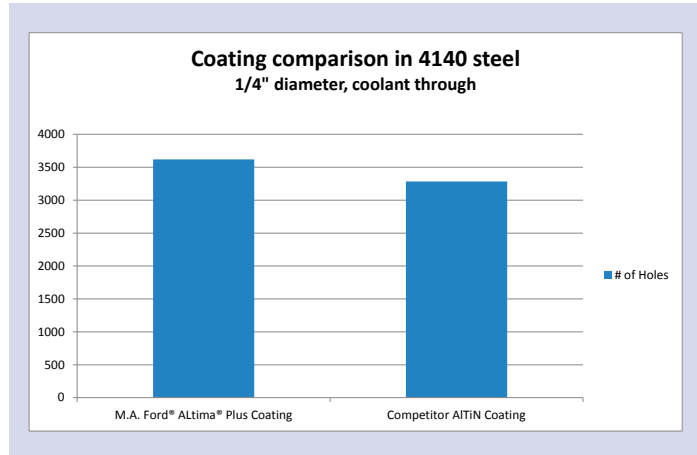

M.A. Ford® 1/4" coolant through carbide drill
 Workpiece Material: 6Al-4V Titanium
 Coating: **M.A. Ford® ALtima® Plus**
 Competitor Coating: AlTiN

17%
more

	M.A. Ford® ALtima® Plus	Competitor AlTiN
Number of Holes Produced	2303	1974

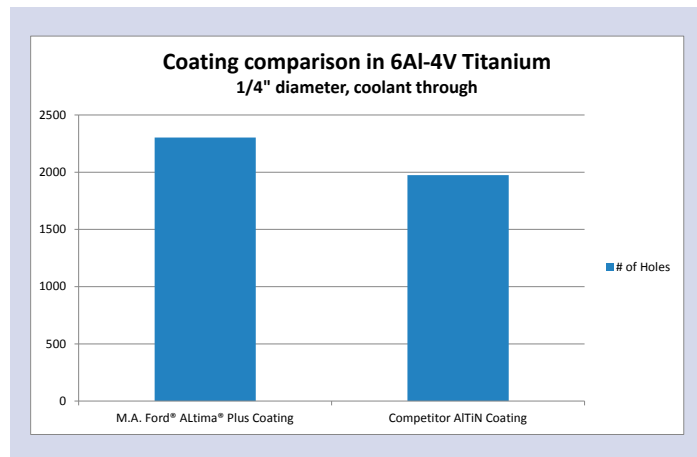

Improved Productivity • Lower Cost Per Hole

Cyclone Series CXDSS

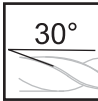
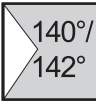
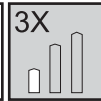
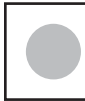

Designed for high performance drilling in a broad range of materials.

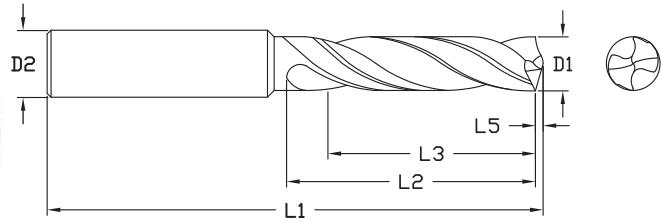

ALtima® Plus		Diameter				Shank		OAL		Flute Length		Drill Length		Point Length	
		D1 (m7)				D2 (h6)		L1		L2 (Max.)		L3 Ref.		L5	
Tool No.	EDP	Inch	Letter/ Wire	mm	Decimal	Inch	mm	Inch	mm	Inch	mm	Inch	mm	Inch	mm
CXDSS 0300AP	06615			3.0	.1181		3.0		62		20		14		0.46
CXDSS 1200AP	06616		#31		.1200	1/8		2.44		0.787		0.551		0.019	
CXDSS 0310AP	06617			3.1	.1220		4.0		62		20		14		0.48
CXDSS 1250AP	06618	1/8			.1250	1/8		2.44		0.787		0.551		0.019	
CXDSS 0320AP	06619			3.2	.1260		4.0		62		20		14		0.50
CXDSS 1285AP	06620		#30		.1285	5/32		2.44		0.787		0.551		0.020	
CXDSS 0330AP	06621			3.3	.1299		4.0		62		20		14		0.51
CXDSS 0340AP	06622			3.4	.1339		4.0		62		20		14		0.53
CXDSS 1360AP	06623		#29		.1360	5/32		2.44		0.787		0.551		0.021	
CXDSS 0350AP	06624			3.5	.1378		4.0		62		20		14		0.54
CXDSS 1406AP	06625	9/64			.1406	5/32		2.44		0.787		0.551		0.022	
CXDSS 0360AP	06626			3.6	.1417		4.0		62		20		14		0.56
CXDSS 0370AP	06627			3.7	.1457		4.0		62		20		14		0.57
CXDSS 0380AP	06628			3.8	.1496		4.0		66		24		17		0.59
CXDSS 1520AP	06629		#24		.1520	5/32		2.60		0.945		0.669		0.024	
CXDSS 0390AP	06630			3.9	.1535		4.0		66		24		17		0.60
CXDSS 1562AP	06631	5/32			.1562	5/32		2.60		0.945		0.669		0.024	
CXDSS 0400AP	06632			4.0	.1575		4.0		66		24		17		0.62
CXDSS 1590AP	06633		#21		.1590	3/16		2.60		0.945		0.669		0.025	
CXDSS 0410AP	06634			4.1	.1614		5.0		66		24		17		0.64
CXDSS 0420AP	06635			4.2	.1654		5.0		66		24		17		0.65
CXDSS 0430AP	06636			4.3	.1693		5.0		66		24		17		0.67
CXDSS 1719AP	06637	11/64			.1719	3/16		2.60		0.945		0.669		0.027	
CXDSS 0440AP	06638			4.4	.1732		5.0		66		24		17		0.68
CXDSS 0450AP	06639			4.5	.1772		5.0		66		24		17		0.70
CXDSS 0460AP	06640			4.6	.1811		5.0		66		24		17		0.71
CXDSS 0470AP	06641			4.7	.1850		5.0		66		24		17		0.73
CXDSS 1875AP	06642	3/16			.1875	3/16		2.60		1.102		0.787		0.029	
CXDSS 0480AP	06643			4.8	.1890		5.0		66		28		20		0.74
CXDSS 0490AP	06644			4.9	.1929		5.0		66		28		20		0.76

Inch		
D1	Tolerance (m7)	
.0000 - .1181	+0.0008/+0.0047	
.1182 - .2362	+0.0016/+0.0063	
.2363 - .3937	+0.0024/+0.0083	
.3938 - .7087	+0.0027/+0.0098	
.7088 - .7500	+0.0031/+0.0114	

Inch		
D2	Tolerance (h6)	
.0000 - .1181	+0/-0.0024	
.1182 - .2362	+0/-0.0031	
.2363 - .3937	+0/-0.0035	
.3938 - .7087	+0/-0.0043	
.7088 - .7500	+0/-0.0051	

Metric (mm)		
D1	Tolerance (m7)	
0 - 3.0	+0.02/+0.12	
3.01 - 6.0	+0.04/+0.16	
6.01 - 10.0	+0.06/+0.21	
10.01 - 18.0	+0.07/+0.25	
18.01 - 20.0	+0.08/+0.29	

Metric (mm)		
D2	Tolerance (h6)	
0 - 3.0	+0/-0.006	
3.01 - 6.0	+0/-0.008	
6.01 - 10.0	+0/-0.009	
10.01 - 18.0	+0/-0.011	
18.01 - 20.0	+0/-0.013	



Series CXDSS Continued

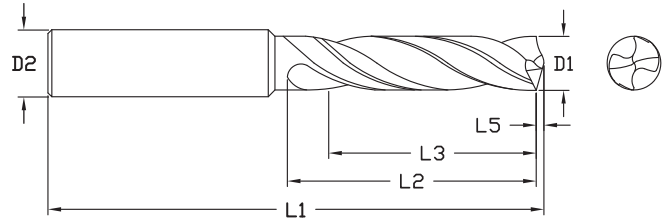
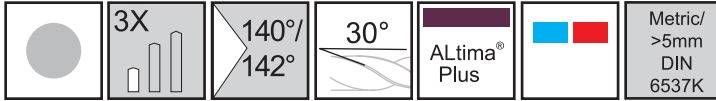

ALtima® Plus		Diameter				Shank		OAL		Flute Length		Drill Length		Point Length	
		D1 (m7)				D2 (h6)		L1		L2 (Max.)		L3 Ref.		L5	
Tool No.	EDP	Inch	Letter/ Wire	mm	Decimal	Inch	mm	Inch	mm	Inch	mm	Inch	mm	Inch	mm
CXDSS 0500AP	06645			5.0	.1968		5.0		66		28		20		0.77
CXDSS 0510AP	06646			5.1	.2008		6.0		66		28		20		0.79
CXDSS2031AP	06647	13/64			.2031	1/4		2.60		1.102		0.787		0.031	
CXDSS 0520AP	06648			5.2	.2047		6.0		66		28		20		0.81
CXDSS 0530AP	06649			5.3	.2087		6.0		66		28		20		0.82
CXDSS 0540AP	06650			5.4	.2126		6.0		66		28		20		0.84
CXDSS 0550AP	06651			5.5	.2165		6.0		66		28		20		0.85
CXDSS2187AP	06652	7/32			.2187	1/4		2.60		1.102		0.787		0.034	
CXDSS 0560AP	07091			5.6	.2205		6.0		66		28		20		0.86
CXDSS2210AP	06653		#2		.2210	1/4		2.60		1.102		0.787		0.034	
CXDSS 0570AP	06654			5.7	.2244		6.0		66		28		20		0.88
CXDSS 0580AP	06655			5.8	.2283		6.0		66		28		20		0.90
CXDSS 0590AP	06656			5.9	.2323		6.0		66		28		20		0.91
CXDSS2344AP	06657	15/64			.2344	1/4		2.60		1.102		0.787		0.036	
CXDSS 0600AP	06658			6.0	.2362		6.0		66		28		20		0.93
CXDSS 0610AP	06659			6.1	.2402		8.0		79		34		24		0.95
CXDSS2420AP	06660		C		.2420	1/4		3.11		1.339		0.945		0.037	
CXDSS 0620AP	06661			6.2	.2441		8.0		79		34		24		0.96
CXDSS2460AP	06662		D		.2460	1/4		3.11		1.339		0.945		0.038	
CXDSS 0630AP	06663			6.3	.2480		8.0		79		34		24		0.98
CXDSS2500AP	06664	1/4			.2500	1/4		3.11		1.339		0.945		0.039	
CXDSS 0640AP	06665			6.4	.2520		8.0		79		34		24		0.99
CXDSS 0650AP	06666			6.5	.2559		8.0		79		34		24		1.01
CXDSS2570AP	06667		F		.2570	5/16		3.11		1.339		0.945		0.040	
CXDSS 0660AP	06668			6.6	.2598		8.0		79		34		24		1.03
CXDSS2610AP	06669		G		.2610	5/16		3.11		1.339		0.945		0.040	
CXDSS 0670AP	06670			6.7	.2638		8.0		79		34		24		1.04
CXDSS2656AP	06671	17/64			.2656	5/16		3.11		1.339		0.945		0.041	
CXDSS 0680AP	06672			6.8	.2677		8.0		79		34		24		1.05
CXDSS 0690AP	06673			6.9	.2717		8.0		79		34		24		1.07
CXDSS 0700AP	06674			7.0	.2756		8.0		79		34		24		1.08
CXDSS 0710AP	06675			7.1	.2795		8.0		79		41		29		1.10
CXDSS2812AP	06676	9/32			.2812	5/16		3.11		1.614		1.142		0.044	
CXDSS 0720AP	06677			7.2	.2835		8.0		79		41		29		1.12
CXDSS 0730AP	06678			7.3	.2874		8.0		79		41		29		1.13
CXDSS 0740AP	06679			7.4	.2913		8.0		79		41		29		1.15
CXDSS 0750AP	06680			7.5	.2953		8.0		79		41		29		1.16
CXDSS2969AP	06681	19/64			.2969	5/16		3.11		1.614		1.142		0.046	
CXDSS 0760AP	06682			7.6	.2992		8.0		79		41		29		1.18
CXDSS 0770AP	06683			7.7	.3031		8.0		79		41		29		1.19
CXDSS 0780AP	06684			7.8	.3071		8.0		79		41		29		1.21



Series CXDSS Continued

ALtima® Plus		Diameter				Shank		OAL		Flute Length		Drill Length		Point Length	
		D1 (m7)				D2 (h6)		L1		L2 (Max.)		L3 Ref.		L5	
Tool No.	EDP	Inch	Letter/ Wire	mm	Decimal	Inch	mm	Inch	mm	Inch	mm	Inch	mm	Inch	mm
CXDSS 0790AP	06685			7.9	.3110		8.0		79		41		29		1.22
CXDSS3125AP	06686	5/16			.3125	5/16		3.11		1.614		1.142		0.048	
CXDSS 0800AP	06687			8.0	.3150		8.0		79		41		29		1.24
CXDSS 0810AP	06688			8.1	.3189		10.0		89		47		35		1.26
CXDSS 0820AP	06689			8.2	.3228		10.0		89		47		35		1.27
CXDSS 0830AP	06690			8.3	.3268		10.0		89		47		35		1.29
CXDSS3281AP	06691	21/64			.3281	3/8		3.50		1.850		1.378		0.051	
CXDSS 0840AP	06692			8.4	.3307		10.0		89		47		35		1.31
CXDSS3320AP	06693		Q		.3320	3/8		3.50		1.850		1.378		0.051	
CXDSS 0850AP	06694			8.5	.3346		10.0		89		47		35		1.32
CXDSS 0860AP	06695			8.6	.3386		10.0		89		47		35		1.33
CXDSS 0870AP	06696			8.7	.3425		10.0		89		47		35		1.35
CXDSS3438AP	06697	11/32			.3438	3/8		3.50		1.850		1.378		0.053	
CXDSS 0880AP	06698			8.8	.3465		10.0		89		47		35		1.36
CXDSS 0890AP	06699			8.9	.3504		10.0		89		47		35		1.38
CXDSS 0900AP	06700			9.0	.3543		10.0		89		47		35		1.39
CXDSS 0910AP	06701			9.1	.3583		10.0		89		47		35		1.41
CXDSS3594AP	06702	23/64			.3594	3/8		3.50		1.850		1.378		0.056	
CXDSS 0920AP	06703			9.2	.3622		10.0		89		47		35		1.43
CXDSS 0925AP	06704			9.25	.3642		10.0		89		47		35		1.43
CXDSS 0930AP	06705			9.3	.3661		10.0		89		47		35		1.44
CXDSS 0940AP	06706			9.4	.3701		10.0		89		47		35		1.46
CXDSS 0950AP	06707			9.5	.3740		10.0		89		47		35		1.47
CXDSS3750AP	06708	3/8			.3750	3/8		3.50		1.850		1.378		0.058	
CXDSS 0960AP	06709			9.6	.3780		10.0		89		47		35		1.49
CXDSS 0970AP	06710			9.7	.3819		10.0		89		47		35		1.50
CXDSS 0980AP	06711			9.8	.3858		10.0		89		47		35		1.52
CXDSS 0990AP	06712			9.9	.3898		10.0		89		47		35		1.53
CXDSS3906AP	06713	25/64			.3906	7/16		3.50		1.850		1.378		0.061	
CXDSS 1000AP	06714			10.0	.3937		10.0		89		47		35		1.55
CXDSS 1010AP	06715			10.1	.3976		12.0		102		55		40		1.56
CXDSS 1020AP	06716			10.2	.4016		12.0		102		55		40		1.58
CXDSS 1030AP	06717			10.3	.4055		12.0		102		55		40		1.60
CXDSS4062AP	06718	13/32			.4062	7/16		4.02		2.165		1.575		0.063	
CXDSS 1040AP	06719			10.4	.4094		12.0		102		55		40		1.61
CXDSS 1050AP	06720			10.5	.4134		12.0		102		55		40		1.63
CXDSS 1060AP	06721			10.6	.4173		12.0		102		55		40		1.64
CXDSS 1070AP	06722			10.7	.4213		12.0		102		55		40		1.66
CXDSS4219AP	06723	27/64			.4219	7/16		4.02		2.165		1.575		0.065	
CXDSS 1080AP	06724			10.8	.4252		12.0		102		55		40		1.67
CXDSS 1090AP	06725			10.9	.4291		12.0		102		55		40		1.69
CXDSS 1100AP	06726			11.0	.4331		12.0		102		55		40		1.70
CXDSS 1110AP	06727			11.1	.4370		12.0		102		55		40		1.72



Series CXDSS Continued

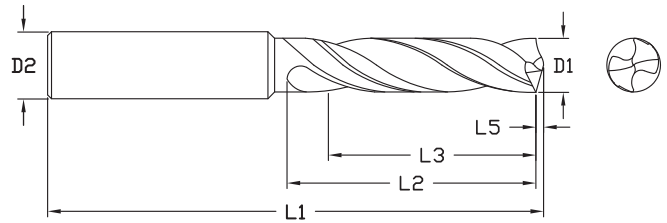
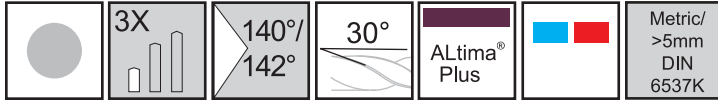

ALtima® Plus		Diameter				Shank		OAL		Flute Length		Drill Length		Point Length	
		D1 (m7)				D2 (h6)		L1		L2 (Max.)		L3 Ref.		L5	
Tool No.	EDP	Inch	Letter/ Wire	mm	Decimal	Inch	mm	Inch	mm	Inch	mm	Inch	mm	Inch	mm
CXDSS4375AP	06728	7/16			.4375	7/16		4.02		2.165		1.575		0.068	
CXDSS 1120AP	06729			11.2	.4409		12.0		102		55		40		1.74
CXDSS 1130AP	06730			11.3	.4449		12.0		102		55		40		1.75
CXDSS 1140AP	06731			11.4	.4488		12.0		102		55		40		1.77
CXDSS 1150AP	06732			11.5	.4527		12.0		102		55		40		1.78
CXDSS 1160AP	06733			11.6	.4567		12.0		102		55		40		1.80
CXDSS 1170AP	06734			11.7	.4606		12.0		102		55		40		1.81
CXDSS 1180AP	06735			11.8	.4646		12.0		102		55		40		1.83
CXDSS 1190AP	06736			11.9	.4685		12.0		102		55		40		1.84
CXDSS4688AP	06737	15/32			.4688	1/2		4.02		2.165		1.575		0.073	
CXDSS 1200AP	06738			12.0	.4724		12.0		102		55		40		1.86
CXDSS 1210AP	06739			12.1	.4764		14.0		107		60		43		1.87
CXDSS4844AP	06740	31/64			.4844	1/2		4.21		2.362		1.693		0.075	
CXDSS 1250AP	06741			12.5	.4921		14.0		107		60		43		1.94
CXDSS5000AP	06742	1/2			.5000	1/2		4.21		2.362		1.693		0.077	
CXDSS 1280AP	06743			12.8	.5039		14.0		107		60		43		1.98
CXDSS 1283AP	06744			12.83	.5051		14.0		107		60		43		1.99
CXDSS 1290AP	06745			12.9	.5079		14.0		107		60		43		2.00
CXDSS 1300AP	06746			13.0	.5118		14.0		107		60		43		2.01
CXDSS5156AP	06747	33/64			.5156	9/16		4.21		2.362		1.693		0.080	
CXDSS5312AP	06748	17/32			.5312	9/16		4.21		2.362		1.693		0.082	
CXDSS 1350AP	06750			13.5	.5315		14.0		107		60		43		2.09
CXDSS 1370AP	06751			13.7	.5394		14.0		107		60		43		2.12
CXDSS5469AP	06752	35/64			.5469	9/16		4.21		2.362		1.693		0.085	
CXDSS 1400AP	06753			14.0	.5512		14.0		107		60		43		2.17
CXDSS5625AP	06754	9/16			.5625	9/16		4.53		2.559		1.772		0.087	
CXDSS 1450AP	06755			14.5	.5709		16.0		115		65		45		2.25
CXDSS 1470AP	06756			14.7	.5787		16.0		115		65		45		2.28
CXDSS 1500AP	06757			15.0	.5905		16.0		115		65		45		2.32
CXDSS5938AP	06758	19/32			.5938	5/8		4.53		2.559		1.772		0.092	
CXDSS 1530AP	06759			15.3	.6024		16.0		115		65		45		2.37
CXDSS 1550AP	06760			15.5	.6102		16.0		115		65		45		2.40
CXDSS 1570AP	06761			15.7	.6181		16.0		115		65		45		2.43
CXDSS6250AP	06762	5/8			.6250	5/8		4.53		2.559		1.772		0.097	
CXDSS 1600AP	06763			16.0	.6299		16.0		115		65		45		2.48
CXDSS 1608AP	06764			16.08	.6331		18.0		123		73		51		2.49
CXDSS 1630AP	06765			16.3	.6417		18.0		123		73		51		2.53
CXDSS 1650AP	06766			16.5	.6496		18.0		123		73		51		2.56



Series CXDSS Continued

ALtima® Plus		Diameter				Shank		OAL		Flute Length		Drill Length		Point Length	
		D1 (m7)				D2 (h6)		L1		L2 (Max.)		L3 Ref.		L5	
Tool No.	EDP	Inch	Letter/ Wire	mm	Decimal	Inch	mm	Inch	mm	Inch	mm	Inch	mm	Inch	mm
CXDSS6562AP	06767	21/32			.6562	11/16		4.84		2.874		2.008		0.102	
CXDSS 1700AP	06768			17.0	.6693		18.0		123		73		51		2.63
CXDSS6875AP	06769	11/16			.6875	11/16		4.84		2.874		2.008		0.107	
CXDSS 1750AP	06770			17.5	.6890		18.0		123		73		51		2.71
CXDSS 1800AP	06771			18.0	.7087		18.0		123		73		51		2.79
CXDSS 1850AP	06772			18.5	.7283		20.0		131		79		55		2.87
CXDSS7500AP	06773	3/4			.7500	3/4		5.16		3.11		2.165		0.116	
CXDSS 1916AP	06774			19.16	.7543		20.0		131		79		55		2.97
CXDSS 1925AP	06775			19.25	.7579		20.0		131		79		55		2.98
CXDSS 1930AP	06776			19.3	.7598		20.0		131		79		55		2.99
CXDSS 1950AP	06777			19.5	.7677		20.0		131		79		55		3.02
CXDSS 2000AP	06778			20.0	.7874		20.0		131		79		55		3.10



NEW ALtima® Plus Advanced High Performance Coating

Coating Properties

MA Ford® Coating	MA Ford® Tool Number Designation	Microhardness (HV)	Maximum Service Temp.	Friction Coefficient
ALtima® Plus	AP	3200	1100° C / 2012° F	0.25

Safety Note

Always wear the appropriate personal protective equipment such as safety glasses and protective clothing when using solid carbide or HSS cutting tools. Machines should be fully guarded. Technical data provided should be considered advisory only as variations may be necessary depending on the particular application.

Cyclone Series CXDSR

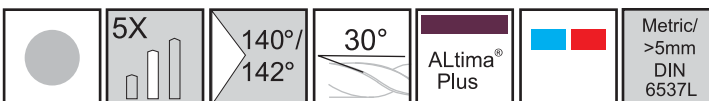

Designed for high performance drilling in a broad range of materials.

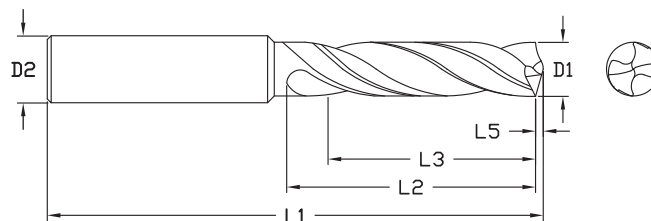

ALtima® Plus		Diameter				Shank		OAL		Flute Length		Drill Length		Point Length	
		D1 (m7)				D2 (h6)		L1		L2 (Max.)		L3 Ref.		L5	
Tool No.	EDP	Inch	Letter/ Wire	mm	Decimal	Inch	mm	Inch	mm	Inch	mm	Inch	mm	Inch	mm
CXDSR 0300AP	06467			3.0	.1181		3.0		66		28		23		0.46
CXDSR 1200AP	06468		#31		.1200	1/8		2.60		1.102		0.906		0.019	
CXDSR 0310AP	06469			3.1	.1220		4.0		66		28		23		0.48
CXDSR 1250AP	06470	1/8			.1250	1/8		2.60		1.102		0.906		0.019	
CXDSR 0320AP	06471			3.2	.1260		4.0		66		28		23		0.50
CXDSR 1285AP	06472		#30		.1285	5/32		2.60		1.102		0.906		0.020	
CXDSR 0330AP	06473			3.3	.1299		4.0		66		28		23		0.51
CXDSR 0340AP	06474			3.4	.1339		4.0		66		28		23		0.53
CXDSR 1360AP	06475		#29		.1360	5/32		2.60		1.102		0.906		0.021	
CXDSR 0350AP	06476			3.5	.1378		4.0		66		28		23		0.54
CXDSR 1406AP	06477	9/64			.1406	5/32		2.60		1.102		0.906		0.022	
CXDSR 0360AP	06478			3.6	.1417		4.0		66		28		23		0.56
CXDSR 0370AP	06479			3.7	.1457		4.0		66		28		23		0.57
CXDSR 0380AP	06480			3.8	.1496		4.0		74		36		29		0.59
CXDSR 1520AP	06481		#24		.1520	5/32		2.91		1.417		1.142		0.024	
CXDSR 0390AP	06482			3.9	.1535		4.0		74		36		29		0.60
CXDSR 1562AP	06483	5/32			.1562	5/32		2.91		1.417		1.142		0.024	
CXDSR 0400AP	06484			4.0	.1575		4.0		74		36		29		0.62
CXDSR 1590AP	06485		#21		.1590	3/16		2.91		1.417		1.142		0.025	
CXDSR 0410AP	06486			4.1	.1614		5.0		74		36		29		0.64
CXDSR 0420AP	06487			4.2	.1654		5.0		74		36		29		0.65
CXDSR 0430AP	06488			4.3	.1693		5.0		74		36		29		0.67
CXDSR 1719AP	06489	11/64			.1719	3/16		2.91		1.417		1.142		0.027	
CXDSR 0440AP	06490			4.4	.1732		5.0		74		36		29		0.68
CXDSR 0450AP	06491			4.5	.1772		5.0		74		36		29		0.70
CXDSR 0460AP	06492			4.6	.1811		5.0		74		36		29		0.71
CXDSR 0470AP	06493			4.7	.1850		5.0		74		36		29		0.73
CXDSR 1875AP	06494	3/16			.1875	3/16		3.23		1.732		1.378		0.029	
CXDSR 0480AP	06495			4.8	.1890		5.0		82		44		35		0.74
CXDSR 0490AP	06496			4.9	.1929		5.0		82		44		35		0.76
CXDSR 0500AP	06497			5.0	.1968		5.0		82		44		35		0.77

Inch		
D1	Tolerance (m7)	
.0000 - .1181	+0.0008/+0.0047	
.1182 - .2362	+0.0016/+0.0063	
.2363 - .3937	+0.0024/+0.0083	
.3938 - .7087	+0.0027/+0.0098	

Inch		
D2	Tolerance (h6)	
.0000 - .1181	+0/-0.0024	
.1182 - .2362	+0/-0.0031	
.2363 - .3937	+0/-0.0035	
.3938 - .7087	+0/-0.0043	

Metric (mm)		
D1	Tolerance (m7)	
0 - 3.0	+0.02/+0.12	
3.01 - 6.0	+0.04/+0.16	
6.01 - 10.0	+0.06/+0.21	
10.01 - 18.0	+0.07/+0.25	

Metric (mm)		
D2	Tolerance (h6)	
0 - 3.0	+0/-0.006	
3.01 - 6.0	+0/-0.008	
6.01 - 10.0	+0/-0.009	
10.01 - 18.0	+0/-0.011	



Series CXDSR Continued

ALtima® Plus		Diameter				Shank		OAL		Flute Length		Drill Length		Point Length	
		D1 (m7)				D2 (h6)		L1		L2 (Max.)		L3 Ref.		L5	
Tool No.	EDP	Inch	Letter/ Wire	mm	Decimal	Inch	mm	Inch	mm	Inch	mm	Inch	mm	Inch	mm
CXDSR 0510AP	06498			5.1	.2008		6.0		82		44		35		0.79
CXDSR2031AP	06499	13/64			.2031	1/4		3.23		1.732		1.378		0.031	
CXDSR 0520AP	06500			5.2	.2047		6.0		82		44		35		0.81
CXDSR 0530AP	06501			5.3	.2087		6.0		82		44		35		0.82
CXDSR 0540AP	06502			5.4	.2126		6.0		82		44		35		0.84
CXDSR 0550AP	06503			5.5	.2165		6.0		82		44		35		0.85
CXDSR2187AP	06504	7/32			.2187	1/4		3.23		1.732		1.378		0.034	
CXDSR 0560AP	07092			5.6	.2205		6.0		82		44		35		0.86
CXDSR2210AP	06505		#2		.2210	1/4		3.23		1.732		1.378		0.034	
CXDSR 0570AP	06506			5.7	.2244		6.0		82		44		35		0.88
CXDSR 0580AP	06507			5.8	.2283		6.0		82		44		35		0.90
CXDSR 0590AP	06508			5.9	.2323		6.0		82		44		35		0.91
CXDSR2344AP	06509	15/64			.2344	1/4		3.23		1.732		1.378		0.036	
CXDSR 0600AP	06510			6.0	.2362		6.0		82		44		35		0.93
CXDSR 0610AP	06511			6.1	.2402		8.0		91		53		43		0.95
CXDSR2420AP	06512		C		.2420	1/4		3.58		2.087		1.693		0.037	
CXDSR 0620AP	06513			6.2	.2441		8.0		91		53		43		0.96
CXDSR2460AP	06514		D		.2460	1/4		3.58		2.087		1.693		0.038	
CXDSR 0630AP	06515			6.3	.2480		8.0		91		53		43		0.98
CXDSR2500AP	06516	1/4			.2500	1/4		3.58		2.087		1.693		0.039	
CXDSR 0640AP	06517			6.4	.2520		8.0		91		53		43		0.99
CXDSR 0650AP	06518			6.5	.2559		8.0		91		53		43		1.01
CXDSR2570AP	06519		F		.2570	5/16		3.58		2.087		1.693		0.040	
CXDSR 0660AP	06520			6.6	.2598		8.0		91		53		43		1.03
CXDSR2610AP	06521		G		.2610	5/16		3.58		2.087		1.693		0.040	
CXDSR 0670AP	06522			6.7	.2638		8.0		91		53		43		1.04
CXDSR2656AP	06523	17/64			.2656	5/16		3.58		2.087		1.693		0.041	
CXDSR 0680AP	06524			6.8	.2677		8.0		91		53		43		1.05
CXDSR 0690AP	06525			6.9	.2717		8.0		91		53		43		1.07
CXDSR 0700AP	06526			7.0	.2756		8.0		91		53		43		1.08
CXDSR 0710AP	06527			7.1	.2795		8.0		91		53		43		1.10
CXDSR2812AP	06528	9/32			.2812	5/16		3.58		2.087		1.693		0.044	
CXDSR 0720AP	06529			7.2	.2835		8.0		91		53		43		1.12
CXDSR 0730AP	06530			7.3	.2874		8.0		91		53		43		1.13
CXDSR 0740AP	06531			7.4	.2913		8.0		91		53		43		1.15
CXDSR 0750AP	06532			7.5	.2953		8.0		91		53		43		1.16
CXDSR2969AP	06533	19/64			.2969	5/16		3.58		2.087		1.693		0.046	
CXDSR 0760AP	06534			7.6	.2992		8.0		91		53		43		1.18
CXDSR 0770AP	06535			7.7	.3031		8.0		91		53		43		1.19
CXDSR 0780AP	06536			7.8	.3071		8.0		91		53		43		1.21
CXDSR 0790AP	06537			7.9	.3110		8.0		91		53		43		1.22
CXDSR3125AP	06538	5/16			.3125	5/16		3.58		2.087		1.693		0.048	
CXDSR 0800AP	06539			8.0	.3150		8.0		91		53		43		1.24



Series CXDSR Continued

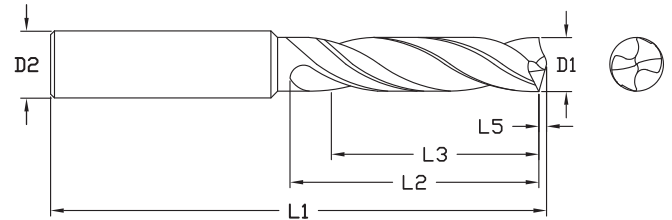
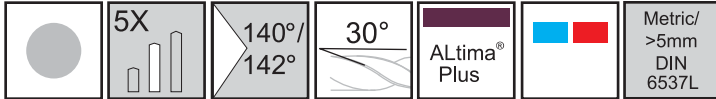

ALtima® Plus		Diameter				Shank		OAL		Flute Length		Drill Length		Point Length	
		D1 (m7)				D2 (h6)		L1		L2 (Max.)		L3 Ref.		L5	
Tool No.	EDP	Inch	Letter/ Wire	mm	Decimal	Inch	mm	Inch	mm	Inch	mm	Inch	mm	Inch	mm
CXDSR 0810AP	06540			8.1	.3189	10.0			103		61		49		1.26
CXDSR 0820AP	06541			8.2	.3228	10.0			103		61		49		1.27
CXDSR 0830AP	06542			8.3	.3268	10.0			103		61		49		1.29
CXDSR3281AP	06543	21/64			.3281	3/8		4.06		2.402		1.929		0.051	
CXDSR 0840AP	06544			8.4	.3307	10.0			103		61		49		1.31
CXDSR3320AP	06545		Q		.3320	3/8		4.06		2.402		1.929		0.051	
CXDSR 0850AP	06546			8.5	.3346	10.0			103		61		49		1.32
CXDSR 0860AP	06547			8.6	.3386	10.0			103		61		49		1.33
CXDSR 0870AP	06548			8.7	.3425	10.0			103		61		49		1.35
CXDSR3438AP	06549	11/32			.3438	3/8		4.06		2.402		1.929		0.053	
CXDSR 0880AP	06550			8.8	.3465	10.0			103		61		49		1.36
CXDSR 0890AP	06551			8.9	.3504	10.0			103		61		49		1.38
CXDSR 0900AP	06552			9.0	.3543	10.0			103		61		49		1.39
CXDSR 0910AP	06553			9.1	.3583	10.0			103		61		49		1.41
CXDSR3594AP	06554	23/64			.3594	3/8		4.06		2.402		1.929		0.056	
CXDSR 0920AP	06555			9.2	.3622	10.0			103		61		49		1.43
CXDSR 0925AP	06556			9.3	.3642	10.0			103		61		49		1.43
CXDSR 0930AP	06557			9.3	.3661	10.0			103		61		49		1.44
CXDSR 0940AP	06558			9.4	.3701	10.0			103		61		49		1.46
CXDSR 0950AP	06559			9.5	.3740	10.0			103		61		49		1.47
CXDSR3750AP	06560	3/8			.3750	3/8		4.06		2.402		1.929		0.058	
CXDSR 0960AP	06561			9.6	.3780	10.0			103		61		49		1.49
CXDSR 0970AP	06562			9.7	.3819	10.0			103		61		49		1.50
CXDSR 0980AP	06563			9.8	.3858	10.0			103		61		49		1.52
CXDSR 0990AP	06564			9.9	.3898	10.0			103		61		49		1.53
CXDSR3906AP	06565	25/64			.3906	7/16		4.06		2.402		1.929		0.061	
CXDSR 1000AP	06566			10.0	.3937	10.0			103		61		49		1.55
CXDSR 1010AP	06567			10.1	.3976	12.0			118		71		56		1.56
CXDSR 1020AP	06568			10.2	.4016	12.0			118		71		56		1.58
CXDSR 1030AP	06569			10.3	.4055	12.0			118		71		56		1.60
CXDSR4062AP	06570	13/32			.4062	7/16		4.65		2.795		2.205		0.063	
CXDSR 1040AP	06571			10.4	.4094	12.0			118		71		56		1.61
CXDSR 1050AP	06572			10.5	.4134	12.0			118		71		56		1.63
CXDSR 1060AP	06573			10.6	.4173	12.0			118		71		56		1.64
CXDSR 1070AP	06574			10.7	.4213	12.0			118		71		56		1.66
CXDSR4219AP	06575	27/64			.4219	7/16		4.65		2.795		2.205		0.065	
CXDSR 1080AP	06576			10.8	.4252	12.0			118		71		56		1.67
CXDSR 1090AP	06577			10.9	.4291	12.0			118		71		56		1.69



Series CXDSR Continued

ALtima® Plus		Diameter				Shank		OAL		Flute Length		Drill Length		Point Length	
		D1 (m7)				D2 (h6)		L1		L2 (Max.)		L3 Ref.		L5	
Tool No.	EDP	Inch	Letter/ Wire	mm	Decimal	Inch	mm	Inch	mm	Inch	mm	Inch	mm	Inch	mm
CXDSR 1100AP	06578			11.0	.4331		12.0		118		71		56		1.70
CXDSR 1110AP	06579			11.1	.4370		12.0		118		71		56		1.72
CXDSR4375AP	06580	7/16			.4375	7/16		4.65		2.795		2.205		0.068	
CXDSR 1120AP	06581			11.2	.4409		12.0		118		71		56		1.74
CXDSR 1130AP	06582			11.3	.4449		12.0		118		71		56		1.75
CXDSR 1140AP	06583			11.4	.4488		12.0		118		71		56		1.77
CXDSR 1150AP	06584			11.5	.4527		12.0		118		71		56		1.78
CXDSR 1160AP	06585			11.6	.4567		12.0		118		71		56		1.80
CXDSR 1170AP	06586			11.7	.4606		12.0		118		71		56		1.81
CXDSR 1180AP	06587			11.8	.4646		12.0		118		71		56		1.83
CXDSR 1190AP	06588			11.9	.4685		12.0		118		71		56		1.84
CXDSR4688AP	06589	15/32			.4688	1/2		4.65		2.795		2.205		0.073	
CXDSR 1200AP	06590			12.0	.4724		12.0		118		71		56		1.86
CXDSR 1210AP	06591			12.1	.4764		14.0		124		77		60		1.87
CXDSR4844AP	06592	31/64			.4844	1/2		4.88		3.031		2.362		0.075	
CXDSR 1250AP	06593			12.5	.4921		14.0		124		77		60		1.94
CXDSR5000AP	06594	1/2			.5000	1/2		4.88		3.031		2.362		0.077	
CXDSR 1280AP	06595			12.8	.5039		14.0		124		77		60		1.98
CXDSR 1283AP	06596			12.83	.5051		14.0		124		77		60		1.99
CXDSR 1290AP	06597			12.9	.5079		14.0		124		77		60		2.00
CXDSR 1300AP	06598			13.0	.5118		14.0		124		77		60		2.01
CXDSR5156AP	06599	33/64			.5156	9/16		4.88		3.031		2.362		0.080	
CXDSR5312AP	06600	17/32			.5312	9/16		4.88		3.031		2.362		0.082	
CXDSR 1350AP	06601			13.5	.5315		14.0		124		77		60		2.09
CXDSR 1370AP	06602			13.7	.5394		14.0		124		77		60		2.12
CXDSR5469AP	06603	35/64			.5469	9/16		4.88		3.031		2.362		0.085	
CXDSR 1400AP	06604			14.0	.5512		14.0		124		77		60		2.17
CXDSR5625AP	06605	9/16			.5625	9/16		5.24		3.268		2.480		0.087	
CXDSR 1450AP	06606			14.5	.5709		16.0		133		83		63		2.25
CXDSR 1470AP	06607			14.7	.5787		16.0		133		83		63		2.28
CXDSR 1500AP	06608			15.0	.5905		16.0		133		83		63		2.32
CXDSR5938AP	06609	19/32			.5938	5/8		5.24		3.268		2.480		0.092	
CXDSR 1530AP	06610			15.3	.6024		16.0		133		83		63		2.37
CXDSR 1550AP	06611			15.5	.6102		16.0		133		83		63		2.40
CXDSR 1570AP	06612			15.7	.6181		16.0		133		83		63		2.43
CXDSR6250AP	06613	5/8			.6250	5/8		5.24		3.268		2.480		0.097	
CXDSR 1600AP	06614			16.0	.6299		16.0		133		83		63		2.48



Cyclone Series CXDCS

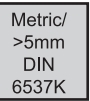
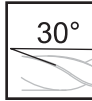
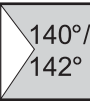
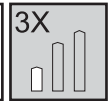

Designed for high performance drilling in a broad range of materials.

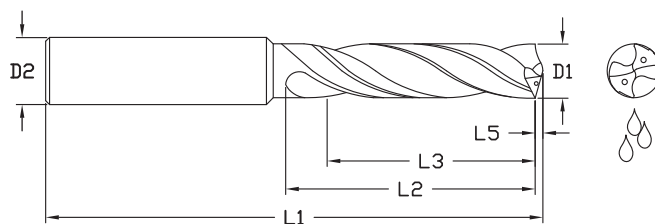

ALtima® Plus		Diameter				Shank		OAL	Flute Length		Drill Length		Point Length		
		D1 (m7)				D2 (h6)		L1	L2 (Max.)		L3 Ref.		L5		
Tool No.	EDP	Inch	Letter/ Wire	mm	Decimal	Inch	mm	Inch	mm	Inch	mm	Inch	mm	Inch	mm
CXDCS 0300AP	06779			3.0	.1181		3.0		62		20		14		0.46
CXDCS1200AP	06780		#31		.1200	1/8		2.44		0.787		0.551		0.019	
CXDCS 0310AP	06781			3.1	.1220		4.0		62		20		14		0.48
CXDCS1250AP	06782	1/8			.1250	1/8		2.44		0.787		0.551		0.019	
CXDCS 0320AP	06783			3.2	.1260		4.0		62		20		14		0.50
CXDCS1285AP	06784		#30		.1285	5/32		2.44		0.787		0.551		0.020	
CXDCS 0330AP	06785			3.3	.1299		4.0		62		20		14		0.51
CXDCS 0340AP	06786			3.4	.1339		4.0		62		20		14		0.53
CXDCS1360AP	06787		#29		.1360	5/32		2.44		0.787		0.551		0.021	
CXDCS 0350AP	06788			3.5	.1378		4.0		62		20		14		0.54
CXDCS1406AP	06789	9/64			.1406	5/32		2.44		0.787		0.551		0.022	
CXDCS 0360AP	06790			3.6	.1417		4.0		62		20		14		0.56
CXDCS 0370AP	06791			3.7	.1457		4.0		62		20		14		0.57
CXDCS 0380AP	06792			3.8	.1496		4.0		66		24		17		0.59
CXDCS1520AP	06793		#24		.1520	5/32		2.60		0.945		0.669		0.024	
CXDCS 0390AP	06794			3.9	.1535		4.0		66		24		17		0.60
CXDCS1562AP	06795	5/32			.1562	5/32		2.60		0.945		0.669		0.024	
CXDCS 0400AP	06796			4.0	.1575		4.0		66		24		17		0.62
CXDCS1590AP	06797		#21		.1590	3/16		2.60		0.945		0.669		0.025	
CXDCS 0410AP	06798			4.1	.1614		5.0		66		24		17		0.64
CXDCS 0420AP	06799			4.2	.1654		5.0		66		24		17		0.65
CXDCS 0430AP	06800			4.3	.1693		5.0		66		24		17		0.67
CXDCS1719AP	06801	11/64			.1719	3/16		2.60		0.945		0.669		0.027	
CXDCS 0440AP	06802			4.4	.1732		5.0		66		24		17		0.68
CXDCS 0450AP	06803			4.5	.1772		5.0		66		24		17		0.70
CXDCS 0460AP	06804			4.6	.1811		5.0		66		24		17		0.71
CXDCS 0470AP	06805			4.7	.1850		5.0		66		24		17		0.73
CXDCS1875AP	06806	3/16			.1875	3/16		2.60		1.102		0.787		0.029	
CXDCS 0480AP	06807			4.8	.1890		5.0		66		28		20		0.74
CXDCS 0490AP	06808			4.9	.1929		5.0		66		28		20		0.76
CXDCS 0500AP	06809			5.0	.1968		5.0		66		28		20		0.77
CXDCS 0510AP	06810			5.1	.2008		6.0		66		28		20		0.79
CXDCS2031AP	06811	13/64			.2031	1/4		2.60		1.102		0.787		0.031	

Inch	
D1	Tolerance (m7)
.0000 - .1181	+0.0008/+0.0047
.1182 - .2362	+0.0016/+0.0063
.2363 - .3937	+0.0024/+0.0083
.3938 - .7087	+0.0027/+0.0098

Inch	
D2	Tolerance (h6)
.0000 - .1181	+0/-0.00024
.1182 - .2362	+0/-0.00031
.2363 - .3937	+0/-0.00035
.3938 - .7087	+0/-0.00043

Metric (mm)	
D1	Tolerance (m7)
0 - 3.0	+0.02/+0.012
3.01 - 6.0	+0.04/+0.016
6.01 - 10.0	+0.06/+0.021
10.01 - 18.0	+0.07/+0.025

Metric (mm)	
D2	Tolerance (h6)
0 - 3.0	+0/-0.006
3.01 - 6.0	+0/-0.008
6.01 - 10.0	+0/-0.009
10.01 - 18.0	+0/-0.011



Series CXDCS Continued

ALtima® Plus		Diameter				Shank		OAL		Flute Length		Drill Length		Point Length	
		D1 (m7)				D2 (h6)		L1		L2 (Max.)		L3 Ref.		L5	
Tool No.	EDP	Inch	Letter/ Wire	mm	Decimal	Inch	mm	Inch	mm	Inch	mm	Inch	mm	Inch	mm
CXDCS 0520AP	06812			5.2	.2047		6.0		66		28		20		0.81
CXDCS 0530AP	06813			5.3	.2087		6.0		66		28		20		0.82
CXDCS 0540AP	06814			5.4	.2126		6.0		66		28		20		0.84
CXDCS 0550AP	06815			5.5	.2165		6.0		66		28		20		0.85
CXDCS2187AP	06816	7/32			.2187	1/4		2.60		1.102		0.787		0.034	
CXDCS 0560AP	07093			5.6	.2205		6.0		66		28		20		0.86
CXDCS2210AP	06817		#2		.2210	1/4		2.60		1.102		0.787		0.034	
CXDCS 0570AP	06818			5.7	.2244		6.0		66		28		20		0.88
CXDCS 0580AP	06819			5.8	.2283		6.0		66		28		20		0.90
CXDCS 0590AP	06820			5.9	.2323		6.0		66		28		20		0.91
CXDCS2344AP	06821	15/64			.2344	1/4		2.60		1.102		0.787		0.036	
CXDCS 0600AP	06822			6.0	.2362		6.0		66		28		20		0.93
CXDCS 0610AP	06823			6.1	.2402		8.0		79		34		24		0.95
CXDCS2420AP	06824		C		.2420	1/4		3.11		1.339		0.945		0.037	
CXDCS 0620AP	06825			6.2	.2441		8.0		79		34		24		0.96
CXDCS2460AP	06826		D		.2460	1/4		3.11		1.339		0.945		0.038	
CXDCS 0630AP	06827			6.3	.2480		8.0		79		34		24		0.98
CXDCS2500AP	06828	1/4			.2500	1/4		3.11		1.339		0.945		0.039	
CXDCS 0640AP	06829			6.4	.2520		8.0		79		34		24		0.99
CXDCS 0650AP	06830			6.5	.2559		8.0		79		34		24		1.01
CXDCS2570AP	06831		F		.2570	5/16		3.11		1.339		0.945		0.040	
CXDCS 0660AP	06832			6.6	.2598		8.0		79		34		24		1.03
CXDCS2610AP	06833		G		.2610	5/16		3.11		1.339		0.945		0.040	
CXDCS 0670AP	06834			6.7	.2638		8.0		79		34		24		1.04
CXDCS2656AP	06835	17/64			.2656	5/16		3.11		1.339		0.945		0.041	
CXDCS 0680AP	06836			6.8	.2677		8.0		79		34		24		1.05
CXDCS 0690AP	06837			6.9	.2717		8.0		79		34		24		1.07
CXDCS 0700AP	06838			7.0	.2756		8.0		79		34		24		1.08
CXDCS 0710AP	06839			7.1	.2795		8.0		79		41		29		1.10
CXDCS2812AP	06840	9/32			.2812	5/16		3.11		1.614		1.142		0.044	
CXDCS 0720AP	06841			7.2	.2835		8.0		79		41		29		1.12
CXDCS 0730AP	06842			7.3	.2874		8.0		79		41		29		1.13
CXDCS 0740AP	06843			7.4	.2913		8.0		79		41		29		1.15
CXDCS 0750AP	06844			7.5	.2953		8.0		79		41		29		1.16
CXDCS2969AP	06845	19/64			.2969	5/16		3.11		1.614		1.142		0.046	
CXDCS 0760AP	06846			7.6	.2992		8.0		79		41		29		1.18
CXDCS 0770AP	06847			7.7	.3031		8.0		79		41		29		1.19
CXDCS 0780AP	06848			7.8	.3071		8.0		79		41		29		1.21
CXDCS 0790AP	06849			7.9	.3110		8.0		79		41		29		1.22
CXDCS3125AP	06850	5/16			.3125	5/16		3.11		1.614		1.142		0.048	
CXDCS 0800AP	06851			8.0	.3150		8.0		79		41		29		1.24
CXDCS 0810AP	06852			8.1	.3189		10.0		89		47		35		1.26



Series CXDCS Continued

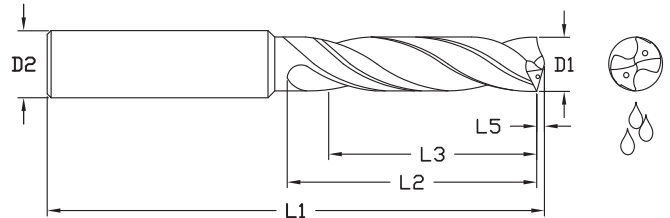
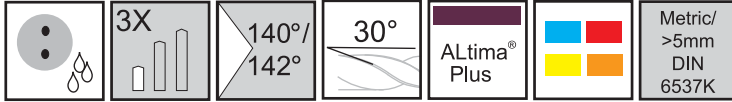

ALtima® Plus		Diameter				Shank		OAL		Flute Length		Drill Length		Point Length	
		D1 (m7)				D2 (h6)		L1		L2 (Max.)		L3 Ref.		L5	
Tool No.	EDP	Inch	Letter/ Wire	mm	Decimal	Inch	mm	Inch	mm	Inch	mm	Inch	mm	Inch	mm
CXDCS 0820AP	06853			8.2	.3228		10.0		89		47		35		1.27
CXDCS 0830AP	06854			8.3	.3268		10.0		89		47		35		1.29
CXDCS3281AP	06855	21/64			.3281	3/8		3.50		1.850		1.378		0.051	
CXDCS 0840AP	06856			8.4	.3307		10.0		89		47		35		1.31
CXDCS3320AP	06857		Q		.3320	3/8		3.50		1.850		1.378		0.051	
CXDCS 0850AP	06858			8.5	.3346		10.0		89		47		35		1.32
CXDCS 0860AP	06859			8.6	.3386		10.0		89		47		35		1.33
CXDCS 0870AP	06860			8.7	.3425		10.0		89		47		35		1.35
CXDCS3438AP	06861	11/32			.3438	3/8		3.50		1.850		1.378		0.053	
CXDCS 0880AP	06862			8.8	.3465		10.0		89		47		35		1.36
CXDCS 0890AP	06863			8.9	.3504		10.0		89		47		35		1.38
CXDCS 0900AP	06864			9.0	.3543		10.0		89		47		35		1.39
CXDCS 0910AP	06865			9.1	.3583		10.0		89		47		35		1.41
CXDCS3594AP	06866	23/64			.3594	3/8		3.50		1.850		1.378		0.056	
CXDCS 0920AP	06867			9.2	.3622		10.0		89		47		35		1.43
CXDCS 0925AP	06868			9.25	.3642		10.0		89		47		35		1.43
CXDCS 0930AP	06869			9.3	.3661		10.0		89		47		35		1.44
CXDCS 0940AP	06870			9.4	.3701		10.0		89		47		35		1.46
CXDCS 0950AP	06871			9.5	.3740		10.0		89		47		35		1.47
CXDCS3750AP	06872	3/8			.3750	3/8		3.50		1.850		1.378		0.058	
CXDCS 0960AP	06873			9.6	.3780		10.0		89		47		35		1.49
CXDCS 0970AP	06874			9.7	.3819		10.0		89		47		35		1.50
CXDCS 0980AP	06875			9.8	.3858		10.0		89		47		35		1.52
CXDCS 0990AP	06876			9.9	.3898		10.0		89		47		35		1.53
CXDCS3906AP	06877	25/64			.3906	7/16		3.50		1.850		1.378		0.061	
CXDCS 1000AP	06878			10.0	.3937		10.0		89		47		35		1.55
CXDCS 1010AP	06879			10.1	.3976		12.0		102		55		40		1.56
CXDCS 1015AP	07095			10.15	.3996		12.0		102		55		40		1.57
CXDCS 1020AP	06880			10.2	.4016		12.0		102		55		40		1.58
CXDCS 1030AP	06881			10.3	.4055		12.0		102		55		40		1.60
CXDCS4062AP	06882	13/32			.4062	7/16		4.02		2.165		1.575		0.063	
CXDCS 1040AP	06883			10.4	.4094		12.0		102		55		40		1.61
CXDCS 1050AP	06884			10.5	.4134		12.0		102		55		40		1.63
CXDCS 1060AP	06885			10.6	.4173		12.0		102		55		40		1.64
CXDCS 1070AP	06886			10.7	.4213		12.0		102		55		40		1.66
CXDCS4219AP	06887	27/64			.4219	7/16		4.02		2.165		1.575		0.065	
CXDCS 1080AP	06888			10.8	.4252		12.0		102		55		40		1.67
CXDCS 1090AP	06889			10.9	.4291		12.0		102		55		40		1.69
CXDCS 1100AP	06890			11.0	.4331		12.0		102		55		40		1.70



Series CXDCS Continued

ALtima® Plus		Diameter				Shank		OAL		Flute Length		Drill Length		Point Length	
		D1 (m7)				D2 (h6)		L1		L2 (Max.)		L3 Ref.		L5	
Tool No.	EDP	Inch	Letter/ Wire	mm	Decimal	Inch	mm	Inch	mm	Inch	mm	Inch	mm	Inch	mm
CXDCS 1110AP	06891			11.1	.4370		12.0		102		55		40		1.72
CXDCS4375AP	06892	7/16			.4375	7/16		4.02		2.165		1.575		0.068	
CXDCS 1120AP	06893			11.2	.4409		12.0		102		55		40		1.74
CXDCS 1130AP	06894			11.3	.4449		12.0		102		55		40		1.75
CXDCS 1140AP	06895			11.4	.4488		12.0		102		55		40		1.77
CXDCS 1150AP	06896			11.5	.4527		12.0		102		55		40		1.78
CXDCS 1155AP	07090			11.55	.4547		12.0		102		55		40		1.79
CXDCS 1160AP	06897			11.6	.4567		12.0		102		55		40		1.80
CXDCS 1170AP	06898			11.7	.4606		12.0		102		55		40		1.81
CXDCS 1180AP	06899			11.8	.4646		12.0		102		55		40		1.83
CXDCS 1190AP	06900			11.9	.4685		12.0		102		55		40		1.84
CXDCS4688AP	06901	15/32			.4688	1/2		4.02		2.165		1.575		0.073	
CXDCS 1200AP	06902			12.0	.4724		12.0		102		55		40		1.86
CXDCS 1210AP	06903			12.1	.4764		14.0		107		60		43		1.87
CXDCS4844AP	06904	31/64			.4844	1/2		4.21		2.362		1.693		0.075	
CXDCS 1250AP	06905			12.5	.4921		14.0		107		60		43		1.94
CXDCS5000AP	06906	1/2			.5000	1/2		4.21		2.362		1.693		0.077	
CXDCS 1280AP	06907			12.8	.5039		14.0		107		60		43		1.98
CXDCS 1283AP	06908			12.83	.5051		14.0		107		60		43		1.99
CXDCS 1290AP	06909			12.9	.5079		14.0		107		60		43		2.00
CXDCS 1300AP	06910			13.0	.5118		14.0		107		60		43		2.01
CXDCS5156AP	06911	33/64			.5156	9/16		4.21		2.362		1.693		0.080	
CXDCS 1320AP	07096			13.2	.5197		14.0		107		60		43		2.06
CXDCS5312AP	07089	17/32			.5312	9/16		4.21		2.362		1.693		0.082	
CXDCS 1350AP	06912			13.5	.5315		14.0		107		60		43		2.09
CXDCS 1370AP	06913			13.7	.5394		14.0		107		60		43		2.12
CXDCS5469AP	06914	35/64			.5469	9/16		4.21		2.362		1.693		0.085	
CXDCS 1400AP	06915			14.0	.5512		14.0		107		60		43		2.17
CXDCS5625AP	06916	9/16			.5625	9/16		4.53		2.559		1.772		0.087	
CXDCS 1450AP	06917			14.5	.5709		16.0		115		65		45		2.25
CXDCS 1470AP	06918			14.7	.5787		16.0		115		65		45		2.28
CXDCS 1475AP	07097			14.75	.5807		16.0		115		65		45		2.30
CXDCS 1500AP	06919			15.0	.5905		16.0		115		65		45		2.32
CXDCS5938AP	06920	19/32			.5938	5/8		4.53		2.559		1.772		0.092	
CXDCS 1530AP	06921			15.3	.6024		16.0		115		65		45		2.37
CXDCS 1550AP	06922			15.5	.6102		16.0		115		65		45		2.40
CXDCS 1570AP	06923			15.7	.6181		16.0		115		65		45		2.43
CXDCS6250AP	06924	5/8			.6250	5/8		4.53		2.559		1.772		0.097	
CXDCS 1600AP	06925			16.0	.6299		16.0		115		65		45		2.48



Cyclone Series CXDCR

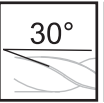
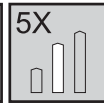

Designed for high performance drilling in a broad range of materials.

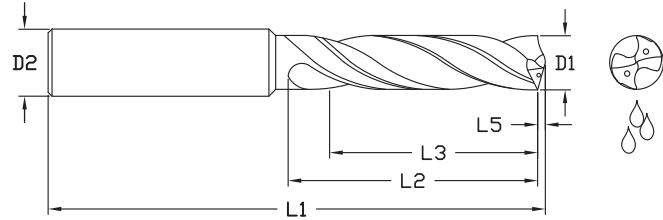

ALtima® Plus		Diameter				Shank		OAL		Flute Length		Drill Length		Point Length	
		D1 (m7)				D2 (h6)		L1		L2 (Max.)		L3 Ref.		L5	
Tool No.	EDP	Inch	Letter/ Wire	mm	Decimal	Inch	mm	Inch	mm	Inch	mm	Inch	mm	Inch	mm
CXDCR 0300AP	06926			3.0	.1181		3.0		66		28		23		0.46
CXDCR1200AP	06927		#31		.1200	1/8		2.60		1.102		0.906		0.019	
CXDCR 0310AP	06928			3.1	.1220		4.0		66		28		23		0.48
CXDCR1250AP	06929	1/8			.1250	1/8		2.60		1.102		0.906		0.019	
CXDCR 0320AP	06930			3.2	.1260		4.0		66		28		23		0.50
CXDCR1285AP	06931		#30		.1285	5/32		2.60		1.102		0.906		0.020	
CXDCR 0330AP	06932			3.3	.1299		4.0		66		28		23		0.51
CXDCR 0340AP	06933			3.4	.1339		4.0		66		28		23		0.53
CXDCR1360AP	06934		#29		.1360	5/32		2.60		1.102		0.906		0.021	
CXDCR 0350AP	06935			3.5	.1378		4.0		66		28		23		0.54
CXDCR1406AP	06936	9/64			.1406	5/32		2.60		1.102		0.906		0.022	
CXDCR 0360AP	06937			3.6	.1417		4.0		66		28		23		0.56
CXDCR 0370AP	06938			3.7	.1457		4.0		66		28		23		0.57
CXDCR 0380AP	06939			3.8	.1496		4.0		74		36		29		0.59
CXDCR1520AP	06940		#24		.1520	5/32		2.91		1.417		1.142		0.024	
CXDCR 0390AP	06941			3.9	.1535		4.0		74		36		29		0.60
CXDCR1562AP	06942	5/32			.1562	5/32		2.91		1.417		1.142		0.024	
CXDCR 0400AP	06943			4.0	.1575		4.0		74		36		29		0.62
CXDCR1590AP	06944		#21		.1590	3/16		2.91		1.417		1.142		0.025	
CXDCR 0410AP	06945			4.1	.1614		5.0		74		36		29		0.64
CXDCR 0420AP	06946			4.2	.1654		5.0		74		36		29		0.65
CXDCR 0430AP	06947			4.3	.1693		5.0		74		36		29		0.67
CXDCR1719AP	06948	11/64			.1719	3/16		2.91		1.417		1.142		0.027	
CXDCR 0440AP	06949			4.4	.1732		5.0		74		36		29		0.68
CXDCR 0450AP	06950			4.5	.1772		5.0		74		36		29		0.70
CXDCR 0460AP	06951			4.6	.1811		5.0		74		36		29		0.71
CXDCR 0470AP	06952			4.7	.1850		5.0		74		36		29		0.73
CXDCR1875AP	06953	3/16			.1875	3/16		3.23		1.732		1.378		0.029	
CXDCR 0480AP	06954			4.8	.1890		5.0		82		44		35		0.74
CXDCR 0490AP	06955			4.9	.1929		5.0		82		44		35		0.76
CXDCR 0500AP	06956			5.0	.1968		5.0		82		44		35		0.77

Inch		Inch	
D1	Tolerance (m7)	D2	Tolerance (h6)
.0000 - .1181	+0.0008/+0.0047	.0000 - .1181	+0/-0.0024
.1182 - .2362	+0.0016/+0.0063	.1182 - .2362	+0/-0.0031
.2363 - .3937	+0.0024/+0.0083	.2363 - .3937	+0/-0.0035
.3938 - .7087	+0.0027/+0.0098	.3938 - .7087	+0/-0.0043
.7088 - .7500	+0.0031/+0.0114	.7088 - .7500	+0/-0.0051

Inch		Metric (mm)	
D1	Tolerance (m7)	D2	Tolerance (h6)
0 - 3.0	+0.02/+0.12	0 - 3.0	+0/-0.006
3.01 - 6.0	+0.04/+0.16	3.01 - 6.0	+0/-0.008
6.01 - 10.0	+0.06/+0.21	6.01 - 10.0	+0/-0.009
10.01 - 18.0	+0.07/+0.25	10.01 - 18.0	+0/-0.011
18.01 - 20.0	+0.08/+0.29	18.01 - 20.0	+0/-0.013

Metric (mm)		Metric (mm)	
D1	Tolerance (m7)	D2	Tolerance (h6)
0 - 3.0	+0.02/+0.12	0 - 3.0	+0/-0.006
3.01 - 6.0	+0.04/+0.16	3.01 - 6.0	+0/-0.008
6.01 - 10.0	+0.06/+0.21	6.01 - 10.0	+0/-0.009
10.01 - 18.0	+0.07/+0.25	10.01 - 18.0	+0/-0.011
18.01 - 20.0	+0.08/+0.29	18.01 - 20.0	+0/-0.013

Metric (mm)		Metric (mm)	
D1	Tolerance (m7)	D2	Tolerance (h6)
0 - 3.0	+0.02/+0.12	0 - 3.0	+0/-0.006
3.01 - 6.0	+0.04/+0.16	3.01 - 6.0	+0/-0.008
6.01 - 10.0	+0.06/+0.21	6.01 - 10.0	+0/-0.009
10.01 - 18.0	+0.07/+0.25	10.01 - 18.0	+0/-0.011
18.01 - 20.0	+0.08/+0.29	18.01 - 20.0	+0/-0.013



Series CXDCR Continued

ALtima® Plus		Diameter				Shank		OAL		Flute Length		Drill Length		Point Length	
		D1 (m7)				D2 (h6)		L1		L2 (Max.)		L3 Ref.		L5	
Tool No.	EDP	Inch	Letter/ Wire	mm	Decimal	Inch	mm	Inch	mm	Inch	mm	Inch	mm	Inch	mm
CXDCR 0510AP	06957			5.1	.2008		6.0		82		44		35		0.79
CXDCR2031AP	06958	13/64			.2031	1/4		3.23		1.732		1.378		0.031	
CXDCR 0520AP	06959			5.2	.2047		6.0		82		44		35		0.81
CXDCR 0530AP	06960			5.3	.2087		6.0		82		44		35		0.82
CXDCR 0540AP	06961			5.4	.2126		6.0		82		44		35		0.84
CXDCR 0550AP	06962			5.5	.2165		6.0		82		44		35		0.85
CXDCR2187AP	06963	7/32			.2187	1/4		3.23		1.732		1.378		0.034	
CXDCR 0560AP	07094			5.6	.2205		6.0		82		44		35		0.86
CXDCR2210AP	06964		#2		.2210	1/4		3.23		1.732		1.378		0.034	
CXDCR 0570AP	06965			5.7	.2244		6.0		82		44		35		0.88
CXDCR 0580AP	06966			5.8	.2283		6.0		82		44		35		0.90
CXDCR 0590AP	06967			5.9	.2323		6.0		82		44		35		0.91
CXDCR2344AP	06968	15/64			.2344	1/4		3.23		1.732		1.378		0.036	
CXDCR 0600AP	06969			6.0	.2362		6.0		82		44		35		0.93
CXDCR 0610AP	06970			6.1	.2402		8.0		91		53		43		0.95
CXDCR2420AP	06971		C		.2420	1/4		3.58		2.087		1.693		0.037	
CXDCR 0620AP	06972			6.2	.2441		8.0		91		53		43		0.96
CXDCR2460AP	06973		D		.2460	1/4		3.58		2.087		1.693		0.038	
CXDCR 0630AP	06974			6.3	.2480		8.0		91		53		43		0.98
CXDCR2500AP	06975	1/4			.2500	1/4		3.58		2.087		1.693		0.039	
CXDCR 0640AP	06976			6.4	.2520		8.0		91		53		43		0.99
CXDCR 0650AP	06977			6.5	.2559		8.0		91		53		43		1.01
CXDCR2570AP	06978		F		.2570	5/16		3.58		2.087		1.693		0.040	
CXDCR 0660AP	06979			6.6	.2598		8.0		91		53		43		1.03
CXDCR2610AP	06980		G		.2610	5/16		3.58		2.087		1.693		0.040	
CXDCR 0670AP	06981			6.7	.2638		8.0		91		53		43		1.04
CXDCR2656AP	06982	17/64			.2656	5/16		3.58		2.087		1.693		0.041	
CXDCR 0680AP	06983			6.8	.2677		8.0		91		53		43		1.05
CXDCR 0690AP	06984			6.9	.2717		8.0		91		53		43		1.07
CXDCR 0700AP	06985			7.0	.2756		8.0		91		53		43		1.08
CXDCR 0710AP	06986			7.1	.2795		8.0		91		53		43		1.10
CXDCR2812AP	06987	9/32			.2812	5/16		3.58		2.087		1.693		0.044	
CXDCR 0720AP	06988			7.2	.2835		8.0		91		53		43		1.12
CXDCR 0730AP	06989			7.3	.2874		8.0		91		53		43		1.13
CXDCR 0740AP	06990			7.4	.2913		8.0		91		53		43		1.15
CXDCR 0750AP	06991			7.5	.2953		8.0		91		53		43		1.16
CXDCR2969AP	06992	19/64			.2969	5/16		3.58		2.087		1.693		0.046	
CXDCR 0760AP	06993			7.6	.2992		8.0		91		53		43		1.18
CXDCR 0770AP	06994			7.7	.3031		8.0		91		53		43		1.19
CXDCR 0780AP	06995			7.8	.3071		8.0		91		53		43		1.21
CXDCR 0790AP	06996			7.9	.3110		8.0		91		53		43		1.22
CXDCR3125AP	06997	5/16			.3125	5/16		3.58		2.087		1.693		0.048	
CXDCR 0800AP	06998			8.0	.3150		8.0		91		53		43		1.24
CXDCR 0810AP	06999			8.1	.3189		10.0		103		61		49		1.26



Series CXDCR Continued

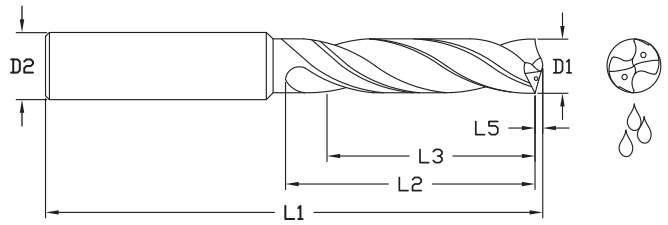
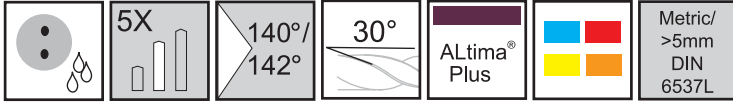

ALtima® Plus		Diameter				Shank		OAL		Flute Length		Drill Length		Point Length	
		Tool No.	EDP	D1 (m7)		D2 (h6)		L1		L2 (Max.)		L3 Ref.		L5	
Inch	Letter/ Wire			mm	Decimal	Inch	mm	Inch	mm	Inch	mm	Inch	mm	Inch	mm
CXDCR 0820AP	07000			8.2	.3228		10.0		103		61		49		1.27
CXDCR 0830AP	07001			8.3	.3268		10.0		103		61		49		1.29
CXDCR3281AP	07002	21/64			.3281	3/8		4.06		2.402		1.929		0.051	
CXDCR 0840AP	07003			8.4	.3307		10.0		103		61		49		1.31
CXDCR3320AP	07004		Q		.3320	3/8		4.06		2.402		1.929		0.051	
CXDCR 0850AP	07005			8.5	.3346		10.0		103		61		49		1.32
CXDCR 0860AP	07006			8.6	.3386		10.0		103		61		49		1.33
CXDCR 0870AP	07007			8.7	.3425		10.0		103		61		49		1.35
CXDCR3438AP	07008	11/32			.3438	3/8		4.06		2.402		1.929		0.053	
CXDCR 0880AP	07009			8.8	.3465		10.0		103		61		49		1.36
CXDCR 0890AP	07010			8.9	.3504		10.0		103		61		49		1.38
CXDCR 0900AP	07011			9.0	.3543		10.0		103		61		49		1.39
CXDCR 0910AP	07012			9.1	.3583		10.0		103		61		49		1.41
CXDCR3594AP	07013	23/64			.3594	3/8		4.06		2.402		1.929		0.056	
CXDCR 0920AP	07014			9.2	.3622		10.0		103		61		49		1.43
CXDCR 0925AP	07015			9.25	.3642		10.0		103		61		49		1.43
CXDCR 0930AP	07016			9.3	.3661		10.0		103		61		49		1.44
CXDCR 0940AP	07017			9.4	.3701		10.0		103		61		49		1.46
CXDCR 0950AP	07018			9.5	.3740		10.0		103		61		49		1.47
CXDCR3750AP	07019	3/8			.3750	3/8		4.06		2.402		1.929		0.058	
CXDCR 0960AP	07020			9.6	.3780		10.0		103		61		49		1.49
CXDCR 0970AP	07021			9.7	.3819		10.0		103		61		49		1.50
CXDCR 0980AP	07022			9.8	.3858		10.0		103		61		49		1.52
CXDCR 0990AP	07023			9.9	.3898		10.0		103		61		49		1.53
CXDCR3906AP	07024	25/64			.3906	7/16		4.06		2.402		1.929		0.061	
CXDCR 1000AP	07025			10.0	.3937		10.0		103		61		49		1.55
CXDCR 1010AP	07026			10.1	.3976		12.0		118		71		56		1.56
CXDCR 1020AP	07027			10.2	.4016		12.0		118		71		56		1.58
CXDCR 1030AP	07028			10.3	.4055		12.0		118		71		56		1.60
CXDCR4062AP	07029	13/32			.4062	7/16		4.65		2.795		2.205		0.063	
CXDCR 1040AP	07030			10.4	.4094		12.0		118		71		56		1.61
CXDCR 1050AP	07031			10.5	.4134		12.0		118		71		56		1.63
CXDCR 1060AP	07032			10.6	.4173		12.0		118		71		56		1.64
CXDCR 1070AP	07033			10.7	.4213		12.0		118		71		56		1.66
CXDCR4219AP	07034	27/64			.4219	7/16		4.65		2.795		2.205		0.065	
CXDCR 1080AP	07035			10.8	.4252		12.0		118		71		56		1.67
CXDCR 1090AP	07036			10.9	.4291		12.0		118		71		56		1.69
CXDCR 1100AP	07037			11.0	.4331		12.0		118		71		56		1.70



Series CXDCR Continued

ALtima® Plus		Diameter				Shank		OAL		Flute Length		Drill Length		Point Length	
		D1 (m7)				D2 (h6)		L1		L2 (Max.)		L3 Ref.		L5	
Tool No.	EDP	Inch	Letter/ Wire	mm	Decimal	Inch	mm	Inch	mm	Inch	mm	Inch	mm	Inch	mm
CXDCR 1110AP	07038			11.1	.4370		12.0		118		71		56		1.72
CXDCR4375AP	07039	7/16			.4375	7/16		4.65		2.795		2.205		0.068	
CXDCR 1120AP	07040			11.2	.4409		12.0		118		71		56		1.74
CXDCR 1130AP	07041			11.3	.4449		12.0		118		71		56		1.75
CXDCR 1140AP	07042			11.4	.4488		12.0		118		71		56		1.77
CXDCR 1150AP	07043			11.5	.4527		12.0		118		71		56		1.78
CXDCR 1160AP	07044			11.6	.4567		12.0		118		71		56		1.80
CXDCR 1170AP	07045			11.7	.4606		12.0		118		71		56		1.81
CXDCR 1180AP	07046			11.8	.4646		12.0		118		71		56		1.83
CXDCR 1190AP	07047			11.9	.4685		12.0		118		71		56		1.84
CXDCR4688AP	07048	15/32			.4688	1/2		4.65		2.795		2.205		0.073	
CXDCR 1200AP	07049			12.0	.4724		12.0		118		71		56		1.86
CXDCR 1210AP	07050			12.1	.4764		14.0		124		77		60		1.87
CXDCR4844AP	07051	31/64			.4844	1/2		4.88		3.031		2.362		0.075	
CXDCR 1250AP	07052			12.5	.4921		14.0		124		77		60		1.94
CXDCR5000AP	07053	1/2			.5000	1/2		4.88		3.031		2.362		0.077	
CXDCR 1280AP	07054			12.8	.5039		14.0		124		77		60		1.98
CXDCR 1283AP	07055			12.83	.5051		14.0		124		77		60		1.99
CXDCR 1290AP	07056			12.9	.5079		14.0		124		77		60		2.00
CXDCR 1300AP	07057			13.0	.5118		14.0		124		77		60		2.01
CXDCR5156AP	07058	33/64			.5156	9/16		4.88		3.031		2.362		0.080	
CXDCR5312AP	07059	17/32			.5312	9/16		4.88		3.031		2.362		0.082	
CXDCR 1350AP	07060			13.5	.5315		14.0		124		77		60		2.09
CXDCR 1370AP	07061			13.7	.5394		14.0		124		77		60		2.12
CXDCR5469AP	07062	35/64			.5469	9/16		4.88		3.031		2.362		0.085	
CXDCR 1400AP	07063			14.0	.5512		14.0		124		77		60		2.17
CXDCR5625AP	07064	9/16			.5625	9/16		5.24		3.268		2.480		0.087	
CXDCR 1450AP	07065			14.5	.5709		16.0		133		83		63		2.25
CXDCR 1470AP	07066			14.7	.5787		16.0		133		83		63		2.28
CXDCR 1500AP	07067			15.0	.5905		16.0		133		83		63		2.32
CXDCR5938AP	07068	19/32			.5938	5/8		5.24		3.268		2.480		0.092	
CXDCR 1530AP	07069			15.3	.6024		16.0		133		83		63		2.37
CXDCR 1550AP	07070			15.5	.6102		16.0		133		83		63		2.40
CXDCR 1570AP	07071			15.7	.6181		16.0		133		83		63		2.43
CXDCR6250AP	07072	5/8			.6250	5/8		5.24		3.268		2.480		0.097	
CXDCR 1600AP	07073			16.0	.6299		16.0		133		83		63		2.48
CXDCR 1608AP	07074			16.08	.6331		18.0		143		93		71		2.49
CXDCR 1630AP	07075			16.3	.6417		18.0		143		93		71		2.53
CXDCR 1650AP	07076			16.5	.6496		18.0		143		93		71		2.56
CXDCR6562AP	07077	21/32			.6562	11/16		5.63		3.661		2.795		0.102	
CXDCR 1700AP	07078			17.0	.6693		18.0		143		93		71		2.63
CXDCR6875AP	07079	11/16			.6875	11/16		5.63		3.661		2.795		0.107	



Series CXDCR Continued

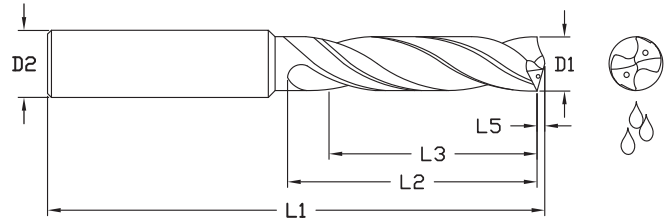
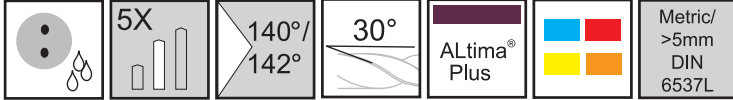

ALtima® Plus		Diameter				Shank		OAL		Flute Length		Drill Length		Point Length	
		D1 (m7)				D2 (h6)		L1		L2 (Max.)		L3 Ref.		L5	
Tool No.	EDP	Inch	Letter/ Wire	mm	Decimal	Inch	mm	Inch	mm	Inch	mm	Inch	mm	Inch	mm
CXDCR 1750AP	07080			17.5	.6890		18.0		143		93		71		2.71
CXDCR 1800AP	07081			18.0	.7087		18.0		143		93		71		2.79
CXDCR 1850AP	07082			18.5	.7283		20.0		153		101		77		2.87
CXDCR7500AP	07083	3/4			.7500	3/4	6.024		3.976		3.031		0.116		
CXDCR 1916AP	07084			19.16	.7543		20.0		153		101		77		2.97
CXDCR 1925AP	07085			19.25	.7579		20.0		153		101		77		2.98
CXDCR 1930AP	07086			19.3	.7598		20.0		153		101		77		2.99
CXDCR 1950AP	07087			19.5	.7677		20.0		153		101		77		3.02
CXDCR 2000AP	07088			20.0	.7874		20.0		153		101		77		3.10



Page 138



Made in USA

ISO 9001:2008 Certified



NEW

Cyclone Series CXDCL

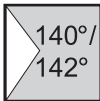
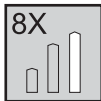

Designed for high performance drilling in a broad range of materials.

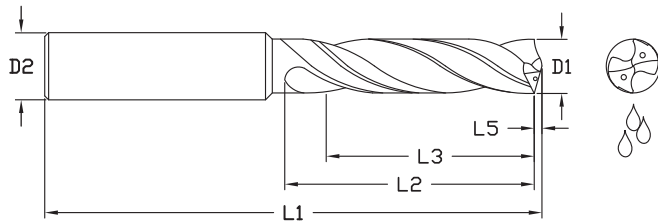

CXDCR / CXDCL

Cyclone XD

ALtima® Plus		Diameter				Shank D2 (h6)	OAL L1	Flute Length L2	Drill Length Ref. L3	Point Length L5
		D1 (m7)								
Tool No.	EDP	Inch	Letter/ Wire	mm	Decimal	mm	mm	mm	mm	mm
CXDCLM0300AP	07226			3.0	.1181	3	81	33	25	0.46
CXDCL1200AP	07227		#31	3.05	.1200	4	92	44	33	0.48
CXDCLM0310AP	07098			3.1	.1220	4	92	44	33	0.48
CXDCL1250AP	07099	1/8		3.18	.1250	4	92	44	33	0.48
CXDCLM0320AP	07100			3.2	.1260	4	92	44	33	0.50
CXDCLM0325AP	07101			3.25	.1280	4	92	44	33	0.51
CXDCL1285AP	07102		#30	3.26	.1285	4	92	44	33	0.51
CXDCLM0330AP	07103			3.3	.1299	4	92	44	33	0.51
CXDCLM0340AP	07104			3.4	.1339	4	92	44	33	0.53
CXDCL1360AP	07105		#29	3.45	.1360	4	92	44	33	0.53
CXDCLM0350AP	07106			3.5	.1378	4	92	44	33	0.54
CXDCL1406AP	07107	9/64		3.57	.1406	4	92	44	33	0.56
CXDCLM0360AP	07108			3.6	.1417	4	92	44	33	0.56
CXDCLM0370AP	07109			3.7	.1457	4	92	44	33	0.57
CXDCL1496AP	07110		#25	3.8	.1496	4	92	44	33	0.59
CXDCL1520AP	07111		#24	3.86	.1520	4	92	44	33	0.60
CXDCLM0390AP	07112			3.9	.1535	4	92	44	33	0.60
CXDCL1562AP	07113	5/32		3.97	.1562	4	92	44	33	0.61
CXDCLM0400AP	07114			4.0	.1575	4	92	44	33	0.62
CXDCL1590AP	07115		#21	4.04	.1590	5	100	45	34	0.63
CXDCLM0410AP	07116			4.1	.1614	5	100	45	34	0.64
CXDCLM0420AP	07117			4.2	.1654	5	100	45	34	0.65
CXDCLM0430AP	07118			4.3	.1693	5	100	45	34	0.67
CXDCL1719AP	07119	11/64		4.37	.1719	5	100	45	34	0.68
CXDCLM0440AP	07120			4.4	.1732	5	100	45	34	0.68
CXDCLM0450AP	07121			4.5	.1772	5	100	45	34	0.70
CXDCLM0460AP	07122			4.6	.1811	5	100	45	34	0.71
CXDCLM0465AP	07123			4.65	.1831	5	100	45	34	0.72
CXDCLM0470AP	07124			4.7	.1850	5	100	45	34	0.73
CXDCL1875AP	07125	3/16		4.76	.1875	5	100	45	34	0.74

Inch		
D1	Tolerance (m7)	
.0000 - .1181	+0.0008/+0.0047	
.1182 - .2362	+0.0016/+0.0063	
.2363 - .3937	+0.0024/+0.0083	
.3938 - .5000	+0.0027/+0.0098	

Inch		
D2	Tolerance (h6)	
.0000 - .1181	+0/-0.0024	
.1182 - .2362	+0/-0.0031	
.2363 - .3937	+0/-0.0035	
.3938 - .5000	+0/-0.0043	

Metric (mm)		
D1	Tolerance (m7)	
0 - 3.0	+0.02/+0.12	
3.01 - 6.0	+0.04/+0.16	
6.01 - 10.0	+0.06/+0.21	
10.01 - 12.7	+0.07/+0.25	

Metric (mm)		
D2	Tolerance (h6)	
0 - 3.0	+0/-0.006	
3.01 - 6.0	+0/-0.008	
6.01 - 10.0	+0/-0.009	
10.01 - 12.7	+0/-0.011	



Series CXDCL Continued

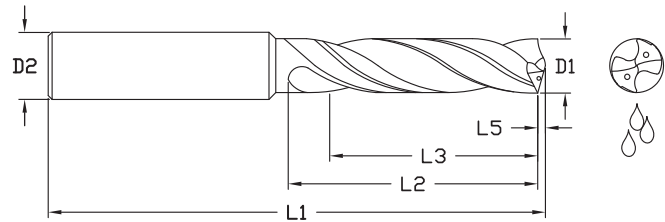
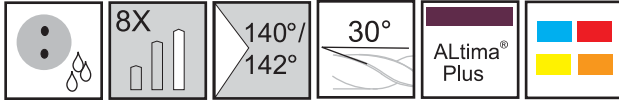

ALtima® Plus		Diameter				Shank	OAL	Flute Length	Drill Length Ref.	Point Length
		D1 (m7)				D2 (h6)	L1	L2	L3	L5
Tool No.	EDP	Inch	Letter/ Wire	mm	Decimal	mm	mm	mm	mm	mm
CXDCLM0480AP	07126			4.8	.1890	5	100	50	38	0.74
CXDCLM0490AP	07127			4.9	.1929	5	100	50	38	0.76
CXDCLM0500AP	07128			5.0	.1968	5	100	50	38	0.77
CXDCLM0510AP	07129			5.1	.2008	6	100	57	43	0.79
CXDCL2031AP	07130	13/64		5.16	.2031	6	100	57	43	0.79
CXDCLM0520AP	07131			5.2	.2047	6	100	57	43	0.81
CXDCLM0530AP	07132			5.3	.2087	6	100	57	43	0.82
CXDCLM0540AP	07133			5.4	.2126	6	100	57	43	0.84
CXDCLM0550AP	07134			5.5	.2165	6	100	57	43	0.85
CXDCL2187AP	07135	7/32		5.56	.2187	6	100	57	43	0.86
CXDCLM0560AP	07136			5.6	.2205	6	100	57	43	0.86
CXDCL2210AP	07137		#2	5.61	.2210	6	100	57	43	0.86
CXDCLM0570AP	07138			5.7	.2244	6	100	57	43	0.88
CXDCLM0580AP	07139			5.8	.2283	6	100	57	43	0.90
CXDCLM0590AP	07140			5.9	.2323	6	100	57	43	0.91
CXDCL2344AP	07141	15/64		5.95	.2344	6	100	57	43	0.91
CXDCLM0600AP	07142			6.0	.2362	6	100	57	43	0.93
CXDCLM0610AP	07143			6.1	.2402	8	118	76	57	0.95
CXDCL2420AP	07144		C	6.15	.2420	8	118	76	57	0.95
CXDCLM0620AP	07145			6.2	.2441	8	118	76	57	0.96
CXDCL2460AP	07146		D	6.25	.2460	8	118	76	57	.097
CXDCLM0630AP	07147			6.3	.2480	8	118	76	57	0.98
CXDCL2500AP	07148	1/4		6.35	.2500	8	118	76	57	0.99
CXDCLM0640AP	07149			6.4	.2520	8	118	76	57	0.99
CXDCLM0650AP	07150			6.5	.2559	8	118	76	57	1.01
CXDCL2570AP	07151		F	6.53	.2570	8	118	76	57	1.03
CXDCLM0660AP	07152			6.6	.2598	8	118	76	57	1.03
CXDCL2610AP	07153		G	6.63	.2610	8	118	76	57	1.03
CXDCLM0670AP	07154			6.7	.2638	8	118	76	57	1.04
CXDCL2656AP	07155	17/64		6.75	.2656	8	118	76	57	1.04
CXDCLM0680AP	07156			6.8	.2677	8	118	76	57	1.05
CXDCLM0690AP	07157			6.9	.2717	8	118	76	57	1.07
CXDCLM0700AP	07158			7.0	.2756	8	118	76	57	1.08
CXDCLM0710AP	07159			7.1	.2795	8	118	76	57	1.10
CXDCL2812AP	07160	9/32		7.14	.2812	8	118	76	57	1.12
CXDCLM0720AP	07161			7.2	.2835	8	118	76	57	1.12



Series CXDCL Continued

ALtima® Plus		Diameter				Shank D2 (h6)	OAL L1	Flute Length L2	Drill Length Ref. L3	Point Length L5
		D1 (m7)								
Tool No.	EDP	Inch	Letter/ Wire	mm	Decimal	mm	mm	mm	mm	
CXDCLM0730AP	07162			7.3	.2874	8	118	76	57	1.13
CXDCLM0740AP	07163			7.4	.2913	8	118	76	57	1.15
CXDCLM0750AP	07164			7.5	.2953	8	118	76	57	1.16
CXDCL2969AP	07165	19/64		7.54	.2969	8	118	76	57	1.17
CXDCLM0760AP	07166			7.6	.2992	8	118	76	57	1.18
CXDCLM0770AP	07167			7.7	.3031	8	118	76	57	1.19
CXDCLM0780AP	07168			7.8	.3071	8	118	76	57	1.21
CXDCLM0790AP	07169			7.9	.3110	8	118	76	57	1.22
CXDCL3125AP	07170	5/16		7.94	.3125	8	118	76	57	1.22
CXDCLM0800AP	07171			8.0	.3150	8	118	76	57	1.24
CXDCLM0810AP	07172			8.1	.3189	10	139	87	65	1.26
CXDCLM0820AP	07173			8.2	.3228	10	139	87	65	1.27
CXDCLM0830AP	07174			8.3	.3268	10	139	87	65	1.29
CXDCL3281AP	07175	21/64		8.33	.3281	10	139	87	65	1.30
CXDCLM0840AP	07176			8.4	.3307	10	139	87	65	1.31
CXDCL3320AP	07177		Q	8.43	.3320	10	139	87	65	1.31
CXDCLM0850AP	07178			8.5	.3346	10	139	87	65	1.32
CXDCLM0860AP	07179			8.6	.3386	10	139	87	65	1.33
CXDCLM0870AP	07180			8.7	.3425	10	139	87	65	1.35
CXDCL3438AP	07181	11/32		8.73	.3438	10	139	87	65	1.35
CXDCLM0880AP	07182			8.8	.3465	10	139	87	65	1.36
CXDCLM0890AP	07183			8.9	.3504	10	139	87	65	1.38
CXDCLM0900AP	07184			9.0	.3543	10	139	87	65	1.39
CXDCLM0910AP	07185			9.1	.3583	10	139	95	71	1.41
CXDCL3594AP	07186	23/64		9.13	.3594	10	139	95	71	1.42
CXDCLM0920AP	07187			9.2	.3622	10	139	95	71	1.43
CXDCLM0925AP	07188			9.25	.3642	10	139	95	71	1.43
CXDCLM0930AP	07189			9.3	.3661	10	139	95	71	1.44
CXDCL3680AP	07190		U	9.35	.3680	10	139	95	71	1.45
CXDCLM0940AP	07191			9.4	.3701	10	139	95	71	1.46
CXDCLM0950AP	07192			9.5	.3740	10	139	95	71	1.47
CXDCL3750AP	07193	3/8		9.52	.3750	10	139	95	71	1.47
CXDCLM0960AP	07194			9.6	.3780	10	139	95	71	1.49
CXDCLM0970AP	07195			9.7	.3819	10	139	95	71	1.50
CXDCL3858AP	07196		W	9.8	.3858	10	139	95	71	1.52
CXDCLM0990AP	07197			9.9	.3898	10	139	95	71	1.53
CXDCL3906AP	07198	25/64		9.92	.3906	10	139	95	71	1.55
CXDCLM1000AP	07199			10.0	.3937	10	139	95	71	1.55
CXDCLM1010AP	07200			10.1	.3976	12	155	106	80	1.56
CXDCLM1020AP	07201			10.2	.4016	12	155	106	80	1.58
CXDCLM1030AP	07202			10.3	.4055	12	155	106	80	1.60



Series CXDCL Continued

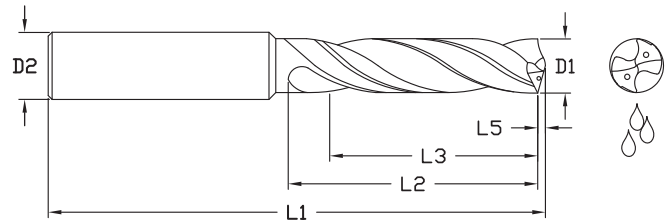
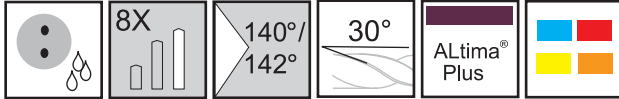

ALtima® Plus		Diameter				Shank	OAL	Flute Length	Drill Length Ref.	Point Length
		D1 (m7)				D2 (h6)	L1	L2	L3	L5
Tool No.	EDP	Inch	Letter/ Wire	mm	Decimal	mm	mm	mm	mm	mm
CXDCL4062AP	07203	13/32		10.32	.4062	12	155	106	80	1.60
CXDCLM1040AP	07204			10.4	.4094	12	155	106	80	1.61
CXDCLM1050AP	07205			10.5	.4134	12	155	106	80	1.63
CXDCLM1060AP	07206			10.6	.4173	12	155	106	80	1.64
CXDCLM1070AP	07207			10.7	.4213	12	155	106	80	1.66
CXDCL4219AP	07208	27/64		10.72	.4219	12	155	106	80	1.65
CXDCLM1080AP	07209			10.8	.4252	12	155	106	80	1.67
CXDCLM1090AP	07210			10.9	.4291	12	155	106	80	1.69
CXDCLM1100AP	07211			11.0	.4331	12	155	106	80	1.70
CXDCLM1110AP	07212			11.1	.4370	12	163	114	86	1.72
CXDCL4375AP	07213	7/16		11.11	.4375	12	163	114	86	1.73
CXDCLM1120AP	07214			11.2	.4409	12	163	114	86	1.74
CXDCLM1130AP	07215			11.3	.4449	12	163	114	86	1.75
CXDCLM1140AP	07216			11.4	.4488	12	163	114	86	1.77
CXDCLM1150AP	07217			11.5	.4527	12	163	114	86	1.78
CXDCLM1160AP	07218			11.6	.4567	12	163	114	86	1.80
CXDCLM1170AP	07219			11.7	.4606	12	163	114	86	1.81
CXDCLM1180AP	07220			11.8	.4646	12	163	114	86	1.83
CXDCLM1190AP	07221			11.9	.4685	12	163	114	86	1.84
CXDCL4688AP	07222	15/32		11.91	.4688	12	163	114	86	1.85
CXDCLM1200AP	07223			12.0	.4724	12	163	114	86	1.86
CXDCL4844AP	07224	31/64		12.3	.4844	14	182	133	100	1.91
CXDCL5000AP	07225	1/2		12.7	.5000	14	182	133	100	1.95



Safety Note

Always wear the appropriate personal protective equipment such as safety glasses and protective clothing when using solid carbide or HSS cutting tools. Machines should be fully guarded.

NEW

Cyclone Series CDACR

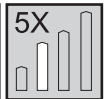

DIN 6537L

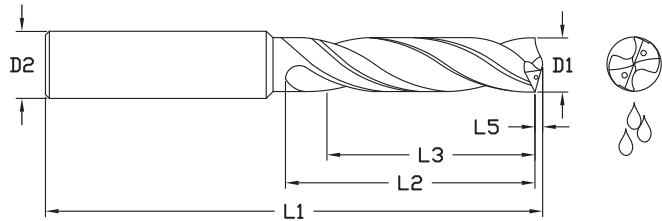

Features:

- 2 Flutes
- Lower Thrust Point Geometry
- Enhanced Double Margin Design
- Coolant Fed

Benefits:

- Reduced cutting forces allowing for heavier feed rates
- Improved performance in Non-Ferrous materials
- Back margin location allows for quicker engagement in hole
- Improved hole finishes
- Improved location when drilling through cross holes
- Higher heat resistance means higher speed and feed capabilities

CDA vs. CXD Style HP Drills:

The CDA provides a deeper flute depth than the CXD style drill for increased chip evacuation. Also, The CDA's point relief and edge protection is maximized for machining in non-ferrous materials.

CXDCL / CDACR
Cyclone XD / DA

Tool No.	EDP	Diameter				Shank	OAL		Flute Length		Relief Length		Point Length		Stock Status
		Inch	Letter/Wire	mm	Decimal	D2 (h6)	Inch	mm	Inch	mm	Inch	mm	Inch	mm	• Stocked
CDACRM0300	07300			3.00	.1181	6		66		28		23		0.46	•
CDACR1200	07301		#31		.1200	6	2.60	66	1.102		0.905	0.018			•
CDACRM0310	07302			3.10	.1220	6		66		28		23		0.48	•
CDACR1250	07303	1/8			.1250	6	2.60	66	1.102		0.905	0.019			•
CDACRM0320	07304			3.20	.1260	6		66		28		23		0.49	•
CDACR1285	07305		#30		.1285	6	2.60	66	1.102		0.905	0.020			•
CDACRM0330	07306			3.30	.1299	6		66		28		23		0.51	•
CDACRM0340	07307			3.40	.1339	6		66		28		23		0.52	•
CDACR1360	07308		#29		.1360	6	2.60	66	1.102		0.905	0.021			•
CDACRM0350	07309			3.50	.1378	6		66		28		23		0.54	•
CDACR1406	07310	9/64			.1406	6	2.60	66	1.102		0.905	0.022			•
CDACRM0360	07311			3.60	.1417	6		66		28		23		0.55	•
CDACR1440	07312		#27		.1440	6	2.60	66	1.102		0.905	0.022			•
CDACRM0370	07313			3.70	.1457	6		66		28		23		0.57	•
CDACR1470	07314		#26		.1470	6	2.60	66	1.102		0.905	0.023			•
CDACR1495	07315		#25		.1495	6	2.91	66	1.417		1.141	0.023			•
CDACRM0380	07316			3.80	.1496	6		74		36		29		0.58	•
CDACR1520	07317		#24		.1520	6	2.91	66	1.417		1.141	0.023			•
CDACRM0390	07318			3.90	.1535	6		74		36		29		0.60	•
CDACR1562	07319	5/32			.1562	6	2.91	66	1.417		1.141	0.024			•
CDACRM0400	07320			4.00	.1575	6		74		36		29		0.61	•
CDACR1590	07321		#21		.1590	6	2.91	66	1.417		1.141	0.024			•
CDACR1610	07322		#20		.1610	6	2.91	66	1.417		1.141	0.025			•
CDACRM0410	07323			4.10	.1614	6		74		36		29		0.63	•
CDACRM0420	07324			4.20	.1654	6		74		36		29		0.64	•
CDACR1660	07325		#19		.1660	6	2.91	66	1.417		1.141	0.025			•
CDACRM0430	07326			4.30	.1693	6		74		36		29		0.66	•
CDACR1719	07327	11/64			.1719	6	2.91	66	1.417		1.141	0.026			•

Inch		
D1	Tolerance (m7)	
.0000 - .1181	+0.0008/+0.0047	
.1182 - .2362	+0.0016/+0.0063	
.2363 - .3937	+0.0024/+0.0083	
.3938 - .5000	+0.0027/+0.0098	

Inch		
D2	Tolerance (h6)	
.0000 - .1181	+0/-0.0024	
.1182 - .2362	+0/-0.0031	
.2363 - .3937	+0/-0.0035	
.3938 - .5000	+0/-0.0043	

Metric (mm)		
D1	Tolerance (m7)	
0 - 3.0	+0.02/+0.12	
3.01 - 6.0	+0.04/+0.16	
6.01 - 10.0	+0.06/+0.21	
10.01 - 12.7	+0.07/+0.25	

Metric (mm)		
D2	Tolerance (h6)	
0 - 3.0	+0/-0.006	
3.01 - 6.0	+0/-0.008	
6.01 - 10.0	+0/-0.009	
10.01 - 12.7	+0/-0.011	



Series CDACR Continued

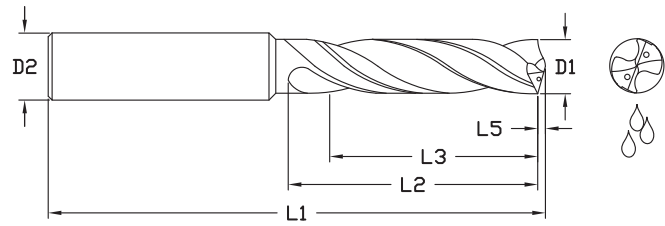
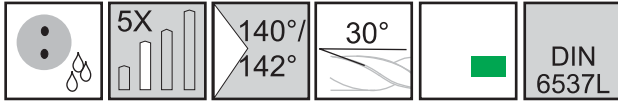

Tool No.	EDP	Diameter				Shank	OAL	Flute Length		Relief Length	Point Length		Stock Status		
		D1 (m7)				D2 (h6)	L1	L2 (max)		L3 (Ref)	L5		• Stocked		
		Inch	Letter/ Wire	mm	Decimal	mm	Inch	mm	Inch	mm	Inch	mm	Inch	mm	o Non-Stocked
CDACR1730	07328		#17		.1730	6	2.91		1.417		1.141		0.027		•
CDACRM0440	07329			4.40	.1732	6		74		36		29		0.67	•
CDACR1770	07330		#16		.1770	6	2.91		1.417		1.141		0.027		•
CDACRM0450	07331			4.50	.1772	6		74		36		29		0.69	•
CDACRM0460	07332			4.60	.1811	6		74		36		29		0.71	•
CDACRM0470	07333			4.70	.1850	6		74		36		29		0.72	•
CDACR1875	07334	3/16			.1875	6	3.23		1.732		1.378		0.029		•
CDACRM0480	07335			4.80	.1890	6		82		44		35		0.74	•
CDACR1910	07337		#11		.1910	6	3.23		1.732		1.378		0.029		•
CDACRM0490	07338			4.90	.1929	6		82		44		35		0.75	•
CDACR1935	07339		#10		.1935	6	3.23		1.732		1.378		0.030		•
CDACRM0500	07340			5.00	.1968	6		82		44		35		0.77	•
CDACRM0510	07341			5.10	.2008	6		82		44		35		0.78	•
CDACR2031	07342	13/64			.2031	6	3.23		1.732		1.378		0.031		•
CDACRM0520	07343			5.20	.2047	6		82		44		35		0.80	•
CDACRM0530	07344			5.30	.2087	6		82		44		35		0.81	•
CDACRM0540	07345			5.40	.2126	6		82		44		35		0.83	•
CDACRM0550	07346			5.50	.2165	6		82		44		35		0.84	•
CDACR2187	07347	7/32			.2187	6	3.23		1.732		1.378		0.034		•
CDACRM0560	07348			5.60	.2205	6		82		44		35		0.86	•
CDACRM0570	07349			5.70	.2244	6		82		44		35		0.87	•
CDACRM0580	07350			5.80	.2283	6		82		44		35		0.89	•
CDACRM0590	07351			5.90	.2323	6		82		44		35		0.90	•
CDACR2340	07352		A		.2340	6	3.23		1.732		1.378		0.036		•
CDACRM0600	07353			6.00	.2362	6		82		44		35		0.92	•
CDACRM0610	07354			6.10	.2402	8		91		53		43		0.94	•
CDACRM0620	07355			6.20	.2441	8		91		53		43		0.95	•
CDACRM0630	07356			6.30	.2480	8		91		53		43		0.97	•
CDACR2500	07357	1/4			.2500	8	3.58		2.087		1.693		0.038		•
CDACRM0640	07358			6.40	.2520	8		91		53		43		0.98	•
CDACRM0650	07359			6.50	.2559	8		91		53		43		1.00	•
CDACR2570	07360		F		.2570	8	3.58		2.087		1.693		0.039		•
CDACRM0660	07406			6.60	.2598	8		91		53		43		1.01	o
CDACRM0670	07361			6.70	.2638	8		91		53		43		1.03	•
CDACR2656	07362	17/64			.2656	8	3.58		2.087		1.693		0.041		•
CDACRM0680	07363			6.80	.2677	8		91		53		43		1.04	•
CDACRM0690	07364			6.90	.2717	8		91		53		43		1.06	•
CDACR2720	07365		I		.2720	8	3.58		2.087		1.693		0.042		•
CDACRM0700	07366			7.00	.2756	8		91		53		43		1.07	•
CDACRM0710	07407			7.10	.2795	8		91		53		43		1.09	o
CDACR2812	07367	9/32			.2812	8	3.58		2.087		1.693		0.043		•
CDACRM0720	07368			7.20	.2835	8		91		53		43		1.10	•
CDACRM0730	07369			7.30	.2874	8		91		53		43		1.12	•
CDACRM0740	07370			7.40	.2913	8		91		53		43		1.13	•
CDACRM0750	07371			7.50	.2953	8		91		53		43		1.15	•
CDACR2969	07372	19/64			.2969	8	3.58		2.087		1.693		0.046		•
CDACRM0760	07408			7.60	.2992	8		91		53		43		1.17	o
CDACRM0770	07409			7.70	.3031	8		91		53		43		1.18	o
CDACRM0780	07373			7.80	.3071	8		91		53		43		1.20	•
CDACRM0790	07410			7.90	.3110	8		91		53		43		1.21	o



Series CDACR Continued

Tool No.	EDP	Diameter				Shank	OAL		Flute Length		Relief Length		Point Length		Stock Status
		Inch	Letter/ Wire	D1 (m7)		D2 (h6)	L1		L2 (max)		L3 (Ref)		L5		• Stocked
				mm	Decimal	mm	Inch	mm	Inch	mm	Inch	mm	Inch	mm	○ Non-Stocked
CDACR3125	07374	5/16		8.00	.3125	8	3.58	91	2.087	53	1.693	43	0.048	1.23	•
CDACRM0800	07375			8.10	.3150	8		103		61		49		1.24	•
CDACRM0810	07376			8.20	.3189	10		103		61		49		1.26	•
CDACRM0820	07405			8.30	.3228	10		103		61		49		1.27	•
CDACRM0830	07411			8.40	.3268	10		103		61		49		1.27	○
CDACR3281	07377	21/64		8.40	.3281	10	4.06	2.402		1.929		0.050			•
CDACRM0840	07378			8.40	.3307	10		103		61		49		1.29	•
CDACR3320	07379		Q	8.50	.3320	10	4.06	2.402		1.929		0.051			•
CDACRM0850	07380			8.50	.3346	10		103		61		49		1.30	•
CDACRM0860	07412			8.60	.3386	10		103		61		49		1.32	○
CDACRM0870	07413			8.70	.3425	10		103		61		49		1.33	○
CDACR3438	07381	11/32		8.80	.3438	10	4.06	2.402		1.929		0.053			•
CDACRM0880	07414			8.80	.3465	10		103		61		49		1.35	○
CDACRM0890	07415			8.90	.3504	10		103		61		49		1.36	○
CDACRM0900	07382			9.00	.3543	10		103		61		49		1.38	•
CDACRM0910	07416			9.10	.3583	10		103		61		49		1.40	○
CDACR3594	07383	23/64		9.20	.3594	10	4.06	2.402		1.929		0.055			•
CDACRM0920	07417			9.20	.3622	10		103		61		49		1.41	○
CDACRM0930	07418			9.30	.3661	10		103		61		49		1.43	○
CDACR3680	07384		U	9.40	.3680	10	4.06	2.402		1.929		0.056			•
CDACRM0940	07419			9.40	.3701	10		103		61		49		1.44	○
CDACRM0950	07385			9.50	.3740	10		103		61		49		1.46	•
CDACR3750	07386	3/8		9.60	.3750	10	4.06	2.402		1.929		0.057			•
CDACRM0960	07420			9.60	.3780	10		103		61		49		1.47	○
CDACRM0970	07387			9.70	.3819	10		103		61		49		1.49	•
CDACRM0980	07421			9.80	.3858	10		103		61		49		1.50	○
CDACRM0990	07422			9.90	.3898	10		103		61		49		1.52	○
CDACR3906	07388	25/64		10.00	.3906	10	4.06	2.402		1.929		0.060			•
CDACRM1000	07389			10.00	.3937	10		103		61		49		1.53	•
CDACRM1010	07423			10.10	.3976	12		118		71		56		1.55	○
CDACRM1020	07390			10.20	.4016	12		118		71		56		1.56	•
CDACRM1030	07424			10.30	.4055	12		118		71		56		1.58	○
CDACR4062	07391	13/32		10.40	.4062	12	4.65	2.795		2.205		0.062			•
CDACRM1040	07392			10.40	.4094	12		118		71		56		1.59	•
CDACRM1050	07393			10.50	.4134	12		118		71		56		1.61	•
CDACRM1060	07394			10.60	.4173	12		118		71		56		1.63	•
CDACRM1070	07425			10.70	.4213	12		118		71		56		1.64	○
CDACR4219	07395	27/64		10.80	.4219	12	4.65	2.795		2.205		0.065			•
CDACRM1080	07426			10.80	.4252	12		118		71		56		1.66	○
CDACRM1090	07427			10.90	.4291	12		118		71		56		1.67	○
CDACRM1100	07396			11.00	.4331	12		118		71		56		1.69	•
CDACRM1110	07428			11.10	.4370	12		118		71		56		1.70	○
CDACR4375	07397	7/16		11.20	.4375	12	4.65	2.795		2.205		0.067			•
CDACRM1120	07429			11.20	.4409	12		118		71		56		1.72	○
CDACRM1130	07430			11.30	.4449	12		118		71		56		1.73	○
CDACRM1140	07431			11.40	.4488	12		118		71		56		1.75	○
CDACRM1150	07398			11.50	.4528	12		118		71		56		1.76	•
CDACR4531	07399	29/64		11.60	.4531	12	4.65	2.795		2.205		0.069			•
CDACRM1160	07432			11.60	.4567	12		118		71		56		1.78	○
CDACRM1170	07433			11.70	.4606	12		118		71		56		1.79	○
CDACRM1180	07434			11.80	.4646	12		118		71		56		1.81	○
CDACRM1190	07435			11.90	.4685	12		118		71		56		1.82	○
CDACR4688	07400	15/32		12.00	.4688	12	4.65	2.795		2.205		0.072			•
CDACRM1200	07401			12.00	.4724	12		118		71		56		1.84	•
CDACR4844	07402	31/64		12.50	.4844	14	4.88	3.031		2.362		0.074			•
CDACRM1250	07403			12.50	.4921	14		124		77		60		1.92	•
CDACR5000	07404	1/2		14	.5000	14	4.88	3.031		2.362		0.077			•

CDACR
Cyclone DA



Twister[®] XD

Xtreme High Performance Drilling

Features

- Advanced “Active Cut” Geometric Design
- Redefined Critical Cut Zone Characteristics
- High Efficiency Flute Profile
- “State-of-the-Art” Proprietary Coating
- Stable Low-Thrust Point Form
- Coolant-Fed or Solid
- Diameter Range - .5mm to 20.0mm, 1/64” to 3/4”
- Stub (3X), Regular (5X), Long (7X+) and Extra Long (12X-25X)
- Engineered and Produced in the USA

Benefits

- Extended Tool Life
- Elevated Metal Removal Rates (MRR)
- Lower Cost Per Hole
- Improved Hole/Part Quality
- Increased Tool Reliability
- Factory Trained Network of Application & Technical Specialists
- Factory Reconditioning Service
- Ideal Platform for Modification or an Engineered “Special” Tool
- Compatibility to a Wide Range of Standard Toolholder Systems



All HP Drill shanks are manufactured to h6 nominal diameters for heat shrink shank applications.

For HP Drill Selection Chart, See Page 135.

ISO 9001:2008 Certified

Twister XD® Series 2XDSS

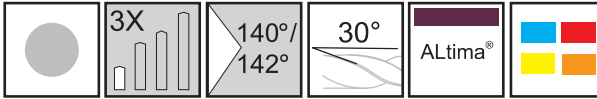

Designed for high performance drilling in a broad range of materials.

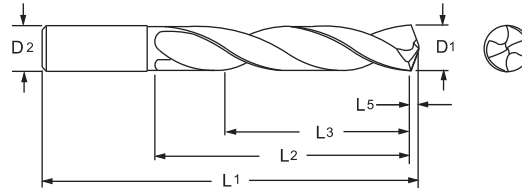

ALtima®		Diameter				Shank		OAL		Flute Length		Drill Length		Point Length	
Tool No.	EDP	D1 (h7)				D2 (h6)		L1		L2 (Max.)		L3 Ref.		L5	
		Inch	Letter/ Wire	mm	Decimal	Inch	mm	Inch	mm	Inch	mm	Inch	mm	Inch	mm
2XDSS0984A	22601			2.5	.0984		2.5		43		14		11		0.39
2XDSS1142A	22602			2.9	.1142		2.9		46		16		12		0.45
2XDSS1181A	02100			3.0	.1181		3.0		57		16		13		0.46
2XDSS1200A	02102		31		.1200	1/8		2.25		0.750		0.60		0.019	
2XDSS1220A	02103			3.1	.1220		4.0		63		22		18		0.48
2XDSS1250A	02104	1/8			.1250	1/8		2.25		0.750		0.60		0.019	
2XDSS1260A	02106			3.2	.1260		4.0		63		22		18		0.50
2XDSS1285A	02108		30		.1285	5/32		2.5		0.875		0.70		0.020	
2XDSS1299A	02110			3.3	.1299		4.0		63		22		18		0.51
2XDSS1339A	02112			3.4	.1339		4.0		63		22		18		0.53
2XDSS1360A	02114		29		.1360	5/32		2.5		0.875		0.70		0.021	
2XDSS1378A	02116			3.5	.1378		4.0		63		22		18		0.54
2XDSS1406A	02118	9/64			.1406	5/32		2.5		0.875		0.70		0.022	
2XDSS1417A	02119			3.6	.1417		4.0		63		22		18		0.56
2XDSS1457A	02120			3.7	.1457		4.0		63		22		18		0.57
2XDSS1496A	02122			3.8	.1496		4.0		63		22		18		0.59
2XDSS1520A	02121		24		.1520	5/32		2.5		0.875		0.70		0.024	
2XDSS1535A	02123			3.9	.1535		4.0		63		22		18		0.60
2XDSS1562A	02124	5/32			.1562	5/32		2.5		0.875		0.70		0.024	
2XDSS1575A	02126			4.0	.1575		4.0		63		22		18		0.62
2XDSS1590A	02127		21		.1590	3/16		2.5		1.000		0.80		0.025	
2XDSS1614A	04000			4.1	.1614		5.0		63		26		21		0.64
2XDSS1654A	02128			4.2	.1654		5.0		63		26		21		0.65
2XDSS1693A	02129			4.3	.1693		5.0		63		26		21		0.67

Inch		
D1	Tolerance (h7)	
.0000 - .1181	+0/- .00039	
.1182 - .2362	+0/- .00047	
.2363 - .3937	+0/- .00059	
.3938 - .7087	+0/- .00071	
.7088 - .7500	+0/- .00083	

Inch		
D2	Tolerance (h6)	
.0000 - .1181	+0/- .00024	
.1182 - .2362	+0/- .00031	
.2363 - .3937	+0/- .00035	
.3938 - .7087	+0/- .00043	
.7088 - .7500	+0/- .00051	

Metric (mm)		
D1	Tolerance (h7)	
0 - 3.0	+0/- .010	
3.01 - 6.0	+0/- .012	
6.01 - 10.0	+0/- .015	
10.01 - 18.0	+0/- .018	
18.01 - 20.0	+0/- .021	

Metric (mm)		
D2	Tolerance (h6)	
0 - 3.0	+0/- .006	
3.01 - 6.0	+0/- .008	
6.01 - 10.0	+0/- .009	
10.01 - 18.0	+0/- .011	
18.01 - 20.0	+0/- .013	



Series 2XDSS Continued

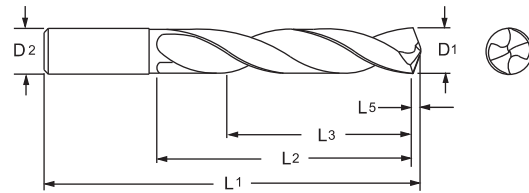
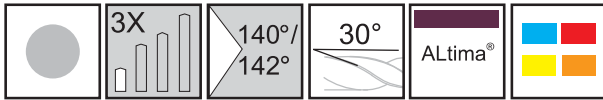

ALtima®		Diameter				Shank		OAL		Flute Length		Drill Length		Point Length	
		D1 (h7)				D2 (h6)		L1		L2 (Max.)		L3 Ref.		L5	
Tool No.	EDP	Inch	Letter/ Wire	mm	Decimal	Inch	mm	Inch	mm	Inch	mm	Inch	mm	Inch	mm
2XDSS1719A	02130	11/64			.1719	3/16		2.50		1.000		0.80		0.027	
2XDSS1732A	02131			4.4	.1732		5.0		63		26		21		0.68
2XDSS1772A	02132			4.5	.1772		5.0		63		26		21		0.70
2XDSS1811A	02134			4.6	.1811		5.0		63		26		21		0.71
2XDSS1850A	02135			4.7	.1850		5.0		63		26		21		0.73
2XDSS1875A	02136	3/16			.1875	3/16		2.50		1.000		0.80		0.029	
2XDSS1890A	02138			4.8	.1890		5.0		63		26		21		0.74
2XDSS1929A	02140			4.9	.1929		5.0		63		26		21		0.76
2XDSS1968A	02142			5.0	.1968		5.0		63		26		21		0.77
2XDSS2008A	02144			5.1	.2008		6.0		76		30		24		0.79
2XDSS2031A	02146	13/64			.2031	15/64		3.00		1.125		0.90		0.031	
2XDSS2047A	02148			5.2	.2047		6.0		76		30		24		0.81
2XDSS2087A	02150			5.3	.2087		6.0		76		30		24		0.82
2XDSS2126A	02152			5.4	.2126		6.0		76		30		24		0.84
2XDSS2165A	02154			5.5	.2165		6.0		76		30		24		0.85
2XDSS2187A	02156	7/32			.2187	15/64		3.00		1.125		0.90		0.034	
2XDSS2210A	02158		2		.2210	15/64		3.00		1.125		0.90		0.034	
2XDSS2244A	02160			5.7	.2244		6.0		76		30		24		0.88
2XDSS2283A	02162			5.8	.2283		6.0		76		30		24		0.90
2XDSS2323A	02164			5.9	.2323		6.0		76		30		24		0.91
2XDSS2344A	02166	15/64			.2344	15/64		3.00		1.125		0.90		0.036	
2XDSS2362A	02168			6.0	.2362		6.0		76		30		24		0.93
2XDSS2402A	02170			6.1	.2402		8.0		82		35		28		0.95
2XDSS2420A	02172		C		.2420	1/4		3.00		1.250		1.00		0.037	
2XDSS2441A	02174			6.2	.2441		8.0		82		35		28		0.96
2XDSS2460A	02176		D		.2460	1/4		3.00		1.250		1.00		0.038	
2XDSS2480A	02178			6.3	.2480		8.0		82		35		28		0.98
2XDSS2500A	02180	1/4			.2500	1/4		3.00		1.250		1.00		0.039	
2XDSS2520A	02182			6.4	.2520		8.0		82		35		28		0.99
2XDSS2559A	02184			6.5	.2559		8.0		82		35		28		1.01
2XDSS2570A	02186		F		.2570	5/16		3.25		1.375		1.10		0.040	
2XDSS2598A	02185			6.6	.2598		8.0		82		35		28		1.03
2XDSS2610A	02188		G		.2610	5/16		3.25		1.375		1.10		0.040	
2XDSS2638A	02189			6.7	.2638		8.0		82		35		28		1.04
2XDSS2656A	02190	17/64			.2656	5/16		3.25		1.375		1.10		0.041	
2XDSS2677A	02192			6.8	.2677		8.0		82		35		28		1.05
2XDSS2717A	02194			6.9	.2717		8.0		82		35		28		1.07



Series 2XDSS Continued

Altima®		Diameter				Shank		OAL		Flute Length		Drill Length		Point Length	
		D1 (h7)				D2 (h6)		L1		L2 (Max.)		L3 Ref.		L5	
Tool No.	EDP	Inch	Letter/ Wire	mm	Decimal	Inch	mm	Inch	mm	Inch	mm	Inch	mm	Inch	mm
2XDSS2756A	02196			7.0	.2756		8.0		82		35		28		1.08
2XDSS2795A	02197			7.1	.2795		8.0		82		38		31		1.10
2XDSS2812A	02198	9/32			.2812	5/16		3.25		1.500		1.20		0.044	
2XDSS2835A	02200			7.2	.2835		8.0		82		38		31		1.12
2XDSS2874A	02201			7.3	.2874		8.0		82		38		31		1.13
2XDSS2913A	02202			7.4	.2913		8.0		82		38		31		1.15
2XDSS2953A	02204			7.5	.2953		8.0		82		38		31		1.16
2XDSS2969A	02206	19/64			.2969	5/16		3.25		1.500		1.20		0.046	
2XDSS2992A	02208			7.6	.2992		8.0		82		38		31		1.18
2XDSS3031A	02210			7.7	.3031		8.0		82		38		31		1.19
2XDSS3071A	02212			7.8	.3071		8.0		82		38		31		1.21
2XDSS3110A	02213			7.9	.3110		8.0		82		38		31		1.22
2XDSS3125A	02214	5/16			.3125	5/16		3.25		1.500		1.20		0.048	
2XDSS3150A	02216			8.0	.3150		8.0		82		38		31		1.24
2XDSS3189A	02218			8.1	.3189		10.0		89		43		35		1.26
2XDSS3228A	02220			8.2	.3228		10.0		89		43		35		1.27
2XDSS3268A	02222			8.3	.3268		10.0		89		43		35		1.29
2XDSS3281A	02224	21/64			.3281	25/64		3.50		1.687		1.35		0.051	
2XDSS3307A	02223			8.4	.3307		10.0		89		43		35		1.31
2XDSS3320A	02225		Q		.3320	25/64		3.50		1.687		1.35		0.051	
2XDSS3346A	02226			8.5	.3346		10.0		89		43		35		1.32
2XDSS3386A	02227			8.6	.3386		10.0		89		43		35		1.33
2XDSS3425A	04001			8.7	.3425		10.0		89		43		35		1.35
2XDSS3438A	02228	11/32			.3438	25/64		3.50		1.687		1.35		0.053	
2XDSS3465A	02230			8.8	.3465		10.0		89		43		35		1.36
2XDSS3504A	02232			8.9	.3504		10.0		89		43		35		1.38
2XDSS3543A	02234			9.0	.3543		10.0		89		43		35		1.39
2XDSS3583A	02235			9.1	.3583		10.0		89		43		35		1.41
2XDSS3594A	02236	23/64			.3594	25/64		3.50		1.687		1.35		0.056	
2XDSS3622A	02238			9.2	.3622		10.0		89		43		35		1.43
2XDSS3642A	02240			9.25	.3642		10.0		89		43		35		1.43
2XDSS3661A	02242			9.3	.3661		10.0		89		43		35		1.44
2XDSS3701A	02243			9.4	.3701		10.0		89		43		35		1.46
2XDSS3740A	02244			9.5	.3740		10.0		89		43		35		1.47
2XDSS3750A	02246	3/8			.3750	25/64		3.50		1.687		1.35		0.058	
2XDSS3780A	02247			9.6	.3780		10.0		89		43		35		1.49
2XDSS3819A	02248			9.7	.3819		10.0		89		43		35		1.50
2XDSS3858A	02250			9.8	.3858		10.0		89		43		35		1.52
2XDSS3898A	02251			9.9	.3898		10.0		89		43		35		1.53
2XDSS3906A	02252	25/64			.3906	25/64		3.50		1.687		1.35		0.061	
2XDSS3937A	02254			10.0	.3937		10.0		89		43		35		1.55
2XDSS3976A	02255			10.1	.3976		12.0		101		51		41		1.56



Series 2XDSS Continued

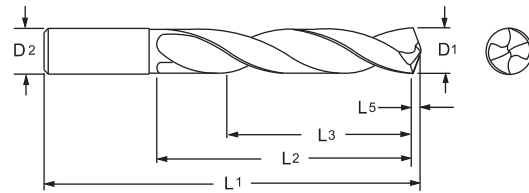
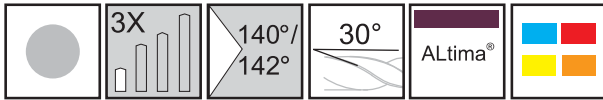

ALtima®		Diameter				Shank		OAL		Flute Length		Drill Length		Point Length	
		D1 (h7)				D2 (h6)		L1		L2 (Max.)		L3 Ref.		L5	
Tool No.	EDP	Inch	Letter/ Wire	mm	Decimal	Inch	mm	Inch	mm	Inch	mm	Inch	mm	Inch	mm
2XDSS4016A	02256			10.2	.4016		12.0		101		51		41		1.58
2XDSS4055A	02257			10.3	.4055		12.0		101		51		41		1.60
2XDSS4062A	02258	13/32			.4062	15/32		4.00		2.000		1.60		0.063	
2XDSS4094A	02259			10.4	.4094		12.0		101		51		41		1.61
2XDSS4134A	02260			10.5	.4134		12.0		101		51		41		1.63
2XDSS4173A	02261			10.6	.4173		12.0		101		51		41		1.64
2XDSS4213A	04002			10.7	.4213		12.0		101		51		41		1.66
2XDSS4219A	02262	27/64			.4219	15/32		4.00		2.00		1.60		0.065	
2XDSS4252A	02263			10.8	.4252		12.0		101		51		41		1.67
2XDSS4291A	04003			10.9	.4291		12.0		101		51		41		1.69
2XDSS4331A	02264			11.0	.4331		12.0		101		51		41		1.70
2XDSS4370A	02265			11.1	.4370		12.0		101		51		41		1.72
2XDSS4375A	02266	7/16			.4375	15/32		4.00		2.00		1.60		0.068	
2XDSS4409A	02268			11.2	.4409		12.0		101		51		41		1.74
2XDSS4449A	02269			11.3	.4449		12.0		101		51		41		1.75
2XDSS4488A	04004			11.4	.4488		12.0		101		51		41		1.77
2XDSS4527A	02270			11.5	.4527		12.0		101		51		41		1.78
2XDSS4567A	02271			11.6	.4567		12.0		101		51		41		1.80
2XDSS4606A	02272			11.7	.4606		12.0		101		51		41		1.81
2XDSS4646A	02273			11.8	.4646		12.0		101		51		41		1.83
2XDSS4685A	04005			11.9	.4685		12.0		101		51		41		1.84
2XDSS4688A	02274	15/32			.4688	15/32		4.00		2.00		1.60		0.073	
2XDSS4724A	02276			12.0	.4724		12.0		101		51		41		1.86
2XDSS4764A	02278			12.1	.4764		14.0		107		54		43		1.87
2XDSS4844A	02280	31/64			.4844	1/2		4.00		2.00		1.60		0.075	
2XDSS4921A	02282			12.5	.4921		14.0		107		54		43		1.94
2XDSS5000A	02284	1/2			.5000	1/2		4.00		2.00		1.60		0.077	
2XDSS5039A	02286			12.8	.5039		14.0		107		54		43		1.98
2XDSS5051A	02285			12.83	.5051		14.0		107		54		43		1.99
2XDSS5079A	02287			12.9	.5079		14.0		107		54		43		2.00
2XDSS5118A	02288			13.0	.5118		14.0		107		54		43		2.01
2XDSS5156A	02290	33/64			.5156	35/64		4.25		2.125		1.70		0.080	
2XDSS5312A	02291	17/32			.5312	35/64		4.25		2.125		1.70		0.082	
2XDSS5315A	02292			13.5	.5315		14.0		107		54		43		2.09
2XDSS5394A	02294			13.7	.5394		14.0		107		54		43		2.12
2XDSS5469A	02296	35/64			.5469	35/64		4.25		2.125		1.70		0.085	
2XDSS5512A	02298			14.0	.5512		14.0		107		54		43		2.17



Series 2XDSS Continued

ALtima®		Diameter				Shank		OAL		Flute Length		Drill Length		Point Length	
		D1 (h7)				D2 (h6)		L1		L2 (Max.)		L3 Ref.		L5	
Tool No.	EDP	Inch	Letter/ Wire	mm	Decimal	Inch	mm	Inch	mm	Inch	mm	Inch	mm	Inch	mm
2XDSS5625A	02300	9/16			.5625	5/8		4.625		2.375		1.90		0.087	
2XDSS5709A	02302			14.5	.5709		16.0		117		60		48		2.25
2XDSS5787A	02304			14.7	.5787		16.0		117		60		48		2.28
2XDSS5905A	02306			15.0	.5905		16.0		117		60		48		2.32
2XDSS5938A	02308	19/32			.5938	5/8		4.625		2.375		1.90		0.092	
2XDSS6024A	02309			15.3	.6024		16.0		117		60		48		2.37
2XDSS6102A	02310			15.5	.6102		16.0		117		60		48		2.40
2XDSS6181A	02312			15.7	.6181		16.0		117		60		48		2.43
2XDSS6250A	02314	5/8			.6250	5/8		4.625		2.375		1.90		0.097	
2XDSS6299A	02316			16.0	.6299		16.0		117		60		48		2.48
2XDSS6331A	02318			16.08	.6331		18.0		122		63		51		2.49
2XDSS6417A	02319			16.3	.6417		18.0		122		63		51		2.53
2XDSS6496A	02320			16.5	.6496		18.0		122		63		51		2.56
2XDSS6562A	02322	21/32			.6562	45/64		4.81		2.500		2.00		0.102	
2XDSS6693A	02324			17.0	.6693		18.0		122		63		51		2.63
2XDSS6875A	02326	11/16			.6875	45/64		4.81		2.500		2.00		0.107	
2XDSS6890A	02328			17.5	.6890		18.0		122		63		51		2.71
2XDSS7087A	02330			18.0	.7087		18.0		122		63		51		2.79
2XDSS7283A	02332			18.5	.7283		20.0		133		70		56		2.87
2XDSS7500A	02334	3/4			.7500	3/4		5.25		2.750		2.20		0.116	
2XDSS7543A	02336			19.16	.7543		20.0		133		70		56		2.97
2XDSS7579A	02338			19.25	.7579		20.0		133		70		56		2.98
2XDSS7598A	02340			19.3	.7598		20.0		133		70		56		2.99
2XDSS7677A	02342			19.5	.7677		20.0		133		70		56		3.02
2XDSS7874A	02344			20.0	.7874		20.0		133		70		56		3.10

2XDSS
TwisterXD®



Page 144



For product information, call your local distributor.

Twister XD® Series 2XDSR

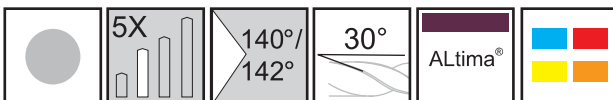

Designed for high performance drilling in a broad range of materials.

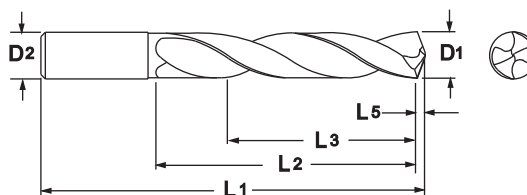

ALtima®		Diameter				Shank		OAL		Flute Length		Drill Length		Point Length	
		D1 (h7)				D2 (h6)		L1		L2 (Max.)		L3 Ref.		L5	
Tool No.	EDP	Inch	Letter/ Wire	mm	Decimal	Inch	mm	Inch	mm	Inch	mm	Inch	mm	Inch	mm
2XDSR0156A	22201	1/64			.0156	1/64		1.50		0.187		0.14		0.002	
2XDSR0197A	28001			0.5	.0197		0.50		26		6		5		0.08
2XDSR0236A	28006			0.6	.0236		0.60		26		7		5		0.09
2XDSR0256A	28011			0.65	.0256		0.65		26		8		6		0.10
2XDSR0312A	22221	1/32			.0312	1/32		1.50		0.375		0.281		0.005	
2XDSR0374A	28016			0.95	.0374		0.95		32		11		8		0.15
2XDSR0394A	28021			1.0	.0394		1.00		34		12		9		0.16
2XDSR0413A	28026			1.05	.0413		1.05		34		12		9		0.16
2XDSR0469A	22241	3/64			.0469	3/64		1.50		0.750		0.562		0.007	
2XDSR0492A	28031			1.25	.0492		1.25		38		16		12		0.19
2XDSR0590A	28036			1.5	.0590		1.50		40		18		14		0.23
2XDSR0625A	22256	1/16			.0625	1/16		1.50		0.750		0.562		0.010	
2XDSR0630A	28041			1.6	.0630		1.60		43		20		15		0.25
2XDSR0708A	28046			1.8	.0708		1.80		46		22		17		0.28
2XDSR0748A	28051			1.9	.0748		1.90		46		22		17		0.29
2XDSR0781A	22276	5/64			.0781	5/64		1.75		0.875		0.656		0.012	
2XDSR0787A	28056			2.0	.0787		2.00		49		24		18		0.31
2XDSR0807A	28058			2.05	.0807		2.05		49		24		18		0.32
2XDSR0906A	28061			2.3	.0906		2.30		53		27		20		0.36
2XDSR0938A	22291	3/32			.0938	3/32		2.00		1.000		0.75		0.015	
2XDSR0945A	28066			2.4	.0945		2.40		57		30		23		0.37
2XDSR0984A	28071			2.5	.0984		2.50		57		30		23		0.39
2XDSR1094A	22306	7/64			.1094	7/64		2.25		1.250		0.937		0.017	
2XDSR1142A	28073			2.9	.1142		2.90		61		33		25		0.45
2XDSR1181A	02346			3.0	.1181		3.00		63		24		19		0.46
2XDSR1200A	02348		31		.1200	1/8		2.50		1.125		0.90		0.019	
2XDSR1220A	02349			3.1	.1220		4.00		69		32		26		0.48
2XDSR1250A	02350	1/8			.1250	1/8		2.50		1.125		0.90		0.019	
2XDSR1260A	02352			3.2	.1260		4.00		69		32		26		0.50

Inch	
D1	Tolerance (h7)
.0000 - .1181	+0/--.00039
.1182 - .2362	+0/--.00047
.2363 - .3937	+0/--.00059
.3938 - .6250	+0/--.00071

Inch	
D2	Tolerance (h6)
.0000 - .1181	+0/--.00024
.1182 - .2362	+0/--.00031
.2363 - .3937	+0/--.00035
.3938 - .6250	+0/--.00043

Metric (mm)	
D1	Tolerance (h7)
0 - 3.0	+0/--.010
3.01 - 6.0	+0/--.012
6.01 - 10.0	+0/--.015
10.01 - 16.0	+0/--.018

Metric (mm)	
D2	Tolerance (h6)
0 - 3.0	+0/--.006
3.01 - 6.0	+0/--.008
6.01 - 10.0	+0/--.009
10.01 - 16.0	+0/--.011



Series 2XDSR Continued

ALtima®		Diameter				Shank		OAL		Flute Length		Drill Length		Point Length	
Tool No.	EDP	D1 (h7)				D2 (h6)		L1		L2 (Max.)		L3 Ref.		L5	
		Inch	Letter/ Wire	mm	Decimal	Inch	mm	Inch	mm	Inch	mm	Inch	mm	Inch	mm
2XDSR1285A	02354		30		.1285	5/32		2.75		1.260		1.000		0.020	
2XDSR1299A	02356			3.3	.1299		4.00		69		32		26		0.51
2XDSR1339A	02358			3.4	.1339		4.00		69		32		26		0.53
2XDSR1360A	02360		29		.1360	5/32		2.75		1.260		1.000		0.021	
2XDSR1378A	02362			3.5	.1378		4.00		69		32		26		0.54
2XDSR1406A	02364	9/64			.1406	5/32		2.75		1.260		1.000		0.022	
2XDSR1417A	02365			3.6	.1417		4.00		69		32		26		0.56
2XDSR1457A	02366			3.7	.1457		4.00		69		32		26		0.57
2XDSR1496A	02368			3.8	.1496		4.00		69		32		26		0.59
2XDSR1520A	02367		24		.1520	5/32		2.75		1.260		1.000		0.024	
2XDSR1535A	02369			3.9	.1535		4.00		69		32		26		0.60
2XDSR1562A	02370	5/32			.1562	5/32		2.75		1.260		1.000		0.024	
2XDSR1575A	02372			4.0	.1575		4.00		69		32		26		0.62
2XDSR1590A	02373		21		.1590	3/16		3.15		1.500		1.200		0.025	
2XDSR1614A	04006			4.1	.1614		5.00		80		38		30		0.64
2XDSR1654A	02374			4.2	.1654		5.00		80		38		30		0.65
2XDSR1693A	02375			4.3	.1693		5.00		80		38		30		0.67
2XDSR1719A	02376	11/64			.1719	3/16		3.15		1.500		1.200		0.027	
2XDSR1732A	02377			4.4	.1732		5.00		80		38		30		0.68
2XDSR1772A	02378			4.5	.1772		5.00		80		38		30		0.70
2XDSR1811A	02380			4.6	.1811		5.00		80		38		30		0.71
2XDSR1850A	02381			4.7	.1850		5.00		80		38		30		0.73
2XDSR1875A	02382	3/16			.1875	3/16		3.15		1.500		1.200		0.029	
2XDSR1890A	02384			4.8	.1890		5.00		80		38		30		0.74
2XDSR1929A	02386			4.9	.1929		5.00		80		38		30		0.76
2XDSR1968A	02388			5.0	.1968		5.00		80		38		30		0.77
2XDSR2008A	02390			5.1	.2008		6.00		82		40		32		0.79
2XDSR2031A	02392	13/64			.2031	15/64		3.23		1.580		1.260		0.031	
2XDSR2047A	02394			5.2	.2047		6.00		82		40		32		0.81
2XDSR2087A	02396			5.3	.2087		6.00		82		40		32		0.82
2XDSR2126A	02398			5.4	.2126		6.00		82		40		32		0.84
2XDSR2165A	02400			5.5	.2165		6.00		82		40		32		0.85
2XDSR2187A	02402	7/32			.2187	15/64		3.23		1.580		1.260		0.034	
2XDSR2210A	02404		2		.2210	15/64		3.23		1.580		1.260		0.034	
2XDSR2244A	02406			5.7	.2244		6.00		82		40		32		0.88
2XDSR2283A	02408			5.8	.2283		6.00		82		40		32		0.90
2XDSR2323A	02410			5.9	.2323		6.00		82		40		32		0.91
2XDSR2344A	02412	15/64			.2344	15/64		3.23		1.580		1.260		0.036	
2XDSR2362A	02414			6.0	.2362		6.00		82		40		32		0.93
2XDSR2402A	02416			6.1	.2402		8.00		91		48		38		0.95
2XDSR2420A	02418		C		.2420	1/4		3.25		1.740		1.390		0.037	
2XDSR2441A	02420			6.2	.2441		8.00		91		48		38		0.96



Series 2XDSR Continued

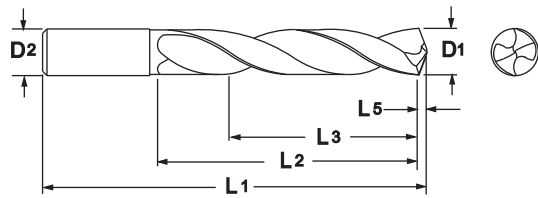
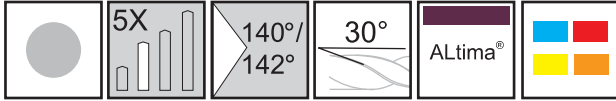

ALtima®		Diameter				Shank		OAL		Flute Length		Drill Length		Point Length	
		D1 (h7)				D2 (h6)		L1		L2 (Max.)		L3 Ref.		L5	
Tool No.	EDP	Inch	Letter/ Wire	mm	Decimal	Inch	mm	Inch	mm	Inch	mm	Inch	mm	Inch	mm
2XDSR2460A	02422		D		.2460	1/4		3.25		1.740		1.390		0.038	
2XDSR2480A	02424			6.3	.2480		8.00		91		48		38		0.98
2XDSR2500A	02426	1/4			.2500	1/4		3.25		1.740		1.390		0.039	
2XDSR2520A	02428			6.4	.2520		8.00		91		48		38		0.99
2XDSR2559A	02430			6.5	.2559		8.00		91		48		38		1.01
2XDSR2570A	02432		F		.2570	5/16		3.58		1.890		1.510		0.040	
2XDSR2598A	02433			6.6	.2598		8.00		91		48		38		1.03
2XDSR2610A	02434		G		.2610	5/16		3.58		1.890		1.510		0.040	
2XDSR2638A	02435			6.7	.2638		8.00		91		48		38		1.04
2XDSR2656A	02436	17/64			.2656	5/16		3.58		1.890		1.510		0.041	
2XDSR2677A	02438			6.8	.2677		8.00		91		48		38		1.05
2XDSR2717A	02440			6.9	.2717		8.00		91		48		38		1.07
2XDSR2756A	02442			7.0	.2756		8.00		91		48		38		1.08
2XDSR2795A	02443			7.1	.2795		8.00		91		48		38		1.10
2XDSR2812A	02444	9/32			.2812	5/16		3.58		1.890		1.510		0.044	
2XDSR2835A	02446			7.2	.2835		8.00		91		48		38		1.12
2XDSR2874A	02447			7.3	.2874		8.00		91		48		38		1.13
2XDSR2913A	02448			7.4	.2913		8.00		91		48		38		1.15
2XDSR2953A	02450			7.5	.2953		8.00		91		48		38		1.16
2XDSR2969A	02452	19/64			.2969	5/16		3.58		1.890		1.510		0.046	
2XDSR2992A	02454			7.6	.2992		8.00		91		48		38		1.18
2XDSR3031A	02456			7.7	.3031		8.00		91		48		38		1.19
2XDSR3071A	02458			7.8	.3071		8.00		91		48		38		1.21
2XDSR3110A	02459			7.9	.3110		8.00		91		48		38		1.22
2XDSR3125A	02460	5/16			.3125	5/16		3.58		1.890		1.510		0.048	
2XDSR3150A	02480			8.0	.3150		8.00		91		48		38		1.24
2XDSR3189A	02482			8.1	.3189		10.00		103		55		44		1.26
2XDSR3228A	02484			8.2	.3228		10.00		103		55		44		1.27
2XDSR3268A	02486			8.3	.3268		10.00		103		55		44		1.29
2XDSR3281A	02488	21/64			.3281	25/64		4.06		2.170		1.740		0.051	
2XDSR3307A	02487			8.4	.3307		10.00		103		55		44		1.31
2XDSR3320A	02489		Q		.3320	25/64		4.06		2.170		1.740		0.051	
2XDSR3346A	02490			8.5	.3346		10.00		103		55		44		1.32
2XDSR3386A	02491			8.6	.3386		10.00		103		55		44		1.33
2XDSR3425A	04007			8.7	.3425		10.00		103		55		44		1.35
2XDSR3438A	02492	11/32			.3438	25/64		4.06		2.170		1.740		0.053	
2XDSR3465A	02494			8.8	.3465		10.00		103		55		44		1.36
2XDSR3504A	02496			8.9	.3504		10.00		103		55		44		1.38



Series 2XDSR Continued

ALtima®		Diameter				Shank		OAL		Flute Length		Drill Length		Point Length	
		D1 (h7)				D2 (h6)		L1		L2 (Max.)		L3 Ref.		L5	
Tool No.	EDP	Inch	Letter/ Wire	mm	Decimal	Inch	mm	Inch	mm	Inch	mm	Inch	mm	Inch	mm
2XDSR3543A	02498			9.0	.3543		10.00		103		55		44		1.39
2XDSR3583A	02499			9.1	.3583		10.00		103		55		44		1.41
2XDSR3594A	02500	23/64			.3594	25/64		4.06		2.170		1.740		0.056	
2XDSR3622A	02502			9.2	.3622		10.00		103		55		44		1.43
2XDSR3642A	02504			9.25	.3642		10.00		103		55		44		1.43
2XDSR3661A	02506			9.3	.3661		10.00		103		55		44		1.44
2XDSR3701A	02507			9.4	.3701		10.00		103		55		44		1.46
2XDSR3740A	02508			9.5	.3740		10.00		103		55		44		1.47
2XDSR3750A	02510	3/8			.3750	25/64		4.06		2.170		1.740		0.058	
2XDSR3780A	02511			9.6	.3780		10.00		103		55		44		1.49
2XDSR3819A	02512			9.7	.3819		10.00		103		55		44		1.50
2XDSR3858A	02514			9.8	.3858		10.00		103		55		44		1.52
2XDSR3898A	02515			9.9	.3898		10.00		103		55		44		1.53
2XDSR3906A	02516	25/64			.3906	25/64		4.06		2.170		1.740		0.061	
2XDSR3937A	02518			10.0	.3937		10.00		103		55		44		1.55
2XDSR3976A	02519			10.1	.3976		12.00		120		60		48		1.56
2XDSR4016A	02520			10.2	.4016		12.00		120		60		48		1.58
2XDSR4055A	02521			10.3	.4055		12.00		120		60		48		1.60
2XDSR4062A	02522	13/32			.4062	15/32		4.72		2.360		1.890		0.063	
2XDSR4094A	02523			10.4	.4094		12.00		120		60		48		1.61
2XDSR4134A	02524			10.5	.4134		12.00		120		60		48		1.63
2XDSR4173A	02525			10.6	.4173		12.00		120		60		48		1.64
2XDSR4213A	04008			10.7	.4213		12.00		120		60		48		1.66
2XDSR4219A	02526	27/64			.4219	15/32		4.72		2.360		1.890		0.065	
2XDSR4252A	02527			10.8	.4252		12.00		120		60		48		1.67
2XDSR4291A	04009			10.9	.4291		12.00		120		60		48		1.69
2XDSR4331A	02528			11.0	.4331		12.00		120		60		48		1.70
2XDSR4370A	02529			11.1	.4370		12.00		120		66		53		1.72
2XDSR4375A	02530	7/16			.4375	15/32		4.72		2.600		2.080		0.068	
2XDSR4409A	02532			11.2	.4409		12.00		120		66		53		1.74
2XDSR4449A	02533			11.3	.4449		12.00		120		66		53		1.75
2XDSR4488A	04010			11.4	.4488		12.00		120		66		53		1.77
2XDSR4527A	02534			11.5	.4527		12.00		120		66		53		1.78
2XDSR4567A	02535			11.6	.4567		12.00		120		66		53		1.80
2XDSR4606A	02536			11.7	.4606		12.00		120		66		53		1.81
2XDSR4646A	02537			11.8	.4646		12.00		120		66		53		1.83
2XDSR4685A	04011			11.9	.4685		12.00		120		66		53		1.84
2XDSR4688A	02538	15/32			.4688	15/32		4.72		2.600		2.080		0.073	
2XDSR4724A	02540			12.0	.4724		12.00		120		66		53		1.86
2XDSR4764A	02542			12.1	.4764		14.00		126		72		58		1.87
2XDSR4844A	02544	31/64			.4844	1/2		4.75		2.830		2.260		0.075	
2XDSR4921A	02546			12.5	.4921		14.00		126		72		58		1.94
2XDSR5000A	02548	1/2			.5000	1/2		4.75		2.830		2.260		0.077	



Series 2XDSR Continued

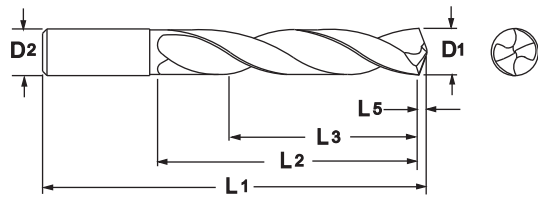
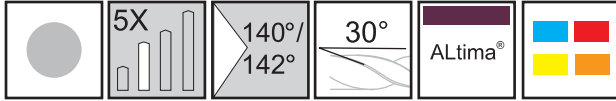

ALtima®		Diameter				Shank		OAL		Flute Length		Drill Length		Point Length	
		D1 (h7)				D2 (h6)		L1		L2 (Max.)		L3 Ref.		L5	
Tool No.	EDP	Inch	Letter/ Wire	mm	Decimal	Inch	mm	Inch	mm	Inch	mm	Inch	mm	Inch	mm
2XDSR5039A	02550			12.8	.5039		14.00		126		72		58		1.98
2XDSR5051A	02549			12.83	.5051		14.00		126		72		58		1.99
2XDSR5079A	02551			12.9	.5079		14.00		126		72		58		2.00
2XDSR5118A	02552			13.0	.5118		14.00		126		72		58		2.01
2XDSR5156A	02554	33/64			.5156	35/64		5.28		3.030		2.420		0.080	
2XDSR5312A	02555	17/32			.5312	35/64		5.28		3.030		2.420		0.082	
2XDSR5315A	02556			13.5	.5315		14.00		134		77		62		2.09
2XDSR5394A	02558			13.7	.5394		14.00		134		77		62		2.12
2XDSR5469A	02560	35/64			.5469	35/64		5.28		3.030		2.420		0.085	
2XDSR5512A	02562			14.0	.5512		14.00		134		77		62		2.17
2XDSR5625A	02564	9/16			.5625	5/8		5.51		3.150		2.520		0.087	
2XDSR5709A	02566			14.5	.5709		16.00		140		80		64		2.25
2XDSR5787A	02568			14.7	.5787		16.00		140		80		64		2.28
2XDSR5905A	02570			15.0	.5905		16.00		140		80		64		2.32
2XDSR5938A	02572	19/32			.5938	5/8		5.75		3.230		2.580		0.092	
2XDSR6024A	02573			15.3	.6024		16.00		146		82		66		2.37
2XDSR6102A	02574			15.5	.6102		16.00		146		82		66		2.40
2XDSR6181A	02576			15.7	.6181		16.00		146		82		66		2.43
2XDSR6250A	02578	5/8			.6250	5/8		5.75		3.230		2.580		0.097	
2XDSR6299A	02580			16.0	.6299		16.00		146		82		66		2.48



Twister XD® Series 2XDCS

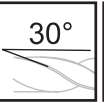
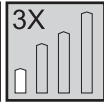

Metric
>5mm
DIN
6537K

Designed for high performance drilling in a broad range of materials.

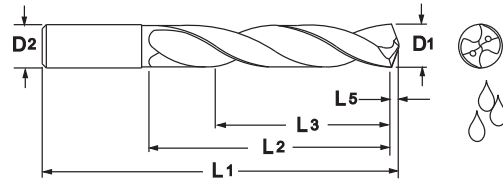

ALtima®		Diameter				Shank		OAL		Flute Length		Drill Length		Point Length	
		D1 (h7)				D2 (h6)		L1		L2 (Max.)		L3 Ref.		L5	
Tool No.	EDP	Inch	Letter/ Wire	mm	Decimal	Inch	mm	Inch	mm	Inch	mm	Inch	mm	Inch	mm
2XDCS1181A	04400			3.0	.1181		3.0		57		16		13		0.46
2XDCS1200A	04402		31		.1200	1/8		2.250		.750		.600		.019	
2XDCS1220A	04404			3.1	.1220		4.0		63		22		18		0.48
2XDCS1250A	04406	1/8			.1250	1/8		2.250		.750		.600		.019	
2XDCS1260A	04408			3.2	.1260		4.0		63		22		18		0.50
2XDCS1285A	04410		30		.1285	5/32		2.500		.875		.700		.020	
2XDCS1299A	04412			3.3	.1299		4.0		63		22		18		0.51
2XDCS1339A	04414			3.4	.1339		4.0		63		22		18		0.53
2XDCS1360A	04416		29		.1360	5/32		2.500		.875		.700		.021	
2XDCS1378A	04418			3.5	.1378		4.0		63		22		18		0.54
2XDCS1406A	04420	9/64			.1406	5/32		2.500		.875		.700		.022	
2XDCS1417A	04422			3.6	.1417		4.0		63		22		18		0.56
2XDCS1457A	04424			3.7	.1457		4.0		63		22		18		0.57
2XDCS1496A	04426			3.8	.1496		4.0		63		22		18		0.59
2XDCS1520A	04428		24		.1520	5/32		2.500		.875		.700		.024	
2XDCS1535A	04430			3.9	.1535		4.0		63		22		18		0.60
2XDCS1562A	04432	5/32			.1562	5/32		2.500		.875		.700		.024	
2XDCS1575A	04434			4.0	.1575		4.0		63		22		18		0.62
2XDCS1590A	04436		21		.1590	3/16		2.500		1.000		.800		.025	
2XDCS1614A	04438			4.1	.1614		5.0		63		26		21		0.64
2XDCS1654A	04440			4.2	.1654		5.0		63		26		21		0.65
2XDCS1693A	04442			4.3	.1693		5.0		63		26		21		0.67
2XDCS1719A	04444	11/64			.1719	3/16		2.500		1.000		.800		.027	
2XDCS1732A	04446			4.4	.1732		5.0		63		26		21		0.68
2XDCS1772A	04448			4.5	.1772		5.0		63		26		21		0.70
2XDCS1811A	04450			4.6	.1811		5.0		63		26		21		0.71
2XDCS1850A	04452			4.7	.1850		5.0		63		26		21		0.73
2XDCS1875A	04454	3/16			.1875	3/16		2.500		1.000		.800		.029	
2XDCS1890A	04456			4.8	.1890		5.0		63		26		21		0.74
2XDCS1929A	04458			4.9	.1929		5.0		63		26		21		0.76
2XDCS1968A	04460			5.0	.1968		5.0		63		26		21		0.77

Inch		Tolerance (h7)
D1	D2	
.0000 - .1181		+0/--.00039
.1182 - .2362		+0/--.00047
.2363 - .3937		+0/--.00059
.3938 - .6250		+0/--.00071

Inch		Tolerance (h6)
D2	D2	
.0000 - .1181		+0/--.00024
.1182 - .2362		+0/--.00031
.2363 - .3937		+0/--.00035
.3938 - .6250		+0/--.00043

Metric (mm)		Tolerance (h7)
D1	D1	
0 - 3.0		+0/--.010
3.01 - 6.0		+0/--.012
6.01 - 10.0		+0/--.015
10.01 - 16.0		+0/--.018

Metric (mm)		Tolerance (h6)
D2	D2	
0 - 3.0		+0/--.006
3.01 - 6.0		+0/--.008
6.01 - 10.0		+0/--.009
10.01 - 16.0		+0/--.011



Series 2XDCS Continued

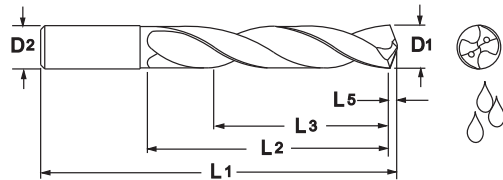
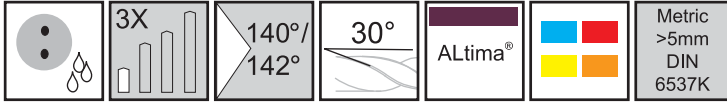

ALtima®		Diameter				Shank		OAL		Flute Length		Drill Length		Point Length	
		D1 (h7)				D2 (h6)		L1		L2 (Max.)		L3 Ref.		L5	
Tool No.	EDP	Inch	Letter/ Wire	mm	Decimal	Inch	mm	Inch	mm	Inch	mm	Inch	mm	Inch	mm
2XDCS2008A	04462			5.1	.2008		6.0		66		28		20		0.79
2XDCS2031A	04464	13/64			.2031	15/64		2.598		1.102		.787		.031	
2XDCS2047A	04466			5.2	.2047		6.0		66		28		20		0.81
2XDCS2087A	04468			5.3	.2087		6.0		66		28		20		0.82
2XDCS2126A	04470			5.4	.2126		6.0		66		28		20		0.84
2XDCS2165A	04472			5.5	.2165		6.0		66		28		20		0.85
2XDCS2187A	04474	7/32			.2187	15/64		2.598		1.102		.787		.034	
2XDCS2210A	04476		2		.2210	15/64		2.598		1.102		.787		.034	
2XDCS2244A	04478			5.7	.2244		6.0		66		28		20		0.88
2XDCS2283A	04480			5.8	.2283		6.0		66		28		20		0.90
2XDCS2323A	04482			5.9	.2323		6.0		66		28		20		0.91
2XDCS2344A	04484	15/64			.2344	15/64		2.598		1.102		.787		.036	
2XDCS2362A	04486			6.0	.2362		6.0		66		28		20		0.93
2XDCS2402A	04488			6.1	.2402		8.0		79		34		24		0.95
2XDCS2420A	04490		C		.2420	1/4		3.110		1.339		.945		.037	
2XDCS2441A	04492			6.2	.2441		8.0		79		34		24		0.96
2XDCS2460A	04494		D		.2460	1/4		3.110		1.339		.945		.038	
2XDCS2480A	04496			6.3	.2480		8.0		79		34		24		0.98
2XDCS2500A	04498	1/4			.2500	1/4		3.110		1.339		.945		.039	
2XDCS2520A	04500			6.4	.2520		8.0		79		34		24		0.99
2XDCS2559A	04502			6.5	.2559		8.0		79		34		24		1.01
2XDCS2570A	04504		F		.2570	5/16		3.110		1.339		.945		.040	
2XDCS2598A	04506			6.6	.2598		8.0		79		34		24		1.03
2XDCS2610A	04508		G		.2610	5/16		3.110		1.339		.945		.040	
2XDCS2638A	04510			6.7	.2638		8.0		79		34		24		1.04
2XDCS2656A	04512	17/64			.2656	5/16		3.110		1.339		.945		.041	
2XDCS2677A	04514			6.8	.2677		8.0		79		34		24		1.05
2XDCS2717A	04516			6.9	.2717		8.0		79		34		24		1.07
2XDCS2756A	04518			7.0	.2756		8.0		79		34		24		1.08
2XDCS2795A	04520			7.1	.2795		8.0		79		41		29		1.10
2XDCS2812A	04522	9/32			.2812	5/16		3.110		1.614		1.142		.044	
2XDCS2835A	04524			7.2	.2835		8.0		79		41		29		1.12
2XDCS2874A	04526			7.3	.2874		8.0		79		41		29		1.13
2XDCS2913A	04528			7.4	.2913		8.0		79		41		29		1.15
2XDCS2953A	04530			7.5	.2953		8.0		79		41		29		1.16
2XDCS2969A	04532	19/64			.2969	5/16		3.110		1.614		1.142		.046	
2XDCS2992A	04534			7.6	.2992		8.0		79		41		29		1.18



Series 2XDCS Continued

ALtima®		Diameter				Shank		OAL		Flute Length		Drill Length		Point Length	
		D1 (h7)				D2 (h6)		L1		L2 (Max.)		L3 Ref.		L5	
Tool No.	EDP	Inch	Letter/ Wire	mm	Decimal	Inch	mm	Inch	mm	Inch	mm	Inch	mm	Inch	mm
2XDCS3031A	04536			7.7	.3031	8.0		79		41		29		1.19	
2XDCS3071A	04538			7.8	.3071	8.0		79		41		29		1.21	
2XDCS3110A	04540			7.9	.3110	8.0		79		41		29		1.22	
2XDCS3125A	04542	5/16			.3125	5/16		3.110		1.614		1.142		.048	
2XDCS3150A	04544			8.0	.3150	8.0		79		41		29		1.24	
2XDCS3189A	04546			8.1	.3189	10.0		89		47		35		1.26	
2XDCS3228A	04548			8.2	.3228	10.0		89		47		35		1.27	
2XDCS3268A	04550			8.3	.3268	10.0		89		47		35		1.29	
2XDCS3281A	04552	21/64			.3281	25/64		3.504		1.850		1.378		.051	
2XDCS3307A	04554			8.4	.3307	10.0		89		47		35		1.31	
2XDCS3320A	04556		Q		.3320	25/64		3.504		1.850		1.378		.051	
2XDCS3346A	04558			8.5	.3346	10.0		89		47		35		1.32	
2XDCS3386A	04560			8.6	.3386	10.0		89		47		35		1.33	
2XDCS3425A	04562			8.7	.3425	10.0		89		47		35		1.35	
2XDCS3438A	04564	11/32			.3438	25/64		3.504		1.850		1.378		.053	
2XDCS3465A	04566			8.8	.3465	10.0		89		47		35		1.36	
2XDCS3504A	04568			8.9	.3504	10.0		89		47		35		1.38	
2XDCS3543A	04570			9.0	.3543	10.0		89		47		35		1.39	
2XDCS3583A	04572			9.1	.3583	10.0		89		47		35		1.41	
2XDCS3594A	04574	23/64			.3594	25/64		3.504		1.850		1.378		.056	
2XDCS3622A	04576			9.2	.3622	10.0		89		47		35		1.43	
2XDCS3642A	04578			9.25	.3642	10.0		89		47		35		1.43	
2XDCS3661A	04580			9.3	.3661	10.0		89		47		35		1.44	
2XDCS3701A	04582			9.4	.3701	10.0		89		47		35		1.46	
2XDCS3740A	04584			9.5	.3740	10.0		89		47		35		1.47	
2XDCS3750A	04586	3/8			.3750	25/64		3.504		1.850		1.378		.058	
2XDCS3780A	04588			9.6	.3780	10.0		89		47		35		1.49	
2XDCS3819A	04590			9.7	.3819	10.0		89		47		35		1.50	
2XDCS3858A	04592			9.8	.3858	10.0		89		47		35		1.52	
2XDCS3898A	04594			9.9	.3898	10.0		89		47		35		1.53	
2XDCS3906A	04596	25/64			.3906	25/64		3.504		1.850		1.378		.061	
2XDCS3937A	04598			10.0	.3937	10.0		89		47		35		1.55	
2XDCS3976A	04600			10.1	.3976	12.0		102		55		40		1.56	
2XDCS4016A	04602			10.2	.4016	12.0		102		55		40		1.58	
2XDCS4055A	04604			10.3	.4055	12.0		102		55		40		1.60	
2XDCS4062A	04606	13/32			.4062	15/32		4.016		2.165		1.575		.063	
2XDCS4094A	04608			10.4	.4094	12.0		102		55		40		1.61	
2XDCS4134A	04610			10.5	.4134	12.0		102		55		40		1.63	
2XDCS4173A	04612			10.6	.4173	12.0		102		55		40		1.64	
2XDCS4213A	04614			10.7	.4213	12.0		102		55		40		1.66	
2XDCS4219A	04616	27/64			.4219	15/32		4.016		2.165		1.575		.065	
2XDCS4252A	04618			10.8	.4252	12.0		102		55		40		1.67	

2XDCS
TwisterXD®



Series 2XDCS Continued

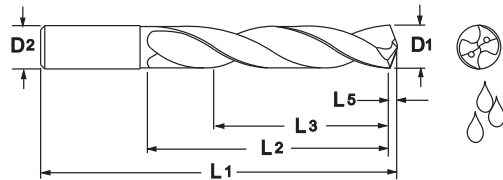
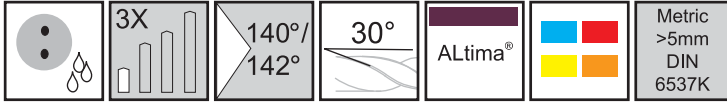

ALtima®		Diameter				Shank		OAL		Flute Length		Drill Length		Point Length	
		D1 (h7)				D2 (h6)		L1		L2 (Max.)		L3 Ref.		L5	
Tool No.	EDP	Inch	Letter/ Wire	mm	Decimal	Inch	mm	Inch	mm	Inch	mm	Inch	mm	Inch	mm
2XDCS4291A	04620			10.9	.4291		12.0		102		55		40		1.69
2XDCS4331A	04622			11.0	.4331		12.0		102		55		40		1.70
2XDCS4370A	04624			11.1	.4370		12.0		102		55		40		1.72
2XDCS4375A	04626	7/16			.4375	15/32		4.016		2.165		1.575		.068	
2XDCS4409A	04628			11.2	.4409		12.0		102		55		40		1.74
2XDCS4449A	04630			11.3	.4449		12.0		102		55		40		1.75
2XDCS4488A	04632			11.4	.4488		12.0		102		55		40		1.77
2XDCS4527A	04634			11.5	.4527		12.0		102		55		40		1.78
2XDCS4567A	04636			11.6	.4567		12.0		102		55		40		1.80
2XDCS4606A	04638			11.7	.4606		12.0		102		55		40		1.81
2XDCS4646A	04640			11.8	.4646		12.0		102		55		40		1.83
2XDCS4685A	04642			11.9	.4685		12.0		102		55		40		1.84
2XDCS4688A	04644	15/32			.4688	15/32		4.016		2.165		1.575		.073	
2XDCS4724A	04646			12.0	.4724		12.0		102		55		40		1.86
2XDCS4764A	04648			12.1	.4764		14.0		107		60		43		1.87
2XDCS4844A	04650	31/64			.4844	1/2		4.213		2.362		1.693		.075	
2XDCS4921A	04652			12.5	.4921		14.0		107		60		43		1.94
2XDCS5000A	04654	1/2			.5000	1/2		4.213		2.362		1.693		.077	
2XDCS5039A	04656			12.8	.5039		14.0		107		60		43		1.98
2XDCS5051A	04658			12.83	.5051		14.0		107		60		43		1.99
2XDCS5079A	04660			12.9	.5079		14.0		107		60		43		2.00
2XDCS5118A	04662			13.0	.5118		14.0		107		60		43		2.01
2XDCS5156A	04664	33/64			.5156	35/64		4.213		2.362		1.693		.080	
2XDCS5315A	04666			13.5	.5315		14.0		107		60		43		2.09
2XDCS5394A	04668			13.7	.5394		14.0		107		60		43		2.12
2XDCS5469A	04670	35/64			.5469	35/64		4.213		2.362		1.693		.085	
2XDCS5512A	04672			14.0	.5512		14.0		107		60		43		2.17
2XDCS5625A	04674	9/16			.5625	5/8		4.528		2.559		1.772		.087	
2XDCS5709A	04676			14.5	.5709		16.0		115		65		45		2.25
2XDCS5787A	04678			14.7	.5787		16.0		115		65		45		2.28
2XDCS5905A	04680			15.0	.5905		16.0		115		65		45		2.32
2XDCS5938A	04682	19/32			.5938	5/8		4.528		2.559		1.772		.092	
2XDCS6024A	04684			15.3	.6024		16.0		115		65		45		2.37
2XDCS6102A	04686			15.5	.6102		16.0		115		65		45		2.40
2XDCS6181A	04688			15.7	.6181		16.0		115		65		45		2.43
2XDCS6250A	04690	5/8			.6250	5/8		4.528		2.559		1.772		.097	
2XDCS6299A	04692			16.0	.6299		16.0		115		65		45		2.48



Twister XD® Series 2XDCR

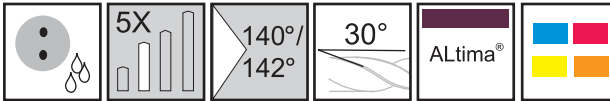

Designed for high performance drilling in a broad range of materials.

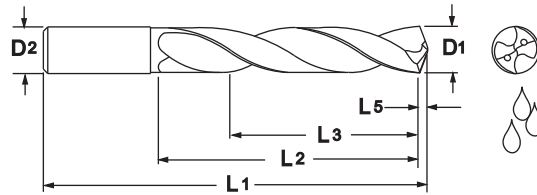

ALtima®		Diameter				Shank		OAL		Flute Length		Drill Length		Point Length	
		D1 (h7)				D2 (h6)		L1		L2 (Max.)		L3 Ref.		L5	
Tool No.	EDP	Inch	Letter/ Wire	mm	Decimal	Inch	mm	Inch	mm	Inch	mm	Inch	mm	Inch	mm
2XDCR1181A	02582			3.0	.1181		3.0		75		24		19		0.46
2XDCR1200A	02584		31		.1200	1/8		3.00		1.125		.90		0.019	
2XDCR1220A	02585			3.1	.1220		4.0		80		32		26		0.48
2XDCR1250A	02586	1/8			.1250	1/8		3.00		1.125		.90		0.019	
2XDCR1260A	02590			3.2	.1260		4.0		80		32		26		0.50
2XDCR1285A	02592		30		.1285	5/32		3.15		1.260		1.00		0.020	
2XDCR1299A	02594			3.3	.1299		4.0		80		32		26		0.51
2XDCR1339A	02596			3.4	.1339		4.0		80		32		26		0.53
2XDCR1360A	02598		29		.1360	5/32		3.15		1.2600		1.00		0.021	
2XDCR1378A	02600			3.5	.1378		4.0		80		32		26		0.54
2XDCR1406A	02602	9/64			.1406	5/32		3.15		1.260		1.00		0.022	
2XDCR1417A	02603			3.6	.1417		4.0		80		32		26		0.56
2XDCR1457A	02604			3.7	.1457		4.0		80		32		26		0.57
2XDCR1496A	02606			3.8	.1496		4.0		80		32		26		0.59
2XDCR1520A	02605		24		.1520	5/32		3.15		1.260		1.00		0.024	
2XDCR1535A	02607			3.9	.1535		4.0		80		32		26		0.60
2XDCR1562A	02608	5/32			.1562	5/32		3.15		1.260		1.00		0.024	
2XDCR1575A	02610			4.0	.1575		4.0		80		32		26		0.62
2XDCR1590A	02611		21		.1590	3/16		3.23		1.500		1.20		0.025	
2XDCR1614A	04012			4.1	.1614		5.0		82		38		30		0.64
2XDCR1654A	02612			4.2	.1654		5.0		82		38		30		0.65
2XDCR1693A	02613			4.3	.1693		5.0		82		38		30		0.67
2XDCR1719A	02614	11/64			.1719	3/16		3.23		1.500		1.20		0.027	
2XDCR1732A	02615			4.4	.1732		5.0		82		38		30		0.68
2XDCR1772A	02616			4.5	.1772		5.0		82		38		30		0.70
2XDCR1811A	02618			4.6	.1811		5.0		82		38		30		0.71

Inch	
D1	Tolerance (h7)
.0000 - .1181	+0/- .00039
.1182 - .2362	+0/- .00047
.2363 - .3937	+0/- .00059
.3938 - .7087	+0/- .00071
.7088 - .7500	+0/- .00083

Inch	
D2	Tolerance (h6)
.0000 - .1181	+0/- .00024
.1182 - .2362	+0/- .00031
.2363 - .3937	+0/- .00035
.3938 - .7087	+0/- .00043
.7088 - .7500	+0/- .00051

Metric (mm)	
D1	Tolerance (h7)
0 - 3.0	+0/- .010
3.01 - 6.0	+0/- .012
6.01 - 10.0	+0/- .015
10.01 - 18.0	+0/- .018
18.01 - 20.0	+0/- .021

Metric (mm)	
D2	Tolerance (h6)
0 - 3.0	+0/- .006
3.01 - 6.0	+0/- .008
6.01 - 10.0	+0/- .009
10.01 - 18.0	+0/- .011
18.01 - 20.0	+0/- .013



Series 2XDCR Continued

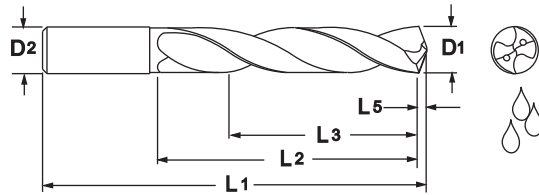
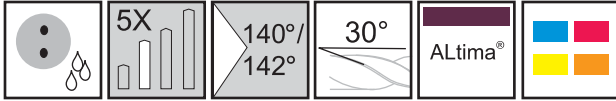

ALtima®		Diameter				Shank		OAL		Flute Length		Drill Length		Point Length	
		D1 (h7)				D2 (h6)		L1		L2 (Max.)		L3 Ref.		L5	
Tool No.	EDP	Inch	Letter/ Wire	mm	Decimal	Inch	mm	Inch	mm	Inch	mm	Inch	mm	Inch	mm
2XDCR1850A	02619			4.7	.1850		5.0		82		38		30		0.73
2XDCR1875A	02620	3/16			.1875	3/16		3.23		1.500		1.20		0.029	
2XDCR1890A	02622			4.8	.1890		5.0		82		38		30		0.74
2XDCR1929A	02624			4.9	.1929		5.0		82		38		30		0.76
2XDCR1968A	02626			5.0	.1968		5.0		82		38		30		0.77
2XDCR2008A	02628			5.1	.2008		6.0		82		40		32		0.79
2XDCR2031A	02630	13/64			.2031	15/64		3.23		1.580		1.26		0.031	
2XDCR2047A	02632			5.2	.2047		6.0		82		40		32		0.81
2XDCR2087A	02634			5.3	.2087		6.0		82		40		32		0.82
2XDCR2126A	02636			5.4	.2126		6.0		82		40		32		0.84
2XDCR2165A	02638			5.5	.2165		6.0		82		40		32		0.85
2XDCR2187A	02640	7/32			.2187	15/64		3.23		1.580		1.26		0.034	
2XDCR2210A	02642		2		.2210	15/64		3.23		1.580		1.26		0.034	
2XDCR2244A	02644			5.7	.2244		6.0		82		40		32		0.88
2XDCR2283A	02646			5.8	.2283		6.0		82		40		32		0.90
2XDCR2323A	02648			5.9	.2323		6.0		82		40		32		0.91
2XDCR2344A	02650	15/64			.2344	15/64		3.23		1.580		1.26		0.036	
2XDCR2362A	02652			6.0	.2362		6.0		82		40		32		0.93
2XDCR2402A	02654			6.1	.2402		8.0		91		48		38		0.95
2XDCR2420A	02656		C		.2420	1/4		3.30		1.740		1.39		0.037	
2XDCR2441A	02658			6.2	.2441		8.0		91		48		38		0.96
2XDCR2460A	02660		D		.2460	1/4		3.30		1.740		1.39		0.038	
2XDCR2480A	02662			6.3	.2480		8.0		91		48		38		0.98
2XDCR2500A	02664	1/4			.2500	1/4		3.30		1.740		1.39		0.039	
2XDCR2520A	02666			6.4	.2520		8.0		91		48		38		0.99
2XDCR2559A	02668			6.5	.2559		8.0		91		48		38		1.01
2XDCR2570A	02670		F		.2570	5/16		3.58		1.890		1.51		0.040	
2XDCR2598A	02671			6.6	.2598		8.0		91		48		38		1.03
2XDCR2610A	02672		G		.2610	5/16		3.58		1.890		1.51		0.040	
2XDCR2638A	02673			6.7	.2638		8.0		91		48		38		1.04
2XDCR2656A	02674	17/64			.2656	5/16		3.58		1.890		1.51		0.041	
2XDCR2677A	02676			6.8	.2677		8.0		91		48		38		1.05
2XDCR2717A	02678			6.9	.2717		8.0		91		48		38		1.07
2XDCR2756A	02680			7.0	.2756		8.0		91		48		38		1.08
2XDCR2795A	02681			7.1	.2795		8.0		91		48		38		1.10
2XDCR2812A	02682	9/32			.2812	5/16		3.58		1.890		1.51		0.044	
2XDCR2835A	02684			7.2	.2835		8.0		91		48		38		1.12
2XDCR2874A	02685			7.3	.2874		8.0		91		48		38		1.13



Series 2XDCR Continued

ALtima®		Diameter				Shank		OAL		Flute Length		Drill Length		Point Length	
		D1 (h7)				D2 (h6)		L1		L2 (Max.)		L3 Ref.		L5	
Tool No.	EDP	Inch	Letter/ Wire	mm	Decimal	Inch	mm	Inch	mm	Inch	mm	Inch	mm	Inch	mm
2XDCR2913A	02686			7.4	.2913		8.0		91		48		38		1.15
2XDCR2953A	02688			7.5	.2953		8.0		91		48		38		1.16
2XDCR2969A	02690	19/64			.2969	5/16		3.58		1.890		1.51		0.046	
2XDCR2992A	02692			7.6	.2992		8.0		91		48		38		1.18
2XDCR3031A	02694			7.7	.3031		8.0		91		48		38		1.19
2XDCR3071A	02696			7.8	.3071		8.0		91		48		38		1.21
2XDCR3110A	02697			7.9	.3110		8.0		91		48		38		1.22
2XDCR3125A	02698	5/16			.3125	5/16		3.58		1.890		1.51		0.048	
2XDCR3150A	02700			8.0	.3150		8.0		91		48		38		1.24
2XDCR3189A	02702			8.1	.3189		10.0		103		55		44		1.26
2XDCR3228A	02704			8.2	.3228		10.0		103		55		44		1.27
2XDCR3268A	02706			8.3	.3268		10.0		103		55		44		1.29
2XDCR3281A	02708	21/64			.3281	25/64		4.06		2.170		1.74		0.051	
2XDCR3307A	02707			8.4	.3307		10.0		103		55		44		1.31
2XDCR3320A	02709		Q		.3320	25/64		4.06		2.170		1.74		0.051	
2XDCR3346A	02710			8.5	.3346		10.0		103		55		44		1.32
2XDCR3386A	02711			8.6	.3386		10.0		103		55		44		1.33
2XDCR3425A	04013			8.7	.3425		10.0		103		55		44		1.35
2XDCR3438A	02712	11/32			.3438	25/64		4.06		2.170		1.74		0.053	
2XDCR3465A	02714			8.8	.3465		10.0		103		55		44		1.36
2XDCR3504A	02716			8.9	.3504		10.0		103		55		44		1.38
2XDCR3543A	02718			9.0	.3543		10.0		103		55		44		1.39
2XDCR3583A	02719			9.1	.3583		10.0		103		55		44		1.41
2XDCR3594A	02720	23/64			.3594	25/64		4.06		2.170		1.74		0.056	
2XDCR3622A	02722			9.2	.3622		10.0		103		55		44		1.43
2XDCR3642A	02724			9.25	.3642		10.0		103		55		44		1.43
2XDCR3661A	02726			9.3	.3661		10.0		103		55		44		1.44
2XDCR3701A	02727			9.4	.3701		10.0		103		55		44		1.46
2XDCR3740A	02728			9.5	.3740		10.0		103		55		44		1.47
2XDCR3750A	02730	3/8			.3750	25/64		4.06		2.170		1.74		0.058	
2XDCR3780A	02731			9.6	.3780		10.0		103		55		44		1.49
2XDCR3819A	02732			9.7	.3819		10.0		103		55		44		1.50
2XDCR3858A	02734			9.8	.3858		10.0		103		55		44		1.52
2XDCR3898A	02735			9.9	.3898		10.0		103		55		44		1.53
2XDCR3906A	02736	25/64			.3906	25/64		4.06		2.170		1.74		0.061	
2XDCR3937A	02738			10.0	.3937		10.0		103		55		44		1.55
2XDCR3976A	02739			10.1	.3976		12.0		120		60		48		1.56
2XDCR4016A	02740			10.2	.4016		12.0		120		60		48		1.58
2XDCR4055A	02741			10.3	.4055		12.0		120		60		48		1.60
2XDCR4062A	02742	13/32			.4062	15/32		4.72		2.360		1.89		0.063	
2XDCR4094A	02743			10.4	.4094		12.0		120		60		48		1.61
2XDCR4134A	02744			10.5	.4134		12.0		120		60		48		1.63

2XDCR
TwisterXD®



Series 2XDCR Continued

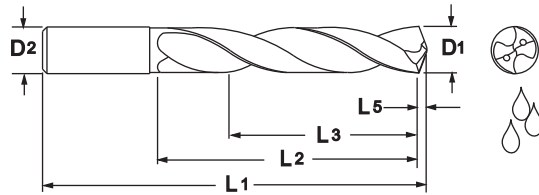
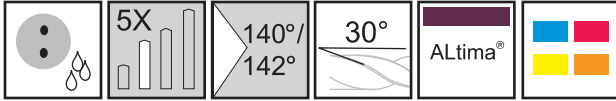

ALtima®		Diameter				Shank		OAL		Flute Length		Drill Length		Point Length	
		D1 (h7)				D2 (h6)		L1		L2 (Max.)		L3 Ref.		L5	
Tool No.	EDP	Inch	Letter/ Wire	mm	Decimal	Inch	mm	Inch	mm	Inch	mm	Inch	mm	Inch	mm
2XDCR4173A	02745			10.6	.4173		12.0		120		60		48		1.64
2XDCR4213A	04014			10.7	.4213		12.0		120		60		48		1.66
2XDCR4219A	02746	27/64			.4219	15/32		4.72		2.360		1.89		0.065	
2XDCR4252A	02747			10.8	.4252		12.0		120		60		48		1.67
2XDCR4291A	04015			10.9	.4291		12.0		120		60		48		1.69
2XDCR4331A	02748			11.0	.4331		12.0		120		60		48		1.70
2XDCR4370A	02749			11.1	.4370		12.0		120		66		53		1.72
2XDCR4375A	02750	7/16			.4375	15/32		4.72		2.600		2.08		0.068	
2XDCR4409A	02752			11.2	.4409		12.0		120		66		53		1.74
2XDCR4449A	02753			11.3	.4449		12.0		120		66		53		1.75
2XDCR4488A	04016			11.4	.4488		12.0		120		66		53		1.77
2XDCR4527A	02754			11.5	.4527		12.0		120		66		53		1.78
2XDCR4567A	02755			11.6	.4567		12.0		120		66		53		1.80
2XDCR4606A	02756			11.7	.4606		12.0		120		66		53		1.81
2XDCR4646A	02757			11.8	.4646		12.0		120		66		53		1.83
2XDCR4685A	04017			11.9	.4685		12.0		120		66		53		1.84
2XDCR4688A	02758	15/32			.4688	15/32		4.72		2.600		2.08		0.073	
2XDCR4724A	02760			12.0	.4724		12.0		120		66		53		1.86
2XDCR4764A	02762			12.1	.4764		14.0		126		72		58		1.87
2XDCR4844A	02764	31/64			.4844	1/2		4.75		2.830		2.26		0.075	
2XDCR4921A	02766			12.5	.4921		14.0		126		72		58		1.94
2XDCR5000A	02768	1/2			.5000	1/2		4.75		2.830		2.26		0.077	
2XDCR5039A	02770			12.8	.5039		14.0		126		72		58		1.98
2XDCR5051A	02769			12.83	.5051		14.0		126		72		58		1.99
2XDCR5079A	02771			12.9	.5079		14.0		126		72		58		2.00
2XDCR5118A	02772			13.0	.5118		14.0		126		72		58		2.01
2XDCR5156A	02774	33/64			.5156	35/64		5.28		3.030		2.42		0.080	
2XDCR5312A	02775	17/32			.5312	35/64		5.28		3.030		2.42		0.082	
2XDCR5315A	02776			13.5	.5315		14.0		134		77		62		2.09
2XDCR5394A	02778			13.7	.5394		14.0		134		77		62		2.12
2XDCR5469A	02780	35/64			.5469	35/64		5.28		3.030		2.42		0.085	
2XDCR5512A	02782			14.0	.5512		14.0		134		77		62		2.17
2XDCR5625A	02784	9/16			.5625	5/8		5.51		3.150		2.52		0.087	
2XDCR5709A	02786			14.5	.5709		16.0		140		80		64		2.25
2XDCR5787A	02788			14.7	.5787		16.0		140		80		64		2.28
2XDCR5905A	02790			15.0	.5905		16.0		140		80		64		2.32
2XDCR5938A	02792	19/32			.5938	5/8		5.75		3.230		2.58		0.092	



Series 2XDCR Continued

ALtima®		Diameter				Shank		OAL		Flute Length		Drill Length		Point Length	
		D1 (h7)				D2 (h6)		L1		L2 (Max.)		L3 Ref.		L5	
Tool No.	EDP	Inch	Letter/ Wire	mm	Decimal	Inch	mm	Inch	mm	Inch	mm	Inch	mm	Inch	mm
2XDCR6024A	02793			15.3	.6024		16.0		146		82		66		2.37
2XDCR6102A	02794			15.5	.6102		16.0		146		82		66		2.40
2XDCR6181A	02796			15.7	.6181		16.0		146		82		66		2.43
2XDCR6250A	02798	5/8			.6250	5/8		5.75		3.230		2.58		0.097	
2XDCR6299A	02800			16.0	.6299		16.0		146		82		66		2.48
2XDCR6331A	02802			16.08	.6331		18.0		158		90		72		2.49
2XDCR6417A	02803			16.3	.6417		18.0		158		90		72		2.53
2XDCR6496A	02804			16.5	.6496		18.0		158		90		72		2.56
2XDCR6562A	02806	21/32			.6562	45/64		6.22		3.540		2.83		0.102	
2XDCR6693A	02808			17.0	.6693		18.0		158		90		72		2.63
2XDCR6875A	02810	11/16			.6875	45/64		6.22		3.740		3.00		0.107	
2XDCR6890A	02812			17.5	.6890		18.0		158		95		76		2.71
2XDCR7087A	02814			18.0	.7087		18.0		158		95		76		2.79
2XDCR7283A	02816			18.5	.7283		20.0		160		100		80		2.87
2XDCR7500A	02818	3/4			.7500	3/4		6.3		3.940		3.15		0.116	
2XDCR7543A	02820			19.16	.7543		20.0		160		100		80		2.97
2XDCR7579A	02822			19.25	.7579		20.0		160		100		80		2.98
2XDCR7598A	02824			19.3	.7598		20.0		160		100		80		2.99
2XDCR7677A	02826			19.5	.7677		20.0		160		100		80		3.02
2XDCR7874A	02828			20.0	.7874		20.0		160		100		80		3.10



ISO 9001:2008 Certified



Twister XD® Series 2XDCL

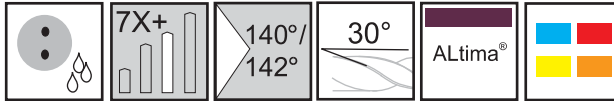

Designed for high performance drilling in a broad range of materials.

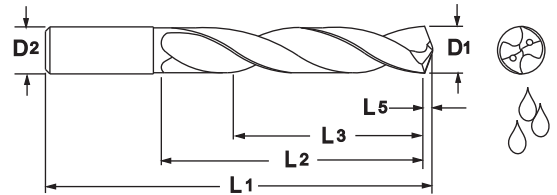

ALtima®		Diameter				Shank		OAL		Flute Length		Drill Length		Point Length	
		D1 (h7)				D2 (h6)		L1		L2 (Max.)		L3 Ref.		L5	
Tool No.	EDP	Inch	Letter/ Wire	mm	Decimal	Inch	mm	Inch	mm	Inch	mm	Inch	mm	Inch	mm
2XDCL1181A	02830			3.0	.1181		3.0		81		33		26		0.46
2XDCL1200A	02832		31		.1200	1/8		3.500		1.500		1.200		0.019	
2XDCL1220A	02833			3.1	.1220		4.0		92		44		35		0.48
2XDCL1250A	02834	1/8			.1250	1/8		3.500		1.500		1.200		0.019	
2XDCL1260A	02836			3.2	.1260		4.0		92		44		35		0.50
2XDCL1285A	02838		30		.1285	5/32		3.625		1.750		1.400		0.020	
2XDCL1299A	02840			3.3	.1299		4.0		92		44		35		0.51
2XDCL1339A	02842			3.4	.1339		4.0		92		44		35		0.53
2XDCL1360A	02844		29		.1360	5/32		3.625		1.750		1.400		0.021	
2XDCL1378A	02846			3.5	.1378		4.0		92		44		35		0.54
2XDCL1406A	02848	9/64			.1406	5/32		3.625		1.750		1.400		0.022	
2XDCL1417A	02849			3.6	.1417		4.0		92		44		35		0.56
2XDCL1457A	02850			3.7	.1457		4.0		92		44		35		0.57
2XDCL1496A	02852			3.8	.1496		4.0		92		44		35		0.59
2XDCL1520A	02851		24		.1520	5/32		3.625		1.750		1.400		0.024	
2XDCL1535A	02853			3.9	.1535		4.0		92		44		35		0.60
2XDCL1562A	02854	5/32			.1562	5/32		3.625		1.750		1.400		0.024	
2XDCL1575A	02856			4.0	.1575		4.0		92		44		35		0.62
2XDCL1590A	02857		21		.1590	3/16		3.940		1.750		1.400		0.025	
2XDCL1614A	04018			4.1	.1614		5.0		100		45		36		0.64
2XDCL1654A	02858			4.2	.1654		5.0		100		45		36		0.65
2XDCL1693A	02859			4.3	.1693		5.0		100		45		36		0.67
2XDCL1719A	02860	11/64			.1719	3/16		3.940		1.750		1.400		0.027	
2XDCL1732A	02861			4.4	.1732		5.0		100		45		36		0.68
2XDCL1772A	02862			4.5	.1772		5.0		100		45		36		0.70
2XDCL1811A	02864			4.6	.1811		5.0		100		45		36		0.71
2XDCL1850A	02865			4.7	.1850		5.0		100		45		36		0.73
2XDCL1875A	02866	3/16			.1875	3/16		3.940		1.750		1.400		0.029	
2XDCL1890A	02868			4.8	.1890		5.0		100		45		36		0.74
2XDCL1929A	02870			4.9	.1929		5.0		100		45		36		0.76
2XDCL1968A	02872			5.0	.1968		5.0		100		45		36		0.77
2XDCL2008A	02874			5.1	.2008		6.0		100		51		41		0.79
2XDCL2031A	02876	13/64			.2031	15/64		3.940		2.000		1.600		0.031	
2XDCL2047A	02878			5.2	.2047		6.0		100		51		41		0.81
2XDCL2087A	02880			5.3	.2087		6.0		100		51		41		0.82
2XDCL2126A	02882			5.4	.2126		6.0		100		51		41		0.84
2XDCL2165A	02884			5.5	.2165		6.0		100		51		41		0.85
2XDCL2187A	02886	7/32			.2187	15/64		3.940		2.000		1.600		0.034	

Inch		Inch		Metric (mm)		Metric (mm)	
D1	Tolerance (h7)	D2	Tolerance (h6)	D1	Tolerance (h7)	D2	Tolerance (h6)
.0000 - .1181	+0/- .00039	.0000 - .1181	+0/- .00024	0 - 3.0	+0/- .010	0 - 3.0	+0/- .006
.1182 - .2362	+0/- .00047	.1182 - .2362	+0/- .00031	3.01 - 6.0	+0/- .012	3.01 - 6.0	+0/- .008
.2363 - .3937	+0/- .00059	.2363 - .3937	+0/- .00035	6.01 - 10.0	+0/- .015	6.01 - 10.0	+0/- .009
.3938 - .7087	+0/- .00071	.3938 - .7087	+0/- .00043	10.01 - 18.0	+0/- .018	10.01 - 18.0	+0/- .011



Series 2XDCL Continued

ALtima®		Diameter				Shank		OAL		Flute Length		Drill Length		Point Length	
		D1 (h7)				D2 (h6)		L1		L2 (Max.)		L3 Ref.		L5	
Tool No.	EDP	Inch	Letter/ Wire	mm	Decimal	Inch	mm	Inch	mm	Inch	mm	Inch	mm	Inch	mm
2XDCL2210A	02888		2		.2210	15/64		3.940		2.000		1.60		0.034	
2XDCL2244A	02890			5.7	.2244		6.0		100		51		41		0.88
2XDCL2283A	02892			5.8	.2283		6.0		100		51		41		0.90
2XDCL2323A	02894			5.9	.2323		6.0		100		51		41		0.91
2XDCL2344A	02896	15/64			.2344	15/64		3.940		2.000		1.60		0.036	
2XDCL2362A	02898			6.0	.2362		6.0		100		51		41		0.93
2XDCL2402A	02900			6.1	.2402		8.0		109		60		48		0.95
2XDCL2420A	02902		C		.2420	1/4		4.310		2.250		1.80		0.037	
2XDCL2441A	02904			6.2	.2441		8.0		109		60		48		0.96
2XDCL2460A	02906		D		.2460	1/4		4.310		2.250		1.80		0.038	
2XDCL2480A	02908			6.3	.2480		8.0		109		60		48		0.98
2XDCL2500A	02910	1/4			.2500	1/4		4.310		2.250		1.80		0.039	
2XDCL2520A	02912			6.4	.2520		8.0		109		60		48		0.99
2XDCL2559A	02914			6.5	.2559		8.0		109		60		48		1.01
2XDCL2570A	02916		F		.2570	5/16		4.310		2.375		1.90		0.040	
2XDCL2598A	02917			6.6	.2598		8.0		109		60		48		1.03
2XDCL2610A	02918		G		.2610	5/16		4.310		2.375		1.90		0.040	
2XDCL2638A	02919			6.7	.2638		8.0		109		60		48		1.04
2XDCL2656A	02920	17/64			.2656	5/16		4.310		2.375		1.90		0.041	
2XDCL2677A	02922			6.8	.2677		8.0		109		60		48		1.05
2XDCL2717A	02924			6.9	.2717		8.0		109		60		48		1.07
2XDCL2756A	02926			7.0	.2756		8.0		109		60		48		1.08
2XDCL2795A	02927			7.1	.2795		8.0		118		70		56		1.10
2XDCL2812A	02928	9/32			.2812	5/16		4.625		2.750		2.20		0.044	
2XDCL2835A	02930			7.2	.2835		8.0		118		70		56		1.12
2XDCL2874A	02931			7.3	.2874		8.0		118		70		56		1.13
2XDCL2913A	02932			7.4	.2913		8.0		118		70		56		1.15
2XDCL2953A	02934			7.5	.2953		8.0		118		70		56		1.16
2XDCL2969A	02936	19/64			.2969	5/16		4.625		2.750		2.20		0.046	
2XDCL2992A	02938			7.6	.2992		8.0		118		70		56		1.18
2XDCL3031A	02940			7.7	.3031		8.0		118		70		56		1.19
2XDCL3071A	02942			7.8	.3071		8.0		118		70		56		1.21
2XDCL3110A	02943			7.9	.3110		8.0		118		70		56		1.22
2XDCL3125A	02944	5/16			.3125	5/16		4.625		2.750		2.20		0.048	
2XDCL3150A	02946			8.0	.3150		8.0		118		70		56		1.24
2XDCL3189A	02948			8.1	.3189		10.0		127		80		64		1.26
2XDCL3228A	02950			8.2	.3228		10.0		127		80		64		1.27
2XDCL3268A	02952			8.3	.3268		10.0		127		80		64		1.29
2XDCL3281A	02954	21/64			.3281	25/64		5.000		3.150		2.52		0.051	
2XDCL3307A	02953			8.4	.3307		10.0		127		80		64		1.31
2XDCL3320A	02955		Q		.3320	25/64		5.000		3.150		2.52		0.051	
2XDCL3346A	02956			8.5	.3346		10.0		127		80		64		1.32
2XDCL3386A	02957			8.6	.3386		10.0		127		80		64		1.33
2XDCL3425A	04019			8.7	.3425		10.0		127		80		64		1.35
2XDCL3438A	02958	11/32			.3438	25/64		5.000		3.150		2.52		0.053	
2XDCL3465A	02960			8.8	.3465		10.0		127		80		64		1.36

2XDCL
TwisterXD®



Series 2XDCL Continued

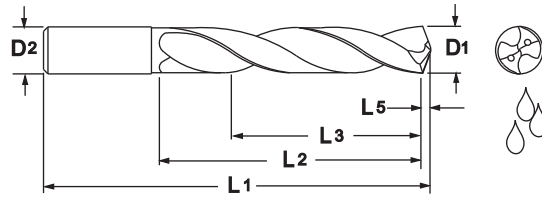
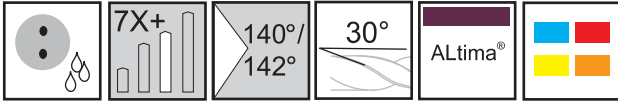

ALtima®		Diameter				Shank		OAL		Flute Length		Drill Length		Point Length	
		D1 (h7)				D2 (h6)		L1		L2 (Max.)		L3 Ref.		L5	
Tool No.	EDP	Inch	Letter/ Wire	mm	Decimal	Inch	mm	Inch	mm	Inch	mm	Inch	mm	Inch	mm
2XDCL3504A	02962			8.9	.3504		10.0		127		80		64		1.38
2XDCL3543A	02964			9.0	.3543		10.0		127		80		64		1.39
2XDCL3583A	02965			9.1	.3583		10.0		136		85		68		1.41
2XDCL3594A	02966	23/64			.3594	25/64		5.312		3.340		2.67		0.056	
2XDCL3622A	02968			9.2	.3622		10.0		136		85		68		1.43
2XDCL3642A	02970			9.25	.3642		10.0		136		85		68		1.43
2XDCL3661A	02972			9.3	.3661		10.0		136		85		68		1.44
2XDCL3701A	02973			9.4	.3701		10.0		136		85		68		1.46
2XDCL3740A	02974			9.5	.3740		10.0		136		85		68		1.47
2XDCL3750A	02976	3/8			.3750	25/64		5.312		3.340		2.67		0.058	
2XDCL3780A	02977			9.6	.3780		10.0		136		85		68		1.49
2XDCL3819A	02978			9.7	.3819		10.0		136		85		68		1.50
2XDCL3858A	02980			9.8	.3858		10.0		136		85		68		1.52
2XDCL3898A	04024			9.9	.3898		10.0		136		85		68		1.53
2XDCL3906A	02981	25/64			.3906	25/64		5.312		3.340		2.67		0.061	
2XDCL3937A	02982			10.0	.3937		10.0		136		85		68		1.55
2XDCL3976A	04025			10.1	.3976		12.0		149		93		74		1.56
2XDCL4016A	02983			10.2	.4016		12.0		149		93		74		1.58
2XDCL4055A	04026			10.3	.4055		12.0		149		93		74		1.60
2XDCL4062A	02984	13/32			.4062	15/32		5.875		3.625		2.90		0.063	
2XDCL4094A	02979			10.4	.4094		12.0		149		93		74		1.61
2XDCL4134A	02986			10.5	.4134		12.0		149		93		74		1.63
2XDCL4173A	02985			10.6	.4173		12.0		149		93		74		1.64
2XDCL4213A	04020			10.7	.4213		12.0		149		93		74		1.66
2XDCL4219A	02987	27/64			.4219	15/32		5.875		3.625		2.90		0.065	
2XDCL4252A	96600			10.8	.4252		12.0		149		93		74		1.67
2XDCL4291A	04021			10.9	.4291		12.0		149		93		74		1.69
2XDCL4331A	02988			11.0	.4331		12.0		149		93		74		1.70
2XDCL4370A	04027			11.1	.4370		12.0		155		102		82		1.72
2XDCL4375A	02989	7/16			.4375	15/32		6.100		4.000		3.20		0.068	
2XDCL4409A	02990			11.2	.4409		12.0		155		102		82		1.74
2XDCL4449A	04028			11.3	.4449		12.0		155		102		82		1.75
2XDCL4488A	04022			11.4	.4488		12.0		155		102		82		1.77
2XDCL4527A	02991			11.5	.4527		12.0		155		102		82		1.78
2XDCL4567A	04029			11.6	.4567		12.0		155		102		82		1.80
2XDCL4606A	02992			11.7	.4606		12.0		155		102		82		1.81
2XDCL4646A	96602			11.8	.4646		12.0		155		102		82		1.83
2XDCL4685A	04023			11.9	.4685		12.0		155		102		82		1.84
2XDCL4688A	02993	15/32			.4688	15/32		6.100		4.000		3.20		0.073	
2XDCL4724A	02994			12.0	.4724		12.0		155		102		82		1.86
2XDCL4844A	02995	31/64			.4844	1/2		6.299		4.312		3.45		0.075	
2XDCL5000A	02996	1/2			.5000	1/2		6.299		4.312		3.45		0.077	



Twister XD® Series 2XDCE

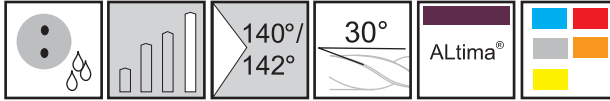

Designed to drill water lines in molds, the 2XDCE drill works exceptionally well in all deep hole drilling applications. With 2XD drilling geometry, this drill provides productivity increases and reduced cycle time by eliminating the need for a peck drilling cycle.

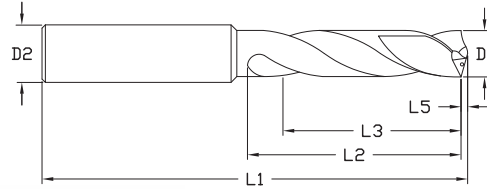

2XDCL / 2XDCE
Twister XD®

ALtima®		Diameter			Shank		OAL		Flute Length		Drill Length		Point Length		Fl. Length/ Dia.	Dr. Length/ Dia.
Tool No.	EDP	D1 (h7)			D2 (h6)		L1		L2		L3 Ref.		L5		L2/D1	L3/D1
		Inch	mm	Decimal	Inch	mm	Inch	mm	Inch	mm	Inch	mm	Inch	mm		
2XDCE1968A	04332		5.00	.1968		5.0		163		105		84		0.77	21	17
2XDCE2047A	04334		5.20	.2047		6.0		163		110		88		0.81	21	17
2XDCE2126A	04336		5.40	.2126		6.0		163		110		88		0.84	20	16
2XDCE2205A	04338		5.60	.2205		6.0		163		110		88		0.87	20	16
2XDCE2283A	04340		5.80	.2283		6.0		163		110		88		0.90	19	15
2XDCE2362A	04342		6.00	.2362		6.0		163		110		88		0.93	18	15
2XDCE2441A	04344		6.20	.2441		8.0		163		110		88		0.96	18	14
2XDCE2480A	04346		6.30	.2480		8.0		163		110		88		0.98	17	14
2XDCE2500A	04348	1/4	6.35	.2500	.3150	8.0	6.4	163	4.33	110	3.46	88	0.039	0.98	17	14
2XDCE2677A	04350		6.80	.2677		8.0		163		110		88		1.05	16	13
2XDCE2756A	04352		7.00	.2756		8.0		163		110		88		1.08	16	13
2XDCE2992A	04354		7.60	.2992		8.0		163		120		96		1.18	16	13
2XDCE3071A	04356		7.80	.3071		8.0		163		120		96		1.21	15	12
2XDCE3125A	04358	5/16	7.94	.3125	.3150	8.0	6.4	163	4.72	120	3.78	96	0.048	1.23	15	12
2XDCE3150A	04360		8.00	.3150		8.0		163		120		96		1.24	15	12
2XDCE3228A	04362		8.20	.3228		10.0		180		135		108		1.27	16	13
2XDCE3346A	04364		8.50	.3346		10.0		180		135		108		1.32	16	13
2XDCE3425A	04366		8.70	.3425		10.0		180		135		108		1.35	16	12
2XDCE3543A	04368		9.00	.3543		10.0		180		135		108		1.39	15	12
2XDCE3701A	04370		9.40	.3701		10.0		195		150		120		1.46	16	13
2XDCE3750A	04372	3/8	9.53	.3750	.3937	10.0	7.7	195	5.90	150	4.72	120	0.058	1.48	16	13
2XDCE3858A	04374		9.80	.3858		10.0		195		150		120		1.52	15	12
2XDCE3937A	04376		10.00	.3937		10.0		195		150		120		1.55	15	12
2XDCE4055A	04378		10.30	.4055		12.0		210		160		128		1.60	16	12
2XDCE4134A	04380		10.50	.4134		12.0		210		160		128		1.63	15	12
2XDCE4252A	04382		10.80	.4252		12.0		210		160		128		1.67	15	12
2XDCE4331A	04384		11.00	.4331		12.0		210		160		128		1.70	15	12
2XDCE4375A	04386	7/16	11.11	.4375	.4724	12.0	8.3	210	6.30	160	5.04	128	0.068	1.72	14	12
2XDCE4527A	04388		11.50	.4527		12.0		210		160		128		1.78	14	11
2XDCE4646A	04390		11.80	.4646		12.0		210		160		128		1.83	14	11
2XDCE4724A	04392		12.00	.4724		12.0		210		160		128		1.86	13	11
2XDCE5000A	04394	1/2	12.70	.5000	.5512	14.0	9.1	230	7.09	180	5.67	144	0.077	1.97	14	11

Inch		
D1	Tolerance (h7)	
.1968 - .2362	+0/-.00047	
.2363 - .3937	+0/-.00059	
.3938 - .5000	+0/-.00071	

Inch		
D2	Tolerance (h6)	
.1968 - .2362	+0/-.00031	
.2363 - .3937	+0/-.00035	
.3938 - .5000	+0/-.00043	

Metric (mm)		
D1	Tolerance (h7)	
5.0 - 6.0	+0/-.012	
6.01 - 10.0	+0/-.015	
10.01 - 12.0	+0/-.018	

Metric (mm)		
D2	Tolerance (h6)	
5.0 - 6.0	+0/-.008	
6.01 - 10.0	+0/-.009	
10.01 - 12.0	+0/-.011	



Twister® Spot Drill Series 200S

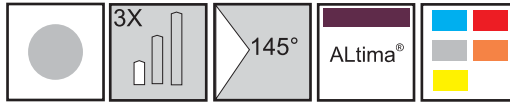

Spot Drills for High Performance Drills

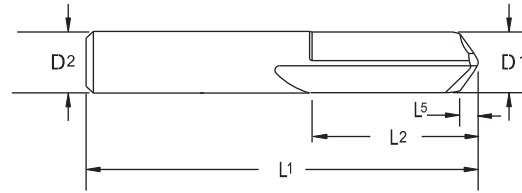

Tool No.	EDP	Diameter			Shank		OAL		Flute Length		Point Length	
		D1 (h7)			D2 (h6)		L1		L2		L5	
		Inch	mm	Decimal	Inch	mm	Inch	mm	Inch	mm	Inch	mm
200S11810A	20221		3.0	.1181		3.0		38		16		0.41
200S12500A	20230	1/8		.1250	1/8		1-1/2		5/8			0.017
200S23620A	20431		6.0	.2362		6.0		51		19		0.83
200S25000A	20452	1/4		.2500	1/4		2		3/4			0.034
200S31250A	20542	5/16		.3125	5/16		2-1/2		3/4			0.043
200S31500A	20545		8.0	.3150		8.0		64		19		1.10
200S37500A	20623	3/8		.3750	3/8		2-1/2		1			0.052
200S39370A	20647		10.0	.3937		10.0		70		25		1.38
200S47240A	20731		12.0	.4724		12.0		76		25		1.65
200S50000A	20740	1/2		.5000	1/2		3		1			0.069
200S62500A	20782	5/8		.6250	5/8		3-1/2		1-1/4			0.086
200S62990A	20785		16.0	.6299		16.0		89		32		2.20

Inch	
D1	Tolerance (h7)
.1182 - .2362	+0/- .00047
.2363 - .3937	+0/- .00059
.3938 - .6250	+0/- .00071

Inch	
D2	Tolerance (h6)
.1182 - .2362	+0/- .00031
.2363 - .3937	+0/- .00035
.3938 - .6250	+0/- .00043

Metric (mm)	
D1	Tolerance (h7)
3.0	+0/- .010
3.01 - 6.0	+0/- .012
6.01 - 10.0	+0/- .015
10.01 - 16.0	+0/- .018

Metric (mm)	
D2	Tolerance (h6)
3.0	+0/- .006
3.01 - 6.0	+0/- .008
6.01 - 10.0	+0/- .009
10.01 - 16.0	+0/- .011



Go Green with **RED BOX**



Extend the Life of Your Cutting Tools with M.A. Ford's Reconditioning Service.

See page 470 for more information or Call 800-553-8024 or 563-391-6220



Twister® GP Series 403

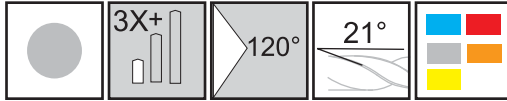

Designed for accurate spotting on NC machines. Solid carbide construction, short lengths and no body clearance make this a very rigid tool.

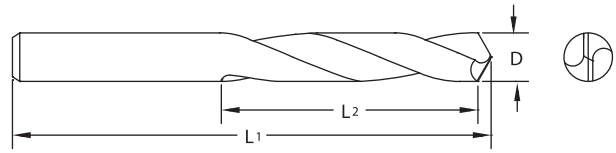

- Can be used at higher speeds and feeds, compatible with other carbide tooling.
- Easy to repoint because there is no web taper.

Tool No.	EDP	Diameter			OAL		Flute Length	
		D			L1		L2	
		Inch	mm	Decimal	Inch	mm	Inch	mm
40318750	40301	3/16		.1875	2		1	
40319680	40305		5.0	.1968		51		26.0
40323620	40309		6.0	.2362		51		26.0
40325000	40313	1/4		.2500	2		1	
40331250	40317	5/16		.3125	2-1/2		1	
40331500	40321		8.0	.3150		64		26.0
40337500	40325	3/8		.3750	2-1/2		1	
40339370	40329		10.0	.3937		70		30.0
40347240	40333		12.0	.4724		76		39.5
40350000	40337	1/2		.5000	3		1-9/16	

Inch	
D	Tolerance
.1875 - .5000	+.0000/- .0005

Metric (mm)	
D	Tolerance
5.00 - 12.00	+.0000/- .0130



Page 168

Twister® GP Series 404

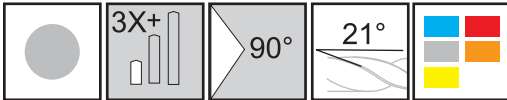

Designed for accurate spotting on NC machines. Solid carbide construction, short lengths and no body clearance make this a very rigid tool.

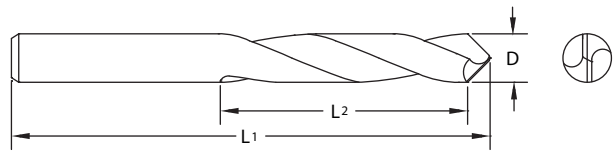

- Can be used at higher speeds and feeds, compatible with other carbide tooling.
- Easy to repoint because there is no web taper.

Tool No.	EDP	Diameter			OAL		Flute Length	
		D			L1		L2	
		Inch	mm	Decimal	Inch	mm	Inch	mm
40418750	40401	3/16		.1875	2		1	
40419680	40405		5.0	.1968		51		26.0
40423620	40409		6.0	.2362		51		26.0
40425000	40413	1/4		.2500	2		1	
40431250	40417	5/16		.3125	2-1/2		1	
40431500	40421		8.0	.3150		64		26.0
40437500	40425	3/8		.3750	2-1/2		1	
40439370	40429		10.0	.3937		70		30.0
40447240	40433		12.0	.4724		76		39.5
40450000	40437	1/2		.5000	3		1-9/16	

Inch	
D	Tolerance
.1875 - .5000	+.0000/- .0005

Metric (mm)	
D	Tolerance
5.00 - 12.00	+.0000/- .0130



Page 168

Twister® HPD Series HPDSR & HPDCR

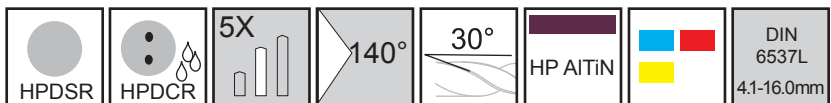

Designed for high performance drilling in a broad range of materials.



- Self centering point that eliminates the need for spot drilling
- h7 OD tolerance for precision holes
- HP AlTiN Coating provides high toughness with low friction
- 5X Diameter with solid and coolant through options
- 4.1mm-16.0mm manufactured to DIN 6537L

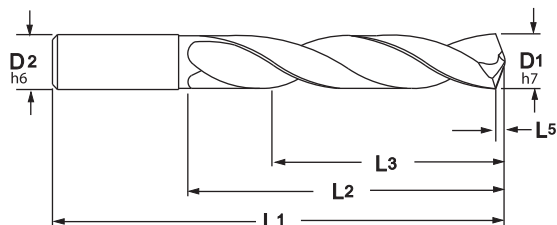

- h6 Shank OD Tolerance for shrink fit applications
- Material Applications: Carbon Steels, Austenitic Stainless Steels and Titanium
- An economical choice perfect for job shop and batch production work requiring a high performance drill option

HPDSR		HPDCR		Diameter		Shank	OAL	Flute Length	Drill Length	Point Length
Tool No.	EDP	Tool No.	EDP	D1 (h7)		D2 (h6)	L1	L2	L3	L5
				mm	Decimal	mm	mm	mm	mm	mm
HPDSR 0300A	21840	HPDCR 0300A	21700	3.0	.1181	3	66	28	23	0.46
HPDSR1200A	21972	HPDCR1200A	21628	3.05	.1200	4	66	28	23	0.47
HPDSR 0310A	21841	HPDCR 0310A	21701	3.1	.1220	4	66	28	23	0.48
HPDSR1250A	21973	HPDCR1250A	21629	3.18	.1250	4	66	28	23	0.49
HPDSR 0320A	21842	HPDCR 0320A	21702	3.2	.1260	4	66	28	23	0.49
HPDSR1285A	21974	HPDCR1285A	21630	3.26	.1285	4	66	28	23	0.50
HPDSR 0330A	21843	HPDCR 0330A	21703	3.3	.1299	4	66	28	23	0.51
HPDSR 0340A	21844	HPDCR 0340A	21704	3.4	.1339	4	66	28	23	0.52
HPDSR1360A	21975	HPDCR1360A	21631	3.45	.1360	4	66	28	23	0.53
HPDSR 0350A	21845	HPDCR 0350A	21705	3.5	.1378	4	66	28	23	0.54
HPDSR 0360A	21846	HPDCR 0360A	21706	3.6	.1417	4	66	28	23	0.55
HPDSR 0370A	21847	HPDCR 0370A	21707	3.7	.1457	4	66	28	23	0.57
HPDSR 0380A	21848	HPDCR 0380A	21708	3.8	.1496	4	74	36	29	0.58
HPDSR 0390A	21849	HPDCR 0390A	21709	3.9	.1535	4	74	36	29	0.60
HPDSR1562A	21976	HPDCR1562A	21632	3.97	.1562	4	74	36	29	0.61
HPDSR 0400A	21850	HPDCR 0400A	21710	4.0	.1575	4	74	36	29	0.61
HPDSR1590A	21977	HPDCR1590A	21633	4.04	.1590	6	74	36	29	0.62
HPDSR 0410A	21851	HPDCR 0410A	21711	4.1	.1614	6	74	36	29	0.64
HPDSR 0420A	21852	HPDCR 0420A	21712	4.2	.1654	6	74	36	29	0.64
HPDSR 0430A	21853	HPDCR 0430A	21713	4.3	.1693	6	74	36	29	0.66
HPDSR 0440A	21854	HPDCR 0440A	21714	4.4	.1732	6	74	36	29	0.67
HPDSR 0450A	21855	HPDCR 0450A	21715	4.5	.1772	6	74	36	29	0.69
HPDSR 0460A	21856	HPDCR 0460A	21716	4.6	.1811	6	74	36	29	0.71
HPDSR 0470A	21857	HPDCR 0470A	21717	4.7	.1850	6	74	36	29	0.72

Inch		Inch		Metric (mm)		Metric (mm)	
D1	Tolerance (h7)	D2	Tolerance (h6)	D1	Tolerance (h7)	D2	Tolerance (h6)
.0000 - .1181	+0/-.00039	.0000 - .1181	+0/-.00024	0 - 3	+0/-.010	0 - 3	+0/-.006
.1182 - .2362	+0/-.00047	.1182 - .2362	+0/-.00031	3.01 - 6	+0/-.012	3.01 - 6	+0/-.008
.2363 - .3937	+0/-.00059	.2363 - .3937	+0/-.00035	6.01 - 10.0	+0/-.015	6.01 - 10.0	+0/-.009
.3938 - .6250	+0/-.00071	.3938 - .6250	+0/-.00043	10.01 - 16.0	+0/-.018	10.01 - 16.0	+0/-.011



Series HPDSR & HPDCR Continued

HPDSR		HPDCR		Diameter		Shank	OAL	Flute Length	Drill Length	Point Length
Tool No.	EDP	Tool No.	EDP	D1 (h7)		D2 (h6)	L1	L2	L3	L5
				mm	Decimal	mm	mm	mm	mm	mm
HPDSR1875A	21978	HPDCR1875A	21634	4.76	.1875	6	82	44	35	0.73
HPDSR 0480A	21858	HPDCR 0480A	21718	4.8	.1890	6	82	44	35	0.74
HPDSR 0490A	21859	HPDCR 0490A	21719	4.9	.1929	6	82	44	35	0.75
HPDSR 0500A	21860	HPDCR 0500A	21720	5.0	.1968	6	82	44	35	0.77
HPDSR 0510A	21861	HPDCR 0510A	21721	5.1	.2008	6	82	44	35	0.78
HPDSR2031A	21979	HPDCR2031A	21635	5.16	.2031	6	82	44	35	0.79
HPDSR 0520A	21862	HPDCR 0520A	21722	5.2	.2047	6	82	44	35	0.80
HPDSR 0530A	21863	HPDCR 0530A	21723	5.3	.2087	6	82	44	35	0.81
HPDSR 0540A	21864	HPDCR 0540A	21724	5.4	.2126	6	82	44	35	0.83
HPDSR 0550A	21865	HPDCR 0550A	21725	5.5	.2165	6	82	44	35	0.84
HPDSR2187A	21980	HPDCR2187A	21636	5.55	.2187	6	82	44	35	0.85
HPDSR 0560A	21866	HPDCR 0560A	21726	5.6	.2205	6	82	44	35	0.86
HPDSR 0570A	21867	HPDCR 0570A	21727	5.7	.2244	6	82	44	35	0.87
HPDSR 0580A	21868	HPDCR 0580A	21728	5.8	.2283	6	82	44	35	0.89
HPDSR 0590A	21869	HPDCR 0590A	21729	5.9	.2323	6	82	44	35	0.90
HPDSR 0600A	21870	HPDCR 0600A	21730	6.0	.2362	6	82	44	35	0.92
HPDSR 0610A	21871	HPDCR 0610A	21731	6.1	.2402	8	91	53	43	0.94
HPDSR 0620A	21872	HPDCR 0620A	21732	6.2	.2441	8	91	53	43	0.95
HPDSR 0630A	21873	HPDCR 0630A	21733	6.3	.2480	8	91	53	43	0.97
HPDSR2500A	21981	HPDCR2500A	21637	6.35	.2500	8	91	53	43	0.97
HPDSR 0640A	21874	HPDCR 0640A	21734	6.4	.2520	8	91	53	43	0.98
HPDSR 0650A	21875	HPDCR 0650A	21735	6.5	.2559	8	91	53	43	1.00
HPDSR2570A	21982	HPDCR2570A	21638	6.53	.2570	8	91	53	43	1.00
HPDSR 0660A	21876	HPDCR 0660A	21736	6.6	.2598	8	91	53	43	1.01
HPDSR 0670A	21877	HPDCR 0670A	21737	6.7	.2638	8	91	53	43	1.03
HPDSR 0680A	21878	HPDCR 0680A	21738	6.8	.2677	8	91	53	43	1.04
HPDSR 0690A	21879	HPDCR 0690A	21739	6.9	.2717	8	91	53	43	1.06
HPDSR 0700A	21880	HPDCR 0700A	21740	7.0	.2756	8	91	53	43	1.07
HPDSR 0710A	21881	HPDCR 0710A	21741	7.1	.2795	8	91	53	43	1.09
HPDSR2812A	21983	HPDCR2812A	21639	7.14	.2812	8	91	53	43	1.10
HPDSR 0720A	21882	HPDCR 0720A	21742	7.2	.2835	8	91	53	43	1.10
HPDSR 0730A	21883	HPDCR 0730A	21743	7.3	.2874	8	91	53	43	1.12
HPDSR 0740A	21884	HPDCR 0740A	21744	7.4	.2913	8	91	53	43	1.13
HPDSR 0750A	21885	HPDCR 0750A	21745	7.5	.2953	8	91	53	43	1.15
HPDSR 0760A	21886	HPDCR 0760A	21746	7.6	.2992	8	91	53	43	1.17
HPDSR 0770A	21887	HPDCR 0770A	21747	7.7	.3031	8	91	53	43	1.18
HPDSR 0780A	21888	HPDCR 0780A	21748	7.8	.3071	8	91	53	43	1.20
HPDSR 0790A	21889	HPDCR 0790A	21749	7.9	.3110	8	91	53	43	1.21
HPDSR3125A	21984	HPDCR3125A	21640	7.94	.3125	8	91	53	43	1.22
HPDSR 0800A	21890	HPDCR 0800A	21750	8.0	.3150	8	91	53	43	1.23
HPDSR 0810A	21891	HPDCR 0810A	21751	8.1	.3189	10	103	61	49	1.24
HPDSR 0820A	21892	HPDCR 0820A	21752	8.2	.3228	10	103	61	49	1.26



Series HPDSR & HPDCR Continued

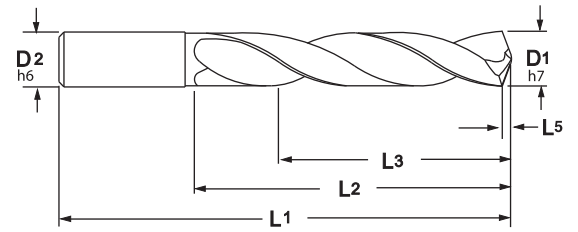
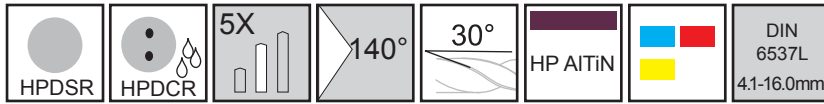

HPDSR		HPDCR		Diameter		Shank	OAL	Flute Length	Drill Length	Point Length
Tool No.	EDP	Tool No.	EDP	D1 (h7)	D2 (h6)	L1	L2	L3	L5	
				mm	Decimal	mm	mm	mm	mm	mm
HPDSR 0830A	21893	HPDCR 0830A	21753	8.3	.3268	10	103	61	49	1.27
HPDSR 0840A	21894	HPDCR 0840A	21754	8.4	.3307	10	103	61	49	1.29
HPDSR 0850A	21895	HPDCR 0850A	21755	8.5	.3346	10	103	61	49	1.30
HPDSR 0860A	21896	HPDCR 0860A	21756	8.6	.3386	10	103	61	49	1.32
HPDSR 0870A	21897	HPDCR 0870A	21757	8.7	.3425	10	103	61	49	1.33
HPDSR 0880A	21898	HPDCR 0880A	21758	8.8	.3465	10	103	61	49	1.35
HPDSR 0890A	21899	HPDCR 0890A	21759	8.9	.3504	10	103	61	49	1.36
HPDSR 0900A	21900	HPDCR 0900A	21760	9.0	.3543	10	103	61	49	1.38
HPDSR 0910A	21901	HPDCR 0910A	21761	9.1	.3583	10	103	61	49	1.40
HPDSR 0920A	21902	HPDCR 0920A	21762	9.2	.3622	10	103	61	49	1.41
HPDSR 0930A	21903	HPDCR 0930A	21763	9.3	.3661	10	103	61	49	1.43
HPDSR 0940A	21904	HPDCR 0940A	21764	9.4	.3701	10	103	61	49	1.44
HPDSR 0950A	21905	HPDCR 0950A	21765	9.5	.3740	10	103	61	49	1.46
HPDSR3750A	21985	HPDCR3750A	21641	9.53	.3750	10	103	61	49	1.46
HPDSR 0960A	21906	HPDCR 0960A	21766	9.6	.3780	10	103	61	49	1.47
HPDSR 0970A	21907	HPDCR 0970A	21767	9.7	.3819	10	103	61	49	1.49
HPDSR 0980A	21908	HPDCR 0980A	21768	9.8	.3858	10	103	61	49	1.50
HPDSR 0990A	21909	HPDCR 0990A	21769	9.9	.3898	10	103	61	49	1.52
HPDSR 1000A	21910	HPDCR 1000A	21770	10.0	.3937	10	103	61	49	1.53
HPDSR 1010A	21911	HPDCR 1010A	21771	10.1	.3976	12	118	71	56	1.55
HPDSR 1020A	21912	HPDCR 1020A	21772	10.2	.4016	12	118	71	56	1.56
HPDSR 1030A	21913	HPDCR 1030A	21773	10.3	.4055	12	118	71	56	1.58
HPDSR 1040A	21914	HPDCR 1040A	21774	10.4	.4094	12	118	71	56	1.59
HPDSR 1050A	21915	HPDCR 1050A	21775	10.5	.4134	12	118	71	56	1.61
HPDSR 1060A	21916	HPDCR 1060A	21776	10.6	.4173	12	118	71	56	1.63
HPDSR 1070A	21917	HPDCR 1070A	21777	10.7	.4213	12	118	71	56	1.64
HPDSR 1080A	21918	HPDCR 1080A	21778	10.8	.4252	12	118	71	56	1.66
HPDSR 1090A	21919	HPDCR 1090A	21779	10.9	.4291	12	118	71	56	1.67
HPDSR 1100A	21920	HPDCR 1100A	21780	11.0	.4331	12	118	71	56	1.69
HPDSR 1110A	21921	HPDCR 1110A	21781	11.1	.4370	12	118	71	56	1.70
HPDSR4375A	21986	HPDCR4375A	21642	11.11	.4375	12	118	71	56	1.70
HPDSR 1120A	21922	HPDCR 1120A	21782	11.2	.4409	12	118	71	56	1.72
HPDSR 1130A	21923	HPDCR 1130A	21783	11.3	.4449	12	118	71	56	1.73
HPDSR 1140A	21924	HPDCR 1140A	21784	11.4	.4488	12	118	71	56	1.75
HPDSR 1150A	21925	HPDCR 1150A	21785	11.5	.4527	12	118	71	56	1.76
HPDSR 1160A	21926	HPDCR 1160A	21786	11.6	.4567	12	118	71	56	1.78
HPDSR 1170A	21927	HPDCR 1170A	21787	11.7	.4606	12	118	71	56	1.79
HPDSR 1180A	21928	HPDCR 1180A	21788	11.8	.4646	12	118	71	56	1.81



Series HPDSR & HPDCR Continued

HPDSR		HPDCR		Diameter		Shank	OAL	Flute Length	Drill Length	Point Length
Tool No.	EDP	Tool No.	EDP	D1 (h7)	D2 (h6)	L1	L2	L3	L5	
mm	Decimal	mm	mm	mm	mm	mm	mm	mm	mm	
HPDSR 1190A	21929	HPDCR 1190A	21789	11.9	.4685	12	118	71	56	1.82
HPDSR 1200A	21930	HPDCR 1200A	21790	12.0	.4724	12	118	71	56	1.84
HPDSR 1210A	21989	HPDCR 1210A	21645	12.1	.4764	14	124	77	60	1.86
HPDSR 1220A	21990	HPDCR 1220A	21646	12.2	.4803	14	124	77	60	1.87
HPDSR 1230A	21991	HPDCR 1230A	21647	12.3	.4842	14	124	77	60	1.89
HPDSR 1240A	21992	HPDCR 1240A	21648	12.4	.4882	14	124	77	60	1.90
HPDSR 1250A	21933	HPDCR 1250A	21793	12.5	.4921	14	124	77	60	1.92
HPDSR 1260A	21993	HPDCR 1260A	21649	12.6	.4961	14	124	77	60	1.93
HPDSR5000A	21987	HPDCR5000A	21643	12.7	.5000	14	124	77	60	1.95
HPDSR 1280A	21935	HPDCR 1280A	21795	12.8	.5039	14	124	77	60	1.96
HPDSR 1290A	21994	HPDCR 1290A	21650	12.9	.5079	14	124	77	60	1.98
HPDSR 1300A	21939	HPDCR 1300A	21799	13.0	.5118	14	124	77	60	1.99
HPDSR 1310A	21995	HPDCR 1310A	21651	13.1	.5157	14	124	77	60	2.01
HPDSR 1320A	21996	HPDCR 1320A	21652	13.2	.5197	14	124	77	60	2.02
HPDSR 1330A	21997	HPDCR 1330A	21653	13.3	.5236	14	124	77	60	2.04
HPDSR 1340A	21998	HPDCR 1340A	21654	13.4	.5276	14	124	77	60	2.05
HPDSR 1350A	21940	HPDCR 1350A	21800	13.5	.5315	14	124	77	60	2.07
HPDSR 1360A	21999	HPDCR 1360A	21655	13.6	.5354	14	124	77	60	2.09
HPDSR 1370A	22000	HPDCR 1370A	21656	13.7	.5394	14	124	77	60	2.10
HPDSR 1380A	21945	HPDCR 1380A	21805	13.8	.5433	14	124	77	60	2.12
HPDSR 1390A	22001	HPDCR 1390A	21657	13.9	.5472	14	124	77	60	2.13
HPDSR 1400A	21950	HPDCR 1400A	21810	14.0	.5512	14	124	77	60	2.15
HPDSR 1410A	22002	HPDCR 1410A	21658	14.1	.5551	16	133	83	63	2.16
HPDSR 1420A	22003	HPDCR 1420A	21659	14.2	.5591	16	133	83	63	2.18
HPDSR 1430A	22004	HPDCR 1430A	21660	14.3	.5630	16	133	83	63	2.19
HPDSR 1440A	22005	HPDCR 1440A	21661	14.4	.5669	16	133	83	63	2.21
HPDSR 1450A	21955	HPDCR 1450A	21815	14.5	.5709	16	133	83	63	2.22
HPDSR 1460A	22006	HPDCR 1460A	21662	14.6	.5748	16	133	83	63	2.24
HPDSR 1470A	22007	HPDCR 1470A	21663	14.7	.5787	16	133	83	63	2.25
HPDSR 1480A	21960	HPDCR 1480A	21820	14.8	.5827	16	133	83	63	2.27
HPDSR 1490A	22008	HPDCR 1490A	21664	14.9	.5866	16	133	83	63	2.28
HPDSR 1500A	21963	HPDCR 1500A	21823	15.0	.5905	16	133	83	63	2.30
HPDSR 1510A	22009	HPDCR 1510A	21665	15.1	.5945	16	133	83	63	2.32
HPDSR 1520A	22010	HPDCR 1520A	21666	15.2	.5984	16	133	83	63	2.33
HPDSR 1530A	22011	HPDCR 1530A	21667	15.3	.6024	16	133	83	63	2.35
HPDSR 1540A	22012	HPDCR 1540A	21668	15.4	.6063	16	133	83	63	2.36
HPDSR 1550A	21965	HPDCR 1550A	21825	15.5	.6102	16	133	83	63	2.38
HPDSR 1560A	22014	HPDCR 1560A	21669	15.6	.6142	16	133	83	63	2.39
HPDSR 1570A	22015	HPDCR 1570A	21670	15.7	.6181	16	133	83	63	2.41
HPDSR 1580A	21968	HPDCR 1580A	21828	15.8	.6220	16	133	83	63	2.42
HPDSR6250A	21988	HPDCR6250A	21644	15.88	.6250	16	133	83	63	2.43
HPDSR 1590A	22016	HPDCR 1590A	21671	15.9	.6260	16	133	83	63	2.44
HPDSR 1600A	21970	HPDCR 1600A	21830	16.0	.6299	16	133	83	63	2.45



Twister® MD Series 2MDCL



Designed for high performance drilling in a broad range of materials.



• mm sizes only

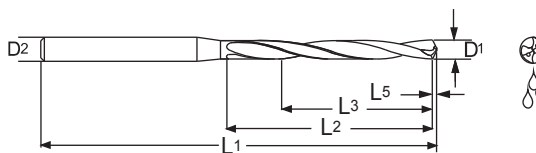

Tool No.	EDP	Diameter		Shank	OAL	Flute Length	Drill Length	Point Length
		D1 (h8)						
		mm	Decimal	L1	L2	L3 Ref.	L5	
2MDCL0787A	04198	2.00	.0787	3.0	74	24	18	0.31
2MDCL0807A	04200	2.05	.0807	3.0	74	28	21	0.32
2MDCL0827A	04202	2.10	.0827	3.0	74	28	21	0.33
2MDCL0846A	04204	2.15	.0846	3.0	74	28	21	0.33
2MDCL0866A	04206	2.20	.0866	3.0	74	28	21	0.34
2MDCL0886A	04208	2.25	.0886	3.0	74	28	21	0.35
2MDCL0906A	04210	2.30	.0906	3.0	74	28	21	0.36
2MDCL0925A	04212	2.35	.0925	3.0	74	28	21	0.36
2MDCL0945A	04214	2.40	.0945	3.0	74	28	21	0.37
2MDCL0965A	04216	2.45	.0965	3.0	74	28	21	0.38
2MDCL0984A	04218	2.50	.0984	3.0	74	28	21	0.39
2MDCL1004A	04220	2.55	.1004	3.0	81	34	25.5	0.40
2MDCL1024A	04222	2.60	.1024	3.0	81	34	25.5	0.40
2MDCL1043A	04224	2.65	.1043	3.0	81	34	25.5	0.41
2MDCL1063A	04226	2.70	.1063	3.0	81	34	25.5	0.42
2MDCL1083A	04228	2.75	.1083	3.0	81	34	25.5	0.43
2MDCL1102A	04230	2.80	.1102	3.0	81	34	25.5	0.43
2MDCL1122A	04232	2.85	.1122	3.0	81	34	25.5	0.44
2MDCL1142A	04234	2.90	.1142	3.0	81	34	25.5	0.45
2MDCL1161A	04236	2.95	.1161	3.0	81	34	25.5	0.46



Page 153

Inch		Inch	
D1	Tolerance (h8)	D2	Tolerance (h6)
.0787 - .1161	+0000/-0.0055	.0787 - .1161	+0000/-0.0024

Metric (mm)		Metric (mm)	
D1	Tolerance (h8)	D2	Tolerance (h6)
2.00 - 2.95	+0000/-0.0140	2.00 - 2.95	+0000/-0.0060

Inch sizes available as specials.



Twister® HP Series 207CE

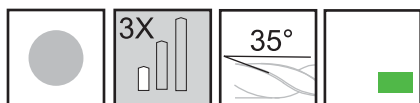

Designed for drilling Carbon Fiber Reinforced Polymer (CFRP), graphite and aramid fiber (kevlar) reinforced composite materials.

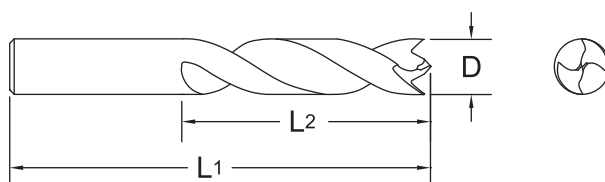

- No delamination.
- Eliminate fuzz or “fray” at exit.
- Brad and spur point.

Tool No.	EDP	Diameter				OAL		Flute Length	
		D				L1		L2	
		Inch	Wire	mm	Decimal	Inch	mm	Inch	mm
20709380CE	27005	3/32			.0938	1-3/4		1/2	
20709800CE	27014		40		.0980	1-13/16		1/2	
20710150CE	27023		38		.1015	1-13/16		1/2	
20712500CE	27068	1/8			.1250	1-7/8		5/8	
20712600CE	27071			3.20	.1260		48		16.0
20712850CE	27074		30		.1285	1-15/16		11/16	
20712990CE	27077			3.30	.1299		49		17.5
20713600CE	27083		29		.1360	1-15/16		11/16	
20714050CE	27089		28		.1405	1-15/16		11/16	
20715620CE	27122	5/32			.1562	2-1/16		3/4	
20715900CE	27131		21		.1590	2-1/8		7/8	
20716100CE	27134		20		.1610	2-1/8		7/8	
20716600CE	27143		19		.1660	2-1/8		7/8	
20718000CE	27167		15		.1800	2-3/16		15/16	
20718750CE	27179	3/16			.1875	2-3/16		15/16	
20719100CE	27188		11		.1910	2-1/4		1	
20719350CE	27194		10		.1935	2-1/4		1	
20719600CE	27197		9		.1960	2-1/4		1	
20720100CE	27209		7		.2010	2-1/4		1	
20720310CE	27212	13/64			.2031	2-1/4		1	
20720900CE	27227		4		.2090	2-3/8		1-1/16	
20721300CE	27233		3		.2130	2-3/8		1-1/16	
20721870CE	27239	7/32			.2187	2-3/8		1-1/16	
20722100CE	27245		2		.2210	2-7/16		1-1/8	
20722800CE	27251		1		.2280	2-7/16		1-1/8	
20723620CE	27266			6.00	.2362		64		32.0
20725000CE	27287	1/4	E		.2500	2-1/2		1-1/4	
20725190CE	27290			6.40	.2519		64		32.0
20725700CE	27296		F		.2570	2-5/8		1-5/16	
20726100CE	27299		G		.2610	2-5/8		1-5/16	
20726560CE	27302	17/64			.2656	2-5/8		1-5/16	
20726600CE	27305		H		.2660	2-11/16		1-3/8	
20727560CE	27311			7.00	.2756		68		35.0
20728100CE	27317		K		.2810	2-11/16		1-3/8	

Inch	
D	Tolerance
.0935 - .5000	+0.000/-0.005

Metric (mm)	
D	Tolerance
2.40 - 12.00	+0.000/-0.013

M.A. FORD® APG

CERAEge®

Hardness that makes it the 3rd hardest material when compared to industrial diamonds.

- Toughness that is comparable to Titanium.
- Lubricity that approaches Teflon.
- Extreme heat tolerance.
- Non-reactive to Titanium.

CERAEge® Coating Properties	
Microhardness (HV)	3400
Max. Service Temperature	1100° C / 2012° F
Friction Coefficient	0.25
Coating Thickness	2-3 microns
Color	Light Gray



Series 207CE Continued

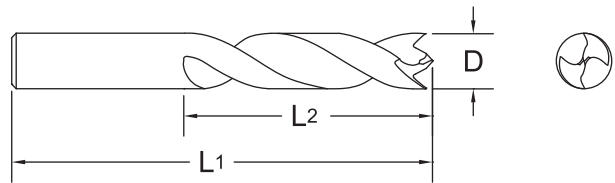
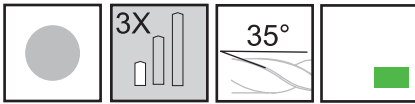

Tool No.	EDP	Diameter				OAL		Flute Length	
		D				L1		L2	
		Inch	Wire	mm	Decimal	Inch	mm	Inch	mm
20728120CE	27320	9/32			.2812	2-11/16		1-3/8	
20729000CE	27323		L		.2900	2-3/4		1-3/8	
20729500CE	27326		M		.2950	2-3/4		1-3/8	
20731250CE	27338	5/16			.3125	2-13/16		1-1/2	
20731500CE	27341			8.00	.3150		71		38.0
20737500CE	27383	3/8			.3750	3-1/8		1-5/8	
20739060CE	27392	25/64			.3906	3-1/4		1-3/4	
20740400CE	27401		Y		.4040	3-5/16		1-3/4	
20743750CE	27419	7/16			.4375	3-7/16		1-7/8	
20750000CE	27437	1/2			.5000	3-3/4		2-1/8	



Page 155



Twister® AL Series 229

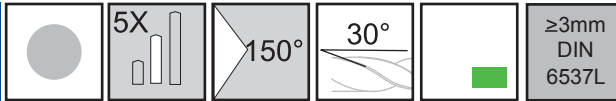

Twister® AL Series 229 recommended for increased speeds and feeds when drilling aluminum, cast iron and other easy to machine materials.



- Easily re-ground point design.
- Special 3 flute parabolic flute form for increased chip evacuation.
- Metric sizes 3mm and above manufactured to DIN 6537L.
- Coolant fed style available as a special.

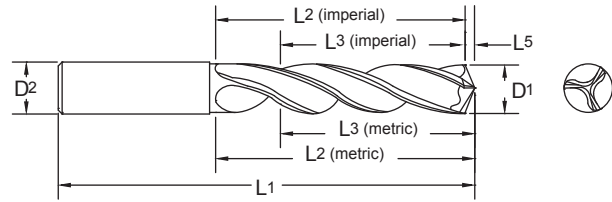

Tool No.	EDP	Diameter				Shank		OAL		Flute Length		Drill Length		Point Length	
		D1 (m7)				D2 (h6)		L1		L2		L3 Ref.		L5	
		Inch	Wire	mm	Decimal	Inch	mm	Inch	mm	Inch	mm	Inch	mm	Inch	mm
22904690	23050	3/64			.0469	3/64		1-1/2		3/4		9/16		0.006	
22905500	23051		54		.0550	.0550		1-1/2		3/4		9/16		0.007	
22905950	23052		53		.0595	.0595		1-1/2		3/4		9/16		0.007	
22906250	22900	1/16			.0625	1/16		1-1/2		3/4		9/16		0.008	
22906700	23054		51		.0670	.0670		1-1/2		3/4		9/16		0.008	
22907000	23055		50		.0700	.0700		1-3/4		7/8		11/16		0.008	
22907300	23056		49		.0730	.0730		1-3/4		7/8		11/16		0.009	
22907870	22950			2.00	.0787		2.0		38		16.0		12		0.24
22908200	23057		45		.0820	.0820		1-3/4		7/8		11/16		0.010	
22908900	22901		43		.0890	.0890		2		1		3/4		0.011	
22909060	23058			2.3	.0906		2.3		43		20.5		15		0.28
22909380	22902	3/32			.0938	3/32		2		1		3/4		0.011	
22909600	22903		41		.0960	.0960		2		1		3/4		0.012	
22909800	22904		40		.0980	.0980		2		1		3/4		0.012	
22909840	22951			2.50	.0984		2.5		43		20.5		15		0.30
22909950	23059		39		.0995	.0995		2-1/4		1-1/4		15/16		0.012	
22910150	22942		38		.1015	.1015		2-1/4		1-1/4		15/16		0.012	
22910400	23060		37		.1040	.1040		2-1/4		1-1/4		15/16		0.013	
22910650	22943		36		.1065	.1065		2-1/4		1-1/4		15/16		0.013	
22911000	23061		35		.1100	.1100		2-1/4		1-1/4		15/16		0.013	
22911300	22944		33		.1130	.1130		2-1/4		1-1/4		15/16		0.014	
22911420	22952			2.90	.1142		2.9		46		25.0		19		0.35
22911810	22953			3.00	.1181		6.0		66		28.0		23		0.36
22912000	22905		31		.1200	.1200		2-1/4		1-1/4		15/16		0.014	
22912200	23063			3.10	.1220		6.0		66		28.0		23		0.37
22912500	22906	1/8			.1250	1/8		2-1/4		1-1/4		15/16		0.015	

Inch			Metric (mm)		
D1	Tolerance (m7)		D1	Tolerance (m7)	
.0469 - .1250	+ .0001/+ .0004		2.00 - 3.00	+ .002/+ .012	
.1251 - .2500	+ .0002/+ .0006		3.01 - 6.00	+ .004/+ .016	
.2501 - .3750	+ .0003/+ .0008		6.01 - 10.00	+ .006/+ .021	
.3751 - .7500	+ .0003/+ .0010		10.01 - 16.00	+ .007/+ .025	



Series 229 Continued

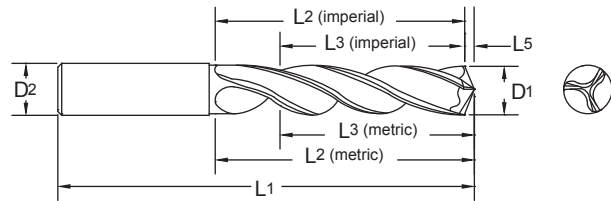
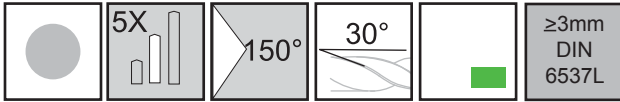

Tool No.	EDP	Diameter				Shank		OAL		Flute Length		Drill Length		Point Length	
		D1 (m7)				D2 (h6)		L1		L2		L3 Ref.		L5	
		Inch	Wire	mm	Decimal	Inch	mm	Inch	mm	Inch	mm	Inch	mm	Inch	mm
22912600	22945			3.20	.1260		6.0		66		28.0		23		0.39
22912850	22935		30		.1285	.1285		2-1/4		1-1/4		15/16		0.015	
22912990	22954			3.30	.1299		6.0		66		28.0		23		0.40
22913390	22949			3.40	.1339		6.0		66		28.0		23		0.41
22913600	22907		29		.1360	.1360		2-1/2		1-3/8		1-1/32		0.016	
22913780	22955			3.50	.1378		6.0		66		28.0		23		0.42
22914060	22908	9/64			.1406	9/64		2-1/2		1-3/8		1-1/32		0.017	
22914170	22992			3.60	.1417		6.0		66		28.0		23		0.43
22914400	22946		27		.1440	.1440		2-1/2		1-3/8		1-1/32		0.017	
22914570	22994			3.70	.1457		6.0		66		28.0		23		0.45
22914950	22973		25		.1495	.1495		2-1/2		1-3/8		1-1/32		0.018	
22914960	22996			3.80	.1496		6.0		74		36.0		29		0.46
22915200	23064		24		.1520	.1520		2-1/2		1-3/8		1-1/32		0.018	
22915350	22997			3.90	.1535		6.0		74		36.0		29		0.47
22915620	22909	5/32			.1562	5/32		2-1/2		1-3/8		1-1/32		0.019	
22915750	22956			4.00	.1575		6.0		74		36.0		29		0.48
22915900	22936		21		.1590	.1590		2-1/2		1-3/8		1-1/32		0.019	
22916100	22937		20		.1610	.1610		2-1/2		1-3/8		1-1/32		0.019	
22916140	22998			4.10	.1614		6.0		74		36.0		29		0.49
22916540	22957			4.20	.1654		6.0		74		36.0		29		0.51
22916600	22947		19		.1660	.1660		2-1/2		1-3/8		1-1/32		0.020	
22916950	22948		18		.1695	.1695		2-3/4		1-5/8		1-7/32		0.020	
22917190	22939	11/64			.1719	11/64		2-3/4		1-5/8		1-7/32		0.021	
22917300	22972		17		.1730	.1730		2-3/4		1-5/8		1-7/32		0.021	
22917320	22999			4.40	.1732		6.0		74		36.0		29		0.53
22917700	22910		16		.1770	.1770		2-3/4		1-5/8		1-7/32		0.021	
22917720	22958			4.50	.1772		6.0		74		36.0		29		0.54
22918110	23000			4.60	.1811		6.0		74		36.0		29		0.55
22918500	22911		13		.1850	.1850		2-3/4		1-5/8		1-7/32		0.022	
22918750	22912	3/16			.1875	3/16		2-3/4		1-5/8		1-7/32		0.023	
22918890	23001			4.80	.1889		6.0		82		44.0		35		0.58
22918900	22974		12		.1890	.1890		2-3/4		1-5/8		1-7/32		0.023	
22919100	22976		11		.1910	.1910		2-3/4		1-5/8		1-7/32		0.023	
22919290	23002			4.90	.1929		6.0		82		44.0		35		0.59
22919350	22938		10		.1935	.1935		2-3/4		1-5/8		1-7/32		0.023	
22919680	22959			5.00	.1968		6.0		82		44.0		35		0.60
22920100	22975		7		.2010	.2010		3		1-3/4		1-5/16		0.024	
22920470	23003			5.20	.2047		6.0		82		44.0		35		0.63
22921300	22977		3		.2130	.2130		3		1-3/4		1-5/16		0.026	



Series 229 Continued

Tool No.	EDP	Diameter				Shank		OAL		Flute Length		Drill Length		Point Length	
		D1 (m7)				D2 (h6)		L1		L2		L3 Ref.		L5	
		Inch	Wire	mm	Decimal	Inch	mm	Inch	mm	Inch	mm	Inch	mm	Inch	mm
22921650	22960			5.50	.2165		6.0		82		44.0		35		0.66
22921870	22913	7/32			.2187	7/32		3		1-3/4		1-5/16		0.026	
22922050	23004			5.60	.2205		6.0		82		44.0		35		0.68
22922800	22978		1		.2280	.2280		3		1-3/4		1-5/16		0.027	
22923400	23065		A		.2340	.2340		3-1/4		2		1-1/2		0.028	
22923620	22961			6.00	.2362		6.0		82		44.0		35		0.72
22924410	22980			6.20	.2441		8.0		91		53.0		43		0.75
22925000	22914	1/4			.2500	1/4		3-1/4		2		1-1/2		0.030	
22925590	22962			6.50	.2559		8.0		91		53.0		43		0.78
22925700	22915		F		.2570	.2570		3-1/4		2		1-1/2		0.031	
22926380	22979			6.70	.2638		8.0		91		53.0		43		0.81
22926560	22916	17/64			.2656	17/64		3-1/2		2-1/8		1-19/32		0.032	
22926770	22963			6.80	.2677		8.0		91		53.0		43		0.82
22927200	22981		I		.2720	.2720		3-1/2		2-1/8		1-19/32		0.033	
22927560	22964			7.00	.2756		8.0		91		53.0		43		0.84
22928120	22917	9/32			.2812	9/32		3-1/2		2-1/8		1-19/32		0.034	
22928350	23005			7.20	.2835		8.0		91		53.0		43		0.87
22928740	22940			7.30	.2874		8.0		91		53.0		43		0.88
22929130	22965			7.40	.2913		8.0		91		53.0		43		0.89
22929530	22966			7.50	.2953		8.0		91		53.0		43		0.90
22929690	22982	19/64			.2969	19/64		3-3/4		2-3/8		1-25/32		0.036	
22930710	23006			7.80	.3071		8.0		91		53.0		43		0.94
22931250	22918	5/16			.3125	5/16		3-3/4		2-3/8		1-25/32		0.038	
22931500	22967			8.00	.3150		8.0		91		53.0		43		0.96
22931890	23008			8.10	.3189		10.0		103		61.0		49		0.98
22932810	22919	21/64			.3281	21/64		4		2-1/2		1-7/8		0.040	
22933070	22985			8.40	.3307		10.0		103		61.0		49		1.01
22933200	22983		Q		.3320	.3320		4		2-1/2		1-7/8		0.040	
22933460	22968			8.50	.3346		10.0		103		61.0		49		1.02
22934380	22987	11/32			.3438	11/32		4		2-1/2		1-7/8		0.041	
22935430	22989			9.00	.3543		10.0		103		61.0		49		1.09
22935940	22984	23/64			.3594	23/64		4-1/4		2-3/4		2-1/16		0.043	
22936800	22991		U		.3680	.3680		4-1/4		2-3/4		2-1/16		0.044	
22937400	23009			9.50	.3740		10.0		103		61.0		49		1.15
22937500	22920	3/8			.3750	3/8		4-1/4		2-3/4		2-1/16		0.045	
22938190	23011			9.70	.3819		10.0		103		61.0		49		1.17
22939060	22921	25/64			.3906	25/64		4-1/2		2-7/8		2-5/32		0.047	
22939370	22969			10.00	.3937		10.0		103		61.0		49		1.21
22940160	22970			10.20	.4016		12.0		118		71.0		56		1.23
22940620	22922	13/32			.4062	13/32		4-1/2		2-7/8		2-5/32		0.049	
22940940	23012			10.40	.4094		12.0		118		71.0		56		1.25
22941340	22986			10.50	.4134		12.0		118		71.0		56		1.27
22941730	23013			10.60	.4173		12.0		118		71.0		56		1.28



Series 229 Continued

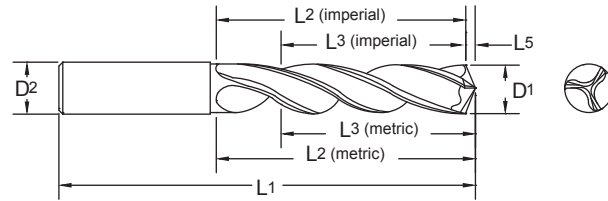
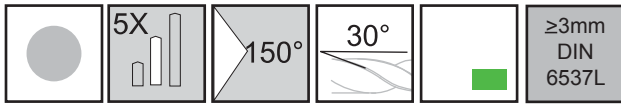

Tool No.	EDP	Diameter				Shank		OAL		Flute Length		Drill Length		Point Length	
		D1 (m7)				D2 (h6)		L1		L2		L3 Ref.		L5	
		Inch	Wire	mm	Decimal	Inch	mm	Inch	mm	Inch	mm	Inch	mm	Inch	mm
22942190	22923	27/64			.4219	27/64		4-1/2		2-7/8		2-5/32		0.051	
22943310	22993			11.00	.4331		12.0		118		71.0		56		1.33
22943750	22924	7/16			.4375	7/16		4-1/2		2-7/8		2-5/32		0.053	
22945280	23014			11.50	.4528		12.0		118		71.0		56		1.39
22945310	22941	29/64			.4531	29/64		4-3/4		3		2-1/4		0.055	
22946880	22995	15/32			.4688	15/32		4-3/4		3		2-1/4		0.057	
22947240	22971			12.00	.4724		12.0		118		71.0		56		1.45
22948440	22925	31/64			.4844	31/64		4-3/4		3		2-1/4		0.058	
22949210	22988			12.50	.4921		14.0		124		77.0		60		1.51
22950000	22926	1/2			.5000	1/2		4-3/4		3		2-1/4		0.060	
22951180	23015			13.00	.5118		14.0		124		77.0		60		1.57
22951560	22927	33/64			.5156	33/64		5		3-1/4		2-7/16		0.062	
22953120	22928	17/32			.5312	17/32		5		3-1/4		2-7/16		0.064	
22953150	23017			13.50	.5315		14.0		124		77.0		60		1.63
22954690	22929	35/64			.5469	35/64		5		3-1/4		2-7/16		0.066	
22955120	23018			14.00	.5512		14.0		124		77.0		60		1.69
22956250	22930	9/16			.5625	9/16		5		3-1/4		2-7/16		0.068	
22957090	23020			14.50	.5709		16.0		133		83.0		63		1.75
22959060	23021			15.00	.5906		16.0		133		83.0		63		1.81
22961020	23022			15.50	.6102		16.0		133		83.0		63		1.87
22962200	23023			15.80	.6220		16.0		133		83.0		63		1.90
22962500	22931	5/8			.6250	5/8		5-1/4		3-1/2		2-5/8		0.075	
22962990	23024			16.00	.6299		16.0		133		83.0		63		1.93
22965620	22932	21/32			.6562	21/32		5-1/2		3-5/8		2-23/32		0.079	
22968750	22933	11/16			.6875	11/16		5-1/2		3-5/8		2-23/32		0.083	
22975000	22934	3/4			.7500	3/4		5-3/4		3-7/8		2-29/32		0.090	



Twister® Micro-Tuff® Series 305

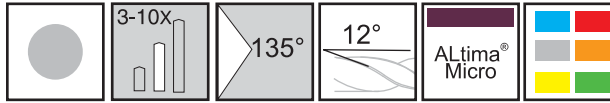

Designed for high performance drilling in a broad range of materials.



• Depth setting rings available on 1/8" shank tools.

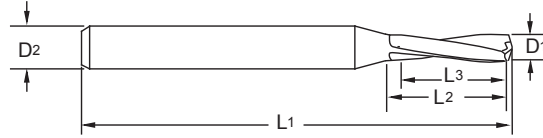

Uncoated		ALtima® Micro		Diameter				Shank		OAL		Flute Length max.*		Drill Length	
Tool No.	EDP	Tool No.	EDP	D1				D2		L1		L2		L3 Ref.	
				Inch	Letter/Wire	mm	Decimal	Inch	mm	Inch	mm	Inch	mm	Inch	mm
30500390	33999				102		0.0039	1/8		1-1/2		0.065		0.05	
305M0010	34000					0.1	0.0039		3.0		38		1.70		1.28
30500430	34001				101		0.0043	1/8		1-1/2		0.065		0.05	
305M0011	33900					0.11	0.0043		3.0		38		1.70		1.28
30500470	34002				100		0.0047	1/8		1-1/2		0.065		0.05	
305M0012	33901					0.12	0.0047		3.0		38		1.70		1.28
30500510	34003				99		0.0051	1/8		1-1/2		0.065		0.05	
305M0013	33902					0.13	0.0051		3.0		38		1.70		1.28
30500550	34004				98		0.0055	1/8		1-1/2		0.065		0.05	
305M0014	33903					0.14	0.0055		3.0		38		1.70		1.28
305M0015	34005					0.15	0.0059		3.0		38		2.50		1.88
30500600	34006						0.0060	1/8		1-1/2		0.100		0.08	
305M0016	33904					0.16	0.0063		3.0		38		2.50		1.88
30500630	34007				96		0.0063	1/8		1-1/2		0.100		0.08	
305M0017	33905					0.17	0.0067		3.0		38		2.50		1.88
30500670	34008				95		0.0067	1/8		1-1/2		0.100		0.08	
30500700	34009						0.0070	1/8		1-1/2		0.100		0.08	
305M0018	33906					0.18	0.0071		3.0		38		2.50		1.88
30500710	34010				94		0.0071	1/8		1-1/2		0.100		0.08	
305M0019	33907					0.19	0.0075		3.0		38		2.50		1.88
30500750	34011				93		0.0075	1/8		1-1/2		0.100		0.08	
305M0020	34012					0.20	0.0078		3.0		38		2.50		1.88
30500790	34013				92		0.0079	1/8		1-1/2		0.125		0.09	
30500800	34014						0.0080	1/8		1-1/2		0.125		0.09	
305M0021	33908					0.21	0.0083		3.0		38		2.50		1.88
30500830	34015				91		0.0083	1/8		1-1/2		0.125		0.09	
305M0022	33909					0.22	0.0087		3.0		38		2.50		1.88
30500870	34016				90		0.0087	1/8		1-1/2		0.125		0.09	
30500900	34017						0.0090	1/8		1-1/2		0.125		0.09	
305M0023	33910					0.23	0.0091		3.0		38		2.50		1.88
30500910	34018				89		0.0091	1/8		1-1/2		0.125		0.09	
305M0024	33911					0.24	0.0094		3.0		38		2.50		1.88

*Do not drill beyond specified flute length. Peck cycles may be utilized to achieve best tool performance.

Inch			
D1	Tolerance	D2	Tolerance
.0039 - .1250	+0/-0.0003	.0039 - .1250	+0/-0.0002
L1	Tolerance	L2	Tolerance
.0039 - .1250	+/-0.015	.0039 - .1250	+0.015/-0

Metric (mm)			
D1	Tolerance	D2	Tolerance
0.1 - 3.0	+0/-0.008	0.1 - 3.0	+0/-0.005
L1	Tolerance	L2	Tolerance
0.1 - 3.0	+/-0.4	0.1 - 3.0	+0.4/-0



Series 305 Continued

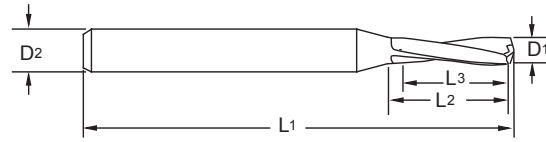
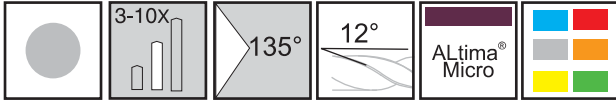

Uncoated		ALtima® Micro		Diameter				Shank		OAL		Flute Length max.*		Drill Length	
Tool No.	EDP	Tool No.	EDP	D1				D2		L1		L2		L3 Ref.	
Tool No.	EDP	Tool No.	EDP	Inch	Letter/ Wire	mm	Decimal	Inch	mm	Inch	mm	Inch	mm	Inch	mm
30500950	34019				88		0.0095	1/8		1-1/2		0.125		0.09	
305M0025	34020					0.25	0.0098		3.0		38		3.20		2.40
30501000	34021				87		0.0100	1/8		1-1/2		0.150		0.11	
305M0026	33912					0.26	0.0102		3.0		38		3.20		2.40
30501050	34022				86		0.0105	1/8		1-1/2		0.150		0.11	
305M0027	33913					0.27	0.0106		3.0		38		3.20		2.40
30501100	34023				85		0.0110	1/8		1-1/2		0.150		0.11	
305M0028	33914					0.28	0.0110		3.0		38		3.20		2.40
305M0029	33915					0.29	0.0114		3.0		38		3.20		2.40
30501150	34024				84		0.0115	1/8		1-1/2		0.150		0.11	
305M0030	34025	305M0030AM	34206			0.30	0.0118		3.0		38		4.80		3.60
30501200	34026	30501200AM	34145		83		0.0120	1/8		1-1/2		0.190		0.14	
305M0031	33916					0.31	0.0122		3.0		38		4.80		3.60
30501250	34027	30501250AM	34146		82		0.0125	1/8		1-1/2		0.190		0.14	
305M0032	33917					0.32	0.0126		3.0		38		4.80		3.60
305M0033	33918					0.33	0.0130		3.0		38		4.80		3.60
30501300	34028	30501300AM	34147		81		0.0130	1/8		1-1/2		0.190		0.14	
305M0034	33919					0.34	0.0134		3.0		38		4.80		3.60
30501350	34029	30501350AM	34148		80		0.0135	1/8		1-1/2		0.190		0.14	
305M0035	34030	305M0035AM	34207			0.35	0.0138		3.0		38		4.80		3.60
305M0036	33920					0.36	0.0142		3.0		38		4.80		3.60
30501450	34031	30501450AM	34149		79		0.0145	1/8		1-1/2		0.190		0.14	
305M0037	33921					0.37	0.0146		3.0		38		4.80		3.60
305M0038	33922					0.38	0.0150		3.0		38		4.80		3.60
305M0039	33923					0.39	0.0154		3.0		38		4.80		3.60
30501560	34032	30501560AM	34150	1/64			0.0156	1/8		1-1/2		0.190		0.14	
305M0040	34033	305M0040AM	34208			0.40	0.0157		3.0		38		4.80		3.60
30501600	34034	30501600AM	34151		78		0.0160	1/8		1-1/2		0.190		0.14	
305M0041	33924					0.41	0.0161		3.0		38		6.35		4.76
305M0042	33925					0.42	0.0165		3.0		38		6.35		4.76
305M0043	33926					0.43	0.0169		3.0		38		6.35		4.76
305M0044	33927					0.44	0.0173		3.0		38		6.35		4.76
305M0045	34035	305M0045AM	34209			0.45	0.0177		3.0		38		6.35		4.76
30501800	34036	30501800AM	34152		77		0.0180	1/8		1-1/2		0.250		0.19	
305M0046	33928					0.46	0.0181		3.0		38		6.35		4.76
305M0047	33929					0.47	0.0185		3.0		38		6.35		4.76
305M0048	33930					0.48	0.0189		3.0		38		6.35		4.76
305M0049	33931					0.49	0.0193		3.0		38		6.35		4.76

*Do not drill beyond specified flute length. Peck cycles may be utilized to achieve best tool performance.



Series 305 Continued

Uncoated		ALtima® Micro		Diameter				Shank		OAL		Flute Length max.*		Drill Length	
				D1				D2		L1		L2		L3 Ref.	
Tool No.	EDP	Tool No.	EDP	Inch	Letter/ Wire	mm	Decimal	Inch	mm	Inch	mm	Inch	mm	Inch	mm
305M0050	34037	305M0050AM	34210			0.50	0.0197		3.0		38		6.35		4.76
30502000	34038	30502000AM	34153		76		0.0200	1/8		1-1/2		0.250		0.19	
305M0051	33932					0.51	0.0201		3.0		38		6.35		4.76
305M0052	33933					0.52	0.0205		3.0		38		6.35		4.76
305M0053	33934					0.53	0.0209		3.0		38		6.35		4.76
30502100	34039	30502100AM	34154		75		0.0210	1/8		1-1/2		0.250		0.19	
305M0054	33935					0.54	0.0213		3.0		38		6.35		4.76
305M0055	34040	305M0055AM	34211			0.55	0.0217		3.0		38		6.35		4.76
305M0056	33936					0.56	0.0220		3.0		38		6.35		4.76
305M0057	33937					0.57	0.0224		3.0		38		6.35		4.76
30502250	34041	30502250AM	34155		74		0.0225	1/8		1-1/2		0.250		0.19	
305M0058	33938					0.58	0.0228		3.0		38		6.35		4.76
305M0059	33939					0.59	0.0232		3.0		38		6.35		4.76
305M0060	34042	305M0060AM	34212			0.60	0.0236		3.0		38		6.35		4.76
30502400	34043	30502400AM	34156		73		0.0240	1/8		1-1/2		0.250		0.19	
305M0061	33940					0.61	0.0240		3.0		38		6.35		4.76
305M0062	33941					0.62	0.0244		3.0		38		6.35		4.76
305M0063	33942					0.63	0.0248		3.0		38		6.35		4.76
30502500	34044	30502500AM	34157		72		0.0250	1/8		1-1/2		0.250		0.19	
305M0064	33943					0.64	0.0252		3.0		38		6.35		4.76
305M0065	34045	305M0065AM	34213			0.65	0.0256		3.0		38		6.35		4.76
305M0066	33944					0.66	0.0260		3.0		38		8.13		6.10
30502600	34046	30502600AM	34158		71		0.0260	1/8		1-1/2		0.250		0.19	
305M0067	33945					0.67	0.0264		3.0		38		8.13		6.10
305M0068	33946					0.68	0.0268		3.0		38		8.13		6.10
305M0069	33947					0.69	0.0272		3.0		38		8.13		6.10
305M0070	34047	305M0070AM	34214			0.70	0.0276		3.0		38		8.13		6.10
305M0071	33948					0.71	0.0280		3.0		38		8.13		6.10
30502800	34048	30502800AM	34159		70		0.0280	1/8		1-1/2		0.320		0.24	
305M0072	33949					0.72	0.0283		3.0		38		8.13		6.10
305M0073	33950					0.73	0.0287		3.0		38		8.13		6.10
305M0074	33951					0.74	0.0291		3.0		38		8.13		6.10
30502920	34049	30502920AM	34160		69		0.0292	1/8		1-1/2		0.320		0.24	
305M0075	34050	305M0075AM	34215			0.75	0.0295		3.0		38		8.13		6.10
305M0076	33952					0.76	0.0299		3.0		38		10.16		7.62
305M0077	33953					0.77	0.0303		3.0		38		10.16		7.62
305M0078	33954					0.78	0.0307		3.0		38		10.16		7.62
30503100	34051	30503100AM	34161		68		0.0310	1/8		1-1/2		0.400		0.30	
305M0079	33955					0.79	0.0311		3.0		38		10.16		7.62
30503120	34052	30503120AM	34162	1/32			0.0312	1/8		1-1/2		0.400		0.30	
305M0080	34053	305M0080AM	34216			0.80	0.0315		3.0		38		10.16		7.62

*Do not drill beyond specified flute length. Peck cycles may be utilized to achieve best tool performance.



Series 305 Continued

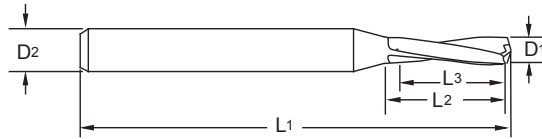
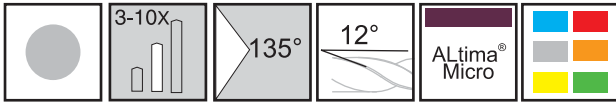

Uncoated		ALtima® Micro		Diameter				Shank		OAL		Flute Length max.*		Drill Length	
Tool No.	EDP	Tool No.	EDP	Inch	Letter/ Wire	mm	Decimal	Inch	mm	Inch	mm	Inch	mm	Inch	mm
305M0081	33956					0.81	0.0319		3.0		38		10.16		7.62
30503200	34054	30503200AM	34163		67		0.0320	1/8		1-1/2		0.400		0.30	
305M0082	33957					0.82	0.0323		3.0		38		10.16		7.62
305M0083	33958					0.83	0.0327		3.0		38		10.16		7.62
30503300	34055	30503300AM	34164		66		0.0330	1/8		1-1/2		0.400		0.30	
305M0084	33959					0.84	0.0331		3.0		38		10.16		7.62
305M0085	34056	305M0085AM	34217			0.85	0.0335		3.0		38		10.16		7.62
305M0086	33960					0.86	0.0339		3.0		38		10.16		7.62
305M0087	33961					0.87	0.0343		3.0		38		10.16		7.62
305M0088	33962					0.88	0.0346		3.0		38		10.16		7.62
30503500	34057	30503500AM	34165		65		0.0350	1/8		1-1/2		0.400		0.30	
305M0089	33963					0.89	0.0350		3.0		38		10.16		7.62
305M0090	34058	305M0090AM	34218			0.90	0.0354		3.0		38		10.16		7.62
305M0091	33964					0.91	0.0358		3.0		38		10.16		7.62
30503600	34059	30503600AM	34166		64		0.0360	1/8		1-1/2		0.400		0.30	
305M0092	33965					0.92	0.0362		3.0		38		10.16		7.62
305M0093	33966					0.93	0.0366		3.0		38		10.16		7.62
30503700	34060	30503700AM	34167		63		0.0370	1/8		1-1/2		0.400		0.30	
305M0094	33967					0.94	0.0370		3.0		38		10.16		7.62
305M0095	34061	305M0095AM	34219			0.95	0.0374		3.0		38		10.16		7.62
305M0096	33968					0.96	0.0378		3.0		38		10.16		7.62
30503800	34062	30503800AM	34168		62		0.0380	1/8		1-1/2		0.400		0.30	
305M0097	33969					0.97	0.0382		3.0		38		10.16		7.62
305M0098	33970					0.98	0.0386		3.0		38		10.16		7.62
305M0099	33971					0.99	0.0390		3.0		38		10.16		7.62
30503900	34063	30503900AM	34169		61		0.0390	1/8		1-1/2		0.400		0.30	
305M0100	34064	305M0100AM	34220			1.00	0.0394		3.0		38		10.16		7.62
30504000	34065	30504000AM	34170		60		0.0400	1/8		1-1/2		0.400		0.30	
30504100	34066	30504100AM	34171		59		0.0410	1/8		1-1/2		0.400		0.30	
305M0105	34067	305M0105AM	34221			1.05	0.0413		3.0		38		10.16		7.62
30504200	34068	30504200AM	34172		58		0.0420	1/8		1-1/2		0.400		0.30	
30504300	34069	30504300AM	34173		57		0.0430	1/8		1-1/2		0.400		0.30	
305M0110	34070	305M0110AM	34222			1.10	0.0433		3.0		38		10.16		7.62
305M0115	34071	305M0115AM	34223			1.15	0.0452		3.0		38		10.16		7.62
30504650	34072	30504650AM	34174		56		0.0465	1/8		1-1/2		0.400		0.30	
30504690	34073	30504690AM	34175	3/64			0.0469	1/8		1-1/2		0.400		0.30	
305M0120	34074	305M0120AM	34224			1.20	0.0472		3.0		38		10.16		7.62
305M0125	34075	305M0125AM	34225			1.25	0.0492		3.0		38		10.16		7.62

*Do not drill beyond specified flute length. Peck cycles may be utilized to achieve best tool performance.



Series 305 Continued

Uncoated		ALtima® Micro		Diameter				Shank		OAL		Flute Length max.*		Drill Length	
				D1				D2		L1		L2		L3 Ref.	
Tool No.	EDP	Tool No.	EDP	Inch	Letter/ Wire	mm	Decimal	Inch	mm	Inch	mm	Inch	mm	Inch	mm
305M0130	34076	305M0130AM	34226			1.30	0.0511		3.0		38		10.16		7.62
30505200	34077	30505200AM	34176		55		0.0520	1/8		1-1/2		0.400		0.30	
305M0135	34078	305M0135AM	34227			1.35	0.0531		3.0		38		10.16		7.62
30505500	34079	30505500AM	34177		54		0.0550	1/8		1-1/2		0.400		0.30	
305M0140	34080	305M0140AM	34228			1.40	0.0551		3.0		38		10.16		7.62
305M0145	34081	305M0145AM	34229			1.45	0.0571		3.0		38		10.16		7.62
305M0150	34082	305M0150AM	34230			1.50	0.0590		3.0		38		10.16		7.62
30505950	34083	30505950AM	34178		53		0.0595	1/8		1-1/2		0.400		0.30	
305M0155	34084	305M0155AM	34231			1.55	0.0610		3.0		38		10.16		7.62
30506250	34085	30506250AM	34179	1/16			0.0625	1/8		1-1/2		0.480		0.36	
305M0160	34086	305M0160AM	34232			1.60	0.0630		3.0		38		12.19		9.14
30506350	34087	30506350AM	34180		52		0.0635	1/8		1-1/2		0.480		0.36	
305M0165	34088	305M0165AM	34233			1.65	0.0649		3.0		38		12.19		9.14
305M0170	34089	305M0170AM	34234			1.70	0.0669		3.0		38		12.19		9.14
30506700	34090	30506700AM	34181		51		0.0670	1/8		1-1/2		0.480		0.36	
305M0175	34091	305M0175AM	34235			1.75	0.0689		3.0		38		12.19		9.14
30507000	34092	30507000AM	34182		50		0.0700	1/8		1-1/2		0.480		0.36	
305M0180	34093	305M0180AM	34236			1.80	0.0708		3.0		38		12.19		9.14
305M0185	34094	305M0185AM	34237			1.85	0.0728		3.0		38		12.19		9.14
30507300	34095	30507300AM	34183		49		0.0730	1/8		1-1/2		0.480		0.36	
305M0190	34096	305M0190AM	34238			1.90	0.0748		3.0		38		12.19		9.14
30507600	34097	30507600AM	34184		48		0.0760	1/8		1-1/2		0.480		0.36	
305M0195	34098	305M0195AM	34239			1.95	0.0767		3.0		38		12.19		9.14
30507810	34099	30507810AM	34185	5/64			0.0781	1/8		1-1/2		0.480		0.36	
30507850	34100	30507850AM	34186		47		0.0785	1/8		1-1/2		0.480		0.36	
305M0200	34101	305M0200AM	34240			2.00	0.0787		3.0		38		12.19		9.14
305M0205	34102	305M0205AM	34241			2.05	0.0807		3.0		38		12.19		9.14
30508100	34103	30508100AM	34187		46		0.0810	1/8		1-1/2		0.480		0.36	
30508200	34104	30508200AM	34188		45		0.0820	1/8		1-1/2		0.480		0.36	
305M0210	34105	305M0210AM	34242			2.10	0.0827		3.0		38		12.19		9.14
305M0215	34106	305M0215AM	34243			2.15	0.0846		3.0		38		12.19		9.14
30508600	34107	30508600AM	34189		44		0.0860	1/8		1-1/2		0.480		0.36	
305M0220	34108	305M0220AM	34244			2.20	0.0866		3.0		38		12.19		9.14
305M0225	34109	305M0225AM	34245			2.25	0.0886		3.0		38		12.19		9.14
30508900	34110	30508900AM	34190		43		0.0890	1/8		1-1/2		0.480		0.36	
305M0230	34111	305M0230AM	34246			2.30	0.0906		3.0		38		12.19		9.14
305M0235	34112	305M0235AM	34247			2.35	0.0925		3.0		38		12.19		9.14
30509350	34113	30509350AM	34191		42		0.0935	1/8		1-1/2		0.480		0.36	
30509380	34114	30509380AM	34192	3/32			0.0938	1/8		1-1/2		0.480		0.36	
305M0240	34115	305M0240AM	34248			2.40	0.0945		3.0		38		12.19		9.14
30509600	34116	30509600AM	34193		41		0.0960	1/8		1-1/2		0.480		0.36	

*Do not drill beyond specified flute length. Peck cycles may be utilized to achieve best tool performance.



Series 305 Continued

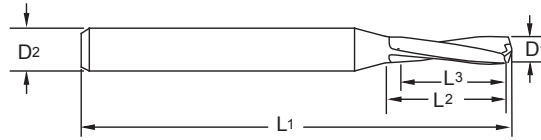
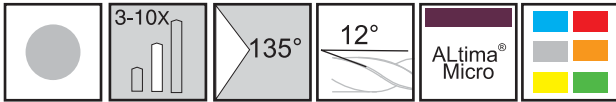

Uncoated		ALtima® Micro		Diameter				Shank		OAL		Flute Length max.*		Drill Length	
				D1				D2		L1		L2		L3 Ref.	
Tool No.	EDP	Tool No.	EDP	Inch	Letter/ Wire	mm	Decimal	Inch	mm	Inch	mm	Inch	mm	Inch	mm
305M0245	34117	305M0245AM	34249			2.45	0.0965		3.0		38		12.19		9.14
30509800	34118	30509800AM	34194		40		0.0980	1/8		1-1/2		0.480		0.36	
305M0250	34119	305M0250AM	34250			2.50	0.0984		3.0		38		12.19		9.14
30509950	34120	30509950AM	34195		39		0.0995	1/8		1-1/2		0.480		0.36	
305M0255	34121	305M0255AM	34251			2.55	0.1004		3.0		38		12.19		9.14
30510150	34122	30510150AM	34196		38		0.1015	1/8		1-1/2		0.480		0.36	
305M0260	34123	305M0260AM	34252			2.60	0.1024		3.0		38		12.19		9.14
30510400	34124	30510400AM	34197		37		0.1040	1/8		1-1/2		0.480		0.36	
305M0265	34125	305M0265AM	34253			2.65	0.1043		3.0		38		12.19		9.14
305M0270	34126	305M0270AM	34254			2.70	0.1063		3.0		38		12.19		9.14
30510650	34127	30510650AM	34198		36		0.1065	1/8		1-1/2		0.480		0.36	
305M0275	34128	305M0275AM	34255			2.75	0.1083		3.0		38		12.19		9.14
30510940	34129	30510940AM	34199	7/64			0.1094	1/8		1-1/2		0.480		0.36	
30511000	34130	30511000AM	34200		35		0.1100	1/8		1-1/2		0.480		0.36	
305M0280	34131	305M0280AM	34256			2.80	0.1102		3.0		38		12.19		9.14
30511100	34132	30511100AM	34201		34		0.1110	1/8		1-1/2		0.480		0.36	
305M0285	34133	305M0285AM	34257			2.85	0.1122		3.0		38		12.19		9.14
30511300	34134	30511300AM	34202		33		0.1130	1/8		1-1/2		0.480		0.36	
305M0290	34135	305M0290AM	34258			2.90	0.1142		3.0		38		12.19		9.14
30511600	34136	30511600AM	34203		32		0.1160	1/8		1-1/2		0.480		0.36	
305M0295	34137	305M0295AM	34259			2.95	0.1161		3.0		38		12.19		9.14
305M0300	34138	305M0300AM	34260			3.00	0.1181		3.0		38		12.19		9.14
30512000	34139	30512000AM	34204		31		0.1200	1/8		1-1/2		0.480		0.36	
30512500	34143	30512500AM	34205	1/8			0.1250	1/8		1-1/2		0.480		0.36	

*Do not drill beyond specified flute length. Peck cycles may be utilized to achieve best tool performance.



Twister® GP

General Purpose Drills

M.A. Ford® drills are designed for maximum flexibility and performance when drilling a wide variety of materials, ranging from soft, non-ferrous materials to hardened steels. Twister® GP drills are an excellent choice for all general purpose hole-making and provide these high performance benefits:

- High feed rates with excellent chip evacuation.
- Accurate hole size in a wide range of materials.
- Pre-drilling and follow-up operations can often be eliminated because of the quality and performance of M.A. Ford® drills.
- Minimal wander produces maximum precision, productivity and drill life.
- Web-thinned drill designs are available for reduced power requirements, lower temperatures and extended drill life.
- Three-flute geometries are available to reduce chip load/tooth and increase tool life in highly alloyed steels.
- Available in a wide range of styles, sizes, lengths and coatings.

Twister® GP Series 200 / 200 Sets

Twister® GP Series 204

Twister® GP Series 205

Twister® GP Series 206

Twister® GP Series 207

Twister® GP Series 209

Twister® GP Series 210

Twister® GP Series 224

Twister® GP Series 226

Twister® GP Series 300

Twister® GP Series 302

Twister® GP Series 306

Twister® GP Series 402

Twister® GP Series 200S

Twister® GP Series 403

Twister® GP Series 404

Twister® GP Series 405

ISO 9001:2008 Certified



Where *high performance* is the **standard**®

Hi Roc® Series 200

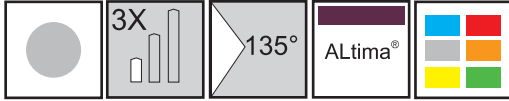

Designed to drill hardened steel in the 42-65 Rockwell "C" range.

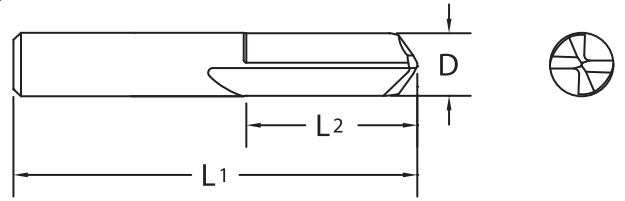

- Produces chips without generating excessive heat.
- Accurately sized holes are produced without annealing or softening the workpiece.
- Reamer type finishes are easily produced.
- Both a production drill and salvage or reclaim tool.
- Straight flute.

Uncoated		ALtima®		Diameter				OAL		Flute Length	
Tool No.	EDP	Tool No.	EDP	D				L1		L2	
				Inch	Letter/ Wire	mm	Decimal	Inch	mm	Inch	mm
20003100	20001				68		.0310	1-1/2		3/16	
20003120	20004			1/32			.0312	1-1/2		3/16	
20003150	20007					0.80	.0315		38		5.0
20003200	20010				67		.0320	1-1/2		7/32	
20003300	20013				66		.0330	1-1/2		7/32	
20003350	20016					0.85	.0335		38		5.5
20003500	20019				65		.0350	1-1/2		7/32	
20003540	20022					0.90	.0354		38		5.5
20003600	20025				64		.0360	1-1/2		7/32	
20003700	20028				63		.0370	1-1/2		1/4	
20003740	20031					0.95	.0374		38		6.0
20003800	20034				62		.0380	1-1/2		1/4	
20003900	20037				61		.0390	1-1/2		1/4	
20003940	20040					1.00	.0394		38		6.5
20004000	20043				60		.0400	1-1/2		1/4	
20004100	20046				59		.0410	1-1/2		1/4	
20004130	20049					1.05	.0413		38		6.5
20004200	20052				58		.0420	1-1/2		1/4	
20004300	20055				57		.0430	1-1/2		1/4	
20004330	20058					1.10	.0433		38		6.5
20004520	20061					1.15	.0452		38		6.5
20004650	20064				56		.0465	1-1/2		1/4	
20004680	20067			3/64			.0468	1-1/2		1/4	
20004720	20070					1.20	.0472		38		8.0
20004920	20073					1.25	.0492		38		8.0
20005110	20076					1.30	.0511		38		8.0
20005200	20079				55		.0520	1-1/2		5/16	
20005310	20082					1.35	.0531		38		8.0
20005500	20085				54		.0550	1-1/2		5/16	
20005510	20088					1.40	.0551		38		8.0
20005710	20091					1.45	.0571		38		8.0
20005900	20094					1.50	.0590		38		8.0

Inch	
D	Tolerance
.0310 - .7812	+.0000/-0.0005

Metric (mm)	
D	Tolerance
0.80 - 20.00	+.000/-0.013



Series 200 Continued

Uncoated		ALtima®		Diameter				OAL		Flute Length	
Tool No.	EDP	Tool No.	EDP	D				L1		L2	
				Inch	Letter/ Wire	mm	Decimal	Inch	mm	Inch	mm
20005950	20097				53		.0595	1-1/2		5/16	
20006250	20100			1/16			.0625	1-1/2		5/16	
20006300	20103					1.60	.0630		38		8.0
20006350	20106				52		.0635	1-1/2		5/16	
20006690	20109					1.70	.0669		38		9.5
20006700	20112				51		.0670	1-1/2		3/8	
20007000	20115				50		.0700	1-1/2		3/8	
20007080	20118					1.80	.0708		38		9.5
20007300	20121				49		.0730	1-1/2		3/8	
20007480	20124					1.90	.0748		38		9.5
20007600	20127				48		.0760	1-1/2		3/8	
20007810	20130			5/64			.0781	1-1/2		3/8	
20007850	20133				47		.0785	1-1/2		3/8	
20007870	20136					2.00	.0787		38		9.5
20008100	20139				46		.0810	1-1/2		1/2	
20008200	20142				45		.0820	1-1/2		1/2	
20008270	20145					2.10	.0827		38		12.5
20008600	20148				44		.0860	1-1/2		1/2	
20008660	20151					2.20	.0866		38		12.5
20008900	20154				43		.0890	1-1/2		1/2	
20009060	20157					2.30	.0906		38		12.5
20009350	20160				42		.0935	1-1/2		1/2	
20009370	20163			3/32			.0937	1-1/2		1/2	
20009450	20166					2.40	.0945		38		12.5
20009600	20169				41		.0960	1-1/2		1/2	
20009800	20172				40		.0980	1-1/2		1/2	
20009840	20175					2.50	.0984		38		12.5
20009950	20178				39		.0995	1-1/2		1/2	
20010150	20184				38		.1015	1-1/2		1/2	
20010240	20187					2.60	.1024		38		16.0
20010400	20190				37		.1040	1-1/2		5/8	
20010630	20193					2.70	.1063		38		16.0
20010650	20196				36		.1065	1-1/2		5/8	
20010930	20199			7/64			.1093	1-1/2		5/8	
20011000	20202				35		.1100	1-1/2		5/8	
20011020	20205					2.80	.1102		38		16.0
20011100	20208				34		.1110	1-1/2		5/8	
20011300	20211				33		.1130	1-1/2		5/8	
20011420	20214					2.90	.1142		38		16.0
20011600	20217				32		.1160	1-1/2		5/8	
20011810	20220	20011810A	96400			3.00	.1181		38		16.0
20012000	20223				31		.1200	1-1/2		5/8	



Series 200 Continued

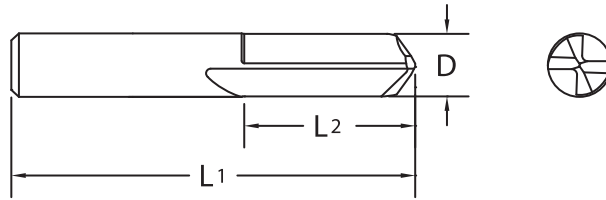
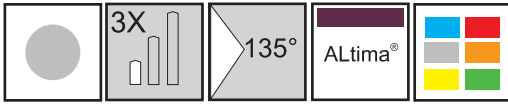

Uncoated		ALtima®		Diameter				OAL		Flute Length	
				D				L1		L2	
Tool No.	EDP	Tool No.	EDP	Inch	Letter/ Wire	mm	Decimal	Inch	mm	Inch	mm
20012200	20226	20012200A	96401			3.10	.1220		38		16.0
20012500	20229			1/8			.1250	1-1/2		5/8	
20012600	20232	20012600A	96402			3.20	.1260		38		16.0
20012850	20235				30		.1285	2		5/8	
20012990	20238	20012990A	96403			3.30	.1299		38		16.0
20013390	20241	20013390A	96404			3.40	.1339		51		16.0
20013600	20244				29		.1360	2		5/8	
20013780	20247	20013780A	96405			3.50	.1378		51		16.0
20014050	20250				28		.1405	2		5/8	
20014060	20253			9/64			.1406	2		5/8	
20014170	20256	20014170A	96406			3.60	.1417		51		16.0
20014400	20259				27		.1440	2		5/8	
20014570	20262	20014570A	96407			3.70	.1457		51		16.0
20014700	20265				26		.1470	2		5/8	
20014950	20268				25		.1495	2		5/8	
20014960	20271	20014960A	96408			3.80	.1496		51		16.0
20015200	20274				24		.1520	2		5/8	
20015350	20277	20015350A	96409			3.90	.1535		51		16.0
20015400	20280				23		.1540	2		5/8	
20015620	20283			5/32			.1562	2		5/8	
20015700	20286				22		.1570	2		5/8	
20015750	20289	20015750A	96410			4.00	.1575		51		16.0
20015900	20292				21		.1590	2		5/8	
20016100	20295				20		.1610	2		5/8	
20016140	20298	20016140A	96411			4.10	.1614		51		16.0
20016540	20301	20016540A	96412			4.20	.1654		51		16.0
20016600	20304				19		.1660	2		5/8	
20016930	20307	20016930A	96413			4.30	.1693		51		16.0
20016950	20310				18		.1695	2		5/8	
20017180	20313			11/64			.1718	2		5/8	
20017300	20316				17		.1730	2		5/8	
20017320	20319	20017320A	96414			4.40	.1732		51		16.0
20017700	20322				16		.1770	2		5/8	
20017720	20325	20017720A	96415			4.50	.1772		51		16.0
20018000	20328				15		.1800	2		5/8	
20018110	20331	20018110A	96416			4.60	.1811		51		16.0
20018200	20334				14		.1820	2		5/8	
20018500	20337	20018500A	96417			4.70	.1850	2	51	5/8	16.0



Series 200 Continued

Uncoated		ALtima®		Diameter				OAL		Flute Length	
Tool No.	EDP	Tool No.	EDP	D				L1		L2	
				Inch	Letter/ Wire	mm	Decimal	Inch	mm	Inch	mm
20018750	20340			3/16			.1875	2		5/8	
20018890	20343	20018890A	96418			4.80	.1889		51		16.0
20018900	20346				12		.1890	2		5/8	
20019100	20349				11		.1910	2		5/8	
20019290	20352	20019290A	96419			4.90	.1929		51		16.0
20019350	20355				10		.1935	2		5/8	
20019600	20358				9		.1960	2		3/4	
20019680	20361	20019680A	96420			5.00	.1968		51		19.0
20019900	20364				8		.1990	2		3/4	
20020080	20370	20020080A	96421			5.10	.2008		51		19.0
20020100	20373				7		.2010	2		3/4	
20020310	20376			13/64			.2031	2		3/4	
20020400	20379				6		.2040	2		3/4	
20020470	20382	20020470A	96422			5.20	.2047		51		19.0
20020550	20385				5		.2055	2		3/4	
20020860	20388	20020860A	96423			5.30	.2086		51		19.0
20020900	20391				4		.2090	2		3/4	
20021260	20394	20021260A	96424			5.40	.2126		51		19.0
20021300	20397				3		.2130	2		3/4	
20021650	20400	20021650A	96425			5.50	.2165		51		19.0
20021870	20403			7/32			.2187	2		3/4	
20022050	20406	20022050A	96426			5.60	.2205		51		19.0
20022100	20409				2		.2210	2		3/4	
20022440	20412	20022440A	96427			5.70	.2244		51		19.0
20022800	20415				1		.2280	2		3/4	
20022830	20418	20022830A	96428			5.80	.2283		51		19.0
20023230	20421	20023230A	96429			5.90	.2323		51		19.0
20023400	20424				A		.2340	2		3/4	
20023430	20427			15/64			.2343	2		3/4	
20023620	20430	20023620A	96430			6.00	.2362		51		19.0
20023800	20433				B		.2380	2		3/4	
20024020	20436	20024020A	96431			6.10	.2402		51		19.0
20024200	20439				C		.2420	2		3/4	
20024410	20442	20024410A	96432			6.20	.2441		51		19.0
20024600	20445				D		.2460	2		3/4	
20024800	20448	20024800A	96433			6.30	.2480		51		19.0
20025000	20451			1/4	E		.2500	2		3/4	
20025190	20454	20025190A	96434			6.40	.2519		51		19.0
20025590	20457	20025590A	96435			6.50	.2559		51		19.0
20025700	20460				F		.2570	2		3/4	
20025980	20463	20025980A	96436			6.60	.2598		64		19.0
20026100	20466				G		.2610	2-1/2		3/4	



Series 200 Continued

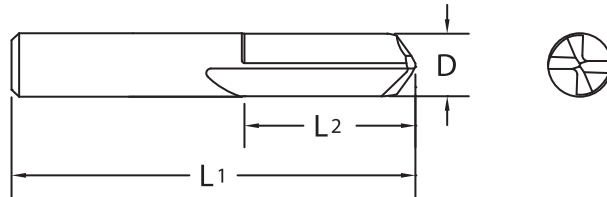
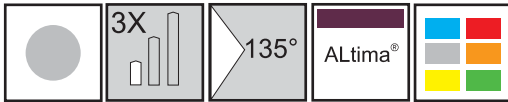

Uncoated		ALtima®		Diameter				OAL		Flute Length	
Tool No.	EDP	Tool No.	EDP	D				L1		L2	
				Inch	Letter/ Wire	mm	Decimal	Inch	mm	Inch	mm
20026370	20469	20026370A	96437			6.70	.2637		64		19.0
20026560	20472			17/64			.2656	2-1/2		3/4	
20026600	20475				H		.2660	2-1/2		3/4	
20026770	20478	20026770A	96438			6.80	.2677		64		19.0
20027160	20481	20027160A	96439			6.90	.2716		64		19.0
20027200	20484				I		.2720	2-1/2		3/4	
20027560	20487	20027560A	96440			7.00	.2756		64		19.0
20027700	20490				J		.2770	2-1/2		3/4	
20027950	20493	20027950A	96441			7.10	.2795		64		19.0
20028100	20496				K		.2810	2-1/2		3/4	
20028120	20499			9/32			.2812	2-1/2		3/4	
20028340	20502	20028340A	96442			7.20	.2834		64		19.0
20028740	20505	20028740A	96443			7.30	.2874		64		19.0
20029000	20508				L		.2900	2-1/2		3/4	
20029130	20511	20029130A	96444			7.40	.2913		64		19.0
20029500	20514				M		.2950	2-1/2		3/4	
20029530	20517	20029530A	96445			7.50	.2953		64		19.0
20029680	20520			19/64			.2968	2-1/2		3/4	
20029920	20523	20029920A	96446			7.60	.2992		64		19.0
20030200	20529				N		.3020	2-1/2		3/4	
20030310	20532	20030310A	96447			7.70	.3031		64		19.0
20030710	20535	20030710A	96448			7.80	.3071		64		19.0
20031100	20538	20031100A	96449			7.90	.3110		64		19.0
20031250	20541			5/16			.3125	2-1/2		3/4	
20031500	20544	20031500A	96450			8.00	.3150		64		19.0
20031600	20547				O		.3160	2-1/2		3/4	
20031890	20550	20031890A	96451			8.10	.3189		64		19.0
20032280	20553	20032280A	96452			8.20	.3228		64		25.5
20032300	20556				P		.3230	2-1/2		1	
20032670	20559	20032670A	96453			8.30	.3267		64		25.5
20032810	20562			21/64			.3281	2-1/2		1	
20033070	20565	20033070A	96454			8.40	.3307		64		25.5
20033200	20568				Q		.3320	2-1/2		1	
20033460	20571	20033460A	96455			8.50	.3346		64		25.5
20033850	20574	20033850A	96456			8.60	.3385		64		25.5
20033900	20577				R		.3390	2-1/2		1	
20034250	20580	20034250A	96457			8.70	.3425		64		25.5
20034370	20583			11/32			.3437	2-1/2		1	
20034640	20586	20034640A	96458			8.80	.3464		64		25.5
20034800	20589				S		.3480	2-1/2		1	



Series 200 Continued

Uncoated		ALtima®		Diameter				OAL		Flute Length	
Tool No.	EDP	Tool No.	EDP	D				L1		L2	
				Inch	Letter/ Wire	mm	Decimal	Inch	mm	Inch	mm
20035040	20592	20035040A	96459			8.90	.3504		64		25.5
20035430	20595	20035430A	96460			9.00	.3543		64		25.5
20035800	20598				T		.3580	2-1/2		1	
20035820	20601	20035820A	96461			9.10	.3582		64		25.5
20035930	20604			23/64			.3593	2-1/2		1	
20036220	20607	20036220A	96462			9.20	.3622		64		25.5
20036610	20610	20036610A	96463			9.30	.3661		64		25.5
20036800	20613				U		.3680	2-1/2		1	
20037000	20616	20037000A	96464			9.40	.3700		64		25.5
20037400	20619	20037400A	96465			9.50	.3740		64		25.5
20037500	20622			3/8			.3750	2-1/2		1	
20037700	20625				V		.3770	2-1/2		1	
20037790	20628	20037790A	96466			9.60	.3779		64		25.5
20038190	20631	20038190A	96467			9.70	.3819		70		25.5
20038580	20634	20038580A	96468			9.80	.3858		70		25.5
20038600	20637				W		.3860	2-3/4		1	
20038970	20640	20038970A	96469			9.90	.3897		70		25.5
20039060	20643			25/64			.3906	2-3/4		1	
20039370	20646	20039370A	96470			10.00	.3937		70		25.5
20039700	20649				X		.3970	2-3/4		1	
20039760	20652	20039760A	96471			10.10	.3976		70		25.5
20040150	20655	20040150A	96472			10.20	.4015		70		25.5
20040400	20658				Y		.4040	2-3/4		1	
20040550	20661	20040550A	96473			10.30	.4055		70		25.5
20040620	20664			13/32			.4062	2-3/4		1	
20040940	20667	20040940A	96474			10.40	.4094		70		25.5
20041300	20670				Z		.4130	2-3/4		1	
20041340	20673	20041340A	96475			10.50	.4134		70		25.5
20041730	20676	20041730A	96476			10.60	.4173		70		25.5
20042120	20679	20042120A	96477			10.70	.4212		70		25.5
20042180	20682			27/64			.4218	2-3/4		1	
20042520	20685	20042520A	96478			10.80	.4252		70		25.5
20042910	20688	20042910A	96479			10.90	.4291		70		25.5
20043310	20691	20043310A	96480			11.00	.4331		70		25.5
20043700	20694	20043700A	96481			11.10	.4370		70		25.5
20043750	20697			7/16			.4375	2-3/4		1	
20044090	20700	20044090A	96482			11.20	.4409		70		25.5
20044490	20703	20044490A	96483			11.30	.4449		76		25.5
20044880	20706	20044880A	96484			11.40	.4488		76		25.5
20045270	20709	20045270A	96485			11.50	.4527		76		25.5
20045310	20712			29/64			.4531	3		1	
20045670	20715	20045670A	96486			11.60	.4567		76		25.5
20046060	20718	20046060A	96487			11.70	.4606		76		25.5
20046450	20721	20046450A	96488			11.80	.4645		76		25.5



Series 200 Continued

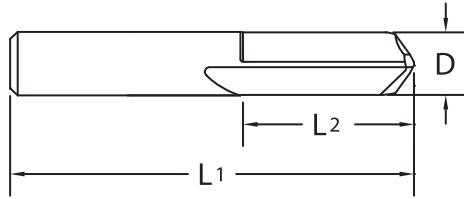
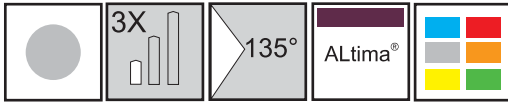

Uncoated		ALtima®		Diameter				OAL		Flute Length	
Tool No.	EDP	Tool No.	EDP	D				L1		L2	
				Inch	Letter/ Wire	mm	Decimal	Inch	mm	Inch	mm
20046850	20724	20046850A	96489			11.90	.4685		76		25.5
20046870	20727			15/32			.4687	3		1	
20047240	20730	20047240A	96490			12.00	.4724		76		25.5
20048440	20733			31/64			.4844	3		1	
20049210	20736	20049210A	96491			12.50	.4921		76		25.5
20050000	20739			1/2			.5000	3		1	
20051180	20742	20051180A	96492			13.00	.5118		89		28.5
20051560	20745			33/64			.5156	3-1/2		1-1/8	
20053120	20748			17/32			.5312	3-1/2		1-1/8	
20053150	20751	20053150A	96493			13.50	.5315		89		28.5
20054690	20754			35/64			.5469	3-1/2		1-1/8	
20055120	20757	20055120A	96494			14.00	.5512		89		28.5
20056250	20760			9/16			.5625	3-1/2		1-1/8	
20057080	20763	20057080A	96495			14.50	.5708		89		32.0
20057810	20766			37/64			.5781	3-1/2		1-1/4	
20059050	20769	20059050A	96496			15.00	.5905		89		32.0
20059380	20772			19/32			.5938	3-1/2		1-1/4	
20060940	20775			39/64			.6094	3-1/2		1-1/4	
20061020	20778	20061020A	96497			15.50	.6102		89		32.0
20062500	20781			5/8			.6250	3-1/2		1-1/4	
20062990	20784	20062990A	96498			16.00	.6299		89		32.0
20064060	20787			41/64			.6406	4		1-1/2	
20064960	20790	20064960A	96499			16.50	.6496		102		38.0
20065620	20793			21/32			.6562	4		1-1/2	
20066930	20796	20066930A	96500			17.00	.6693		102		38.0
20067190	20799			43/64			.6719	4		1-1/2	
20068750	20802			11/16			.6875	4		1-1/2	
20068900	20805	20068900A	96501			17.50	.6890		102		38.0
20070310	20808			45/64			.7031	4		1-1/2	
20070870	20811	20070870A	96502			18.00	.7087		102		38.0
20071880	20814			23/32			.7188	4		1-1/2	
20072830	20817	20072830A	96503			18.50	.7283		102		38.0
20073440	20820			47/64			.7344	4		1-1/2	
20074800	20823	20074800A	96504			19.00	.7480		102		38.0
20075000	20826			3/4			.7500	4		1-1/2	
20076560	20829			49/64			.7656	4		1-1/2	
20078120	20832			25/32			.7812	4		1-1/2	
20078740	20835	20078740A	96505			20.00	.7874		102		38.0



Hi Roc® Series 200 Sets

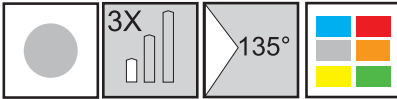

Available in five popular sets. Each set contains a selection of more frequently used drills.

- Packed in a plastic case.
- Used for drilling bolt studs, welds and other hard materials.
- Ideal for tool box.



		Sets										
Tool No.	EDP	Sizes per Set										
20010000	20181	1/8"	3/16"	1/4"	5/16"	3/8"						
20020000	20367	1/16"	3/32"	1/8"	5/32"	3/16"	7/32"	1/4"				
20030000	20526	3/64"	1/16"	5/64"	3/32"	7/64"	1/8"	9/64"	5/32"	11/64"	3/16"	
20040000	20653	2.0mm	3.0mm	4.0mm	5.0mm	6.0mm						
20060000	20773	2.0mm	2.5mm	3.0mm	4.0mm	5.0mm	6.0mm	8.0mm				



Page 158



Twister® GP Series 204

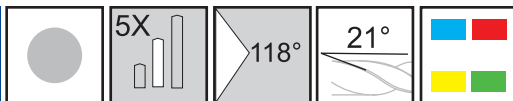

- Designed to allow high feed rates with good chip flow.
- Four facet drill point minimizes drill wander and assures accurately sized holes.

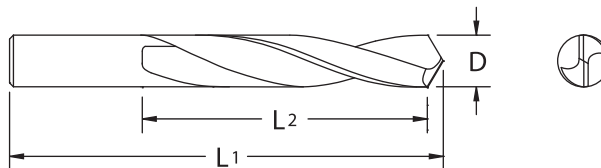

See Series 224 on page 115 for mm size Jobber Drills.

Tool No.	EDP	Diameter			OAL	Flute Length	
		D				L1	L2
		Inch	Wire	Decimal			
20401350	24004		80	.0135	1-1/2	1/4	
20401450	24010		79	.0145	1-1/2	1/4	
20401560	24013	1/64		.0156	1-1/2	1/4	
20401600	24019		78	.0160	1-1/2	1/4	
20401800	24025		77	.0180	1-1/2	1/4	
20402000	24031		76	.0200	1-1/2	1/4	
20402100	24034		75	.0210	1-1/2	1/4	
20402250	24040		74	.0225	1-1/2	1/4	
20402400	24046		73	.0240	1-1/2	1/4	
20402500	24049		72	.0250	1-1/2	5/16	
20402600	24055		71	.0260	1-1/2	5/16	
20402800	24061		70	.0280	1-1/2	5/16	
20402920	24064		69	.0292	1-1/2	5/16	
20403100	24070		68	.0310	1-1/2	3/8	
20403120	24073	1/32		.0312	1-1/2	3/8	
20403200	24079		67	.0320	1-1/2	3/8	
20403300	24082		66	.0330	1-1/2	3/8	
20403500	24088		65	.0350	1-1/2	3/8	
20403600	24094		64	.0360	1-1/2	1/2	
20403700	24097		63	.0370	1-1/2	1/2	
20403800	24103		62	.0380	1-1/2	1/2	
20403900	24106		61	.0390	1-1/2	1/2	
20404000	24112		60	.0400	1-1/2	3/4	
20404100	24115		59	.0410	1-1/2	3/4	
20404200	24121		58	.0420	1-1/2	3/4	
20404300	24124		57	.0430	1-1/2	3/4	
20404650	24133		56	.0465	1-1/2	3/4	
20404690	24136	3/64		.0469	1-1/2	3/4	
20405200	24148		55	.0520	1-1/2	3/4	
20405500	24154		54	.0550	1-1/2	3/4	
20405950	24166		53	.0595	1-1/2	3/4	
20406250	24169	1/16		.0625	1-1/2	3/4	
20406350	24175		52	.0635	1-1/2	3/4	
20406700	24181		51	.0670	1-1/2	3/4	

Tool No.	EDP	Diameter			OAL	Flute Length	
		D				L1	L2
		Inch	Wire	Decimal			
20407000	24184		50	.0700	1-3/4	7/8	
20407300	24190		49	.0730	1-3/4	7/8	
20407600	24196		48	.0760	1-3/4	7/8	
20407810	24199	5/64		.0781	1-3/4	7/8	
20407850	24202		47	.0785	1-3/4	7/8	
20408100	24208		46	.0810	1-3/4	7/8	
20408200	24211		45	.0820	1-3/4	7/8	
20408600	24217		44	.0860	2	1	
20408900	24223		43	.0890	2	1	
20409350	24229		42	.0935	2	1	
20409380	24232	3/32		.0938	2	1	
20409600	24238		41	.0960	2	1	
20409800	24241		40	.0980	2	1	
20409950	24247		39	.0995	2-1/4	1-1/4	
20410150	24250		38	.1015	2-1/4	1-1/4	
20410400	24256		37	.1040	2-1/4	1-1/4	
20410650	24262		36	.1065	2-1/4	1-1/4	
20410940	24265	7/64		.1094	2-1/4	1-1/4	
20411000	24268		35	.1100	2-1/4	1-1/4	
20411100	24274		34	.1110	2-1/4	1-1/4	
20411300	24277		33	.1130	2-1/4	1-1/4	
20411600	24283		32	.1160	2-1/4	1-1/4	
20412000	24289		31	.1200	2-1/4	1-1/4	
20412500	24295	1/8		.1250	2-1/4	1-1/4	
20412850	24301		30	.1285	2-1/4	1-1/4	
20413600	24310		29	.1360	2-1/2	1-3/8	
20414050	24316		28	.1405	2-1/2	1-3/8	
20414060	24319	9/64		.1406	2-1/2	1-3/8	
20414400	24325		27	.1440	2-1/2	1-3/8	
20414700	24331		26	.1470	2-1/2	1-3/8	
20414950	24334		25	.1495	2-1/2	1-3/8	
20415200	24340		24	.1520	2-1/2	1-3/8	
20415400	24346		23	.1540	2-1/2	1-3/8	
20415620	24349	5/32		.1562	2-1/2	1-3/8	

Inch	
D	Tolerance
.0135 - .7812	+.0000/-.0005



Series 204 Continued

Tool No.	EDP	Diameter			OAL	Flute Length
		D				
		Inch	Wire	Decimal	L1	L2
20415700	24352		22	.1570	2-1/2	1-3/8
20415900	24358		21	.1590	2-1/2	1-3/8
20416100	24361		20	.1610	2-1/2	1-3/8
20416600	24370		19	.1660	2-3/4	1-5/8
20416950	24376		18	.1695	2-3/4	1-5/8
20417190	24379	11/64		.1719	2-3/4	1-5/8
20417300	24382		17	.1730	2-3/4	1-5/8
20417700	24388		16	.1770	2-3/4	1-5/8
20418000	24394		15	.1800	2-3/4	1-5/8
20418200	24400		14	.1820	2-3/4	1-5/8
20418500	24403		13	.1850	2-3/4	1-5/8
20418750	24406	3/16		.1875	2-3/4	1-5/8
20418900	24412		12	.1890	2-3/4	1-5/8
20419100	24415		11	.1910	2-3/4	1-5/8
20419350	24421		10	.1935	2-3/4	1-5/8
20419600	24424		9	.1960	3	1-3/4
20419900	24430		8	.1990	3	1-3/4
20420100	24436		7	.2010	3	1-3/4
20420310	24439	13/64		.2031	3	1-3/4
20420400	24442		6	.2040	3	1-3/4
20420550	24448		5	.2055	3	1-3/4
20420900	24454		4	.2090	3	1-3/4
20421300	24460		3	.2130	3	1-3/4
20421870	24466	7/32		.2187	3	1-3/4
20422100	24472		2	.2210	3	1-3/4
20422800	24478		1	.2280	3	1-3/4
20423400	24487		A	.2340	3-1/4	2
20423440	24490	15/64		.2344	3-1/4	2
20423800	24496		B	.2380	3-1/4	2
20424200	24502		C	.2420	3-1/4	2
20424600	24508		D	.2460	3-1/4	2
20425000	24514	1/4		.2500	3-1/4	2
20425700	24523		F	.2570	3-1/4	2
20426100	24529		G	.2610	3-1/2	2-1/8
20426560	24535	17/64		.2656	3-1/2	2-1/8
20426600	24538		H	.2660	3-1/2	2-1/8
20427200	24547		I	.2720	3-1/2	2-1/8
20427700	24553		J	.2770	3-1/2	2-1/8
20428100	24559		K	.2810	3-1/2	2-1/8
20428120	24562	9/32		.2812	3-1/2	2-1/8
20429000	24571		L	.2900	3-1/2	2-1/8
20429500	24577		M	.2950	3-3/4	2-3/8
20429690	24583	19/64		.2969	3-3/4	2-3/8
20430200	24589		N	.3020	3-3/4	2-3/8
20431250	24601	5/16		.3125	3-3/4	2-3/8
20431600	24607		O	.3160	3-3/4	2-3/8

Tool No.	EDP	Diameter			OAL	Flute Length
		D				
		Inch	Wire	Decimal	L1	L2
20432300	24616		P	.3230	3-3/4	2-3/8
20432810	24622	21/64		.3281	4	2-1/2
20433200	24628		Q	.3320	4	2-1/2
20433900	24637		R	.3390	4	2-1/2
20434380	24643	11/32		.3438	4	2-1/2
20434800	24649		S	.3480	4	2-1/2
20435800	24658		T	.3580	4-1/4	2-3/4
20435940	24664	23/64		.3594	4-1/4	2-3/4
20436800	24673		U	.3680	4-1/4	2-3/4
20437500	24682	3/8		.3750	4-1/4	2-3/4
20437700	24685		V	.3770	4-1/2	2-7/8
20438600	24697		W	.3860	4-1/2	2-7/8
20439060	24703	25/64		.3906	4-1/2	2-7/8
20439700	24709		X	.3970	4-1/2	2-7/8
20440400	24718		Y	.4040	4-1/2	2-7/8
20440620	24724	13/32		.4062	4-1/2	2-7/8
20441300	24730		Z	.4130	4-1/2	2-7/8
20442190	24742	27/64		.4219	4-1/2	2-7/8
20443750	24757	7/16		.4375	4-1/2	2-7/8
20445310	24772	29/64		.4531	4-3/4	3
20446880	24787	15/32		.4688	4-3/4	3
20448440	24793	31/64		.4844	4-3/4	3
20450000	24799	1/2		.5000	4-3/4	3
20451560	24805	33/64		.5156	5	3-1/4
20453120	24808	17/32		.5312	5	3-1/4
20454690	24814	35/64		.5469	5	3-1/4
20456250	24820	9/16		.5625	5	3-1/4
20457810	24826	37/64		.5781	5-1/4	3-1/2
20459380	24832	19/32		.5938	5-1/4	3-1/2
20460940	24835	39/64		.6094	5-1/4	3-1/2
20462500	24841	5/8		.6250	5-1/4	3-1/2
20464060	24847	41/64		.6406	5-1/2	3-5/8
20465620	24853	21/32		.6562	5-1/2	3-5/8
20467190	24859	43/64		.6719	5-1/2	3-5/8
20468750	24862	11/16		.6875	5-1/2	3-5/8
20470310	24868	45/64		.7031	5-3/4	3-7/8
20471880	24874	23/32		.7188	5-3/4	3-7/8
20473440	24880	47/64		.7344	5-3/4	3-7/8
20475000	24886	3/4		.7500	5-3/4	3-7/8
20476560	24889	49/64		.7656	6	4
20478120	24892	25/32		.7812	6	4

See Series 224 on page 115 for mm size Jobber Drills.



Twister® Hi-Tuff® Series 205



Designed for drilling stainless steel, tool steels, titanium, nickel based alloys and other high strength ferrous metals.

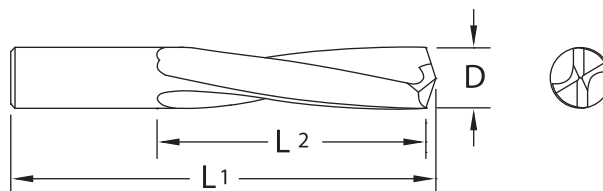

- Screw machine lengths and a heavy web provide extra rigidity and strength.
- Web-thinned drill point reduces power requirements, lowers drilling temperatures and extends tool life.

- Slow spiral.
- ALtima® coating upon request.

Uncoated		TiN		Diameter				OAL		Flute Length	
Tool No.	EDP	Tool No.	EDP	D				L1		L2	
				Inch	Wire	mm	Decimal	Inch	mm	Inch	mm
20501180	25001					0.30	.0118		38		5.0
20501350	25004					80	.0135	1-1/2		3/16	
20501380	25007					0.35	.0138		38		5.0
20501450	25010					79	.0145	1-1/2		3/16	
20501560	25013			1/64			.0156	1-1/2		3/16	
20501570	25016					0.40	.0157		38		5.0
20501600	25019					78	.0160	1-1/2		3/16	
20501770	25022					0.45	.0177		38		5.0
20501800	25025					77	.0180	1-1/2		3/16	
20501970	25028					0.50	.0197		38		6.5
20502000	25031					76	.0200	1-1/2		1/4	
20502100	25034					75	.0210	1-1/2		1/4	
20502170	25037					0.55	.0217		38		6.5
20502250	25040					74	.0225	1-1/2		1/4	
20502360	25043					0.60	.0236		38		6.5
20502400	25046					73	.0240	1-1/2		1/4	
20502500	25049					72	.0250	1-1/2		5/16	
20502560	25052					0.65	.0256		38		8.0
20502600	25055					71	.0260	1-1/2		5/16	
20502760	25058					0.70	.0276		38		8.0
20502800	25061					70	.0280	1-1/2		5/16	
20502920	25064					69	.0292	1-1/2		5/16	
20502950	25067					0.75	.0295		38		8.0
20503100	25070					68	.0310	1-1/2		3/8	
20503120	25073	20503120T	25074	1/32			.0312	1-1/2		3/8	
20503150	25076					0.80	.0315		38		9.5
20503200	25079					67	.0320	1-1/2		3/8	
20503300	25082					66	.0330	1-1/2		3/8	
20503350	25085					0.85	.0335		38		9.5
20503500	25088					65	.0350	1-1/2		7/16	
20503540	25091					0.90	.0354		38		11.0
20503600	25094					64	.0360	1-1/2		7/16	
20503700	25097					63	.0370	1-1/2		7/16	
20503740	25100					0.95	.0374		38		11.0

Inch	
D	Tolerance
.0135 - .7812	+0.0000/-0.0005

Metric (mm)	
D	Tolerance
0.30 - 20.00	+0.000/-0.013



Series 205 Continued

Uncoated		TIN		Diameter				OAL		Flute Length	
				D				L1		L2	
Tool No.	EDP	Tool No.	EDP	Inch	Wire	mm	Decimal	Inch	mm	Inch	mm
20503800	25103				62		.0380	1-1/2		7/16	
20503900	25106				61		.0390	1-1/2		7/16	
20503940	25109	20503940T	25110			1.00	.0394		38		12.5
20504000	25112				60		.0400	1-1/2		1/2	
20504100	25115				59		.0410	1-1/2		1/2	
20504130	25118					1.05	.0413		38		12.5
20504200	25121				58		.0420	1-1/2		1/2	
20504300	25124				57		.0430	1-1/2		1/2	
20504330	25127					1.10	.0433		38		12.5
20504520	25130					1.15	.0452		38		12.5
20504650	25133				56		.0465	1-1/2		1/2	
20504690	25136	20504690T	25137	3/64			.0469	1-1/2		1/2	
20504720	25139					1.20	.0472		38		12.5
20504920	25142					1.25	.0492		41		16.0
20505110	25145					1.30	.0511		41		16.0
20505200	25148				55		.0520	1-5/8		5/8	
20505310	25151					1.35	.0531		41		16.0
20505500	25154				54		.0550	1-5/8		5/8	
20505510	25157					1.40	.0551		41		16.0
20505710	25160					1.45	.0571		41		16.0
20505900	25163	20505900T	25164			1.50	.0590		41		16.0
20505950	25166				53		.0595	1-5/8		5/8	
20506250	25169	20506250T	25170	1/16			.0625	1-5/8		5/8	
20506300	25172					1.60	.0630		41		16.0
20506350	25175				52		.0635	1-11/16		11/16	
20506690	25178					1.70	.0669		43		17.5
20506700	25181				51		.0670	1-11/16		11/16	
20507000	25184	20507000T	20507		50		.0700	1-11/16		11/16	
20507080	25187					1.80	.0708		43		17.5
20507300	25190				49		.0730	1-11/16		11/16	
20507480	25193					1.90	.0748		43		17.5
20507600	25196				48		.0760	1-11/16		11/16	
20507810	25199	20507810T	25200	5/64			.0781	1-11/16		11/16	
20507850	25202				47		.0785	1-3/4		3/4	
20507870	25205	20507870T	25206			2.00	.0787		44		19.0
20508100	25208				46		.0810	1-3/4		3/4	
20508200	25211				45		.0820	1-3/4		3/4	
20508270	25214					2.10	.0827		44		19.0
20508600	25217				44		.0860	1-3/4		3/4	
20508660	25220					2.20	.0866		44		19.0
20508900	25223	20508900T	25224		43		.0890	1-3/4		3/4	
20509060	25226					2.30	.0906		44		19.0
20509350	25229				42		.0935	1-3/4		3/4	
20509380	25232	20509380T	25233	3/32			.0938	1-3/4		3/4	
20509450	25235					2.40	.0945		44		19.0
20509600	25238				41		.0960	1-13/16		13/16	



Series 205 Continued

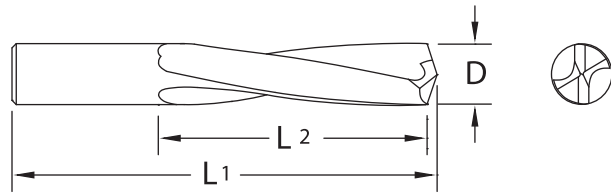
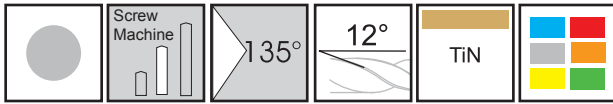

Uncoated		TiN		Diameter				OAL		Flute Length	
Tool No.	EDP	Tool No.	EDP	Inch	Wire	mm	Decimal	Inch	mm	Inch	mm
20509800	25241				40		.0980	1-13/16		13/16	
20509840	25244	20509840T	25245			2.50	.0984		46		20.5
20509950	25247				39		.0995	1-13/16		13/16	
20510150	25250				38		.1015	1-13/16		13/16	
20510240	25253					2.60	.1024		46		20.5
20510400	25256				37		.1040	1-13/16		13/16	
20510630	25259					2.70	.1063		46		20.5
20510650	25262				36		.1065	1-13/16		13/16	
20510940	25265	20510940T	25266	7/64			.1094	1-13/16		13/16	
20511000	25268				35		.1100	1-7/8		7/8	
20511020	25271					2.80	.1102		48		22.0
20511100	25274				34		.1110	1-7/8		7/8	
20511300	25277				33		.1130	1-7/8		7/8	
20511420	25280					2.90	.1142		48		22.0
20511600	25283				32		.1160	1-7/8		7/8	
20511810	25286	20511810T	25287			3.00	.1181		48		22.0
20512000	25289				31		.1200	1-7/8		7/8	
20512200	25292					3.10	.1220		48		22.0
20512500	25295	20512500T	25296	1/8			.1250	1-7/8		7/8	
20512600	25298					3.20	.1260		48		22.0
20512850	25301				30		.1285	1-15/16		15/16	
20512990	25304					3.30	.1299		49		24.0
20513390	25307					3.40	.1339		49		24.0
20513600	25310				29		.1360	1-15/16		15/16	
20513780	25313	20513780T	25314			3.50	.1378		49		24.0
20514050	25316				28		.1405	1-15/16		15/16	
20514060	25319	20514060T	25320	9/64			.1406	1-15/16		15/16	
20514170	25322					3.60	.1417		49		24.0
20514400	25325				27		.1440	2-1/16		1	
20514570	25328					3.70	.1457		52		25.5
20514700	25331				26		.1470	2-1/16		1	
20514950	25334				25		.1495	2-1/16		1	
20514960	25337					3.80	.1496		52		25.5
20515200	25340				24		.1520	2-1/16		1	
20515350	25343					3.90	.1535		52		25.5
20515400	25346				23		.1540	2-1/16		1	
20515620	25349	20515620T	25350	5/32			.1562	2-1/16		1	
20515700	25352				22		.1570	2-1/8		1-1/16	
20515750	25355	20515750T	25356			4.00	.1575		54		27.0
20515900	25358				21		.1590	2-1/8		1-1/16	
20516100	25361				20		.1610	2-1/8		1-1/16	
20516140	25364					4.10	.1614		54		27.0



Series 205 Continued

Uncoated		TiN		Diameter				OAL		Flute Length	
				D				L1		L2	
Tool No.	EDP	Tool No.	EDP	Inch	Wire	mm	Decimal	Inch	mm	Inch	mm
20516540	25367					4.20	.1654		54		27.0
20516600	25370				19		.1660	2-1/8		1-1/16	
20516930	25373					4.30	.1693		54		27.0
20516950	25376				18		.1695	2-1/8		1-1/16	
20517190	25379	20517190T	25380	11/64			.1719	2-1/8		1-1/16	
20517300	25382				17		.1730	2-3/16		1-1/8	
20517320	25385					4.40	.1732		56		28.5
20517700	25388				16		.1770	2-3/16		1-1/8	
20517720	25391	20517720T	25392			4.50	.1772		56		28.5
20518000	25394				15		.1800	2-3/16		1-1/8	
20518110	25397					4.60	.1811		56		28.5
20518200	25400				14		.1820	2-3/16		1-1/8	
20518500	25403				13	4.70	.1850	2-3/16	56	1-1/8	28.5
20518750	25406	20518750T	25407	3/16			.1875	2-3/16		1-1/8	
20518890	25409					4.80	.1889		57		30.0
20518900	25412				12		.1890	2-1/4		1-3/16	
20519100	25415				11		.1910	2-1/4		1-3/16	
20519290	25418					4.90	.1929		57		30.0
20519350	25421				10		.1935	2-1/4		1-3/16	
20519600	25424				9		.1960	2-1/4		1-3/16	
20519680	25427	20519680T	25428			5.00	.1968		57		30.0
20519900	25430				8		.1990	2-1/4		1-3/16	
20520080	25433					5.10	.2008		57		30.0
20520100	25436				7		.2010	2-1/4		1-3/16	
20520310	25439	20520310T	25440	13/64			.2031	2-1/4		1-3/16	
20520400	25442				6		.2040	2-3/8		1-1/4	
20520470	25445					5.20	.2047		60		32.0
20520550	25448				5		.2055	2-3/8		1-1/4	
20520860	25451					5.30	.2086		60		32.0
20520900	25454				4		.2090	2-3/8		1-1/4	
20521260	25457					5.40	.2126		60		32.0
20521300	25460				3		.2130	2-3/8		1-1/4	
20521650	25463	20521650T	25464			5.50	.2165		60		32.0
20521870	25466	20521870T	25467	7/32			.2187	2-3/8		1-1/4	
20522050	25469					5.60	.2205		62		33.4
20522100	25472				2		.2210	2-7/16		1-5/16	
20522440	25475					5.70	.2244		62		33.4
20522800	25478				1		.2280	2-7/16		1-5/16	
20522830	25481					5.80	.2283		62		33.4
20523230	25484					5.90	.2323		62		33.4
20523400	25487				A		.2340	2-7/16		1-5/16	
20523440	25490	20523440T	25491	15/64			.2344	2-7/16		1-5/16	
20523620	25493	20523620T	25494			6.00	.2362		64		35.0
20523800	25496				B		.2380	2-1/2		1-3/8	
20524020	25499					6.10	.2402		64		35.0
20524200	25502				C		.2420	2-1/2		1-3/8	



Series 205 Continued

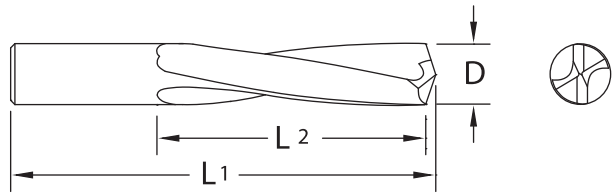
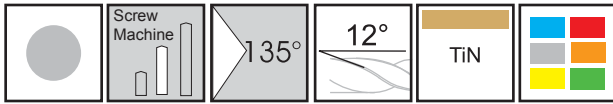

Uncoated		TiN		Diameter				OAL		Flute Length	
Tool No.	EDP	Tool No.	EDP	D				L1		L2	
				Inch	Wire	mm	Decimal	Inch	mm	Inch	mm
20524410	25505					6.20	.2441		64		35.0
20524600	25508				D		.2460	2-1/2		1-3/8	
20524800	25511					6.30	.2480		64		35.0
20525000	25514	20525000T	25515	1/4	E		.2500	2-1/2		1-3/8	
20525190	25517					6.40	.2519		64		35.0
20525590	25520	20525590T	25521			6.50	.2559		67		36.5
20525700	25523				F		.2570	2-5/8		1-7/16	
20525980	25526					6.60	.2598		67		36.5
20526100	25529				G		.2610	2-5/8		1-7/16	
20526370	25532					6.70	.2637		67		36.5
20526560	25535	20526560T	25536	17/64			.2656	2-5/8		1-7/16	
20526600	25538				H		.2660	2-11/16		1-1/2	
20526770	25541					6.80	.2677		68		38.0
20527160	25544					6.90	.2716		68		38.0
20527200	25547				I		.2720	2-11/16		1-1/2	
20527560	25550	20527560T	25551			7.00	.2756		68		38.0
20527700	25553				J		.2770	2-11/16		1-1/2	
20527950	25556					7.10	.2795		68		38.0
20528100	25559				K		.2810	2-11/16		1-1/2	
20528120	25562	20528120T	25563	9/32			.2812	2-11/16		1-1/2	
20528340	25565					7.20	.2834		68		38.0
20528740	25568					7.30	.2874		68		38.0
20529000	25571				L		.2900	2-3/4		1-9/16	
20529130	25574					7.40	.2913		70		39.5
20529500	25577				M		.2950	2-3/4		1-9/16	
20529530	25580	20529530T	25581			7.50	.2953		70		39.5
20529690	25583	20529690T	25584	19/64			.2969	2-3/4		1-9/16	
20529920	25586					7.60	.2992		70		39.5
20530200	25589				N		.3020	2-13/16		1-5/8	
20530310	25592					7.70	.3031		71		41.5
20530710	25595					7.80	.3071		71		41.5
20531100	25598					7.90	.3110		71		41.5
20531250	25601	20531250T	25602	5/16			.3125	2-13/16		1-5/8	
20531500	25604	20531500T	25605			8.00	.3150		71		41.5
20531600	25607				O		.3160	2-15/16		1-11/16	
20531890	25610					8.10	.3189		75		43.0
20532280	25613					8.20	.3228		75		43.0
20532300	25616				P		.3230	2-15/16		1-11/16	
20532670	25619					8.30	.3267		75		43.0
20532810	25622	20532810T	25623	21/64			.3281	2-15/16		1-11/16	
20533070	25625					8.40	.3307		75		43.0
20533200	25628				Q		.3320	2-15/16		1-11/16	



Series 205 Continued

Uncoated		TiN		Diameter				OAL		Flute Length	
Tool No.	EDP	Tool No.	EDP	D				L1		L2	
				Inch	Wire	mm	Decimal	Inch	mm	Inch	mm
20533460	25631	20533460T	25632			8.50	.3346		75		43.0
20533850	25634					8.60	.3385		75		43.0
20533900	25637				R		.3390	2-15/16		1-11/16	
20534250	25640					8.70	.3425		75		43.0
20534380	25643	20534380T	25644	11/32			.3438	2-15/16		1-11/16	
20534640	25646					8.80	.3464		75		43.0
20534800	25649				S		.3480	3-1/16		1-3/4	
20535040	25652					8.90	.3504		78		44.5
20535430	25655	20535430T	25656			9.00	.3543		78		44.5
20535800	25658				T		.3580	3-1/16		1-3/4	
20535820	25661					9.10	.3582		78		44.5
20535940	25664	20535940T	25665	23/64			.3594	3-1/16		1-3/4	
20536220	25667					9.20	.3622		78		44.5
20536610	25670					9.30	.3661		79		46.0
20536800	25673				U		.3680	3-1/8		1-13/16	
20537000	25676					9.40	.3700		79		46.0
20537400	25679	20537400T	25680			9.50	.3740		79		46.0
20537500	25682	20537500T	25683	3/8			.3750	3-1/8		1-13/16	
20537700	25685				V		.3770	3-1/4		1-7/8	
20537790	25688					9.60	.3779		83		47.5
20538190	25691					9.70	.3819		83		47.5
20538580	25694					9.80	.3858		83		47.5
20538600	25697				W		.3860	3-1/4		1-7/8	
20538970	25700					9.90	.3897		83		47.5
20539060	25703	20539060T	25704	25/64			.3906	3-1/4		1-7/8	
20539370	25706	20539370T	25707			10.00	.3937		84		49.0
20539700	25709				X		.3970	3-5/16		1-15/16	
20539760	25712					10.10	.3976		84		49.0
20540150	25715					10.20	.4015		84		49.0
20540400	25718				Y		.4040	3-5/16		1-15/16	
20540550	25721					10.30	.4055		84		49.0
20540620	25724	20540620T	25725	13/32			.4062	3-5/16		1-15/16	
20540940	25727					10.40	.4094		84		49.0
20541300	25730				Z		.4130	3-3/8		2	
20541340	25733	20541340T	25734			10.50	.4134		86		51.0
20541730	25736					10.60	.4173		86		51.0
20542120	25739					10.70	.4212		86		51.0
20542190	25742	20542190T	25743	27/64			.4219	3-3/8		2	
20542520	25745					10.80	.4252		86		51.0
20542910	25748					10.90	.4291		87		52.5
20543310	25751	20543310T	25752			11.00	.4331		87		52.5
20543700	25754					11.10	.4370		87		52.5
20543750	25757	20543750T	25758	7/16			.4375	3-7/16		2-1/16	
20544090	25760					11.20	.4409		87		52.5
20544490	25763					11.30	.4449		92		54.0
20544880	25766					11.40	.4488		92		54.0



Series 205 Continued

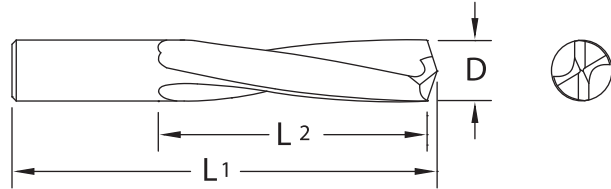
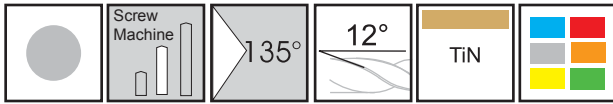

Uncoated		TiN		Diameter				OAL		Flute Length	
Tool No.	EDP	Tool No.	EDP	D				L1		L2	
				Inch	Wire	mm	Decimal	Inch	mm	Inch	mm
20545270	25769	20545270T	25770			11.50	.4527		92		54.0
20545310	25772	20545310T	25773	29/64			.4531	3-5/8		2-1/8	
20545670	25775					11.60	.4567		92		54.0
20546060	25778					11.70	.4606		92		54.0
20546450	25781					11.80	.4645		92		54.0
20546850	25784					11.90	.4685		92		54.0
20546880	25787	20546880T	25788	15/32			.4688	3-5/8		2-1/8	
20547240	25790	20547240T	25791			12.00	.4724		94		55.5
20548440	25793	20548440T	25794	31/64			.4844	3-11/16		2-3/16	
20549210	25796					12.50	.4921		95		57.0
20550000	25799	20550000T	25800	1/2			.5000	3-3/4		2-1/4	
20551180	25802	20551180T	25803			13.00	.5118		98		60.5
20551560	25805			33/64			.5156	3-7/8		2-3/8	
20553120	25808			17/32			.5312	3-7/8		2-3/8	
20553150	25811					13.50	.5315		102		63.5
20554690	25814			35/64			.5469	4		2-1/2	
20555120	25817	20555120T	25818			14.00	.5512		102		63.5
20556250	25820	20556250T	25821	9/16			.5625	4		2-1/2	
20557080	25823					14.50	.5708		105		66.5
20557810	25826			37/64			.5781	4-1/8		2-5/8	
20559050	25829	20559050T	25830			15.00	.5905		105		66.5
20559380	25832			19/32			.5938	4-1/8		2-5/8	
20560940	25835			39/64			.6094	4-1/4		2-3/4	
20561020	25838					15.50	.6102		108		70.0
20562500	25841	20562500T	25842	5/8			.6250	4-1/4		2-3/4	
20562990	25844	20562990T	25845			16.00	.6299		108		70.0
20564060	25847			41/64			.6406	4-1/2		2-7/8	
20564960	25850					16.50	.6496		114		73.0
20565620	25853			21/32			.6562	4-1/2		2-7/8	
20566930	25856	20566930T	25857			17.00	.6693		117		73.0
20567190	25859			43/64			.6719	4-5/8		2-7/8	
20568750	25862	20568750T	25863	11/16			.6875	4-5/8		2-7/8	
20568900	25865					17.50	.6890		121		76.0
20570310	25868			45/64			.7031	4-3/4		3	
20570870	25871	20570870T	25872			18.00	.7087		121		76.0
20571880	25874			23/32			.7188	4-3/4		3	
20572830	25877					18.50	.7283		127		79.5
20573440	25880			47/64			.7344	5		3-1/8	
20574800	25883	20574800T	25884			19.00	.7480		127		79.5
20575000	25886	20575000T	25887	3/4			.7500	5		3-1/8	
20576560	25889			49/64			.7656	5-1/4		3-1/4	
20578120	25892			25/32			.7812	5-1/4		3-1/4	
20578740	25895	20578740T	25896			20.00	.7874		133		82.5



Twister® GP Series 206

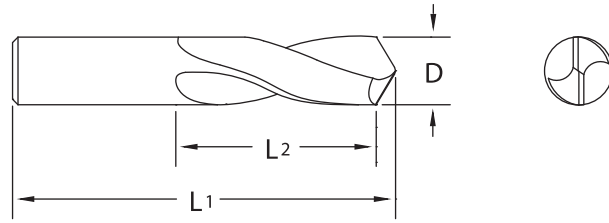
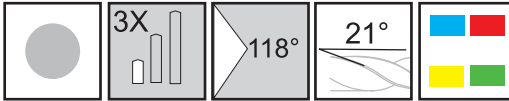

- Designed to allow high feed rates with good chip flow.
- Four facet drill point minimizes drill wander and assures accurately sized holes.
- Shorter length reduces deflection and vibration, increases drill accuracy and improves tool life.

Tool No.	EDP	Diameter			OAL	Flute Length
		D				
		Inch	Wire	Decimal	L1	L2
20604000	26004		60	.0400	1-1/2	3/8
20604100	26007		59	.0410	1-1/2	3/8
20604200	26013		58	.0420	1-1/2	3/8
20604300	26016		57	.0430	1-1/2	3/8
20604650	26025		56	.0465	1-1/2	3/8
20604690	26028	3/64		.0469	1-1/2	3/8
20605200	26040		55	.0520	1-1/2	3/8
20605500	26046		54	.0550	1-1/2	3/8
20605950	26058		53	.0595	1-1/2	3/8
20606250	26061	1/16		.0625	1-1/2	3/8
20606350	26067		52	.0635	1-1/2	3/8
20606700	26073		51	.0670	1-1/2	3/8
20607000	26076		50	.0700	1-1/2	3/8
20607300	26082		49	.0730	1-1/2	3/8
20607600	26088		48	.0760	1-1/2	1/2
20607810	26091	5/64		.0781	1-1/2	1/2
20607850	26094		47	.0785	1-1/2	1/2
20608100	26100		46	.0810	1-1/2	1/2
20608200	26103		45	.0820	1-1/2	1/2
20608600	26109		44	.0860	2	1/2
20608900	26115		43	.0890	2	1/2
20609350	26121		42	.0935	2	1/2
20609380	26124	3/32		.0938	2	1/2
20609600	26130		41	.0960	2	1/2
20609800	26133		40	.0980	2	5/8
20609950	26139		39	.0995	2	5/8
20610150	26142		38	.1015	2	5/8
20610400	26148		37	.1040	2	5/8
20610650	26154		36	.1065	2	5/8
20610940	26157	7/64		.1094	2	5/8
20611000	26160		35	.1100	2	5/8
20611100	26166		34	.1110	2	5/8
20611300	26169		33	.1130	2	5/8
20611600	26175		32	.1160	2	5/8

Tool No.	EDP	Diameter			OAL	Flute Length
		D				
		Inch	Wire	Decimal	L1	L2
20612000	26181		31	.1200	2	5/8
20612500	26187	1/8		.1250	2	5/8
20612850	26193		30	.1285	2	5/8
20613600	26202		29	.1360	2	5/8
20614050	26208		28	.1405	2	5/8
20614060	26211	9/64		.1406	2	5/8
20614400	26217		27	.1440	2	5/8
20614700	26223		26	.1470	2	5/8
20614950	26226		25	.1495	2	5/8
20615200	26232		24	.1520	2	5/8
20615400	26238		23	.1540	2	5/8
20615620	26241	5/32		.1562	2	3/4
20615700	26244		22	.1570	2	3/4
20615900	26250		21	.1590	2	3/4
20616100	26253		20	.1610	2	3/4
20616600	26262		19	.1660	2-1/8	3/4
20616950	26268		18	.1695	2-1/8	3/4
20617190	26271	11/64		.1719	2-1/8	3/4
20617300	26274		17	.1730	2-1/8	3/4
20617700	26280		16	.1770	2-1/8	3/4
20618000	26286		15	.1800	2-3/16	3/4
20618200	26292		14	.1820	2-3/16	3/4
20618500	26295		13	.1850	2-3/16	3/4
20618750	26298	3/16		.1875	2-3/16	3/4
20618900	26304		12	.1890	2-3/16	3/4
20619100	26307		11	.1910	2-3/16	3/4
20619350	26313		10	.1935	2-3/16	3/4
20619600	26316		9	.1960	2-1/4	3/4

Inch	
D	Tolerance
.0400 - .7812	+.0000/- .0005

See Series 226 on page 117 for mm size Stub Drills



Series 206 Continued

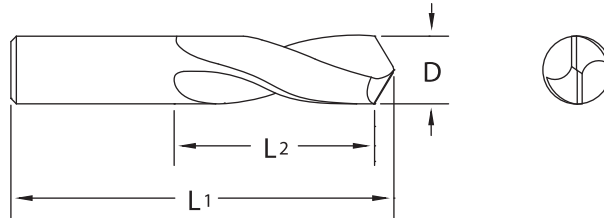
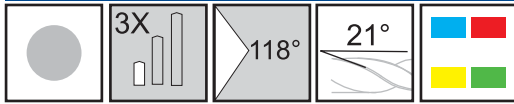

Tool No.	EDP	Diameter			OAL	Flute Length
		D				
		Inch	Wire	Decimal		
20619900	26322		8	.1990	2-1/4	3/4
20620100	26328		7	.2010	2-1/4	3/4
20620310	26331	13/64		.2031	2-1/4	3/4
20620400	26334		6	.2040	2-1/4	3/4
20620550	26340		5	.2055	2-1/4	3/4
20620900	26346		4	.2090	2-1/4	3/4
20621300	26352		3	.2130	2-1/2	1
20621870	26358	7/32		.2187	2-1/2	1
20622100	26364		2	.2210	2-1/2	1
20622800	26370		1	.2280	2-1/2	1
20623400	26379		A	.2340	2-1/2	1
20623440	26382	15/64		.2344	2-1/2	1
20623800	26388		B	.2380	2-1/2	1
20624200	26394		C	.2420	2-1/2	1
20624600	26400		D	.2460	2-1/2	1
20625000	26406	1/4	E	.2500	2-1/2	1
20625700	26415		F	.2570	2-1/2	1
20626100	26421		G	.2610	2-1/2	1
20626560	26427	17/64		.2656	2-1/2	1
20626600	26430		H	.2660	2-1/2	1
20627200	26439		I	.2720	2-1/2	1
20627700	26445		J	.2770	2-1/2	1
20628100	26451		K	.2810	2-1/2	1
20628120	26454	9/32		.2812	2-1/2	1
20629000	26463		L	.2900	2-1/2	1
20629500	26469		M	.2950	2-1/2	1-1/4
20629690	26475	19/64		.2969	2-1/2	1-1/4
20630200	26481		N	.3020	2-1/2	1-1/4
20631250	26493	5/16		.3125	2-1/2	1-1/4
20631600	26499		O	.3160	2-1/2	1-1/4
20632300	26508		P	.3230	2-1/2	1-1/4
20632810	26514	21/64		.3281	2-1/2	1-1/4
20633200	26520		Q	.3320	2-1/2	1-1/4
20633900	26529		R	.3390	2-1/2	1-1/4
20634380	26535	11/32		.3438	2-1/2	1-1/4
20634800	26541		S	.3480	2-1/2	1-1/4
20635800	26550		T	.3580	2-1/2	1-1/4
20635940	26556	23/64		.3594	2-1/2	1-1/4
20636800	26565		U	.3680	2-1/2	1-1/4
20637500	26574	3/8		.3750	2-1/2	1-1/4

Tool No.	EDP	Diameter			OAL	Flute Length
		D				
		Inch	Wire	Decimal		
20637700	26577		V	.3770	2-1/2	1-1/4
20638600	26589		W	.3860	2-3/4	1-1/4
20639060	26595	25/64		.3906	2-3/4	1-1/4
20639700	26601		X	.3970	2-3/4	1-1/4
20640400	26610		Y	.4040	2-3/4	1-1/4
20640620	26616	13/32		.4062	2-3/4	1-1/4
20641300	26622		Z	.4130	2-3/4	1-1/4
20642190	26634	27/64		.4219	2-3/4	1-1/4
20643750	26649	7/16		.4375	2-3/4	1-1/4
20645310	26664	29/64		.4531	3	1-1/4
20646880	26679	15/32		.4688	3	1-1/4
20648440	26685	31/64		.4844	3	1-1/4
20650000	26691	1/2		.5000	3	1-1/4
20651560	26697	33/64		.5156	3-1/2	1-3/8
20653120	26700	17/32		.5312	3-1/2	1-3/8
20654690	26706	35/64		.5469	3-1/2	1-1/2
20656250	26712	9/16		.5625	3-1/2	1-1/2
20657810	26718	37/64		.5781	3-1/2	1-5/8
20659380	26724	19/32		.5938	3-1/2	1-5/8
20660940	26727	39/64		.6094	3-1/2	1-3/4
20662500	26733	5/8		.6250	3-1/2	1-3/4
20664060	26739	41/64		.6406	4	1-7/8
20665620	26745	21/32		.6562	4	1-7/8
20667190	26751	43/64		.6719	4	1-7/8
20668750	26754	11/16		.6875	4	1-7/8
20670310	26760	45/64		.7031	4	2
20671880	26766	23/32		.7188	4	2-1/8
20673440	26772	47/64		.7344	4	2-1/8
20675000	26778	3/4		.7500	4	2-1/8
20676560	26781	49/64		.7656	4	2-1/4
20678120	26784	25/32		.7812	4	2-1/4

See Series 226 on page 117 for mm size Stub Drills



Twister® GP Series 207

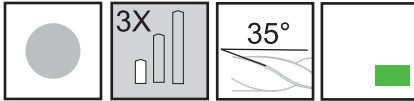

Designed for drilling Carbon Fiber Reinforced Polymer (CFRP), graphite and aramid fiber (kevlar) reinforced composite materials.

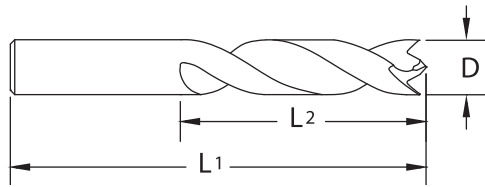

- No delamination.
- Eliminate fuzz or "fray" at exit.
- Brad and spur point.

Tool No.	EDP	Diameter				OAL		Flute Length	
		D				L1		L2	
		Inch	Wire	mm	Decimal	Inch	mm	Inch	mm
20709350	27001		42		.0935	1-3/4		1/2	
20709380	27004	3/32			.0938	1-3/4		1/2	
20709450	27007			2.40	.0945		44		12.5
20709600	27010		41		.0960	1-13/16		1/2	
20709800	27013		40		.0980	1-13/16		1/2	
20709840	27016			2.50	.0984		46		12.5
20709950	27019		39		.0995	1-13/16		1/2	
20710150	27022		38		.1015	1-13/16		1/2	
20710240	27025			2.60	.1024		46		12.5
20710400	27028		37		.1040	1-13/16		1/2	
20710630	27031			2.70	.1063		46		12.5
20710650	27034		36		.1065	1-13/16		1/2	
20710940	27037	7/64			.1094	1-13/16		1/2	
20711000	27040		35		.1100	1-7/8		5/8	
20711020	27043			2.80	.1102		48		16.0
20711100	27046		34		.1110	1-7/8		5/8	
20711300	27049		33		.1130	1-7/8		5/8	
20711420	27052			2.90	.1142		48		16.0
20711600	27055		32		.1160	1-7/8		5/8	
20711810	27058			3.00	.1181		48		16.0
20712000	27061		31		.1200	1-7/8		5/8	
20712200	27064			3.10	.1220		48		16.0
20712500	27067	1/8			.1250	1-7/8		5/8	
20712600	27070			3.20	.1260		48		16.0
20712850	27073		30		.1285	1-15/16		11/16	
20712990	27076			3.30	.1299		49		17.5
20713390	27079			3.40	.1339		49		17.5
20713600	27082		29		.1360	1-15/16		11/16	
20713780	27085			3.50	.1378		49		17.5
20714050	27088		28		.1405	1-15/16		11/16	
20714060	27091	9/64			.1406	1-15/16		11/16	
20714170	27094			3.60	.1417		49		17.5
20714400	27097		27		.1440	2-1/16		3/4	
20714570	27100			3.70	.1457		52		19.0
20714700	27103		26		.1470	2-1/16		3/4	
20714950	27106		25		.1495	2-1/16		3/4	
20714960	27109			3.80	.1496		52		19.0
20715200	27112		24		.1520	2-1/16		3/4	

Inch	
D	Tolerance
.0935 - .5000	+0.0000/-0.0005

Metric (mm)	
D	Tolerance
2.40 - 12.00	+0.000/-0.013



Series 207 Continued

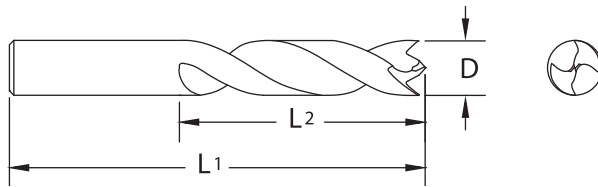
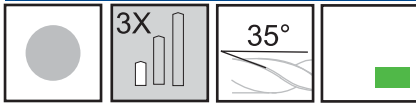

Tool No.	EDP	Diameter				OAL		Flute Length	
		D				L1		L2	
		Inch	Wire	mm	Decimal	Inch	mm	Inch	mm
20715350	27115			3.90	.1535		52		19.0
20715400	27118		23		.1540	2-1/16		3/4	
20715620	27121	5/32			.1562	2-1/16		3/4	
20715700	27124		22		.1570	2-1/8		7/8	
20715750	27127			4.00	.1575		54		22.0
20715900	27130		21		.1590	2-1/8		7/8	
20716100	27133		20		.1610	2-1/8		7/8	
20716140	27136			4.10	.1614		54		22.0
20716540	27139			4.20	.1654		54		22.0
20716600	27142		19		.1660	2-1/8		7/8	
20716930	27145			4.30	.1693		54		22.0
20716950	27148		18		.1695	2-1/8		7/8	
20717190	27151	11/64			.1719	2-1/8		7/8	
20717300	27154		17		.1730	2-3/16		15/16	
20717320	27157			4.40	.1732		56		24.0
20717700	27160		16		.1770	2-3/16		15/16	
20717720	27163			4.50	.1772		56		24.0
20718000	27166		15		.1800	2-3/16		15/16	
20718110	27169			4.60	.1811		56		24.0
20718200	27172		14		.1820	2-3/16		15/16	
20718500	27175		13	4.7	.1850	2-3/16	56	15/16	24.0
20718750	27178	3/16			.1875	2-3/16		15/16	
20718890	27181			4.80	.1889		57		25.5
20718900	27184		12		.1890	2-1/4		1	
20719100	27187		11		.1910	2-1/4		1	
20719290	27190			4.90	.1929		57		25.5
20719350	27193		10		.1935	2-1/4		1	
20719600	27196		9		.1960	2-1/4		1	
20719680	27199			5.00	.1968		57		25.5
20719900	27202		8		.1990	2-1/4		1	
20720080	27205			5.10	.2008		57		25.5
20720100	27208		7		.2010	2-1/4		1	
20720310	27211	13/64			.2031	2-1/4		1	
20720400	27214		6		.2040	2-3/8		1-1/16	
20720470	27217			5.20	.2047		60		27.0
20720550	27220		5		.2055	2-3/8		1-1/16	
20720860	27223			5.30	.2086		60		27.0
20720900	27226		4		.2090	2-3/8		1-1/16	
20721260	27229			5.40	.2126		60		27.0
20721300	27232		3		.2130	2-3/8		1-1/16	
20721650	27235			5.50	.2165		60		27.0
20721870	27238	7/32			.2187	2-3/8		1-1/16	



Series 207 Continued

Tool No.	EDP	Diameter				OAL		Flute Length	
		D				L1		L2	
		Inch	Wire	mm	Decimal	Inch	mm	Inch	mm
20722050	27241			5.60	.2205		62		28.5
20722100	27244		2		.2210	2-7/16		1-1/8	
20722440	27247			5.70	.2244		62		28.5
20722800	27250		1		.2280	2-7/16		1-1/8	
20722830	27253			5.80	.2283		62		28.5
20723230	27256			5.90	.2323		62		28.5
20723400	27259		A		.2340	2-7/16		1-1/8	
20723440	27262	15/64			.2344	2-7/16		1-1/8	
20723620	27265			6.00	.2362		64		32.0
20723800	27268		B		.2380	2-1/2		1-1/4	
20724020	27271			6.10	.2402		64		32.0
20724200	27274		C		.2420	2-1/2		1-1/4	
20724410	27277			6.20	.2441		64		32.0
20724600	27280		D		.2460	2-1/2		1-1/4	
20724800	27283			6.30	.2480		64		32.0
20725000	27286	1/4	E		.2500	2-1/2		1-1/4	
20725190	27289			6.40	.2519		64		32.0
20725590	27292			6.50	.2559		67		33.5
20725700	27295		F		.2570	2-5/8		1-5/16	
20726100	27298		G		.2610	2-5/8		1-5/16	
20726560	27301	17/64			.2656	2-5/8		1-5/16	
20726600	27304		H		.2660	2-11/16		1-3/8	
20727200	27307		I		.2720	2-11/16		1-3/8	
20727560	27310			7.00	.2756		68		35.0
20727700	27313		J		.2770	2-11/16		1-3/8	
20728100	27316		K		.2810	2-11/16		1-3/8	
20728120	27319	9/32			.2812	2-11/16		1-3/8	
20729000	27322		L		.2900	2-3/4		1-3/8	
20729500	27325		M		.2950	2-3/4		1-3/8	
20729530	27328			7.50	.2953		70		35.0
20729690	27331	19/64			.2969	2-3/4		1-3/8	
20730200	27334		N		.3020	2-13/16		1-1/2	
20731250	27337	5/16			.3125	2-13/16		1-1/2	
20731500	27340			8.00	.3150		71		38.0
20731600	27343		O		.3160	2-15/16		1-9/16	
20732300	27346		P		.3230	2-15/16		1-9/16	
20732810	27349	21/64			.3281	2-15/16		1-9/16	
20733200	27352		Q		.3320	2-15/16		1-9/16	
20733460	27355			8.50	.3346		75		39.5
20733900	27358		R		.3390	2-15/16		1-9/16	
20734380	27361	11/32			.3438	2-15/16		1-9/16	
20734800	27364		S		.3480	3-1/16		1-9/16	
20735430	27367			9.00	.3543		78		39.5
20735800	27370		T		.3580	3-1/16		1-9/16	



Series 207 Continued

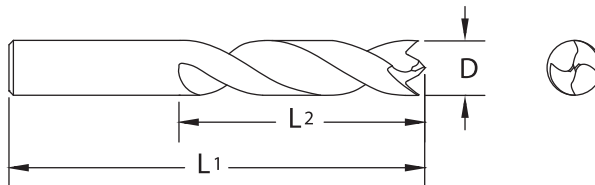
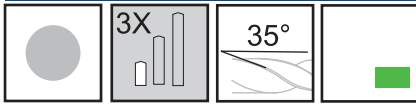

Tool No.	EDP	Diameter				OAL		Flute Length	
		D				L1		L2	
		Inch	Wire	mm	Decimal	Inch	mm	Inch	mm
20735940	27373	23/64			.3594	3-1/16		1-9/16	
20736800	27376		U		.3680	3-1/8		1-5/8	
20737400	27379			9.50	.3740		79		41.5
20737500	27382	3/8			.3750	3-1/8		1-5/8	
20737700	27385		V		.3770	3-1/4		1-3/4	
20738600	27388		W		.3860	3-1/4		1-3/4	
20739060	27391	25/64			.3906	3-1/4		1-3/4	
20739370	27394			10.00	.3937		84		44.5
20739700	27397		X		.3970	3-5/16		1-3/4	
20740400	27400		Y		.4040	3-5/16		1-3/4	
20740620	27403	13/32			.4062	3-5/16		1-3/4	
20741300	27406		Z		.4130	3-3/8		1-13/16	
20741340	27409			10.50	.4134		86		46.0
20742190	27412	27/64			.4219	3-3/8		1-13/16	
20743310	27415			11.00	.4331		87		47.5
20743750	27418	7/16			.4375	3-7/16		1-7/8	
20745270	27421			11.50	.4527		92		51.0
20745310	27424	29/64			.4531	3-5/8		2	
20746880	27427	15/32			.4688	3-5/8		2	
20747240	27430			12.00	.4724		94		54.0
20748440	27433	31/64			.4844	3-11/16		2-1/8	
20750000	27436	1/2			.5000	3-3/4		2-1/8	



ISO 9001:2008 Certified



Twister® GP Series 209

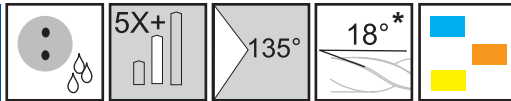

Designed for tougher drilling applications similar to the Hi-Tuff® on page 98. Ideal for drilling materials such as stainless steel, tool steel, titanium and other high tensile strength metals. Also well suited for increased efficiency in deep hole drilling of many materials.

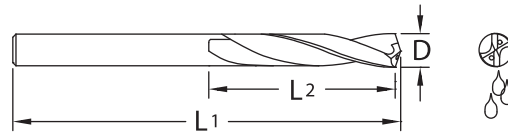

- Coolant volume aids in ejecting chips from hole.
- Excellent for increased feed rates, lower drilling temperatures and longer tool life.

Tool No.	EDP	Diameter				OAL		Flute Length	
		D				L1		L2	
		Inch	Letter/Wire	mm	Decimal	Inch	mm	Inch	mm
20918750	29001	3/16			.1875	4-3/16		1-5/8	
20918890	29004			4.8	.1889		106		41.5
20918900	29007		12		.1890	4-3/16		1-5/8	
20919100	29010		11		.1910	4-3/16		1-5/8	
20919290	29013			4.9	.1929		106		41.5
20919350	29016		10		.1935	4-3/16		1-5/8	
20919600	29019		9		.1960	4-3/8		1-3/4	
20919680	29022			5.0	.1968		111		44.5
20919900	29025		8		.1990	4-3/8		1-3/4	
20920080	29028			5.1	.2008		111		44.5
20920100	29031		7		.2010	4-3/8		1-3/4	
20920310	29034	13/64			.2031	4-3/8		1-3/4	
20920400	29037		6		.2040	4-3/8		1-3/4	
20920470	29040			5.2	.2047		111		44.5
20920550	29043		5		.2055	4-3/8		1-3/4	
20920860	29046			5.3	.2086		111		44.5
20920900	29049		4		.2090	4-3/8		1-3/4	
20921260	29052			5.4	.2126		111		44.5
20921300	29055		3		.2130	4-3/8		1-3/4	
20921650	29058			5.5	.2165		111		44.5
20921870	29061	7/32			.2187	4-3/8		1-3/4	
20922050	29064			5.6	.2205		111		44.5
20922100	29067		2		.2210	4-3/8		1-3/4	
20922440	29070			5.7	.2244		111		44.5
20922800	29073		1		.2280	4-3/8		1-3/4	
20922830	29076			5.8	.2283		121		51.0
20923230	29079			5.9	.2323		121		51.0
20923400	29082		A		.2340	4-3/4		2	
20923440	29085	15/64			.2344	4-3/4		2	
20923620	29088			6.0	.2362		121		51.0
20923800	29091		B		.2380	4-3/4		2	
20924020	29094			6.1	.2402		121		51.0
20924200	29097		C		.2420	4-3/4		2	
20924410	29100			6.2	.2441		121		51.0

Inch	
D	Tolerance
.1875 - .7812	+0.000/-0.0005

Metric (mm)	
D	Tolerance
4.80 - 20.00	+0.000/-0.013

*Drills manufactured after 8/1/2012 have 30° helix angle.



Series 209 Continued

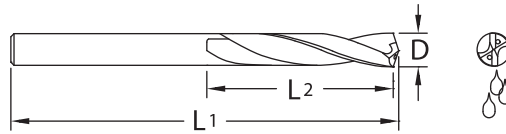
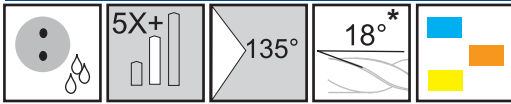

Tool No.	EDP	Diameter				OAL		Flute Length	
		D				L1		L2	
		Inch	Letter/ Wire	mm	Decimal	Inch	mm	Inch	mm
20924600	29103		D		.2460	4-3/4		2	
20924800	29106			6.3	.2480		121		51.0
20925000	29109	1/4	E		.2500	4-3/4		2	
20925190	29112			6.4	.2519		121		51.0
20925590	29115			6.5	.2559		121		51.0
20925700	29118		F		.2570	4-3/4		2	
20926100	29121		G		.2610	4-7/8		2-1/8	
20926560	29124	17/64			.2656	4-7/8		2-1/8	
20926600	29127		H		.2660	4-7/8		2-1/8	
20927200	29130		I		.2720	4-7/8		2-1/8	
20927560	29133			7.0	.2756		124		54.0
20927700	29136		J		.2770	4-7/8		2-1/8	
20928100	29139		K		.2810	4-7/8		2-1/8	
20928120	29142	9/32			.2812	4-7/8		2-1/8	
20929000	29145		L		.2900	4-7/8		2-1/8	
20929500	29148		M		.2950	5-3/16		2-3/8	
20929530	29151			7.5	.2953		132		60.5
20929690	29154	19/64			.2969	5-3/16		2-3/8	
20930200	29157		N		.3020	5-3/16		2-3/8	
20931250	29160	5/16			.3125	5-3/16		2-3/8	
20931500	29163			8.0	.3150		132		60.5
20931600	29166		O		.3160	5-3/16		2-3/8	
20932300	29169		P		.3230	5-3/16		2-3/8	
20932810	29172	21/64			.3281	5-3/8		2-1/2	
20933200	29175		Q		.3320	5-3/8		2-1/2	
20933460	29178			8.5	.3346		137		63.5
20933900	29181		R		.3390	5-3/8		2-1/2	
20934380	29184	11/32			.3438	5-3/8		2-1/2	
20934800	29187		S		.3480	5-3/8		2-1/2	
20935430	29190			9.0	.3543		146		70.0
20935800	29193		T		.3580	5-3/4		2-3/4	
20935940	29196	23/64			.3594	5-3/4		2-3/4	
20936800	29199		U		.3680	5-3/4		2-3/4	
20937400	29202			9.5	.3740		146		70.0
20937500	29205	3/8			.3750	5-3/4		2-3/4	
20937700	29208		V		.3770	6		2-7/8	
20938600	29211		W		.3860	6		2-7/8	
20939060	29214	25/64			.3906	6		2-7/8	
20939370	29217			10.0	.3937		152		73.0
20939700	29220		X		.3970	6		2-7/8	
20940400	29223		Y		.4040	6		2-7/8	
20940620	29226	13/32			.4062	6		2-7/8	

*Drills manufactured after 8/1/2012 have 30° helix angle.



Series 209 Continued

Tool No.	EDP	Diameter				OAL		Flute Length	
		D				L1		L2	
		Inch	Letter/ Wire	mm	Decimal	Inch	mm	Inch	mm
20941300	29229		Z		.4130	6		2-7/8	
20941340	29232			10.5	.4134		152		73.0
20942190	29235	27/64			.4219	6		2-7/8	
20943310	29238			11.0	.4331		152		73.0
20943750	29241	7/16			.4375	6		2-7/8	
20945270	29244			11.5	.4527		159		76.0
20945310	29247	29/64			.4531	6-1/4		3	
20946880	29250	15/32			.4688	6-1/4		3	
20947240	29253			12.0	.4724		159		76.0
20948440	29256	31/64			.4844	6-1/4		3	
20949210	29259			12.5	.4921		159		76.0
20950000	29262	1/2			.5000	6-1/4		3	
20951180	29265			13.0	.5118		171		82.5
20951560	29268	33/64			.5156	6-3/4		3-1/4	
20953120	29271	17/32			.5312	6-3/4		3-1/4	
20953150	29274			13.5	.5315		171		82.5
20954690	29277	35/64			.5469	6-3/4		3-1/4	
20955120	29280			14.0	.5512		171		82.5
20956250	29283	9/16			.5625	6-3/4		3-1/4	
20957080	29286			14.5	.5708		187		89.0
20957810	29289	37/64			.5781	7-3/8		3-1/2	
20959050	29292			15.0	.5905		187		89.0
20959380	29295	19/32			.5938	7-3/8		3-1/2	
20960940	29298	39/64			.6094	7-3/8		3-1/2	
20961020	29301			15.5	.6102		187		89.0
20962500	29304	5/8			.6250	7-3/8		3-1/2	
20962990	29307			16.0	.6299		187		89.0
20964060	29310	41/64			.6406	7-3/4		3-5/8	
20964960	29313			16.5	.6496		197		92.0
20965620	29316	21/32			.6562	7-3/4		3-5/8	
20966930	29319			17.0	.6693		197		92.0
20967190	29322	43/64			.6719	7-3/4		3-5/8	
20968750	29325	11/16			.6875	7-3/4		3-5/8	
20968900	29328			17.5	.6890		210		98.5
20970310	29331	45/64			.7031	8-1/4		3-7/8	
20970870	29334			18.0	.7087		210		98.5
20971880	29337	23/32			.7188	8-1/4		3-7/8	
20972830	29340			18.5	.7283		210		98.5
20973440	29343	47/64			.7344	8-1/4		3-7/8	
20974800	29346			19.0	.7480		210		98.5
20975000	29349	3/4			.7500	8-1/4		3-7/8	
20976560	29352	49/64			.7656	8-5/8		4	
20978120	29355	25/32			.7812	8-5/8		4	
20978740	29358			20.0	.7874		219		101.5



Twister® GP Series 210

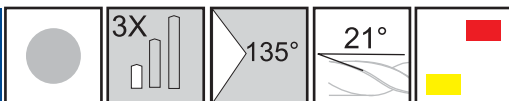

Designed for drilling highly alloyed ferrous metals including stainless steel, nickel based alloys and titanium. Also suitable for drilling materials which produce powder like chips such as cast iron. Not recommended for non-ferrous materials.



• 3 Flute Drill.

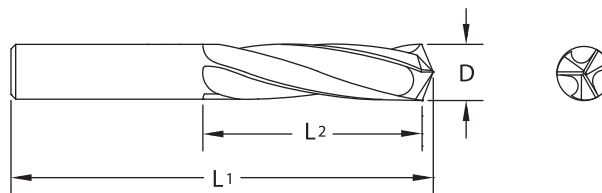

Tool No.	EDP	Diameter				OAL		Flute Length	
		D				L1		L2	
		Inch	Wire	mm	Decimal	Inch	mm	Inch	mm
21011300	21010		33		.1130	1-7/8		3/4	
21011600	21016		32		.1160	1-7/8		3/4	
21012000	21022		31		.1200	1-7/8		3/4	
21012500	21028	1/8			.1250	1-7/8		3/4	
21013600	21043		29		.1360	1-15/16		13/16	
21014050	21049		28		.1405	1-15/16		13/16	
21014060	21052	9/64			.1406	1-15/16		13/16	
21015620	21082	5/32			.1562	2-1/16		27/32	
21017190	21112	11/64			.1719	2-1/8		7/8	
21018750	21139	3/16			.1875	2-3/16		15/16	
21020310	21172	13/64			.2031	2-1/4		1	
21020550	21181		5		.2055	2-3/8		1-1/16	
21021870	21199	7/32			.2187	2-3/8		1-1/16	
21023440	21223	15/64			.2344	2-7/16		1-1/8	
21025000	21247	1/4	E		.2500	2-1/2		1-3/16	
21026560	21262	17/64			.2656	2-5/8		1-1/4	
21028100	21277		K		.2810	2-11/16		1-5/16	
21028120	21280	9/32			.2812	2-11/16		1-5/16	
21029690	21292	19/64			.2969	2-3/4		1-3/8	
21031250	21298	5/16			.3125	2-13/16		1-7/16	
21032810	21310	21/64			.3281	2-15/16		1-1/2	
21034380	21322	11/32			.3438	2-15/16		1-1/2	
21035940	21334	23/64			.3594	3-1/16		1-9/16	
21037500	21343	3/8			.3750	3-1/8		1-19/32	
21039060	21352	25/64			.3906	3-1/4		1-5/8	
21040620	21364	13/32			.4062	3-5/16		1-5/8	
21041300	21367		Z		.4130	3-3/8		1-21/32	
21042190	21373	27/64			.4219	3-3/8		1-21/32	
21043750	21379	7/16			.4375	3-7/16		1-3/4	
21048440	21394	31/64			.4844	3-11/16		2	
21050000	21400	1/2			.5000	3-3/4		2	
21053120	21409	17/32			.5312	3-7/8		2	
21056250	21421	9/16			.5625	4		2-1/8	
21057810	21427	37/64			.5781	4-1/8		2-1/8	
21065620	21454	21/32			.6562	4-1/2		2-7/8	
21075000	21487	3/4			.7500	5		3-1/8	

Inch	
D	Tolerance
.1130 - .7500	+.0000/- .0005

For Drilling Aluminum see Twister® AL Series 229 on page 77 and the new Cyclone DA Series on page 41.



Twister® GP Series 224



- Designed to allow high feed rates with good chip flow.
- Four facet drill point minimizes drill wander and assures accurately sized holes.

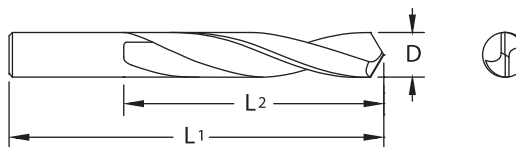

Tool No.	EDP	Diameter		OAL	Flute Length	
		D			L1	L2
		mm	Decimal			
22401180	24002	0.30	.0118	26	3	
22401380	24008	0.35	.0138	26	4	
22401570	24017	0.40	.0157	26	5	
22401770	24023	0.45	.0177	26	5	
22401970	24029	0.50	.0197	26	6	
22402170	24038	0.55	.0217	26	7	
22402360	24044	0.60	.0236	26	7	
22402560	24053	0.65	.0256	26	8	
22402760	24059	0.70	.0276	28	9	
22402950	24068	0.75	.0295	28	9	
22403150	24077	0.80	.0315	30	10	
22403350	24086	0.85	.0335	30	10	
22403540	24092	0.90	.0354	32	11	
22403740	24101	0.95	.0374	32	11	
22403940	24110	1.00	.0394	34	12	
22404130	24119	1.05	.0413	34	12	
22404330	24128	1.10	.0433	36	14	
22404520	24131	1.15	.0452	36	14	
22404720	24140	1.20	.0472	38	16	
22404920	24143	1.25	.0492	38	16	
22405110	24146	1.30	.0511	38	16	
22405310	24152	1.35	.0531	40	18	
22405510	24158	1.40	.0551	40	18	
22405710	24161	1.45	.0571	40	18	
22405900	24164	1.50	.0590	40	18	
22406300	24173	1.60	.0630	43	20	
22406690	24179	1.70	.0669	43	20	
22407080	24188	1.80	.0708	46	22	
22407480	24194	1.90	.0748	46	22	
22407870	24206	2.00	.0787	49	24	
22408270	24215	2.10	.0827	49	24	
22408660	24221	2.20	.0866	53	27	
22409060	24227	2.30	.0906	53	27	
22409450	24236	2.40	.0945	57	30	
22409840	24245	2.50	.0984	57	30	
22410240	24254	2.60	.1024	57	30	
22410630	24260	2.70	.1063	61	33	
22411020	24272	2.80	.1102	61	33	
22411420	24281	2.90	.1142	61	33	
22411810	24287	3.00	.1181	61	33	
22412200	24293	3.10	.1220	65	36	
22412600	24299	3.20	.1260	65	36	
22412990	24305	3.30	.1299	65	36	
22413390	24308	3.40	.1339	70	39	
22413780	24314	3.50	.1378	70	39	
22414170	24323	3.60	.1417	70	39	
22414570	24329	3.70	.1457	70	39	
22414960	24338	3.80	.1496	75	43	
22415350	24344	3.90	.1535	75	43	
22415750	24356	4.00	.1575	75	43	
22416140	24365	4.10	.1614	75	43	
22416540	24368	4.20	.1654	75	43	
22416930	24374	4.30	.1693	80	47	
22417320	24386	4.40	.1732	80	47	
22417720	24392	4.50	.1772	80	47	
22418110	24398	4.60	.1811	80	47	
22418500	24404	4.70	.1850	80	47	
22418890	24410	4.80	.1889	86	52	
22419290	24419	4.90	.1929	86	52	
22419680	24428	5.00	.1968	86	52	
22420080	24434	5.10	.2008	86	52	
22420470	24446	5.20	.2047	86	52	
22420860	24452	5.30	.2086	86	52	
22421260	24458	5.40	.2126	93	57	
22421650	24464	5.50	.2165	93	57	
22422050	24470	5.60	.2205	93	57	
22422440	24476	5.70	.2244	93	57	
22422830	24482	5.80	.2283	93	57	
22423230	24485	5.90	.2323	93	57	
22423620	24494	6.00	.2362	93	57	
22424020	24500	6.10	.2402	101	63	
22424410	24506	6.20	.2441	101	63	

Metric (mm)	
D	Tolerance
0.30 - 20.00	+ .000/- .013

See Series 204 on page 96 for inch size Jobber Drills.



Series 224 Continued

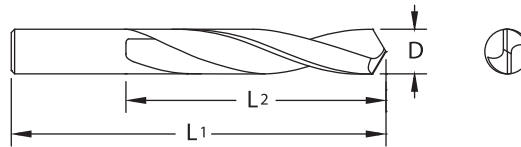
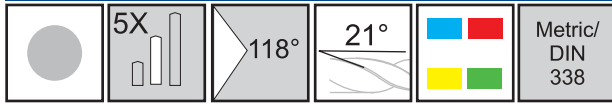

Tool No.	EDP	Diameter		OAL	Flute Length
		D			
		mm	Decimal	L1	L2
22424800	24512	6.30	.2480	101	63
22425190	24518	6.40	.2519	101	63
22425590	24521	6.50	.2559	101	63
22425980	24527	6.60	.2598	101	63
22426370	24533	6.70	.2637	101	63
22426770	24542	6.80	.2677	109	69
22427160	24545	6.90	.2716	109	69
22427560	24551	7.00	.2756	109	69
22427950	24557	7.10	.2795	109	69
22428340	24566	7.20	.2834	109	69
22428740	24569	7.30	.2874	109	69
22429130	24575	7.40	.2913	109	69
22429530	24581	7.50	.2953	109	69
22429920	24587	7.60	.2992	117	75
22430310	24593	7.70	.3031	117	75
22430710	24596	7.80	.3071	117	75
22431100	24599	7.90	.3110	117	75
22431500	24605	8.00	.3150	117	75
22431890	24611	8.10	.3189	117	75
22432280	24614	8.20	.3228	117	75
22432670	24620	8.30	.3267	117	75
22433070	24626	8.40	.3307	117	75
22433460	24632	8.50	.3346	117	75
22433850	24635	8.60	.3385	125	81
22434250	24641	8.70	.3425	125	81
22434640	24647	8.80	.3464	125	81
22435040	24653	8.90	.3504	125	81
22435430	24656	9.00	.3543	125	81
22435820	24662	9.10	.3582	125	81
22436220	24668	9.20	.3622	125	81
22436610	24671	9.30	.3661	125	81
22437000	24677	9.40	.3700	125	81
22437400	24680	9.50	.3740	125	81
22437790	24689	9.60	.3779	133	87
22438190	24692	9.70	.3819	133	87
22438580	24695	9.80	.3858	133	87
22438970	24701	9.90	.3897	133	87
22439370	24707	10.00	.3937	133	87
22439760	24713	10.10	.3976	133	87
22440150	24716	10.20	.4015	133	87
22440550	24722	10.30	.4055	133	87
22440940	24728	10.40	.4094	133	87

Tool No.	EDP	Diameter		OAL	Flute Length
		D			
		mm	Decimal	L1	L2
22441340	24734	10.50	.4134	133	87
22441730	24737	10.60	.4173	133	87
22442120	24740	10.70	.4212	142	94
22442520	24746	10.80	.4252	142	94
22442910	24749	10.90	.4291	142	94
22443310	24752	11.00	.4331	142	94
22443700	24755	11.10	.4370	142	94
22444090	24761	11.20	.4409	142	94
22444490	24764	11.30	.4449	142	94
22444880	24767	11.40	.4488	142	94
22445270	24770	11.50	.4527	142	94
22445670	24776	11.60	.4567	142	94
22446060	24779	11.70	.4606	142	94
22446450	24782	11.80	.4645	142	94
22446850	24785	11.90	.4685	151	101
22447240	24791	12.00	.4724	151	101
22449210	24797	12.50	.4921	151	101
22451180	24803	13.00	.5118	151	101
22453150	24812	13.50	.5315	160	108
22455120	24818	14.00	.5512	160	108
22457080	24824	14.50	.5708	169	114
22459050	24830	15.00	.5905	169	114
22461020	24839	15.50	.6102	178	120
22462990	24845	16.00	.6299	178	120
22464960	24851	16.50	.6496	184	125
22466930	24857	17.00	.6693	184	125
22468900	24866	17.50	.6890	191	130
22470870	24872	18.00	.7087	191	130
22472830	24878	18.50	.7283	198	135
22474800	24884	19.00	.7480	198	135
22478740	24896	20.00	.7874	205	140

See Series 204 on page 96 for inch size Jobber Drills.



Twister® GP Series 226

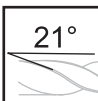
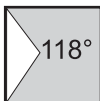
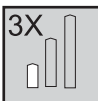
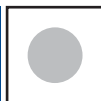

Metric/
DIN
6539

See Series 206 on page 105 for inch size Stub Drills.

Recommended for drilling cast iron, aluminum, bronze and magnesium alloys and other abrasive, but easily machined materials.

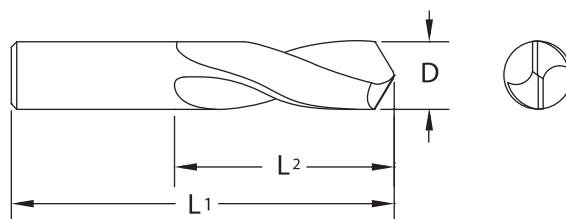

- Designed to allow high feed rates with good chip flow.
- Four facet drill point minimizes drill wander and assures accurately sized holes.
- Shorter length reduces deflection and vibration, increases drill accuracy and improves tool life.

Tool No.	EDP	Diameter		OAL	Flute Length	
		D			L1	L2
		mm	Decimal	mm		
22603940	26002	1.00	.0394	26	6	
22604130	26011	1.05	.0413	28	7	
22604330	26020	1.10	.0433	28	7	
22604520	26023	1.15	.0452	30	8	
22604720	26032	1.20	.0472	30	8	
22604920	26035	1.25	.0492	30	8	
22605110	26038	1.30	.0511	30	8	
22605310	26044	1.35	.0531	32	9	
22605510	26050	1.40	.0551	32	9	
22605710	26053	1.45	.0571	32	9	
22605900	26056	1.50	.0590	32	9	
22606300	26065	1.60	.0630	34	10	
22606690	26071	1.70	.0669	34	10	
22607080	26080	1.80	.0708	36	11	
22607480	26086	1.90	.0748	36	11	
22607870	26098	2.00	.0787	38	12	
22608270	26107	2.10	.0827	38	12	
22608660	26113	2.20	.0866	40	13	
22609060	26119	2.30	.0906	40	13	
22609450	26128	2.40	.0945	43	14	
22609840	26137	2.50	.0984	43	14	
22610240	26146	2.60	.1024	43	14	
22610630	26152	2.70	.1063	46	16	
22611020	26164	2.80	.1102	46	16	
22611420	26173	2.90	.1142	46	16	
22611810	26179	3.00	.1181	46	16	
22612200	26185	3.10	.1220	49	18	
22612600	26191	3.20	.1260	49	18	
22612990	26197	3.30	.1299	49	18	
22613390	26200	3.40	.1339	52	20	
22613780	26206	3.50	.1378	52	20	
22614170	26215	3.60	.1417	52	20	
22614570	26221	3.70	.1457	52	20	
22614960	26230	3.80	.1496	55	22	
22615350	26236	3.90	.1535	55	22	
22615750	26248	4.00	.1575	55	22	
22616140	26257	4.10	.1614	55	22	
22616540	26260	4.20	.1654	55	22	
22616930	26266	4.30	.1693	58	24	
22617320	26278	4.40	.1732	58	24	
22617720	26284	4.50	.1772	58	24	
22618110	26290	4.60	.1811	58	24	
22618500	26296	4.70	.1850	58	24	
22618890	26302	4.80	.1889	62	26	
22619290	26311	4.90	.1929	62	26	
22619680	26320	5.00	.1968	62	26	
22620080	26326	5.10	.2008	62	26	
22620470	26338	5.20	.2047	62	26	
22620860	26344	5.30	.2086	62	26	
22621260	26350	5.40	.2126	66	28	
22621650	26356	5.50	.2165	66	28	
22622050	26362	5.60	.2205	66	28	
22622440	26368	5.70	.2244	66	28	
22622830	26374	5.80	.2283	66	28	
22623230	26377	5.90	.2323	66	28	
22623620	26386	6.00	.2362	66	28	
22624020	26392	6.10	.2402	70	31	
22624410	26398	6.20	.2441	70	31	
22624800	26404	6.30	.2480	70	31	
22625190	26410	6.40	.2519	70	31	
22625590	26413	6.50	.2559	70	31	
22625980	26419	6.60	.2598	70	31	
22626370	26425	6.70	.2637	70	31	
22626770	26434	6.80	.2677	74	34	

Metric (mm)	
D	Tolerance
1.00 - 20.00	+0.00/-0.013



Series 226 Continued

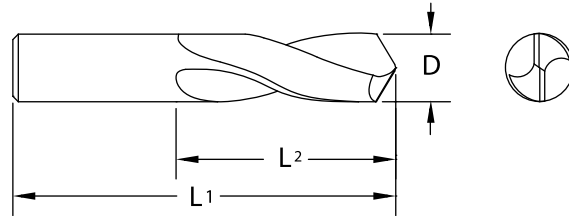

Tool No.	EDP	Diameter		OAL	Flute Length	
		D			L1	L2
		mm	Decimal			
22627160	26437	6.90	.2716	74	34	
22627560	26443	7.00	.2756	74	34	
22627950	26449	7.10	.2795	74	34	
22628340	26458	7.20	.2834	74	34	
22628740	26461	7.30	.2874	74	34	
22629130	26467	7.40	.2913	74	34	
22629530	26473	7.50	.2953	74	34	
22629920	26479	7.60	.2992	79	37	
22630310	26485	7.70	.3031	79	37	
22630710	26488	7.80	.3071	79	37	
22631100	26491	7.90	.3110	79	37	
22631500	26497	8.00	.3150	79	37	
22631890	26503	8.10	.3189	79	37	
22632280	26506	8.20	.3228	79	37	
22632670	26512	8.30	.3267	79	37	
22633070	26518	8.40	.3307	79	37	
22633460	26524	8.50	.3346	79	37	
22633850	26527	8.60	.3385	84	40	
22634250	26533	8.70	.3425	84	40	
22634640	26539	8.80	.3464	84	40	
22635040	26545	8.90	.3504	84	40	
22635430	26548	9.00	.3543	84	40	
22635820	26554	9.10	.3582	84	40	
22636220	26560	9.20	.3622	84	40	
22636610	26563	9.30	.3661	84	40	
22637000	26569	9.40	.3700	84	40	
22637400	26572	9.50	.3740	84	40	
22637790	26581	9.60	.3779	89	43	
22638190	26584	9.70	.3819	89	43	
22638580	26587	9.80	.3858	89	43	
22638970	26593	9.90	.3897	89	43	
22639370	26599	10.00	.3937	89	43	
22639760	26605	10.10	.3976	89	43	
22640150	26608	10.20	.4015	89	43	
22640550	26614	10.30	.4055	89	43	
22640940	26620	10.40	.4094	89	43	
22641340	26626	10.50	.4134	89	43	
22641730	26629	10.60	.4173	89	43	
22642120	26632	10.70	.4212	95	47	
22642520	26638	10.80	.4252	95	47	
22642910	26641	10.90	.4291	95	47	
22643310	26644	11.00	.4331	95	47	

Tool No.	EDP	Diameter		OAL	Flute Length	
		D			L1	L2
		mm	Decimal			
22643700	26647	11.10	.4370	95	47	
22644090	26653	11.20	.4409	95	47	
22644490	26656	11.30	.4449	95	47	
22644880	26659	11.40	.4488	95	47	
22645270	26662	11.50	.4527	95	47	
22645670	26668	11.60	.4567	95	47	
22646060	26671	11.70	.4606	95	47	
22646450	26674	11.80	.4645	95	47	
22646850	26677	11.90	.4685	102	51	
22647240	26683	12.00	.4724	102	51	
22649210	26689	12.50	.4921	102	51	
22651180	26695	13.00	.5118	102	51	
22653150	26704	13.50	.5315	107	54	
22655120	26710	14.00	.5512	107	54	
22657080	26716	14.50	.5708	111	56	
22659050	26722	15.00	.5905	111	56	
22661020	26731	15.50	.6102	115	58	
22662990	26737	16.00	.6299	115	58	
22664960	26743	16.50	.6496	119	60	
22666930	26749	17.00	.6693	119	60	
22668900	26758	17.50	.6890	123	62	
22670870	26764	18.00	.7087	123	62	
22672830	26770	18.50	.7283	127	64	
22674800	26776	19.00	.7480	127	64	
22678740	26788	20.00	.7874	131	66	

See Series 206 on page 105 for inch size Stub Drills.



Twister® GP Series 300

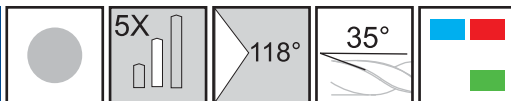

Designed for drilling soft metals as well as glass reinforced circuit boards, phenolic-epoxies and other abrasive, but easily machined materials.



- Sizes from .0135 to .250.
- Over 150 sizes available.

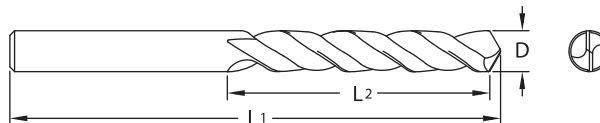

Tool No.	EDP	Diameter				OAL		Flute Length	
		D				L1		L2	
		Inch	Letter/Wire	mm	Decimal	Inch	mm	Inch	mm
30001350	30001		80		.0135	1-1/2		1/4	
30001450	30005		79		.0145	1-1/2		1/4	
30001560	30009	1/64			.0156	1-1/2		1/4	
30001600	30013		78		.0160	1-1/2		1/4	
30001800	30017		77		.0180	1-1/2		1/4	
30001970	30021			0.50	.0197		38		9.5
30002000	30025		76		.0200	1-1/2		3/8	
30002100	30029		75		.0210	1-1/2		3/8	
30002170	30033			0.55	.0217		38		9.5
30002250	30037		74		.0225	1-1/2		3/8	
30002360	30041			0.60	.0236		38		9.5
30002400	30045		73		.0240	1-1/2		3/8	
30002500	30049		72		.0250	1-1/2		1/2	
30002560	30053			0.65	.0256		38		12.5
30002600	30057		71		.0260	1-1/2		1/2	
30002760	30061			0.70	.0276		38		12.5
30002800	30065		70		.0280	1-1/2		1/2	
30002920	30069		69		.0292	1-1/2		1/2	
30002950	30073			0.75	.0295		38		12.5
30003100	30077		68		.0310	1-1/2		1/2	
30003120	30081	1/32			.0312	1-1/2		1/2	
30003150	30085			0.80	.0315		38		12.5
30003200	30089		67		.0320	1-1/2		1/2	
30003300	30093		66		.0330	1-1/2		1/2	
30003350	30097			0.85	.0335		38		12.5
30003500	30101		65		.0350	1-1/2		5/8	
30003540	30105			0.90	.0354		38		16.0
30003600	30109		64		.0360	1-1/2		5/8	
30003700	30113		63		.0370	1-1/2		5/8	
30003740	30117			0.95	.0374		38		16.0
30003800	30121		62		.0380	1-1/2		5/8	
30003900	30125		61		.0390	1-1/2		5/8	
30003940	30129			1.00	.0394		38		16.0
30004000	30133		60		.0400	1-1/2		5/8	

Inch	
D	Tolerance
.0135 - .2500	+0.0000/-0.0005

Metric (mm)	
D	Tolerance
0.50 - 3.15	+0.000/-0.013



Series 300 Continued

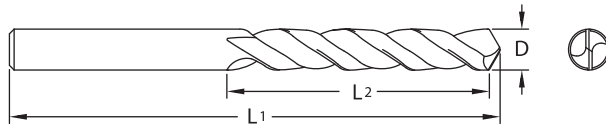
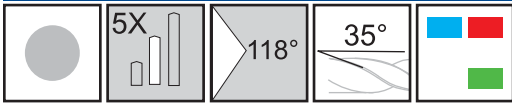

Tool No.	EDP	Diameter				OAL		Flute Length	
		D				L1		L2	
		Inch	Letter/Wire	mm	Decimal	Inch	mm	Inch	mm
30004100	30137		59		.0410	1-1/2		5/8	
30004130	30141			1.05	.0413		38		16.0
30004200	30145		58		.0420	1-1/2		5/8	
30004300	30149		57		.0430	1-1/2		5/8	
30004330	30153			1.10	.0433		38		16.0
30004520	30157			1.15	.0452		38		16.0
30004650	30161		56		.0465	1-1/2		5/8	
30004690	30165	3/64			.0469	1-1/2		5/8	
30004720	30169			1.20	.0472		38		16.0
30004920	30173			1.25	.0492		38		16.0
30005110	30177			1.30	.0511		38		16.0
30005200	30181		55		.0520	1-1/2		5/8	
30005310	30185			1.35	.0531		38		16.0
30005500	30189		54		.0550	1-1/2		5/8	
30005510	30193			1.40	.0551		38		16.0
30005710	30197			1.45	.0571		38		16.0
30005900	30201			1.50	.0590		38		16.0
30005950	30205		53		.0595	1-1/2		5/8	
30006100	30209			1.55	.0610		38		16.0
30006250	30213	1/16			.0625	1-1/2		5/8	
30006300	30217			1.60	.0630		38		16.0
30006350	30221		52		.0635	1-1/2		5/8	
30006490	30225			1.65	.0649		38		16.0
30006690	30229			1.70	.0669		38		16.0
30006700	30233		51		.0670	1-1/2		5/8	
30006890	30237			1.75	.0689		38		16.0
30007000	30241		50		.0700	1-1/2		5/8	
30007080	30245			1.80	.0708		38		16.0
30007280	30249			1.85	.0728		38		16.0
30007300	30253		49		.0730	1-1/2		5/8	
30007480	30257			1.90	.0748		38		16.0
30007600	30261		48		.0760	1-1/2		5/8	
30007670	30265			1.95	.0767		38		16.0
30007810	30269	5/64			.0781	1-1/2		5/8	
30007850	30273		47		.0785	1-1/2		5/8	
30007870	30277			2.00	.0787		38		16.0
30008070	30281			2.05	.0807		38		16.0
30008100	30285		46		.0810	1-1/2		5/8	
30008200	30289		45		.0820	1-1/2		5/8	
30008270	30293			2.10	.0827		38		16.0
30008460	30297			2.15	.0846		38		16.0
30008600	30301		44		.0860	1-1/2		5/8	



Series 300 Continued

Tool No.	EDP	Diameter				OAL		Flute Length	
		D				L1		L2	
		Inch	Letter/Wire	mm	Decimal	Inch	mm	Inch	mm
30008660	30305			2.20	.0866		38		16.0
30008860	30309			2.25	.0886		38		16.0
30008900	30313		43		.0890	1-1/2		5/8	
30009060	30317			2.30	.0906		38		16.0
30009250	30321			2.35	.0925		38		16.0
30009350	30325		42		.0935	1-1/2		5/8	
30009380	30329	3/32			.0938	1-1/2		5/8	
30009450	30333			2.40	.0945		38		16.0
30009600	30337		41		.0960	1-1/2		5/8	
30009650	30341			2.45	.0965		38		16.0
30009800	30345		40		.0980	1-1/2		5/8	
30009840	30349			2.50	.0984		38		16.0
30009950	30353		39		.0995	1-1/2		5/8	
30010040	30357			2.55	.1004		38		16.0
30010150	30361		38		.1015	1-1/2		5/8	
30010240	30365			2.60	.1024		38		16.0
30010400	30369		37		.1040	1-1/2		5/8	
30010430	30371			2.65	.1043		38		16.0
30010630	30373			2.70	.1063		38		16.0
30010650	30377		36		.1065	1-1/2		5/8	
30010830	30381			2.75	.1083		38		16.0
30010940	30385	7/64			.1094	1-1/2		5/8	
30011000	30389		35		.1100	1-1/2		5/8	
30011020	30393			2.80	.1102		38		16.0
30011100	30397		34		.1110	1-1/2		5/8	
30011220	30401			2.85	.1122		38		16.0
30011300	30405		33		.1130	1-1/2		5/8	
30011420	30409			2.90	.1142		38		16.0
30011600	30413		32		.1160	1-1/2		5/8	
30011610	30415			2.95	.1161		38		16.0
30011810	30417			3.00	.1181		38		16.0
30012000	30421		31		.1200	1-1/2		5/8	
30012010	30423			3.05	.1201		38		16.0
30012200	30425			3.10	.1220		38		16.0
30012400	30427			3.15	.1240		38		16.0
30012500	30429	1/8			.1250	1-1/2		5/8	
30012850	30437		30		.1285	1-1/2		3/4	
30013600	30441		29		.1360	1-1/2		3/4	
30014050	30445		28		.1405	1-1/2		3/4	
30014060	30449	9/64			.1406	1-1/2		3/4	
30014400	30453		27		.1440	1-1/2		3/4	
30014700	30457		26		.1470	1-1/2		3/4	
30014950	30461		25		.1495	1-1/2		3/4	
30015200	30465		24		.1520	1-1/2		3/4	
30015400	30469		23		.1540	1-1/2		3/4	
30015620	30473	5/32			.1562	1-1/2		3/4	



Series 300 Continued

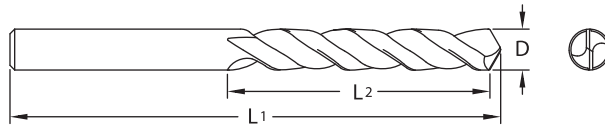
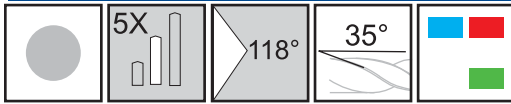

Tool No.	EDP	Diameter				OAL		Flute Length	
		D				L1		L2	
		Inch	Letter/Wire	mm	Decimal	Inch	mm	Inch	mm
30015700	30477		22		.1570	1-1/2		3/4	
30015900	30481		21		.1590	1-1/2		3/4	
30016100	30485		20		.1610	1-1/2		3/4	
30016600	30489		19		.1660	1-1/2		3/4	
30016950	30493		18		.1695	1-1/2		3/4	
30017190	30497	11/64			.1719	1-1/2		3/4	
30017300	30501		17		.1730	1-1/2		3/4	
30017700	30505		16		.1770	1-1/2		3/4	
30018000	30509		15		.1800	1-1/2		3/4	
30018200	30513		14		.1820	1-1/2		3/4	
30018500	30517		13		.1850	1-1/2		3/4	
30018750	30521	3/16			.1875	1-1/2		3/4	
30018900	30525		12		.1890	1-1/2		3/4	
30019100	30529		11		.1910	1-1/2		3/4	
30019350	30533		10		.1935	1-1/2		3/4	
30019600	30537		9		.1960	1-1/2		3/4	
30019900	30541		8		.1990	1-1/2		3/4	
30020100	30545		7		.2010	1-1/2		3/4	
30020310	30549	13/64			.2031	1-1/2		3/4	
30020400	30553		6		.2040	1-1/2		3/4	
30020550	30557		5		.2055	1-1/2		3/4	
30020900	30561		4		.2090	1-1/2		3/4	
30021300	30565		3		.2130	1-1/2		3/4	
30021870	30569	7/32			.2187	1-1/2		3/4	
30022100	30573		2		.2210	1-1/2		3/4	
30022800	30577		1		.2280	1-1/2		3/4	
30023400	30581		A		.2340	1-1/2		3/4	
30023440	30585	15/64			.2344	1-1/2		3/4	
30023800	30589		B		.2380	1-1/2		3/4	
30024200	30593		C		.2420	1-1/2		3/4	
30024600	30597		D		.2460	1-1/2		3/4	
30025000	30601	1/4	E		.2500	1-1/2		3/4	



Twister® GP Series 302

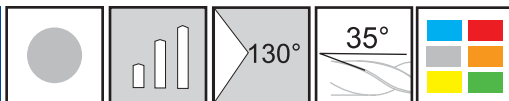

Micro drills are manufactured in up to 3 different flute lengths, depending on diameter.



- Drills available with color coded depth setting rings upon request.

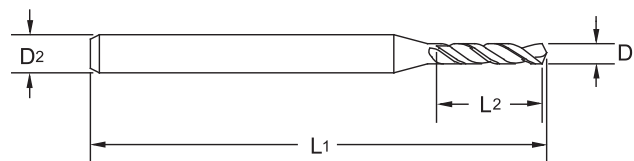

Tool No.	EDP	Diameter				Shank		OAL		Flute Length	
		D1				D2		L1		L2	
		Inch	Letter/Wire	mm	Decimal	Inch	mm	Inch	mm	Inch	mm
30200390	32001		102	0.10	.0039	1/8	3.175	1-1/2	38	.065	1.70
30200430	32005		101		.0043	1/8		1-1/2		.065	
30200470	32009		100		.0047	1/8		1-1/2		.065	
30200510	32013		99		.0051	1/8		1-1/2		.065	
30200550	32017		98		.0055	1/8		1-1/2		.065	
30200590	32021		97	0.15	.0059	1/8	3.175	1-1/2	38	.100	2.50
30200600	32025				.0060	1/8		1-1/2		.100	
30200630	32029		96		.0063	1/8		1-1/2		.100	
30200670	32033		95		.0067	1/8		1-1/2		.100	
30200700	32037				.0070	1/8		1-1/2		.100	
30200710	32041		94		.0071	1/8		1-1/2		.100	
30200750	32045		93		.0075	1/8		1-1/2		.100	
30200780	32049			0.20	.0078		3.175		38		3.20
30200790	32053		92		.0079	1/8		1-1/2		.125	
30200800	32057				.0080	1/8		1-1/2		.125	
30200830	32061		91		.0083	1/8		1-1/2		.125	
30200870	32065		90		.0087	1/8		1-1/2		.125	
30200900	32069				.0090	1/8		1-1/2		.125	
30200910	32073		89		.0091	1/8		1-1/2		.125	
30200950	32077		88		.0095	1/8		1-1/2		.125	
30200980	32081			0.25	.0098		3.175		38		3.80
30201000	32085		87		.0100	1/8		1-1/2		.150	
30201050	32089		86		.0105	1/8		1-1/2		.150	
30201100	32093		85		.0110	1/8		1-1/2		.150	
30201150	32097		84		.0115	1/8		1-1/2		.150	
30201180	32101			0.30	.0118		3.175		38		4.80
30201200	32105		83		.0120	1/8		1-1/2		.190	
30201250	32109		82		.0125	1/8		1-1/2		.190	
30201300	32113		81		.0130	1/8		1-1/2		.190	
30201350	32117		80		.0135	1/8		1-1/2		.190	
30201351	32119		80		.0135	1/8		1-1/2		.250	
30201380	32121			0.35	.0138		3.175		38		4.80
30201381	32123			0.35	.0138		3.175		38		6.35
30201450	32125		79		.0145	1/8		1-1/2		.190	

Inch	
D1	Tolerance
≤ 0.010	+0.000/-0.0003
> 0.010	+0.0000/-0.0005
L1	Tolerance
≤ 0.010	+/-0.005
> 0.010	+/-0.005
D2	Tolerance
≤ .125	+0.0000/-0.0002

Metric (mm)	
D1	Tolerance
≤ 0.25	+0.000/-0.008
> 0.25	+0.000/-0.013
L1	Tolerance
≤ 0.25	+/-0.130
> 0.25	+/-0.130
D2	Tolerance
≤ 3.18	+0.000/-0.005

For our High Performance Micro Drill see page 81 for the 305 Series.



Series 302 Continued

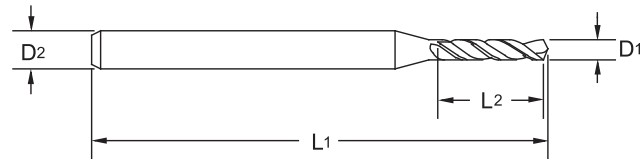
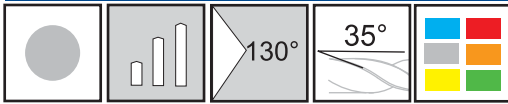

Tool No.	EDP	Diameter				Shank		OAL		Flute Length	
		D1				D2		L1		L2	
		Inch	Letter/Wire	mm	Decimal	Inch	mm	Inch	mm	Inch	mm
30201451	32127		79		.0145	1/8		1-1/2		.250	
30201560	32129	1/64			.0156	1/8		1-1/2		.190	
30201561	32131	1/64			.0156	1/8		1-1/2		.250	
30201570	32133			0.40	.0157		3.175		38		4.80
30201571	32135			0.40	.0157		3.175		38		6.35
30201600	32137		78		.0160	1/8		1-1/2		.190	
30201601	32139		78		.0160	1/8		1-1/2		.250	
30201770	32141			0.45	.0177		3.175		38		4.80
30201771	32143			0.45	.0177		3.175		38		6.35
30201772	32144			0.45	.0177		3.175		38		8.13
30201800	32145		77		.0180	1/8		1-1/2		.190	
30201801	32147		77		.0180	1/8		1-1/2		.250	
30201802	32148		77		.0180	1/8		1-1/2		.320	
30201970	32149			0.50	.0197		3.175		38		4.80
30201971	32151			0.50	.0197		3.175		38		6.35
30201972	32152			0.50	.0197		3.175		38		8.13
30202000	32153		76		.0200	1/8		1-1/2		.190	
30202001	32155		76		.0200	1/8		1-1/2		.250	
30202002	32156		76		.0200	1/8		1-1/2		.320	
30202100	32157		75		.0210	1/8		1-1/2		.190	
30202101	32159		75		.0210	1/8		1-1/2		.250	
30202102	32160		75		.0210	1/8		1-1/2		.320	
30202170	32161			0.55	.0217		3.175		38		4.80
30202171	32163			0.55	.0217		3.175		38		6.35
30202172	32164			0.55	.0217		3.175		38		8.13
30202250	32165		74		.0225	1/8		1-1/2		.190	
30202251	32167		74		.0225	1/8		1-1/2		.250	
30202252	32168		74		.0225	1/8		1-1/2		.320	
30202360	32169			0.60	.0236		3.175		38		4.80
30202361	32171			0.60	.0236		3.175		38		6.35
30202362	32172			0.60	.0236		3.175		38		8.13
30202400	32173		73		.0240	1/8		1-1/2		.190	
30202401	32175		73		.0240	1/8		1-1/2		.250	
30202402	32176		73		.0240	1/8		1-1/2		.320	
30202500	32177		72		.0250	1/8		1-1/2		.190	
30202501	32179		72		.0250	1/8		1-1/2		.250	
30202502	32180		72		.0250	1/8		1-1/2		.320	
30202560	32181			0.65	.0256		3.175		38		4.80
30202561	32183			0.65	.0256		3.175		38		6.35
30202562	32184			0.65	.0256		3.175		38		8.13
30202600	32185		71		.0260	1/8		1-1/2		.190	
30202601	32187		71		.0260	1/8		1-1/2		.250	



Series 302 Continued

Tool No.	EDP	Diameter				Shank		OAL		Flute Length	
		D1				D2		L1		L2	
		Inch	Letter/Wire	mm	Decimal	Inch	mm	Inch	mm	Inch	mm
30202602	32188		71		.0260	1/8		1-1/2		.320	
30202760	32189			0.70	.0276		3.175		38		6.35
30202761	32191			0.70	.0276		3.175		38		8.13
30202762	32192			0.70	.0276		3.175		38		10.16
30202800	32193		70		.0280	1/8		1-1/2		.250	
30202801	32195		70		.0280	1/8		1-1/2		.320	
30202802	32196		70		.0280	1/8		1-1/2		.400	
30202920	32197		69		.0292	1/8		1-1/2		.250	
30202921	32199		69		.0292	1/8		1-1/2		.320	
30202922	32200		69		.0292	1/8		1-1/2		.400	
30202950	32201			0.75	.0295		3.175		38		6.35
30202951	32203			0.75	.0295		3.175		38		8.13
30202952	32204			0.75	.0295		3.175		38		10.16
30203100	32205		68		.0310	1/8		1-1/2		.250	
30203101	32207		68		.0310	1/8		1-1/2		.400	
30203120	32209	1/32			.0312	1/8		1-1/2		.250	
30203121	32211	1/32			.0312	1/8		1-1/2		.400	
30203150	32213			0.80	.0315		3.175		38		6.35
30203151	32215			0.80	.0315		3.175		38		10.16
30203200	32217		67		.0320	1/8		1-1/2		.250	
30203201	32219		67		.0320	1/8		1-1/2		.400	
30203300	32221		66		.0330	1/8		1-1/2		.250	
30203301	32223		66		.0330	1/8		1-1/2		.400	
30203350	32225			0.85	.0335		3.175		38		6.35
30203351	32227			0.85	.0335		3.175		38		10.16
30203500	32229		65		.0350	1/8		1-1/2		.400	
30203540	32233			0.90	.0354		3.175		38		10.16
30203600	32237		64		.0360	1/8		1-1/2		.400	
30203700	32241		63		.0370	1/8		1-1/2		.400	
30203740	32245			0.95	.0374		3.175		38		10.16
30203800	32249		62		.0380	1/8		1-1/2		.400	
30203900	32253		61		.0390	1/8		1-1/2		.400	
30203940	32257			1.00	.0394		3.175		38		10.16
30204000	32261		60		.0400	1/8		1-1/2		.400	
30204100	32265		59		.0410	1/8		1-1/2		.400	
30204130	32269			1.05	.0413		3.175		38		10.16
30204200	32273		58		.0420	1/8		1-1/2		.400	
30204300	32277		57		.0430	1/8		1-1/2		.400	
30204330	32281			1.10	.0433		3.175		38		10.16
30204520	32285			1.15	.0452		3.175		38		10.16
30204650	32289		56		.0465	1/8		1-1/2		.400	
30204690	32293	3/64			.0469	1/8		1-1/2		.400	
30204720	32297			1.20	.0472		3.175		38		10.16
30204920	32301			1.25	.0492		3.175		38		10.16



Series 302 Continued

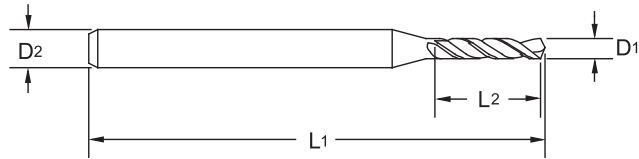
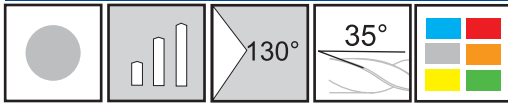

Tool No.	EDP	Diameter				Shank		OAL		Flute Length	
		D1				D2		L1		L2	
		Inch	Letter/Wire	mm	Decimal	Inch	mm	Inch	mm	Inch	mm
30205110	32305			1.30	.0511		3.175		38		10.16
30205200	32309		55		.0520	1/8		1-1/2		.400	
30205310	32313			1.35	.0531		3.175		38		10.16
30205500	32317		54		.0550	1/8		1-1/2		.400	
30205510	32321			1.40	.0551		3.175		38		10.16
30205710	32325			1.45	.0571		3.175		38		10.16
30205900	32329			1.50	.0590		3.175		38		10.16
30205950	32333		53		.0595	1/8		1-1/2		.400	
30206100	32341			1.55	.0610		3.175		38		10.16
30206250	32345	1/16			.0625	1/8		1-1/2		.480	
30206300	32349			1.60	.0630		3.175		38		12.19
30206350	32353		52		.0635	1/8		1-1/2		.480	
30206490	32357			1.65	.0649		3.175		38		12.19
30206690	32361			1.70	.0669		3.175		38		12.19
30206700	32365		51		.0670	1/8		1-1/2		.480	
30206890	32369			1.75	.0689		3.175		38		12.19
30207000	32373		50		.0700	1/8		1-1/2		.480	
30207080	32377			1.80	.0708		3.175		38		12.19
30207280	32381			1.85	.0728		3.175		38		12.19
30207300	32385		49		.0730	1/8		1-1/2		.480	
30207480	32389			1.90	.0748		3.175		38		12.19
30207600	32393		48		.0760	1/8		1-1/2		.480	
30207670	32397			1.95	.0767		3.175		38		12.19
30207810	32401	5/64			.0781	1/8		1-1/2		.480	
30207850	32405		47		.0785	1/8		1-1/2		.480	
30207870	32409			2.00	.0787		3.175		38		12.19
30208070	32413			2.05	.0807		3.175		38		12.19
30208100	32417		46		.0810	1/8		1-1/2		.480	
30208200	32421		45		.0820	1/8		1-1/2		.480	
30208270	32425			2.10	.0827		3.175		38		12.19
30208460	32429			2.15	.0846		3.175		38		12.19
30208600	32433		44		.0860	1/8		1-1/2		.480	
30208660	32437			2.20	.0866		3.175		38		12.19
30208860	32441			2.25	.0886		3.175		38		12.19
30208900	32445		43		.0890	1/8		1-1/2		.480	
30209060	32449			2.30	.0906		3.175		38		12.19
30209250	32453			2.35	.0925		3.175		38		12.19
30209350	32457		42		.0935	1/8		1-1/2		.480	
30209380	32461	3/32			.0938	1/8		1-1/2		.480	
30209450	32465			2.40	.0945		3.175		38		12.19



Series 302 Continued

Tool No.	EDP	Diameter				Shank		OAL		Flute Length	
		D1				D2		L1		L2	
		Inch	Letter/Wire	mm	Decimal	Inch	mm	Inch	mm	Inch	mm
30209600	32469		41		.0960	1/8		1-1/2		.480	
30209650	32473			2.45	.0965		3.175		38		12.19
30209800	32477		40		.0980	1/8		1-1/2		.480	
30209840	32481			2.50	.0984		3.175		38		12.19
30209950	32485		39		.0995	1/8		1-1/2		.480	
30210040	32489			2.55	.1004		3.175		38		12.19
30210150	32493		38		.1015	1/8		1-1/2		.480	
30210240	32497			2.60	.1024		3.175		38		12.19
30210400	32501		37		.1040	1/8		1-1/2		.480	
30210430	32503			2.65	.1043		3.175		38		12.19
30210630	32509			2.70	.1063		3.175		38		12.19
30210650	32513		36		.1065	1/8		1-1/2		.480	
30210830	32517			2.75	.1083		3.175		38		12.19
30210940	32521	7/64			.1094	1/8		1-1/2		.480	
30211000	32525		35		.1100	1/8		1-1/2		.480	
30211020	32529			2.80	.1102		3.175		38		12.19
30211100	32533		34		.1110	1/8		1-1/2		.480	
30211220	32537			2.85	.1122		3.175		38		12.19
30211300	32541		33		.1130	1/8		1-1/2		.480	
30211420	32545			2.90	.1142		3.175		38		12.19
30211600	32549		32		.1160	1/8		1-1/2		.480	
30211610	32551			2.95	.1161		3.175		38		12.19
30211810	32553			3.00	.1181		3.175		38		12.19
30212000	32557		31		.1200	1/8		1-1/2		.480	
30212010	32559			3.05	.1201		3.175		38		12.19
30212200	32561			3.10	.1220		3.175		38		12.19
30212400	32565			3.15	.1240		3.175		38		12.19
30212500	32569	1/8			.1250	1/8		1-1/2		.480	

302

Twister® GP



Page 166



For product information, call your local distributor.

Twister® GP Series 306

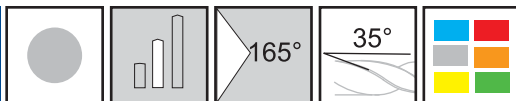

- Drills available with color coded depth setting rings upon request.

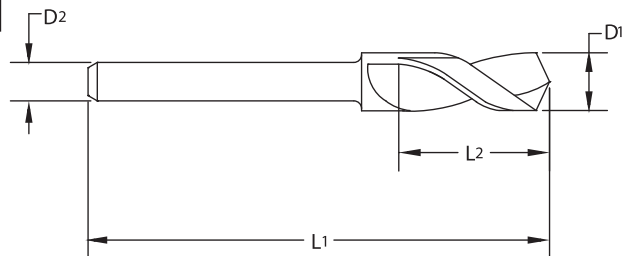

Tool No.	EDP	Diameter			Shank		OAL		Flute Length	
		D1			D2		L1		L2	
		Inch/Wire	mm	Decimal	Inch	mm	Inch	mm	Inch	mm
30612600	36003		3.20	.1260		3.175		38		12.2
30612800	36005		3.25	.1280		3.175		38		12.2
30612850	36007	30		.1285	1/8		1-1/2		.480	
30612990	36009		3.30	.1299		3.175		38		12.2
30613190	36011		3.35	.1319		3.175		38		12.2
30613390	36013		3.40	.1339		3.175		38		12.2
30613580	36015		3.45	.1358		3.175		38		12.2
30613600	36017	29		.1360	1/8		1-1/2		.480	
30613780	36019		3.50	.1378		3.175		38		12.2
30613980	36021		3.55	.1398		3.175		38		12.2
30614050	36023	28		.1405	1/8		1-1/2		.480	
30614060	36025	9/64		.1406	1/8		1-1/2		.480	
30614170	36027		3.60	.1417		3.175		38		12.2
30614370	36029		3.65	.1437		3.175		38		12.2
30614400	36031	27		.1440	1/8		1-1/2		.480	
30614570	36033		3.70	.1457		3.175		38		12.2
30614700	36035	26		.1470	1/8		1-1/2		.480	
30614760	36037		3.75	.1476		3.175		38		12.2
30614950	36039	25		.1495	1/8		1-1/2		.480	
30614960	36041		3.80	.1496		3.175		38		12.2
30615160	36042		3.85	.1516		3.175		38		12.2
30615200	36043	24		.1520	1/8		1-1/2		.480	
30615350	36045		3.90	.1535		3.175		38		12.2
30615400	36047	23		.1540	1/8		1-1/2		.480	
30615550	36049		3.95	.1555		3.175		38		12.2
30615620	36051	5/32		.1562	1/8		1-1/2		.480	
30615700	36053	22		.1570	1/8		1-1/2		.480	
30615750	36055		4.00	.1575		3.175		38		12.2
30615900	36057	21		.1590	1/8		1-1/2		.480	
30615940	36059		4.05	.1594		3.175		38		12.2
30616100	36061	20		.1610	1/8		1-1/2		.480	
30616140	36063		4.10	.1614		3.175		38		12.2
30616340	36065		4.15	.1634		3.175		38		12.2
30616540	36067		4.20	.1654		3.175		38		12.2
30616600	36069	19		.1660	1/8		1-1/2		.480	
30616730	36071		.4.25	.1673		3.175		38		12.2

Inch	
D1	Tolerance
.1285 - .2570	+0/-0.0005
L1	Tolerance
.1285 - .2570	+/-0.005
D2	Tolerance
.1285 - .2570	+0/-0.0003

Metric (mm)	
D1	Tolerance
3.20 - 6.35	+0/-0.013
L1	Tolerance
3.20 - 6.35	+/-0.130
D2	Tolerance
3.20 - 6.35	+0/-0.008



Series 306 Continued

Tool No.	EDP	Diameter			Shank		OAL		Flute Length	
		D1			D2		L1		L2	
		Inch/Wire	mm	Decimal	Inch	mm	Inch	mm	Inch	mm
30616930	36073		4.30	.1693		3.175		38		12.2
30616950	36075	18		.1695	1/8		1-1/2		.480	
30617130	36077		4.35	.1713		3.175		38		12.2
30617190	36079	11/64		.1719	1/8		1-1/2		.480	
30617300	36081	17		.1730	1/8		1-1/2		.480	
30617320	36083		4.40	.1732		3.175		38		12.2
30617520	36085		4.45	.1752		3.175		38		12.2
30617700	36087	16		.1770	1/8		1-1/2		.480	
30617720	36089		4.50	.1772		3.175		38		12.2
30617910	36091		4.55	.1791		3.175		38		12.2
30618000	36093	15		.1800	1/8		1-1/2		.480	
30618110	36095		4.60	.1811		3.175		38		12.2
30618200	36097	14		.1820	1/8		1-1/2		.480	
30618310	36099		4.65	.1831		3.175		38		12.2
30618500	36101	13	4.70	.1850	1/8	3.175	1-1/2	38	.480	12.2
30618700	36103		4.75	.1870		3.175		38		12.2
30618750	36105	3/16		.1875	1/8		1-1/2		.480	
30618900	36107	12	4.80	.1890	1/8	3.175	1-1/2	38	.480	12.2
30619090	36109		4.85	.1909		3.175		38		12.2
30619100	36111	11		.1910	1/8		1-1/2		.480	
30619290	36113		4.90	.1929		3.175		38		12.2
30619350	36115	10		.1935	1/8		1-1/2		.480	
30619490	36117		4.95	.1949		3.175		38		12.2
30619600	36119	9		.1960	1/8		1-1/2		.480	
30619690	36121		5.00	.1969		3.175		38		12.2
30619880	36123		5.05	.1988		3.175		38		12.2
30619900	36125	8		.1990	1/8		1-1/2		.480	
30620080	36127		5.10	.2008		3.175		38		12.2
30620100	36129	7		.2010	1/8		1-1/2		.480	
30620280	36131		5.15	.2028		3.175		38		12.2
30620310	36133	13/64		.2031	1/8		1-1/2		.480	
30620400	36135	6		.2040	1/8		1-1/2		.480	
30620470	36137		5.20	.2047		3.175		38		12.2
30620550	36139	5		.2055	1/8		1-1/2		.480	
30620670	36141		5.25	.2067		3.175		38		12.2
30620870	36143		5.30	.2087		3.175		38		12.2
30620900	36145	4		.2090	1/8		1-1/2		.480	
30621060	36147		5.35	.2106		3.175		38		12.2
30621260	36149		5.40	.2126		3.175		38		12.2
30621300	36151	3		.2130	1/8		1-1/2		.480	
30621460	36153		5.45	.2146		3.175		38		12.2
30621650	36155		5.50	.2165		3.175		38		12.2
30621850	36157		5.55	.2185		3.175		38		12.2
30621870	36159	7/32		.2187	1/8		1-1/2		.480	



Series 306 Continued

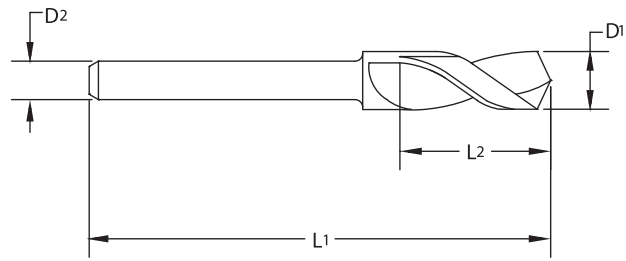
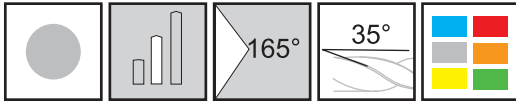

Tool No.	EDP	Diameter			Shank		OAL		Flute Length	
		D1			D2		L1		L2	
		Inch/Wire	mm	Decimal	Inch	mm	Inch	mm	Inch	mm
30622050	36161		5.60	.2205		3.175		38		12.2
30622100	36163	2		.2210	1/8		1-1/2		.480	
30622240	36165		5.65	.2224		3.175		38		12.2
30622440	36167		5.70	.2244		3.175		38		12.2
30622640	36169		5.75	.2264		3.175		38		12.2
30622800	36171	1		.2280	1/8		1-1/2		.480	
30622830	36173		5.80	.2283		3.175		38		12.2
30623030	36175		5.85	.2303		3.175		38		12.2
30623230	36177		5.90	.2323		3.175		38		12.2
30623400	36179	A		.2340	1/8		1-1/2		.480	
30623430	36181		5.95	.2343		3.175		38		12.2
30623440	36183	15/64		.2344	1/8		1-1/2		.480	
30623620	36185		6.00	.2362		3.175		38		12.2
30623800	36187	B		.2380	1/8		1-1/2		.480	
30623820	36188		6.05	.2382		3.175		38		12.2
30624020	36189		6.10	.2402		3.175		38		12.2
30624200	36191	C		.2420	1/8		1-1/2		.480	
30624210	36192		6.15	.2421		3.175		38		12.2
30624410	36193		6.20	.2441		3.175		38		12.2
30624600	36195	D		.2460	1/8		1-1/2		.480	
30624610	36197		6.25	.2461		3.175		38		12.2
30624800	36199		6.30	.2480		3.175		38		12.2
30625000	36201	1/4 & E	6.35	.2500	1/8	3.175	1-1/2	38	.480	12.2
30625700	36203	F		.2570	1/8		1-1/2		.480	



Twister® GP Series 402

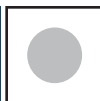

Metric/
DIN
333A

Designed to maintain accurate center holes on long production runs, or when precise centering is required.

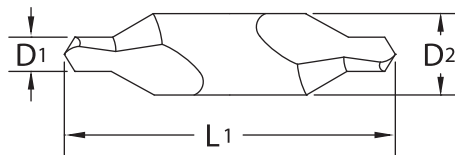

- 60° included angle.
- Solid carbide construction helps reduce tool changes when centering abrasive or difficult to machine materials.

Tool No.	EDP	Diameter			Shank		OAL	
		D1			D2		L1	
		Size	Inch	mm	Inch	mm	Inch	mm
40201970	40201			0.5		3.15		31.5*
40202500	40205	00	.025		1/8		1-1/2	
40203100	40209	0	1/32		1/8		1-1/2	
40203150	40213			0.8		3.15		31.5*
40203940	40217			1.0		3.15		31.5
40204680	40221	1	3/64		1/8		1-1/2	
40204920	40225			1.25		3.15		31.5
40206300	40229			1.6		4.0		35.5
40207810	40233	2	5/64		3/16		1-7/8	
40207870	40237			2.0		5.0		40
40209840	40241			2.5		6.3		45
40210930	40245	3	7/64		1/4		2	
40212400	40249			3.15		8.0		50
40212500	40253	4	1/8		5/16		2-1/8	
40215750	40257			4.0		10.0		56
40218750	40261	5	3/16		7/16		2-3/4	
40219680	40265			5.0		12.5		63
40221870	40269	6	7/32		1/2		3	

Inch	
D1	Tolerance
.0250 - 7/32	+ .003/- .000

Metric (mm)	
D1	Tolerance
0.50 - 5.0	+ .076/- .000



Page 168

*Overall length not to DIN specifications.

Twister® Series 200S

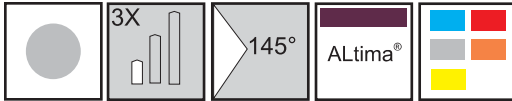

Spot Drills for High Performance Drills

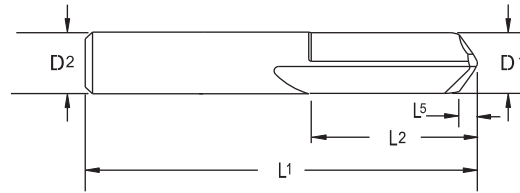

Tool No.	EDP	Diameter			Shank		OAL		Flute Length		Point Length	
		D1 (h7)			D2 (h6)		L1		L2		L5	
		Inch	mm	Decimal	Inch	mm	Inch	mm	Inch	mm	Inch	mm
200S11810A	20221		3.0	.1181		3.0		38		16		0.41
200S12500A	20230	1/8		.1250	1/8		1-1/2		5/8		0.017	
200S23620A	20431		6.0	.2362		6.0		51		19		0.83
200S25000A	20452	1/4		.2500	1/4		2		3/4		0.034	
200S31250A	20542	5/16		.3125	5/16		2-1/2		3/4		0.043	
200S31500A	20545		8.0	.3150		8.0		64		19		1.10
200S37500A	20623	3/8		.3750	3/8		2-1/2		1		0.052	
200S39370A	20647		10.0	.3937		10.0		70		25		1.38
200S47240A	20731		12.0	.4724		12.0		76		25		1.65
200S50000A	20740	1/2		.5000	1/2		3		1		0.069	
200S62500A	20782	5/8		.6250	5/8		3-1/2		1-1/4		0.086	
200S62990A	20785		16.0	.6299		16.0		89		32		2.20

Inch		Inch		Metric (mm)		Metric (mm)	
D1	Tolerance (h7)	D2	Tolerance (h6)	D1	Tolerance (h7)	D2	Tolerance (h6)
.1182 - .2362	+0/- .00047	.1182 - .2362	+0/- .00031	3.0	+0/- .010	3.0	+0/- .006
.2363 - .3937	+0/- .00059	.2363 - .3937	+0/- .00035	3.01 - 6.0	+0/- .012	3.01 - 6.0	+0/- .008
.3938 - .6250	+0/- .00071	.3938 - .6250	+0/- .00043	6.01 - 10.0	+0/- .015	6.01 - 10.0	+0/- .009
				10.01 - 16.0	+0/- .018	10.01 - 16.0	+0/- .011



Page 158



Twister® GP Series 403

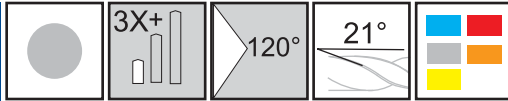

Designed for accurate spotting on NC machines. Solid carbide construction, short lengths and no body clearance make this a very rigid tool.

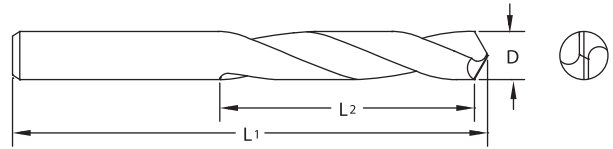

- Can be used at higher speeds and feeds, compatible with other carbide tooling.
- Easy to repoint because there is no web taper.

Tool No.	EDP	Diameter			OAL		Flute Length	
		D			L1		L2	
		Inch	mm	Decimal	Inch	mm	Inch	mm
40318750	40301	3/16		.1875	2		1	
40319680	40305		5.0	.1968		51		26.0
40323620	40309		6.0	.2362		51		26.0
40325000	40313	1/4		.2500	2		1	
40331250	40317	5/16		.3125	2-1/2		1	
40331500	40321		8.0	.3150		64		26.0
40337500	40325	3/8		.3750	2-1/2		1	
40339370	40329		10.0	.3937		70		30.0
40347240	40333		12.0	.4724		76		39.5
40350000	40337	1/2		.5000	3		1-9/16	

Inch	
D	Tolerance
.1875 - .5000	+0.0000/-0.0005

Metric (mm)	
D	Tolerance
5.00 - 12.00	+0.0000/-0.0130



Page 168

200S / 403 / 404

Twister® GP

Twister® GP Series 404

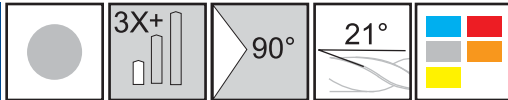

Designed for accurate spotting on NC machines. Solid carbide construction, short lengths and no body clearance make this a very rigid tool.

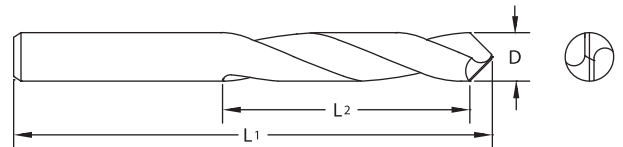

- Can be used at higher speeds and feeds, compatible with other carbide tooling.
- Easy to repoint because there is no web taper.

Tool No.	EDP	Diameter			OAL		Flute Length	
		D			L1		L2	
		Inch	mm	Decimal	Inch	mm	Inch	mm
40418750	40401	3/16		.1875	2		1	
40419680	40405		5.0	.1968		51		26.0
40423620	40409		6.0	.2362		51		26.0
40425000	40413	1/4		.2500	2		1	
40431250	40417	5/16		.3125	2-1/2		1	
40431500	40421		8.0	.3150		64		26.0
40437500	40425	3/8		.3750	2-1/2		1	
40439370	40429		10.0	.3937		70		30.0
40447240	40433		12.0	.4724		76		39.5
40450000	40437	1/2		.5000	3		1-9/16	

Inch	
D	Tolerance
.1875 - .5000	+0.0000/-0.0005

Metric (mm)	
D	Tolerance
5.00 - 12.00	+0.0000/-0.0130



Page 168

Twister® GP Series 405



Designed to maintain accurate center holes on long production runs or when precise centering is required.

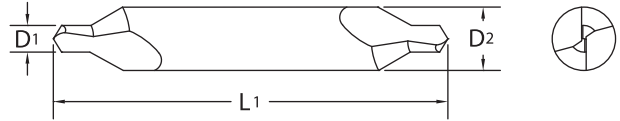

- 60° included angle.
- Solid carbide construction helps reduce tool changes when centering abrasive or difficult to machine materials.

Tool No.	EDP	Diameter		Shank	OAL
		Size	D1	D2	L1
40502500	40501	00	.0250	1/8	5
40503100	40505	0	1/32	1/8	5
40504680	40509	1	3/64	1/8	5
40507810	40513	2	5/64	3/16	5
40510930	40517	3	7/64	1/4	5
40512500	40521	4	1/8	5/16	5
40518750	40525	5	3/16	7/16	5
40521870	40529	6	7/32	1/2	5

Inch	
D1	Tolerance
.0250 - 7/32	+.003/-0.000



Page 168

ISO 9001:2008 Certified



High Performance Drill Selection Chart



Multipurpose high quality drill for most drilling applications adding stability, hole quality, tool life, and finish (excludes some work hardening materials).

Our industry leading high performance drill with the same high quality that helped set the standard.

An economical choice perfect for job shop and batch production work requiring a high performance drill option.

Series	Drill Lgth	Size Range Inch	Size Range mm	Margin	D1 Tol.	D2 Tol.	Helix	Point Angle	Coolant Fed	DIN	Coating	Application Recommendations							
												TEMA* Sizes	Steel	Hardened Steel	Stainless Steel	PH Stainless Steel	Cast Iron	Titanium	High Temp Alloys
CXDSS	3X	#31-3/4	3.0-20.0	Double	m7	h6	30°	140°	N	6537K	ALtima® Plus	X	1st	2nd	2nd	2nd	1st	2nd	2nd
CXDSSR	5X	#31-5/8	3.0-16.0	Double	m7	h6	30°	140°	N	6537L	ALtima® Plus	X	1st	2nd	2nd	2nd	1st	2nd	2nd
CXDSS	3X	#31-5/8	3.0-16.0	Double	m7	h6	30°	140°	Y	6537K	ALtima® Plus	X	1st	2nd	1st	2nd	1st	1st	2nd
CXDSSR	5X	#31-3/4	3.0-20.0	Double	m7	h6	30°	140°	Y	6537L	ALtima® Plus	X	1st	2nd	1st	2nd	1st	1st	2nd
CXDSS	8X	#31-1/2	3.0-12.0	Double	m7	h6	30°	140°	Y		ALtima® Plus	X	1st	2nd	1st	2nd	1st	1st	2nd
2XDSS	3X	#31-3/4	2.5-20.0	Single	h7	h6	30°	142°	N		ALtima®	X	2nd	1st	1st	1st	2nd	1st	1st
2XDSSR	5X	1/64-5/8	0.5-16.0	Single	h7	h6	30°	142°	N		ALtima®	X	2nd	1st	1st	1st	2nd	1st	1st
2XDSS	3X	#31-5/8	3.0-16.0	Single	h7	h6	30°	142°	Y	6537K	ALtima®	X	2nd	1st	1st	1st	2nd	2nd	1st
2XDSSR	5X	#31-3/4	3.0-20.0	Single	h7	h6	30°	142°	Y		ALtima®	X	2nd	1st	1st	1st	2nd	2nd	1st
2XDSS	7X+	#31-1/2	3.0-12.0	Single	h7	h6	30°	142°	Y		ALtima®	X	2nd	1st	1st	1st	2nd	2nd	1st
2XDCE	12X-25X**	1/4 - 1/2	5.0-12.0	Double	h7	h6	30°	142°	Y		ALtima®		2nd	1st	1st	1st	2nd	2nd	1st
HPDSR	5X	#31-5/8	3.0-16.0	Single	h7	h6	30°	140°	N	6537L	HP AlTiN		3rd	3rd	3rd	3rd	3rd	3rd	3rd
HPDCR	5X	#31-5/8	3.0-16.0	Single	h7	h6	30°	140°	Y	6537L	HP AlTiN		3rd	3rd	3rd	3rd	3rd	3rd	3rd

Note: For drilling applications involving cross holes and/or optimal hole finishes, use the CXD style drill.

*TEMA - Tubular Exchange Manufacturer's Association

**Length varies depending on size.

Inch	
D1	Tolerance (m7)
.0000 - .1181	+0.0008/+0.0047
.1182 - .2362	+0.0016/+0.0063
.2363 - .3937	+0.0024/+0.0083
.3938 - .7087	+0.0027/+0.0098
.7088 - .7500	+0.0031/+0.0114

Inch	
D1	Tolerance (h7)
.0000 - .1181	+0/-0.00039
.1182 - .2362	+0/-0.00047
.2363 - .3937	+0/-0.00059
.3938 - .7087	+0/-0.00071
.7088 - .7500	+0/-0.00083

Inch	
D2	Tolerance (h6)
.0000 - .1181	+0/-0.00024
.1182 - .2362	+0/-0.00031
.2363 - .3937	+0/-0.00035
.3938 - .7087	+0/-0.00043
.7088 - .7500	+0/-0.00051

Metric (mm)	
D1	Tolerance (m7)
0 - 3.0	+0.002/+0.012
3.01 - 6.0	+0.004/+0.016
6.01 - 10.0	+0.006/+0.021
10.01 - 18.0	+0.007/+0.025
18.01 - 20.0	+0.008/+0.029

Metric (mm)	
D1	Tolerance (h7)
0 - 3.0	+0/-0.010
3.01 - 6.0	+0/-0.012
6.01 - 10.0	+0/-0.015
10.01 - 18.0	+0/-0.018
18.01 - 20.0	+0/-0.021

Metric (mm)	
D2	Tolerance (h6)
0 - 3.0	+0/-0.006
3.01 - 6.0	+0/-0.008
6.01 - 10.0	+0/-0.009
10.01 - 18.0	+0/-0.011
18.01 - 20.0	+0/-0.013

M.A. Ford® Coating	Microhardness (HV)	Maximum Service Temp.	Friction Coefficient
ALtima®	3100	1100° C / 2012° F	0.42
ALtima® Plus	3200	1100° C / 2012° F	0.25
HP AlTiN	3000	927° C / 1700° F	0.25

Technical data provided should be considered advisory only as variations may be necessary depending on the particular application.

For product information, call your local distributor.

Twister® Drill Icon Glossary

Solid

Coolant Fed

Drill Length

Drill Point Angle

Helix Angle

Coatings

ALtima®

DIN Specs

Workpiece Material Group

Legend: Blue (P), Yellow (M), Red (K), Orange (S), Grey (H), Green (N)

P Steels

M Stainless Steels

K Cast Iron

S Special Alloys

H Hardened Steels (35-65Rc)

N Non-Ferrous

Cutting Calculations and Definitions		Metric	U.S.
ae	= Width of cut, radial depth of cut	(mm)	(inch)
ap	= Depth of cut, axial depth of cut	(mm)	(inch)
Dc	= Cutter diameter	(mm)	(inch)
f	= Feed per revolution	(mm/rev)	(IPR)
fz	= Feed per tooth	(mm/tooth)	(IPT)
zn	= Number of teeth	Number	
n	= RPM	(rev/min)	(rev/min)
Q	= Metal removal rate	(cm ³ /min)	(in ³ /min)
vc	= Cutting speed	(m/min)	(SFM)
vf	= Feed speed	(mm/min)	(IPM)
Dw	= Working diameter	(mm)	(inch)

Formulas

Inch
 RPM (n) = SFM (vc) x 3.82/Tool Diam.
 IPM (vf) = RPM (n) x IPR (f)

Conversion Inch to Metric
 SFM (vc) to m/min (vc) = SFM (vc) x .3048
 IPM (vf) to mm/min (vf) = IPM (vf) x 25.4

Metric
 RPM (n) = m/min (vc) x 318.057/Tool Diam.
 mm/min (vf) = RPM (n) x mm/Revolution (f).

Conversion Metric to Inch
 m/min (vc) to SFM (vc) = (m/min)/.3048
 mm/min (vf) to IPM (vf) = (mm/min)/25.4

Safety Note

Always wear the appropriate personal protective equipment such as safety glasses and protective clothing when using solid carbide or HSS cutting tools. Machines should be fully guarded.

Drill Troubleshooting

Possible Solutions	Problem																																		
	Tool Deterioration											Chip Formation		Tool Life		Workpiece				Process															
	Flank wear	Margin wear	Breakeage	Flaking	Creater wear	Chisel edge wear	Corner chipping	Flute chipping	Cutting edge chipping	Cutting edge wear	Point center chipping	Rake face	Scoring on tool body	Long stringy	Varied chip form	Blue/brown chips	Tool Life	Undersized hole	Oversized hole	Poor alignment	Poor surface finish	Heavy burr breakout	Retract marks	Hole location	Hole straightness	Deflection	Point Deflection	Galling	Vibration	Abnormal noise	Chip packing	No drill penetration			
Reduce feed or reduce at exit	x		x			x	x	x	x								x	x	x		x											x			
Reduce feed at entrance			x															x			x				x							x			
Consistent feed rate			x											x	x														x		x				
Increase feed	x					x								x				x	x																
Reduce speed	x	x			x	x				x							x	x										x	x	x					
Increase speed																					x														
Coolant			x	x	x								x				x	x			x	x										x			
Coolant increase flow	x		x			x	x								x		x	x			x	x										x			
Coolant filter	x		x	x													x	x			x	x										x			
Setup																																			
Workpiece clamp rigid		x	x			x	x						x				x		x	x	x	x	x	x	x							x			
Collet accuracy																																	x		
Tool holder fit .0008																																			
Alignment																																		x	
Peck drill																																			
Concentricity		x	x	x																															
Do not extract tool during peck																																			

Technical data provided should be considered advisory only as variations may be necessary depending on the particular application.

Coolant Pressure - Inch Recommended Minimum Coolant Pressure

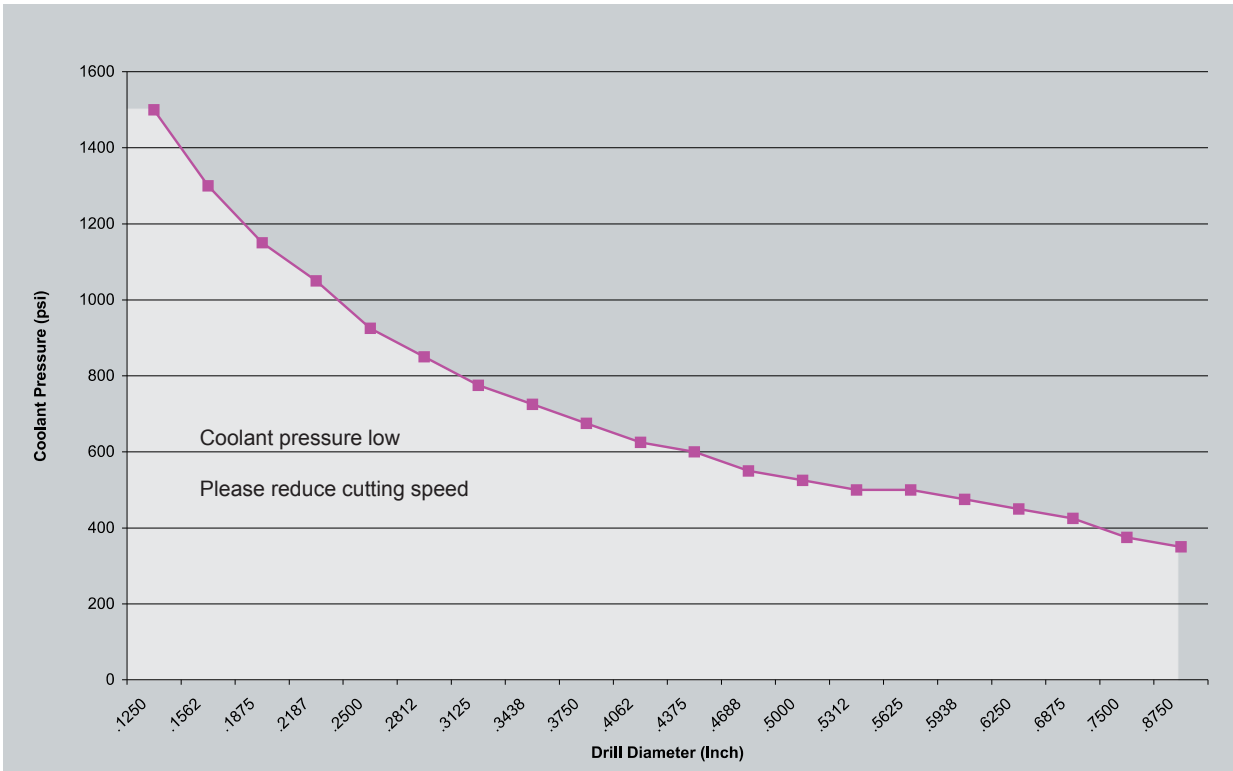

Coolant Pressure - Metric Recommended Minimum Coolant Pressure

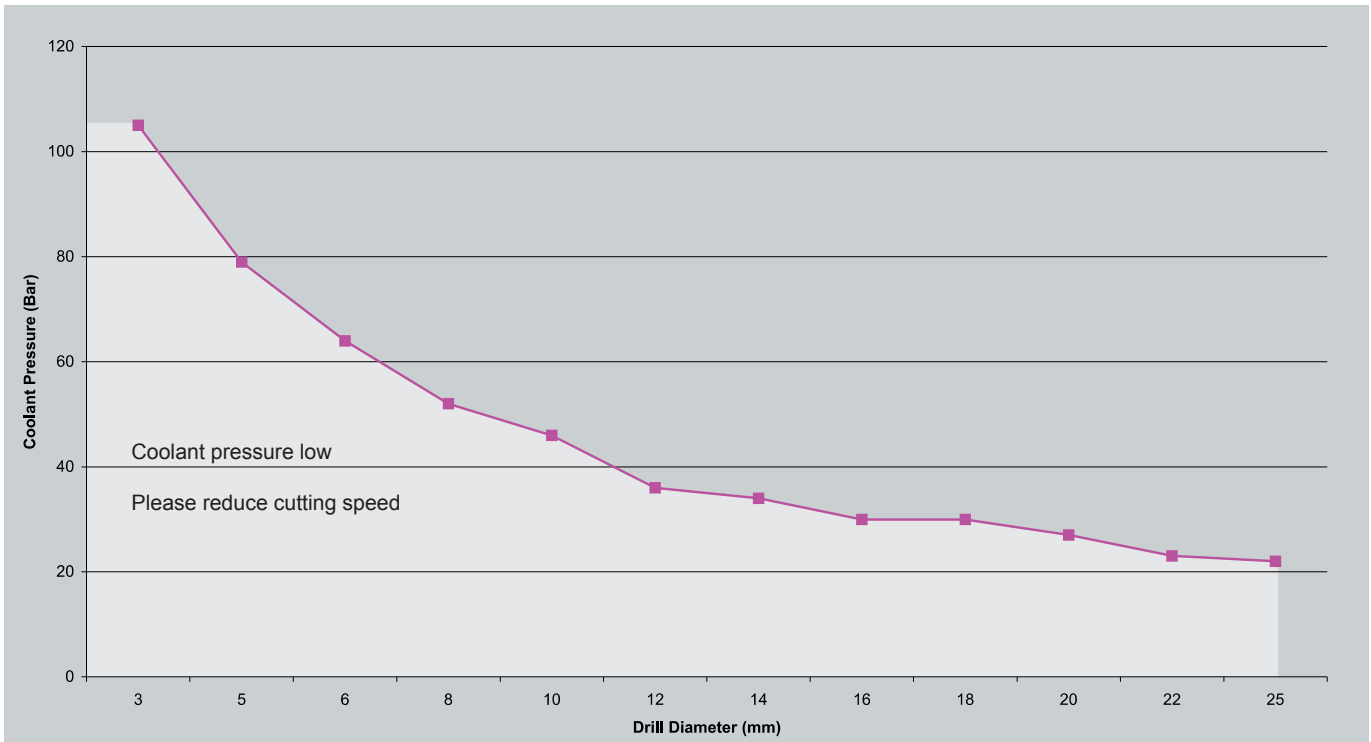

Technical data provided should be considered advisory only as variations may be necessary depending on the particular application.

For product information, call your local distributor.



Recommended Cutting Data CXD ≤ 1/4 - Inch

For applications in aluminum, brass and copper alloys use CDA series cutting data on page 142.

Workpiece Material Group	ISO	Hardness	Tool Series	TYPE	DEPTH	Drill Diameter				Drill Diameter			
						1/8	5/32	3/16	1/4	1/8	5/32	3/16	1/4
						vc - SFM				f - IPR			
Free Machining & Low Carbon Steels 1006, 1008, 1015, 1018, 1020, 1022, 1025, 1117, 1140, 1141, 11L08, 11L14, 1213, 12L13, 12L14, 1215, 1330	P	up to 28 Rc	CXDSS		3	390	380	370	360	.003-.005	.004-.006	.005-.007	.0055-.0080
			CXDSR		5	390	380	370	360				
			CXDSCS		3	660	650	640	630				
			CXDSCR		5	660	650	640	630				
			CXDCL		8	595	580	560	540				
Medium Carbon & High Carbon Steels, Alloy Steels & Easy to Machine Tool Steels 1030, 1035, 1040, 1045, 1050, 1052, 1055, 1060, 1085, 1095, 1541, 1551, 9255, 2515, 3135, 3415, 4130, 4137, 4140, 4150, 4320, 4340, 4520, 5015, 5115, 5120, 5132, 5140, 5155, 6150, 8620, 9262, 9840, 52100, O1, O2, O6, S2, W1 to W310	P	28 to 38 Rc	CXDSS		3	330	320	310	300	.003-.005	.004-.006	.005-.007	.0055-.008
			CXDSR		5	330	320	310	300				
			CXDSCS		3	575	550	540	500				
			CXDSCR		5	575	550	540	500				
			CXDCL		8	430	420	410	400				
Tool Steels & Die Steels O7, M1, M2, M3, M4, M7, T1, T2, T4, T5, T8, T15, A2, A3, A6, A7, H10, H11, H12, H13, H19, H21, L3, L6, L7, P2, P20, S1, S5, S7, 52100, A128, D2, D3, D4, D5, D7	P	28 to 44 Rc	CXDSS		3	200	190	190	185	.0014-.0030	.0024-.0040	.003-.005	.0035-.006
			CXDSR		5	200	190	190	185				
			CXDSCS		3	250	240	230	220				
			CXDSCR		5	250	240	230	220				
			CXDCL		8	225	220	215	205				
Stainless Steel - Easy to Machine 430F, 301, 303, 410, 416 Annealed, 420F, 430	M	up to 28 Rc	CXDSS		3	350	340	330	320	.003-.005	.004-.006	.005-.007	.0055-.008
			CXDSR		5	350	340	330	320				
			CXDSCS		3	550	500	475	450				
			CXDSCR		5	550	500	475	450				
			CXDCL		8	450	425	400	380				
Stainless Steel - Moderately Difficult 301, 302, 303 High Tensile, 304, 304L, 305, 420, 15-5PH, 17-4PH, 17-7PH	M	up to 28 Rc	CXDSS		3	140	135	130	125	.003-.005	.004-.006	.005-.007	.0055-.008
			CXDSR		5	140	135	130	125				
			CXDSCS		3	300	290	280	270				
			CXDSCR		5	300	290	280	270				
			CXDCL		8	280	270	260	250				
Stainless Steel - Difficult to Machine 302B, 304B, 309, 310, 316, 316B, 316L, 316Ti, 317, 317L, 321, PH13-8Mo, Nitronics	M	over 28 Rc	CXDSS		3	140	130	120	110	.0020-.0033	.0024-.0035	.0030-.0043	.0031-.005
			CXDSR		5	140	130	120	110				
			CXDSCS		3	265	250	240	230				
			CXDSCR		5	265	250	240	230				
			CXDCL		8	190	180	170	160				
High Temp Alloys Nimonic, Inconel, Monel, Hastelloy	S	up to 42 Rc	CXDSS		3	85	80	75	70	.0014-.0033	.0016-.0035	.002-.004	.0023-.0043
			CXDSR		5	85	80	75	70				
			CXDSCS		3	115	100	95	90				
			CXDSCR		5	115	100	95	90				
			CXDCL		8	100	100	95	95				
Titanium Alloys 6Al-4V, 5Al-2.5 Sn, 6Al-2 Sn-4Zr-6Mo, 3Al-8V-6Cr4Mo-4Zr, 10V-2Fe-3Al, 13V-11Cr-3Al	S	up to 42 Rc	CXDSS		3	130	125	120	115	.003-.004	.004-.006	.005-.007	.0055-.008
			CXDSR		5	130	125	120	115				
			CXDSCS		3	230	220	210	200				
			CXDSCR		5	230	220	210	200				
			CXDCL		8	210	190	180	170				
Cast Iron Gray CG, ASTM A48, CLASS 20, 25, 30, 35, SAE J431C, GRADES G1800, G3000, G3500, GG 10, 15, 20, 25, 30, 35, 40	K	up to 240 HB	CXDSS		3	480	470	460	430	.003-.005	.004-.006	.005-.007	.0055-.008
			CXDSR		5	480	470	460	430				
			CXDSCS		3	660	640	620	600				
			CXDSCR		5	660	640	620	600				
			CXDCL		8	500	490	480	470				
Cast Iron - Ductile & Malleable CGI 60-40-18, 65-45-12, D4018, D4512, D5506, 32510, 35108, M3210, M4504, M5503, 250, 300, 350, 400, 450	K	over 240 HB	CXDSS		3	280	270	260	250	.003-.005	.004-.006	.005-.007	.0055-.008
			CXDSR		5	280	270	260	250				
			CXDSCS		3	400	480	460	440				
			CXDSCR		5	400	480	460	440				
			CXDCL		8	350	340	330	320				

Technical data provided should be considered advisory only as variations may be necessary depending on the particular application.



Recommended Cutting Data CXD ≥ 5/16 - Inch

For applications in aluminum, brass and copper alloys use CDA series cutting data on page 142.

Workpiece Material Group	ISO	Hardness	Tool Series	TYPE	DEPTH	Drill Diameter						Drill Diameter					
						5/16	3/8	1/2	9/16	5/8	3/4	5/16	3/8	1/2	9/16	5/8	3/4
						vc - SFM						f - IPR					
Free Machining & Low Carbon Steels 1006, 1008, 1015, 1018, 1020, 1022, 1025, 1117, 1140, 1141, 11L08, 11L14, 1213, 12L13, 12L14, 1215, 1330	P	up to 28 Rc	CXDSS		3	350	340	320	300	275	265	.006-.009	.007-.010	.008-.011	.009-.014	.010-.014	.011-.015
			CXDSR		5	350	340	320	300	275							
			CXDSCS		3	620	600	575	550	525							
			CXDSCR		5	620	600	575	550	525	500	.006-.009	.007-.010	.009-.011	.009-.014	.010-.014	.011-.015
			CXDCL		8	520	500	480									
Medium Carbon & High Carbon Steels, Alloy Steels & Easy to Machine Tool Steels 1030, 1035, 1040, 1045, 1050, 1052, 1055, 1060, 1085, 1095, 1541, 1551, 9255, 2515, 3135, 3415, 4130, 4137, 4140, 4150, 4320, 4340, 4520, 5015, 5115, 5120, 5132, 5140, 5155, 6150, 8620, 9262, 9840, 52100, O1, O2, O6, S2, W1 to W310	P	28 to 38 Rc	CXDSS		3	290	280	270	265	260	260	.006-.009	.007-.010	.008-.011	.009-.014	.010-.014	.011-.015
			CXDSR		5	290	280	270	265	260							
			CXDSCS		3	475	450	425	400	325							
			CXDSCR		5	475	450	425	400	325	315	.006-.009	.007-.010	.009-.011	.009-.014	.010-.014	.011-.015
			CXDCL		8	375	350	325									
Tool Steels & Die Steels O7, M1, M2, M3, M4, M7, T1, T2, T4, T5, T8, T15, A2, A3, A6, A7, H10, H11, H12, H13, H19, H21, L3, L6, L7, P2, P20, S1, S5, S7, S2100, A128, D2, D3, D4, D5, D7	P	28 to 44 Rc	CXDSS		3	185	180	180	175	175	170	.006-.009	.007-.010	.008-.011	.009-.014	.010-.014	.011-.015
			CXDSR		5	185	180	180	175	175							
			CXDSCS		3	210	210	200	200	190							
			CXDSCR		5	210	210	200	200	190	190	.006-.009	.007-.010	.009-.011	.009-.014	.010-.014	.011-.015
			CXDCL		8	200	190	190									
Stainless Steel - Easy to Machine 430F, 301, 303, 410, 416 Annealed, 420F, 430	M	up to 28 Rc	CXDSS		3	310	300	275	250	225	200	.006-.009	.007-.010	.008-.011	.009-.014	.010-.014	.011-.015
			CXDSR		5	310	300	275	250	225							
			CXDSCS		3	400	390	380	370	330							
			CXDSCR		5	400	390	380	370	330	320	.006-.009	.007-.010	.008-.011	.009-.014	.010-.014	.011-.015
			CXDCL		8	375	370	350									
Stainless Steel - Moderately Difficult 301, 302, 303 High Tensile, 304, 304L, 305, 420, 15-5PH, 17-4PH, 17-7PH	M	up to 28 Rc	CXDSS		3	120	115	110	105	100	95	.006-.009	.007-.010	.008-.011	.009-.014	.010-.014	.011-.015
			CXDSR		5	120	115	110	105	100							
			CXDSCS		3	260	250	240	240	230							
			CXDSCR		5	260	250	240	240	230	220	.006-.009	.007-.010	.008-.011	.009-.014	.010-.014	.011-.015
			CXDCL		8	240	230	220									
Stainless Steel - Difficult to Machine 302B, 304B, 309, 310, 316, 316B, 316L, 316Ti, 317, 317L, 321, PH13-8Mo, Nitronics	M	over 28 Rc	CXDSS		3	110	105	105	100	100	95	.003-.006	.005-.009	.007-.009	.008-.010	.009-.011	.009-.013
			CXDSR		5	110	105	105	100	100							
			CXDSCS		3	220	200	190	180	170							
			CXDSCR		5	220	200	190	180	170	155	.003-.006	.005-.009	.007-.009	.008-.010	.009-.011	.009-.013
			CXDCL		8	150	140	130									
High Temp Alloys Nimonic, Inconel, Monel, Hastelloy	S	up to 42 Rc	CXDSS		3	65	60	55	50	45	40	.003-.005	.004-.006	.005-.007	.005-.008	.006-.008	.009-.010
			CXDSR		5	65	60	55	50	45							
			CXDSCS		3	85	85	80	80	75							
			CXDSCR		5	85	85	80	80	75	75	.003-.005	.004-.006	.005-.007	.005-.008	.006-.008	.009-.010
			CXDCL		8	90	90	85									
Titanium Alloys 6Al-4V, 5Al-2.5 Sn, 6Al-2 Sn-4Zr-6Mo, 3Al-8V-6Cr4Mo-4Zr, 10V-2Fe-3Al, 13V-11Cr-3Al	S	up to 42 Rc	CXDSS		3	110	105	100	100	90	90	.006-.009	.007-.010	.008-.011	.008-.010	.010-.014	.011-.015
			CXDSR		5	110	105	100	100	90							
			CXDSCS		3	190	180	170	160	150							
			CXDSCR		5	190	180	170	160	150	150	.006-.009	.007-.010	.008-.011	.008-.010	.010-.014	.011-.015
			CXDCL		8	160	150	140									
Cast Iron - Gray CG, ASTM A48, CLASS 20, 25, 30, 35, SAE J431C, GRADES G1800, G3000, G3500, GG 10, 15, 20, 25, 30, 35, 40	K	up to 240 HB	CXDSS		3	410	400	390	370	360	350	.006-.009	.007-.010	.008-.011	.009-.014	.010-.014	.011-.015
			CXDSR		5	410	400	390	370	360							
			CXDSCS		3	580	560	550	550	525							
			CXDSCR		5	580	560	550	550	525	500	.006-.009	.007-.010	.008-.011	.009-.014	.010-.014	.011-.015
			CXDCL		8	460	450	440									
Cast Iron - Ductile & Malleable CGI 60-40-18, 65-45-12, D4018, D4512, D5506, 32510, 35108, M3210, M4504, M5503, 250, 300, 350, 400, 450	K	over 240 HB	CXDSS		3	240	230	220	210	200	190	.006-.009	.007-.010	.008-.011	.009-.014	.010-.014	.011-.015
			CXDSR		5	240	230	220	210	200							
			CXDSCS		3	400	375	350	300	275							
			CXDSCR		5	400	375	350	300	275	250	.006-.009	.007-.010	.008-.011	.009-.014	.010-.014	.011-.015
			CXDCL		8	300	270	250									

Technical data provided should be considered advisory only as variations may be necessary depending on the particular application.

For product information, call your local distributor.

CXD
Cyclone XD

Technical Information



For applications in aluminum, brass and copper alloys, use CDA series cutting data on page 143.

Recommended Cutting Data CXD ≤ 6mm - Metric

Workpiece Material Group	ISO	Hardness	Tool Series	TYPE	DEPTH	Drill Diameter (mm)				Drill Diameter (mm)			
						3	4	5	6	3	4	5	6
						vc - m/min				f - mm/Rev			
Free Machining & Low Carbon Steels 1006, 1008, 1015, 1018, 1020, 1022, 1025, 1117, 1140, 1141, 11L08, 11L14, 1213, 12L13, 12L14, 1215, 1330	P	up to 28 Rc	CXDSS	●	3	119	116	113	110	.076-.127	.102-.152	.127-.178	.127-.203
			CXDSR		5	119	116	113	110				
			CXDCCS	●●	3	201	198	195	192	.076-.127	.102-.152	.127-.178	.127-.203
			CXDCCR		5	201	198	195	192				
			CXDCL		8	181	177	171	165				
Medium Carbon & High Carbon Steels, Alloy Steels & Easy to Machine Tool Steels 1030, 1035, 1040, 1045, 1050, 1052, 1055, 1060, 1085, 1095, 1541, 1551, 9255, 2515, 3135, 3415, 4130, 4137, 4140, 4150, 4320, 4340, 4520, 5015, 5115, 5120, 5132, 5140, 5155, 6150, 8620, 9262, 9840, 52100, O1, O2, O6, S2, W1 to W310	P	28 to 38 Rc	CXDSS	●	3	101	98	94	91	.076-.127	.102-.152	.127-.178	.127-.203
			CXDSR		5	101	98	94	91				
			CXDCCS	●●	3	175	168	165	152	.076-.127	.102-.152	.127-.178	.127-.203
			CXDCCR		5	175	168	165	152				
			CXDCL		8	131	128	125	122				
Tool Steels & Die Steels O7, M1, M2, M3, M4, M7, T1, T2, T4, T5, T8, T15, A2, A3, A6, A7, H10, H11, H12, H13, H19, H21, L3, L6, L7, P2, P20, S1, S5, S7, 52100, A128, D2, D3, D4, D5, D7	P	28 to 44 Rc	CXDSS	●	3	61	58	58	56	.036-.076	.061-.102	.076-.127	.089-.152
			CXDSR		5	61	58	58	56				
			CXDCCS	●●	3	76	73	70	67	.036-.076	.061-.102	.076-.127	.089-.152
			CXDCCR		5	76	73	70	67				
			CXDCL		8	69	67	66	62				
Stainless Steel - Easy to Machine 430F, 301, 303, 410, 416 Annealed, 420F, 430	M	up to 28 Rc	CXDSS	●	3	107	104	101	98	.076-.127	.102-.152	.127-.178	.127-.203
			CXDSR		5	107	104	101	98				
			CXDCCS	●●	3	168	152	145	137	.076-.127	.102-.152	.127-.178	.127-.203
			CXDCCR		5	168	152	145	137				
			CXDCL		8	137	130	122	116				
Stainless Steel - Moderately Difficult 301, 302, 303 High Tensile, 304, 304L, 305, 420, 15-5PH, 17-4PH, 17-7PH	M	up to 28 Rc	CXDSS	●	3	43	41	40	38	.076-.127	.102-.152	.127-.178	.127-.203
			CXDSR		5	43	41	40	38				
			CXDCCS	●●	3	91	88	85	82	.076-.127	.102-.152	.127-.178	.127-.203
			CXDCCR		5	91	88	85	82				
			CXDCL		8	85	82	79	76				
Stainless Steel - Difficult to Machine 302B, 304B, 309, 310, 316, 316B, 316L, 316Ti, 317, 317L, 321, PH13-8Mo, Nitronics	M	over 28 Rc	CXDSS	●	3	43	40	37	34	.051-.076	.061-.089	.089-.102	.076-.127
			CXDSR		5	43	40	37	34				
			CXDCCS	●●	3	81	76	73	70	.051-.076	.061-.089	.089-.102	.076-.127
			CXDCCR		5	81	76	73	70				
			CXDCL		8	58	55	52	49				
High Temp Alloys Nimonic, Inconel, Monel, Hastelloy	S	up to 42 Rc	CXDSS	●	3	26	24	23	21	.036-.089	.036-.089	.051-.102	.061-.127
			CXDSR		5	26	24	23	21				
			CXDCCS	●●	3	35	30	29	27	.036-.089	.036-.089	.051-.102	.061-.127
			CXDCCR		5	35	30	29	27				
			CXDCL		8	30	30	29	29				
Titanium Alloys 6Al-4V, 5Al-2.5 Sn, 6Al-2 Sn-4Zr-6Mo, 3Al-8V-6Cr4Mo-4Zr, 10V-2Fe-3Al, 13V-11Cr-3Al	S	up to 42 Rc	CXDSS	●	3	40	38	37	35	.076-.102	.102-.152	.127-.178	.140-.229
			CXDSR		5	40	38	37	35				
			CXDCCS	●●	3	70	67	64	61	.076-.102	.102-.152	.127-.178	.140-.229
			CXDCCR		5	70	67	64	61				
			CXDCL		8	64	58	55	52				
Cast Iron Gray CG, ASTM A48, CLASS 20, 25, 30, 35, SAE J431C, GRADES G1800, G3000, G3500, GG 10, 15, 20, 25, 30, 35, 40	K	up to 240 HB	CXDSS	●	3	146	143	140	131	.076-.127	.102-.152	.127-.178	.127-.203
			CXDSR		5	146	143	140	131				
			CXDCCS	●●	3	201	195	189	183	.076-.127	.102-.152	.127-.178	.127-.203
			CXDCCR		5	201	195	189	183				
			CXDCL		8	152	149	146	143				
Cast Iron - Ductile & Malleable CGI 60-40-18, 65-45-12, D4018, D4512, D5506, 32510, 35108, M3210, M4504, M5503, 250, 300, 350, 400, 450	K	over 240 HB	CXDSS	●	3	85	82	79	76	.076-.127	.102-.152	.127-.178	.127-.203
			CXDSR		5	85	82	79	76				
			CXDCCS	●●	3	122	146	140	134	.076-.127	.102-.152	.127-.178	.127-.203
			CXDCCR		5	122	146	140	134				
			CXDCL		8	107	104	101	98				

Technical data provided should be considered advisory only as variations may be necessary depending on the particular application.



For applications in aluminum, brass and copper alloys, use CDA series cutting data on page 143.

Recommended Cutting Data CXD ≥ 8mm - Metric

Workpiece Material Group	I S O	Hardness	Tool Series	T Y P E	D E P T H	Drill Diameter (mm)							Drill Diameter (mm)							
						8	10	12	14	16	18	20	8	10	12	14	16	18	20	
						vc - m/min							f - mm/Rev							
Free Machining & Low Carbon Steels 1006, 1008, 1015, 1018, 1020, 1022, 1025, 1117, 1140, 1141, 11L08, 11L14, 1213, 12L13, 12L14, 1215, 1330	P	up to 28 Rc	CXDSS	●	3	107	104	98	91	84	81	77	.16-.24	.18-.27	.21-.31	.22-.35	.25-.35	.28-.38	.30-.37	
			CXDSR		5	107	104	98	91	84	81									
			CXDCS	●	3	189	183	175	168	160	152									
			CXDGR		5	189	183	175	168	160	152	145	.16-.24	.18-.27	.21-.31	.22-.35	.25-.35	.28-.38	.30-.37	
			CXDCL		8	158	152	146												
Medium Carbon & High Carbon Steels, Alloy Steels & Easy to Machine Tool Steels 1030, 1035, 1040, 1045, 1050, 1052, 1055, 1060, 1085, 1095, 1541, 1551, 9255, 2515, 3135, 3415, 4130, 4137, 4140, 4150, 4320, 4340, 4520, 5015, 5115, 5120, 5132, 5140, 5155, 6150, 8620, 9262, 9840, 52100, O1, O2, O6, S2, W1 to W310	P	28 to 38 Rc	CXDSS	●	3	88	85	82	81	79	79	75	.16-.24	.18-.27	.21-.31	.22-.35	.25-.35	.28-.38	.30-.37	
			CXDSR		5	88	85	82	81	79	79									
			CXDCS	●	3	145	137	130	122	99	96									
			CXDGR		5	145	137	130	122	99	96	92	.16-.24	.18-.27	.21-.31	.22-.35	.25-.35	.28-.38	.30-.37	
			CXDCL		8	114	107	99												
Tool Steels & Die Steels O7, M1, M2, M3, M4, M7, T1, T2, T4, T5, T8, T15, A2, A3, A6, A7, H10, H11, H12, H13, H19, H21, L3, L6, L7, P2, P20, S1, S5, S7, 52100, A128, D2, D3, D4, D5, D7	P	28 to 44 Rc	CXDSS	●	3	56	55	55	53	53	52	49	.16-.24	.18-.27	.21-.31	.22-.35	.25-.35	.28-.38	.30-.37	
			CXDSR		5	56	55	55	53	53	52									
			CXDCS	●	3	64	64	61	61	58	58									
			CXDGR		5	64	64	61	61	58	58	55	.16-.24	.18-.27	.21-.31	.22-.35	.25-.35	.28-.38	.30-.37	
			CXDCL		8	61	58	58												
Stainless Steel - Easy to Machine 430F, 301, 303, 410, 416 Annealed, 420F, 430	M	up to 28 Rc	CXDSS	●	3	94	91	84	76	69	61	55	.16-.24	.18-.27	.21-.31	.22-.35	.25-.36	.28-.38	.30-.37	
			CXDSR		5	94	91	84	76	69	61									
			CXDCS	●	3	122	119	116	113	101	98									
			CXDGR		5	122	119	116	113	101	98	94	.16-.24	.18-.27	.21-.31	.22-.35	.25-.35	.28-.38	.30-.37	
			CXDCL		8	114	113	107												
Stainless Steel - Moderately Difficult 301, 302, 303 High Tensile, 304, 304L, 305, 420, 15-5PH, 17-4PH, 17-7PH	M	up to 28 Rc	CXDSS	●	3	37	35	34	32	30	29	28	.16-.24	.18-.27	.21-.31	.22-.35	.25-.36	.28-.38	.30-.37	
			CXDSR		5	37	35	34	32	30	29									
			CXDCS	●	3	79	76	73	73	70	67									
			CXDGR		5	79	76	73	73	70	67	64	.16-.24	.18-.27	.21-.31	.22-.35	.25-.35	.28-.38	.30-.37	
			CXDCL		8	73	70	67												
Stainless Steel - Difficult to Machine 302B, 304B, 309, 310, 316, 316B, 316L, 316Ti, 317, 317L, 321, PH13-8Mo, Nitronics	M	over 28 Rc	CXDSS	●	3	34	32	32	30	30	29	27	.11-.15	.13-.23	.18-.25	.21-.27	.22-.31	.25-.33	.30-.37	
			CXDSR		5	34	32	32	30	30	29									
			CXDCS	●	3	67	61	58	55	52	47									
			CXDGR		5	67	61	58	55	52	47	45	.11-.15	.13-.23	.18-.25	.21-.27	.22-.31	.25-.33	.30-.37	
			CXDCL		8	46	43	40												
High Temp Alloys Nimonic, Inconel, Monel, Hastelloy	S	up to 42 Rc	CXDSS	●	3	20	18	17	15	14	12	11	.08-.13	.11-.15	.12-.17	.14-.19	.16-.21	.18-.25	.17-.24	
			CXDSR		5	20	18	17	15	14	12									
			CXDCS	●	3	26	26	24	24	23	23									
			CXDGR		5	26	26	24	24	23	23	22	.09-.13	.11-.15	.12-.17	.14-.19	.16-.21	.18-.25	.17-.24	
			CXDCL		8	27	27	26												
Titanium Alloys 6Al-4V, 5Al-2.5 Sn, 6Al-2 Sn-4Zr-6Mo, 3Al-8V-6Cr4Mo-4Zr, 10V-2Fe-3Al, 13V-11Cr-3Al	S	up to 42 Rc	CXDSS	●	3	34	32	30	30	27	27	25	.16-.24	.18-.27	.21-.31	.22-.35	.25-.36	.28-.38	.30-.37	
			CXDSR		5	34	32	30	30	27	27									
			CXDCS	●	3	55	55	52	49	46	46									
			CXDGR		5	55	55	52	49	46	46	44	.16-.24	.18-.27	.21-.31	.22-.35	.25-.36	.28-.38	.30-.37	
			CXDCL		8	49	46	43												
Cast Iron - Gray CG, ASTM A48, CLASS 20, 25, 30, 35, SAE J431C, GRADES G1800, G3000, G3500, GG 10, 15, 20, 25, 30, 35, 40	K	up to 240 HB	CXDSS	●	3	125	122	119	113	110	107	102	.16-.24	.18-.27	.21-.31	.22-.35	.25-.36	.28-.38	.30-.37	
			CXDSR		5	125	122	119	113	110	107									
			CXDCS	●	3	177	171	168	168	160	152									
			CXCDR		5	177	171	168	168	160	152	145	.16-.24	.18-.27	.21-.31	.22-.35	.25-.35	.28-.38	.30-.37	
			CXDCL		8	140	137	134												
Cast Iron - Ductile & Malleable CGI 60-40-18, 65-45-12, D4018, D4512, D5506, 32510, 35108, M3210, M4504, M5503, 250, 300, 350, 400, 450	K	over 240 HB	CXDSS	●	3	73	70	67	64	61	58	55	.16-.24	.18-.27	.21-.31	.22-.35	.25-.36	.28-.38	.30-.37	
			CXDSR		5	73	70	67	64	61	58									
			CXDCS	●	3	122	114	107	91	84	76									
			CXDGR		5	122	114	107	91	84	76	72	.16-.24	.18-.27	.21-.31	.22-.35	.25-.35	.28-.38	.30-.37	
			CXDCL		8	91	82	76												

CXD
Cyclone XD

Technical Information

Technical data provided should be considered advisory only as variations may be necessary depending on the particular application.

For product information, call your local distributor.



Recommended Cutting Data CDACR - Inch

Workpiece Material Group	I S O	Hardness	vc - SFM			Drill Diameter					
			Min	Starting Value	Max	1/8	3/16	1/4	5/16	3/8	1/2
			f - IPR								
Aluminum & Aluminum Wrought Alloys	10	60-100 Brinell HB	390	750	1480	.005-.010	.006-.011	.007-.014	.008-.017	.011-.020	.013-.022
Cast Aluminum Alloys	20	75-90 Brinell HB	390	720	1150	.006-.009	.006-.011	.007-.013	.009-.015	.011-.018	.013-.021
Aluminum Alloys Cast 13-22% Si	N 30		330	590	1310	.005-.007	.006-.007	.006-.010	.008-.012	.011-.015	.013-.017
Copper and Copper Alloys, Brass, Bronze, Copper	40	90-110 Brinell HB	330	430	980	.004-.006	.005-.007	.006-.009	.006-.011	.007-.013	.008-.014

Definition

This group contains non-ferrous, soft metals with hardness under 130 HB, except for high strength bronzes (>225HB)
 Aluminum (Al) alloys comprising less than 12-13% silicon (Si) represent the largest part
 MMC: Metal Matrix Composite: Al + SiC (20-30%)
 Magnesium based alloys
 Copper, electrolytic copper with 99.95% Cu
 Bronze: Copper with Tin (Sn) (10-14%) and/or aluminum (3-10%)
 Brass: Copper (60-85%) with Zinc (Zn) (40-15%)

Machinability of Aluminum

Long-chipping material
 Relatively easy chip control, if alloyed
 Pure Al is sticky and requires sharp cutting edges and high cutting speeds (Vc), consider Fordlube coating.
 Specific cutting force: 350–700 N/mm²
 Cutting forces, and thus the power required to machine them, are low.
 For Cast Aluminum with Si-content above 13%, consider CERAedge® coating.
 Over eutectic Al with higher Si-content > 12% is very abrasive, consider an engineered custom tool solution with GemX coating or PCD diamond tipped.

Common components

Engine block, cylinder head, transmission housings, casings, aerospace frame components.





Recommended Cutting Data CDACR - Metric

Workpiece Material Group	I S O	Hardness	vc - m/min			Drill Diameter (mm)					
			Min	Starting Value	Max	3.0	4.0	6.0	8.0	10.0	12.0
						f - mm/Rev					
Aluminum & Aluminum Wrought Alloys	10	60-100 Brinell HB	120	230	450	0.13-0.25	0.14-0.29	0.17-0.35	0.21-0.42	0.27-0.50	0.33-0.57
Cast Aluminum Alloys	20	75-90 Brinell HB	120	220	350	0.14-0.23	0.15-0.28	0.17-0.34	0.22-0.39	0.29-0.46	0.34-0.54
Aluminum Alloys Cast 13-22% Si	N 30		100	180	400	0.13-0.18	0.14-0.19	0.16-0.25	0.20-0.30	0.28-0.37	0.33-0.42
Copper and Copper Alloys, Brass, Bronze, Copper	40	90-110 Brinell HB	100	130	300	0.10-0.16	0.12-0.18	0.14-0.24	0.16-0.28	0.18-0.32	0.20-0.36

Definition

This group contains non-ferrous, soft metals with hardness under 130 HB, except for high strength bronzes (>225HB)
 Aluminum (Al) alloys comprising less than 12-13% silicon (Si) represent the largest part
 MMC: Metal Matrix Composite: Al + SiC (20-30%)
 Magnesium based alloys
 Copper, electrolytic copper with 99.95% Cu
 Bronze: Copper with Tin (Sn) (10-14%) and/or aluminum (3-10%)
 Brass: Copper (60-85%) with Zinc (Zn) (40-15%)

Machinability of Aluminum

Long-chipping material
 Relatively easy chip control, if alloyed
 Pure Al is sticky and requires sharp cutting edges and high cutting speeds (Vc), consider Fordlube coating.
 Specific cutting force: 350-700 N/mm²
 Cutting forces, and thus the power required to machine them, are low.
 For Cast Aluminum with Si-content above 13%, consider CERAedge® coating.
 Over eutectic Al with higher Si-content > 12% is very abrasive, consider an engineered custom tool solution with GemX coating or PCD diamond tipped.

Common components

Engine block, cylinder head, transmission housings, casings, aerospace frame components.



Recommended Cutting Data XD ≤ 1/4 - Inch

Workpiece Material Group	I S O	Hardness	Tool Series	T Y P E	D E P T H	Drill Diameter						Drill Diameter					
						1/64	1/16	1/8	5/32	3/16	1/4	1/64	1/16	1/8	5/32	3/16	1/4
						vc - SFM						f - IPR					
Free Machining & Low Carbon Steels 1006, 1008, 1015, 1018, 1020, 1022, 1025, 1117, 1140, 1141, 11L08, 11L14, 1213, 12L13, 12L14, 1215, 1330	P	up to 28 Rc	2XDSS		3			390	380	370	360	.001-.002	.002-.003	.003-.005	.004-.006	.005-.007	.0055-.0080
			2XDSR		5	405	400	390	380	370	360						
			2XDSC		3			660	650	640	630						
			2XDRC		5			660	650	640	630						
			2XDCL		7+			595	580	560	540						
Medium Carbon & High Carbon Steels, Alloy Steels & Easy to Machine Tool Steels 1030, 1035, 1040, 1045, 1050, 1052, 1055, 1060, 1085, 1095, 1541, 1551, 9255, 2515, 3135, 3415, 4130, 4137, 4140, 4150, 4320, 4340, 4520, 5015, 5115, 5120, 5132, 5140, 5155, 6150, 8620, 9262, 9840, 52100, O1, O2, O6, S2, W1 to W310	P	28 to 38 Rc	2XDSS		3			330	320	310	300	.001-.002	.002-.003	.003-.005	.004-.006	.005-.007	.0055-.0080
			2XDSR		5	350	340	330	320	310	300						
			2XDSC		3			575	550	540	500						
			2XDRC		5			575	550	540	500						
			2XDCL		7+			430	420	410	400						
Tool Steels & Die Steels O7, M1, M2, M3, M4, M7, T1, T2, T4, T5, T8, T15, A2, A3, A6, A7, H10, H11, H12, H13, H19, H21, L3, L6, L7, P2, P20, S1, S5, S7, 52100, A128, D2, D3, D4, D5, D7	P	28 to 44 Rc	2XDSS		3			200	190	190	185	.0004-.0008	.0008-.0012	.0014-.0030	.0024-.0040	.003-.005	.0035-.0060
			2XDSR		5	210	200	200	190	190	185						
			2XDSC		3			250	240	230	220						
			2XDRC		5			250	240	230	220						
			2XDCL		7+			225	220	215	205						
Stainless Steel - Easy to Machine 430F, 301, 303, 410, 416 Annealed, 420F, 430	M	up to 28 Rc	2XDSS		3			350	340	330	320	.001-.002	.002-.003	.003-.005	.004-.006	.005-.007	.0055-.0080
			2XDSR		5	360	355	350	340	330	320						
			2XDSC		3			550	500	475	450						
			2XDRC		5			550	500	475	450						
			2XDCL		7+			450	425	400	380						
Stainless Steel - Moderately Difficult 301, 302, 303 High Tensile, 304, 304L, 305, 420, 15-5PH, 17-4PH, 17-7PH	M	up to 28 Rc	2XDSS		3			140	135	130	125	.001-.002	.002-.003	.003-.005	.004-.006	.005-.007	.0055-.0080
			2XDSR		5	150	145	140	135	130	125						
			2XDSC		3			300	290	280	270						
			2XDRC		5			300	290	280	270						
			2XDCL		7+			280	270	260	250						
Stainless Steel - Difficult to Machine 302B, 304B, 309, 310, 316, 316B, 316L, 316Ti, 317, 317L, 321, PH13-8Mo, Nitronics	M	over 28 Rc	2XDSS		3			140	130	120	110	.0004-.0012	.001-.002	.0020-.0033	.0024-.0035	.0030-.0043	.0031-.0050
			2XDSR		5	160	150	140	130	120	110						
			2XDSC		3			265	250	240	230						
			2XDRC		5			265	250	240	230						
			2XDCL		7+			190	180	170	160						
High Temp Alloys Nimonic, Inconel, Monel, Hastelloy	S	up to 42 Rc	2XDSS		3			85	80	75	70	.0004-.0012	.001-.002	.0014-.0033	.0016-.0035	.002-.004	.0023-.0043
			2XDSR		5	100	90	85	80	75	70						
			2XDSC		3			115	100	95	90						
			2XDRC		5			115	100	95	90						
			2XDCL		7+			100	100	95	95						
Titanium Alloys 6Al-4V, 5Al-2.5 Sn, 6Al-2 Sn-4Zr-6Mo, 3Al-8V-6Cr4Mo-4Zr, 10V-2Fe-3Al, 13V-11Cr-3Al	S	up to 42 Rc	2XDSS		3			130	125	120	115	.0004-.0012	.001-.002	.003-.004	.004-.006	.005-.007	.0055-.0080
			2XDSR		5	150	140	130	125	120	115						
			2XDSC		3			230	220	210	200						
			2XDRC		5			230	220	210	200						
			2XDCL		7+			210	190	180	170						
Cast Iron - Gray CG, ASTM A48, CLASS 20, 25, 30, 35, SAE J431C, GRADES G1800, G3000, G3500, GG 10, 15, 20, 25, 30, 35, 40	K	up to 240 HB	2XDSS		3			480	470	460	430	.001-.002	.002-.003	.003-.005	.004-.006	.005-.007	.0055-.0080
			2XDSR		5	500	490	480	470	460	430						
			2XDSC		3			660	640	620	600						
			2XDRC		5			660	640	620	600						
			2XDCL		7+			500	490	480	470						
Cast Iron Ductile & Malleable CGI 60-40-18, 65-45-12, D4018, D4512, D5506, 32510, 35108, M3210, M4504, M5503, 250, 300, 350, 400, 450	K	over 240 HB	2XDSS		3			280	270	260	250	.001-.002	.002-.003	.003-.005	.004-.006	.005-.007	.0055-.0080
			2XDSR		5	300	290	280	270	260	250						
			2XDSC		3			400	480	460	440						
			2XDRC		5			400	480	460	440						
			2XDCL		7+			350	340	330	320						

Technical data provided should be considered advisory only as variations may be necessary depending on the particular application.

Recommended Cutting Data XD ≥ 5/16 - Inch

Workpiece Material Group	ISO	Hardness	Tool Series	TYPE	DEPTH	Drill Diameter						Drill Diameter					
						5/16	3/8	1/2	9/16	5/8	3/4	5/16	3/8	1/2	9/16	5/8	3/4
						vc - SFM						f - IPR					
Free Machining & Low Carbon Steels 1006, 1008, 1015, 1018, 1020, 1022, 1025, 1117, 1140, 1141, 11L08, 11L14, 1213, 12L13, 12L14, 1215, 1330	P	up to 28 Rc	2XDSS	●	3	350	340	320	300	275	265	.006-.009	.007-.010	.008-.011	.009-.014	.010-.014	.011-.015
			2XDSR		5	350	340	320	300	275	265						
			2XDSCS	● ●	3	620	600	575	550	525	500	.006-.009	.007-.010	.009-.011	.009-.014	.010-.014	.011-.015
			2XDCLR		5	620	600	575	550	525	500						
			2XDCL		7+	520	500	480	460	440	430						
Medium Carbon & High Carbon Steels, Alloy Steels & Easy to Machine Tool Steels 1030, 1035, 1040, 1045, 1050, 1052, 1055, 1060, 1085, 1095, 1541, 1551, 9255, 2515, 3135, 3415, 4130, 4137, 4140, 4150, 4320, 4340, 4520, 5015, 5115, 5120, 5132, 5140, 5155, 6150, 8620, 9262, 9840, 52100, O1, O2, O6, S2, W1 to W310	P	28 to 38 Rc	2XDSS	●	3	290	280	270	265	260	260	.006-.009	.007-.010	.008-.011	.009-.014	.010-.014	.011-.015
			2XDSR		5	290	280	270	265	260	260						
			2XDSCS	● ●	3	475	450	425	400	325	315	.006-.009	.007-.010	.009-.011	.009-.014	.010-.014	.011-.015
			2XDCLR		5	475	450	425	400	325	315						
			2XDCL		7+	375	350	325	315	300	280						
Tool Steels & Die Steels O7, M1, M2, M3, M4, M7, T1, T2, T4, T5, T8, T15, A2, A3, A6, A7, H10, H11, H12, H13, H19, H21, L3, L6, L7, P2, P20, S1, S5, S7, 52100, A128, D2, D3, D4, D5, D7	P	28 to 44 Rc	2XDSS	●	3	185	180	180	175	175	170	.006-.009	.007-.010	.008-.011	.009-.014	.010-.014	.011-.015
			2XDSR		5	185	180	180	175	175	170						
			2XDSCS	● ●	3	210	210	200	200	190	190	.006-.009	.007-.010	.009-.011	.009-.014	.010-.014	.011-.015
			2XDCLR		5	210	210	200	200	190	190						
			2XDCL		7+	200	190	190	180	180	170						
Stainless Steel - Easy to Machine 430F, 301, 303, 410, 416 Annealed, 420F, 430	M	up to 28 Rc	2XDSS	●	3	310	300	275	250	225	200	.006-.009	.007-.010	.008-.011	.009-.014	.010-.014	.011-.015
			2XDSR		5	310	300	275	250	225	200						
			2XDSCS	● ●	3	400	390	380	370	330	320	.006-.009	.007-.010	.008-.011	.009-.014	.010-.014	.011-.015
			2XDCLR		5	400	390	380	370	330	320						
			2XDCL		7+	375	370	350	325	310	300						
Stainless Steel - Moderately Difficult 301, 302, 303 High Tensile, 304, 304L, 305, 420, 15-5PH, 17-4PH, 17-7PH	M	up to 28 Rc	2XDSS	●	3	120	115	110	105	100	95	.006-.009	.007-.010	.008-.011	.009-.014	.010-.014	.011-.015
			2XDSR		5	120	115	110	105	100	95						
			2XDSCS	● ●	3	260	250	240	240	230	220	.006-.009	.007-.010	.008-.011	.009-.014	.010-.014	.011-.015
			2XDCLR		5	260	250	240	240	230	220						
			2XDCL		7+	240	230	220	220	200	200						
Stainless Steel - Difficult to Machine 302B, 304B, 309, 310, 316, 316B, 316L, 316Ti, 317, 317L, 321, PH13-8Mo, Nitronics	M	over 28 Rc	2XDSS	●	3	110	105	105	100	100	95	.003-.006	.005-.009	.007-.009	.008-.010	.009-.011	.009-.013
			2XDSR		5	110	105	105	100	100	95						
			2XDSCS	● ●	3	220	200	190	180	170	155	.003-.006	.005-.009	.007-.009	.008-.010	.009-.011	.009-.013
			2XDCLR		5	220	200	190	180	170	155						
			2XDCL		7+	150	140	130	130	125	125						
High Temp Alloys Nimonic, Inconel, Monel, Hastelloy	S	up to 42 Rc	2XDSS	●	3	65	60	55	50	45	40	.003-.005	.004-.006	.005-.007	.005-.008	.006-.008	.009-.010
			2XDSR		5	65	60	55	50	45	40						
			2XDSCS	● ●	3	85	85	80	80	75	75	.003-.005	.004-.006	.005-.007	.005-.008	.006-.008	.009-.010
			2XDCLR		5	85	85	80	80	75	75						
			2XDCL		7+	90	90	85	85	75	75						
Titanium Alloys 6Al-4V, 5Al-2.5 Sn, 6Al-2 Sn-4Zr-6Mo, 3Al-8V-6Cr4Mo-4Zr, 10V-2Fe-3Al, 13V-11Cr-3Al	S	up to 42 Rc	2XDSS	●	3	110	105	100	100	90	90	.006-.009	.007-.010	.008-.011	.008-.010	.010-.014	.011-.015
			2XDSR		5	110	105	100	100	90	90						
			2XDSCS	● ●	3	190	180	170	160	150	150	.006-.009	.007-.010	.008-.011	.008-.010	.010-.014	.011-.015
			2XDCLR		5	190	180	170	160	150	150						
			2XDCL		7+	160	150	140	130	120	120						
Cast Iron - Gray CG, ASTM A48, CLASS 20, 25, 30, 35, SAE J431C, GRADES G1800, G3000, G3500, GG 10, 15, 20, 25, 30, 35, 40	K	up to 240 HB	2XDSS	●	3	410	400	390	370	360	350	.006-.009	.007-.010	.008-.011	.009-.014	.010-.014	.011-.015
			2XDSR		5	410	400	390	370	360	350						
			2XDSCS	● ●	3	580	560	550	550	525	500	.006-.009	.007-.010	.008-.011	.009-.014	.010-.014	.011-.015
			2XDCLR		5	580	560	550	550	525	500						
			2XDCL		7+	460	450	440	430	410	400						
Cast Iron - Ductile & Malleable CGI 60-40-18, 65-45-12, D4018, D4512, D5506, 32510, 35108, M3210, M4504, M5503, 250, 300, 350, 400, 450	K	over 240 HB	2XDSS	●	3	240	230	220	210	200	190	.006-.009	.007-.010	.008-.011	.009-.014	.010-.014	.011-.015
			2XDSR		5	240	230	220	210	200	190						
			2XDSCS	● ●	3	400	375	350	300	275	250	.006-.009	.007-.010	.008-.011	.009-.014	.010-.014	.011-.015
			2XDCLR		5	400	375	350	300	275	250						
			2XDCL		7+	300	270	250	240	220	200						

Technical data provided should be considered advisory only as variations may be necessary depending on the particular application.

For product information, call your local distributor.

Recommended Cutting Data X^D ≤ 6mm - Metric

Workpiece Material Group	ISO	Hardness	Tool Series	TYPE	DEPTH	Drill Diameter (mm)						Drill Diameter (mm)						
						0.05	1.5	3	4	5	6	0.05	1.5	3	4	5	6	
						vc - m/min						f - mm/Rev						
Free Machining & Low Carbon Steels 1006, 1008, 1015, 1018, 1020, 1022, 1025, 1117, 1140, 1141, 11L08, 11L14, 1213, 12L13, 12L14, 1215, 1330	P	up to 28 Rc	2XDSS		3			119	116	113	110	.025-.051	.051-.076	.076-.127	.102-.152	.127-.178	.127-.203	
			2XDSCR		5	123	122	119	116	113	110							
			2XDSCS			3			201	198	195	192			.076-.127	.102-.152	.127-.178	.127-.203
			2XDSCR			5			201	198	195	192						
			2XDCL			7+			181	177	171	165						
Medium Carbon & High Carbon Steels, Alloy Steels & Easy to Machine Tool Steels 1030, 1035, 1040, 1045, 1050, 1052, 1055, 1060, 1085, 1095, 1541, 1551, 9255, 2515, 3135, 3415, 4130, 4137, 4140, 4150, 4320, 4340, 4520, 5015, 5115, 5120, 5132, 5140, 5155, 6150, 8620, 9262, 9840, 52100, O1, O2, O6, S2, W1 to W310	P	28 to 38 Rc	2XDSS		3			101	98	94	91	.025-.051	.051-.076	.076-.127	.102-.152	.127-.178	.127-.203	
			2XDSCR		5	107	104	101	98	94	91							
			2XDSCS			3			175	168	165	152			.076-.127	.102-.152	.127-.178	.127-.203
			2XDSCR			5			175	168	165	152						
			2XDCL			7+			131	128	125	122						
Tool Steels & Die Steels O7, M1, M2, M3, M4, M7, T1, T2, T4, T5, T8, T15, A2, A3, A6, A7, H10, H11, H12, H13, H19, H21, L3, L6, L7, P2, P20, S1, S5, S7, 52100, A128, D2, D3, D4, D5, D7	P	28 to 44 Rc	2XDSS		3			61	58	58	56	.010-.020	.020-.030	.036-.076	.061-.102	.076-.127	.089-.152	
			2XDSCR		5	64	61	61	58	58	56							
			2XDSCS			3			76	73	70	67			.036-.076	.061-.102	.076-.127	.089-.152
			2XDSCR			5			76	73	70	67						
			2XDCL			7+			69	67	66	62						
Stainless Steel - Easy to Machine 430F, 301, 303, 410, 416 Annealed, 420F, 430	M	up to 28 Rc	2XDSS		3			107	104	101	98	.025-.051	.051-.076	.076-.127	.102-.152	.127-.178	.127-.203	
			2XDSCR		5	125	120	107	104	101	98							
			2XDSCS			3			168	152	145	137			.076-.127	.102-.152	.127-.178	.127-.203
			2XDSCR			5			168	152	145	137						
			2XDCL			7+			137	130	122	116						
Stainless Steel - Moderately Difficult 301, 302, 303 High Tensile, 304, 304L, 305, 420, 15-5PH, 17-4PH, 17-7PH	M	up to 28 Rc	2XDSS		3			43	41	40	38	.025-.051	.051-.076	.076-.127	.102-.152	.127-.178	.127-.203	
			2XDSCR		5	50	48	43	41	40	38							
			2XDSCS			3			91	88	85	82			.076-.127	.102-.152	.127-.178	.127-.203
			2XDSCR			5			91	88	85	82						
			2XDCL			7+			85	82	79	76						
Stainless Steel - Difficult to Machine 302B, 304B, 309, 310, 316, 316B, 316L, 316Ti, 317, 317L, 321, PH13-8Mo, Nitronics	M	over 28 Rc	2XDSS		3			43	40	37	34	.010-.030	.025-.051	.051-.076	.061-.089	.089-.102	.076-.127	
			2XDSCR		5	49	46	43	40	37	34							
			2XDSCS			3			81	76	73	70			.051-.076	.061-.089	.089-.102	.076-.127
			2XDSCR			5			81	76	73	70						
			2XDCL			7+			58	55	52	49						
High Temp Alloys Nimionics, Inconel, Monel, Hastelloy	S	up to 42 Rc	2XDSS		3			26	24	23	21	.010-.030	.025-.051	.036-.089	.036-.089	.051-.102	.061-.127	
			2XDSCR		5	30	27	26	24	23	21							
			2XDSCS			3			35	30	29	27			.036-.089	.036-.089	.051-.102	.061-.127
			2XDSCR			5			35	30	29	27						
			2XDCL			7+			30	30	29	29						
Titanium Alloys 6Al-4V, 5Al-2.5 Sn, 6Al-2 Sn-4Zr-6Mo, 3Al-8V-6Cr-4Mo-4Zr, 10V-2Fe-3Al, 13V-11Cr-3Al	S	up to 42 Rc	2XDSS		3			40	38	37	35	.010-.030	.025-.051	.076-.102	.102-.152	.127-.178	.140-.229	
			2XDSCR		5	46	43	40	38	37	35							
			2XDSCS			3			70	67	64	61			.076-.102	.102-.152	.127-.178	.140-.229
			2XDSCR			5			70	67	64	61						
			2XDCL			7+			64	58	55	52						
Cast Iron - Gray CG, ASTM A48, CLASS 20, 25, 30, 35, SAE J431C, GRADES G1800, G3000, G3500, GG 10, 15, 20, 25, 30, 35, 40	K	up to 240 HB	2XDSS		3			146	143	140	131	.025-.051	.051-.076	.076-.127	.102-.152	.127-.178	.127-.203	
			2XDSCR		5	152	149	146	143	140	131							
			2XDSCS			3			201	195	189	183			.076-.127	.102-.152	.127-.178	.127-.203
			2XDSCR			5			201	195	189	183						
			2XDCL			7+			152	149	146	143						
Cast Iron - Ductile & Malleable CGI 60-40-18, 65-45-12, D4018, D4512, D5506, 32510, 35108, M3210, M4504, M5503, 250, 300, 350, 400, 450	K	over 240 HB	2XDSS		3			85	82	79	76	.025-.051	.051-.076	.076-.127	.102-.152	.127-.178	.127-.203	
			2XDSCR		5	91	88	85	82	79	76							
			2XDSCS			3			122	146	140	134			.076-.127	.102-.152	.127-.178	.127-.203
			2XDSCR			5			122	146	140	134						
			2XDCL			7+			107	104	101	98						

Technical data provided should be considered advisory only as variations may be necessary depending on the particular application.

Recommended Cutting Data XD ≥ 8mm - Metric

Workpiece Material Group	ISO	Hardness	Tool Series	TYPE	DEPTH	Drill Diameter (mm)							Drill Diameter (mm)								
						8	10	12	14	16	18	20	8	10	12	14	16	18	20		
						vc - m/min							f - mm/Rev								
Free Machining & Low Carbon Steels 1006, 1008, 1015, 1018, 1020, 1022, 1025, 1117, 1140, 1141, 11L08, 11L14, 1213, 12L13, 12L14, 1215, 1330	P	up to 28 Rc	2XDSS	●	3	107	104	98	91	84	81	77	.16-.24	.18-.27	.21-.31	.22-.35	.25-.35	.28-.38	.30-.37		
			2XDSR	●	5	107	104	98	91	84	81	77									
			2XDSCS	●	3	189	183	175	168	160	152	145									
			2XDSCR	●	5	189	183	175	168	160	152	145	.16-.24	.18-.27	.21-.31	.22-.35	.25-.35	.28-.38	.30-.37		
			2XDCL	●	7+	158	152	146	140	134	131	125									
Medium Carbon & High Carbon Steels, Alloy Steels & Easy to Machine Tool Steels 1030, 1035, 1040, 1045, 1050, 1052, 1055, 1060, 1085, 1095, 1541, 1551, 9255, 2515, 3135, 3415, 4130, 4137, 4140, 4150, 4320, 4340, 4520, 5015, 5115, 5120, 5132, 5140, 5155, 6150, 8620, 9262, 9840, 52100, O1, O2, O6, S2, W1 to W310	P	28 to 38 Rc	2XDSS	●	3	88	85	82	81	79	79	75	.16-.24	.18-.27	.21-.31	.22-.35	.25-.35	.28-.38	.30-.37		
			2XDSR	●	5	88	85	82	81	79	79	75									
			2XDSCS	●	3	145	137	130	122	99	96	92									
			2XDSCR	●	5	145	137	130	122	99	96	92	.16-.24	.18-.27	.21-.31	.22-.35	.25-.35	.28-.38	.30-.37		
			2XDCL	●	7+	114	107	99	96	91	85	81									
Tool Steels & Die Steels O7, M1, M2, M3, M4, M7, T1, T2, T4, T5, T8, T15, A2, A3, A6, A7, H10, H11, H12, H13, H19, H21, L3, L6, L7, P2, P20, S1, S5, S7, 52100, A128, D2, D3, D4, D5, D7	P	28 to 44 Rc	2XDSS	●	3	56	55	55	53	53	52	49	.16-.24	.18-.27	.21-.31	.22-.35	.25-.35	.28-.38	.30-.37		
			2XDSR	●	5	56	55	55	53	53	52	49									
			2XDSCS	●	3	64	64	61	61	58	58	55									
			2XDSCR	●	5	64	64	61	61	58	58	55	.16-.24	.18-.27	.21-.31	.22-.35	.25-.35	.28-.38	.30-.37		
			2XDCL	●	7+	61	58	58	55	55	52	49									
Stainless Steel - Easy to Machine 430F, 301, 303, 410, 416 Annealed, 420F, 430	M	up to 28 Rc	2XDSS	●	3	94	91	84	76	69	61	55	.16-.24	.18-.27	.21-.31	.22-.35	.25-.36	.28-.38	.30-.37		
			2XDSR	●	5	94	91	84	76	69	61	55									
			2XDSCS	●	3	122	119	116	113	101	98	94									
			2XDSCR	●	5	122	119	116	113	101	98	94	.16-.24	.18-.27	.21-.31	.22-.35	.25-.35	.28-.38	.30-.37		
			2XDCL	●	7+	114	113	107	99	94	91	87									
Stainless Steel - Moderately Difficult 301, 302, 303 High Tensile, 304, 304L, 305, 420, 15-5PH, 17-4PH, 17-7PH	M	up to 28 Rc	2XDSS	●	3	37	35	34	32	30	29	28	.16-.24	.18-.27	.21-.31	.22-.35	.25-.36	.28-.38	.30-.37		
			2XDSR	●	5	37	35	34	32	30	29	28									
			2XDSCS	●	3	79	76	73	73	70	67	64									
			2XDSCR	●	5	79	76	73	73	70	67	64	.16-.24	.18-.27	.21-.31	.22-.35	.25-.35	.28-.38	.30-.37		
			2XDCL	●	7+	73	70	67	67	61	61	58									
Stainless Steel - Difficult to Machine 302B, 304B, 309, 310, 316, 316B, 316L, 316Ti, 317, 317L, 321, PH13-8Mo, Nitronics	M	over 28 Rc	2XDSS	●	3	34	32	32	30	30	29	27	.11-.15	.13-.23	.18-.25	.21-.27	.22-.31	.25-.33	.30-.37		
			2XDSR	●	5	34	32	32	30	30	29	27									
			2XDSCS	●	3	67	61	58	55	52	47	45									
			2XDSCR	●	5	67	61	58	55	52	47	45	.11-.15	.13-.23	.18-.25	.21-.27	.22-.31	.25-.33	.30-.37		
			2XDCL	●	7+	46	43	40	40	38	38	36									
High Temp Alloys Nimonic, Inconel, Monel, Hastelloy	S	up to 42 Rc	2XDSS	●	3	20	18	17	15	14	12	11	.08-.13	.11-.15	.12-.17	.14-.19	.16-.21	.18-.25	.17-.24		
			2XDSR	●	5	20	18	17	15	14	12	11									
			2XDSCS	●	3	26	26	24	24	23	23	22									
			2XDSCR	●	5	26	26	24	24	23	23	22	.09-.13	.11-.15	.12-.17	.14-.19	.16-.21	.18-.25	.17-.24		
			2XDCL	●	7+	27	27	26	26	23	23	22									
Titanium Alloys 6Al-4V, 5Al-2.5 Sn, 6Al-2 Sn-4Zr-6Mo, 3Al-8V-6Cr4Mo-4Zr, 10V-2Fe-3Al, 13V-11Cr-3Al	S	up to 42 Rc	2XDSS	●	3	34	32	30	30	27	27	25	.16-.24	.18-.27	.21-.31	.22-.35	.25-.36	.28-.38	.30-.37		
			2XDSR	●	5	34	32	30	30	27	27	25									
			2XDSCS	●	3	55	55	52	49	46	46	44									
			2XDSCR	●	5	55	55	52	49	46	46	44	.16-.24	.18-.27	.21-.31	.22-.35	.25-.36	.28-.38	.30-.37		
			2XDCL	●	7+	49	46	43	40	37	37	35									
Cast Iron - Gray CG, ASTM A48, CLASS 20, 25, 30, 35, SAE J431C, GRADES G1800, G3000, G3500, GG 10, 15, 20, 25, 30, 35, 40	K	up to 240 HB	2XDSS	●	3	125	122	119	113	110	107	102	.16-.24	.18-.27	.21-.31	.22-.35	.25-.36	.28-.38	.30-.37		
			2XDSR	●	5	125	122	119	113	110	107	102									
			2XDSCS	●	3	177	171	168	168	160	152	145									
			2XDSCR	●	5	177	171	168	168	160	152	145	.16-.24	.18-.27	.21-.31	.22-.35	.25-.35	.28-.38	.30-.37		
			2XDCL	●	7+	140	137	134	131	125	122	117									
Cast Iron - Ductile & Malleable CGI 60-40-18, 65-45-12, D4018, D4512, D5506, 32510, 35108, M3210, M4504, M5503, 250, 300, 350, 400, 450	K	over 240 HB	2XDSS	●	3	73	70	67	64	61	58	55	.16-.24	.18-.27	.21-.31	.22-.35	.25-.36	.28-.38	.30-.37		
			2XDSR	●	5	73	70	67	64	61	58	55									
			2XDSCS	●	3	122	114	107	91	84	76	72									
			2XDSCR	●	5	122	114	107	91	84	76	72	.16-.24	.18-.27	.21-.31	.22-.35	.25-.35	.28-.38	.30-.37		
			2XDCL	●	7+	91	82	76	73	67	61	58									

XD
TwisterXD[®]

Technical Information

Technical data provided should be considered advisory only as variations may be necessary depending on the particular application.

For product information, call your local distributor.

Series 2XDCE Technical Information

Process For Successful Deep Hole Drilling:

1. Start by producing a 1.5 x diameter to 3 x diameter pilot hole using a coolant or non-coolant pilot drill. Typically this tool will have a point angle the same as or greater than the deep hole drill. Run this drill at 100% of the final drill speed and 1/2 the normal IPM (mm/min).
2. Retract and tool change to the final deep hole (2XDCE M.A. Ford[®] Series) drill.
3. Rapid to clearance plane and enter the pilot hole at 25% (don't exceed 400 to 500 RPM (n)) of the final speed and 1 to 2 IPM (25.4 to 50.8 mm/min). This will help with true position by eliminating drill whip. Once into the hole, turn on the coolant and advance to the material start. At this point, you can add a dwell to clear any chips that have been left from the previous drill and let the spindle get to full speed. Increase the speed and feed to final drilling parameters.
4. Drill one shot to the final hole depth or through.
5. Should you experience any squeaking you may need to retract the drill and increase your feed. Chip packing is occurring and will need to be addressed.
6. Once through the material, it may be necessary to reduce the RPM (n) to eliminate breakage of the drill due to drill whip. Then retract to the clearance plane.

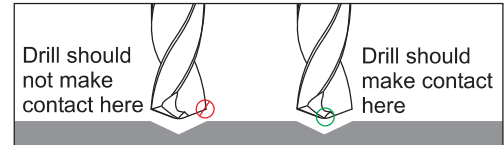

Machine Requirements

High Pressure Pump System (1,000 psi/68.9 bar)
Machine runout of .0003" (.008mm) Max.

Due to the conditions of equipment, tool holders, and conditions beyond M.A. Ford[®]'s control, your results may vary.

Should your application require more in depth discussion or a special tool, please contact M.A. Ford[®]'s Application Engineering Department at 563-391-6220 / 800-553-8024.



Recommended Cutting Data XD 2XDCE - Inch

Workpiece Material Group	ISO	Hardness	TYPE	DEPTH	vc - SFM	Drill Diameter				
						3/16	1/4	5/16	3/8	1/2
						f - IPR				
Free Machining & Low Carbon Steels 1006, 1008, 1015, 1018, 1020, 1022, 1025, 1117, 1140, 1141, 11L08, 11L14, 1213, 12L13, 12L14, 1215, 1330	P	up to 28 Rc		12-25X	345	.0030	.0040	.0080	.0090	.0100
Medium Carbon & High Carbon Steels, Alloy Steels & Easy to Machine Tool Steels 1030, 1035, 1040, 1045, 1050, 1052, 1055, 1060, 1085, 1095, 1541, 1551, 9255, 2515, 3135, 3415, 4130, 4137, 4140, 4150, 4320, 4340, 4520, 5015, 5115, 5120, 5132, 5140, 5155, 6150, 8620, 9262, 9840, 52100, O1, O2, O6, S2, W1 to W310	P	28 to 35 Rc		12-25X	265	.0030	.0040	.0080	.0090	.0100
Tool Steels & Die Steels O7, M1, M2, M3, M4, M7, T1, T2, T4, T5, T8, T15, A2, A3, A6, A7, H10, H11, H12, H13, H19, H21, L3, L6, L7, P2, P20, S1, S5, S7, 52100, A128, D2, D3, D4, D5, D7	P	28 to 35 Rc		12-25X	265	.0030	.0040	.0080	.0090	.0100
Hardened Steels	H	35-45 Rc		12-25X	115	.0006	.0009	.0020	.0024	.0030
Hardened Steels		45-55 Rc			80					
Stainless Steel - Easy to Machine 430F, 301, 303, 410, 416 Annealed, 420F, 430	M	up to 28 Rc		12-25X	300	.0030	.0040	.0080	.0090	.0100
Stainless Steel - Moderately Difficult 301, 302, 303 High Tensile, 304, 304L, 305, 420, 15-5PH, 17-4PH, 17-7PH	M	up to 28 Rc		12-25X	180	.0030	.0040	.0080	.0090	.0100
Stainless Steel - Difficult to Machine 302B, 304B, 309, 310, 316, 316B, 316L, 316Ti, 317, 317L, 321, PH13-8Mo, Nitronics	M	over 28 Rc		12-25X	130	.0020	.0030	.0060	.0080	.0100
High Temp Alloys Nimonic, Inconel, Monel, Hastelloy	S	up to 42 Rc		12-25X	65-80	.0009	.0014	.0025	.0030	.0033
Titanium Alloys 6Al-4V, 5Al-2.5 Sn, 6Al-2 Sn-4Zr-6Mo, 3Al-8V-6Cr4Mo-4Zr, 10V-2Fe-3Al, 13V-11Cr-3Al	S	up to 42 Rc		12-25X	150	.0016	.0024	.0050	.0060	.0060
Cast Iron - Gray CG, ASTM A48, CLASS 20, 25, 30, 35, SAE J431C, GRADES G1800, G3000, G3500, GG 10, 15, 20, 25, 30, 35, 40	K	up to 240 HB		12-25X	400	.0030	.0050	.0080	.0090	.0100
Cast Iron - Ductile & Malleable CGI 60-40-18, 65-45-12, D4018, D4512, D5506, 32510, 35108, M3210, M4504, M5503, 250, 300, 350, 400, 450	K	over 240 HB		12-25X	265	.0030	.0050	.0080	.0090	.0100
Non-Ferrous - Al < 14% Si	N		12-25X	500	.0043	.0070	.0110	.0138	.0149	
Non-Ferrous - Al > 14% Si	N		12-25X	350	.0043	.0070	.0110	.0138	.0149	
Non-Ferrous - Brass	N		12-25X	400	.0030	.0040	.0110	.0130	.0140	
Non-Ferrous - Cu/Cu Alloys/Magnesium	N		12-25X	300	.0030	.0040	.0110	.0130	.0140	









ISO 9001:2008 Certified

Technical data provided should be considered advisory only as variations may be necessary depending on the particular application.

For product information, call your local distributor.

Recommended Cutting Data XD 2XDCE - Metric

Workpiece Material Group	ISO	Hardness	TYPE	DEPTH	vc - m/min	Drill Diameter (mm)						
						5	6	7	8	9	10	12
						f - mm/Rev						
Free Machining & Low Carbon Steels 1006, 1008, 1015, 1018, 1020, 1022, 1025, 1117, 1140, 1141, 11L08, 11L14, 1213, 12L13, 12L14, 1215, 1330	P	up to 28 Rc		12-25X	105	.088	.106	.127	.193	.215	.238	.254
Medium Carbon & High Carbon Steels, Alloy Steels & Easy to Machine Tool Steels 1030, 1035, 1040, 1045, 1050, 1052, 1055, 1060, 1085, 1095, 1541, 1551, 9255, 2515, 3135, 3415, 4130, 4137, 4140, 4150, 4320, 4340, 4520, 5015, 5115, 5120, 5132, 5140, 5155, 6150, 8620, 9262, 9840, 52100, O1, O2, O6, S2, W1 to W310	P	28 to 35 Rc		12-25X	80	.088	.106	.127	.193	.215	.238	.254
Tool Steels & Die Steels O7, M1, M2, M3, M4, M7, T1, T2, T4, T5, T8, T15, A2, A3, A6, A7, H10, H11, H12, H13, H19, H21, L3, L6, L7, P2, P20, S1, S5, S7, 52100, A128, D2, D3, D4, D5, D7	P	28 to 35 Rc		12-25X	80	.088	.106	.127	.193	.215	.238	.254
Hardened Steels	H	35-45 Rc		12-25X	35	.020	.022	.027	.046	.053	.060	.066
Hardened Steels		45-55 Rc			25							
Stainless Steel - Easy to Machine 430F, 301, 303, 410, 416 Annealed, 420F, 430	M	up to 28 Rc		12-25X	90	.090	.105	.127	.193	.215	.238	.254
Stainless Steel - Moderately Difficult 301, 302, 303 High Tensile, 304, 304L, 305, 420, 15-5PH, 17-4PH, 17-7PH	M	up to 28 Rc		12-25X	55	.090	.105	.127	.193	.215	.238	.254
Stainless Steel - Difficult to Machine 302B, 304B, 309, 310, 316, 316B, 316L, 316Ti, 317, 317L, 321, PH13-8Mo, Nitronics	M	over 28 Rc		12-25X	40	.090	.105	.127	.193	.215	.238	.254
High Temp Alloys Nimonic, Inconel, Monel, Hastelloy	S	up to 42 Rc		12-25X	20-25	.030	.035	.048	.051	.071	.078	.085
Titanium Alloys 6Al-4V, 5Al-2.5 Sn, 6Al-2 Sn-4Zr-6Mo, 3Al-8V-6Cr4Mo-4Zr, 10V-2Fe-3Al, 13V-11Cr-3Al	S	up to 42 Rc		12-25X	45	.050	.060	.071	.098	.127	.140	.152
Cast Iron - Gray CG, ASTM A48, CLASS 20, 25, 30, 35, SAE J431C, GRADES G1800, G3000, G3500, GG 10, 15, 20, 25, 30, 35, 40	K	up to 240 HB		12-25X	120	.100	.120	.140	.200	.215	.240	.254
Cast Iron - Ductile & Malleable CGI 60-40-18, 65-45-12, D4018, D4512, D5506, 32510, 35108, M3210, M4504, M5503, 250, 300, 350, 400, 450	K	over 240 HB		12-25X	80	.100	.120	.140	.200	.215	.240	.254
Non-Ferrous - Al < 14% Si	N		12-25X	150	.140	.170	.195	.280	.314	.350	.378	
Non-Ferrous - Al > 14% Si	N			105	.140	.170	.195	.280	.314	.350	.378	
Non-Ferrous - Brass	N			120	.088	.106	.127	.279	.314	.350	.378	
Non-Ferrous - Cu/Cu Alloys/Magnesium	N			90	.088	.106	.127	.279	.314	.350	.378	

Safety Note

Always wear the appropriate personal protective equipment such as safety glasses and protective clothing when using solid carbide or HSS cutting tools. Machines should be fully guarded. Technical data provided should be considered advisory only as variations may be necessary depending on the particular application.

Twister[®] Spot Drill

Recommended Cutting Data 200S - Inch

Workpiece Material Group	I S O	Hardness	D E P T H	vc - SFM	Drill Diameter				
					1/8	1/4	3/8	1/2	5/8
					f - IPR				
Free Machining & Low Carbon Steels 1006, 1008, 1015, 1018, 1020, 1022, 1025, 1117, 1140, 1141, 11L08, 11L14, 1213, 12L13, 12L14, 1215, 1330	P	up to 28 Rc	3	330	.0015	.0030	.0040	.0050	.0060
Medium Carbon & High Carbon Steels, Alloy Steels & Easy to Machine Tool Steels 1030, 1035, 1040, 1045, 1050, 1052, 1055, 1060, 1085, 1095, 1541, 1551, 9255, 2515, 3135, 3415, 4130, 4137, 4140, 4150, 4320, 4340, 4520, 5015, 5115, 5120, 5132, 5140, 5155, 6150, 8620, 9262, 9840, 52100, O1, O2, O6, S2, W1 to W310	P	28 to 38 Rc	3	265	.0015	.0030	.0040	.0050	.0060
Tool Steels & Die Steels O7, M1, M2, M3, M4, M7, T1, T2, T4, T5, T8, T15, A2, A3, A6, A7, H10, H11, H12, H13, H19, H21, L3, L6, L7, P2, P20, S1, S5, S7, 52100, A128, D2, D3, D4, D5, D7	P	28 to 44 Rc	3	230	.0015	.0030	.0040	.0050	.0060
Hardened Steel	H	45 to 65 Rc	3	50	.0005	.0005	.0010	.0010	.0010
Stainless Steel - Moderately Difficult 301, 302, 303 High Tensile, 304, 304L, 305, 420, 15-5PH, 17-4PH, 17-7PH	M	up to 28 Rc	3	150	.0015	.0030	.0040	.0050	.0060
Stainless Steel - Difficult to Machine 302B, 304B, 309, 310, 316, 316B, 316L, 316Ti, 317, 317L, 321, PH13-8Mo, Nitronics	M	up to 28 Rc	3	100	.0010	.0020	.0025	.0030	.0040
High Temp Alloys Nimonic, Inconel, Monel, Hastelloy	S	up to 42 Rc	3	70	.0010	.0020	.0025	.0030	.0040
Titanium Alloys 6Al-4V, 5Al-2.5 Sn, 6Al-2 Sn-4Zr-6Mo, 3Al-8V-6Cr4Mo-4Zr, 10V-2Fe-3Al, 13V-11Cr-3Al	S		3	180	.0010	.0020	.0025	.0030	.0040
Cast Iron - Gray CG, ASTM A48, CLASS 20, 25, 30, 35, SAE J431C, GRADES G1800, G3000, G3500, GG 10, 15, 20, 25, 30, 35, 40	K	up to 240 HB	3	365	.0015	.0030	.0040	.0050	.0060
Cast Iron - Ductile & Malleable CGI 60-40-18, 65-45-12, D4018, D4512, D5506, 32510, 35108, M3210, M4504, M5503, 250, 300, 350, 400, 450	K	over 240 HB	3	265	.0015	.0030	.0040	.0050	.0060
Plastics Kevlar/Graphite	N		3	300	.0015	.0030	.0040	.0050	.0060

2XDCE / 200S
TwisterXD[®]

Technical Information

Recommended Cutting Data 200S - Metric

Workpiece Material Group	I S O	Hardness	D E P T H	vc - m/ min	Drill Diameter (mm)					
					3	6	8	10	12	16
					f - mm/Rev					
Free Machining & Low Carbon Steels 1006, 1008, 1015, 1018, 1020, 1022, 1025, 1117, 1140, 1141, 11L08, 11L14, 1213, 12L13, 12L14, 1215, 1330	P	up to 28 Rc	3	100	.0380	.0760	.1020	.1270	.1520	.1520
Medium Carbon & High Carbon Steels, Alloy Steels & Easy to Machine Tool Steels 1030, 1035, 1040, 1045, 1050, 1052, 1055, 1060, 1085, 1095, 1541, 1551, 9255, 2515, 3135, 3415, 4130, 4137, 4140, 4150, 4320, 4340, 4520, 5015, 5115, 5120, 5132, 5140, 5155, 6150, 8620, 9262, 9840, 52100, O1, O2, O6, S2, W1 to W310	P	28 to 38 Rc	3	80	.0380	.0760	.1020	.1270	.1520	.1520
Tool Steels & Die Steels O7, M1, M2, M3, M4, M7, T1, T2, T4, T5, T8, T15, A2, A3, A6, A7, H10, H11, H12, H13, H19, H21, L3, L6, L7, P2, P20, S1, S5, S7, 52100, A128, D2, D3, D4, D5, D7	P	28 to 44 Rc	3	45	.0380	.0760	.1020	.1270	.1520	.1520
Hardened Steel	H	45 to 65 Rc	3	15	.0127	.0127	.0254	.0254	.0254	.0381
Stainless Steel - Moderately Difficult 301, 302, 303 High Tensile, 304, 304L, 305, 420, 15-5PH, 17-4PH, 17-7PH	M	up to 28 Rc	3	45	.0380	.0760	.1020	.1270	.1520	.1520
Stainless Steel - Difficult to Machine 302B, 304B, 309, 310, 316, 316B, 316L, 316Ti, 317, 317L, 321, PH13-8Mo, Nitronics	M	up to 28 Rc	3	30	.0250	.0510	.0640	.0760	.1020	.1270
High Temp Alloys Nimonic, Inconel, Monel, Hastelloy	S	up to 42 Rc	3	20	.0250	.0510	.0640	.0760	.1020	.1270
Titanium Alloys 6Al-4V, 5Al-2.5 Sn, 6Al-2 Sn-4Zr-6Mo, 3Al-8V-6Cr4Mo-4Zr, 10V-2Fe-3Al, 13V-11Cr-3Al	S		3	55	.0250	.0510	.0640	.0760	.1020	.1270
Cast Iron - Gray CG, ASTM A48, CLASS 20, 25, 30, 35, SAE J431C, GRADES G1800, G3000, G3500, GG 10, 15, 20, 25, 30, 35, 40	K	up to 240 HB	3	110	.0380	.0760	.1020	.1270	.1520	.1520
Cast Iron - Ductile & Malleable CGI 60-40-18, 65-45-12, D4018, D4512, D5506, 32510, 35108, M3210, M4504, M5503, 250, 300, 350, 400, 450	K	over 240 HB	3	80	.0380	.0760	.1020	.1270	.1520	.1520
Plastics Kevlar/Graphite	N		3	90	.0380	.0760	.1020	.1270	.1520	.1520

Technical data provided should be considered advisory only as variations may be necessary depending on the particular application.

For product information, call your local distributor.

Twister® HPD Series 5xD

Series HPDSR - HPDCR Recommended Cutting Data - Inch

Recommended Speeds By Material Group			Vc (SFM)	
Material Groups	Material Type		HPDSR	HPDCR
			5 X D Solid	5 X D Through Coolant
Steels	P	Low Carbon	490 - 525 - 560	590 - 625 - 655
		Alloy Steel (≤ 35 Rc)	360 - 395 - 425	425 - 460 - 490
		Alloy Steel (36-45 Rc)	330 - 360 - 395	360 - 395 - 425
		Mold/Tool Steel	200 - 230 - 260	230 - 260 - 295
Stainless Steels	M	Austenitic	130 - 165 - 200	165 - 200 - 230
		Martensitic	100 - 130 - 165	130 - 165 - 200
Cast Irons	K	Gray Cast Iron	590 - 625 - 655	625 - 655 - 690
		Ductile Cast Iron	460 - 490 - 525	490 - 525 - 560

RPM Formula For Inch Drills Only - $RPM = SFM \times 3.82 \div \text{Drill } \varnothing D'$

Recommended Feedrates By Material Group			Drill Diameter (inch)							
Material Groups	Material Type		1/8	5/32	3/16	1/4	5/16	3/8	1/2	5/8
			Feed (in/rev)							
Steels	P	Low Carbon	0.0057	0.0071	0.0071	0.0089	0.0112	0.0143	0.0143	0.0178
		Alloy Steel (≤ 35 Rc)								
		Alloy Steel (36-45 Rc)								
		Mold/Tool Steel								
Stainless Steels	M	Austenitic	0.0028	0.0035	0.0035	0.0043	0.0055	0.0071	0.0071	0.0089
		Martensitic								
Cast Irons	K	Gray Cast Iron	0.0061	0.0076	0.0085	0.0120	0.0120	0.0152	0.0171	0.0209
		Ductile Cast Iron								

Feedrate Formula For Inch Drills - $\text{Feed} = RPM \times \text{in/rev}$

Series HPDSR - HPDCR Recommended Cutting Data - Metric

Recommended Speeds By Material Group			Vc (m/min)	
Material Groups	Material Type		HPDSR	HPDCR
			5 X D Solid	5 X D Through Coolant
Steels	P	Low Carbon	150 - 160 - 170	180 - 190 - 200
		Alloy Steel (≤ 35 Rc)	110 - 120 - 130	130 - 140 - 150
		Alloy Steel (36-45 Rc)	100 - 110 - 120	110 - 120 - 130
		Mold/Tool Steel	60 - 70 - 80	70 - 80 - 90
Stainless Steels	M	Austenitic	40 - 50 - 60	50 - 60 - 70
		Martensitic	30 - 40 - 50	40 - 50 - 60
Cast Irons	K	Gray Cast Iron	180 - 190 - 200	190 - 200 - 210
		Ductile Cast Iron	140 - 150 - 160	150 - 160 - 170

RPM Formula For Metric Drills Only - $RPM = (Vc \times 318.0) \div \text{Drill } \varnothing D'$

Recommended Feedrates By Material Group			Drill Diameter (mm)							
Material Groups	Material Type		3.0	4.0	5.0	6.0	8.0	10.0	12.0	16.0
			Feed (mm/rev)							
Steels	P	Low Carbon	0.145	0.181	0.181	0.226	0.285	0.362	0.362	0.453
		Alloy Steel (≤ 35 Rc)								
		Alloy Steel (36-45 Rc)								
		Mold/Tool Steel								
Stainless Steels	M	Austenitic	0.070	0.090	0.090	0.110	0.140	0.180	0.180	0.225
		Martensitic								
Cast Irons	K	Gray Cast Iron	0.155	0.193	0.217	0.305	0.305	0.386	0.435	0.532
		Ductile Cast Iron								

Feedrate Formula For Metric Drills - $\text{Feed} = RPM \times \text{mm/rev}$

Technical data provided should be considered advisory only as variations may be necessary depending on the particular application.

Recommended Cutting Data 2MDCL - Inch

Workpiece Material Group	I S O	Hardness	T Y P E	D E P T H	Drill Diameter			Drill Diameter		
					0.787	0.984	0.1142	0.0787	0.0984	0.1142
					vc - SFM			f - IPR		
Free Machining & Low Carbon Steels 1006, 1008, 1015, 1018, 1020, 1022, 1025, 1117, 1140, 1141, 11L08, 11L14, 1213, 12L13, 12L14, 1215, 1330	P	up to 28 Rc		10X	300	300	250	.0018	.0020	.0022
Medium Carbon & High Carbon Steels, Alloy Steels & Easy to Machine Tool Steels 1030, 1035, 1040, 1045, 1050, 1052, 1055, 1060, 1085, 1095, 1541, 1551, 9255, 2515, 3135, 3415, 4130, 4137, 4140, 4150, 4320, 4340, 4520, 5015, 5115, 5120, 5132, 5140, 5155, 6150, 8620, 9262, 9840, 52100, O1, O2, O6, S2, W1 to W310	P	28 to 38 Rc		10X	300	300	250	.0018	.0020	.0022
Tool Steels & Die Steels O7, M1, M2, M3, M4, M7, T1, T2, T4, T5, T8, T15, A2, A3, A6, A7, H10, H11, H12, H13, H19, H21, L3, L6, L7, P2, P20, S1, S5, S7, 52100, A128, D2, D3, D4, D5, D7	P	28 to 44 Rc		10X	250	250	200	.0018	.0020	.0022
Stainless Steel - Easy to Machine 430F, 301, 303, 410, 416 Annealed, 420F, 430	M	up to 28 Rc		10X	300	300	250	.0018	.0020	.0022
Stainless Steel - Moderately Difficult 301, 302, 303 High Tensile, 304, 304L, 305, 420, 15-5PH, 17-4PH, 17-7PH	M	up to 28 Rc		10X	230	230	200	.0018	.0020	.0022
Stainless Steel - Difficult to Machine 302B, 304B, 309, 310, 316, 316B, 316L, 316Ti, 317, 317L, 321, PH13-8Mo, Nitronics	M	over 28 Rc		10X	60	60	50	.0009	.0011	.0015
High Temp Alloys Nimonic, Inconel, Monel, Hastelloy	S	up to 42 Rc		10X	50	50	40	.0009	.0011	.0014
Titanium Alloys 6Al-4V, 5Al-2.5 Sn, 6Al-2 Sn-4Zr-6Mo, 3Al-8V-6Cr4Mo-4Zr, 10V-2Fe-3Al, 13V-11Cr-3Al	S	up to 42 Rc		10X	175	175	150	.0009	.0011	.0014
Cast Iron - Gray CG, ASTM A48, CLASS 20, 25, 30, 35, SAE J431C, GRADES G1800, G3000, G3500, GG 10, 15, 20, 25, 30, 35, 40	K	up to 240 HB		10X	325	325	300	.0018	.0020	.0022
Cast Iron - Ductile & Malleable CGI 60-40-18, 65-45-12, D4018, D4512, D5506, 32510, 35108, M3210, M4504, M5503, 250, 300, 350, 400, 450	K	over 240 HB		10X	250	250	200	.0018	.0020	.0022

M.A. Ford® recommends full retraction of the body of the drill from the hole during the peck cycle. It is recommended to leave the drill point within the hole.

For hole depths deeper than 4x the diameter, M.A. Ford® recommends using a "soft start" program that drills to .5x diameter deep at 2/3 of the speed and feed.

Machine Requirements

High Pressure Pump System (1,000 psi/68.9 bar)
Coolant filtration of 10 microns or better
Machine runout of .0004" (.01mm) Max.

Estimated Peck Depths

For hole depths up to 6X diameter No Pecks
For hole depths up to 10X diameter 0-2 Pecks
For hole depths up to 15X diameter 2-4 Pecks

Recommended Cutting Data 2MDCL - Metric

Workpiece Material Group	I S O	Hardness	T Y P E	D E P T H	Drill Diameter (mm)			Drill Diameter (mm)		
					2.0	2.5	2.9	2.0	2.5	2.9
					vc - m/min			f - mm/Rev		
Free Machining & Low Carbon Steels 1006, 1008, 1015, 1018, 1020, 1022, 1025, 1117, 1140, 1141, 11L08, 11L14, 1213, 12L13, 12L14, 1215, 1330	P	up to 28 Rc		10X	90	90	75	.046	.051	.056
Medium Carbon & High Carbon Steels, Alloy Steels & Easy to Machine Tool Steels 1030, 1035, 1040, 1045, 1050, 1052, 1055, 1060, 1085, 1095, 1541, 1551, 9255, 2515, 3135, 3415, 4130, 4137, 4140, 4150, 4320, 4340, 4520, 5015, 5115, 5120, 5132, 5140, 5155, 6150, 8620, 9262, 9840, 52100, O1, O2, O6, S2, W1 to W310	P	28 to 38 Rc		10X	90	90	75	.046	.051	.056
Tool Steels & Die Steels O7, M1, M2, M3, M4, M7, T1, T2, T4, T5, T8, T15, A2, A3, A6, A7, H10, H11, H12, H13, H19, H21, L3, L6, L7, P2, P20, S1, S5, S7, 52100, A128, D2, D3, D4, D5, D7	P	28 to 44 Rc		10X	60	60	53	.046	.051	.056
Stainless Steel - Easy to Machine 430F, 301, 303, 410, 416 Annealed, 420F, 430	M	up to 28 Rc		10X	90	90	75	.046	.051	.056
Stainless Steel - Moderately Difficult 301, 302, 303 High Tensile, 304, 304L, 305, 420, 15-5PH, 17-4PH, 17-7PH	M	up to 28 Rc		10X	75	75	60	.033	.038	.043
Stainless Steel - Difficult to Machine 302B, 304B, 309, 310, 316, 316B, 316L, 316Ti, 317, 317L, 321, PH13-8Mo, Nitronics	M	over 28 Rc		10X	18	18	15	.025	.027	.038
High Temp Alloys Nimonic, Inconel, Monel, Hastelloy	S	up to 42 Rc		10X	15	15	12	.025	.027	.036
Titanium Alloys 6Al-4V, 5Al-2.5 Sn, 6Al-2 Sn-4Zr-6Mo, 3Al-8V-6Cr-4Mo-4Zr, 10V-2Fe-3Al, 13V-11Cr-3Al	S	up to 42 Rc		10X	55	55	45	.025	.027	.036
Cast Iron - Gray CG, ASTM A48, CLASS 20, 25, 30, 35, SAE J431C, GRADES G1800, G3000, G3500, GG 10, 15, 20, 25, 30, 35, 40	K	up to 240 HB		10X	100	100	90	.046	.051	.065
Cast Iron - Ductile & Malleable CGI 60-40-18, 65-45-12, D4018, D4512, D5506, 32510, 35108, M3210, M4504, M5503, 250, 300, 350, 400, 450	K	over 240 HB		10X	75	75	60	.046	.051	.056

M.A. Ford[®] recommends full retraction of the body of the drill from the hole during the peck cycle. It is recommended to leave the drill point within the hole.

For hole depths deeper than 4x the diameter, M.A. Ford[®] recommends using a "soft start" program that drills to .5x diameter deep at 2/3 of the speed and feed.

Machine Requirements

High Pressure Pump System (1,000 psi/68.9 bar)
Coolant filtration of 10 microns or better
Machine runout of .0004" (.01mm) Max.

Estimated Peck Depths

For hole depths up to 6X diameter No Pecks
For hole depths up to 10X diameter 0-2 Pecks
For hole depths up to 15X diameter 2-4 Pecks

Technical data provided should be considered advisory only as variations may be necessary depending on the particular application.

Twister® HP

Recommended Cutting Data 207CE - Inch

Workpiece Material Group	I S O	Tool Series	T Y P E	D E P T H	Speed - (SFM) Surface Feed Per minute	Drill Diameter			
						1/8	1/4	3/8	1/2
						Feed - (IPR) Inch per Rev			
Plastics	N	207CE	●	3	330	.002	.004	.005	.006
Kevlar/Graphite	N			3	420	.002	.004	.005	.006

Recommended Cutting Data 207CE - Metric

Workpiece Material Group	I S O	Tool Series	T Y P E	D E P T H	Speed Vc- (m/min) Meters Per minute	Drill Diameter			
						3.0	6.0	10.0	12.0
						Feed - (mm/rev) millimeters per Rev			
Plastics	N	207CE	●	3	100	.05	.10	.13	.15
Kevlar/Graphite	N			3	125	.05	.10	.13	.15

Twister® AL

Recommended Cutting Data 229 - Inch

Workpiece Material Group	I S O	T Y P E	D E P T H	vc - SFM	Drill Diameter				
					3/64	3/16	1/4	1/2	3/4
					f - IPR				
Non-Ferrous - Al < 14% Si	N	●	5	700	.003	.007	.012	.017	.024
Non-Ferrous - Al > 14% Si	N		5	500	.002	.003	.006	.009	.012
Non-Ferrous - Brass	N		5	400	.002	.003	.006	.009	.012
Non-Ferrous - Cu/Cu Alloys/Magnesium	N		5	300	.002	.003	.006	.009	.012

Recommended Cutting Data 229 - Metric

Workpiece Material Group	I S O	T Y P E	D E P T H	vc - m/min	Drill Diameter (mm)				
					1.5	3	6	12	20
					f - mm/Rev				
Non-Ferrous - Al < 14% Si	N	●	5	215	.080	.200	.310	.450	.610
Non-Ferrous - Al > 14% Si	N		5	155	.050	.080	.150	.250	.310
Non-Ferrous - Brass	N		5	120	.050	.080	.150	.250	.310
Non-Ferrous - Cu/Cu Alloys/Magnesium	N		5	90	.050	.080	.150	.250	.310

Recommended Cutting Data 305 Micro-Tuff® - Inch

Workpiece Material Group	ISO	Hardness	Tool Series	TYPE	vc - SFM	Drill Diameter				
						1/64	1/32	1/16	3/32	1/8
						f - IPR				
Free Machining & Low Carbon Steels 1006, 1008, 1015, 1018, 1020, 1022, 1025, 1117, 1140, 1141, 11L08, 11L14, 1213, 12L13, 12L14, 1215, 1330	P	up to 28 Rc	305	●	110	.0004	.0008	.0015	.0023	.0030
			305AM		150					
Medium Carbon & High Carbon Steels, Alloy Steels & Easy to Machine Tool Steels 1030, 1035, 1040, 1045, 1050, 1052, 1055, 1060, 1085, 1095, 1541, 1551, 9255, 2515, 3135, 3415, 4130, 4137, 4140, 4150, 4320, 4340, 4520, 5015, 5115, 5120, 5132, 5140, 5155, 6150, 8620, 9262, 9840, 52100, O1, O2, O6, S2, W1 to W310	P	28 to 38 Rc	305		90					
			305AM		130					
Tool Steels & Die Steels O7, M1, M2, M3, M4, M7, T1, T2, T4, T5, T8, T15, A2, A3, A6, A7, H10, H11, H12, H13, H19, H21, L3, L6, L7, P2, P20, S1, S5, S7, 52100, A128, D2, D3, D4, D5, D7	P	28 to 44 Rc	305		85					
			305AM		120					
Hardened Steels A2 / 52100	H	55 Rc	305	35	.0002	.0004	.0007	.0011	.0014	
			305AM	50						
Free Machining Stainless	M	up to 28 Rc	305	110	.0004	.0008	.0015	.0023	.0030	
			305AM	140						
Stainless Steel - Austenitic 304 / 316	M	up to 28 Rc	305	90	.0004	.0008	.0015	.0023	.0030	
			305AM	125						
Stainless Steel - Ferritic / Martensitic	M	up to 28 Rc	305	80	.0004	.0008	.0015	.0023	.0030	
			305AM	110						
Stainless Steel - Moderately Difficult 301, 302, 303 High Tensile, 304, 304L, 305, 420, 15-5PH, 17-4PH, 17-7PH	M	over 28 Rc	305	45	.0004	.0008	.0015	.0023	.0030	
			305AM	60						
Aluminum (<10% Si)	N		305	175	.0005	.0010	.0020	.0030	.0040	
			305AM							
Plastics	N		305	175	.0005	.0010	.0020	.0030	.0040	
			305AM							
Cast Iron - Gray CG, ASTM A48, CLASS 20, 25, 30, 35, SAE J431C, GRADES G1800, G3000, G3500, GG 10, 15, 20, 25, 30, 35, 40	K	up to 240 HB	305	110	.0004	.0008	.0015	.0023	.0030	
			305AM	150						
Cast Iron - Ductile & Malleable CGI 60-40-18, 65-45-12, D4018, D4512, D5506, 32510, 35108, M3210, M4504, M5503, 250, 300, 350, 400, 450	K	over 240 HB	305	110	.0004	.0008	.0015	.0023	.0030	
			305AM	150						
Titanium 6Al-4V	S	up to 40 Rc	305	50	.0004	.0008	.0015	.0023	.0030	
			305AM	70						
High Temp Alloys Inconel / Hastelloy / Waspeloy / Nickel Based Alloys-Monel	S	up to 40 Rc	305	45	.0002	.0004	.0007	.0011	.0014	
			305AM	60						

Recommended Peck Depths by Diameter*

Diameter	Peck Depth
1/64	.2 x Diameter
1/32	.3 x Diameter
1/16	.6 x Diameter
5/64	.8 x Diameter
3/32	1.0 x Diameter
1/8	1.2 x Diameter

*Peck depths can vary by material type.

Technical data provided should be considered advisory only as variations may be necessary depending on the particular application.

Recommended Cutting Data 305 Micro-Tuff® - Metric

Workpiece Material Group	I S O	Hardness	Tool Series	T Y P E	vc - m/min	Drill Diameter (mm)										
						0.5	1	2	2.5	3						
						f - mm/Rev										
Free Machining & Low Carbon Steels 1006, 1008, 1015, 1018, 1020, 1022, 1025, 1117, 1140, 1141, 11L08, 11L14, 1213, 12L13, 12L14, 1215, 1330	P	up to 28 Rc	305	●	35	.010	.020	.040	.060	.075						
			305AM		45											
Medium Carbon & High Carbon Steels, Alloy Steels & Easy to Machine Tool Steels 1030, 1035, 1040, 1045, 1050, 1052, 1055, 1060, 1085, 1095, 1541, 1551, 9255, 2515, 3135, 3415, 4130, 4137, 4140, 4150, 4320, 4340, 4520, 5015, 5115, 5120, 5132, 5140, 5155, 6150, 8620, 9262, 9840, 52100, O1, O2, O6, S2, W1 to W310	P	28 to 38 Rc	305		25											
			305AM		40											
Tool Steels & Die Steels O7, M1, M2, M3, M4, M7, T1, T2, T4, T5, T8, T15, A2, A3, A6, A7, H10, H11, H12, H13, H19, H21, L3, L6, L7, P2, P20, S1, S5, S7, 52100, A128, D2, D3, D4, D5, D7	P	28 to 44 Rc	305		25											
			305AM		40											
Hardened Steels A2 / 52100	H	55 Rc	305	●	10	.005	.010	.020	.025	.035						
			305AM	15												
Free Machining Stainless	M	up to 28 Rc	305	●	35	.010	.020	.040	.060	.075						
			305AM		45											
Stainless Steel - Austenitic 304 / 316	M	up to 28 Rc	305		25											
			305AM		40											
Stainless Steel - Ferritic / Martensitic	M	up to 28 Rc	305		25											
			305AM		35											
Stainless Steel - Moderately Difficult 301, 302, 303 High Tensile, 304, 304L, 305, 420, 15-5PH, 17-4PH, 17-7PH	M	over 28 Rc	305	15												
			305AM	20												
Aluminum (<10% Si)	N		305	●	55	.015	.025	.050	.075	.100						
			305AM		55											
Plastics	N		305		55											
			305AM		55											
Cast Iron - Gray CG, ASTM A48, CLASS 20, 25, 30, 35, SAE J431C, GRADES G1800, G3000, G3500, GG 10, 15, 20, 25, 30, 35, 40	K	up to 240 HB	305		●						35	.010	.020	.040	.060	.075
			305AM								45					
Cast Iron - Ductile & Malleable CGI 60-40-18, 65-45-12, D4018, D4512, D5506, 32510, 35108, M3210, M4504, M5503, 250, 300, 350, 400, 450	K	over 240 HB	305	35												
			305AM	45												
Titanium 6Al-4V	S	up to 40 Rc	305	●		15	.010	.020	.040	.060	.075					
			305AM			20										
High Temp Alloys Inconel / Hastelloy / Waspeloy / Nickel Based Alloys-Monel	S		305		15											
			305AM		20											

Recommended Peck Depths by Diameter*

Diameter	Peck Depth
0.5 mm	.2 x Diameter
1.0 mm	.4 x Diameter
1.5 mm	.6 x Diameter
2.0 mm	.8 x Diameter
2.5 mm	1.0 x Diameter
3.0 mm	1.2 x Diameter

*Peck depths can vary by material type.

Technical data provided should be considered advisory only as variations may be necessary depending on the particular application.

For product information, call your local distributor.

Twister® GP Hi-Roc®

Recommended Cutting Data 200 / 200S - Inch

Workpiece Material Group	I S O	Hardness	Tool Series	T Y P E	D E P T H	vc - SFM	Drill Diameter							
							1/32	1/16	1/8	1/4	3/8	1/2	5/8	3/4
							f - IPR							
Free Machining & Low Carbon Steels 1006, 1008, 1015, 1018, 1020, 1022, 1025, 1117, 1140, 1141, 11L08, 11L14, 1213, 12L13, 12L14, 1215, 1330	P	up to 28 Rc	200	●	3	330	.0010	.0020	.0030	.0060	.0080	.0100	.0110	.0120
			200S		3		.0005	.0010	.0015	.0030	.0040	.0050	.0060	.0060
			200A		3		.0010	.0020	.0030	.0060	.0080	.0100	.0110	.0120
Medium Carbon & High Carbon Steels, Alloy Steels & Easy to Machine Tool Steels 1030, 1035, 1040, 1045, 1050, 1052, 1055, 1060, 1085, 1095, 1541, 1551, 9255, 2515, 3135, 3415, 4130, 4137, 4140, 4150, 4320, 4340, 4520, 5015, 5115, 5120, 5132, 5140, 5155, 6150, 8620, 9262, 9840, 52100, O1, O2, O6, S2, W1 to W310	P	28 to 38 Rc	200	●	3	265	.0010	.0020	.0030	.0060	.0080	.0100	.0110	.0120
			200S		3		.0005	.0010	.0015	.0030	.0040	.0050	.0060	.0060
			200A		3		.0010	.0020	.0030	.0060	.0080	.0100	.0110	.0120
Tool Steels & Die Steels O7, M1, M2, M3, M4, M7, T1, T2, T4, T5, T8, T15, A2, A3, A6, A7, H10, H11, H12, H13, H19, H21, L3, L6, L7, P2, P20, S1, S5, S7, 52100, A 128, D2, D3, D4, D5, D7	P	28 to 44 Rc	200	●	3	230	.0010	.0020	.0030	.0060	.0080	.0100	.0110	.0120
			200S		3		.0005	.0010	.0015	.0030	.0040	.0050	.0060	.0060
			200A		3		.0010	.0020	.0030	.0060	.0080	.0100	.0110	.0120
Hardened Steel	H	45 to 65 Rc	200	●	3	50	.0003	.0010	.0010	.0010	.0020	.0020	.0020	.0030
			200S		3		.0002	.0005	.0005	.0005	.0010	.0010	.0010	.0015
			200A		3		.0003	.0010	.0010	.0010	.0020	.0020	.0020	.0030
Stainless Steel - Moderately Difficult 301, 302, 303 High Tensile, 304, 304L, 305, 420, 15-5PH, 17-4PH, 17-7PH	M	up to 28 Rc	200	●	3	150	.0010	.0020	.0030	.0060	.0080	.0100	.0110	.0120
			200S		3		.0005	.0010	.0015	.0030	.0040	.0050	.0060	.0060
			200A		3		.0010	.0020	.0030	.0060	.0080	.0100	.0110	.0120
Stainless Steel - Difficult to Machine 302B, 304B, 309, 310, 316, 316B, 316L, 316Ti, 317, 317L, 321, PH13-8Mo, Nitronics	M	up to 28 Rc	200	●	3	100	.0003	.0005	.0020	.0040	.0050	.0060	.0080	.0100
			200S		3		.0002	.0003	.0010	.0020	.0025	.0030	.0040	.0050
			200A		3		.0003	.0005	.0020	.0040	.0050	.0060	.0080	.0100
High Temp Alloys Nimonic, Inconel, Monel, Hastelloy	S	up to 42 Rc	200	●	3	70	.0003	.0005	.0020	.0040	.0050	.0060	.0080	.0100
			200S		3		.0002	.0003	.0010	.0020	.0025	.0030	.0040	.0050
			200A		3		.0003	.0005	.0020	.0040	.0050	.0060	.0080	.0100
Titanium Alloys 6Al-4V, 5Al-2.5 Sn, 6Al-2 Sn-4Zr-6Mo, 3Al-8V-6Cr4Mo-4Zr, 10V-2Fe-3Al, 13V-11Cr-3Al	S	up to 42 Rc	200	●	3	180	.0003	.0005	.0020	.0040	.0050	.0060	.0080	.0100
			200S		3		.0002	.0003	.0010	.0020	.0025	.0030	.0040	.0050
			200A		3		.0003	.0005	.0020	.0040	.0050	.0060	.0080	.0100
Cas-Iron - Gray CG, ASTM A48, CLASS 20, 25, 30, 35, SAE J431C, GRADES G1800, G3000, G3500, GG 10, 15, 20, 25, 30, 35, 40	K	up to 240 HB	200	●	3	365	.0010	.0020	.0030	.0060	.0080	.0100	.0110	.0120
			200S		3		.0005	.0010	.0015	.0030	.0040	.0050	.0060	.0060
			200A		3		.0010	.0020	.0030	.0060	.0080	.0100	.0110	.0120
Cast Iron - Ductile & Malleable CGI 60-40-18, 65-45-12, D4018, D4512, D5506, 32510, 35108, M3210, M4504, M5503, 250, 300, 350, 400, 450	K	over 240 HB	200	●	3	265	.0010	.0020	.0030	.0060	.0080	.0100	.0110	.0120
			200S		3		.0005	.0010	.0015	.0030	.0040	.0050	.0060	.0060
			200A		3		.0010	.0020	.0030	.0060	.0080	.0100	.0110	.0120
Plastics	N		200	●	3	300	.0010	.0020	.0030	.0060	.0080	.0100	.0110	.0120
			200S		3		.0005	.0010	.0015	.0030	.0040	.0050	.0060	.0060
			200A		3		.0010	.0020	.0030	.0060	.0080	.0100	.0110	.0120
Kevlar/Graphite	N		200	●	3	300	.0010	.0020	.0030	.0060	.0080	.0100	.0110	.0120
			200S		3		.0005	.0010	.0015	.0030	.0040	.0050	.0060	.0060
			200A		3		.0010	.0020	.0030	.0060	.0080	.0100	.0110	.0120

Technical data provided should be considered advisory only as variations may be necessary depending on the particular application.

Twister® GP Hi-Roc®

Recommended Cutting Data 200 / 200S - Metric

Workpiece Material Group	ISO	Hardness	Tool Series	TYPE	DEPTH	vc - m/min	Drill Diameter (mm)								
							1	1.5	3	6	8	10	12	16	20
							f - mm/Rev								
Free Machining & Low Carbon Steels 1006, 1008, 1015, 1018, 1020, 1022, 1025, 1117, 1140, 1141, 11L08, 11L14, 1213, 12L13, 12L14, 1215, 1330	P	up to 28 Rc	200	●	3	100	.0250	.0510	.0760	.1520	.2030	.2540	.2790	.3000	.3300
			200S		3		.0130	.0250	.0380	.0760	.1020	.1270	.1520	.1520	.1600
			200A		3		.0250	.0510	.0760	.1520	.2030	.2540	.2790	.3000	.3300
Medium Carbon & High Carbon Steels, Alloy Steels & Easy to Machine Tool Steels 1030, 1035, 1040, 1045, 1050, 1052, 1055, 1060, 1085, 1095, 1541, 1551, 9255, 2515, 3135, 3415, 4130, 4137, 4140, 4150, 4320, 4340, 4520, 5015, 5115, 5120, 5132, 5140, 5155, 6150, 8620, 9262, 9840, 52100, O1, O2, O6, S2, W1 to W310	P	28 to 38 Rc	200	●	3	80	.0250	.0510	.0760	.1520	.2030	.2540	.2790	.3000	.3300
			200S		3		.0130	.0250	.0380	.0760	.1020	.1270	.1520	.1520	.1600
			200A		3		.0250	.0510	.0760	.1520	.2030	.2540	.2790	.3000	.3300
Tool Steels & Die Steels O7, M1, M2, M3, M4, M7, T1, T2, T4, T5, T8, T15, A2, A3, A6, A7, H10, H11, H12, H13, H19, H21, L3, L6, L7, P2, P20, S1, S5, S7, 52100, A 128, D2, D3, D4, D5, D7	P	28 to 44 Rc	200	●	3	45	.0250	.0510	.0760	.1520	.2030	.2540	.2790	.3000	.3300
			200S		3		.0130	.0250	.0380	.0760	.1020	.1270	.1520	.1520	.1600
			200A		3		.0250	.0510	.0760	.1520	.2030	.2540	.2790	.3000	.3300
Hardened Steel	H	45 to 65 Rc	200	●	3	15	.0063	.0254	.0254	.0254	.0508	.0508	.0508	.0762	.0800
			200S		3		.0038	.0127	.0127	.0127	.0254	.0254	.0254	.0381	.0400
			200A		3		.0063	.0254	.0254	.0254	.0508	.0508	.0508	.0760	.0800
Stainless Steel - Moderately Difficult 301, 302, 303 High Tensile, 304, 304L, 305, 420, 15-5PH, 17-4PH, 17-7PH	M	up to 28 Rc	200	●	3	45	.0250	.0510	.0760	.1520	.2030	.2540	.2790	.3000	.3300
			200S		3		.0130	.0250	.0380	.0760	.1020	.1270	.1520	.1520	.1600
			200A		3		.0250	.0510	.0760	.1520	.2030	.2540	.2790	.3000	.3300
Stainless Steel - Difficult to Machine 302B, 304B, 309, 310, 316, 316B, 316L, 316Ti, 317, 317L, 321, PH13-8Mo, Nitronics	M	up to 28 Rc	200	●	3	30	.0060	.0130	.0510	.1020	.1270	.1520	.2030	.2500	.2700
			200S		3		.0040	.0060	.0250	.0510	.0640	.0760	.1020	.1270	.1400
			200A		3		.0060	.0130	.0510	.1020	.1270	.1520	.2030	.2500	.2700
High Temp Alloys Nimonic, Inconel, Monel, Hastelloy	S	up to 42 Rc	200	●	3	20	.0060	.0130	.0510	.1020	.1270	.1520	.2030	.2500	.2700
			200S		3		.0040	.0060	.0250	.0510	.0640	.0760	.1020	.1270	.1400
			200A		3		.0060	.0130	.0510	.1020	.1270	.1520	.2030	.2500	.2700
Titanium Alloys 6Al-4V, 5Al-2.5 Sn, 6Al-2 Sn-4Zr-6Mo, 3Al-8V-6Cr4Mo-4Zr, 10V-2Fe-3Al, 13V-11Cr-3Al	S	up to 42 Rc	200	●	3	55	.0060	.0130	.0510	.1020	.1270	.1520	.2030	.2500	.2700
			200S		3		.0040	.0060	.0250	.0510	.0640	.0760	.1020	.1270	.1400
			200A		3		.0060	.0130	.0510	.1020	.1270	.1520	.2030	.2500	.2700
Cast Iron - Gray CG, ASTM A48, CLASS 20, 25, 30, 35, SAE J431C, GRADES G1800, G3000, G3500, GG 10, 15, 20, 25, 30, 35, 40	K	up to 240 HB	200	●	3	110	.0250	.0510	.0760	.1520	.2030	.2540	.2790	.3000	.3300
			200S		3		.0130	.0250	.0380	.0760	.1020	.1270	.1520	.1520	.1600
			200A		3		.0250	.0510	.0760	.1520	.2030	.2540	.2790	.3000	.3300
Cast Iron - Ductile & Malleable CGI 60-40-18, 65-45-12, D4018, D4512, D5506, 32510, 35108, M3210, M4504, M5503, 250, 300, 350, 400, 450	K	over 240 HB	200	●	3	80	.0250	.0510	.0760	.1520	.2030	.2540	.2790	.3000	.3300
			200S		3		.0130	.0250	.0380	.0760	.1020	.1270	.1520	.1520	.1600
			200A		3		.0250	.0510	.0760	.1520	.2030	.2540	.2790	.3000	.3300
Plastics	N		200	●	3	90	.0250	.0510	.0760	.1520	.2030	.2540	.2790	.3000	.3300
			200S		3		.0130	.0250	.0380	.0760	.1020	.1270	.1520	.1520	.1600
			200A		3		.0250	.0510	.0760	.1520	.2030	.2540	.2790	.3000	.3300
Kevlar/Graphite	N		200	●	3	90	.0250	.0510	.0760	.1520	.2030	.2540	.2790	.3000	.3300
			200S		3		.0130	.0250	.0380	.0760	.1020	.1270	.1520	.1520	.1600
			200A		3		.0250	.0510	.0760	.1520	.2030	.2540	.2790	.3000	.3300

200 Hi-Roc® / 200S

Twister® GP

Technical Information

Technical data provided should be considered advisory only as variations may be necessary depending on the particular application.

For product information, call your local distributor.

Recommended Cutting Data 204 / 206 - Inch

Workpiece Material Group	ISO	Hardness	Tool Series	TYPE	DEPTH	vc - SFM	Drill Diameter							
							1/32	1/16	1/8	1/4	3/8	1/2	5/8	3/4
							f - IPR							
Free Machining & Low Carbon Steels 1006, 1008, 1015, 1018, 1020, 1022, 1025, 1117, 1140, 1141, 11L08, 11L14, 1213, 12L13, 12L14, 1215, 1330	P	up to 28 Rc	206	●	3	175	.0010	.0020	.0030	.0060	.0080	.0100	.0110	.0120
			204		5									
Medium Carbon & High Carbon Steels, Alloy Steels & Easy to Machine Tool Steels 1030, 1035, 1040, 1045, 1050, 1052, 1055, 1060, 1085, 1095, 1541, 1551, 9255, 2515, 3135, 3415, 4130, 4137, 4140, 4150, 4320, 4340, 4520, 5015, 5115, 5120, 5132, 5140, 5155, 6150, 8620, 9262, 9840, 52100, O1, O2, O6, S2, W1 to W310	P	28 to 38 Rc	206	●	3	165	.0010	.0020	.0030	.0060	.0080	.0100	.0110	.0120
			204		5									
Tool Steels & Die Steels O7, M1, M2, M3, M4, M7, T1, T2, T4, T5, T8, T15, A2, A3, A6, A7, H10, H11, H12, H13, H19, H21, L3, L6, L7, P2, P20, S1, S5, S7, 52100, A 128, D2, D3, D4, D5, D7	P	28 to 44 Rc	206	●	3	150	.0010	.0020	.0030	.0060	.0080	.0100	.0110	.0120
			204		5									
Stainless Steel - Easy to Machine 430F, 301, 303, 410, 416 Annealed, 420F, 430, 430F	M	up to 28 Rc	206	●	3	195	.0010	.0020	.0030	.0060	.0080	.0100	.0110	.0120
			204		5									
Stainless Steel - Moderately Difficult 301, 302, 303 High Tensile, 304, 304L, 305, 420, 15-5PH, 17-4PH, 17-7PH	M	up to 28 Rc	206	●	3	125	.0010	.0020	.0030	.0060	.0080	.0100	.0110	.0120
			204		5									
Plastics	N		206	●	3	400	.00025	.0005	.0020	.0040	.0050	.0060	.0080	.0100
			204		5									
Kevlar/Graphite	N		206	●	3	400	.00025	.0005	.0020	.0040	.0050	.0060	.0080	.0100
			204		5									
Cast Iron - Gray CG, ASTM A48, CLASS 20, 25, 30, 35, SAE J431C, GRADES G1800, G3000, G3500, GG 10, 15, 20, 25, 30, 35, 40	K	up to 240 HB	206	●	3	275	.0010	.0020	.0030	.0060	.0080	.0100	.0110	.0120
			204		5									
Cast Iron - Ductile & Malleable CGI 60-40-18, 65-45-12, D4018, D4512, D5506, 32510, 35108, M3210, M4504, M5503, 250, 300, 350, 400, 450	K	over 240 HB	206	●	3	175	.0010	.0020	.0030	.0060	.0080	.0100	.0110	.0120
			204		5									

Technical data provided should be considered advisory only as variations may be necessary depending on the particular application.

Recommended Cutting Data 224 / 226 - Metric

Workpiece Material Group	I S O	Hardness	Tool Series	T Y P E	D E P T H	vc - m/min	Drill Diameter (mm)							
							1	1.5	3	6	10	12	16	20
							f - mm/Rev							
Free Machining & Low Carbon Steels 1006, 1008, 1015, 1018, 1020, 1022, 1025, 1117, 1140, 1141, 11L08, 11L14, 1213, 12L13, 12L14, 1215, 1330	P	up to 28 Rc	226	●	3	55	.025	.050	.076	.152	.203	.254	.275	.305
			224		5									
Medium Carbon & High Carbon Steels, Alloy Steels & Easy to Machine Tool Steels 1030, 1035, 1040, 1045, 1050, 1052, 1055, 1060, 1085, 1095, 1541, 1551, 9255, 2515, 3135, 3415, 4130, 4137, 4140, 4150, 4320, 4340, 4520, 5015, 5115, 5120, 5132, 5140, 5155, 6150, 8620, 9262, 9840, 52100, O1, O2, O6, S2, W1 to W310	P	28 to 38 Rc	226	●	3	50	.025	.050	.076	.152	.203	.254	.275	.305
			224		5									
Tool Steels & Die Steels O7, M1, M2, M3, M4, M7, T1, T2, T4, T5, T8, T15, A2, A3, A6, A7, H10, H11, H12, H13, H19, H21, L3, L6, L7, P2, P20, S1, S5, S7, 52100, A 128, D2, D3, D4, D5, D7	P	28 to 44 Rc	226	●	3	45	.025	.050	.076	.152	.203	.254	.275	.305
			224		5									
Stainless Steel - Easy to Machine 430F, 301, 303, 410, 416 Annealed, 420F, 430, 430F	M	up to 28 Rc	226	●	3	60	.025	.050	.076	.152	.203	.254	.275	.305
			224		5									
Stainless Steel - Moderately Difficult 301, 302, 303 High Tensile, 304, 304L, 305, 420, 15-5PH, 17-4PH, 17-7PH	M	up to 28 Rc	226	●	3	40	.025	.050	.076	.152	.203	.254	.275	.305
			224		5									
Plastics	N		226	●	3	120	.006	.013	.050	.076	.101	.152	.203	.225
			224		5									
Kevlar/Graphite	N		226	●	3	120	.006	.013	.050	.076	.101	.152	.203	.225
			224		5									
Cast Iron - Gray CG, ASTM A48, CLASS 20, 25, 30, 35, SAE J431C, GRADES G1800, G3000, G3500, GG 10, 15, 20, 25, 30, 35, 40	K	up to 240 HB	226	●	3	85	.025	.050	.076	.152	.203	.254	.275	.305
			224		5									
Cast Iron - Ductile & Malleable CGI 60-40-18, 65-45-12, D4018, D4512, D5506, 32510, 35108, M3210, M4504, M5503, 250, 300, 350, 400, 450	K	over 240 HB	226	●	3	55	.025	.050	.076	.152	.203	.254	.275	.305
			224		5									

Recommended Cutting Data 205 / 207 / 209 / 210 - Inch

Workpiece Material Group	I S O	Hardness	Tool Series	T Y P E	D E P T H	vc - SFM	Drill Diameter							
							1/32	1/16	1/8	1/4	3/8	1/2	5/8	3/4
							f - IPR							
Free Machining & Low Carbon Steels 1006, 1008, 1015, 1018, 1020, 1022, 1025, 1117, 1140, 1141, 11L08, 11L14, 1213, 12L13, 12L14, 1215, 1330	P	up to 28 Rc	205	●	Screw Machine	175	.0010	.0020	.0030	.0060	.0080	.0100	.0110	.0120
			205T				.0010	.0020	.0030	.0060	.0080	.0100	.0110	.0120
			209	●	5+	275	.0010	.0020	.0030	.0060	.0080	.0100	.0110	.0120
Medium Carbon & High Carbon Steels, Alloy Steels & Easy to Machine Tool Steels 1030, 1035, 1040, 1045, 1050, 1052, 1055, 1060, 1085, 1095, 1541, 1551, 9255, 2515, 3135, 3415, 4130, 4137, 4140, 4150, 4320, 4340, 4520, 5015, 5115, 5120, 5132, 5140, 5155, 6150, 8620, 9262, 9840, 52100, O1, O2, O6, S2, 1 to W310	P	28 to 38 Rc	205	●	Screw Machine	165	.0010	.0020	.0030	.0060	.0080	.0100	.0110	.0120
			205T				.0010	.0020	.0030	.0060	.0080	.0100	.0110	.0120
			209	●	5+	250	.0010	.0020	.0030	.0060	.0080	.0100	.0110	.0120
Tool Steels & Die Steels O7, M1, M2, M3, M4, M7, T1, T2, T4, T5, T8, T15, A2, A3, A6, A7, H10, H11, H12, H13, H19, H21, L3, L6, L7, P2, P20, S1, S5, S7, 52100, A 128, D2, D3, D4, D5, D7	P	28 to 44 Rc	205	●	Screw Machine	150	.0010	.0020	.0030	.0060	.0080	.0100	.0110	.0120
			205T				.0010	.0020	.0030	.0060	.0080	.0100	.0110	.0120
			209	●	5+	225	.0010	.0020	.0030	.0060	.0080	.0100	.0110	.0120
Stainless Steel - Moderately Difficult 301, 302, 303 High Tensile, 304, 304L, 305, 420, 15-5PH, 17-4PH, 17-7PH	M	up to 28 Rc	205	●	Screw Machine	140	.0010	.0020	.0030	.0060	.0080	.0100	.0110	.0120
			205T				.0010	.0020	.0030	.0060	.0080	.0100	.0110	.0120
			210	●	3	80	.0010	.0020	.0030	.0060	.0080	.0100	.0110	.0120
Stainless Steel - Difficult to Machine 302B, 304B, 309, 310, 316, 316B, 316L, 316Ti, 317, 317L, 321, PH13-8Mo, Nitronics	M	up to 28 Rc	205	●	Screw Machine	60	.0003	.0005	.0020	.0040	.0050	.0060	.0080	.0100
			205T				.0003	.0005	.0020	.0040	.0050	.0060	.0080	.0100
			209	●	5+	80	.0003	.0005	.0020	.0040	.0050	.0060	.0080	.0100
High Temp Alloys Nimonic, Inconel, Monel, Hastelloy	S	up to 42 Rc	205	●	Screw Machine	60	.0003	.0005	.0020	.0040	.0050	.0060	.0080	.0100
			205T				.0003	.0005	.0020	.0040	.0050	.0060	.0080	.0100
			209	●	5+	50	.0003	.0005	.0020	.0040	.0050	.0060	.0080	.0100
Titanium Alloys 6Al-4V, 5Al-2.5 Sn, 6Al-2 Sn-4Zr-6Mo, 3Al-8V-6Cr-4Mo-4Zr, 10V-2Fe-3Al, 13V-11Cr-3Al	S	up to 42 Rc	205	●	Screw Machine	80	.0003	.0005	.0020	.0040	.0050	.0060	.0080	.0100
			205T				.0003	.0005	.0020	.0040	.0050	.0060	.0080	.0100
			209	●	5+	100	.0003	.0005	.0020	.0040	.0050	.0060	.0080	.0100
Cast Iron - Gray CG, ASTM A48, CLASS 20, 25, 30, 35, SAE J431C, GRADES G1800, G3000, G3500, GG 10, 15, 20, 25, 30, 35, 40	K	up to 240 HB	205	●	Screw Machine	175	.0010	.0020	.0030	.0060	.0080	.0100	.0110	.0120
			205T				.0010	.0020	.0030	.0060	.0080	.0100	.0110	.0120
			210	●	3	275	.0010	.0020	.0030	.0060	.0080	.0100	.0110	.0120
Cast Iron - Ductile & Malleable CGI, 60-40-18, 65-45-12, D4018, D4512, D5506, 32510, 35108, M3210, M4504, M5503, 250, 300, 350, 400, 450	K	over 240 HB	205	●	Screw Machine	175	.0010	.0020	.0030	.0060	.0080	.0100	.0110	.0120
			205T				.0010	.0020	.0030	.0060	.0080	.0100	.0110	.0120
			210	●	3	175	.0010	.0020	.0030	.0060	.0080	.0100	.0110	.0120
Plastics	N		205	●	Screw Machine	300	.0003	.0005	.0020	.0040	.0050	.0060	.0080	.0100
			205T				.0003	.0005	.0020	.0040	.0050	.0060	.0080	.0100
			207	●	3	300	.0003	.0005	.0020	.0040	.0050	.0060	.0080	.0100
Kevlar/Graphite	N		207	●	3	375	.0003	.0005	.0020	.0040	.0050	.0060	.0080	.0100
Hardened Steel	H	45 to 65 Rc	205	●	Screw Machine	50	.0003	.0010	.0010	.0010	.0020	.0020	.0020	.0030
			205T				.0003	.0010	.0010	.0010	.0020	.0020	.0020	.0030

Technical data provided should be considered advisory only as variations may be necessary depending on the particular application.

Recommended Cutting Data 205 / 207 / 209 / 210 - Metric

Workpiece Material Group	I S O	Hardness	Tool Series	T Y P E	D E P T H	vc - m/min	Drill Diameter (mm)							
							1	2	3	6	10	12	16	20
							f - mm/Rev							
Free Machining & Low Carbon Steels 1006, 1008, 1015, 1018, 1020, 1022, 1025, 1117, 1140, 1141, 11L08, 11L14, 1213, 12L13, 12L14, 1215, 1330	P	up to 28 Rc	205		Screw Machine	55	.025	.050	.078	.152	.203	.254	.275	.305
			205T				.025	.050	.078	.152	.203	.254	.275	.305
			209		5+	85	.025	.050	.078	.152	.203	.254	.275	.305
Medium Carbon & High Carbon Steels, Alloy Steels & Easy to Machine Tool Steels 1030, 1035, 1040, 1045, 1050, 1052, 1055, 1060, 1085, 1095, 1541, 1551, 9255, 2515, 3135, 3415, 4130, 4137, 4140, 4150, 4320, 4340, 4520, 5015, 5115, 5120, 5132, 5140, 5155, 6150, 8620, 9262, 9840, 52100, O1, O2, O6, S2, W1 to W310	P	28 to 38 Rc	205		Screw Machine	45	.025	.050	.078	.152	.203	.254	.275	.305
			205T				.025	.050	.078	.152	.203	.254	.275	.305
			209		5+	75	.025	.050	.078	.152	.203	.254	.275	.305
Tool Steels & Die Steels O7, M1, M2, M3, M4, M7, T1, T2, T4, T5, T8, T15, A2, A3, A6, A7, H10, H11, H12, H13, H19, H21, L3, L6, L7, P2, P20, S1, S5, S7, 52100, A 128, D2, D3, D4, D5, D7	P	28 to 44 Rc	205		Screw Machine	35	.025	.050	.078	.152	.203	.254	.275	.305
			205T				.025	.050	.078	.152	.203	.254	.275	.305
			209		5+	70	.025	.050	.078	.152	.203	.254	.275	.305
Stainless Steel - Moderately Difficult 301, 302, 303 High Tensile, 304, 304L, 305, 420, 15-5PH, 17-4PH, 17-7PH	M	up to 28 Rc	205		Screw Machine	45	.025	.050	.078	.152	.203	.254	.275	.305
			205T				.025	.050	.078	.152	.203	.254	.275	.305
			210	3	25	.025	.050	.078	.152	.203	.254	.275	.305	
Stainless Steel - Difficult to Machine 302B, 304B, 309, 310, 316, 316B, 316L, 316Ti, 317, 317L, 321, PH13-8Mo, Nitronics	M	up to 28 Rc	205		Screw Machine	20	.006	.013	.050	.076	.101	.152	.203	.225
			205T				.006	.013	.050	.076	.101	.152	.203	.225
			209		5+	25	.006	.013	.050	.076	.101	.152	.203	.225
High Temp Alloys Nimonic, Inconel, Monel, Hastelloy	S	up to 42 Rc	205		Screw Machine	20	.006	.013	.050	.076	.101	.152	.203	.225
			205T				.006	.013	.050	.076	.101	.152	.203	.225
			209		5+	15	.006	.013	.050	.076	.101	.152	.203	.225
Titanium Alloys 6Al-4V, 5Al-2.5 Sn, 6Al-2 Sn-4Zr-6Mo, 3Al-8V-6Cr-4Mo-4Zr, 10V-2Fe-3Al, 13V-11Cr-3Al	S	up to 42 Rc	205		Screw Machine	25	.006	.013	.050	.076	.101	.152	.203	.225
			205T				.006	.013	.050	.076	.101	.152	.203	.225
			209		5+	30	.006	.013	.050	.076	.101	.152	.203	.225
Cast Iron - Gray CG, ASTM A48, CLASS 20, 25, 30, 35, SAE J431C, GRADES G1800, G3000, G3500, GG 10, 15, 20, 25, 30, 35, 40	K	up to 240 HB	205		Screw Machine	55	.025	.050	.078	.152	.203	.254	.275	.305
			205T				.025	.050	.078	.152	.203	.254	.275	.305
			210	3	85	.025	.050	.078	.152	.203	.254	.275	.305	
Cast Iron - Ductile & Malleable CGI 60-40-18, 65-45-12, D4018, D4512, D5506, 32510, 35108, M3210, M4504, M5503, 250, 300, 350, 400, 450	K	over 240 HB	205		Screw Machine	55	.025	.050	.078	.152	.203	.254	.275	.305
			205T				.025	.050	.078	.152	.203	.254	.275	.305
			210	3		.025	.050	.078	.152	.203	.254	.275	.305	
Plastics	N		205		Screw Machine	90	.006	.013	.050	.076	.101	.152	.203	.225
			205T				.006	.013	.050	.076	.101	.152	.203	.225
			207	3		.006	.013	.050	.076	.101	.152	.203	.225	
Kevlar/Graphite	N		207	3	115	.006	.013	.050	.076	.101	.152	.203	.225	
Hardened Steel	H	45 to 65 Rc	205		Screw Machine	15	.0063	.0254	.0254	.0254	.0508	.0508	.0508	.0762
			205T				.0063	.0254	.0254	.0254	.0508	.0508	.0508	.0762

Technical data provided should be considered advisory only as variations may be necessary depending on the particular application.

For product information, call your local distributor.

Recommended Cutting Data 300 - Inch

Workpiece Material Group	ISO	Hardness	TYPE	vc - SFM	Drill Diameter					
					1/64	1/32	1/16	1/8	3/16	1/4
					f - IPR					
Free Machining & Low Carbon Steels 1006, 1008, 1015, 1018, 1020, 1022, 1025, 1117, 1140, 1141, 11L08, 11L14, 1213, 12L13, 12L14, 1215, 1330	P	up to 28 Rc	●	175	.0007	.0010	.0020	.0030	.0040	.0060
Medium Carbon & High Carbon Steels, Alloy Steels & Easy to Machine Tool Steels 1030, 1035, 1040, 1045, 1050, 1052, 1055, 1060, 1085, 1095, 1541, 1551, 9255, 2515, 3135, 3415, 4130, 4137, 4140, 4150, 4320, 4340, 4520, 5015, 5115, 5120, 5132, 5140, 5155, 6150, 8620, 9262, 9840, 52100, O1, O2, O6, S2, W1 to W310	P	28 to 38 Rc		150	.0007	.0010	.0020	.0030	.0040	.0060
Aluminum (<10% Si) 6061-T6 / 7075-T6	N		●	400	.0007	.0010	.0020	.0030	.0040	.0060
Aluminum (>10% Si) Copper / Brass	N			250	.0007	.0010	.0020	.0030	.0040	.0060
Plastics	N			300	.0007	.0010	.0020	.0030	.0040	.0060
Cast Iron - Gray CG, ASTM A48, CLASS 20, 25, 30, 35, SAE J431C, GRADES G1800, G3000, G3500, GG 10, 15, 20, 25, 30, 35, 40	K	up to 240 HB	●	275	.0007	.0010	.0020	.0030	.0040	.0060
Cast Iron - Ductile & Malleable CGI 60-40-18, 65-45-12, D4018, D4512, D5506, 32510, 35108, M3210, M4504, M5503, 250, 300, 350, 400, 450	K	over 240 HB		175	.0007	.0010	.0020	.0030	.0040	.0060

Technical data provided should be considered advisory only as variations may be necessary depending on the particular application.

Recommended Cutting Data 300 - Metric

Workpiece Material Group	I S O	Hardness	T Y P E	vc - m/min	Drill Diameter (mm)			
					0.5	1	2	3
					f - mm/Rev			
Free Machining & Low Carbon Steels 1006, 1008, 1015, 1018, 1020, 1022, 1025, 1117, 1140, 1141, 11L08, 11L14, 1213, 12L13, 12L14, 1215, 1330	P	up to 28 Rc	●	55	.017	.025	.050	.076
Medium Carbon & High Carbon Steels, Alloy Steels & Easy to Machine Tool Steels 1030, 1035, 1040, 1045, 1050, 1052, 1055, 1060, 1085, 1095, 1541, 1551, 9255, 2515, 3135, 3415, 4130, 4137, 4140, 4150, 4320, 4340, 4520, 5015, 5115, 5120, 5132, 5140, 5155, 6150, 8620, 9262, 9840, 52100, O1, O2, O6, S2, W1 to W310	P	28 to 38 Rc		45	.017	.025	.050	.076
Aluminum (<10% Si) 6061-T6 / 7075-T6	N	●	●	120	.017	.025	.050	.076
Aluminum (>10% Si) Copper / Brass	N			75	.017	.025	.050	.076
Plastics	N			90	.017	.025	.050	.076
Cast Iron - Gray CG, ASTM A48, CLASS 20, 25, 30, 35, SAE J431C, GRADES G1800, G3000, G3500, GG 10, 15, 20, 25, 30, 35, 40	K	up to 240 HB	●	85	.017	.025	.050	.076
Cast Iron - Ductile & Malleable CGI 60-40-18, 65-45-12, D4018, 4512, D5506, 32510, 35108, M3210, M4504, M5503, 250, 300, 350, 400, 450	K	over 240 HB		55	.017	.025	.050	.076



Recommended Cutting Data 302 / 306 - Inch

Workpiece Material Group	I S O	Hardness	Tool Series	T Y P E	vc - SFM	Drill Diameter				
						<.030	.031-.036	.037-.040	.041-.051	>.052
						f - IPR				
Free Machining & Low Carbon Steels 1006, 1008, 1015, 1018, 1020, 1022, 1025, 1117, 1140, 1141, 11L08, 11L14, 1213, 12L13, 12L14, 1215, 1330	P	up to 28 Rc	302	●	300	.0002-.0006	.0008	.0010	.0014	.0015
			306							
Medium Carbon & High Carbon Steels, Alloy Steels & Easy to Machine Tool Steels 1030, 1035, 1040, 1045, 1050, 1052, 1055, 1060, 1085, 1095, 1541, 1551, 9255, 2515, 3135, 3415, 4130, 4137, 4140, 4150, 4320, 4340, 4520, 5015, 5115, 5120, 5132, 5140, 5155, 6150, 8620, 9262, 9840, 52100, O1, O2, O6, S2, W1 to W310	P	28 to 38 Rc	302	●	225	.0002-.0006	.0008	.0010	.0014	.0015
			306							
Tool Steels & Die Steels O7, M1, M2, M3, M4, M7, T1, T2, T4, T5, T8, T15, A2, A3, A6, A7, H10, H11, H12, H13, H19, H21, L3, L6, L7, P2, P20, S1, S5, S7, 52100, A 128, D2, D3, D4, D5, D7	P	28 to 44 Rc	302	●	200	.0002-.0006	.0008	.0010	.0014	.0015
			306							
Hardened Steels A2 / 52100	H	35-45 Rc	302	●	175	.0002-.0006	.0008	.0010	.0014	.0015
			306							
Free Machining Stainless	M	up to 28 Rc	302	●	175	.0002-.0004	.0006	.0008	.0010	.0012
			306							
Stainless Steel - Austenitic 304 / 316	M	up to 28 Rc	302	●	200	.0002-.0004	.0006	.0008	.0010	.0012
			306							
Stainless Steel - Ferritic / Martensitic	M	up to 28 Rc	302	●	100	.0002-.0006	.0008	.0010	.0014	.0015
			306							
Stainless Steel - Moderately Difficult 301, 302, 303 High Tensile, 304, 304L, 305, 420, 15-5PH, 17-4PH, 17-7PH	M	over 28 Rc	302	●	75	.0002-.0006	.0008	.0010	.0014	.0015
			306							
Aluminum (<10% Si)	N		302	●	450	.0002-.0006	.0008	.0010	.0014	.0015
			306							
Aluminum (>10% Si)	N		302	●	325	.0002-.0006	.0008	.0010	.0014	.0015
			306							
Plastics	N		302	●	550	.0002-.0006	.0008	.0010	.0014	.0015
			306							
Composites / Fiber Reinforced Materials / Circuit Boards	N		302	●	650	.0005-.0015	.0020	.0030	.0040	.0050
			306							
Cast Iron - Gray CG, ASTM A48, CLASS 20, 25, 30, 35, SAE J431C, GRADES G1800, G3000, G3500, GG 10, 15, 20, 25, 30, 35, 40	K	up to 240 HB	302	●	400	.0002-.0006	.0008	.0010	.0014	.0015
			306							
Cast Iron - Ductile & Malleable CGI 60-40-18, 65-45-12, D4018, D4512, D5506, 32510, 35108, M3210, M4504, M5503, 250, 300, 350, 400, 450	K	over 240 HB	302	●	350	.0002-.0006	.0008	.0010	.0014	.0015
			306							
Titanium 6Al-4V	S	up to 42 Rc	302	●	60	.0002-.0004	.0006	.0008	.0010	.0012
			306							
High Temp Alloys Inconel / Hastelloy / Waspeloy / Nickel Based Alloys-Monel	S	up to 42 Rc	302	●	50	.0002-.0004	.0006	.0008	.0010	.0012
			306							

Chiploads above .006 are not recommended since location problems become more evident.

In typical circuit board materials, Micro Drills operate efficiently in the 600-700 SFM (180-215 m/min) ranges. Higher speed rates tend to produce excessive drill wear and early failure. In general, smaller diameter drills are limited to slower speeds, because of machine limitations.

Feed rates can be set extremely high in most applications, because of the quality and design features of the M.A. Ford® Micro Drill. However, certain precautions should be taken for proper performance and safety. When determining optimum feed rates, consider the following factors:

- Spindle motors must be rated at least one hp (1 horsepower).
- To prevent delamination, entry materials must be used.
- Pressure foot clamping must be appropriate.

When drilling harder materials, the Micro Drill life may be variable. Drilling set ups must be precise. The drill TIR must be less than .0001" (.0025mm). The feed axis motion must be smooth without any play. Machining practices are very important.

Note: Micro drills should be kept in their original packaging, or equivalent when not in use. Mechanical micrometers are not recommended for checking size.

Technical data provided should be considered advisory only as variations may be necessary depending on the particular application.

M.A. Ford® Phone: 800-553-8024 or 563-391-6220 • email: sales@maford.com • www.maford.com

Recommended Cutting Data 302 / 306 - Metric

Workpiece Material Group	I S O	Hardness	Tool Series	T Y P E	vc - m/min	Drill Diameter (mm)				
						<.76	.077-.92	.93-1.02	1.03-1.30	>1.31
						f - mm/Rev				
Free Machining & Low Carbon Steels 1006, 1008, 1015, 1018, 1020, 1022, 1025, 1117, 1140, 1141, 11L08, 11L14, 1213, 12L13, 12L14, 1215, 1330	P	up to 28 Rc	302	●	90	.005-.015	.020	.025	.036	.038
			306							
Medium Carbon & High Carbon Steels, Alloy Steels & Easy to Machine Tool Steels 1030, 1035, 1040, 1045, 1050, 1052, 1055, 1060, 1085, 1095, 1541, 1551, 9255, 2515, 3135, 3415, 4130, 4137, 4140, 4150, 4320, 4340, 4520, 5015, 5115, 5120, 5132, 5140, 5155, 6150, 8620, 9262, 9840, 52100, O1, O2, O6, S2, W1 to W310	P	28 to 38 Rc	302	●	70	.005-.015	.020	.025	.036	.038
			306							
Tool Steels & Die Steels O7, M1, M2, M3, M4, M7, T1, T2, T4, T5, T8, T15, A2, A3, A6, A7, H10, H11, H12, H13, H19, H21, L3, L6, L7, P2, P20, S1, S5, S7, 52100, A 128, D2, D3, D4, D5, D7	P	28 to 44 Rc	302	●	60	.005-.015	.020	.025	.036	.038
			306							
Hardened Steels A2 / 52100	H	35-45 Rc	302	●	55	.005-.015	.020	.025	.036	.038
			306							
Free Machining Stainless	M	up to 28 Rc	302	●	55	.005-.015	.020	.025	.036	.038
			306							
Stainless Steel - Austenitic 304 / 316	M	up to 28 Rc	302	●	60	.005-.015	.020	.025	.036	.038
			306							
Stainless Steel - Ferritic / Martensitic	M	up to 28 Rc	302	●	30	.005-.015	.020	.025	.036	.038
			306							
Stainless Steel - Moderately Difficult 301, 302, 303 High Tensile, 304, 304L, 305, 420, 15-5PH, 17-4PH, 17-7PH	M	over 28 Rc	302	●	25	.005-.015	.020	.025	.036	.038
			306							
Aluminum (<10% Si)	N		302	●	140	.005-.015	.020	.025	.036	.038
			306							
Aluminum (>10% Si)	N		302	●	100	.005-.015	.020	.025	.036	.038
			306							
Plastics	N		302	●	170	.005-.015	.020	.025	.036	.038
			306							
Composites / Fiber Reinforced Materials / Circuit Boards	N		302	●	200	.013-.038	.051	.076	.102	.127
			306							
Cast Iron - Gray CG, ASTM A48, CLASS 20, 25, 30, 35, SAE J431C, GRADES G1800, G3000, G3500, GG 10, 15, 20, 25, 30, 35, 40	K	up to 240 HB	302	●	120	.005-.015	.020	.025	.036	.038
			306							
Cast Iron - Ductile & Malleable CGI 60-40-18, 65-45-12, D4018, D4512, D5506, 32510, 35108, M3210, M4504, M5503, 250, 300, 350, 400, 450	K	over 240 HB	302	●	110	.005-.015	.020	.025	.036	.038
			306							
Titanium 6Al-4V	S	up to 42 Rc	302	●	20	.005-.010	.015	.020	.025	.030
			306							
High Temp Alloys Inconel / Hastelloy / Waspeloy / Nickel Based Alloys-Monel	S	up to 42 Rc	302	●	15	.005-.010	.015	.020	.025	.030
			306							

Chiploads above .140 are not recommended since location problems become more evident.

In typical circuit board materials, Micro Drills operate efficiently in the 600-700 SFM (180-215 m/min) ranges. Higher speed rates tend to produce excessive drill wear and early failure. In general, smaller diameter drills are limited to slower speeds, because of machine limitations.

Feed rates can be set extremely high in most applications, because of the quality and design features of the M.A. Ford® Micro Drill. However, certain precautions should be taken for proper performance and safety. When determining optimum feed rates, consider the following factors:

- Spindle motors must be rated at least one hp (1 horsepower).
- To prevent delamination, entry materials must be used.
- Pressure foot clamping must be appropriate.

When drilling harder materials, the Micro Drill life may be variable. Drilling set ups must be precise. The drill TIR must be less than .0001" (.0025mm). The feed axis motion must be smooth without any play. Machining practices are very important.

Note: Micro drills should be kept in their original packaging, or equivalent when not in use. Mechanical micrometers are not recommended for checking size.

Technical data provided should be considered advisory only as variations may be necessary depending on the particular application.

For product information, call your local distributor.

Recommended Cutting Data 402 / 403 / 404 / 405 - Inch

Workpiece Material Group	ISO	Hardness	Tool Series	TYPE	vc - SFM	Drill Diameter					
						1/32	1/16	1/8	1/4	3/8	1/2
						f - IPR					
Free Machining & Low Carbon Steels 1006, 1008, 1015, 1018, 1020, 1022, 1025, 1117, 1140, 1141, 11L08, 11L14, 1213, 12L13, 12L14, 1215, 1330	P	up to 28 Rc	402	●	175	.0005	.0010	.0015	.0030	.0040	.0050
			403								
			404								
			405								
Medium Carbon & High Carbon Steels, Alloy Steels & Easy to Machine Tool Steels 1030, 1035, 1040, 1045, 1050, 1052, 1055, 1060, 1085, 1095, 1541, 1551, 9255, 2515, 3135, 3415, 4130, 4137, 4140, 4150, 4320, 4340, 4520, 5015, 5115, 5120, 5132, 5140, 5155, 6150, 8620, 9262, 9840, 52100, O1, O2, O6, S2, W1 to W310	P	28 to 38 Rc	402	●	165	.0005	.0010	.0015	.0030	.0040	.0050
			403								
			404								
			405								
Tool Steels & Die Steels O7, M1, M2, M3, M4, M7, T1, T2, T4, T5, T8, T15, A2, A3, A6, A7, H10, H11, H12, H13, H19, H21, L3, L6, L7, P2, P20, S1, S5, S7, 52100, A 128, D2, D3, D4, D5, D7	P	28 to 44 Rc	402	●	150	.0005	.0010	.0015	.0030	.0040	.0050
			403								
			404								
			405								
Hardened Steels A2 / 52100	H	35 to 45 Rc	402	●	50	.0005	.0010	.0015	.0030	.0040	.0050
			403								
			404/405								
Stainless Steel - Austenitic 304 / 316	M	up to 28 Rc	402	●	125	.0005	.0010	.0015	.0030	.0040	.0050
			403								
			404								
			405								
Stainless Steel - Moderately Difficult 301, 302, 303 High Tensile, 304, 304L, 305, 420, 15-5PH, 17-4PH, 17-7PH	M	over 28 Rc	402	●	60	.0005	.0010	.0015	.0030	.0040	.0050
			403								
			404								
			405								
Cast Iron - Gray CG, ASTM A48, CLASS 20, 25, 30, 35, SAE J431C, GRADES G1800, G3000, G3500, GG 10, 15, 20, 25, 30, 35, 40	K	up to 240 HB	402	●	275	.0005	.0010	.0015	.0030	.0040	.0050
			403								
			404								
			405								
Cast Iron - Ductile & Malleable CGI 60-40-18, 65-45-12, D4018, D4512, D5506, 32510, 35108, M3210, M4504, M5503, 250, 300, 350, 400, 450	K	over 240 HB	402	●	175	.0005	.0010	.0015	.0030	.0040	.0050
			403								
			404								
			405								
Titanium 6Al-4V	S	up to 42 Rc	402	●	80	.0005	.0010	.0015	.0030	.0040	.0050
			403								
			404								
			405								
High Temp Alloys Inconel / Hastelloy / Waspeloy / Nickel Based Alloys-Monel	S	up to 42 Rc	402	●	40	.0005	.0010	.0015	.0030	.0040	.0050
			403								
			404								
			405								

Technical data provided should be considered advisory only as variations may be necessary depending on the particular application.

Recommended Cutting Data 402 / 403 / 404 / 405 - Metric

Workpiece Material Group	I S O	Hardness	Tool Series	T Y P E	vc - m/min	Drill Diameter (mm)					
						1	2	3	6	10	12
						f - mm/Rev					
Free Machining & Low Carbon Steels 1006, 1008, 1015, 1018, 1020, 1022, 1025, 1117, 1140, 1141, 11L08, 11L14, 1213, 12L13, 12L14, 1215, 1330	P	up to 28 Rc	402	●	55	.013	.025	.038	.076	.102	.127
			403								
			404								
			405								
Medium Carbon & High Carbon Steels, Alloy Steels & Easy to Machine Tool Steels 1030, 1035, 1040, 1045, 1050, 1052, 1055, 1060, 1085, 1095, 1541, 1551, 9255, 2515, 3135, 3415, 4130, 4137, 4140, 4150, 4320, 4340, 4520, 5015, 5115, 5120, 5132, 5140, 5155, 6150, 8620, 9262, 9840, 52100, O1, O2, O6, S2, W1 to W310	P	28 to 38 Rc	402	●	50	.013	.025	.038	.076	.102	.127
			403								
			404								
			405								
Tool Steels & Die Steels O7, M1, M2, M3, M4, M7, T1, T2, T4, T5, T8, T15, A2, A3, A6, A7, H10, H11, H12, H13, H19, H21, L3, L6, L7, P2, P20, S1, S5, S7, 52100, A 128, D2, D3, D4, D5, D7	P	28 to 44 Rc	402	●	45	.013	.025	.038	.076	.102	.127
			403								
			404								
			405								
Hardened Steels A2 / 52100	H	35 to 45 Rc	402	●	15	.013	.025	.038	.076	.102	.127
			403								
			404								
			405								
Stainless Steel - Austenitic 304 / 316	M	up to 28 Rc	402	●	40	.013	.025	.038	.076	.102	.127
			403								
			404								
			405								
Stainless Steel - Moderately Difficult 301, 302, 303 High Tensile, 304, 304L, 305, 420, 15-5PH, 17-4PH, 17-7PH	M	over 28 Rc	402	●	20	.013	.025	.038	.076	.102	.127
			403								
			404								
			405								
Cast Iron - Gray CG, ASTM A48, CLASS 20, 25, 30, 35, SAE J431C, GRADES G1800, G3000, G3500, GG 10, 15, 20, 25, 30, 35, 40	K	up to 240 HB	402	●	85	.013	.025	.038	.076	.102	.127
			403								
			404								
			405								
Cast Iron - Ductile & Malleable CGI 60-40-18, 65-45-12, D4018, D4512, D5506, 32510, 35108, M3210, M4504, M5503, 250, 300, 350, 400, 450	K	over 240 HB	402	●	55	.013	.025	.038	.076	.102	.127
			403								
			404								
			405								
Titanium 6Al-4V	S	up to 42 Rc	402	●	25	.013	.025	.038	.076	.102	.127
			403								
			404								
			405								
High Temp Alloys Inconel / Hastelloy / Waspeloy / Nickel Based Alloys-Monel	S	up to 42 Rc	402	●	10	.013	.025	.038	.076	.102	.127
			403								
			404								
			405								

Technical data provided should be considered advisory only as variations may be necessary depending on the particular application.

For product information, call your local distributor.

Drill Terminology

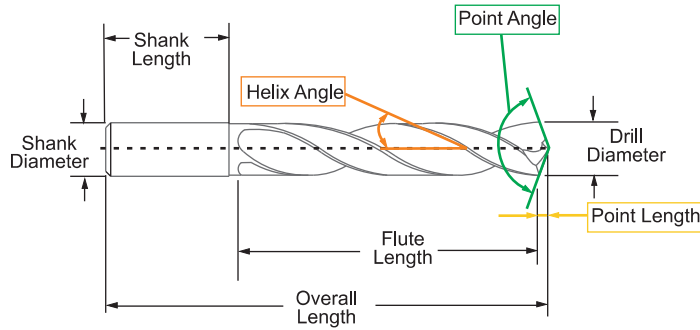

Chisel Edge – The non-cutting tip of the drill. Pushes, rather than cuts material. Having a smaller chisel means that a tool will cut more aggressively. A larger chisel means that a tool will be stronger.

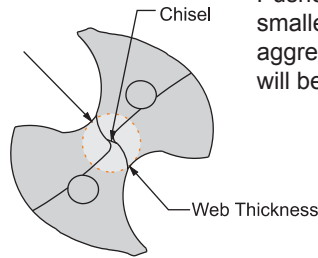

Web – The core of the drill that is left from the fluting operation. A thicker web means added rigidity, while a smaller web means more chip evacuation. On two flute drills, typically varies from 16% - 30% of the tool diameter.

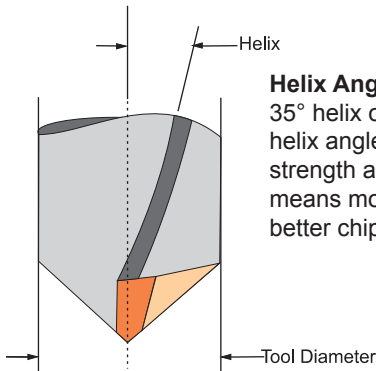

Helix Angle - Varies from 0° to 35° helix on standard tools. Lower helix angle means more rigidity and strength and a higher helix angle means more aggressive drilling and better chip evacuation.

Margin Width – Provides a surface to support the drill inside the hole during the drilling operation. M.A. Ford® offers both single margin and double margin geometries. Margin widths are a balancing act between friction build-up vs. tool support in the drilling operation.

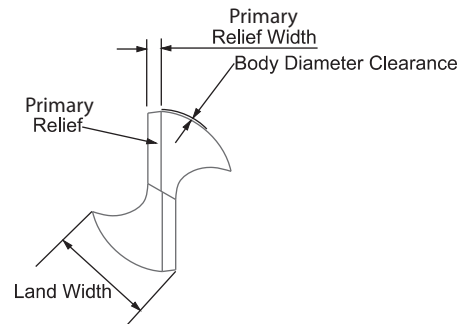

Cutting Lip - The cutting edges of a two flute drill extending from the chisel edge to the periphery.

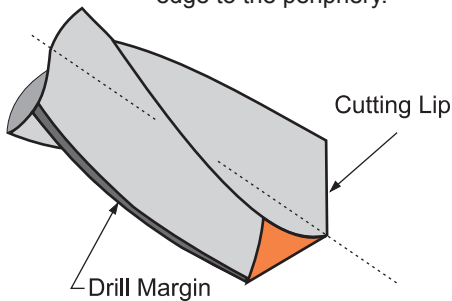

Land Width – The amount of material left on the drill per side, from the fluting operation. Larger land widths mean more rigidity, while smaller land widths allow for better chip evacuation.

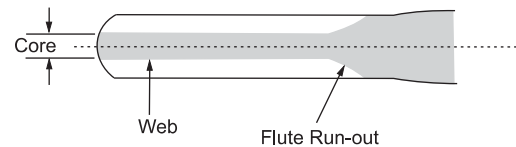

Having a problem with drill geometries? Circle the area where the problem exists. Include a detailed explanation of the issue and fax to Attn: Technical Application Support 800-892-9522 / 563-386-7660 or email: maftech@maford.com

Technical data provided should be considered advisory only as variations may be necessary depending on the particular application.



TuffCut®

High Performance End Mills

M.A. Ford® TuffCut® End Mills perform better and last significantly longer than competitive products, minimizing process downtime and maximizing productivity and cost efficiency. Included in our product line are high performance end mills developed for specific applications such as stainless steels and high temperature alloys, hardened steel, titanium, composite material, aluminum and softer alloys.

New to the TuffCut® XT End Mill family is series 277N, a necked version of the 4 Flute Tool, and series 279, a ball nose 4 flute end mill, as well as an expansion of the offering of our 278 series. The XT series consists of 4 & 5 flute end mills that feature improved geometries and enhanced corner protection that allows slotting at 1X diameter deep and higher feed rates over similar end mills. Coated with ALtima® Blaze, it is perfect for applications in high temperature alloys and titanium. A chipbreaker expands the TuffCut® XR7 offering with the new series 180CB. The chipbreaker breaks up continuous chips into small regular pieces for easy collection and disposal, as well as prevention of damage to the workpiece material. Finally, a standard offering of end mills with Weldon shank have been added to the 277, 278, 177 and 178 series of TuffCut® XT and XR end mills.

In addition to High Performance products, M.A. Ford® carries a complete family of standard carbide end mills designed for efficient general purpose milling of all steels, cast irons and most other materials. M.A. Ford® End Mills are ideal for tough or abrasive work. On many jobs, they can run faster than HSS or Cobalt because of their high heat resistance.

Benefits of M.A. Ford® End Mill products and support include:

- Thousands of end mills in stock.
- Over 50 different styles of end mills available.
- Aggressive speeds and feeds to maximize metal removal rates.
- Standard, Stub, Long and Extended Reach Lengths are available.
- Solid Carbide Tools are easy to re-sharpen for maximum life.
- ALtima®, ALtima® Plus, ALtima® Blaze, ALtima Micro® ALtima® 52, TiN, TiCN, Fordlube, GemX and CERAedge® coatings are available. See page 472 for more information on available coatings.
- U.S. Designed and Manufactured.



ISO 9001:2008 Certified



Where high performance is the standard®

TuffCut®

High Performance End Mills

- TuffCut® XT Series 277 & 277W NEW
- TuffCut® XT Series 277N
- TuffCut® XT Series 277 Set
- TuffCut® XT Series 278 & 278W NEW
- TuffCut® XT Series 278N
- NEW TuffCut® XT Series 279
- TuffCut® XR7 Series 180
- TuffCut® XR7 Series 180N
- NEW TuffCut® XR7 Series 180CB NEW
- TuffCut® XR Series 177 & 177W
- TuffCut® XR Series 177L
- TuffCut® XR Series 177S NEW
- TuffCut® XR Series 178 & 178W
- TuffCut® XR Series 178N
- TuffCut® XR Series 179
- TuffCut® XR Series 179L
- TuffCut® AL Series 135
- TuffCut® AL Series 135N
- TuffCut® AL Series 135B
- TuffCut® AL Series 135BN
- TuffCut® AL Series 136
- TuffCut® AL Series 134
- TuffCut® AL Series 134S
- TuffCut® AL Series 134N
- TuffCut® X-AL Series 138 & 138R
- TuffCut® X-AL Series 138N & 138NR
- TuffCut® X-AL Series 138CE
- TuffCut® X-AL Series 138B
- TuffCut® X-AL Series 138BN
- TuffCut DM™ Series 156
- TuffCut DM™ Series 158
- TuffCut DM™ Series 157
- TuffCut DM™ Series 192
- TuffCut® SS Series 112
- TuffCut® SS Series 113

NEW TuffCut® XT

Features:

- Unique M.A. Ford® Heli-Pitch Geometry
- Proprietary Carbide Substrate
- Improved Geometries
- Enhanced Corner Protection
- Industry Standard Corner Radii
- ALtima® Blaze Coated
- 4 And 5 Flutes
- Stub, Standard, Long And Extra Long Lengths, As Well As Neck Relief Styles Available
- Whisper Blend Transition Between OD And Neck

Benefits:

- Higher Feeds Over Similar End Mills
- Reduced Vibration Harmonics
- Improved Part Finishes
- Maintains Cutting Edge Strength & Sharpness For Improved Tool Life
- Slotting at 1X Diameter Deep
- State-Of-The-Art ALtima® Blaze PVD Coating For Superior Tool Life
- For Titanium And High Temp Alloy Applications



High Performance
TuffCut® End Mills

ADVANCED TECHNOLOGY

4
Flute
NEW

TuffCut® XT
Series 277 / 277W

Z4



38°/41°



ALtima®
Blaze



New-Standard Offering with Weldon Shank Flats

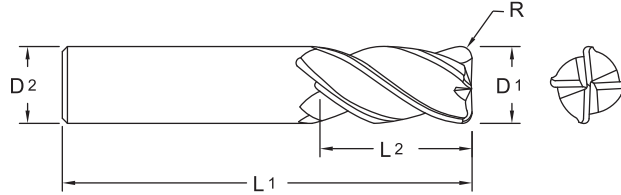

- Improved geometries.
- Enhanced corner protection.

ALtima® Blaze		ALtima® Blaze Weldon Flat		Diameter			Shank		OAL		Flute Length		Corner Radius	
Tool No.	EDP	Tool No.	EDP	D1			D2 h6		L1		L2		R	
				Inch	mm	Decimal	Inch	mm	Inch	mm	Inch	mm	Inch	mm
277 0300B	27700			3.0	.1181		6.0		57.0		8.0			
277 0300-0.25RB	27701			3.0	.1181		6.0		57.0		8.0		0.25	
27712500B	18700			1/8	.1250		1/8		1-1/2		1/8			
27712502B	18701			1/8	.1250		1/8		1-1/2		1/8		.015	
27712510B	18702			1/8	.1250		1/8		1-1/2		3/8			
27712512B	18703			1/8	.1250		1/8		1-1/2		3/8		.015	
277L1250B	18704			1/8	.1250		1/8		1-1/2		1/2			
277L1252B	18705			1/8	.1250		1/8		1-1/2		1/2		.015	
277 0400B	27702			4.0	.1575		6.0		57.0		11.0			
277 0400-0.25RB	27703			4.0	.1575		6.0		57.0		11.0		0.25	
27718700B	18710			3/16	.1875		3/16		2		3/16			
27718702B	18711			3/16	.1875		3/16		2		3/16		.015	
27718704B	18712			3/16	.1875		3/16		2		3/16		.030	
27718710B	18713			3/16	.1875		3/16		2		7/16			
27718712B	18714			3/16	.1875		3/16		2		7/16		.015	
27718714B	18715			3/16	.1875		3/16		2		7/16		.030	
277L1870B	18716			3/16	.1875		3/16		2-1/2		3/4			
277L1872B	18717			3/16	.1875		3/16		2-1/2		3/4		.015	
277L1874B	18718			3/16	.1875		3/16		2-1/2		3/4		.030	
277 0500B	27704			5.0	.1968		6.0		57.0		13.0			
277 0500-0.25RB	27705			5.0	.1968		6.0		57.0		13.0		0.25	
277 0600B	27706			6.0	.2362		6.0		57.0		13.0			
277 0600-0.25RB	27707			6.0	.2362		6.0		57.0		13.0		0.25	
27725000B	18725			1/4	.2500		1/4		2		3/8			
27725002B	18726			1/4	.2500		1/4		2		3/8		.015	
27725004B	18727			1/4	.2500		1/4		2		3/8		.030	
27725010B	18728			1/4	.2500		1/4		2-1/2		3/4			
27725012B	18729			1/4	.2500		1/4		2-1/2		3/4		.015	
27725014B	18730			1/4	.2500		1/4		2-1/2		3/4		.030	
277L2500B	18731			1/4	.2500		1/4		3		1-1/4			
277L2502B	18732			1/4	.2500		1/4		3		1-1/4		.015	
277L2504B	18733			1/4	.2500		1/4		3		1-1/4		.030	
277X2500B	18734			1/4	.2500		1/4		4		1-3/4			
277X2502B	18735			1/4	.2500		1/4		4		1-3/4		.015	

Inch	
R	Tolerance
1/8 - 1	+.0000/-0.0016

Metric (mm)	
R	Tolerance
3.0 - 20.0	+.00/-0.04

Inch	
D1	Tolerance
1/8 - 1/4	+.000/-0.002
>1/4 - 1	+.000/-0.003

Metric (mm)	
D1	Tolerance (h10)
3.00	+.000/-0.040
>3.00 - 6.00	+.000/-0.048
>6.00 - 10.00	+.000/-0.058
>10.00 - 18.00	+.000/-0.070
>18.00 - 20.00	+.000/-0.084

Inch	
D2	Tolerance (h6)
.1182 - .2362	+0/-0.00031
.2363 - .3937	+0/-0.00035
.3938 - .7087	+0/-0.00043
.7088 - 1.000	+0/-0.00051

Metric (mm)	
D2	Tolerance (h6)
6.0	+0/-0.008
6.01 - 10.0	+0/-0.009
10.01 - 18.0	+0/-0.011
18.01 - 20.0	+0/-0.013



Series 277 / 277W Continued

4
Flute

277 / 277W
TuffCut® XT

HIGH PERFORMANCE

ALtima® Blaze		ALtima® Blaze Weldon Flat		Diameter			Shank		OAL		Flute Length		Corner Radius	
Tool No.	EDP	Tool No.	EDP	D1			D2 h6		L1		L2		R	
				Inch	mm	Decimal	Inch	mm	Inch	mm	Inch	mm	Inch	mm
277X2504B	18736			1/4		.2500	1/4		4		1-3/4		.030	
27731200B	18740			5/16		.3125	5/16		2		7/16			
27731202B	18741			5/16		.3125	5/16		2		7/16		.015	
27731204B	18742			5/16		.3125	5/16		2		7/16		.030	
27731206B	18743			5/16		.3125	5/16		2		7/16		.060	
27731210B	18744			5/16		.3125	5/16		2-1/2		13/16			
27731212B	18745			5/16		.3125	5/16		2-1/2		13/16		.015	
27731214B	18746			5/16		.3125	5/16		2-1/2		13/16		.030	
27731216B	18747			5/16		.3125	5/16		2-1/2		13/16		.060	
277L3120B	18748			5/16		.3125	5/16		3		1-1/4			
277L3122B	18749			5/16		.3125	5/16		3		1-1/4		.015	
277L3124B	18750			5/16		.3125	5/16		3		1-1/4		.030	
277L3126B	18751			5/16		.3125	5/16		3		1-1/4		.060	
277X3120B	18752			5/16		.3125	5/16		4		1-3/4			
277X3122B	18753			5/16		.3125	5/16		4		1-3/4		.015	
277X3124B	18754			5/16		.3125	5/16		4		1-3/4		.030	
277X3126B	18755			5/16		.3125	5/16		4		1-3/4		.060	
277 0800B	27708				8.0	.3150		8.0		63.0		19.0		
277 0800-0.80RB	27709				8.0	.3150		8.0		63.0		19.0		0.80
27737500B	18759			3/8		.3750	3/8		2		1/2			
27737502B	18760			3/8		.3750	3/8		2		1/2		.015	
27737504B	18761			3/8		.3750	3/8		2		1/2		.030	
27737506B	18762			3/8		.3750	3/8		2		1/2		.060	
27737510B	18763			3/8		.3750	3/8		2-1/2		7/8			
27737512B	18764			3/8		.3750	3/8		2-1/2		7/8		.015	
27737514B	18765			3/8		.3750	3/8		2-1/2		7/8		.030	
27737516B	18766			3/8		.3750	3/8		2-1/2		7/8		.060	
27737520B	14498			3/8		.3750	3/8		3		1-1/4			
27737522B	14499			3/8		.3750	3/8		3		1-1/4		.015	
27737524B	14500			3/8		.3750	3/8		3		1-1/4		.030	
27737526B	14503			3/8		.3750	3/8		3		1-1/4		.060	
277L3750B	18767			3/8		.3750	3/8		4		1-1/2			
277L3752B	18768			3/8		.3750	3/8		4		1-1/2		.015	
277L3754B	18769			3/8		.3750	3/8		4		1-1/2		.030	
277L3756B	18770			3/8		.3750	3/8		4		1-1/2		.060	
277X3750B	18771			3/8		.3750	3/8		4		2-1/2			
277X3752B	18772			3/8		.3750	3/8		4		2-1/2		.015	
277X3754B	18773			3/8		.3750	3/8		4		2-1/2		.030	
277X3756B	18774			3/8		.3750	3/8		4		2-1/2		.060	
277 1000B	27710				10.0	.3937		10.0		72.0		22.0		
277 1000-0.80RB	27711				10.0	.3937		10.0		72.0		22.0		0.80
27743700B	18778			7/16		.4375	7/16		2-1/2		1/2			
27743702B	18779			7/16		.4375	7/16		2-1/2		1/2		.015	
27743704B	18780			7/16		.4375	7/16		2-1/2		1/2		.030	
27743710B	18781			7/16		.4375	7/16		2-3/4		1			
27743712B	18782			7/16		.4375	7/16		2-3/4		1		.015	
27743714B	18783			7/16		.4375	7/16		2-3/4		1		.030	
277L4370B	18784			7/16		.4375	7/16		4		2			
277L4372B	18785			7/16		.4375	7/16		4		2		.015	
277L4374B	18786			7/16		.4375	7/16		4		2		.030	
277 1200B	27712				12.0	.4724		12.0		83.0		26.0		
277 1200-0.80RB	27713				12.0	.4724		12.0		83.0		26.0		0.80



4
Flute

Series 277 / 277W Continued

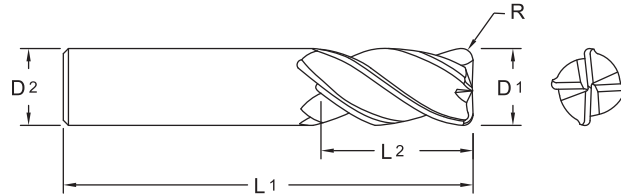

ALtima® Blaze		ALtima® Blaze Weldon Flat		Diameter			Shank		OAL		Flute Length		Corner Radius	
Tool No.	EDP	Tool No.	EDP	D1			D2 h6		L1		L2		R	
				Inch	mm	Decimal	Inch	mm	Inch	mm	Inch	mm	Inch	mm
277 1200-3.00RB	27714				12.0	.4724		12.0		83.0		26.0		3.00
2775000B	18787	2775000BW	13269	1/2		.5000	1/2		2-1/2		5/8			
27750002B	18788	27750002BW	13270	1/2		.5000	1/2		2-1/2		5/8		.015	
27750004B	18789	27750004BW	13271	1/2		.5000	1/2		2-1/2		5/8		.030	
27750006B	18790	27750006BW	13272	1/2		.5000	1/2		2-1/2		5/8		.060	
27750010B	18791	27750010BW	13273	1/2		.5000	1/2		3		1			
27750012B	18792	27750012BW	13274	1/2		.5000	1/2		3		1		.015	
27750014B	18793	27750014BW	13275	1/2		.5000	1/2		3		1		.030	
27750015B	18811	27750015BW	13276	1/2		.5000	1/2		3		1		.045	
27750016B	18794	27750016BW	13277	1/2		.5000	1/2		3		1		.060	
27750017B	18795	27750017BW	13278	1/2		.5000	1/2		3		1		.090	
27750018B	18796	27750018BW	13279	1/2		.5000	1/2		3		1		.120	
27750020B	18797	27750020BW	13280	1/2		.5000	1/2		3		1-1/4			
27750022B	18798	27750022BW	13281	1/2		.5000	1/2		3		1-1/4		.015	
27750024B	18799	27750024BW	13282	1/2		.5000	1/2		3		1-1/4		.030	
27750026B	18800	27750026BW	13283	1/2		.5000	1/2		3		1-1/4		.060	
27750027B	18801	27750027BW	13284	1/2		.5000	1/2		3		1-1/4		.090	
27750028B	18802	27750028BW	13285	1/2		.5000	1/2		3		1-1/4		.120	
277L5000B	18803	277L5000BW	13286	1/2		.5000	1/2		4		2			
277L5002B	18804	277L5002BW	13287	1/2		.5000	1/2		4		2		.015	
277L5004B	18805	277L5004BW	13288	1/2		.5000	1/2		4		2		.030	
277L5006B	18806	277L5006BW	13289	1/2		.5000	1/2		4		2		.060	
277X5000B	18807	277X5000BW	13290	1/2		.5000	1/2		5		3			
277X5002B	18808	277X5002BW	13291	1/2		.5000	1/2		5		3		.015	
277X5004B	18809	277X5004BW	13292	1/2		.5000	1/2		5		3		.030	
277X5006B	18810	277X5006BW	13293	1/2		.5000	1/2		5		3		.060	
27762500B	18814	27762500BW	13294	5/8		.6250	5/8		3		3/4			
27762502B	18815	27762502BW	13295	5/8		.6250	5/8		3		3/4		.015	
27762504B	18816	27762504BW	13296	5/8		.6250	5/8		3		3/4		.030	
27762506B	18817	27762506BW	13297	5/8		.6250	5/8		3		3/4		.060	
27762510B	18818	27762510BW	13298	5/8		.6250	5/8		3-1/2		1-1/4			
27762512B	18819	27762512BW	13299	5/8		.6250	5/8		3-1/2		1-1/4		.015	
27762514B	18820	27762514BW	14141	5/8		.6250	5/8		3-1/2		1-1/4		.030	
27762516B	18821	27762516BW	14142	5/8		.6250	5/8		3-1/2		1-1/4		.060	
27762517B	18822	27762517BW	14143	5/8		.6250	5/8		3-1/2		1-1/4		.090	
27762518B	18823	27762518BW	14144	5/8		.6250	5/8		3-1/2		1-1/4		.120	
277L6250B	18824	277L6250BW	14145	5/8		.6250	5/8		5		2-1/4			
277L6252B	18825	277L6252BW	14146	5/8		.6250	5/8		5		2-1/4		.015	
277L6254B	18826	277L6254BW	14147	5/8		.6250	5/8		5		2-1/4		.030	
277L6256B	18827	277L6256BW	14148	5/8		.6250	5/8		5		2-1/4		.060	



Series 277 / 277W Continued

4
Flute

277 / 277W
TuffCut® XT

HIGH PERFORMANCE

ALtima® Blaze		ALtima® Blaze Weldon Flat		Diameter			Shank		OAL		Flute Length		Corner Radius	
Tool No.	EDP	Tool No.	EDP	D1			D2 h6		L1		L2		R	
				Inch	mm	Decimal	Inch	mm	Inch	mm	Inch	mm	Inch	mm
277X6250B	18828	277X6250BW	14149	5/8		.6250	5/8		6		3			
277X6252B	18829	277X6252BW	14150	5/8		.6250	5/8		6		3		.015	
277X6254B	18830	277X6254BW	14151	5/8		.6250	5/8		6		3		.030	
277X6256B	18831	277X6256BW	14152	5/8		.6250	5/8		6		3		.060	
277 1600B	27715				16.0	.6299		16.0		92.0		32.0		
277 1600-0.80RB	27716				16.0	.6299		16.0		92.0		32.0		0.80
27775000B	18832	27775000BW	14153	3/4		.7500	3/4		3		1			
27775002B	18833	27775002BW	14154	3/4		.7500	3/4		3		1		.015	
27775004B	18834	27775004BW	14155	3/4		.7500	3/4		3		1		.030	
27775006B	18835	27775006BW	14156	3/4		.7500	3/4		3		1		.060	
27775010B	18836	27775010BW	14157	3/4		.7500	3/4		4		1-5/8			
27775012B	18837	27775012BW	14158	3/4		.7500	3/4		4		1-5/8		.015	
27775014B	18838	27775014BW	14159	3/4		.7500	3/4		4		1-5/8		.030	
27775016B	18839	27775016BW	14160	3/4		.7500	3/4		4		1-5/8		.060	
27775017B	18840	27775017BW	14161	3/4		.7500	3/4		4		1-5/8		.090	
27775018B	18841	27775018BW	14162	3/4		.7500	3/4		4		1-5/8		.120	
27775019B	18842	27775019BW	14163	3/4		.7500	3/4		4		1-5/8		.190	
27775020B	18843	27775020BW	14164	3/4		.7500	3/4		4		1-5/8		.250	
277L7500B	18844	277L7500BW	14165	3/4		.7500	3/4		5		2-1/4			
277L7502B	18845	277L7502BW	14166	3/4		.7500	3/4		5		2-1/4		.015	
277L7504B	18846	277L7504BW	14167	3/4		.7500	3/4		5		2-1/4		.030	
277L7506B	18847	277L7506BW	14168	3/4		.7500	3/4		5		2-1/4		.060	
277X7500B	18848	277X7500BW	14169	3/4		.7500	3/4		6		3			
277X7502B	18849	277X7502BW	14170	3/4		.7500	3/4		6		3		.015	
277X7504B	18850	277X7504BW	14171	3/4		.7500	3/4		6		3		.030	
277X7506B	18851	277X7506BW	14172	3/4		.7500	3/4		6		3		.060	
277XX750B	18852	277XX750BW	14173	3/4		.7500	3/4		7		4-1/8			
277XX754B	18853	277XX754BW	14174	3/4		.7500	3/4		7		4-1/8		.030	
277XX756B	18854	277XX756BW	14175	3/4		.7500	3/4		7		4-1/8		.060	
277 2000B	27717				20.0	.7874		20.0		104.0		38.0		
277 2000-0.80RB	27718				20.0	.7874		20.0		104.0		38.0		0.80
27710010B	18859	27710010BW	14176	1		1.0000	1		4		1-1/2			
27710012B	18860	27710012BW	14177	1		1.0000	1		4		1-1/2		.015	
27710014B	18861	27710014BW	14178	1		1.0000	1		4		1-1/2		.030	
27710016B	18862	27710016BW	14179	1		1.0000	1		4		1-1/2		.060	
27710017B	18863	27710017BW	14180	1		1.0000	1		4		1-1/2		.090	
27710018B	18864	27710018BW	14181	1		1.0000	1		4		1-1/2		.120	
27710019B	18865	27710019BW	14182	1		1.0000	1		4		1-1/2		.190	
27710020B	18866	27710020BW	14183	1		1.0000	1		4		1-1/2		.250	
277L1000B	18867	277L1000BW	14184	1		1.0000	1		5		2-1/4			
277L1002B	18868	277L1002BW	14185	1		1.0000	1		5		2-1/4		.015	
277L1004B	18869	277L1004BW	14186	1		1.0000	1		5		2-1/4		.030	
277L1006B	18870	277L1006BW	14187	1		1.0000	1		5		2-1/4		.060	
277X1000B	18871	277X1000BW	14188	1		1.0000	1		6		3			
277X1002B	18872	277X1002BW	14189	1		1.0000	1		6		3		.015	
277X1004B	18873	277X1004BW	14190	1		1.0000	1		6		3		.030	
277X1006B	18874	277X1006BW	14191	1		1.0000	1		6		3		.060	
277XX100B	18875	277XX100BW	14192	1		1.0000	1		7		4-1/8			
277XX104B	18876	277XX104BW	14193	1		1.0000	1		7		4-1/8		.030	
277XX106B	18877	277XX106BW	14194	1		1.0000	1		7		4-1/8		.060	



4
Flute

**TuffCut® XT
Series 277N**

NEW



- Improved geometries.
- Enhanced corner protection.

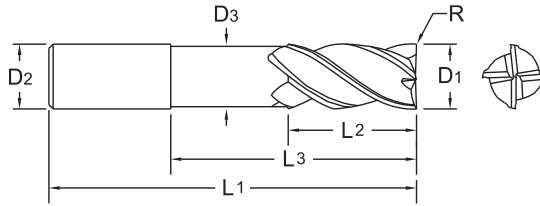

ALtima® Blaze		Diameter		Shank	Neck Diameter	OAL	Flute	Neck Length	Corner Radius	Neck/Diameter Ratio
Tool No.	EDP	D1	Decimal	D2 h6	D3	L1	L2	L3	R	L3/D1
27712500N3B	27720	1/8	.1250	1/8	.115	3	3/16	3/8		3
27712502N3B	27721	1/8	.1250	1/8	.115	3	3/16	3/8	.015	3
27712500N5B	27722	1/8	.1250	1/8	.115	3	3/16	5/8		5
27712502N5B	27723	1/8	.1250	1/8	.115	3	3/16	5/8	.015	5
27718700N3B	27724	3/16	.1875	3/16	.177	3	1/4	9/16		3
27718702N3B	27725	3/16	.1875	3/16	.177	3	1/4	9/16	.015	3
27718704N3B	27726	3/16	.1875	3/16	.177	3	1/4	9/16	.030	3
27718700N5B	27727	3/16	.1875	3/16	.177	3	1/4	15/16		5
27718702N5B	27728	3/16	.1875	3/16	.177	3	1/4	15/16	.015	5
27718704N5B	27729	3/16	.1875	3/16	.177	3	1/4	15/16	.030	5
27725000N3B	27730	1/4	.2500	1/4	.240	3	3/8	3/4		3
27725002N3B	27731	1/4	.2500	1/4	.240	3	3/8	3/4	.015	3
27725004N3B	27732	1/4	.2500	1/4	.240	3	3/8	3/4	.030	3
27725006N3B	27733	1/4	.2500	1/4	.240	3	3/8	3/4	.060	3
27725000N5B	27734	1/4	.2500	1/4	.240	4	3/8	1-1/4		5
27725002N5B	27735	1/4	.2500	1/4	.240	4	3/8	1-1/4	.015	5
27725004N5B	27736	1/4	.2500	1/4	.240	4	3/8	1-1/4	.030	5
27725006N5B	27737	1/4	.2500	1/4	.240	4	3/8	1-1/4	.060	5
27731200N3B	27738	5/16	.3125	5/16	.300	3	7/16	15/16		3
27731202N3B	27739	5/16	.3125	5/16	.300	3	7/16	15/16	.015	3
27731204N3B	27740	5/16	.3125	5/16	.300	3	7/16	15/16	.030	3
27737500N3B	27741	3/8	.3750	3/8	.360	3	1/2	1-1/8		3
27737502N3B	27742	3/8	.3750	3/8	.360	3	1/2	1-1/8	.015	3
27737504N3B	27743	3/8	.3750	3/8	.360	3	1/2	1-1/8	.030	3
27737506N3B	27744	3/8	.3750	3/8	.360	3	1/2	1-1/8	.060	3
27737500N4B	27745	3/8	.3750	3/8	.360	4	1/2	1-1/2		4
27737502N4B	27746	3/8	.3750	3/8	.360	4	1/2	1-1/2	.015	4
27737504N4B	27747	3/8	.3750	3/8	.360	4	1/2	1-1/2	.030	4
27737506N4B	27748	3/8	.3750	3/8	.360	4	1/2	1-1/2	.060	4
27737500N5B	27749	3/8	.3750	3/8	.360	4	1/2	1-7/8		5
27737502N5B	27750	3/8	.3750	3/8	.360	4	1/2	1-7/8	.015	5
27737504N5B	27751	3/8	.3750	3/8	.360	4	1/2	1-7/8	.030	5
27737506N5B	27752	3/8	.3750	3/8	.360	4	1/2	1-7/8	.060	5
27750000N3B	27753	1/2	.5000	1/2	.480	4	5/8	1-1/2		3
27750002N3B	27754	1/2	.5000	1/2	.480	4	5/8	1-1/2	.015	3
27750004N3B	27755	1/2	.5000	1/2	.480	4	5/8	1-1/2	.030	3
27750006N3B	27756	1/2	.5000	1/2	.480	4	5/8	1-1/2	.060	3
27750007N3B	27757	1/2	.5000	1/2	.480	4	5/8	1-1/2	.090	3

Inch	
D1	Tolerance
1/8 - 1/4	+0.000/-0.002
>1/4 - 1	+0.000/-0.003

Inch	
D2	Tolerance (h6)
.1182 - .2362	+0/-0.00031
.2363 - .3937	+0/-0.00035
.3938 - .7087	+0/-0.00043
.7088 - 1.000	+0/-0.00051

Inch	
R	Tolerance
1/8 - 1	+0.0000/-0.0016



Series 277N Continued

4
Flute

ALtima® Blaze		Diameter		Shank	Neck Diameter	OAL	Flute	Neck Length	Corner Radius	Neck/Diameter Ratio
Tool No.	EDP	D1	Decimal	D2 h6	D3	L1	L2	L3	R	L3/D1
27750008N3B	27758	1/2	.5000	1/2	.480	4	5/8	1-1/2	.120	3
27750000N4B	27759	1/2	.5000	1/2	.480	5	5/8	2		4
27750002N4B	27760	1/2	.5000	1/2	.480	5	5/8	2	.015	4
27750004N4B	27761	1/2	.5000	1/2	.480	5	5/8	2	.030	4
27750006N4B	27762	1/2	.5000	1/2	.480	5	5/8	2	.060	4
27750007N4B	27763	1/2	.5000	1/2	.480	5	5/8	2	.090	4
27750008N4B	27764	1/2	.5000	1/2	.480	5	5/8	2	.120	4
27750000N5B	27765	1/2	.5000	1/2	.480	6	5/8	2-1/2		5
27750002N5B	27766	1/2	.5000	1/2	.480	6	5/8	2-1/2	.015	5
27750004N5B	27767	1/2	.5000	1/2	.480	6	5/8	2-1/2	.030	5
27750006N5B	27768	1/2	.5000	1/2	.480	6	5/8	2-1/2	.060	5
27750007N5B	27769	1/2	.5000	1/2	.480	6	5/8	2-1/2	.090	5
27750008N5B	27770	1/2	.5000	1/2	.480	6	5/8	2-1/2	.120	5
27762500N3B	27771	5/8	.6250	5/8	.600	5	3/4	1-7/8		3
27762504N3B	27772	5/8	.6250	5/8	.600	5	3/4	1-7/8	.030	3
27762506N3B	27773	5/8	.6250	5/8	.600	5	3/4	1-7/8	.060	3
27762507N3B	27774	5/8	.6250	5/8	.600	5	3/4	1-7/8	.090	3
27762508N3B	27775	5/8	.6250	5/8	.600	5	3/4	1-7/8	.120	3
27762500N4B	27776	5/8	.6250	5/8	.600	5	3/4	2-1/2		4
27762504N4B	27777	5/8	.6250	5/8	.600	5	3/4	2-1/2	.030	4
27762506N4B	27778	5/8	.6250	5/8	.600	5	3/4	2-1/2	.060	4
27762507N4B	27779	5/8	.6250	5/8	.600	5	3/4	2-1/2	.090	4
27762508N4B	27780	5/8	.6250	5/8	.600	5	3/4	2-1/2	.120	4
27762500N5B	27781	5/8	.6250	5/8	.600	6	3/4	3-1/8		5
27762504N5B	27782	5/8	.6250	5/8	.600	6	3/4	3-1/8	.030	5
27762506N5B	27783	5/8	.6250	5/8	.600	6	3/4	3-1/8	.060	5
27762507N5B	27784	5/8	.6250	5/8	.600	6	3/4	3-1/8	.090	5
27762508N5B	27785	5/8	.6250	5/8	.600	6	3/4	3-1/8	.120	5
27775000N3B	27786	3/4	.7500	3/4	.720	5	1	2-1/4		3
27775004N3B	27787	3/4	.7500	3/4	.720	5	1	2-1/4	.030	3
27775006N3B	27788	3/4	.7500	3/4	.720	5	1	2-1/4	.060	3
27775007N3B	27789	3/4	.7500	3/4	.720	5	1	2-1/4	.090	3
27775008N3B	27790	3/4	.7500	3/4	.720	5	1	2-1/4	.120	3
27775009N3B	27791	3/4	.7500	3/4	.720	5	1	2-1/4	.190	3
27775012N3B	27792	3/4	.7500	3/4	.720	5	1	2-1/4	.250	3
27775000N4B	27793	3/4	.7500	3/4	.720	6	1	3		4
27775004N4B	27794	3/4	.7500	3/4	.720	6	1	3	.030	4
27775006N4B	27795	3/4	.7500	3/4	.720	6	1	3	.060	4
27775007N4B	27796	3/4	.7500	3/4	.720	6	1	3	.090	4
27775008N4B	27797	3/4	.7500	3/4	.720	6	1	3	.120	4
27775009N4B	27798	3/4	.7500	3/4	.720	6	1	3	.190	4
27775012N4B	27799	3/4	.7500	3/4	.720	6	1	3	.250	4
27775000N5B	27800	3/4	.7500	3/4	.720	6	1	3-3/4		5
27775004N5B	27801	3/4	.7500	3/4	.720	6	1	3-3/4	.030	5

277N
TuffCut® XT

HIGH PERFORMANCE



4
Flute

Series 277N Continued

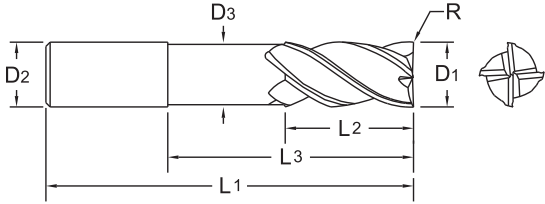

ALtima® Blaze		Diameter		Shank	Neck Diameter	OAL	Flute	Neck Length	Corner Radius	Neck/Diameter Ratio
Tool No.	EDP	D1	Decimal	D2 h6	D3	L1	L2	L3	R	L3/D1
27775006N5B	27802	3/4	.7500	3/4	.720	6	1	3-3/4	.060	5
27775007N5B	27803	3/4	.7500	3/4	.720	6	1	3-3/4	.090	5
27775008N5B	27804	3/4	.7500	3/4	.720	6	1	3-3/4	.120	5
27775009N5B	27805	3/4	.7500	3/4	.720	6	1	3-3/4	.190	5
27775012N5B	27806	3/4	.7500	3/4	.720	6	1	3-3/4	.250	5
27710000N3B	27807	1	1.0000	1	.960	6	1-1/4	3		3
27710004N3B	27808	1	1.0000	1	.960	6	1-1/4	3	.030	3
27710006N3B	27809	1	1.0000	1	.960	6	1-1/4	3	.060	3
27710007N3B	27810	1	1.0000	1	.960	6	1-1/4	3	.090	3
27710008N3B	27811	1	1.0000	1	.960	6	1-1/4	3	.120	3
27710009N3B	27812	1	1.0000	1	.960	6	1-1/4	3	.190	3
27710012N3B	27813	1	1.0000	1	.960	6	1-1/4	3	.250	3
27710000N4B	27814	1	1.0000	1	.960	6	1-1/4	4		4
27710004N4B	27815	1	1.0000	1	.960	6	1-1/4	4	.030	4
27710006N4B	27816	1	1.0000	1	.960	6	1-1/4	4	.060	4
27710007N4B	27817	1	1.0000	1	.960	6	1-1/4	4	.090	4
27710008N4B	27818	1	1.0000	1	.960	6	1-1/4	4	.120	4
27710009N4B	27819	1	1.0000	1	.960	6	1-1/4	4	.190	4
27710012N4B	27821	1	1.0000	1	.960	6	1-1/4	4	.250	4
27710000N5B	27823	1	1.0000	1	.960	7	1-1/4	5		5
27710004N5B	27825	1	1.0000	1	.960	7	1-1/4	5	.030	5
27710006N5B	27827	1	1.0000	1	.960	7	1-1/4	5	.060	5
27710007N5B	27829	1	1.0000	1	.960	7	1-1/4	5	.090	5
27710008N5B	27831	1	1.0000	1	.960	7	1-1/4	5	.120	5
27710009N5B	27833	1	1.0000	1	.960	7	1-1/4	5	.190	5
27710012N5B	27835	1	1.0000	1	.960	7	1-1/4	5	.250	5



NEW
TuffCut® XT
Series 277 Set

ALtima® Blaze		Diameters in Set	End
Tool Number	EDP		
27700000B	27699	1/8", 1/4", 3/8", 1/2"	Sq. End
27700002B	27698	1/8", 1/4", 3/8", 1/2"	.015 R



NEW

TuffCut® XT Series 278 / 278W

Z5

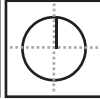

5
Flute

NEW

Additional sizes, lengths, corner radii, and Weldon Shank flat options

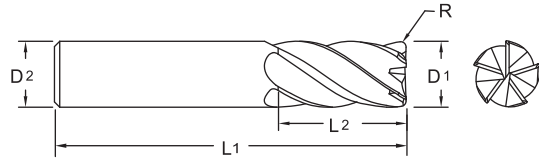

- Improved geometries.
- Enhanced corner protection.

ALtima® Blaze		ALtima® Blaze Weldon Flat		Diameter		Shank	OAL	Flute Length		Corner Radius	Stock Status
Tool No.	EDP	Tool No.	EDP	D1		D2 h6	L1	L2	R	• Stocked ○ Non-Stocked	
				Inch	Decimal	Inch	Inch	Inch	Inch		
27812500B	36992			1/8	.1250	1/8	1-1/2	1/4		•	
27812502B	97002			1/8	.1250	1/8	1-1/2	1/4	.015	•	
27812504B	97003			1/8	.1250	1/8	1-1/2	1/4	.030	•	
27812510B	36993			1/8	.1250	1/8	1-1/2	3/8		•	
27812520B	97005			1/8	.1250	1/8	1-1/2	1/2		•	
27812522B	97006			1/8	.1250	1/8	1-1/2	1/2	.015	•	
27812524B	97007			1/8	.1250	1/8	1-1/2	1/2	.030	•	
27812530B	97009			1/8	.1250	1/8	2-1/2	3/4		•	
27812532B	97010			1/8	.1250	1/8	2-1/2	3/4	.015	•	
27812534B	97011			1/8	.1250	1/8	2-1/2	3/4	.030	•	
27815600B	36994			5/32	.1562	3/16	2	3/16		•	
27815610B	36995			5/32	.1562	3/16	2	7/16		•	
27818700B	36996			3/16	.1875	3/16	2	5/16		•	
27818702B	97014			3/16	.1875	3/16	2	5/16	.015	•	
27818704B	97015			3/16	.1875	3/16	2	5/16	.030	•	
27818710B	36997			3/16	.1875	3/16	2	7/16		•	
27818720B	97017			3/16	.1875	3/16	2	9/16		•	
27818722B	97018			3/16	.1875	3/16	2	9/16	.015	•	
27818724B	97019			3/16	.1875	3/16	2	9/16	.030	•	
27818730B	97021			3/16	.1875	3/16	2-1/2	3/4		•	
27818732B	97022			3/16	.1875	3/16	2-1/2	3/4	.015	•	
27818734B	97023			3/16	.1875	3/16	2-1/2	3/4	.030	•	
27821800B	36998			7/32	.2187	1/4	2	1/4		•	
27821810B	36999			7/32	.2187	1/4	2-1/2	7/16		•	
27825000B	37000			1/4	.2500	1/4	2	3/8		•	
27825002B	37001			1/4	.2500	1/4	2	3/8	.015	•	
27825004B	37002			1/4	.2500	1/4	2	3/8	.030	•	
27825006B	97028			1/4	.2500	1/4	2	3/8	.060	○	
27825007B	97029			1/4	.2500	1/4	2	3/8	.090	○	
27825010B	37003			1/4	.2500	1/4	2-1/2	3/4		•	
27825012B	37004			1/4	.2500	1/4	2-1/2	3/4	.015	•	
27825014B	37005			1/4	.2500	1/4	2-1/2	3/4	.030	•	

Inch	
D1	Tolerance
1/8 - 1/4	+0.000/-0.002
>1/4 - 1	+0.000/-0.003

Inch	
D2	Tolerance (h6)
.1182 - .2362	+0/-0.00031
.2363 - .3937	+0/-0.00035
.3938 - .7087	+0/-0.00043
.7088 - 1.000	+0/-0.00051

Inch	
R	Tolerance
1/8 - 1	+0.0000/-0.0016

277N / 278 / 278W

TuffCut® XT

HIGH PERFORMANCE



5
Flute

Series 278 / 278W Continued

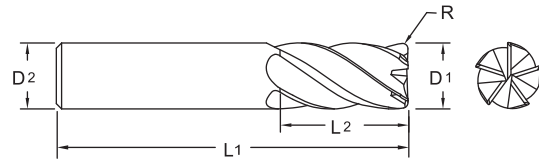

ALtima® Blaze		ALtima® Blaze Weldon Flat		Diameter		Shank	OAL	Flute Length		Corner Radius	Stock Status
Tool No.	EDP	Tool No.	EDP	D1		D2 h6	L1	L2	R	Stocked	
				Inch	Decimal	Inch	Inch	Inch	Inch	Non-Stocked	
27825016B	97052			1/4	.2500	1/4	2-1/2	3/4	.060	o	
27825017B	97053			1/4	.2500	1/4	2-1/2	3/4	.090	o	
278L25000B	37006			1/4	.2500	1/4	3	1-1/4		•	
278L25002B	37007			1/4	.2500	1/4	3	1-1/4	.015	•	
278L25004B	37008			1/4	.2500	1/4	3	1-1/4	.030	•	
278L25006B	97058			1/4	.2500	1/4	3	1-1/4	.060	o	
278L25007B	97059			1/4	.2500	1/4	3	1-1/4	.090	o	
278X25000B	37009			1/4	.2500	1/4	4	1-3/4		•	
278X25002B	37010			1/4	.2500	1/4	4	1-3/4	.015	•	
278X25004B	37075			1/4	.2500	1/4	4	1-3/4	.030	•	
27831200B	97061			5/16	.3125	5/16	2	7/16		•	
27831202B	97062			5/16	.3125	5/16	2	7/16	.015	o	
27831204B	97063			5/16	.3125	5/16	2	7/16	.030	o	
27831206B	97064			5/16	.3125	5/16	2	7/16	.060	o	
27831207B	97065			5/16	.3125	5/16	2	7/16	.090	o	
27831210B	97067			5/16	.3125	5/16	2-1/2	13/16		o	
27831212B	97068			5/16	.3125	5/16	2-1/2	13/16	.015	o	
27831214B	97069			5/16	.3125	5/16	2-1/2	13/16	.030	o	
27831216B	97070			5/16	.3125	5/16	2-1/2	13/16	.060	o	
27831217B	97071			5/16	.3125	5/16	2-1/2	13/16	.090	o	
27831220B	97073			5/16	.3125	5/16	3	1-1/4		o	
27831222B	97074			5/16	.3125	5/16	3	1-1/4	.015	o	
27831224B	97075			5/16	.3125	5/16	3	1-1/4	.030	o	
27831226B	97076			5/16	.3125	5/16	3	1-1/4	.060	o	
27831227B	97077			5/16	.3125	5/16	3	1-1/4	.090	o	
27831230B	97079			5/16	.3125	5/16	4	2-1/8		•	
27831232B	97080			5/16	.3125	5/16	4	2-1/8	.015	o	
27831234B	97081			5/16	.3125	5/16	4	2-1/8	.030	o	
27831236B	97082			5/16	.3125	5/16	4	2-1/8	.060	o	
27831237B	97083			5/16	.3125	5/16	4	2-1/8	.090	o	
27837500B	37013			3/8	.3750	3/8	2-1/2	1/2		•	
27837502B	37014			3/8	.3750	3/8	2-1/2	1/2	.015	•	
27837504B	37015			3/8	.3750	3/8	2-1/2	1/2	.030	•	
27837506B	97088			3/8	.3750	3/8	2-1/2	1/2	.060	o	
27837507B	97089			3/8	.3750	3/8	2-1/2	1/2	.090	o	
27837508B	97090			3/8	.3750	3/8	2-1/2	1/2	.120	o	
278375011B	97091			3/8	.3750	3/8	2-1/2	1/2	.156	o	
27837510B	37016			3/8	.3750	3/8	2-1/2	1		•	
27837512B	37017			3/8	.3750	3/8	2-1/2	1	.015	•	
27837514B	37018			3/8	.3750	3/8	2-1/2	1	.030	•	



Series 278 / 278W Continued

5
Flute

ALtima® Blaze		ALtima® Blaze Weldon Flat		Diameter		Shank	OAL	Flute Length		Corner Radius	Stock Status
Tool No.	EDP	Tool No.	EDP	D1		D2 h6	L1	L2	R	● Stocked ○ Non-Stocked	
				Inch	Decimal	Inch	Inch	Inch	Inch		
27837516B	97136			3/8	.3750	3/8	2-1/2	1	.060	●	
27837517B	97137			3/8	.3750	3/8	2-1/2	1	.090	○	
27837518B	97138			3/8	.3750	3/8	2-1/2	1	.120	○	
278375111B	97139			3/8	.3750	3/8	2-1/2	1	.156	○	
27837520B	97141			3/8	.3750	3/8	3	1-1/4		●	
27837522B	97142			3/8	.3750	3/8	3	1-1/4	.015	●	
27837524B	97143			3/8	.3750	3/8	3	1-1/4	.030	●	
27837526B	97144			3/8	.3750	3/8	3	1-1/4	.060	●	
27837527B	97145			3/8	.3750	3/8	3	1-1/4	.090	○	
27837528B	97146			3/8	.3750	3/8	3	1-1/4	.120	○	
278375211B	97147			3/8	.3750	3/8	3	1-1/4	.156	○	
27837530B	97149			3/8	.3750	3/8	3-1/2	1-5/8		●	
27837532B	97150			3/8	.3750	3/8	3-1/2	1-5/8	.015	○	
27837534B	97151			3/8	.3750	3/8	3-1/2	1-5/8	.030	○	
27837536B	97152			3/8	.3750	3/8	3-1/2	1-5/8	.060	○	
27837537B	97153			3/8	.3750	3/8	3-1/2	1-5/8	.090	○	
27837538B	97154			3/8	.3750	3/8	3-1/2	1-5/8	.120	○	
278375311B	97155			3/8	.3750	3/8	3-1/2	1-5/8	.156	○	
27837540B	97165			3/8	.3750	3/8	6	1-5/8		●	
27837542B	97166			3/8	.3750	3/8	6	1-5/8	.015	○	
27837544B	97167			3/8	.3750	3/8	6	1-5/8	.030	○	
27837546B	97168			3/8	.3750	3/8	6	1-5/8	.060	○	
27837547B	97169			3/8	.3750	3/8	6	1-5/8	.090	○	
27837548B	97170			3/8	.3750	3/8	6	1-5/8	.120	○	
278375411B	97171			3/8	.3750	3/8	6	1-5/8	.156	○	
27837550B	97173			3/8	.3750	3/8	4	2		●	
27837552B	97174			3/8	.3750	3/8	4	2	.015	○	
27837554B	97175			3/8	.3750	3/8	4	2	.030	○	
27837556B	97176			3/8	.3750	3/8	4	2	.060	○	
27837557B	97177			3/8	.3750	3/8	4	2	.090	○	
27837558B	97178			3/8	.3750	3/8	4	2	.120	○	
278375511B	97179			3/8	.3750	3/8	4	2	.156	○	
27837560B	97181			3/8	.3750	3/8	6	2-1/2		○	
27837562B	97182			3/8	.3750	3/8	6	2-1/2	.015	○	
27837564B	97183			3/8	.3750	3/8	6	2-1/2	.030	○	
27837566B	97184			3/8	.3750	3/8	6	2-1/2	.060	○	
27837567B	97185			3/8	.3750	3/8	6	2-1/2	.090	○	
27837568B	97186			3/8	.3750	3/8	6	2-1/2	.120	○	
278375611B	97187			3/8	.3750	3/8	6	2-1/2	.156	○	
278L37500B	37019			3/8	.3750	3/8	4	1-5/8		●	
278L37502B	37020			3/8	.3750	3/8	4	1-5/8	.015	●	
278L37504B	37076			3/8	.3750	3/8	4	1-5/8	.030	●	
278L37506B	97160			3/8	.3750	3/8	4	1-5/8	.060	○	
278L37507B	97161			3/8	.3750	3/8	4	1-5/8	.090	○	
278L37508B	97162			3/8	.3750	3/8	4	1-5/8	.120	○	
278L375011B	97163			3/8	.3750	3/8	4	1-5/8	.156	○	
278X37500B	37021			3/8	.3750	3/8	4	2-1/2		●	
278X37502B	37022			3/8	.3750	3/8	4	2-1/2	.015	●	

278 / 278W
TuffCut® XT

HIGH PERFORMANCE



5
Flute

Series 278 / 278W Continued

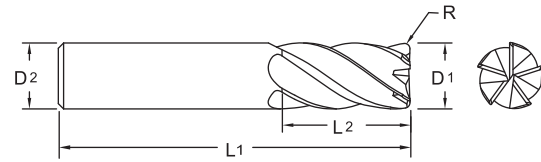

ALtima® Blaze		ALtima® Blaze Weldon Flat		Diameter		Shank	OAL	Flute Length		Corner Radius	Stock Status
Tool No.	EDP	Tool No.	EDP	D1		D2 h6	L1	L2	R	● Stocked	
				Inch	Decimal	Inch	Inch	Inch	Inch	○ Non-Stocked	
278X37504B	37077			3/8	.3750	3/8	4	2-1/2	.030	●	
27843700B	97189			7/16	.4375	7/16	2-1/2	5/8		●	
27843702B	97190			7/16	.4375	7/16	2-1/2	5/8	.015	○	
27843704B	97191			7/16	.4375	7/16	2-1/2	5/8	.030	○	
27843706B	97192			7/16	.4375	7/16	2-1/2	5/8	.060	○	
27843707B	97193			7/16	.4375	7/16	2-1/2	5/8	.090	○	
27843708B	97194			7/16	.4375	7/16	2-1/2	5/8	.120	○	
278437011B	97195			7/16	.4375	7/16	2-1/2	5/8	.156	○	
27843710B	97197			7/16	.4375	7/16	2-3/4	1		●	
27843712B	97198			7/16	.4375	7/16	2-3/4	1	.015	○	
27843714B	97199			7/16	.4375	7/16	2-3/4	1	.030	○	
27843716B	97200			7/16	.4375	7/16	2-3/4	1	.060	○	
27843717B	97201			7/16	.4375	7/16	2-3/4	1	.090	○	
27843718B	97202			7/16	.4375	7/16	2-3/4	1	.120	○	
278437111B	97203			7/16	.4375	7/16	2-3/4	1	.156	○	
27843720B	97205			7/16	.4375	7/16	4	2		●	
27843722B	97206			7/16	.4375	7/16	4	2	.015	○	
27843724B	97207			7/16	.4375	7/16	4	2	.030	○	
27843726B	97208			7/16	.4375	7/16	4	2	.060	○	
27843727B	97209			7/16	.4375	7/16	4	2	.090	○	
27843728B	97210			7/16	.4375	7/16	4	2	.120	○	
278437211B	97211			7/16	.4375	7/16	4	2	.156	○	
27850000B	37025	27850000BW	13528	1/2	.5000	1/2	3	5/8		●	
27850002B	37026	27850002BW	13529	1/2	.5000	1/2	3	5/8	.015	●	
27850004B	37027	27850004BW	13550	1/2	.5000	1/2	3	5/8	.030	●	
27850006B	97216			1/2	.5000	1/2	3	5/8	.060	●	
27850007B	97217			1/2	.5000	1/2	3	5/8	.090	●	
27850008B	97218			1/2	.5000	1/2	3	5/8	.120	●	
278500011B	97219			1/2	.5000	1/2	3	5/8	.156	●	
27850009B	97220			1/2	.5000	1/2	3	5/8	.190	●	
27850010B	97258			1/2	.5000	1/2	3	1		●	
27850012B	97259			1/2	.5000	1/2	3	1	.015	●	
27850014B	97260			1/2	.5000	1/2	3	1	.030	●	
27850016B	97261			1/2	.5000	1/2	3	1	.060	●	
27850017B	97262			1/2	.5000	1/2	3	1	.090	●	
27850018B	97263			1/2	.5000	1/2	3	1	.120	●	
278500111B	97264			1/2	.5000	1/2	3	1	.156	●	
27850019B	97265			1/2	.5000	1/2	3	1	.190	●	



Series 278 / 278W Continued

5
Flute

ALtima® Blaze		ALtima® Blaze Weldon Flat		Diameter		Shank	OAL	Flute Length		Corner Radius	Stock Status
Tool No.	EDP	Tool No.	EDP	D1		D2 h6	L1	L2	R	• Stocked	
				Inch	Decimal	Inch	Inch	Inch	Inch	○ Non-Stocked	
27850020B	37028	27850020BW	13551	1/2	.5000	1/2	3	1-1/4		•	
27850022B	37029	27850022BW	13579	1/2	.5000	1/2	3	1-1/4	.015	•	
27850024B	37030	27850024BW	12761	1/2	.5000	1/2	3	1-1/4	.030	•	
27850026B	37078	27850026BW	13584	1/2	.5000	1/2	3	1-1/4	.060	•	
27850027B	97271			1/2	.5000	1/2	3	1-1/4	.090	•	
27850028B	97272			1/2	.5000	1/2	3	1-1/4	.120	•	
278500211B	97273			1/2	.5000	1/2	3	1-1/4	.156	•	
27850029B	97274			1/2	.5000	1/2	3	1-1/4	.190	•	
27850030B	97276			1/2	.5000	1/2	4	1-5/8		•	
27850032B	97277			1/2	.5000	1/2	4	1-5/8	.015	•	
27850034B	97278			1/2	.5000	1/2	4	1-5/8	.030	•	
27850036B	97279			1/2	.5000	1/2	4	1-5/8	.060	•	
27850037B	97280			1/2	.5000	1/2	4	1-5/8	.090	•	
27850038B	97281			1/2	.5000	1/2	4	1-5/8	.120	•	
278500311B	97282			1/2	.5000	1/2	4	1-5/8	.156	•	
27850039B	97283			1/2	.5000	1/2	4	1-5/8	.190	•	
27850040B	97294			1/2	.5000	1/2	4	2-1/8		•	
27850042B	97295			1/2	.5000	1/2	4	2-1/8	.015	•	
27850044B	97296			1/2	.5000	1/2	4	2-1/8	.030	○	
27850046B	97297			1/2	.5000	1/2	4	2-1/8	.060	•	
27850047B	97298			1/2	.5000	1/2	4	2-1/8	.090	•	
27850048B	97299			1/2	.5000	1/2	4	2-1/8	.120	•	
278500411B	97300			1/2	.5000	1/2	4	2-1/8	.156	•	
27850049B	97301			1/2	.5000	1/2	4	2-1/8	.190	•	
27850050B	97303			1/2	.5000	1/2	5	2-5/8		•	
27850052B	97304			1/2	.5000	1/2	5	2-5/8	.015	•	
27850054B	97305			1/2	.5000	1/2	5	2-5/8	.030	•	
27850056B	97306			1/2	.5000	1/2	5	2-5/8	.060	•	
27850057B	97307			1/2	.5000	1/2	5	2-5/8	.090	•	
27850058B	97308			1/2	.5000	1/2	5	2-5/8	.120	•	
278500511B	97309			1/2	.5000	1/2	5	2-5/8	.156	•	
27850059B	97310			1/2	.5000	1/2	5	2-5/8	.190	•	
27850060B	97285			1/2	.5000	1/2	6	1-5/8		•	
27850062B	97286			1/2	.5000	1/2	6	1-5/8	.015	•	
27850064B	97287			1/2	.5000	1/2	6	1-5/8	.030	•	
27850066B	97288			1/2	.5000	1/2	6	1-5/8	.060	•	
27850067B	97289			1/2	.5000	1/2	6	1-5/8	.090	•	
27850068B	97290			1/2	.5000	1/2	6	1-5/8	.120	•	
278500611B	97291			1/2	.5000	1/2	6	1-5/8	.156	•	
27850069B	97292			1/2	.5000	1/2	6	1-5/8	.190	•	
27850070B	97312			1/2	.5000	1/2	6	3-1/4		•	
27850072B	97313			1/2	.5000	1/2	6	3-1/4	.015	•	
27850074B	97314			1/2	.5000	1/2	6	3-1/4	.030	•	
27850076B	97315			1/2	.5000	1/2	6	3-1/4	.060	•	
27850077B	97316			1/2	.5000	1/2	6	3-1/4	.090	•	
27850078B	97317			1/2	.5000	1/2	6	3-1/4	.120	•	

278 / 278W
TuffCut® XT

HIGH PERFORMANCE



Series 278 / 278W Continued

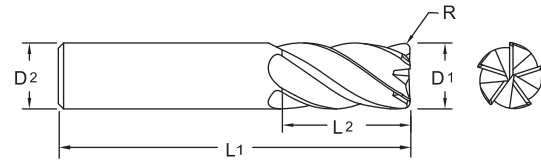

ALtima® Blaze		ALtima® Blaze Weldon Flat		Diameter		Shank	OAL	Flute Length	Corner Radius	Stock Status
Tool No.	EDP	Tool No.	EDP	Inch	Decimal	D2 h6 Inch	L1 Inch	L2 Inch	R Inch	● Stocked ○ Non-Stocked
278500711B	97318			1/2	.5000	1/2	6	3-1/4	.156	●
27850079B	97319			1/2	.5000	1/2	6	3-1/4	.190	●
278L50000B	37031	278L50000BW	13588	1/2	.5000	1/2	4	2		●
278L50002B	37032	278L50002BW	13589	1/2	.5000	1/2	4	2	.015	●
278L50004B	37033	278L50004BW	13593	1/2	.5000	1/2	4	2	.030	●
278X50000B	37034	278X50000BW	13606	1/2	.5000	1/2	5	3		●
278X50002B	37035	278X50002BW	13607	1/2	.5000	1/2	5	3	.015	●
278X50004B	37036	278X50004BW	13608	1/2	.5000	1/2	5	3	.030	●
27862500B	97321			5/8	.6250	5/8	3	3/4		●
27862502B	97322			5/8	.6250	5/8	3	3/4	.015	●
27862504B	97323			5/8	.6250	5/8	3	3/4	.030	●
27862506B	97324			5/8	.6250	5/8	3	3/4	.060	●
27862507B	97325			5/8	.6250	5/8	3	3/4	.090	●
27862508B	97326			5/8	.6250	5/8	3	3/4	.120	●
278625011B	97327			5/8	.6250	5/8	3	3/4	.156	○
27862509B	97328			5/8	.6250	5/8	3	3/4	.190	○
278625012B	97329			5/8	.6250	5/8	3	3/4	.250	○
27862510B	37039	27862510BW	13609	5/8	.6250	5/8	3-1/2	1-1/4		●
27862512B	37040	27862512BW	13611	5/8	.6250	5/8	3-1/2	1-1/4	.015	●
27862514B	37041	27862514BW	13612	5/8	.6250	5/8	3-1/2	1-1/4	.030	●
27862516B	37042	27862516BW	13613	5/8	.6250	5/8	3-1/2	1-1/4	.060	●
27862518B	37043	27862518BW	13614	5/8	.6250	5/8	3-1/2	1-1/4	.120	●
27862520B	97361			5/8	.6250	5/8	3-1/2	1-5/8		●
27862522B	97362			5/8	.6250	5/8	3-1/2	1-5/8	.015	○
27862524B	97363			5/8	.6250	5/8	3-1/2	1-5/8	.030	○
27862526B	97364			5/8	.6250	5/8	3-1/2	1-5/8	.060	○
27862527B	97365			5/8	.6250	5/8	3-1/2	1-5/8	.090	○
27862528B	97366			5/8	.6250	5/8	3-1/2	1-5/8	.120	○
278625211B	97368			5/8	.6250	5/8	3-1/2	1-5/8	.156	○
27862529B	97367			5/8	.6250	5/8	3-1/2	1-5/8	.190	○
278625212B	97369			5/8	.6250	5/8	3-1/2	1-5/8	.250	○
27862530B	97371			5/8	.6250	5/8	4	2-1/8		○
27862532B	97372			5/8	.6250	5/8	4	2-1/8	.015	○
27862534B	97373			5/8	.6250	5/8	4	2-1/8	.030	●
27862536B	97374			5/8	.6250	5/8	4	2-1/8	.060	○
27862537B	97375			5/8	.6250	5/8	4	2-1/8	.090	○
27862538B	97376			5/8	.6250	5/8	4	2-1/8	.120	○
278625311B	97377			5/8	.6250	5/8	4	2-1/8	.156	○



Series 278 / 278W Continued

5
Flute

ALtima® Blaze		ALtima® Blaze Weldon Flat		Diameter		Shank	OAL	Flute Length	Corner Radius	Stock Status
Tool No.	EDP	Tool No.	EDP	D1		D2 h6	L1	L2	R	• Stocked
				Inch	Decimal	Inch	Inch	Inch	Inch	○ Non-Stocked
27862539B	97378			5/8	.6250	5/8	4	2-1/8	.190	○
278625312B	97379			5/8	.6250	5/8	4	2-1/8	.250	○
27862540B	97391			5/8	.6250	5/8	5	2-5/8		●
27862542B	97392			5/8	.6250	5/8	5	2-5/8	.015	○
27862544B	97393			5/8	.6250	5/8	5	2-5/8	.030	○
27862546B	97394			5/8	.6250	5/8	5	2-5/8	.060	○
27862547B	97395			5/8	.6250	5/8	5	2-5/8	.090	○
27862548B	97396			5/8	.6250	5/8	5	2-5/8	.120	○
278625411B	97397			5/8	.6250	5/8	5	2-5/8	.156	○
27862549B	97398			5/8	.6250	5/8	5	2-5/8	.190	○
278625412B	97399			5/8	.6250	5/8	5	2-5/8	.250	○
27862550B	97381			5/8	.6250	5/8	6	2-1/8		●
27862552B	97382			5/8	.6250	5/8	6	2-1/8	.015	○
27862554B	97383			5/8	.6250	5/8	6	2-1/8	.030	○
27862556B	97384			5/8	.6250	5/8	6	2-1/8	.060	○
27862557B	97385			5/8	.6250	5/8	6	2-1/8	.090	○
27862558B	97386			5/8	.6250	5/8	6	2-1/8	.120	○
278625511B	97387			5/8	.6250	5/8	6	2-1/8	.156	○
27862559B	97388			5/8	.6250	5/8	6	2-1/8	.190	○
278625512B	97389			5/8	.6250	5/8	6	2-1/8	.250	○
27862560B	97401			5/8	.6250	5/8	6	3-1/4		●
27862562B	97402			5/8	.6250	5/8	6	3-1/4	.015	○
27862564B	97403			5/8	.6250	5/8	6	3-1/4	.030	○
27862566B	97404			5/8	.6250	5/8	6	3-1/4	.060	○
27862567B	97405			5/8	.6250	5/8	6	3-1/4	.090	○
27862568B	97406			5/8	.6250	5/8	6	3-1/4	.120	○
278625611B	97407			5/8	.6250	5/8	6	3-1/4	.156	○
27862569B	97408			5/8	.6250	5/8	6	3-1/4	.190	○
278625612B	97409			5/8	.6250	5/8	6	3-1/4	.250	○
27862570B	97411			5/8	.6250	5/8	6	4		●
27862572B	97412			5/8	.6250	5/8	6	4	.015	○
27862574B	97413			5/8	.6250	5/8	6	4	.030	○
27862576B	97414			5/8	.6250	5/8	6	4	.060	○
27862577B	97415			5/8	.6250	5/8	6	4	.090	○
27862578B	97416			5/8	.6250	5/8	6	4	.120	○
278625711B	97417			5/8	.6250	5/8	6	4	.156	○
27862579B	97418			5/8	.6250	5/8	6	4	.190	○
278625712B	97419			5/8	.6250	5/8	6	4	.250	○
278L62500B	37044	278L62500BW	13616	5/8	.6250	5/8	5	2-1/4		●
278L62502B	37045	278L62502BW	13617	5/8	.6250	5/8	5	2-1/4	.015	●
278L62504B	37046	278L62504BW	13618	5/8	.6250	5/8	5	2-1/4	.030	●
278X62500B	37047	278X62500BW	13619	5/8	.6250	5/8	6	3		●
278X62502B	37048	278X62502BW	13621	5/8	.6250	5/8	6	3	.015	●
278X62504B	37049	278X62504BW	13622	5/8	.6250	5/8	6	3	.030	●
27875000B	97421			3/4	.7500	3/4	3	1		●
27875002B	97422			3/4	.7500	3/4	3	1	.015	●
27875004B	97423			3/4	.7500	3/4	3	1	.030	●
27875006B	97424			3/4	.7500	3/4	3	1	.060	●

278 / 278W
TuffCut® XT

HIGH PERFORMANCE



5
Flute

Series 278 / 278W Continued

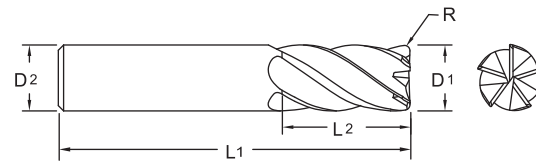

ALtima® Blaze		ALtima® Blaze Weldon Flat		Diameter		Shank	OAL	Flute Length		Corner Radius	Stock Status
Tool No.	EDP	Tool No.	EDP	D1		D2 h6	L1	L2	R	● Stocked	
				Inch	Decimal	Inch	Inch	Inch	Inch	○ Non-Stocked	
27875007B	97425			3/4	.7500	3/4	3	1	.090	●	
27875008B	97426			3/4	.7500	3/4	3	1	.120	●	
278750011B	97427			3/4	.7500	3/4	3	1	.156	○	
27875009B	97428			3/4	.7500	3/4	3	1	.190	○	
278750012B	97429			3/4	.7500	3/4	3	1	.250	○	
27875010B	37052	27875010BW	13623	3/4	.7500	3/4	4	1-1/2		●	
27875012B	37053	27875012BW	13624	3/4	.7500	3/4	4	1-1/2	.015	●	
27875014B	37054	27875014BW	13627	3/4	.7500	3/4	4	1-1/2	.030	●	
27875016B	37055	27875016BW	13628	3/4	.7500	3/4	4	1-1/2	.060	●	
27875018B	37056	27875018BW	13629	3/4	.7500	3/4	4	1-1/2	.120	●	
27875019B	37079	27875019BW	13632	3/4	.7500	3/4	4	1 1/2	.190	●	
27875020B	97461			3/4	.7500	3/4	4	1-5/8		●	
27875022B	97462			3/4	.7500	3/4	4	1-5/8	.015	○	
27875024B	97463			3/4	.7500	3/4	4	1-5/8	.030	○	
27875026B	97464			3/4	.7500	3/4	4	1-5/8	.060	○	
27875027B	97465			3/4	.7500	3/4	4	1-5/8	.090	○	
27875028B	97466			3/4	.7500	3/4	4	1-5/8	.120	○	
278750211B	97467			3/4	.7500	3/4	4	1-5/8	.156	○	
27875029B	97468			3/4	.7500	3/4	4	1-5/8	.190	○	
278750212B	97469			3/4	.7500	3/4	4	1-5/8	.250	○	
27875030B	97471			3/4	.7500	3/4	5	2-3/8		●	
27875032B	97472			3/4	.7500	3/4	5	2-3/8	.015	○	
27875034B	97473			3/4	.7500	3/4	5	2-3/8	.030	○	
27875036B	97474			3/4	.7500	3/4	5	2-3/8	.060	○	
27875037B	97475			3/4	.7500	3/4	5	2-3/8	.090	○	
27875038B	97476			3/4	.7500	3/4	5	2-3/8	.120	○	
278750311B	97477			3/4	.7500	3/4	5	2-3/8	.156	○	
27875039B	97478			3/4	.7500	3/4	5	2-3/8	.190	○	
278750312B	97479			3/4	.7500	3/4	5	2-3/8	.250	○	
27875040B	97481			3/4	.7500	3/4	6	2-3/8		●	
27875042B	97482			3/4	.7500	3/4	6	2-3/8	.015	○	
27875044B	97483			3/4	.7500	3/4	6	2-3/8	.030	○	
27875046B	97484			3/4	.7500	3/4	6	2-3/8	.060	○	
27875047B	97485			3/4	.7500	3/4	6	2-3/8	.090	○	
27875048B	97486			3/4	.7500	3/4	6	2-3/8	.120	○	
278750411B	97487			3/4	.7500	3/4	6	2-3/8	.156	○	
27875049B	97488			3/4	.7500	3/4	6	2-3/8	.190	○	
278750412B	97489			3/4	.7500	3/4	6	2-3/8	.250	○	



Series 278 / 278W Continued

5
Flute

ALtima® Blaze		ALtima® Blaze Weldon Flat		Diameter		Shank	OAL	Flute Length		Corner Radius	Stock Status
Tool No.	EDP	Tool No.	EDP	D1		D2 h6	L1	L2	R	• Stocked	
				Inch	Decimal	Inch	Inch	Inch	Inch	○ Non-Stocked	
27875050B	97491			3/4	.7500	3/4	6	3-1/4		•	
27875052B	97492			3/4	.7500	3/4	6	3-1/4	.015	○	
27875054B	97493			3/4	.7500	3/4	6	3-1/4	.030	○	
27875056B	97494			3/4	.7500	3/4	6	3-1/4	.060	○	
27875057B	97495			3/4	.7500	3/4	6	3-1/4	.090	○	
27875058B	97496			3/4	.7500	3/4	6	3-1/4	.120	○	
278750511B	97497			3/4	.7500	3/4	6	3-1/4	.156	○	
27875059B	97498			3/4	.7500	3/4	6	3-1/4	.190	○	
278750512B	97499			3/4	.7500	3/4	6	3-1/4	.250	○	
27875060B	97501			3/4	.7500	3/4	7	4-1/8		•	
27875062B	97502			3/4	.7500	3/4	7	4-1/8	.015	○	
27875064B	97503			3/4	.7500	3/4	7	4-1/8	.030	○	
27875066B	97504			3/4	.7500	3/4	7	4-1/8	.060	○	
27875067B	97505			3/4	.7500	3/4	7	4-1/8	.090	○	
27875068B	97506			3/4	.7500	3/4	7	4-1/8	.120	○	
278750611B	97507			3/4	.7500	3/4	7	4-1/8	.156	○	
27875069B	97508			3/4	.7500	3/4	7	4-1/8	.190	○	
278750612B	97509			3/4	.7500	3/4	7	4-1/8	.250	○	
278L75000B	37057	278L75000BW	13633	3/4	.7500	3/4	5	2-1/4		•	
278L75002B	37058	278L75002BW	13634	3/4	.7500	3/4	5	2-1/4	.015	•	
278L75004B	37059	278L75004BW	13636	3/4	.7500	3/4	5	2-1/4	.030	•	
278X75000B	37060	278X75000BW	13637	3/4	.7500	3/4	6	3		•	
278X75002B	37061	278X75002BW	13639	3/4	.7500	3/4	6	3	.015	•	
278X75004B	37062	278X75004BW	13656	3/4	.7500	3/4	6	3	.030	•	
27810010B	37065	27810010BW	13657	1	1.0000	1	4	1-1/2		•	
27810014B	37066	27810014BW	13658	1	1.0000	1	4	1-1/2	.030	•	
27810016B	37067	27810016BW	13659	1	1.0000	1	4	1-1/2	.060	•	
27810018B	37068	27810018BW	13677	1	1.0000	1	4	1-1/2	.120	•	
27810019B	37080	27810019BW	14112	1	1.0000	1	4	1-1/2	.190	•	
27810020B	97555			1	1.0000	1	4	1-3/4		•	
27810022B	97556			1	1.0000	1	4	1-3/4	.015	○	
27810024B	97557			1	1.0000	1	4	1-3/4	.030	○	
27810026B	97558			1	1.0000	1	4	1-3/4	.060	○	
27810027B	97559			1	1.0000	1	4	1-3/4	.090	○	
27810028B	97560			1	1.0000	1	4	1-3/4	.120	○	
278100211B	97561			1	1.0000	1	4	1-3/4	.156	○	
27810029B	97562			1	1.0000	1	4	1-3/4	.190	○	
278100212B	97563			1	1.0000	1	4	1-3/4	.250	○	
278100213B	97564			1	1.0000	1	4	1-3/4	.375	○	
27810030B	97566			1	1.0000	1	5	2-5/8		•	
27810032B	97567			1	1.0000	1	5	2-5/8	.015	○	
27810034B	97568			1	1.0000	1	5	2-5/8	.030	○	
27810036B	97569			1	1.0000	1	5	2-5/8	.060	○	
27810037B	97570			1	1.0000	1	5	2-5/8	.090	○	
27810038B	97571			1	1.0000	1	5	2-5/8	.120	○	
278100311B	97572			1	1.0000	1	5	2-5/8	.156	○	

278 / 278W
TuffCut® XT

HIGH PERFORMANCE



5
Flute

Series 278 / 278W Continued

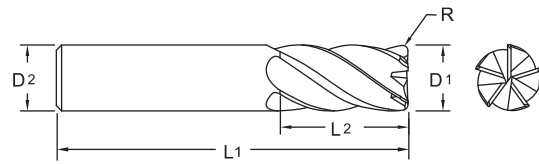

ALtima® Blaze		ALtima® Blaze Weldon Flat		Diameter		Shank	OAL	Flute Length		Corner Radius	Stock Status
Tool No.	EDP	Tool No.	EDP	Inch	Decimal	D2 h6 Inch	L1 Inch	L2 Inch	R Inch	● Stocked	○ Non-Stocked
27810039B	97573			1	1.0000	1	5	2-5/8	.190	○	
278100312B	97574			1	1.0000	1	5	2-5/8	.250	○	
278100313B	97575			1	1.0000	1	5	2-5/8	.375	○	
27810040B	97588			1	1.0000	1	6	3-1/4		●	
27810042B	97589			1	1.0000	1	6	3-1/4	.015	○	
27810044B	97590			1	1.0000	1	6	3-1/4	.030	○	
27810046B	97591			1	1.0000	1	6	3-1/4	.060	○	
27810047B	97592			1	1.0000	1	6	3-1/4	.090	○	
27810048B	97593			1	1.0000	1	6	3-1/4	.120	○	
278100411B	97594			1	1.0000	1	6	3-1/4	.156	○	
27810049B	97595			1	1.0000	1	6	3-1/4	.190	○	
278100412B	97596			1	1.0000	1	6	3-1/4	.250	○	
278100413B	97597			1	1.0000	1	6	3-1/4	.375	○	
27810050B	97599			1	1.0000	1	7	4-1/4		●	
27810052B	97600			1	1.0000	1	7	4-1/4	.015	○	
27810054B	97601			1	1.0000	1	7	4-1/4	.030	○	
27810056B	97602			1	1.0000	1	7	4-1/4	.060	○	
27810057B	97603			1	1.0000	1	7	4-1/4	.090	○	
27810058B	97604			1	1.0000	1	7	4-1/4	.120	○	
278100511B	97605			1	1.0000	1	7	4-1/4	.156	○	
27810059B	97606			1	1.0000	1	7	4-1/4	.190	○	
278100512B	97607			1	1.0000	1	7	4-1/4	.250	○	
278100513B	97608			1	1.0000	1	7	4-1/4	.375	○	
278L10000B	37069	278L10000BW	14113	1	1.0000	1	5	2-1/4		●	
278L10002B	37070	278L10002BW	14114	1	1.0000	1	5	2-1/4	.015	●	
278L10004B	37071	278L10004BW	14115	1	1.0000	1	5	2-1/4	.030	●	
278X10000B	37072	278X10000BW	14116	1	1.0000	1	6	3		●	
278X10002B	37073	278X10002BW	14117	1	1.0000	1	6	3	.015	●	
278X10004B	37074	278X10004BW	14118	1	1.0000	1	6	3	.030	●	



TuffCut® XT Series 278N

Z5



5
Flute

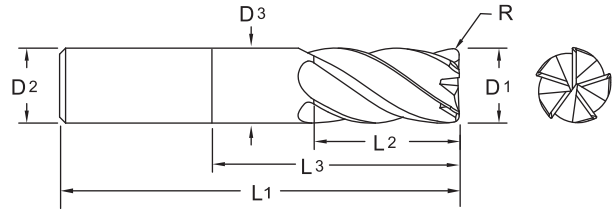

- Improved geometries.
- Enhanced corner protection.

ALtima® Blaze		Diameter			Shank		Neck Diameter		OAL		Flute Length		Neck Length		Corner Radius	
		D1			D2 h6		D3		L1		L2		L3		R	
Tool No.	EDP	Inch	mm	Decimal	Inch	mm	Inch	mm	Inch	mm	Inch	mm	Inch	mm	Inch	mm
278 0300N3-0.25RB	27820		3	.1181		6		2.9		57		8		10		0.25
278 0300N3-0.5RB	27822		3	.1181		6		2.9		57		8		10		0.50
278 0400N3-0.25RB	27824		4	.1575		6		3.9		57		11		13		0.25
278 0400N3-0.5RB	27826		4	.1575		6		3.9		57		11		13		0.50
278 0500N3-0.25RB	27828		5	.1968		6		4.9		57		13		16		0.25
278 0500N3-0.5RB	27830		5	.1968		6		4.9		57		13		16		0.50
278 0600N3-0.25RB	27832		6	.2362		6		5.9		57		13		19		0.25
278 0600N3-0.5RB	27834		6	.2362		6		5.9		57		13		19		0.50
278 0600N3-1.0RB	27836		6	.2362		6		5.9		57		13		19		1.00
27825022NB	37011	1/4		.2500	1/4				4		3/4		2-1/8		0.015	
27825024NB	37012	1/4		.2500	1/4				4		3/4		2-1/8		0.030	
278 0800N3-0.25RB	27837		8	.3150		8		7.8		63		19		25		0.25
278 0800N3-0.5RB	27838		8	.3150		8		7.8		63		19		25		0.50
278 0800N3-1.0RB	27840		8	.3150		8		7.8		63		19		25		1.00
278 0800N3-2.0RB	27842		8	.3150		8		7.8		63		19		25		2.00
27837522NB	37023	3/8		.3750	3/8				4		1		2-1/8		0.015	
27837524NB	37024	3/8		.3750	3/8				4		1		2-1/8		0.030	
278 1000N3-0.5RB	27844		10	.3937		10		9.8		72		22		31		0.50
278 1000N3-1.0RB	27846		10	.3937		10		9.8		72		22		31		1.00
278 1000N3-2.0RB	27848		10	.3937		10		9.8		72		22		31		2.00
278 1200N3-0.5RB	27850		12	.4724		12		11.4		84		26		38		0.50
278 1200N3-1.0RB	27852		12	.4724		12		11.4		84		26		38		1.00
278 1200N3-1.5RB	27854		12	.4724		12		11.4		84		26		38		1.50
278 1200N3-2.5RB	27856		12	.4724		12		11.4		84		26		38		2.50
278 1200N3-3.0RB	27858		12	.4724		12		11.4		84		26		38		3.00
278 1200N3-4.0RB	27860		12	.4724		12		11.4		84		26		38		4.00

Inch	
D1	Tolerance
1/4	+ .000/- .002
>1/4 - 3/4	+ .000/- .003

Metric (mm)	
D1	Tolerance (h10)
3.00	+ .000/- .040
>3.00 - 6.00	+ .000/- .048
>6.00 - 10.00	+ .000/- .058
>10.00 - 18.00	+ .000/- .070
>18.00 - 25.00	+ .000/- .084

Inch	
D2	Tolerance (h6)
.1182 - .2362	+0/- .00031
.2363 - .3937	+0/- .00035
.3938 - .7087	+0/- .00043
.7088 - .7500	+0/- .00051

Metric (mm)	
D2	Tolerance (h6)
6.0	+0/- .008
6.01 - 10.0	+0/- .009
10.01 - 18.0	+0/- .011
18.01 - 25.0	+0/- .013

Inch	
R	Tolerance
1/4 - 3/4	+ .0000/- .0016

Metric (mm)	
R	Tolerance
3.0 - 25.0	+ .00/- .04



5
Flute

Series 278N Continued

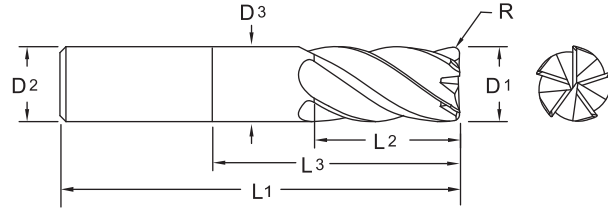

ALtima® Blaze		Diameter			Shank		Neck Diameter		OAL		Flute Length		Neck Length		Corner Radius	
		D1			D2 h6		D3		L1		L2		L3		R	
Tool No.	EDP	Inch	mm	Decimal	Inch	mm	Inch	mm	Inch	mm	Inch	mm	Inch	mm	Inch	mm
27850022NB	37037	1/2		.5000	1/2				4		1-1/4		2-1/8		0.015	
27850024NB	37038	1/2		.5000	1/2				4		1-1/4		2-1/8		0.030	
27862522NB	37050	5/8		.6250	5/8				4		1-1/2		2-1/8		0.015	
27862524NB	37051	5/8		.6250	5/8				4		1-1/2		2-1/8		0.030	
278 1600N3-0.5RB	27870		16	.6299		16		15.2		100		35		50		0.50
278 1600N3-1.0RB	27872		16	.6299		16		15.2		100		35		50		1.00
278 1600N3-1.5RB	27874		16	.6299		16		15.2		100		35		50		1.50
278 1600N3-2.5RB	27876		16	.6299		16		15.2		100		35		50		2.50
278 1600N3-3.0RB	27878		16	.6299		16		15.2		100		35		50		3.00
278 1600N3-4.0RB	27880		16	.6299		16		15.2		100		35		50		4.00
278 1600N4-1.0RB	27871		16	.6299		16		15.2		117		35		65		1.00
278 1600N4-3.0RB	27873		16	.6299		16		15.2		117		35		65		3.00
278 1600N5-1.0RB	27875		16	.6299		16		15.2		133		35		82		1.00
278 1600N5-3.0RB	27877		16	.6299		16		15.2		133		35		82		3.00
27875022NB	37063	3/4		.7500	3/4				5		1-7/8		3		0.015	
27875024NB	37064	3/4		.7500	3/4				5		1-7/8		3		0.030	
278 2000N3-1.0RB	27890		20	.7874		20		19.2		112		40		62		1.00
278 2000N3-2.0RB	27906		20	.7874		20		19.2		112		40		62		2.00
278 2000N3-3.0RB	27892		20	.7874		20		19.2		112		40		62		3.00
278 2000N3-4.0RB	27894		20	.7874		20		19.2		112		40		62		4.00
278 2000N4-1.0RB	27891		20	.7874		20		19.2		133		40		82		1.00
278 2000N4-3.0RB	27893		20	.7874		20		19.2		133		40		82		3.00
278 2000N5-1.0RB	27895		20	.7874		20		19.2		152		40		102		1.00
278 2000N5-3.0RB	27897		20	.7874		20		19.2		152		40		102		3.00
278 2500N3-1.0RB	27896		25	.9843		25		24.6		127		40		77		1.00
278 2500N3-3.0RB	27898		25	.9843		25		24.6		127		40		77		3.00
278 2500N3-4.0RB	27900		25	.9843		25		24.6		127		40		77		4.00
278 2500N4-1.0RB	27899		25	.9843		25		24.6		152		40		102		1.00
278 2500N4-3.0RB	27901		25	.9843		25		24.6		152		40		102		3.00
278 2500N5-1.0RB	27902		25	.9843		25		24.6		180		40		125		1.00
278 2500N5-3.0RB	27903		25	.9843		25		24.6		180		40		125		3.00



ISO 9001:2008 Certified



NEW

TuffCut® XT Series 279

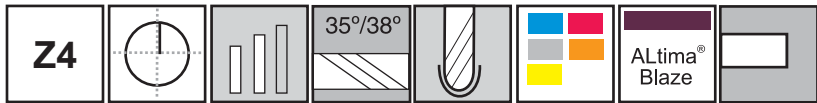

4 Flute Ball



- ALtima® Blaze coated.
- Enhanced cutting edge quality.
- Variable helix and flute spacing for improved machining harmonics.

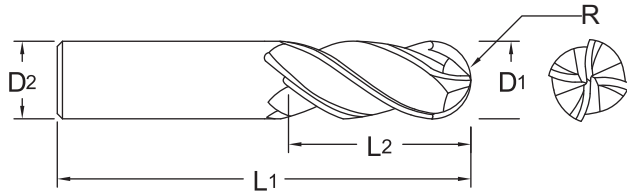

ALtima® Blaze		Diameter			Shank		OAL		Flute Length	
		D1			D2 h6		L1		L2	
Tool Number	EDP	Fraction	mm	Decimal	Inch	mm	Inch	mm	Inch	mm
279M0300B	27938		3	.1181		6		57		8
27912500B	27910	1/8		.1250	1/8		1-1/2		1/4	
27912510B	27912	1/8		.1250	1/8		1-1/2		3/8	
279M0400B	27940		4	.1575		6		57		11
27918700B	27914	3/16		.1875	3/16		2		3/8	
27918710B	27916	3/16		.1875	3/16		2		5/8	
279M0500B	27942		5	.1968		6		57		13
279M0600B	27944		6	.2362		6		57		13
27925000B	27918	1/4		.2500	1/4		2		3/8	
27925010B	27920	1/4		.2500	1/4		2-1/2		3/4	
27931200B	27922	5/16		.3125	5/16		2		1/2	
27931210B	27924	5/16		.3125	5/16		2-1/2		13/16	
279M0800B	27946		8	.3150		8		63		19
27937500B	27926	3/8		.3750	3/8		2		1/2	
27937510B	27928	3/8		.3750	3/8		2-1/2		7/8	
279M1000B	27948		10	.3937		10		72		22
279M1200B	27950		12	.4724		12		83		26
27950000B	27930	1/2		.5000	1/2		2-1/2		5/8	
27950010B	27932	1/2		.5000	1/2		3		1-1/4	
27962510B	27934	5/8		.6250	5/8		3-1/2		1-1/4	
279M1600B	27952		16	.6299		16		92		32
27975010B	27936	3/4		.7500	3/4		4		1-1/2	



Page 316, 320

Inch	
D1	Tolerance
1/16 - 1/4	+0/-0.002
> 1/4 - 3/4	+0/-0.003

Metric (mm)	
D1	Tolerance h10
3.00	+0/-0.040
>3.00 - 6.00	+0/-0.048
>6.00 - 10.00	+0/-0.058
>10.00 - 16.00	+0/-0.070

Inch	
D2	Tolerance (h6)
.1182 - .2362	+0/-0.00031
.2363 - .3937	+0/-0.00035
.3938 - .7087	+0/-0.00043
.7088 - .7500	+0/-0.00051

Metric (mm)	
D2	Tolerance (h6)
3	+0/-0.006
3.01 - 6.0	+0/-0.008
6.01 - 10.0	+0/-0.009
10.01 - 16.0	+0/-0.011

Inch	
R	Tolerance
1/8 - 3/4	+0/-0.001

Metric (mm)	
R	Tolerance
3.0 - 16.0	+0/-0.025

278N / 279
TuffCut® XT

HIGH PERFORMANCE

7
Flute

TuffCut® XR7 Series 180



40% increase in productivity over a 5 flute tool.



- Designed specifically for Titanium, Inconel and similar materials.
- ALtima® Blaze coating for increased performance.

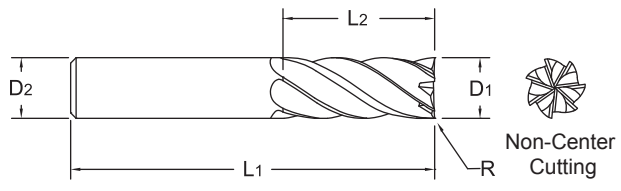

For Long and X-Long lengths see Series 180CB Chipbreaker on page 198.

ALtima® Blaze		Diameter			Shank		OAL		Flute Length		Corner Radius	
		D1			D2 h6		L1		L2		R	
Tool No.	EDP	Inch	mm	Decimal	Inch	mm	Inch	mm	Inch	mm	Inch	mm
18023600B	18936		6	.2362		6		57		13		
18023601B	18938		6	.2362		6		57		13		0.5
18025000B	18900	1/4		.2500	1/4		2		3/8			
18025002B	18901	1/4		.2500	1/4		2		3/8		.015	
18025010B	18902	1/4		.2500	1/4		2-1/2		3/4			
18025012B	18903	1/4		.2500	1/4		2-1/2		3/4		.015	
18031500B	18944		8	.3150		8		63		19		
18031501B	18946		8	.3150		8		63		19		0.5
18037500B	18908	3/8		.3750	3/8		2-1/2		1/2			
18037502B	18909	3/8		.3750	3/8		2-1/2		1/2		.015	
18037504B	18932	3/8		.3750	3/8		2-1/2		1/2		.030	
18037510B	18910	3/8		.3750	3/8		2-1/2		1			
18037512B	18911	3/8		.3750	3/8		2-1/2		1		.015	
18037514B	18934	3/8		.3750	3/8		2-1/2		1		.030	
18039300B	18940		10	.3937		10		72		22		
18039301B	18942		10	.3937		10		72		22		0.5
18047201B	18501		12	.4724		12		84		32		0.5
18047203B	18503		12	.4724		12		84		32		1.0
18047205B	18505		12	.4724		12		84		32		2.0
18047207B	18507		12	.4724		12		84		32		3.0
18047209B	18508		12	.4724		12		84		32		4.0
18050000B	18512	1/2		.5000	1/2		3		5/8			
18050002B	18515	1/2		.5000	1/2		3		5/8		.015	
18050004B	18517	1/2		.5000	1/2		3		5/8		.030	
18050006B	18519	1/2		.5000	1/2		3		5/8		.060	
18050007B	18521	1/2		.5000	1/2		3		5/8		.090	
18050008B	18523	1/2		.5000	1/2		3		5/8		.125	
18050010B	18514	1/2		.5000	1/2		3		1-1/4			
18050012B	18516	1/2		.5000	1/2		3		1-1/4		.015	
18050014B	18518	1/2		.5000	1/2		3		1-1/4		.030	
18050016B	18520	1/2		.5000	1/2		3		1-1/4		.060	
18050017B	18522	1/2		.5000	1/2		3		1-1/4		.090	
18050018B	18524	1/2		.5000	1/2		3		1-1/4		.125	
18062500B	18532	5/8		.6250	5/8		3-1/2		3/4			
18062502B	18535	5/8		.6250	5/8		3-1/2		3/4		.015	
18062504B	18537	5/8		.6250	5/8		3-1/2		3/4		.030	

Inch	
D1	Tolerance
1/4 - 1.0	+0.000/-0.0011

Metric (mm)	
D1	Tolerance
12.00 - 20.00	+0.000/-0.028

Inch	
D2	Tolerance (h6)
.2363 - .3937	+0/-0.00035
.3938 - .7087	+0/-0.00043
.7088 - 1.000	+0/-0.00051

Metric (mm)	
D2	Tolerance (h6)
12.00 - 18.0	+0/-0.011
18.01 - 20.0	+0/-0.013

Inch	
R	Tolerance
1/4 - 1	+0.001/-0.001

Metric (mm)	
R	Tolerance
6.0 - 20.0	+0.025/-0.025

ALtima® Blaze

Featuring high temperature hardness and oxidation resistance that provides extreme wear resistance under all machining conditions

Coating Properties

Micro Hardness (HV)	3200
Max. Working Temperature	1100°C 2012°F
Friction Coefficient	0.35



Series 180 Continued

7
Flute

ALtima® Blaze		Diameter			Shank		OAL		Flute Length		Corner Radius	
		D1			D2 h6		L1		L2		R	
Tool No.	EDP	Inch	mm	Decimal	Inch	mm	Inch	mm	Inch	mm	Inch	mm
18062506B	18539	5/8		.6250	5/8		3-1/2		3/4		.060	
18062507B	18541	5/8		.6250	5/8		3-1/2		3/4		.090	
18062508B	18543	5/8		.6250	5/8		3-1/2		3/4		.125	
18062510B	18534	5/8		.6250	5/8		3-1/2		1-1/4			
18062512B	18536	5/8		.6250	5/8		3-1/2		1-1/4		.015	
18062514B	18538	5/8		.6250	5/8		3-1/2		1-1/4		.030	
18062516B	18540	5/8		.6250	5/8		3-1/2		1-1/4		.060	
18062517B	18542	5/8		.6250	5/8		3-1/2		1-1/4		.090	
18062518B	18544	5/8		.6250	5/8		3-1/2		1-1/4		.125	
18062901B	18509		16	.6299		16		92		42		0.5
18062903B	18510		16	.6299		16		92		42		1.0
18062905B	18511		16	.6299		16		92		42		2.0
18062907B	18513		16	.6299		16		92		42		3.0
18062909B	18527		16	.6299		16		92		42		4.0
18075000B	18570	3/4		.7500	3/4		4		1			
18075002B	18573	3/4		.7500	3/4		4		1		.015	
18075004B	18575	3/4		.7500	3/4		4		1		.030	
18075006B	18577	3/4		.7500	3/4		4		1		.060	
18075007B	18579	3/4		.7500	3/4		4		1		.090	
18075008B	18581	3/4		.7500	3/4		4		1		.125	
18075009B	18583	3/4		.7500	3/4		4		1		.190	
180750012B	18585	3/4		.7500	3/4		4		1		.250	
18075010B	18572	3/4		.7500	3/4		4		1-1/2			
18075012B	18574	3/4		.7500	3/4		4		1-1/2		.015	
18075014B	18576	3/4		.7500	3/4		4		1-1/2		.030	
18075016B	18578	3/4		.7500	3/4		4		1-1/2		.060	
18075017B	18580	3/4		.7500	3/4		4		1-1/2		.090	
18075018B	18582	3/4		.7500	3/4		4		1-1/2		.125	
18075019B	18584	3/4		.7500	3/4		4		1-1/2		.190	
180750112B	18586	3/4		.7500	3/4		4		1-1/2		.250	
18078701B	18528		20	.7874		20		102		52		0.5
18078703B	18529		20	.7874		20		102		52		1.0
18078705B	18530		20	.7874		20		102		52		2.0
18078707B	18531		20	.7874		20		102		52		3.0
18078709B	18533		20	.7874		20		102		52		4.0
18010000B	18597	1		1.0000	1		4		1			
18010002B	18599	1		1.0000	1		4		1		.015	
18010004B	18601	1		1.0000	1		4		1		.030	
18010006B	18603	1		1.0000	1		4		1		.060	
18010007B	18615	1		1.0000	1		4		1		.090	
18010008B	18607	1		1.0000	1		4		1		.125	
18010009B	18609	1		1.0000	1		4		1		.190	
180100012B	18611	1		1.0000	1		4		1		.250	
18010010B	18598	1		1.0000	1		4		1-1/2			
18010012B	18613	1		1.0000	1		4		1-1/2		.015	
18010014B	18602	1		1.0000	1		4		1-1/2		.030	

180
TuffCut® XR7

HIGH PERFORMANCE



7
Flute

Series 180 Continued

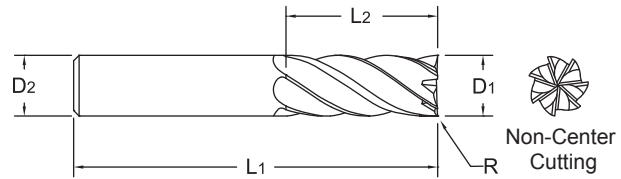

ALtima® Blaze		Diameter			Shank		OAL		Flute Length		Corner Radius	
		D1			D2 h6		L1		L2		R	
Tool No.	EDP	Inch	mm	Decimal	Inch	mm	Inch	mm	Inch	mm	Inch	mm
18010016B	18604	1		1.0000	1		4		1-1/2		.060	
18010017B	18606	1		1.0000	1		4		1-1/2		.090	
18010018B	18608	1		1.0000	1		4		1-1/2		.125	
18010019B	18616	1		1.0000	1		4		1-1/2		.190	
180100112B	18612	1		1.0000	1		4		1-1/2		.250	



Go Green with **RED BOX**



Extend the Life of Your Cutting Tools with M.A. Ford®'s Reconditioning Service.

See page 470 for more information or Call 800-553-8024 or 563-391-6220



TuffCut® XR7 Series 180N



7 Flute

180 / 180N
TuffCut® XR7

40% increase in productivity over a 5 flute tool.

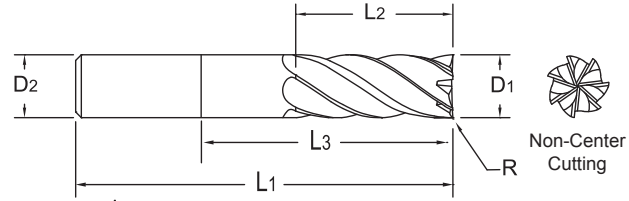

- Designed specifically for Titanium, Inconel and similar materials.
- ALtima® Blaze coating for increased performance.

ALtima® Blaze		Diameter			Shank		OAL		Flute Length		Neck Length		Corner Radius	
		D1			D2 h6		L1		L2		L3		R	
Tool No.	EDP	Inch	mm	Decimal	Inch	mm	Inch	mm	Inch	mm	Inch	mm	Inch	mm
18047203NB	18500		12.0	.4724		12.0		120		30		60		1.0
18047205NB	18502		12.0	.4724		12.0		120		30		60		2.0
18047207NB	18504		12.0	.4724		12.0		120		30		60		3.0
18047209NB	18506		12.0	.4724		12.0		120		30		60		4.0
18050024NB	18526	1/2		.5000	1/2		4		1-1/4		2-1/8		.030	
18062524NB	18546	5/8		.6250	5/8		4		1-1/4		2-1/8		.030	
18062903NB	18548		16.0	.6299		16.0		150		40		80		1.0
18062905NB	18550		16.0	.6299		16.0		150		40		80		2.0
18062907NB	18552		16.0	.6299		16.0		150		40		80		3.0
18062909NB	18554		16.0	.6299		16.0		150		40		80		4.0
18075024NB	18588	3/4		.7500	3/4		5		1-7/8		3		.030	
18078713NB	18590		20.0	.7874		20.0		150		50		100		1.0
18078715NB	18592		20.0	.7874		20.0		150		50		100		2.0
18078717NB	18594		20.0	.7874		20.0		150		50		100		3.0
18078719NB	18596		20.0	.7874		20.0		150		50		100		4.0
180100205NB	18614	1		1.0000	1		6		3		4		.045	

TECH
Page 318

HIGH PERFORMANCE

Inch	
D1	Tolerance
1/2 - 1.0	+0.000/-0.0011

Metric (mm)	
D1	Tolerance
12.00 - 20.00	+0.000/-0.028

Inch	
D2	Tolerance (h6)
.5000 - .7087	+0/-0.00043
.7088 - 1.000	+0/-0.00051

Metric (mm)	
D2	Tolerance (h6)
12.00 - 18.0	+0/-0.011
18.01 - 20.0	+0/-0.013

Inch	
R	Tolerance
1/4 - 1	+0.001/-0.001

Metric (mm)	
R	Tolerance
6.0 - 20.0	+0.025/-0.025

7
Flute
NEW

**TuffCut® XR7
Series 180CB Chipbreaker**

Z7 **ALtima® Blaze**



Close-up of chipbreaker grind

- Long and X-Long lengths now with chipbreaker
- Higher feed rates allowed
- Cutting forces minimized resulting in straighter walls on long axial engagements
- Chatter reduced or eliminated
- Prolongs life of tool by reducing re-cutting of chips
- Creates shorter chips that can be evacuated more easily

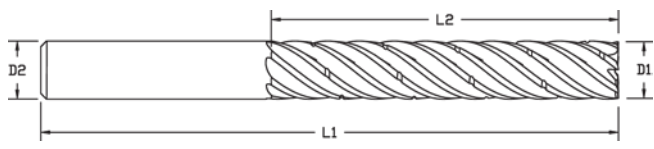

ALtima® Blaze		Diameter		Shank	OAL	Flute Length	
		D1		D2 h6	L1	L2	
Tool No.	EDP	Inch	Decimal	Inch	Inch	Inch	
180L2500B	18904	1/4	.2500	1/4	3	1-1/4	
180X2500B	18906	1/4	.2500	1/4	4	1-3/4	
180L3750B	18912	3/8	.3750	3/8	4	1-1/2	
180X3750B	18914	3/8	.3750	3/8	4	2-1/2	
180L5000B	18916	1/2	.5000	1/2	4	2	
180X5000B	18918	1/2	.5000	1/2	5	3	
180L6250B	18920	5/8	.6250	5/8	5	2-1/4	
180X6250B	18922	5/8	.6250	5/8	6	3	
180L7500B	18924	3/4	.7500	3/4	5	2-1/4	
180X7500B	18926	3/4	.7500	3/4	6	3	
180L1000B	18928	1	1.0000	1	5	2-1/4	
180X1000B	18930	1	1.0000	1	6	3	



Inch	
D1	Tolerance
1/4 - 1.0	+0.00/-0.0011

Inch	
D2	Tolerance (h6)
.2363 - .3937	+0/-0.00035
.3938 - .7087	+0/-0.00043
.7088 - 1.000	+0/-0.00051

NEW

**TuffCut® XR
Series 177 / 177W**



**4
Flute**

Designed for EXTREME Productivity. Unique flute geometry reduces harmonics at increased feeds and speeds.

New-Standard Offering with Weldon Shank Flats

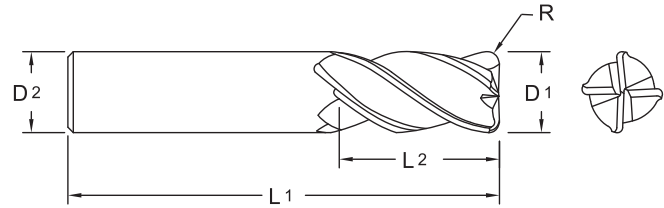

180CB / 177 / 177W
TuffCut® XR7 / XR

HIGH PERFORMANCE

ALtima®		ALtima® Weldon Flat		Diameter			Shank		OAL		Flute Length		Corner Radius	
Tool No.	EDP	Tool No.	EDP	D1			D2 h6		L1		L2		R	
				Inch	mm	Decimal	Inch	mm	Inch	mm	Inch	mm	Inch	mm
17705900A	17680				1.5	.0591		3.0		38		3.0		
17706250A	17692			1/16		.0625	1/8		1-1/2		1/8			
17707810A	17694			5/64		.0781	1/8		1-1/2		5/32			
17707870A	17682				2.0	.0787		3.0		38		4.0		
17709370A	17696			3/32		.0937	1/8		1-1/2		3/16			
17709840A	17684				2.5	.0984		3.0		38		5.0		
17711800A	17928				3.0	.1181		6.0		57		8.0		
17711801A	17783				3.0	.1181		6.0		57		8.0		0.50
17711803A	17686				3.0	.1181		3.0		38		6.0		
17711808A	17929				3.0	.1181		6.0		57		8.0		0.25
17712500A	17700			1/8		.1250	1/8		1-1/2		1/8			
17712502A	17729			1/8		.1250	1/8		1-1/2		1/8		0.015	
17712510A	17701			1/8		.1250	1/8		1-1/2		3/8			
17712512A	17730			1/8		.1250	1/8		1-1/2		3/8		0.015	
17713700A	17688				3.5	.1378		6.0		57		7.0		
17715600A	17702			5/32		.1562	3/16		2		3/16			
17715602A	17731			5/32		.1562	3/16		2		3/16		0.015	
17715610A	17703			5/32		.1562	3/16		2		7/16			
17715612A	17732			5/32		.1562	3/16		2		7/16		0.015	
17715700A	17930				4.0	.1575		6.0		57		11.0		
17715701A	17784				4.0	.1575		6.0		57		11.0		0.50
17715708A	17931				4.0	.1575		6.0		57		11.0		0.25
17717700A	17690				4.5	.1772		6.0		57		9.0		
17718700A	17704			3/16		.1875	3/16		2		3/16			

Inch	
D1	Tolerance
1/16 - 1/4	+0.000/-0.002
> 1/4 - 1.0	+0.000/-0.003

Metric (mm)	
D1	Tolerance (h10)
1.50 - 3.00	+0.000/-0.040
>3.00 - 6.00	+0.000/-0.048
>6.00 - 10.00	+0.000/-0.058
>10.00 - 18.00	+0.000/-0.070
>18.00 - 25.00	+0.000/-0.084

Inch	
D2	Tolerance (h6)
.1182 - .2362	+0/-0.00031
.2363 - .3937	+0/-0.00035
.3938 - .7087	+0/-0.00043
.7088 - 1.000	+0/-0.00051

Metric (mm)	
D2	Tolerance (h6)
3.0	+0/-0.006
3.01 - 6.0	+0/-0.008
6.01 - 10.0	+0/-0.009
10.01 - 18.0	+0/-0.011
18.01 - 25.0	+0/-0.013

Inch	
R	Tolerance
1/8 - 1	+0.0000/-0.0016

Metric (mm)	
R	Tolerance
3.0 - 25.0	+0.00/-0.04



4
Flute

Series 177 / 177W Continued

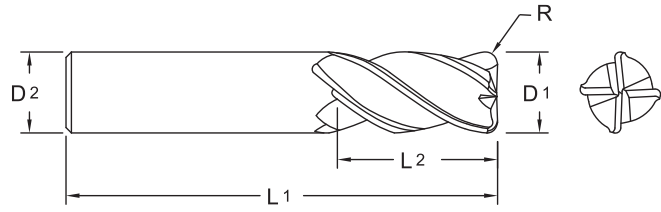

ALtima®		ALtima® Weldon Flat		Diameter			Shank		OAL		Flute Length		Corner Radius	
Tool No.	EDP	Tool No.	EDP	D1			D2 h6		L1		L2		R	
				Inch	mm	Decimal	Inch	mm	Inch	mm	Inch	mm	Inch	mm
17718702A	17733			3/16		.1875	3/16		2		3/16		0.015	
17718704A	17734			3/16		.1875	3/16		2		3/16		0.030	
17718710A	17705			3/16		.1875	3/16		2		7/16			
17718712A	17735			3/16		.1875	3/16		2		7/16		0.015	
17718714A	17736			3/16		.1875	3/16		2		7/16		0.030	
17719600A	17932				5.0	.1968		6.0		57		13.0		
17719601A	17785				5.0	.1968		6.0		57		13.0		0.50
17719608A	17933				5.0	.1968		6.0		57		13.0		0.25
17721800A	17706			7/32		.2187	1/4		2		1/4			
17721802A	17737			7/32		.2187	1/4		2		1/4		0.015	
17721804A	17738			7/32		.2187	1/4		2		1/4		0.030	
17721810A	17707			7/32		.2187	1/4		2-1/2		7/16			
17721812A	17739			7/32		.2187	1/4		2-1/2		7/16		0.015	
17721814A	17740			7/32		.2187	1/4		2-1/2		7/16		0.030	
17723600A	17934				6.0	.2362		6.0		57		13.0		
17723608A	17786				6.0	.2362		6.0		57		13.0		0.25
17723601A	17935				6.0	.2362		6.0		57		13.0		0.50
17723603A	17787				6.0	.2362		6.0		57		13.0		1.00
17723604A	17788				6.0	.2362		6.0		57		13.0		1.50
17723605A	18070				6.0	.2362		6.0		57		13.0		2.00
17725000A	17708			1/4		.2500	1/4		2		1/4			
17725002A	17741			1/4		.2500	1/4		2		1/4		0.015	
17725004A	17742			1/4		.2500	1/4		2		1/4		0.030	
17725010A	17709			1/4		.2500	1/4		2-1/2		1/2			
17725012A	17743			1/4		.2500	1/4		2-1/2		1/2		0.015	
17725014A	17744			1/4		.2500	1/4		2-1/2		1/2		0.030	
17728100A	17710			9/32		.2812	5/16		2-1/2		5/8			
17728102A	17745			9/32		.2812	5/16		2-1/2		5/8		0.015	
17728104A	17746			9/32		.2812	5/16		2-1/2		5/8		0.030	
17731200A	17711			5/16		.3125	5/16		2		5/16			
17731202A	17747			5/16		.3125	5/16		2		5/16		0.015	
17731204A	17748			5/16		.3125	5/16		2		5/16		0.030	
17731210A	17712			5/16		.3125	5/16		2-1/2		13/16			
17731212A	17749			5/16		.3125	5/16		2-1/2		13/16		0.015	
17731214A	17750			5/16		.3125	5/16		2-1/2		13/16		0.030	
17731500A	17937				8.0	.3150		8.0		63		19.0		



Series 177 / 177W Continued

4
Flute

177 / 177W
TuffCut® XR

HIGH PERFORMANCE

ALtima®		ALtima® Weldon Flat		Diameter			Shank		OAL		Flute Length		Corner Radius	
Tool No.	EDP	Tool No.	EDP	D1			D2 h6		L1		L2		R	
				Inch	mm	Decimal	Inch	mm	Inch	mm	Inch	mm	Inch	mm
17731501A	17938				8.0	.3150		8.0		63		19.0		0.50
17731503A	17789				8.0	.3150		8.0		63		19.0		1.00
17731504A	17790				8.0	.3150		8.0		63		19.0		1.50
17731505A	17791				8.0	.3150		8.0		63		19.0		2.00
17731507A	18072				8.0	.3150		8.0		63		19.0		3.00
17734300A	17713			11/32		.3438	3/8		2-1/2		13/16			
17734302A	17751			11/32		.3438	3/8		2-1/2		13/16		0.015	
17734304A	17752			11/32		.3438	3/8		2-1/2		13/16		0.030	
17737500A	17714			3/8		.3750	3/8		2		3/8			
17737502A	17753			3/8		.3750	3/8		2		3/8		0.015	
17737504A	17754			3/8		.3750	3/8		2		3/8		0.030	
17737510A	17715			3/8		.3750	3/8		2-1/2		7/8			
17737512A	17755			3/8		.3750	3/8		2-1/2		7/8		0.015	
17737514A	17756			3/8		.3750	3/8		2-1/2		7/8		0.030	
17739300A	17940				10.0	.3937		10.0		72		22.0		
17739301A	17941				10.0	.3937		10.0		72		22.0		0.50
17739303A	17792				10.0	.3937		10.0		72		22.0		1.00
17739304A	17793				10.0	.3937		10.0		72		22.0		1.50
17739305A	17794				10.0	.3937		10.0		72		22.0		2.00
17739307A	96603				10.0	.3937		10.0		72		22.0		3.00
17740600A	17716			13/32		.4062	7/16		2-3/4		15/16			
17740602A	17757			13/32		.4062	7/16		2-3/4		15/16		0.015	
17740604A	17758			13/32		.4062	7/16		2-3/4		15/16		0.030	
17743700A	17717			7/16		.4375	7/16		2-1/2		7/16			
17743702A	17759			7/16		.4375	7/16		2-1/2		7/16		0.015	
17743704A	17760			7/16		.4375	7/16		2-1/2		7/16		0.030	
17743710A	17718			7/16		.4375	7/16		2-3/4		1			
17743712A	17761			7/16		.4375	7/16		2-3/4		1		0.015	
17743714A	17762			7/16		.4375	7/16		2-3/4		1		0.030	
17746800A	17719			15/32		.4688	1/2		3		1			
17746802A	17763			15/32		.4688	1/2		3		1		0.015	
17746804A	17764			15/32		.4688	1/2		3		1		0.030	
17747200A	17943				12.0	.4724		12.0		83		26.0		
17747201A	17795				12.0	.4724		12.0		83		26.0		0.50
17747202A	17944				12.0	.4724		12.0		83		26.0		0.75
17747203A	17796				12.0	.4724		12.0		83		26.0		1.00
17747204A	17797				12.0	.4724		12.0		83		26.0		1.50
17747205A	17798				12.0	.4724		12.0		83		26.0		2.00
17747206A	18074				12.0	.4724		12.0		83		26.0		2.50
17747207A	96506				12.0	.4724		12.0		83		26.0		3.00
17747209A	18076				12.0	.4724		12.0		83		26.0		4.00
17750000A	17720	17750000AW	13166	1/2		.5000	1/2		2-1/2		1/2			
17750002A	17765	17750002AW	13167	1/2		.5000	1/2		2-1/2		1/2		0.015	
17750004A	17766	17750004AW	13168	1/2		.5000	1/2		2-1/2		1/2		0.030	
17750010A	17721	17750010AW	58038	1/2		.5000	1/2		3		1			
17750012A	17767	17750012AW	13169	1/2		.5000	1/2		3		1		0.015	



4
Flute

Series 177 / 177W Continued

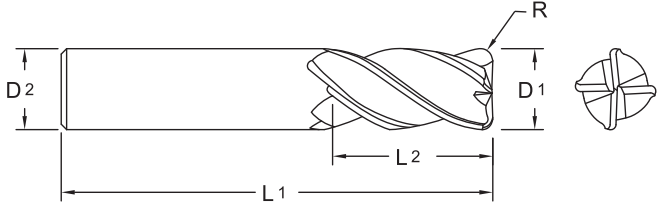

ALtima®		ALtima® Weldon Flat		Diameter			Shank		OAL		Flute Length		Corner Radius	
Tool No.	EDP	Tool No.	EDP	D1			D2 h6		L1		L2		R	
				Inch	mm	Decimal	Inch	mm	Inch	mm	Inch	mm	Inch	mm
17750014A	17768	17750014AW	58039	1/2		.5000	1/2		3		1		0.030	
17750016A	17901	17750016AW	58061	1/2		.5000	1/2		3		1		0.060	
17750017A	17902	17750017AW	13170	1/2		.5000	1/2		3		1		0.090	
17750018A	17903	17750018AW	13171	1/2		.5000	1/2		3		1		0.125	
17750020A	18094	17750020AW	58056	1/2		.5000	1/2		3		1-1/4			
17750022A	18095	17750022AW	13172	1/2		.5000	1/2		3		1-1/4		.015	
17750024A	18096	17750024AW	58051	1/2		.5000	1/2		3		1-1/4		.030	
17750026A	18097	17750026AW	12610	1/2		.5000	1/2		3		1-1/4		.060	
17750027A	18098	17750027AW	13173	1/2		.5000	1/2		3		1-1/4		.090	
17750028A	18099	17750028AW	13174	1/2		.5000	1/2		3		1-1/4		.125	
17755100A	17946				14.0	.5512		14.0		83		26.0		
17755102A	17947				14.0	.5512		14.0		83		26.0		0.75
17756200A	17722			9/16		.5625	9/16		3-1/2		1-1/8			
17756202A	17769			9/16		.5625	9/16		3-1/2		1-1/8		0.015	
17756204A	17770			9/16		.5625	9/16		3-1/2		1-1/8		0.030	
17762500A	17723	17762500AW	13175	5/8		.6250	5/8		3		5/8			
17762502A	18000	17762502AW	13176	5/8		.6250	5/8		3		5/8		0.015	
17762504A	17771	17762504AW	13177	5/8		.6250	5/8		3		5/8		0.030	
17762505A	17772	17762505AW	13178	5/8		.6250	5/8		3		5/8		0.045	
17762510A	17724	17762510AW	58040	5/8		.6250	5/8		3-1/2		1-1/4			
17762512A	18001	17762512AW	13179	5/8		.6250	5/8		3-1/2		1-1/4		0.015	
17762514A	17773	17762514AW	58041	5/8		.6250	5/8		3-1/2		1-1/4		0.030	
17762515A	17774	17762515AW	13180	5/8		.6250	5/8		3-1/2		1-1/4		0.045	
17762516A	17904	17762516AW	13181	5/8		.6250	5/8		3-1/2		1-1/4		0.060	
17762517A	17905	17762517AW	13182	5/8		.6250	5/8		3-1/2		1-1/4		0.090	
17762518A	17906	17762518AW	13183	5/8		.6250	5/8		3-1/2		1-1/4		0.125	
17762900A	17950				16.0	.6299		16.0		92		32.0		
17762901A	18078				16.0	.6299		16.0		92		32.0		0.50
17762903A	17951				16.0	.6299		16.0		92		32.0		1.00
17762904A	17799				16.0	.6299		16.0		92		32.0		1.50
17762905A	17673				16.0	.6299		16.0		92		32.0		2.00
17762906A	18080				16.0	.6299		16.0		92		32.0		2.50
17762907A	17674				16.0	.6299		16.0		92		32.0		3.00
17762909A	18082				16.0	.6299		16.0		92		32.0		4.00
17770800A	17952				18.0	.7087		18.0		92		32.0		
17770803A	17953				18.0	.7087		18.0		92		32.0		1.00



Series 177 / 177W Continued

4
Flute

ALtima®		ALtima® Weldon Flat		Diameter			Shank		OAL		Flute Length		Corner Radius	
Tool No.	EDP	Tool No.	EDP	D1			D2 h6		L1		L2		R	
Tool No.	EDP	Tool No.	EDP	Inch	mm	Decimal	Inch	mm	Inch	mm	Inch	mm	Inch	mm
17775000A	17725	17775000AW	13184	3/4		.7500	3/4		3		3/4			
17775002A	18002	17775002AW	13185	3/4		.7500	3/4		3		3/4		0.015	
17775004A	17775	17775004AW	13186	3/4		.7500	3/4		3		3/4		0.030	
17775005A	17776	17775005AW	14590	3/4		.7500	3/4		3		3/4		0.045	
17775010A	17726	17775010AW	58042	3/4		.7500	3/4		4		1-1/2			
17775012A	18003	17775012AW	13187	3/4		.7500	3/4		4		1-1/2		0.015	
17775014A	17777	17775014AW	58043	3/4		.7500	3/4		4		1-1/2		0.030	
17775015A	17778	17775015AW	13188	3/4		.7500	3/4		4		1-1/2		0.045	
17775016A	17907	17775016AW	58053	3/4		.7500	3/4		4		1-1/2		0.060	
17775017A	17908	17775017AW	13189	3/4		.7500	3/4		4		1-1/2		0.090	
17775018A	17909	17775018AW	13190	3/4		.7500	3/4		4		1-1/2		0.125	
17778700A	17955				20.0	.7874		20.0		104		38.0		
17778703A	17956				20.0	.7874		20.0		104		38.0		1.00
17778704A	18091				20.0	.7874		20.0		104		38.0		1.50
17778705A	18084				20.0	.7874		20.0		104		38.0		2.00
17778707A	18086				20.0	.7874		20.0		104		38.0		3.00
17778709A	18088				20.0	.7874		20.0		104		38.0		4.00
177787011A	18090				20.0	.7874		20.0		104		38.0		5.00
177787012A	18092				20.0	.7874		20.0		104		38.0		6.00
17798400A	17957				25.0	.9843		25.0		104		38.0		
17798403A	17958				25.0	.9843		25.0		104		38.0		1.00
17710000A	17727	17710000AW	13191	1		1.0000	1		4		1			
17710002A	18004	17710002AW	13192	1		1.0000	1		4		1		0.015	
17710004A	17779	17710004AW	13193	1		1.0000	1		4		1		0.030	
17710005A	17780	17710005AW	13194	1		1.0000	1		4		1		0.045	
17710010A	17728	17710010AW	58078	1		1.0000	1		4		1-1/2			
17710012A	18005	17710012AW	13195	1		1.0000	1		4		1-1/2		0.015	
17710014A	17781	17710014AW	58033	1		1.0000	1		4		1-1/2		0.030	
17710015A	17782	17710015AW	13197	1		1.0000	1		4		1-1/2		0.045	
17710016A	17910	17710016AW	13198	1		1.0000	1		4		1-1/2		0.060	
17710017A	17911	17710017AW	13199	1		1.0000	1		4		1-1/2		0.090	
17710018A	17912	17710018AW	13200	1		1.0000	1		4		1-1/2		0.125	

177 / 177W
TuffCut® XR

HIGH PERFORMANCE



Page 320



For product information, call your local distributor.

4
Flute

**TuffCut® XR
Series 177L**

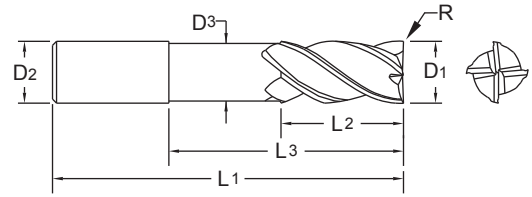

ALtima®		Diameter		Shank	Neck Dia.	OAL	Flute Length	Neck Length	Corner Radius
		D1 h10		D2 h6	D3	L1	L2	L3	R
Tool No.	EDP	mm	Decimal	mm	mm	mm	mm	mm	mm
177L2360R010N5A	18186	6	.2362	6	5.8	101	12	31	0.25
177L2360R020N5A	18183	6	.2362	6	5.8	101	12	31	0.5
177L2360R039N5A	18184	6	.2362	6	5.8	101	12	31	1.0
177L3150R020N5A	18187	8	.3150	8	7.6	101	16	41	0.5
177L3150R039N5A	18194	8	.3150	8	7.6	101	16	41	1.0
177L3150R078N5A	18195	8	.3150	8	7.6	101	16	41	2.0
177L3150R118N5A	18196	8	.3150	8	7.6	101	16	41	3.0
177L3930R020N5A	18188	10	.3937	10	9.6	127	20	51	0.5
177L3930R039N5A	18197	10	.3937	10	9.6	127	20	51	1.0
177L3930R078N5A	18198	10	.3937	10	9.6	127	20	51	2.0
177L3930R118N5A	18199	10	.3937	10	9.6	127	20	51	3.0
177L4720R020N5A	18189	12	.4724	12	11.4	152	24	62	0.5
177L4720R039N5A	18176	12	.4724	12	11.4	152	24	62	1.0
177L4720R078N5A	18177	12	.4724	12	11.4	152	24	62	2.0
177L4720R118N5A	18190	12	.4724	12	11.4	152	24	62	3.0
177L4720R157N5A	18178	12	.4724	12	11.4	152	24	62	4.0
177L6290R020N5A	18181	16	.6299	16	15.2	152	32	82	0.5
177L6290R039N5A	18191	16	.6299	16	15.2	152	32	82	1.0
177L6290R078N5A	18179	16	.6299	16	15.2	152	32	82	2.0
177L6290R118N5A	18180	16	.6299	16	15.2	152	32	82	3.0
177L7870R020N5A	18182	20	.7874	20	19.2	152	40	102	0.5
177L7870R039N5A	18192	20	.7874	20	19.2	152	40	102	1.0
177L7870R118N5A	18193	20	.7874	20	19.2	152	40	102	3.0

Inch sizes available upon request.

Metric (mm)	
D1	Tolerance h10
6.00	+0.00/-0.048
>6.00 - 10.00	+0.00/-0.058
>10.00 - 18.00	+0.00/-0.070
>18.00 - 20.00	+0.00/-0.084

Metric (mm)	
D2	Tolerance (h6)
6.0	+0/-0.008
6.01 - 10.0	+0/-0.009
10.01 - 18.0	+0/-0.011
18.01 - 20.0	+0/-0.013

Metric (mm)	
R	Tolerance
6.0 - 20.0	+0.00/-0.10



TuffCut® XR Series 177S

Z4

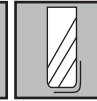
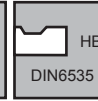
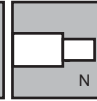
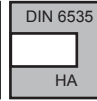
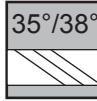
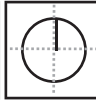

4
Flute

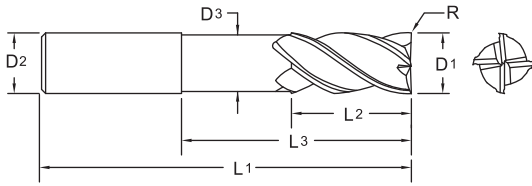

Metric (mm)	
D1	Tolerance h10
3.00	+0.000/-0.040
>3.00 - 6.00	+0.000/-0.048
>6.00 - 10.00	+0.000/-0.058
>10.00 - 18.00	+0.000/-0.070
>18.00 - 20.00	+0.000/-0.084

Metric (mm)	
D2	Tolerance (h6)
6.0	+0/-0.008
6.01 - 10.0	+0/-0.009
10.01 - 18.0	+0/-0.011
18.01 - 20.0	+0/-0.013

Metric (mm)	
R	Tolerance
3.0 - 20.0	+0.00/-0.10

ALtima®		Diameter		Shank	Neck Diameter	OAL	Flute Length	Neck Length	Corner Radius	Shank
Tool No.	EDP	mm	Decimal							
177S1181A	18218	3	.1181	6	2.9	50	5	11		DIN 6535 HA
177S1181R008A	18200	3	.1181	6	2.9	50	5	11	0.20	DIN 6535 HA
177S1181AW	18254	3	.1181	6	2.9	50	5	11		DIN 6535 HB
177S1181R008AW	18236	3	.1181	6	2.9	50	5	11	0.20	DIN 6535 HB
177S1575A	18220	4	.1575	6	3.9	50	6	14		DIN 6535 HA
177S1575R008A	18202	4	.1575	6	3.9	50	6	14	0.20	DIN 6535 HA
177S1575AW	18256	4	.1575	6	3.9	50	6	14		DIN 6535 HB
177S1575R008AW	18238	4	.1575	6	3.9	50	6	14	0.20	DIN 6535 HB
177S1969A	18222	5	.1968	6	4.9	57	8	17		DIN 6535 HA
177S1969R008A	18204	5	.1968	6	4.9	57	8	17	0.20	DIN 6535 HA
177S1969AW	18258	5	.1968	6	4.9	57	8	17		DIN 6535 HB
177S1969R008AW	18240	5	.1968	6	4.9	57	8	17	0.20	DIN 6535 HB
177S2362A	18224	6	.2362	6	5.8	57	9	20		DIN 6535 HA
177S2362R012A	18206	6	.2362	6	5.8	57	9	20	0.30	DIN 6535 HA
177S2362AW	18260	6	.2362	6	5.8	57	9	20		DIN 6535 HB
177S2362R012AW	18242	6	.2362	6	5.8	57	9	20	0.30	DIN 6535 HB
177S3150A	18226	8	.3150	8	7.6	63	12	26		DIN 6535 HA
177S3150R020A	18208	8	.3150	8	7.6	63	12	26	0.50	DIN 6535 HA
177S3150AW	18262	8	.3150	8	7.6	63	12	26		DIN 6535 HB
177S3150R020AW	18244	8	.3150	8	7.6	63	12	26	0.50	DIN 6535 HB
177S3937A	18228	10	.3937	10	9.6	72	15	32		DIN 6535 HA
177S3937R020A	18210	10	.3937	10	9.6	72	15	32	0.50	DIN 6535 HA
177S3937AW	18264	10	.3937	10	9.6	72	15	32		DIN 6535 HB
177S3937R020AW	18246	10	.3937	10	9.6	72	15	32	0.50	DIN 6535 HB
177S4724A	18230	12	.4724	12	11.4	83	18	38		DIN 6535 HA
177S4724R020A	18212	12	.4724	12	11.4	83	18	38	0.50	DIN 6535 HA
177S4724AW	18266	12	.4724	12	11.4	83	18	38		DIN 6535 HB
177S4724R020AW	18248	12	.4724	12	11.4	83	18	38	0.50	DIN 6535 HB
177S6299A	18232	16	.6299	16	15.2	98	24	50		DIN 6535 HA
177S6299R039A	18214	16	.6299	16	15.2	98	24	50	1.00	DIN 6535 HA
177S6299AW	18268	16	.6299	16	15.2	98	24	50		DIN 6535 HB
177S6299R039AW	18250	16	.6299	16	15.2	98	24	50	1.00	DIN 6535 HB
177S7874A	18234	20	.7874	20	19.2	112	30	62		DIN 6535 HA
177S7874R039A	18216	20	.7874	20	19.2	112	30	62	1.00	DIN 6535 HA
177S7874AW	18270	20	.7874	20	19.2	112	30	62		DIN 6535 HB
177S7874R039AW	18252	20	.7874	20	19.2	112	30	62	1.00	DIN 6535 HB

177L / 177S
TuffCut® XR

HIGH PERFORMANCE



Inch sizes available upon request.

5
Flute
NEW

TuffCut® XR
Series 178 / 178W



Designed for EXTREME Productivity. Gain 20% or more in productivity over four flute styles. Smooth cutting action to eliminate vibration.

New-Standard Offering with Weldon Shank Flats

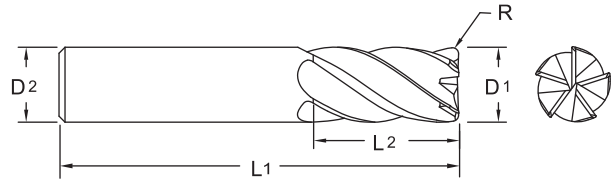

ALtima®		ALtima® Weldon Flat		Diameter			Shank		OAL		Flute Length		Corner Radius	
Tool No.	EDP	Tool No.	EDP	D1			D2 h6		L1		L2		R	
				Inch	mm	Decimal	Inch	mm	Inch	mm	Inch	mm	Inch	mm
17811800A	17959				3	.1181		6		57		8		
17811810A	17998				3	.1181		3		75		25		
17812500A	17800			1/8		.1250	1/8		1-1/2		1/8			
17812510A	17801			1/8		.1250	1/8		1-1/2		3/8			
17815600A	17802			5/32		.1562	3/16		2		3/16			
17815610A	17803			5/32		.1562	3/16		2		7/16			
17815700A	17961				4	.1575		6		57		11		
17815710A	17999				4	.1575		4		75		25		
17818700A	17804			3/16		.1875	3/16		2		3/16			
17818710A	17805			3/16		.1875	3/16		2		7/16			
17819600A	17963				5	.1968		6		57		13		
17819610A	18026				5	.1968		5		75		25		
17821800A	17806			7/32		.2187	1/4		2		1/4			
17821810A	17807			7/32		.2187	1/4		2-1/2		7/16			
17823600A	17965				6	.2362		6		57		13		
17823601A	17966				6	.2362		6		57		13		0.500
17823610A	18027				6	.2362		6		75		25		
17825000A	17808			1/4		.2500	1/4		2		3/8			
17825002A	17829			1/4		.2500	1/4		2		3/8		0.015	
17825004A	17830			1/4		.2500	1/4		2		3/8		0.030	
17825010A	17809			1/4		.2500	1/4		2-1/2		5/8			
17825012A	17831			1/4		.2500	1/4		2-1/2		5/8		0.015	
17825014A	17832			1/4		.2500	1/4		2-1/2		5/8		0.030	
17825022A	18105			1/4			1/4		2-1/2		3/4		0.015	
17828100A	17810			9/32		.2812	5/16		2-1/2		5/8			
17828102A	17835			9/32		.2812	5/16		2-1/2		5/8		0.015	
17828104A	17836			9/32		.2812	5/16		2-1/2		5/8		0.030	
17831200A	17811			5/16		.3125	5/16		2		7/16			



Inch	
D1	Tolerance
1/8 - 1/4	+0.000/-0.002
> 1/4 - 1.0	+0.000/-0.003

Metric (mm)	
D1	Tolerance h10
3.00	+0.000/-0.040
>3.00 - 6.00	+0.000/-0.048
>6.00 - 10.00	+0.000/-0.058
>10.00 - 18.00	+0.000/-0.070
>18.00 - 25.00	+0.000/-0.084

Inch	
D2	Tolerance (h6)
.1182 - .2362	+0/-0.00031
.2363 - .3937	+0/-0.00035
.3938 - .7087	+0/-0.00043
.7088 - 1.000	+0/-0.00051

Metric (mm)	
D2	Tolerance (h6)
3.0	+0/-0.006
3.01 - 6.0	+0/-0.008
6.01 - 10.0	+0/-0.009
10.01 - 18.0	+0/-0.011
18.01 - 25.0	+0/-0.013

Inch	
R	Tolerance
1/4 - 1	+0.0000/-0.0016

Metric (mm)	
R	Tolerance
6.0 - 25.0	+0.00/-0.04

Series 178 / 178W Continued

5
Flute

178 / 178W
TuffCut® XR

HIGH PERFORMANCE

ALtima®		ALtima® Weldon Flat		Diameter			Shank		OAL		Flute Length		Corner Radius	
Tool No.	EDP	Tool No.	EDP	D1			D2 h6		L1		L2		R	
				Inch	mm	Decimal	Inch	mm	Inch	mm	Inch	mm	Inch	mm
17831202A	17837			5/16		.3125	5/16		2		7/16		0.015	
17831204A	17838			5/16		.3125	5/16		2		7/16		0.030	
17831210A	17812			5/16		.3125	5/16		2-1/2		13/16			
17831212A	17839			5/16		.3125	5/16		2-1/2		13/16		0.015	
17831214A	17840			5/16		.3125	5/16		2-1/2		13/16		0.030	
17831500A	17968				8	.3150		8		63		19		
17831501A	17969				8	.3150		8		63		19		0.500
17831510A	18028				8	.3150		8		75		30		
17834300A	17813			11/32		.3438	3/8		2-1/2		13/16			
17834302A	17843			11/32		.3438	3/8		2-1/2		13/16		0.015	
17834304A	17844			11/32		.3438	3/8		2-1/2		13/16		0.030	
17837500A	17814			3/8		.3750	3/8		2		1/2			
17837502A	17845			3/8		.3750	3/8		2		1/2		0.015	
17837504A	17846			3/8		.3750	3/8		2		1/2		0.030	
17837510A	17815			3/8		.3750	3/8		2-1/2		7/8			
17837512A	17847			3/8		.3750	3/8		2-1/2		7/8		0.015	
17837514A	17848			3/8		.3750	3/8		2-1/2		7/8		0.030	
17839300A	17971				10	.3937		10		72		22		
17839301A	17972				10	.3937		10		72		22		0.500
17839310A	18029				10	.3937		10		100		45		
17840600A	17816			13/32		.4062	7/16		2-3/4		7/8			
17840602A	17853			13/32		.4062	7/16		2-3/4		7/8		0.015	
17840604A	17854			13/32		.4062	7/16		2-3/4		7/8		0.030	
17843700A	17817			7/16		.4375	7/16		2-1/2		9/16			
17843702A	17855			7/16		.4375	7/16		2-1/2		9/16		0.015	
17843704A	17856			7/16		.4375	7/16		2-1/2		9/16		0.030	
17843710A	17818			7/16		.4375	7/16		2-3/4		1			
17843712A	17857			7/16		.4375	7/16		2-3/4		1		0.015	
17843714A	17858			7/16		.4375	7/16		2-3/4		1		0.030	
17846800A	17819			15/32		.4688	1/2		3		1			
17846802A	17863			15/32		.4688	1/2		3		1		0.015	
17846804A	17864			15/32		.4688	1/2		3		1		0.030	
17847200A	17974				12	.4724		12		83		26		
17847202A	17975				12	.4724		12		83		26		0.750
17847210A	18030				12	.4724		12		150		75		
17850000A	17820	17850000AW	10655	1/2		.5000	1/2		2-1/2		5/8			
17850002A	17865	17850002AW	13337	1/2		.5000	1/2		2-1/2		5/8		0.015	
17850004A	17866	17850004AW	13339	1/2		.5000	1/2		2-1/2		5/8		0.030	
17850010A	17821	17850010AW	13341	1/2		.5000	1/2		3		1			
17850012A	17867	17850012AW	13343	1/2		.5000	1/2		3		1		0.015	
17850014A	17868	17850014AW	13345	1/2		.5000	1/2		3		1		0.030	
17850015A	17869	17850015AW	13347	1/2		.5000	1/2		3		1		0.045	
17850016A	17913	17850016AW	13349	1/2		.5000	1/2		3		1		0.060	
17850017A	17914	17850017AW	13351	1/2		.5000	1/2		3		1		0.090	
17850018A	17915	17850018AW	13353	1/2		.5000	1/2		3		1		0.125	
17855100A	17977				14	.5512		14		83		26		
17855102A	17978				14	.5512		14		83		26		0.750
17856200A	17822	17856200AW	13355	9/16		.5625	9/16		3-1/2		1-1/8			
17856202A	17875	17856202AW	13357	9/16		.5625	9/16		3-1/2		1-1/8		0.015	
17856204A	17876	17856204AW	13359	9/16		.5625	9/16		3-1/2		1-1/8		0.030	



5
Flute

Series 178 / 178W Continued

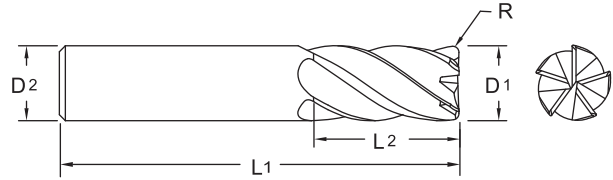

ALtima®		ALtima® Weldon Flat		Diameter			Shank		OAL		Flute Length		Corner Radius	
Tool No.	EDP	Tool No.	EDP	D1			D2 h6		L1		L2		R	
				Inch	mm	Decimal	Inch	mm	Inch	mm	Inch	mm	Inch	mm
17862500A	17823	17862500AW	13361	5/8		.6250	5/8		3		3/4			
17862502A	18006	17862502AW	13363	5/8		.6250	5/8		3		3/4		0.015	
17862504A	17877	17862504AW	13365	5/8		.6250	5/8		3		3/4		0.030	
17862505A	17878	17862505AW	13367	5/8		.6250	5/8		3		3/4		0.045	
17862510A	17824	17862510AW	13369	5/8		.6250	5/8		3-1/2		1-1/4			
17862512A	18007	17862512AW	13371	5/8		.6250	5/8		3-1/2		1-1/4		0.015	
17862514A	17879	17862514AW	13373	5/8		.6250	5/8		3-1/2		1-1/4		0.030	
17862515A	17880	17862515AW	13375	5/8		.6250	5/8		3-1/2		1-1/4		0.045	
17862516A	17916	17862516AW	13377	5/8		.6250	5/8		3-1/2		1-1/4		0.060	
17862517A	17917	17862517AW	13379	5/8		.6250	5/8		3-1/2		1-1/4		0.090	
17862518A	17918	17862518AW	13381	5/8		.6250	5/8		3-1/2		1-1/4		0.125	
17862900A	17981				16	.6299		16		92		32		
17862903A	17982				16	.6299		16		92		32		1.000
17862910A	18031				16	.6299		16		150		75		
17870800A	17983				18	.7087		18		92		32		
17870803A	17984				18	.7087		18		92		32		1.000
17875000A	17825	17875000AW	10656	3/4		.7500	3/4		3		1			
17875002A	18011	17875002AW	13385	3/4		.7500	3/4		3		1		0.015	
17875004A	17887	17875004AW	13387	3/4		.7500	3/4		3		1		0.030	
17875005A	17888	17875005AW	13389	3/4		.7500	3/4		3		1		0.045	
17875010A	17826	17875010AW	13394	3/4		.7500	3/4		4		1-1/2			
17875012A	18012	17875012AW	13395	3/4		.7500	3/4		4		1-1/2		0.015	
17875014A	17889	17875014AW	13396	3/4		.7500	3/4		4		1-1/2		0.030	
17875015A	17890	17875015AW	13397	3/4		.7500	3/4		4		1-1/2		0.045	
17875016A	17919	17875016AW	13398	3/4		.7500	3/4		4		1-1/2		0.060	
17875017A	17920	17875017AW	13399	3/4		.7500	3/4		4		1-1/2		0.090	
17875018A	17921	17875018AW	13402	3/4		.7500	3/4		4		1-1/2		0.125	
17878700A	17986				20	.7874		20		104		38		
17878703A	17987				20	.7874		20		104		38		1.000
17878710A	18032				20	.7874		20		150		75		
17898400A	17988				25	.9843		25		104		38		
17898403A	17989				25	.9843		25		104		38		1.000
17810000A	17827	17810000AW	13403	1		1.0000	1		4		1			
17810010A	17828	17810010AW	13404	1		1.0000	1		4		1-1/2			
17810012A	18015	17810012AW	13405	1		1.0000	1		4		1-1/2		0.015	
17810014A	17895	17810014AW	13406	1		1.0000	1		4		1-1/2		0.030	
17810015A	17896	17810015AW	13407	1		1.0000	1		4		1-1/2		0.045	
17810016A	17922	17810016AW	13408	1		1.0000	1		4		1-1/2		0.060	
17810017A	17923	17810017AW	13420	1		1.0000	1		4		1-1/2		0.090	
17810018A	17924	17810018AW	13421	1		1.0000	1		4		1-1/2		0.125	



TuffCut® XR Series 178N



5
Flute

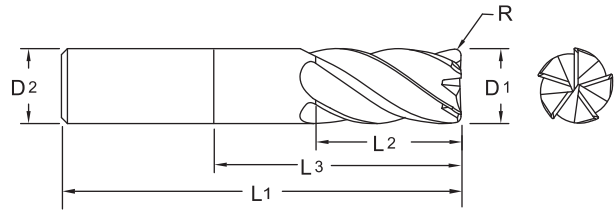

ALtima®		Diameter		Shank	OAL	Flute Length		Neck Length	Corner Radius
		D1		D2 h6	L1	L2	L3	R	
Tool No.	EDP	Inch	Decimal	Inch	Inch	Inch	Inch	Inch	Inch
17825022NA	17833	1/4	.2500	1/4	4	3/4	2-1/8	0.015	
17825024NA	17834	1/4	.2500	1/4	4	3/4	2-1/8	0.030	
17831222NA	17841	5/16	.3125	5/16	4	1	2-1/8	0.015	
17831224NA	17842	5/16	.3125	5/16	4	1	2-1/8	0.030	
17837522NA	17849	3/8	.3750	3/8	4	1	2-1/8	0.015	
17837524NA	17850	3/8	.3750	3/8	4	1	2-1/8	0.030	
17837532NA	17851	3/8	.3750	3/8	6	1-1/4	3-3/8	0.015	
17837534NA	17852	3/8	.3750	3/8	6	1-1/4	3-3/8	0.030	
17843722NA	17859	7/16	.4375	7/16	4	1-1/4	2-1/8	0.015	
17843724NA	17860	7/16	.4375	7/16	4	1-1/4	2-1/8	0.030	
17843732NA	17861	7/16	.4375	7/16	6	1-1/2	3-3/8	0.015	
17843734NA	17862	7/16	.4375	7/16	6	1-1/2	3-3/8	0.030	
17850022NA	17925	1/2	.5000	1/2	4	1-1/4	2-1/8	0.015	
17850024NA	17870	1/2	.5000	1/2	4	1-1/4	2-1/8	0.030	
17850032NA	17871	1/2	.5000	1/2	5	1-3/8	3-1/8	0.015	
17850034NA	17872	1/2	.5000	1/2	5	1-3/8	3-1/8	0.030	
17850042NA	17873	1/2	.5000	1/2	6	1-1/2	4-1/8	0.015	
17850044NA	17874	1/2	.5000	1/2	6	1-1/2	4-1/8	0.030	
17862522NA	18008	5/8	.6250	5/8	4	1-1/2	2-1/8	0.015	
17862524NA	17881	5/8	.6250	5/8	4	1-1/2	2-1/8	0.030	
17862525NA	17882	5/8	.6250	5/8	4	1-1/2	2-1/8	0.045	
17862532NA	18009	5/8	.6250	5/8	5	1-3/4	3-1/8	0.015	
17862534NA	17883	5/8	.6250	5/8	5	1-3/4	3-1/8	0.030	
17862535NA	17884	5/8	.6250	5/8	5	1-3/4	3-1/8	0.045	
17862542NA	18010	5/8	.6250	5/8	6	2	4	0.015	
17862544NA	17885	5/8	.6250	5/8	6	2	4	0.030	
17862545NA	17886	5/8	.6250	5/8	6	2	4	0.045	
17875022NA	18013	3/4	.7500	3/4	5	1-7/8	3	0.015	
17875024NA	17891	3/4	.7500	3/4	5	1-7/8	3	0.030	
17875025NA	17892	3/4	.7500	3/4	5	1-7/8	3	0.045	
17875032NA	18014	3/4	.7500	3/4	6	2-1/4	4	0.015	
17875034NA	17893	3/4	.7500	3/4	6	2-1/4	4	0.030	
17875035NA	17894	3/4	.7500	3/4	6	2-1/4	4	0.045	
17810022NA	18016	1	1.0000	1	5	2-1/4	3	0.015	
17810024NA	17897	1	1.0000	1	5	2-1/4	3	0.030	
17810025NA	17898	1	1.0000	1	5	2-1/4	3	0.045	
17810032NA	18017	1	1.0000	1	6	3	4	0.015	
17810034NA	17899	1	1.0000	1	6	3	4	0.030	
17810035NA	17900	1	1.0000	1	6	3	4	0.045	

Inch	
D1	Tolerance
1/4	+0.000/-0.002
> 1/4 - 1.0	+0.000/-0.003

Inch	
D2	Tolerance (h6)
.2363 - .3937	+0/-0.00035
.3938 - .7087	+0/-0.00043
.7088 - 1.000	+0/-0.00051

Inch	
R	Tolerance
1/4 - 1	+0.0000/-0.0016

178 / 178W / 178N

TuffCut® XR

HIGH PERFORMANCE



4

Flute
Ball

**TuffCut® XR
Series 179**

Z4

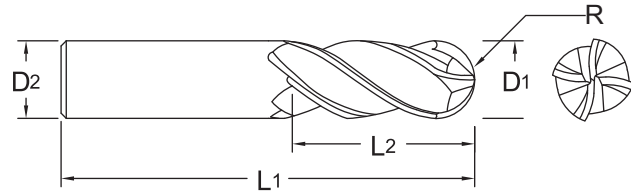
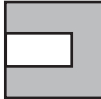
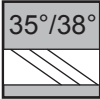
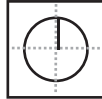

ALtima®		Diameter			Shank		OAL		Flute Length	
Tool No.	EDP	D1			D2 h6		L1		L2	
		Inch	mm	Decimal	Inch	mm	Inch	mm	Inch	mm
17905900A	18272		1.5	.0591		3		38		3.0
17906250A	18284	1/16		.0625	1/8		1-1/2		1/8	
17907810A	18286	5/64		.0781	1/8		1-1/2		5/32	
17907870A	18274		2	.0787		3		38		4.0
17909370A	18288	3/32		.0937	1/8		1-1/2		3/16	
17909840A	18276		2.5	.0984		3		38		5.0
17911800A	18018		3	.1181		6		57		8.0
17911803A	18278		3	.1181		3		38		6.0
17912500A	18034	1/8		.1250	1/8		1-1/2		1/4	
17912510A	18035	1/8		.1250	1/8		1-1/2		3/8	
17913700A	18280		3.5	.1378		6		63		7.0
17915700A	18019		4	.1575		6		57		11.0
17917700A	18282		4.5	.1772		6		63		9.0
17918700A	18038	3/16		.1875	3/16		2		3/8	
17918710A	18039	3/16		.1875	3/16		2		5/8	
17919600A	18020		5	.1968		6		57		13.0
17923600A	18021		6	.2362		6		57		13.0
17925000A	18042	1/4		.2500	1/4		2		3/8	
17925010A	18043	1/4		.2500	1/4		2-1/2		3/4	
17925020A	18063	1/4		.2500	1/4		4		1/2	
17931200A	18045	5/16		.3125	5/16		2		1/2	
17931210A	18046	5/16		.3125	5/16		2-1/2		13/16	
17931500A	18022		8	.3150		8		63		19.0
17937500A	18048	3/8		.3750	3/8		2		1/2	
17937510A	18049	3/8		.3750	3/8		2-1/2		7/8	
17937520A	18064	3/8		.3750	3/8		4		9/16	
17939300A	18023		10	.3937		10		72		22.0
17947200A	18024		12	.4724		12		83		26.0
17950000A	18054	1/2		.5000	1/2		2-1/2		5/8	
17950010A	18055	1/2		.5000	1/2		3		1-1/4	
17950020A	18065	1/2		.5000	1/2		5		5/8	
17962510A	18058	5/8		.6250	5/8		3-1/2		1-1/4	
17962520A	18066	5/8		.6250	5/8		6		3/4	
17962900A	18059		16	.6299		16		92		32.0
17975010A	18060	3/4		.7500	3/4		4		1-1/2	
17975020A	18067	3/4		.7500	3/4		6		1	
17910010A	18062	1		1.0000	1		4		1-1/2	
17910020A	18068	1		1.0000	1		6		1-1/4	

Inch	
D1	Tolerance
1/16 - 1/4	+0.000/-0.002
> 1/4 - 1.0	+0.000/-0.003

Metric (mm)	
D1	Tolerance h10
1.50 - 3.00	+0.000/-0.040
>3.00 - 6.00	+0.000/-0.048
>6.00 - 10.00	+0.000/-0.058
>10.00 - 16.00	+0.000/-0.070

Inch	
D2	Tolerance (h6)
.1182 - .2362	+0/-0.00031
.2363 - .3937	+0/-0.00035
.3938 - .7087	+0/-0.00043
.7088 - 1.000	+0/-0.00051

Metric (mm)	
D2	Tolerance (h6)
3.0	+0/-0.006
3.01 - 6.0	+0/-0.008
6.01 - 10.0	+0/-0.009
10.01 - 16.0	+0/-0.011

Inch	
R	Tolerance
1/16 - 1	+0/-0.001

Metric (mm)	
R	Tolerance
1.5 - 16.0	+0/-0.025



4
Flute
Ball

179 / 179L
TuffCut® XR

HIGH PERFORMANCE

TuffCut® XR
Series 179L

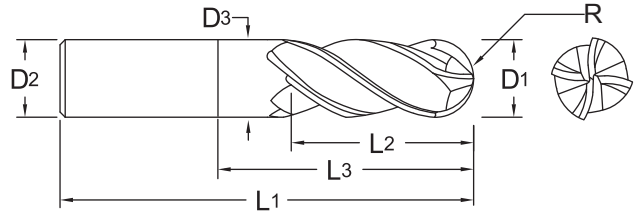

ALtima®		Diameter		Shank D2 h6	Neck Dia. D3	OAL L1	Flute Length L2	Neck Length L3
		D1 h10	mm					
Tool No.	EDP	mm	Decimal	mm	mm	mm	mm	mm
179L1181N5A	18290	3	.1181	6	2.9	75	4.5	17
179L1575N5A	18292	4	.1575	6	3.9	75	6.0	22
179L1968N5A	18294	5	.1968	6	4.9	75	7.5	27
179L2362N5A	18296	6	.2362	6	5.8	101	9.0	32
179L3150N5A	18298	8	.3150	8	7.6	101	12.0	42
179L3937N5A	18302	10	.3937	10	9.6	127	15.0	52
179L4724N5A	18304	12	.4724	12	11.4	152	18.0	62
179L6299N5A	18306	16	.6299	16	15.2	152	24.0	82

Metric (mm)	
D1	Tolerance h10
3.00	+0.00/-0.040
>3.00 - 6.00	+0.00/-0.048
>6.00 - 10.00	+0.00/-0.058
>10.00 - 16.00	+0.00/-0.070

Metric (mm)	
D2	Tolerance (h6)
6.0	+0/-0.008
6.01 - 10.0	+0/-0.009
10.01 - 16.0	+0/-0.011

Inch Sizes Available upon request.

Metric (mm)	
R	Tolerance
3.0 - 16.0	+0/-0.025



ISO 9001:2008 Certified



For product information, call your local distributor.

2
Flute

TuffCut® AL Series 135

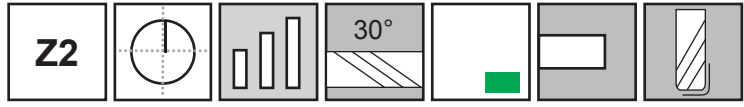

The geometry of M.A. Ford® 135 Series solid carbide end mill allows it to be run at extremely high chip loads surpassing the current market leaders.

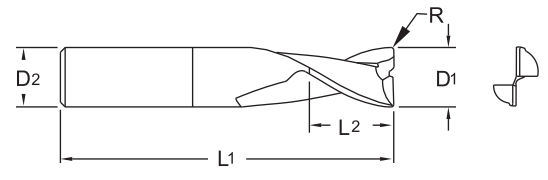

- Extremely high chip loads - .040"/1mm per tooth and above.
- Performs equally well across a broad range of operating speeds.
- Zirconium coating also available.

Uncoated		Diameter			Shank		OAL		Flute Length		Corner Radius	
		D1			D2		L1		L2		R	
Tool No.	EDP	Inch	mm	Decimal	Inch	mm	Inch	mm	Inch	mm	Inch	mm
13511810	13523		3.0	.1181		3.0		38		3.5		0.20
13515750	13533		4.0	.1575		4.0		51		4.8		0.20
13518750	13500	3/16		.1875	3/16		2		1/4		0.008	
13518751	13513	3/16		.1875	3/16		3		1/4		0.008	
13519680	13502		5.0	.1968		5.0		51		6.0		0.25
13523620	13504		6.0	.2362		6.0		64		7.0		0.30
13525000	13506	1/4		.2500	1/4		2-1/2		5/16		0.011	
13525001	13514	1/4		.2500	1/4		3-1/2		5/16		0.011	
13531500	13508		8.0	.3150		8.0		64		9.5		0.35
13537500	13510	3/8		.3750	3/8		2-1/2		1/2		0.015	
13537501	13511	3/8		.3750	3/8		3		1/2		0.015	
13537502	13512	3/8		.3750	3/8		4		1/2		0.015	
13539370	13515		10.0	.3937		10.0		70		12.0		0.50
13539371	13516		10.0	.3937		10.0		76		12.0		0.50
13539372	13517		10.0	.3937		10.0		89		12.0		0.50
13547240	13525		12.0	.4724		12.0		76		14.0		0.50
13547241	13526		12.0	.4724		12.0		102		14.0		0.50
13547242	13527		12.0	.4724		12.0		127		14.0		0.50
13550000	13520	1/2		.5000	1/2		3		5/8		0.020	
13550001	13521	1/2		.5000	1/2		4		5/8		0.020	
13550002	13522	1/2		.5000	1/2		5		5/8		0.020	
13555120	13552		14.0	.5512		14.0		89		16.0		0.50
13555121	13554		14.0	.5512		14.0		102		16.0		0.50
13555122	13573		14.0	.5512		14.0		127		16.0		0.50
13562500	13538	5/8		.6250	5/8		3-1/2		3/4		0.025	
13562501	13539	5/8		.6250	5/8		4-5/8		3/4		0.025	
13562502	13543	5/8		.6250	5/8		5-1/4		3/4		0.025	
13562990	13535		16.0	.6299		16.0		89		18.0		0.75
13562991	13536		16.0	.6299		16.0		117		18.0		0.75
13562992	13537		16.0	.6299		16.0		133		18.0		0.75
13570870	13563		18.0	.7087		18.0		102		20.0		0.75
13570871	13568		18.0	.7087		18.0		127		20.0		0.75
13570872	13574		18.0	.7087		18.0		152		20.0		0.75
13575000	13530	3/4		.7500	3/4		4		1		0.030	

Inch	
D1	Tolerance
3/16 - 1/4	+0.000/-0.002
>1/4 - 1	+0.000/-0.003

Metric (mm)	
D1	Tolerance h10
3.00	+0.000/-0.040
>3.00 - 6.00	+0.000/-0.048
>6.00 - 10.00	+0.000/-0.058
>10.00 - 18.00	+0.000/-0.070
>18.00 - 25.00	+0.000/-0.084

Inch	
R	Tolerance
< 3/8	+0.002/-0.002
≥ 3/8	+0.003/-0.003

Metric (mm)	
R	Tolerance
< 10.0	+0.05/-0.05
≥ 10.0	+0.075/-0.075



Series 135 Continued

2
Flute

Uncoated		Diameter			Shank		OAL		Flute Length		Corner Radius	
		D1			D2		L1		L2		R	
Tool No.	EDP	Inch	mm	Decimal	Inch	mm	Inch	mm	Inch	mm	Inch	mm
13575001	13531	3/4		.7500	3/4		5		1		0.030	
13575002	13532	3/4		.7500	3/4		6		1		0.030	
13578740	13545		20.0	.7874		20.0		102		22.0		0.75
13578741	13546		20.0	.7874		20.0		127		22.0		0.75
13578742	13547		20.0	.7874		20.0		152		22.0		0.75
13598430	13555		25.0	.9843		25.0		102		25.0		0.75
13598431	13556		25.0	.9843		25.0		127		25.0		0.75
13598432	13557		25.0	.9843		25.0		152		25.0		0.75
13510000	13540	1		1.0000	1		4		1-1/4		0.045	
13510001	13541	1		1.0000	1		5		1-1/4		0.045	
13510002	13542	1		1.0000	1		6		1-1/4		0.045	



Page 330

135

TuffCut® AL

HIGH PERFORMANCE



For product information, call your local distributor.

2
Flute

TuffCut® AL Series 135N

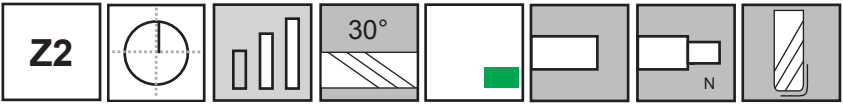

The geometry of M.A. Ford® 135 Series solid carbide end mill allows it to be run at extremely high chip loads surpassing the current market leaders.

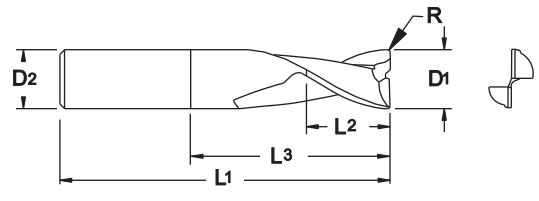

Uncoated Necked		Diameter			Shank		OAL		Flute Length		Neck Length		Corner Radius	
		D1			D2		L1		L2		L3		R	
Tool No.	EDP	Inch	mm	Decimal	Inch	mm	Inch	mm	Inch	mm	Inch	mm	Inch	mm
13511800N3	96620		3.0	.1181		3.0		38		3.5		11		
13511810N	13524		3.0	.1181		3.0		38		3.5		11		0.20
13511801N3	96621		3.0	.1181		3.0		38		3.5		11		0.50
13511803N3	96622		3.0	.1181		3.0		38		3.5		11		1.00
13511800N5	96623		3.0	.1181		3.0		38		3.5		16		
13511801N5	96624		3.0	.1181		3.0		38		3.5		16		0.50
13511803N5	96625		3.0	.1181		3.0		38		3.5		16		1.00
13515700N3	96626		4.0	.1575		4.0		51		4.8		14		
13515701N3	96627		4.0	.1575		4.0		51		4.8		14		0.50
13515703N3	96628		4.0	.1575		4.0		51		4.8		14		1.00
13515700N5	96629		4.0	.1575		4.0		51		4.8		22		
13515750N	13534		4.0	.1575		4.0		51		4.8		22		0.20
13515701N5	96630		4.0	.1575		4.0		51		4.8		22		0.50
13515703N5	96631		4.0	.1575		4.0		51		4.8		22		1.00
13518750N	13501	3/16		.1875	3/16		2		1/4		9/16		0.008	
13518751N	13518	3/16		.1875	3/16		3		1/4		1-9/16		0.008	
13519680N	13503		5.0	.1968		5.0		51		6.0		22		0.25
13519600N3	96632		5.0	.1968		6.0		64		6.0		17		
13519601N3	96633		5.0	.1968		6.0		64		6.0		17		0.50
13519603N3	96634		5.0	.1968		6.0		64		6.0		17		1.00
13519600N5	96635		5.0	.1968		6.0		64		6.0		27		
13519601N5	96636		5.0	.1968		6.0		64		6.0		27		0.50
13519603N5	96637		5.0	.1968		6.0		64		6.0		27		1.00
13523600N3	96638		6.0	.2362		6.0		64		7.0		20		
13523601N3	96639		6.0	.2362		6.0		64		7.0		20		0.50
13523603N3	96640		6.0	.2362		6.0		64		7.0		20		1.00
13523604N3	96641		6.0	.2362		6.0		64		7.0		20		1.50
13523605N3	96642		6.0	.2362		6.0		64		7.0		20		2.00
13523620N	13505		6.0	.2362		6.0		64		7.0		26		0.30
13523600N5	96643		6.0	.2362		6.0		64		7.0		32		

Inch	
D1	Tolerance
3/16 - 1/4	+0.00/-0.002
> 1/4 - 1	+0.00/-0.003

Metric (mm)	
D1	Tolerance h10
3.00	+0.00/-0.040
>3.00 - 6.00	+0.00/-0.048
>6.00 - 10.00	+0.00/-0.058
>10.00 - 18.00	+0.00/-0.070
>18.00 - 25.00	+0.00/-0.084

Inch	
R	Tolerance
< 3/8	+0.002/-0.002
≥ 3/8	+0.003/-0.003

Metric (mm)	
R	Tolerance
< 10.0	+0.05/-0.05
≥ 10.0	+0.075/-0.075



Series 135N Continued

2
Flute

Uncoated Necked		Diameter			Shank		OAL		Flute Length		Neck Length		Corner Radius	
		D1			D2		L1		L2		L3		R	
Tool No.	EDP	Inch	mm	Decimal	Inch	mm	Inch	mm	Inch	mm	Inch	mm	Inch	mm
13523601N5	96644		6.0	.2362		6.0		64		7.0		32		0.50
13523603N5	96645		6.0	.2362		6.0		64		7.0		32		1.00
13523604N5	96646		6.0	.2362		6.0		64		7.0		32		1.50
13523605N5	96647		6.0	.2362		6.0		64		7.0		32		2.00
13525000N	13507	1/4		.2500	1/4		2-1/2		5/16		3/4		0.011	
13525001N	13519	1/4		.2500	1/4		3-1/2		5/16		1-3/4		0.011	
13531500N3	96648		8.0	.3150		8.0		64		9.5		26		
13531501N3	96649		8.0	.3150		8.0		64		9.5		26		0.50
13531500N	13509		8.0	.3150		8.0		64		9.5		26		0.35
13531503N3	96650		8.0	.3150		8.0		64		9.5		26		1.00
13531504N3	96651		8.0	.3150		8.0		64		9.5		26		1.50
13531505N3	96652		8.0	.3150		8.0		64		9.5		26		2.00
13531507N3	96653		8.0	.3150		8.0		64		9.5		26		3.00
13531500N5	96654		8.0	.3150		8.0		75		9.5		42		
13531501N5	96655		8.0	.3150		8.0		75		9.5		42		0.50
13531503N5	96656		8.0	.3150		8.0		75		9.5		42		1.00
13531504N5	96657		8.0	.3150		8.0		75		9.5		42		1.50
13531505N5	96658		8.0	.3150		8.0		75		9.5		42		2.00
13531507N5	96659		8.0	.3150		8.0		75		9.5		42		3.00
13537500N	13560	3/8		.3750	3/8		2-1/2		1/2		7/8		0.015	
13537501N	13561	3/8		.3750	3/8		3		1/2		1-3/8		0.015	
13537502N	13562	3/8		.3750	3/8		4		1/2		2-3/8		0.015	
13539370N	13565		10.0	.3937		10.0		70		12.0		28		0.50
13539300N3	96660		10.0	.3937		10.0		76		12.0		34		
13539371N	13566		10.0	.3937		10.0		76		12.0		34		0.50
13539303N3	96662		10.0	.3937		10.0		76		12.0		34		1.00
13539304N3	96663		10.0	.3937		10.0		76		12.0		34		1.50
13539305N3	96664		10.0	.3937		10.0		76		12.0		34		2.00
13539307N3	96665		10.0	.3937		10.0		76		12.0		34		3.00
13539372N	13567		10.0	.3937		10.0		89		12.0		47		0.50
13539301N5	96666		10.0	.3937		10.0		89		12.0		52		0.50
13539303N5	96667		10.0	.3937		10.0		89		12.0		52		1.00
13539304N5	96668		10.0	.3937		10.0		89		12.0		52		1.50
13539305N5	96669		10.0	.3937		10.0		89		12.0		52		2.00
13539307N5	96670		10.0	.3937		10.0		89		12.0		52		3.00
13547240N	13575		12.0	.4724		12.0		76		14.0		28		0.50
13547200N3	96671		12.0	.4724		12.0		76		14.0		38		
13547201N3	96672		12.0	.4724		12.0		76		14.0		38		0.50
13547203N3	96673		12.0	.4724		12.0		76		14.0		38		1.00
13547204N3	96674		12.0	.4724		12.0		76		14.0		38		1.50
13547205N3	96675		12.0	.4724		12.0		76		14.0		38		2.00
13547207N3	96676		12.0	.4724		12.0		76		14.0		38		3.00
13547209N3	96677		12.0	.4724		12.0		76		14.0		38		4.00
135472011N3	96721		12.0	.4724		12.0		76		14.0		38		5.00

135N
TuffCut® AL

HIGH PERFORMANCE



2
Flute

Series 135N Continued

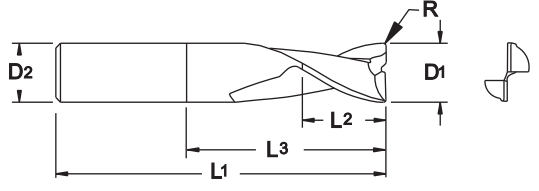
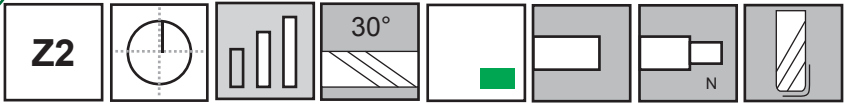

Uncoated Necked		Diameter			Shank		OAL		Flute Length		Neck Length		Corner Radius	
		D1			D2		L1		L2		L3		R	
Tool No.	EDP	Inch	mm	Decimal	Inch	mm	Inch	mm	Inch	mm	Inch	mm	Inch	mm
13547241N	13576		12.0	.4724		12.0		102		14.0		54		0.50
13547201N5	96678		12.0	.4724		12.0		110		14.0		62		0.50
13547203N5	96679		12.0	.4724		12.0		110		14.0		62		1.00
13547204N5	96680		12.0	.4724		12.0		110		14.0		62		1.50
13547205N5	96681		12.0	.4724		12.0		110		14.0		62		2.00
13547207N5	96682		12.0	.4724		12.0		110		14.0		62		3.00
13547209N5	96683		12.0	.4724		12.0		110		14.0		62		4.00
135472011N5	96723		12.0	.4724		12.0		110		14.0		62		5.00
13547242N	13577		12.0	.4724		12.0		127		14.0		79		0.50
13550000N	13570	1/2		.5000	1/2		3		5/8		1-1/8		0.020	
13550001N	13571	1/2		.5000	1/2		4		5/8		2-1/8		0.020	
13550002N	13572	1/2		.5000	1/2		5		5/8		3-1/8		0.020	
13555120N	13553		14.0	.5512		14.0		89		16.0		42		0.50
13555121N	13558		14.0	.5512		14.0		102		16.0		55		0.50
13555122N	13559		14.0	.5512		14.0		127		16.0		80		0.50
13562500N	13544	5/8		.6250	5/8		3-1/2		3/4		1-1/2		0.025	
13562501N	13548	5/8		.6250	5/8		4-5/8		3/4		2-1/2		0.025	
13562502N	13549	5/8		.6250	5/8		5-1/4		3/4		3-1/2		0.025	
13562990N	13585		16.0	.6299		16.0		89		18.0		39		0.75
13562900N3	96684		16.0	.6299		16.0		117		18.0		53		
13562901N3	96685		16.0	.6299		16.0		117		18.0		53		0.50
13562903N3	96686		16.0	.6299		16.0		117		18.0		53		1.00
13562904N3	96687		16.0	.6299		16.0		117		18.0		53		1.50
13562905N3	96688		16.0	.6299		16.0		117		18.0		53		2.00
13562907N3	96689		16.0	.6299		16.0		117		18.0		53		3.00
13562909N3	96690		16.0	.6299		16.0		117		18.0		53		4.00
13562991N	13586		16.0	.6299		16.0		117		18.0		83		0.75
13562901N5	96691		16.0	.6299		16.0		127		18.0		85		0.50
13562903N5	96692		16.0	.6299		16.0		127		18.0		85		1.00
13562904N5	96693		16.0	.6299		16.0		127		18.0		85		1.50
13562905N5	96694		16.0	.6299		16.0		127		18.0		85		2.00
13562907N5	96695		16.0	.6299		16.0		127		18.0		85		3.00
13562909N5	96696		16.0	.6299		16.0		127		18.0		85		4.00
13562992N	13587		16.0	.6299		16.0		133		18.0		99		0.75
13570870N	13564		18.0	.7087		18.0		102		20.0		52		0.75
13570871N	13569		18.0	.7087		18.0		127		20.0		77		0.75



Series 135N Continued

2
Flute

Uncoated Necked		Diameter			Shank		OAL		Flute Length		Neck Length		Corner Radius	
		D1			D2		L1		L2		L3		R	
Tool No.	EDP	Inch	mm	Decimal	Inch	mm	Inch	mm	Inch	mm	Inch	mm	Inch	mm
13570872N	13578		18.0	.7087		18.0		152		20.0		102		0.75
13575000N	13580	3/4		.7500	3/4		4		1		1-7/8		0.030	
13575001N	13581	3/4		.7500	3/4		5		1		2-7/8		0.030	
13575002N	13582	3/4		.7500	3/4		6		1		3-7/8		0.030	
13578740N	13594		20.0	.7874		20.0		102		22.0		50		0.75
13578701N3	96697		20.0	.7874		20.0		127		22.0		65		0.50
13578703N3	96698		20.0	.7874		20.0		127		22.0		65		1.00
13578704N3	96699		20.0	.7874		20.0		127		22.0		65		1.50
13578705N3	96700		20.0	.7874		20.0		127		22.0		65		2.00
13578707N3	96701		20.0	.7874		20.0		127		22.0		65		3.00
13578709N3	96702		20.0	.7874		20.0		127		22.0		65		4.00
135787011N3	96722		20.0	.7874		20.0		127		22.0		65		5.00
13578741N	13595		20.0	.7874		20.0		127		22.0		75		0.75
13578742N	13596		20.0	.7874		20.0		152		22.0		100		0.75
13578701N5	96703		20.0	.7874		20.0		152		22.0		105		0.50
13578703N5	96704		20.0	.7874		20.0		152		22.0		105		1.00
13578704N5	96705		20.0	.7874		20.0		152		22.0		105		1.50
13578705N5	96706		20.0	.7874		20.0		152		22.0		105		2.00
13578707N5	96707		20.0	.7874		20.0		152		22.0		105		3.00
13578709N5	96708		20.0	.7874		20.0		152		22.0		105		4.00
135787011N5	96724		20.0	.7874		20.0		152		22.0		105		5.00
13598430N	13597		25.0	.9843		25.0		102		25.0		36		0.75
13598431N	13598		25.0	.9843		25.0		127		25.0		61		0.75
13598401N3	96709		25.0	.9843		25.0		127		25.0		80		0.50
13598403N3	96710		25.0	.9843		25.0		127		25.0		80		1.00
13598404N3	96711		25.0	.9843		25.0		127		25.0		80		1.50
13598405N3	96712		25.0	.9843		25.0		127		25.0		80		2.00
13598407N3	96713		25.0	.9843		25.0		127		25.0		80		3.00
13598409N3	96714		25.0	.9843		25.0		127		25.0		80		4.00
13598432N	13599		25.0	.9843		25.0		152		25.0		86		0.75
13598401N5	96715		25.0	.9843		25.0		180		25.0		130		0.50
13598403N5	96716		25.0	.9843		25.0		180		25.0		130		1.00
13598404N5	96717		25.0	.9843		25.0		180		25.0		130		1.50
13598405N5	96718		25.0	.9843		25.0		180		25.0		130		2.00
13598407N5	96719		25.0	.9843		25.0		180		25.0		130		3.00
13598409N5	96720		25.0	.9843		25.0		180		25.0		130		4.00
13510000N	13590	1		1.0000	1		4		1-1/4		1-5/8		0.045	
13510001N	13591	1		1.0000	1		5		1-1/4		2-5/8		0.045	
13510002N	13592	1		1.0000	1		6		1-1/4		3-5/8		0.045	

135N
TuffCut® AL

HIGH PERFORMANCE



2
Flute

**TuffCut® AL
Series 135B**

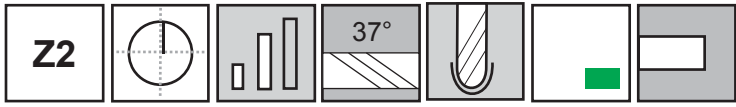

The geometry of M.A. Ford® 135 Series solid carbide end mill allows it to be run at extremely high chip loads surpassing the current market leaders.

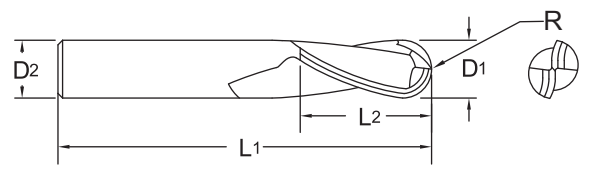

- Performs equally well across a broad range of operating speeds.
- Zirconium coating also available.

Uncoated		Diameter		Shank	OAL	Flute Length	
		D1		D2	L1	L2	
Tool No.	EDP	Inch	Decimal	Inch	Inch	Inch	
135B12500	13440	1/8	.1250	1/8	1-1/2	3/8	
135B12501	13442	1/8	.1250	1/8	2	1/2	
135B18750	13444	3/16	.1875	3/16	2	3/8	
135B18751	13446	3/16	.1875	3/16	2-1/2	5/8	
135B25000	13448	1/4	.2500	1/4	2-1/2	1/2	
135B25001	13450	1/4	.2500	1/4	2-1/2	3/4	
135B31250	13452	5/16	.3125	5/16	2-1/2	1/2	
135B31251	13454	5/16	.3125	5/16	2-1/2	13/16	
135B37500	13456	3/8	.3750	3/8	2-1/2	5/8	
135B37501	13458	3/8	.3750	3/8	2-1/2	1	
135B43750	13460	7/16	.4375	7/16	2-3/4	9/16	
135B43751	13462	7/16	.4375	7/16	2-3/4	1	
135B50000	13464	1/2	.5000	1/2	3	5/8	
135B50001	13466	1/2	.5000	1/2	3	1-1/4	
135B50002	13468	1/2	.5000	1/2	6	1-1/4	
135B62500	13470	5/8	.6250	5/8	3-1/2	1-1/4	
135B62501	13472	5/8	.6250	5/8	4	1-5/8	
135B75000	13474	3/4	.7500	3/4	4	1	
135B75001	13476	3/4	.7500	3/4	4	1-5/8	
135B10000	13478	1	1.0000	1	4	1-1/2	
135B10001	13480	1	1.0000	1	5	2-1/4	

Inch	
D1	Tolerance
1/8 - 1/4	+0.000/-0.002
> 1/4 - 1	+0.000/-0.003

Inch	
R	Tolerance
1/8 - 1	+0.0004/-0.0004



ISO 9001:2008 Certified

TuffCut® AL Series 135BN

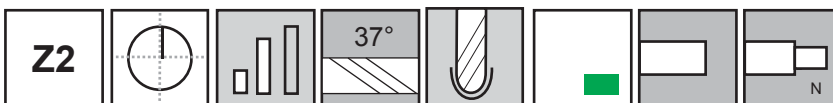

2
Flute
Ball

The geometry of M.A. Ford® 135 Series solid carbide end mill allows it to be run at extremely high chip loads surpassing the current market leaders.

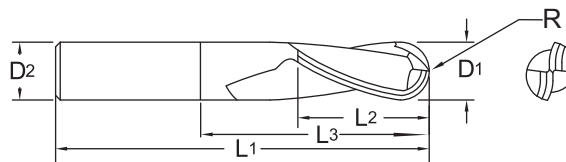

- Performs equally well across a broad range of operating speeds.
- Zirconium coating also available.

Uncoated		Diameter			Shank		OAL		Flute Length		Neck Length	
		D1			D2		L1		L2		L3	
Tool No.	EDP	Inch	mm	Decimal	Inch	mm	Inch	mm	Inch	mm	Inch	mm
135B0787N5	13252		2.0	.0787		6.0		75.0		4.0		12.0
135B1181N3	13236		3.0	.1181		3.0		38.0		5.0		11.0
135B1181N5	13254		3.0	.1181		6.0		75.0		5.0		17.0
135B1575N3	13238		4.0	.1575		4.0		51.0		6.0		14.0
135B1575N5	13256		4.0	.1575		6.0		75.0		6.0		22.0
135B1968N3	13240		5.0	.1968		5.0		64.0		7.0		17.0
135B1968N5	13258		5.0	.1968		6.0		75.0		7.0		27.0
135B2362N3	13242		6.0	.2362		6.0		64.0		8.0		20.0
135B2362N5	13260		6.0	.2362		6.0		110.0		8.0		32.0
135B25001N	13482	1/4		.2500	1/4		4		3/4		2-1/8	
135B31251N	13484	5/16		.3125	5/16		4		13/16		2-1/8	
135B3150N3	13244		8.0	.3150		8.0		64.0		10.0		26.0
135B3150N5	13262		8.0	.3150		8.0		110.0		10.0		42.0
135B37501N	13486	3/8		.3750	3/8		4		1		2-1/8	
135B3937N3	13246		10.0	.3937		10.0		70.0		12.0		32.0
135B3937N5	13264		10.0	.3937		10.0		110.0		12.0		52.0
135B4724N3	13248		12.0	.4724		12.0		76.0		16.0		38.0
135B4724N5	13266		12.0	.4724		12.0		120.0		16.0		62.0
135B50001N	13488	1/2		.5000	1/2		4		1-1/4		2-1/8	
135B62501N	13490	5/8		.6250	5/8		6		1-5/8		3-3/8	
135B6299N3	13250		16.0	.6299		16.0		89.0		20.0		50.0
135B6299N5	13268		16.0	.6299		16.0		130.0		20.0		82.0
135B75001N	13492	3/4		.7500	3/4		6		1-5/8		3-3/8	
135B10000N	13494	1		1.0000	1		6		1-1/2		3-1/4	

135B / 135BN
TuffCut® AL

HIGH PERFORMANCE



Page 332

Inch	
D1	Tolerance
1/4	+.000/-0.002
> 1/4 - 1	+.000/-0.003

Metric (mm)	
D1	Tolerance h10
2.00 - 3.00	+.000/-0.040
>3.00 - 6.00	+.000/-0.048
>6.00 - 10.00	+.000/-0.058
>10.00 - 16.00	+.000/-0.070

Inch	
R	Tolerance
1/4 - 1	+.0004/-0.0004

Metric (mm)	
R	Tolerance
2.0 - 16.0	+.01/-0.01

2
Flute

**TuffCut® AL
Series 136**

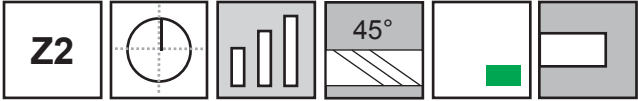

High performance aluminum finisher out performs competitors.

- Available with corner radius upon request. Call customer service for radius pricing.

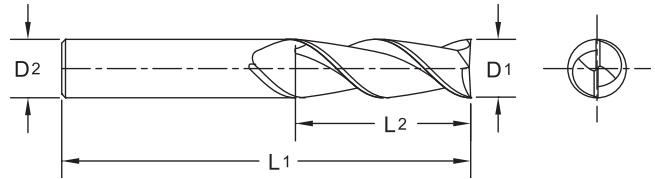

Uncoated		Diameter			Shank		OAL		Flute Length	
		D1			D2		L1		L2	
Tool No.	EDP	Inch	mm	Decimal	Inch	mm	Inch	mm	Inch	mm
13611810	13600		3.0	.1181		6.0		52		8.0
13612500	13641	1/8		.1250	1/8		1-1/2		1/4	
13612503	13671	1/8		.1250	1/8		1-1/2		3/8	
13612501	13642	1/8		.1250	1/8		1-1/2		1/2	
13612504	13672	1/8		.1250	1/8		2		3/4	
13612502	13643	1/8		.1250	1/8		2-1/2		1	
13615620	13673	5/32		.1562	5/32		2		5/16	
13615621	13674	5/32		.1562	5/32		2		9/16	
13615750	13602		4.0	.1575		6.0		55		11.0
13618750	13644	3/16		.1875	3/16		2		5/16	
13618753	13675	3/16		.1875	3/16		2		3/8	
13618751	13646	3/16		.1875	3/16		2-1/2		5/8	
13618754	13676	3/16		.1875	3/16		2-1/2		3/4	
13618752	13647	3/16		.1875	3/16		2-1/2		1	
13619680	13605		5.0	.1968		6.0		58		13.0
13623620	13610		6.0	.2362		6.0		58		13.0
13625003	13678	1/4		.2500	1/4		2		3/8	
13625004	13679	1/4		.2500	1/4		2		1/2	
13625005	13680	1/4		.2500	1/4		2-1/2		5/8	
13625000	13640	1/4		.2500	1/4		2-1/2		3/4	
13625006	13681	1/4		.2500	1/4		2-1/2		1	
13625007	13682	1/4		.2500	1/4		3		1-1/2	
13625001	13648	1/4		.2500	1/4		3-1/16		1-1/4	
13625002	13649	1/4		.2500	1/4		3-9/16		1-3/4	
13625008	13683	1/4		.2500	1/4		4		2	
13631253	13684	5/16		.3125	5/16		2		7/16	
13631250	13651	5/16		.3125	5/16		2		1/2	
13631254	13685	5/16		.3125	5/16		2-1/2		13/16	
13631252	13653	5/16		.3125	5/16		3-1/4		1-3/4	
13631251	13652	5/16		.3125	5/16		3-1/8		1-3/8	
13631500	13615		8.0	.3150		8.0		64		19.0
13637503	13686	3/8		.3750	3/8		2		1/2	
13637504	13687	3/8		.3750	3/8		2		5/8	
13637500	13645	3/8		.3750	3/8		2-1/2		3/4	

Inch	
D1	Tolerance
1/8 - 1/4	+0.00/-0.002
>1/4 - 1.0	+0.00/-0.003

Metric (mm)	
D1	Tolerance h10
3.00	+0.00/-0.040
>3.00 - 6.00	+0.00/-0.048
>6.00 - 10.00	+0.00/-0.058
>10.00 - 18.00	+0.00/-0.070
>18.00 - 20.00	+0.00/-0.084



Series 136 Continued

2
Flute

136
TuffCut® AL

HIGH PERFORMANCE

Uncoated		Diameter			Shank		OAL		Flute Length	
		D1			D2		L1		L2	
Tool No.	EDP	Inch	mm	Decimal	Inch	mm	Inch	mm	Inch	mm
13637505	13688	3/8		.3750	3/8		2-1/2		1	
13637506	13689	3/8		.3750	3/8		3		1-1/4	
13637501	13654	3/8		.3750	3/8		3-1/4		1-1/2	
13637507	13690	3/8		.3750	3/8		4		2	
13637502	13660	3/8		.3750	3/8		4-1/4		2-1/2	
13639370	13620		10.0	.3937		10.0		70		22.0
13647240	13625		12.0	.4724		12.0		84		26.0
13650003	13691	1/2		.5000	1/2		3		5/8	
13650004	13692	1/2		.5000	1/2		3		3/4	
13650005	13693	1/2		.5000	1/2		3		1	
13650000	13650	1/2		.5000	1/2		3-1/2		1-1/4	
13650006	13694	1/2		.5000	1/2		4		1-1/2	
13650001	13661	1/2		.5000	1/2		4		2	
13650007	13695	1/2		.5000	1/2		5		2-1/2	
13650002	13662	1/2		.5000	1/2		5		3	
13655120	13626		14.0	.5512		14.0		84		26.0
13662500	13663	5/8		.6250	5/8		3-1/2		3/4	
13662503	13696	5/8		.6250	5/8		3-1/2		1-1/4	
13662501	13664	5/8		.6250	5/8		3-3/4		1-5/8	
13662502	13665	5/8		.6250	5/8		4-5/8		2-1/2	
13662504	13697	5/8		.6250	5/8		5		2	
13662990	13630		16.0	.6299		16.0		89		32.0
13670870	13631		18.0	.7087		18.0		92		32.0
13675003	13698	3/4		.7500	3/4		4		1	
13675000	13655	3/4		.7500	3/4		4		1-5/8	
13675004	13699	3/4		.7500	3/4		5		2	
13675005	13601	3/4		.7500	3/4		5		2-1/2	
13675001	13666	3/4		.7500	3/4		5-1/4		3	
13675002	13667	3/4		.7500	3/4		6-1/4		4	
13678740	13635		20.0	.7874		20.0		102		38.0
13610000	13668	1		1.0000	1		4		1-1/4	
13610001	13669	1		1.0000	1		4-1/2		2	
13610003	13603	1		1.0000	1		6		3	
13610002	13670	1		1.0000	1		6-1/2		4	
13610004	13604	1		1.0000	1		8		5-1/2	



Page 328



TuffCut® Series 138 and 136 wiper flat end geometry with face grind protection (as shown in photo) provides improved floor finishes on customer parts.

For product information, call your local distributor.

3
Flute

**TuffCut® AL
Series 134**

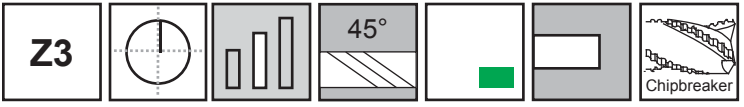

High helix 3 flute design ideal for rapid stock removal in aluminum alloys.

- Unique geometry.
- Improved chip flow and prevents chips from packing in flute.

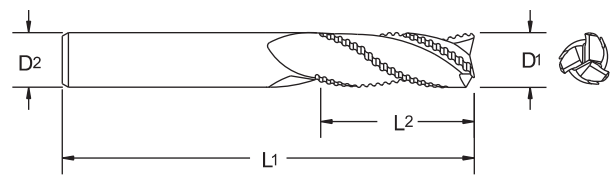

Uncoated		Diameter			Shank		OAL		Flute Length	
Tool No.	EDP	D1			D2		L1		L2	
		Inch	mm	Decimal	Inch	mm	Inch	mm	Inch	mm
13423620	13409		6.0	.2362		6.0		64		20.0
13425000	13411	1/4		.2500	1/4		2-1/2		3/4	
13431500	13414		8.0	.3150		8.0		64		20.0
13437500	13417	3/8		.3750	3/8		2-1/2		7/8	
13439370	13419		10.0	.3937		10.0		70		25.0
13447240	13423		12.0	.4724		12.0		76		25.0
13450000	13425	1/2		.5000	1/2		3		1-1/4	
13455120	95321		14.0	.5512		14.0		89		30.0
13462990	13429		16.0	.6299		16.0		89		30.0
13470870	13430		18.0	.7087		18.0		102		35.0
13475000	13431	3/4		.7500	3/4		4		1-1/2	
13478740	13433		20.0	.7874		20.0		102		38.0
13498430	13435		25.0	.9843		25.0		102		50.0
13410000	13401	1		1.0000	1		4		2	

Inch	
D1	Tolerance
1/4 - 1	+ .000/- .005

Metric (mm)	
D1	Tolerance
6.00 - 25.00	+ .000/- .127



3
Flute

**TuffCut® AL
Series 134S**

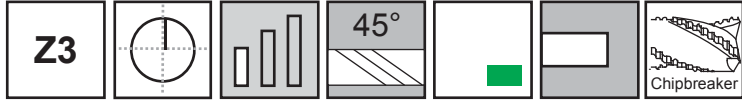

Uncoated		Diameter		Shank	OAL	Flute Length
Tool Number	EDP	D1	Decimal	D2	L1	L2
134S2500	13410	1/4	.2500	1/4	2	1/4
134S3750	13416	3/8	.3750	3/8	2-1/2	3/8
134S5000	13424	1/2	.5000	1/2	2-1/2	1/2
134S7500	13432	3/4	.7500	3/4	4	3/4
134S1000	13400	1	1.0000	1	4	1



**TuffCut® AL
Series 134N**

Z3



**3
Flute**

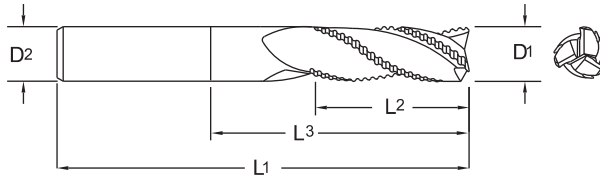

Uncoated		Diameter		Shank		OAL	Flute Length		Neck Length	
Tool No.	EDP	D1	Decimal	D2	L1	L2	L3			
13425000N	13412	1/4	.2500	1/4	3	1/4	3/4			
13425001N	13413	1/4	.2500	1/4	3	1/4	1-1/4			
13437500N	13415	3/8	.3750	3/8	3	1/2	1-1/8			
13437501N	13418	3/8	.3750	3/8	4	1/2	2-1/8			
13450000N	13426	1/2	.5000	1/2	4	5/8	1-1/8			
13450001N	13427	1/2	.5000	1/2	4	5/8	2-1/8			
13450002N	13428	1/2	.5000	1/2	6	5/8	3-1/8			
13475000N	13436	3/4	.7500	3/4	4	1	1-5/8			
13475001N	13437	3/4	.7500	3/4	5	1	2-5/8			
13475002N	13438	3/4	.7500	3/4	6	1	3-5/8			
13410000N	13439	1	1.0000	1	5	1-1/4	2-5/8			
13410001N	13441	1	1.0000	1	6	1-1/4	3-5/8			
13410002N	13443	1	1.0000	1	7	1-1/4	4-5/8			

Inch	
D1	Tolerance
1/4 - 1	+ .000/- .005

Metric (mm)	
D1	Tolerance
6.00 - 25.00	+ .000/- .127



Page 330

134 / 134S / 134N

TuffCut® AL

HIGH PERFORMANCE

ISO 9001:2008 Certified



For product information, call your local distributor.

3
Flute

**TuffCut® X-AL
Series 138 / 138R**

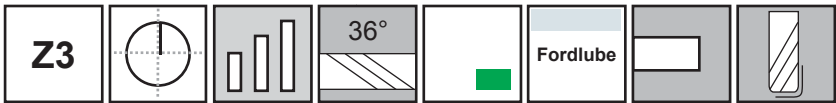

Series 138 takes aluminum milling to the extreme with chip loads and speeds, definitely designed for extreme productivity.

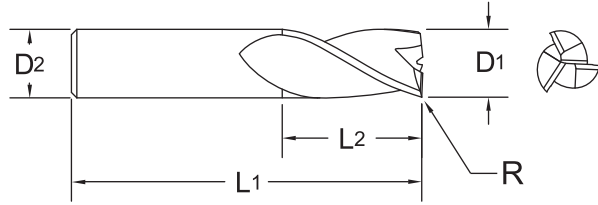

- Gem coating available upon request.

Uncoated		Fordlube*		Diameter			Shank		OAL		Flute Length		Corner Radius	
				D1			D2		L1		L2		R	
Tool No.	EDP	Tool No.	EDP	Inch	mm	Decimal	Inch	mm	Inch	mm	Inch	mm	Inch	mm
13811810	13892	13811810F	14295		3.0	.1181		6.0		52.0		8.0		
13811810R.020	13100				3.0	.1181		6.0		52.0		8.0		0.50
13811810R.039	13101				3.0	.1181		6.0		52.0		8.0		1.00
13812500	13800	13812500F	14203	1/8		.1250	1/8		1-1/2		3/16			
13812501	13801	13812501F	14204	1/8		.1250	1/8		1-1/2		1/4			
13812502	13802	13812502F	14205	1/8		.1250	1/8		1-1/2		5/16			
13812503	13803	13812503F	14206	1/8		.1250	1/8		1-1/2		3/8			
13812504	13804	13812504F	14207	1/8		.1250	1/8		1-1/2		1/2			
13812505	13805	13812505F	14208	1/8		.1250	1/8		1-1/2		5/8			
13812506	13806	13812506F	14209	1/8		.1250	1/8		2		3/4			
13812507	13807	13812507F	14210	1/8		.1250	1/8		2		1			
13815750	13893	13815750F	14296		4.0	.1575		6.0		55.0		11.0		
13815750R.020	13102				4.0	.1575		6.0		55.0		11.0		0.50
13815750R.039	13103				4.0	.1575		6.0		55.0		11.0		1.00
13818750	13808	13818750F	14211	3/16		.1875	3/16		2		1/4			
13818751	13809	13818751F	14212	3/16		.1875	3/16		2		3/8			
13818752	13810	13818752F	14213	3/16		.1875	3/16		2		1/2			
13818753	13811	13818753F	14214	3/16		.1875	3/16		2-1/2		5/8			
13818754	13812	13818754F	14215	3/16		.1875	3/16		2-1/2		3/4			
13818755	13813	13818755F	14216	3/16		.1875	3/16		2-1/2		1			
13819680	13894	13819680F	14297		5.0	.1968		6.0		58.0		13.0		
13819680R.020	13104				5.0	.1968		6.0		58.0		13.0		0.50
13819680R.039	13105				5.0	.1968		6.0		58.0		13.0		1.00
13823620	13895	13823620F	14298		6.0	.2362		6.0		58.0		13.0		
13823620R.020	13106				6.0	.2362		6.0		58.0		13.0		0.50
13823620R.039	13107				6.0	.2362		6.0		58.0		13.0		1.00
13823620R.059	13108				6.0	.2362		6.0		58.0		13.0		1.50
13823620R.079	13109				6.0	.2362		6.0		58.0		13.0		2.00

Inch	
D1	Tolerance
1/8 - 1-1/4	+ .000/- .0005

Metric (mm)	
D1	Tolerance
3.00 - 20.00	+ .000/- .013

*Allow 2 weeks to ship non-stock items. Weldon flats available. Please specify when ordering. When ordering Weldon flats please call customer service for pricing.

Inch	
R	Tolerance
1/8 - 1	+ .0008/- .0008

Metric (mm)	
R	Tolerance
3.0 - 20.0	+ .02/- .02



Series 138 / 138R Continued

3
Flute

Uncoated		Fordlube*		Diameter			Shank		OAL		Flute Length		Corner Radius	
Tool No.	EDP	Tool No.	EDP	D1			D2		L1		L2		R	
				Inch	mm	Decimal	Inch	mm	Inch	mm	Inch	mm	Inch	mm
13825000	13814	13825000F	14217	1/4		.2500	1/4		2		3/8			
13825000R.015	13000			1/4		.2500	1/4		2		3/8		0.015	
13825000R.030	13001			1/4		.2500	1/4		2		3/8		0.030	
13825001	13815	13825001F	14218	1/4		.2500	1/4		2		1/2			
13825002	13816	13825002F	14219	1/4		.2500	1/4		4		1/2			
13825003	13817	13825003F	14220	1/4		.2500	1/4		2		5/8			
13825004	13818	13825004F	14221	1/4		.2500	1/4		2-1/2		3/4			
13825004R.015	13002			1/4		.2500	1/4		2-1/2		3/4		0.015	
13825004R.030	13003			1/4		.2500	1/4		2-1/2		3/4		0.030	
13825005	13819	13825005F	14222	1/4		.2500	1/4		3		1			
13825006	13820	13825006F	14223	1/4		.2500	1/4		3		1-1/8			
13825007	13821	13825007F	14224	1/4		.2500	1/4		3		1-1/4			
13825007R.015	13004			1/4		.2500	1/4		3		1-1/4		0.015	
13825007R.030	13005			1/4		.2500	1/4		3		1-1/4		0.030	
13825008	13822	13825008F	14225	1/4		.2500	1/4		3		1-1/2			
13825009	13823	13825009F	14226	1/4		.2500	1/4		4		1-3/4			
13825010	13824	13825010F	14227	1/4		.2500	1/4		4		2			
13831200	13390			5/16		.3125	5/16		2-1/2		5/16			
13831250	13825	13831250F	14228	5/16		.3125	5/16		4		5/16			
13831201	13391			5/16		.3125	5/16		2-1/2		3/8			
13831251	13826	13831251F	14229	5/16		.3125	5/16		4		3/8			
13831202	13392			5/16		.3125	5/16		2-1/2		7/16			
13831252	13827	13831252F	14230	5/16		.3125	5/16		4		7/16			
13831203	13393			5/16		.3125	5/16		2-1/2		1/2			
13831253	13828	13831253F	14231	5/16		.3125	5/16		4		1/2			
13831254	13829	13831254F	14232	5/16		.3125	5/16		2-1/2		13/16			
13831255	13830	13831255F	14233	5/16		.3125	5/16		2-1/2		1-1/8			
13831256	13831	13831256F	14234	5/16		.3125	5/16		3-1/8		1-3/8			
13831257	13832	13831257F	14235	5/16		.3125	5/16		3		1-1/4			
13831258	13833	13831258F	14236	5/16		.3125	5/16		4		1-1/2			
13831500	13896	13831500F	14299		8.0	.3150		8.0		64.0		19.0		
13831500R.020	13110				8.0	.3150		8.0		64.0		19.0		0.50
13831500R.039	13111				8.0	.3150		8.0		64.0		19.0		1.00
13831500R.059	13112				8.0	.3150		8.0		64.0		19.0		1.50
13831500R.079	13113				8.0	.3150		8.0		64.0		19.0		2.00
13831500R.118	13114				8.0	.3150		8.0		64.0		19.0		3.00
13837500	13834	13837500F	14237	3/8		.3750	3/8		2		1/2			
13837500R.015	13006			3/8		.3750	3/8		2		1/2		0.015	
13837500R.030	13007			3/8		.3750	3/8		2		1/2		0.030	
13837501	13835	13837501F	14238	3/8		.3750	3/8		2-1/2		9/16			

*Allow 2 weeks to ship non-stock items.
Weldon flats available. Please specify when ordering.
When ordering Weldon flats please call customer service for pricing.

138 / 138R
TuffCut® X-AL

HIGH PERFORMANCE



3
Flute

Series 138 / 138R Continued

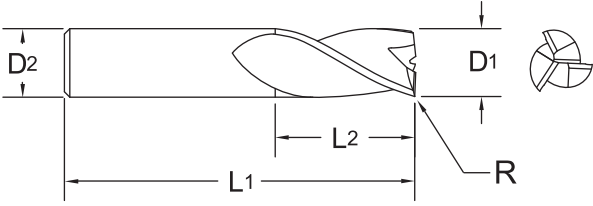
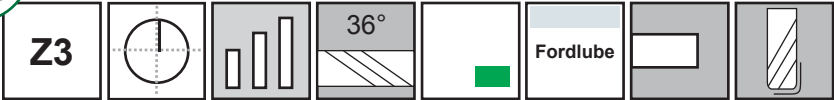

Uncoated		Fordlube*		Diameter			Shank		OAL		Flute Length		Corner Radius	
Tool No.	EDP	Tool No.	EDP	D1			D2		L1		L2		R	
Tool No.	EDP	Tool No.	EDP	Inch	mm	Decimal	Inch	mm	Inch	mm	Inch	mm	Inch	mm
13837502	13836	13837502F	14239	3/8		.3750	3/8		2		5/8			
13837503	13837	13837503F	14240	3/8		.3750	3/8		4		5/8			
13837504	13838	13837504F	14241	3/8		.3750	3/8		2-1/2		3/4			
13837505	13839	13837505F	14242	3/8		.3750	3/8		2-1/2		1			
13837505R.015	13008			3/8		.3750	3/8		2-1/2		1		0.015	
13837505R.030	13009			3/8		.3750	3/8		2-1/2		1		0.030	
13837506	13840	13837506F	14243	3/8		.3750	3/8		3		1-1/4			
13837507	13841	13837507F	14244	3/8		.3750	3/8		3-1/2		1-1/2			
13837507R.015	13010			3/8		.3750	3/8		3-1/2		1-1/2		0.015	
13837507R.030	13011			3/8		.3750	3/8		3-1/2		1-1/2		0.030	
13837508	13842	13837508F	14245	3/8		.3750	3/8		4		2			
13837509	13843	13837509F	14246	3/8		.3750	3/8		4-1/2		2-1/2			
13837510	13844	13837510F	14247	3/8		.3750	3/8		3		9/16			
13837511	13845	13837511F	14248	3/8		.3750	3/8		3		1			
13839370	13897	13839370F	14300		10.0	.3937		10.0		70.0		22.0		
13839370R.020	13115				10.0	.3937		10.0		70.0		22.0		0.50
13839370R.039	13116				10.0	.3937		10.0		70.0		22.0		1.00
13839370R.059	13117				10.0	.3937		10.0		70.0		22.0		1.50
13839370R.079	13118				10.0	.3937		10.0		70.0		22.0		2.00
13839370R.118	13119				10.0	.3937		10.0		70.0		22.0		3.00
13843750	13846	13843750F	14249	7/16		.4375	7/16		2-3/4		9/16			
13843751	13847	13843751F	14250	7/16		.4375	7/16		2-3/4		1			
13847240	13898	13847240F	14301		12.0	.4724		12.0		84.0		26.0		
13847240R.020	13120				12.0	.4724		12.0		84.0		26.0		0.50
13847240R.039	13121				12.0	.4724		12.0		84.0		26.0		1.00
13847240R.059	13122				12.0	.4724		12.0		84.0		26.0		1.50
13847240R.079	13123				12.0	.4724		12.0		84.0		26.0		2.00
13847240R.118	13124				12.0	.4724		12.0		84.0		26.0		3.00
13847240R.157	13125				12.0	.4724		12.0		84.0		26.0		4.00
13847240R.196	13126				12.0	.4724		12.0		84.0		26.0		5.00
13850000	13848	13850000F	14251	1/2		.5000	1/2		3		5/8			
13850000R.015	13012			1/2		.5000	1/2		3		5/8		0.015	

*Allow 2 weeks to ship non-stock items.
Weldon flats available. Please specify when ordering.
When ordering Weldon flats please call customer service for pricing.



Series 138 / 138R Continued

**3
Flute**

138 / 138R
TuffCut® X-AL

HIGH PERFORMANCE

Uncoated		Fordlube*		Diameter			Shank		OAL		Flute Length		Corner Radius	
Tool No.	EDP	Tool No.	EDP	D1			D2		L1		L2		R	
				Inch	mm	Decimal	Inch	mm	Inch	mm	Inch	mm	Inch	mm
13850000R.030	13013			1/2		.5000	1/2		3		5/8		0.030	
13850000R.060	13014			1/2		.5000	1/2		3		5/8		0.060	
13850000R.090	13015			1/2		.5000	1/2		3		5/8		0.090	
13850000R.120	13016			1/2		.5000	1/2		3		5/8		0.120	
13850001	13849	13850001F	14252	1/2		.5000	1/2		3		3/4			
13850002	13850	13850002F	14253	1/2		.5000	1/2		3		1			
13850003	13851	13850003F	14254	1/2		.5000	1/2		3		1-1/4			
13850003R.015	13017			1/2		.5000	1/2		3		1-1/4		0.015	
13850003R.030	13018			1/2		.5000	1/2		3		1-1/4		0.030	
13850003R.060	13019			1/2		.5000	1/2		3		1-1/4		0.060	
13850003R.090	13020			1/2		.5000	1/2		3		1-1/4		0.090	
13850003R.120	13021			1/2		.5000	1/2		3		1-1/4		0.120	
13850004	13852	13850004F	14255	1/2		.5000	1/2		4		1-1/2			
13850005	13853	13850005F	14256	1/2		.5000	1/2		4		2			
13850005R.015	13022			1/2		.5000	1/2		4		2		0.015	
13850005R.030	13023			1/2		.5000	1/2		4		2		0.030	
13850005R.060	13024			1/2		.5000	1/2		4		2		0.060	
13850005R.090	13025			1/2		.5000	1/2		4		2		0.090	
13850005R.120	13026			1/2		.5000	1/2		4		2		0.120	
13850006	13854	13850006F	14257	1/2		.5000	1/2		4		2-1/4			
13850007	13855	13850007F	14258	1/2		.5000	1/2		6		2-1/2			
13850008	13856	13850008F	14259	1/2		.5000	1/2		6		3-1/4			
13850009	13857	13850009F	14260	1/2		.5000	1/2		8		4			
13855120	13899	13855120F	14302		14.0	.5512		14.0		84.0		26.0		
13862500	13858	13862500F	14261	5/8		.6250	5/8		3-1/2		3/4			
13862500R.030	13027			5/8		.6250	5/8		3-1/2		3/4		0.030	
13862500R.060	13028			5/8		.6250	5/8		3-1/2		3/4		0.060	
13862500R.090	13029			5/8		.6250	5/8		3-1/2		3/4		0.090	
13862500R.120	13030			5/8		.6250	5/8		3-1/2		3/4		0.120	
13862501	13859	13862501F	14262	5/8		.6250	5/8		6		3/4			
13862502	13860	13862502F	14263	5/8		.6250	5/8		3-1/2		7/8			
13862503	13861	13862503F	14264	5/8		.6250	5/8		3-1/2		1-1/4			
13862504	13862	13862504F	14265	5/8		.6250	5/8		4		1-5/8			
13862504R.030	13031			5/8		.6250	5/8		4		1-5/8		0.030	
13862504R.060	13032			5/8		.6250	5/8		4		1-5/8		0.060	
13862504R.090	13033			5/8		.6250	5/8		4		1-5/8		0.090	
13862504R.120	13034			5/8		.6250	5/8		4		1-5/8		0.120	
13862505	13863	13862505F	14266	5/8		.6250	5/8		5		2			
13862506	13864	13862506F	14267	5/8		.6250	5/8		5		2-1/2			
13862506R.030	13035			5/8		.6250	5/8		5		2-1/2		0.030	
13862506R.060	13036			5/8		.6250	5/8		5		2-1/2		0.060	
13862506R.090	13037			5/8		.6250	5/8		5		2-1/2		0.090	

*Allow 2 weeks to ship non-stock items.
Weldon flats available. Please specify when ordering.
When ordering Weldon flats please call customer service for pricing.



3
Flute

Series 138 / 138R Continued

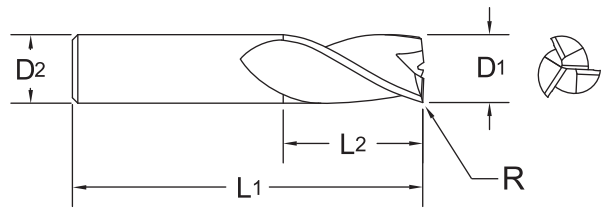
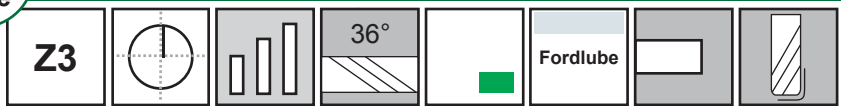

Uncoated		Fordlube*		Diameter			Shank		OAL		Flute Length		Corner Radius	
Tool No.	EDP	Tool No.	EDP	D1			D2		L1		L2		R	
				Inch	mm	Decimal	Inch	mm	Inch	mm	Inch	mm	Inch	mm
13862506R.120	13038			5/8		.6250	5/8		5		2-1/2		0.120	
13862507	13865	13862507F	14268	5/8		.6250	5/8		6		3-1/4			
13862990	13900	13862990F	14303		16.0	.6299		16.0		89.0		32.0		
13862990R.020	13127				16.0	.6299		16.0		89.0		32.0		0.50
13862990R.039	13128				16.0	.6299		16.0		89.0		32.0		1.00
13862990R.059	13129				16.0	.6299		16.0		89.0		32.0		1.50
13862990R.079	13130				16.0	.6299		16.0		89.0		32.0		2.00
13862990R.118	13131				16.0	.6299		16.0		89.0		32.0		3.00
13862990R.157	13132				16.0	.6299		16.0		89.0		32.0		4.00
13862990R.196	13133				16.0	.6299		16.0		89.0		32.0		5.00
13870870	13901	13870870F	14304		18.0	.7087		18.0		92.0		32.0		
13875000	13866	13875000F	14269	3/4		.7500	3/4		4		3/4			
13875001	13867	13875001F	14270	3/4		.7500	3/4		4		1			
13875001R.030	13039			3/4		.7500	3/4		4		1		0.030	
13875001R.060	13040			3/4		.7500	3/4		4		1		0.060	
13875001R.090	13041			3/4		.7500	3/4		4		1		0.090	
13875001R.120	13042			3/4		.7500	3/4		4		1		0.120	
13875001R.190	13043			3/4		.7500	3/4		4		1		0.190	
13875001R.250	13044			3/4		.7500	3/4		4		1		0.250	
13875002	13868	13875002F	14271	3/4		.7500	3/4		6		1			
13875003	13869	13875003F	14272	3/4		.7500	3/4		6		1-1/2			
13875004	13870	13875004F	14273	3/4		.7500	3/4		4		1-5/8			
13875004R.030	13045			3/4		.7500	3/4		4		1-5/8		0.030	
13875004R.060	13046			3/4		.7500	3/4		4		1-5/8		0.060	
13875004R.090	13047			3/4		.7500	3/4		4		1-5/8		0.090	
13875004R.120	13048			3/4		.7500	3/4		4		1-5/8		0.120	
13875004R.190	13049			3/4		.7500	3/4		4		1-5/8		0.190	
13875004R.250	13050			3/4		.7500	3/4		4		1-5/8		0.250	
13875005	13871	13875005F	14274	3/4		.7500	3/4		5		2			
13875006	13872	13875006F	14275	3/4		.7500	3/4		5		2-1/4			
13875007	13873	13875007F	14276	3/4		.7500	3/4		5		2-1/2			
13875007R.030	13051			3/4		.7500	3/4		5		2-1/2			.030

*Allow 2 weeks to ship non-stock items.
Weldon flats available. Please specify when ordering.
When ordering Weldon flats please call customer service for pricing.



Series 138 / 138R Continued

**3
Flute**

138 / 138R
TurffCut® X-AL

HIGH PERFORMANCE

Uncoated		Fordlube*		Diameter			Shank		OAL		Flute Length		Corner Radius	
Tool No.	EDP	Tool No.	EDP	D1			D2		L1		L2		R	
				Inch	mm	Decimal	Inch	mm	Inch	mm	Inch	mm	Inch	mm
13875007R.060	13052			3/4		.7500	3/4		5		2-1/2			.060
13875007R.090	13053			3/4		.7500	3/4		5		2-1/2			.090
13875007R.120	13054			3/4		.7500	3/4		5		2-1/2			.120
13875007R.190	13055			3/4		.7500	3/4		5		2-1/2			.190
13875007R.250	13056			3/4		.7500	3/4		5		2-1/2			.250
13875008	13874	13875008F	14277	3/4		.7500	3/4		6		3			
13875009	13875	13875009F	14278	3/4		.7500	3/4		6		3-1/4			
13875010	13876	13875010F	14279	3/4		.7500	3/4		6		3-1/2			
13875011	13877	13875011F	14280	3/4		.7500	3/4		6-1/4		4			
13875012	13878	13875012F	14281	3/4		.7500	3/4		8		5			
13878740	13902	13878740F	14305		20.0	.7874		20.0		102.0		38.0		
13878740R.020	13134				20.0	.7874		20.0		102.0		38.0		0.50
13878740R.039	13135				20.0	.7874		20.0		102.0		38.0		1.00
13878740R.059	13136				20.0	.7874		20.0		102.0		38.0		1.50
13878740R.079	13137				20.0	.7874		20.0		102.0		38.0		2.00
13878740R.118	13138				20.0	.7874		20.0		102.0		38.0		3.00
13878740R.157	13139				20.0	.7874		20.0		102.0		38.0		4.00
13878740R.196	13140				20.0	.7874		20.0		102.0		38.0		5.00
13810000	13879	13810000F	14282	1.00		1.0000	1		6		1-1/4			
13810001	13880	13810001F	14283	1.00		1.0000	1		8		1-1/4			
13810002	13881	13810002F	14284	1.00		1.0000	1		4		1-1/2			
13810002R.030	13057			1.00		1.0000	1		4		1-1/2		0.030	
13810002R.060	13058			1.00		1.0000	1		4		1-1/2		0.060	
13810002R.090	13059			1.00		1.0000	1		4		1-1/2		0.090	
13810002R.120	13060			1.00		1.0000	1		4		1-1/2		0.120	
13810002R.190	13061			1.00		1.0000	1		4		1-1/2		0.190	
13810002R.250	13062			1.00		1.0000	1		4		1-1/2		0.250	
13810003	13882	13810003F	14285	1.00		1.0000	1		5		2			
13810004	13883	13810004F	14286	1.00		1.0000	1		5		2-1/2			
13810004R.030	13063			1.00		1.0000	1		5		2-1/2		0.030	
13810004R.060	13064			1.00		1.0000	1		5		2-1/2		0.060	
13810004R.090	13065			1.00		1.0000	1		5		2-1/2		0.090	
13810004R.120	13066			1.00		1.0000	1		5		2-1/2		0.120	
13810004R.190	13067			1.00		1.0000	1		5		2-1/2		0.190	
13810004R.250	13068			1.00		1.0000	1		5		2-1/2		0.250	
13810005	13884	13810005F	14287	1.00		1.0000	1		6		3			
13810006	13885	13810006F	14288	1.00		1.0000	1		6		3-1/2			
13810006R.030	13069			1.00		1.0000	1		6		3-1/2		0.030	
13810006R.060	13070			1.00		1.0000	1		6		3-1/2		0.060	
13810006R.090	13071			1.00		1.0000	1		6		3-1/2		0.090	
13810006R.120	13072			1.00		1.0000	1		6		3-1/2		0.120	
13810006R.190	13073			1.00		1.0000	1		6		3-1/2		0.190	

*Allow 2 weeks to ship non-stock items.
Weldon flats available. Please specify when ordering.
When ordering Weldon flats please call customer service for pricing.



3
Flute

Series 138 / 138R Continued

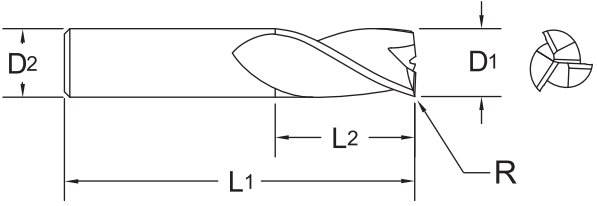
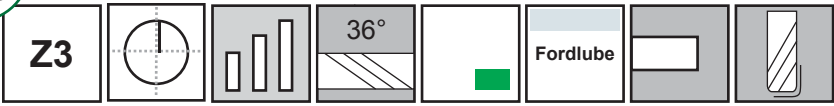

Uncoated		Fordlube*		Diameter			Shank		OAL		Flute Length		Corner Radius	
Tool No.	EDP	Tool No.	EDP	D1			D2		L1		L2		R	
				Inch	mm	Decimal	Inch	mm	Inch	mm	Inch	mm	Inch	mm
13810006R.250	13074			1.00		1.0000	1		6		3-1/2		0.250	
13810007	13886	13810007F	14289	1.00		1.0000	1		6		4			
13810008	13887	13810008F	14290	1.00		1.0000	1		7		4-1/8			
13810009	13888	13810009F	14291	1.00		1.0000	1		8		5-1/2			
13812510	13889	13812510F	14292	1-1/4		1.2500	1-1/4		6		2			
13812511	13890	13812511F	14293	1-1/4		1.2500	1-1/4		8		5			
13812512	13891	13812512F	14294	1-1/4		1.2500	1-1/4		12		2			



*Allow 2 weeks to ship non-stock items.
Weldon flats available. Please specify when ordering.
When ordering Weldon flats please call customer service for pricing.



TuffCut® X-AL Series 138N / 138NR



3
Flute

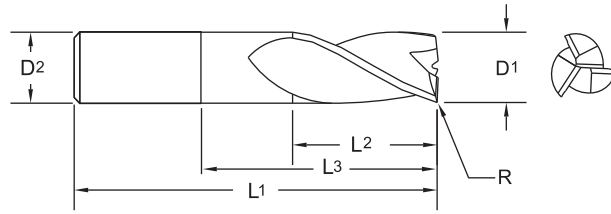

Uncoated		Fordlube*		Diameter		Shank	OAL	Flute Length	Neck Length	Corner Radius
Tool No.	EDP	Tool No.	EDP	D1	Decimal	D2	L1	L2	L3	R
13812508N	14120			1/8	.1250	1/8	2	3/16	1/2	
13812508NR.015	11790			1/8	.1250	1/8	2	3/16	1/2	.015
13812509N	14121			1/8	.1250	1/8	2	3/16	3/4	
13812509NR.015	11792			1/8	.1250	1/8	2	3/16	3/4	.015
13812550N	14122			1/8	.1250	1/8	2	3/16	1	
13812550NR.015	11794			1/8	.1250	1/8	2	3/16	1	.015
13818750N	14123			3/16	.1875	3/16	2	1/4	1/2	
13818750NR.015	11796			3/16	.1875	3/16	2	1/4	1/2	.015
13818756N	14124			3/16	.1875	3/16	2	1/4	3/4	
13818756NR.015	11798			3/16	.1875	3/16	2	1/4	3/4	.015
13818757N	14125			3/16	.1875	3/16	2	1/4	1	
13818757NR.015	11800			3/16	.1875	3/16	2	1/4	1	.015
13825002N	14450	13825002NF	14459	1/4	.2500	1/4	4	1/2	1-1/8	
13825002NR.015	11806			1/4	.2500	1/4	4	1/2	1-1/8	.015
13825002NR.030	11808			1/4	.2500	1/4	4	1/2	1-1/8	.030
13825011N	14126			1/4	.2500	1/4	4	1/2	3/4	
13825011NR.015	11802			1/4	.2500	1/4	4	1/2	3/4	.015
13825011NR.030	11804			1/4	.2500	1/4	4	1/2	3/4	.030
13825012N	14127			1/4	.2500	1/4	4	1/2	2-1/8	
13825012NR.015	11810			1/4	.2500	1/4	4	1/2	2-1/8	.015
13825012NR.030	11812			1/4	.2500	1/4	4	1/2	2-1/8	.030
13831210N	14128			5/16	.3125	5/16	6	7/16	3-1/8	
13831210NR.015	11822			5/16	.3125	5/16	6	7/16	3-1/8	.015
13831210NR.030	11824			5/16	.3125	5/16	6	7/16	3-1/8	.030
13831252N	14451	13831252NF	14460	5/16	.3125	5/16	4	7/16	2-1/8	
13831252NR.015	11818			5/16	.3125	5/16	4	7/16	2-1/8	.015
13831252NR.030	11820			5/16	.3125	5/16	4	7/16	2-1/8	.030
13831259N	14129			5/16	.3125	5/16	4	7/16	1-1/8	
13831259NR.015	11814			5/16	.3125	5/16	4	7/16	1-1/8	.015
13831259NR.030	11816			5/16	.3125	5/16	4	7/16	1-1/8	.030
13837503N	14452	13837503NF	14461	3/8	.3750	3/8	4	5/8	2-1/8	
13837503NR.015	11832			3/8	.3750	3/8	4	5/8	2-1/8	.015
13837503NR.030	11834			3/8	.3750	3/8	4	5/8	2-1/8	.030
13837503NR.060	11836			3/8	.3750	3/8	4	5/8	2-1/8	.060

Inch	
D1	Tolerance
1/8 - 1.0	+ .000/- .0005

Inch	
R	Tolerance
1/8 - 1	+ .0008/- .0008

138 / 138R / 138N / 138NR

TuffCut® X-AL

HIGH PERFORMANCE

*Allow 2 weeks to ship non-stock items.
Weldon flats available. Please specify when ordering.
When ordering Weldon flats please call customer service for pricing.



3
Flute

Series 138N / 138NR Continued

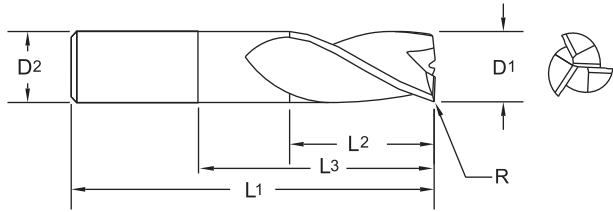
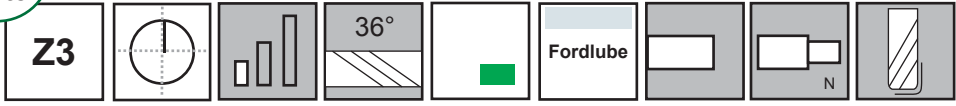

Uncoated		Fordlube*		Diameter		Shank	OAL	Flute Length	Neck Length	Corner Radius
Tool No.	EDP	Tool No.	EDP	D1	Decimal	D2	L1	L2	L3	R
13837512N	14130			3/8	.3750	3/8	4	5/8	1-1/8	
13837512NR.015	11826			3/8	.3750	3/8	4	5/8	1-1/8	.015
13837512NR.030	11828			3/8	.3750	3/8	4	5/8	1-1/8	.030
13837512NR.060	11830			3/8	.3750	3/8	4	5/8	1-1/8	.060
13837513N	14131			3/8	.3750	3/8	6	5/8	3-1/8	
13837513NR.015	11838			3/8	.3750	3/8	6	5/8	3-1/8	.015
13837513NR.030	11840			3/8	.3750	3/8	6	5/8	3-1/8	.030
13837513NR.060	11842			3/8	.3750	3/8	6	5/8	3-1/8	.060
13850000N	14453	13850000NF	14462	1/2	.5000	1/2	3	5/8	1-3/8	
13850010N	14454	13850010NF	14463	1/2	.5000	1/2	4	5/8	2-3/8	
13850010NR.015	11854			1/2	.5000	1/2	4	5/8	2-3/8	.015
13850010NR.030	11856			1/2	.5000	1/2	4	5/8	2-3/8	.030
13850010NR.060	11858			1/2	.5000	1/2	4	5/8	2-3/8	.060
13850010NR.090	11860			1/2	.5000	1/2	4	5/8	2-3/8	.090
13850010NR.120	11862			1/2	.5000	1/2	4	5/8	2-3/8	.120
13850011N	14455	13850011NF	14464	1/2	.5000	1/2	6	3/4	3-3/8	
13850011NR.015	11864			1/2	.5000	1/2	6	3/4	3-3/8	.015
13850011NR.030	11866			1/2	.5000	1/2	6	3/4	3-3/8	.030
13850011NR.060	11868			1/2	.5000	1/2	6	3/4	3-3/8	.060
13850011NR.090	11870			1/2	.5000	1/2	6	3/4	3-3/8	.090
13850011NR.120	11872			1/2	.5000	1/2	6	3/4	3-3/8	.120
13850012N	14132			1/2	.5000	1/2	4	5/8	1-3/8	
13850012NR.015	11844			1/2	.5000	1/2	4	5/8	1-3/8	.015
13850012NR.030	11846			1/2	.5000	1/2	4	5/8	1-3/8	.030
13850012NR.060	11848			1/2	.5000	1/2	4	5/8	1-3/8	.060
13850012NR.090	11850			1/2	.5000	1/2	4	5/8	1-3/8	.090
13850012NR.120	11852			1/2	.5000	1/2	4	5/8	1-3/8	.120
13850013N	14133			1/2	.5000	1/2	6	3/4	4-3/8	
13850013NR.015	11874			1/2	.5000	1/2	6	3/4	4-3/8	.015
13850013NR.030	11876			1/2	.5000	1/2	6	3/4	4-3/8	.030
13850013NR.060	11878			1/2	.5000	1/2	6	3/4	4-3/8	.060
13850013NR.090	11880			1/2	.5000	1/2	6	3/4	4-3/8	.090
13850013NR.120	11882			1/2	.5000	1/2	6	3/4	4-3/8	.120
13862501N	14456	13862501NF	14465	5/8	.6250	5/8	6	3/4	3-3/8	

*Allow 2 weeks to ship non-stock items.
Weldon flats available. Please specify when ordering.
When ordering Weldon flats please call customer service for pricing.



Series 138N / 138NR Continued

Uncoated		Fordlube*		Diameter		Shank	OAL	Flute Length	Neck Length	Corner Radius
Tool No.	EDP	Tool No.	EDP	D1	Decimal	D2	L1	L2	L3	R
13862501NR.030	11900			5/8	.6250	5/8	6	3/4	3-3/8	.030
13862501NR.060	11902			5/8	.6250	5/8	6	3/4	3-3/8	.060
13862501NR.090	11904			5/8	.6250	5/8	6	3/4	3-3/8	.090
13862501NR.120	11906			5/8	.6250	5/8	6	3/4	3-3/8	.120
13862508N	14134			5/8	.6250	5/8	4	3/4	1-3/8	
13862508NR.030	11884			5/8	.6250	5/8	4	3/4	1-3/8	.030
13862508NR.060	11886			5/8	.6250	5/8	4	3/4	1-3/8	.060
13862508NR.090	11888			5/8	.6250	5/8	4	3/4	1-3/8	.090
13862508NR.120	11890			5/8	.6250	5/8	4	3/4	1-3/8	.120
13862509N	14135			5/8	.6250	5/8	6	3/4	2-3/8	
13862509NR.030	11892			5/8	.6250	5/8	6	3/4	2-3/8	.030
13862509NR.060	11894			5/8	.6250	5/8	6	3/4	2-3/8	.060
13862509NR.090	11896			5/8	.6250	5/8	6	3/4	2-3/8	.090
13862509NR.120	11898			5/8	.6250	5/8	6	3/4	2-3/8	.120
13875002N	14457	13875002NF	14466	3/4	.7500	3/4	6	1	3-3/8	
13875002NR.030	11932			3/4	.7500	3/4	6	1	3-3/8	.030
13875002NR.060	11934			3/4	.7500	3/4	6	1	3-3/8	.060
13875002NR.090	11936			3/4	.7500	3/4	6	1	3-3/8	.090
13875002NR.120	11938			3/4	.7500	3/4	6	1	3-3/8	.120
13875002NR.190	11940			3/4	.7500	3/4	6	1	3-3/8	.190
13875002NR.250	11942			3/4	.7500	3/4	6	1	3-3/8	.250
13875013N	14136			3/4	.7500	3/4	6	1	1-3/8	
13875013NR.030	11908			3/4	.7500	3/4	6	1	1-3/8	.030
13875013NR.060	11910			3/4	.7500	3/4	6	1	1-3/8	.060
13875013NR.090	11912			3/4	.7500	3/4	6	1	1-3/8	.090
13875013NR.120	11914			3/4	.7500	3/4	6	1	1-3/8	.120
13875013NR.190	11916			3/4	.7500	3/4	6	1	1-3/8	.190
13875013NR.250	11918			3/4	.7500	3/4	6	1	1-3/8	.250
13875014N	14137			3/4	.7500	3/4	6	1	2-3/8	
13875014NR.030	11920			3/4	.7500	3/4	6	1	2-3/8	.030
13875014NR.060	11922			3/4	.7500	3/4	6	1	2-3/8	.060
13875014NR.090	11924			3/4	.7500	3/4	6	1	2-3/8	.090
13875014NR.120	11926			3/4	.7500	3/4	6	1	2-3/8	.120
13875014NR.190	11928			3/4	.7500	3/4	6	1	2-3/8	.190
13875014NR.250	11930			3/4	.7500	3/4	6	1	2-3/8	.250
13810000N	14458	13810000NF	14467	1	1.0000	1	6	1-1/4	3-3/8	
13810000NR.030	11956			1	1.0000	1	6	1-1/4	3-3/8	.030
13810000NR.060	11958			1	1.0000	1	6	1-1/4	3-3/8	.060
13810000NR.090	11960			1	1.0000	1	6	1-1/4	3-3/8	.090
13810000NR.120	11962			1	1.0000	1	6	1-1/4	3-3/8	.120
13810000NR.190	11964			1	1.0000	1	6	1-1/4	3-3/8	.190
13810000NR.250	11966			1	1.0000	1	6	1-1/4	3-3/8	.250
13810010N	14138			1	1.0000	1	6	1-1/4	2-3/8	
13810010NR.030	11944			1	1.0000	1	6	1-1/4	2-3/8	.030

*Allow 2 weeks to ship non-stock items.
Weldon flats available. Please specify when ordering.
When ordering Weldon flats please call customer service for pricing.



3
Flute

Series 138N / 138NR Continued

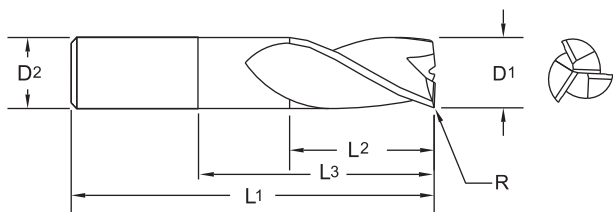

Uncoated		Fordlube*		Diameter		Shank	OAL	Flute Length	Neck Length	Corner Radius
Tool No.	EDP	Tool No.	EDP	D1	Decimal	D2	L1	L2	L3	R
13810010NR.060	11946			1	1.0000	1	6	1-1/4	2-3/8	.060
13810010NR.090	11948			1	1.0000	1	6	1-1/4	2-3/8	.090
13810010NR.120	11950			1	1.0000	1	6	1-1/4	2-3/8	.120
13810010NR.190	11952			1	1.0000	1	6	1-1/4	2-3/8	.190
13810010NR.250	11954			1	1.0000	1	6	1-1/4	2-3/8	.250
13810011N	14139			1	1.0000	1	7	1-1/4	4-3/8	
13810011NR.030	11968			1	1.0000	1	7	1-1/4	4-3/8	.030
13810011NR.060	11970			1	1.0000	1	7	1-1/4	4-3/8	.060
13810011NR.090	11972			1	1.0000	1	7	1-1/4	4-3/8	.090
13810011NR.120	11974			1	1.0000	1	7	1-1/4	4-3/8	.120
13810011NR.190	11976			1	1.0000	1	7	1-1/4	4-3/8	.190
13810011NR.250	11978			1	1.0000	1	7	1-1/4	4-3/8	.250



*Allow 2 weeks to ship non-stock items.
Weldon flats available. Please specify when ordering.
When ordering Weldon flats please call customer service for pricing.

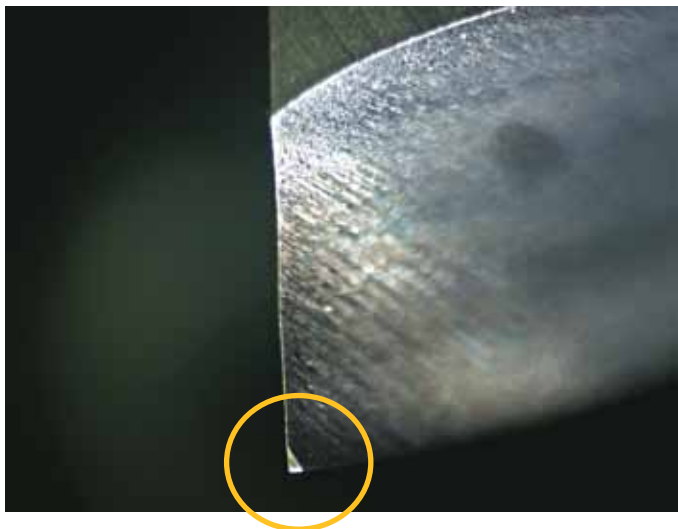

TuffCut® Series 138 and 136 wiper flat end geometry with face grind protection (as shown in above photo) provides improved floor finishes on customer parts.

TuffCut® X-AL Series 138CE

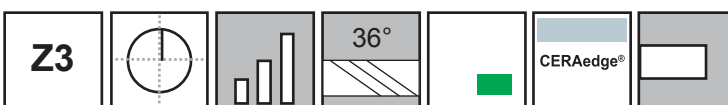

3
Flute

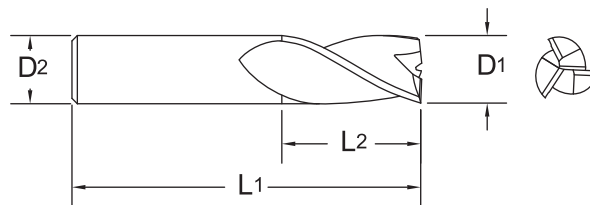

CERAedge®		Diameter			Shank		OAL		Flute Length	
		D1			D2		L1		L2	
Tool No.	EDP	Inch	mm	Decimal	Inch	mm	Inch	mm	Inch	mm
13812501CE	07988	1/8		.1250	1/8		1-1/2		1/4	
13812503CE	07990	1/8		.1250	1/8		1-1/2		3/8	
13812504CE	07992	1/8		.1250	1/8		1-1/2		1/2	
13812506CE	07994	1/8		.1250	1/8		2		3/4	
13818751CE	07996	3/16		.1875	3/16		2		3/8	
13818752CE	07998	3/16		.1875	3/16		2		1/2	
13818753CE	08000	3/16		.1875	3/16		2-1/2		5/8	
13818754CE	08002	3/16		.1875	3/16		2-1/2		3/4	
13818755CE	08004	3/16		.1875	3/16		2-1/2		1	
13823620CE	08006		6.0	.2362		6.0		58.0		13.0
13825000CE	08008	1/4		.2500	1/4		2		3/8	
13825001CE	08010	1/4		.2500	1/4		2		1/2	
13825003CE	08012	1/4		.2500	1/4		2		5/8	
13825004CE	08014	1/4		.2500	1/4		2-1/2		3/4	
13825005CE	08016	1/4		.2500	1/4		3		1	
13825007CE	08018	1/4		.2500	1/4		3		1-1/4	
13831500CE	08020		8.0	.3150		8.0		64.0		19.0
13837500CE	08022	3/8		.3750	3/8		2		1/2	
13837504CE	08024	3/8		.3750	3/8		2-1/2		3/4	
13837505CE	08026	3/8		.3750	3/8		2-1/2		1	
13837506CE	08028	3/8		.3750	3/8		3		1-1/4	
13837507CE	08030	3/8		.3750	3/8		3-1/2		1-1/2	
13837508CE	08032	3/8		.3750	3/8		4		2	
13839370CE	08034		10.0	.3937		10.0		70.0		22.0
13847240CE	08036		12.0	.4724		12.0		84.0		26.0
13850000CE	08038	1/2		.5000	1/2		3		5/8	
13850001CE	08040	1/2		.5000	1/2		3		3/4	
13850002CE	08042	1/2		.5000	1/2		3		1	
13850003CE	08044	1/2		.5000	1/2		3		1-1/4	
13850004CE	08046	1/2		.5000	1/2		4		1-1/2	

M.A. FORD® APG

CERAedge®

Hardness that makes it the 3rd hardest material when compared to industrial diamonds.

- Toughness that is comparable to Titanium.
- Lubricity that approaches Teflon.
- Extreme heat tolerance.
- Non-reactive to Titanium.

CERAedge® Coating Properties	
Microhardness (HV)	3400
Max. Service Temperature	1100° C / 2012° F
Friction Coefficient	0.25
Coating Thickness	2-3 microns
Color	Light Gray



Page 334

Inch		Metric (mm)	
D1	Tolerance	D1	Tolerance
1/8 - 1	+0.000/-0.0005	6.00 - 20.00	+0.000/-0.013

138N / 138NR / 138CE

TuffCut® X-AL

HIGH PERFORMANCE

3
Flute

**TuffCut® X-AL
Series 138CE**

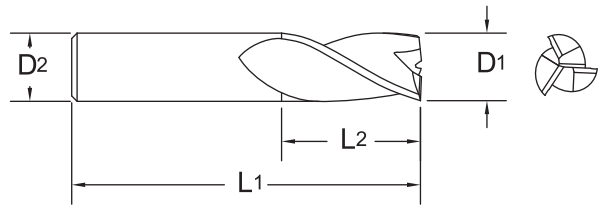
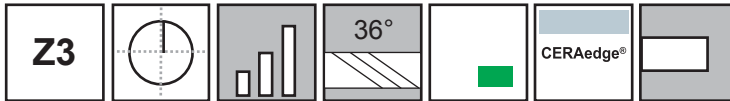

CERAAedge®		Diameter			Shank		OAL		Flute Length	
		D1			D2		L1		L2	
Tool No.	EDP	Inch	mm	Decimal	Inch	mm	Inch	mm	Inch	mm
13850005CE	08048	1/2		.5000	1/2		4		2	
13850006CE	08050	1/2		.5000	1/2		4		2-1/4	
13850007CE	08052	1/2		.5000	1/2		6		2-1/2	
13855120CE	08054		14.0	.5512		14.0		84.0		26.0
13862503CE	08056	5/8		.6250	5/8		3-1/2		1-1/4	
13862504CE	08058	5/8		.6250	5/8		4		1-5/8	
13862506CE	08060	5/8		.6250	5/8		5		2-1/2	
13862507CE	08062	5/8		.6250	5/8		6		3-1/4	
13862990CE	08064		16.0	.6299		16.0		89.0		32.0
13875001CE	08066	3/4		.7500	3/4		4		1	
13875004CE	08068	3/4		.7500	3/4		4		1-5/8	
13875005CE	08070	3/4		.7500	3/4		5		2	
13875006CE	08072	3/4		.7500	3/4		5		2-1/4	
13875007CE	08074	3/4		.7500	3/4		5		2-1/2	
13875008CE	08076	3/4		.7500	3/4		6		3	
13878740CE	08078		20.0	.7874		20.0		102.0		38.0
13810002CE	08080	1		1.0000	1		4		1-1/2	
13810003CE	08082	1		1.0000	1		5		2	
13810005CE	08084	1		1.0000	1		6		3	
13810006CE	08086	1		1.0000	1		6		3-1/2	



Page 334

ISO 9001:2008 Certified



TuffCut® X-AL Series 138B

Z3

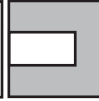
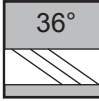
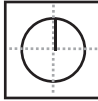

3
Flute
Ball

Designed for extreme productivity.

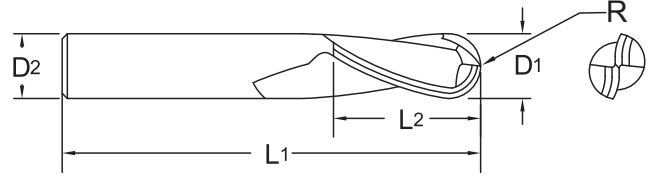

Uncoated		Diameter			Shank		OAL		Flute Length	
		D1			D2		L1		L2	
Tool No.	EDP	Inch	mm	Decimal	Inch	mm	Inch	mm	Inch	mm
138B11810	13356		3.0	.1181		3.0		38.0		12.0
138B12500	13300	1/8		.1250	1/8		1-1/2		3/8	
138B12501	13302	1/8		.1250	1/8		2		1/2	
138B15750	13358		4.0	.1575		4.0		51.0		15.0
138B18750	13304	3/16		.1875	3/16		2		3/8	
138B18751	13306	3/16		.1875	3/16		2-1/2		5/8	
138B19680	13360		5.0	.1968		5.0		64.0		20.0
138B23620	13362		6.0	.2362		6.0		64.0		20.0
138B25000	13308	1/4		.2500	1/4		2-1/2		1/2	
138B25001	13310	1/4		.2500	1/4		2-1/2		3/4	
138B31250	13312	5/16		.3125	5/16		2-1/2		1/2	
138B31251	13314	5/16		.3125	5/16		2-1/2		13/16	
138B31500	13364		8.0	.3150		8.0		64.0		20.0
138B37500	13316	3/8		.3750	3/8		2-1/2		5/8	
138B37501	13318	3/8		.3750	3/8		2-1/2		1	
138B39370	13366		10.0	.3937		10.0		70.0		25.0
138B43750	13320	7/16		.4375	7/16		2-3/4		9/16	
138B43751	13322	7/16		.4375	7/16		2-3/4		1	
138B47240	13368		12.0	.4724		12.0		76.0		25.0
138B50000	13324	1/2		.5000	1/2		3		5/8	
138B50001	13326	1/2		.5000	1/2		3		1-1/4	
138B50002	13328	1/2		.5000	1/2		6		1-1/4	
138B62500	13330	5/8		.6250	5/8		3-1/2		1-1/4	
138B62501	13332	5/8		.6250	5/8		4		1-5/8	
138B62990	13370		16.0	.6299		16.0		89.0		35.0
138B75000	13334	3/4		.7500	3/4		4		1	
138B75001	13336	3/4		.7500	3/4		4		1-5/8	
138B10000	13338	1		1.0000	1		4		1-1/2	
138B10001	13340	1		1.0000	1		5		2-1/4	

Inch	
D1	Tolerance
1/8 - 1.0	+0.0000/-0.0005

Metric (mm)	
D1	Tolerance
3.00 - 16.00	+0.000/-0.013

Inch	
R	Tolerance
1/8 - 1	+0.0004/-0.0004

Metric (mm)	
R	Tolerance
3.0 - 16.0	+0.01/-0.01

138CE / 138B

TuffCut® X-AL

HIGH PERFORMANCE



Page 332

3
Flute
Ball

**TuffCut® X-AL
Series 138BN**

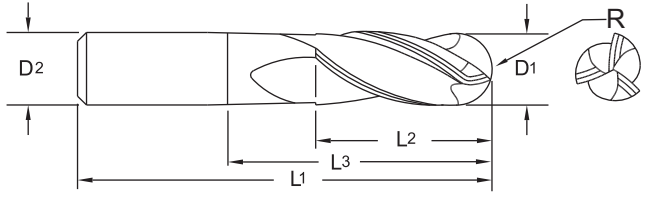
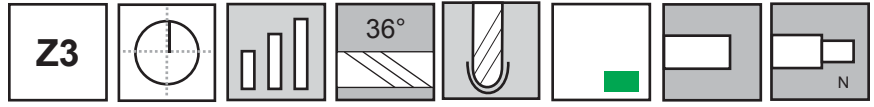

Uncoated Necked		Diameter			Shank		OAL		Flute Length		Neck Length	
Tool No.	EDP	D1			D2		L1		L2		L3	
		Inch	mm	Decimal	Inch	mm	Inch	mm	Inch	mm	Inch	mm
138B0787N5	13372		2.0	.0787		6.0		75.0		4.0		12.0
138B1181N5	13374		3.0	.1181		6.0		75.0		5.0		17.0
138B1575N5	13376		4.0	.1575		6.0		75.0		6.0		22.0
138B1968N5	13378		5.0	.1968		6.0		75.0		7.0		27.0
138B2362N5	13380		6.0	.2362		6.0		110.0		8.0		32.0
138B25001N	13342	1/4		.2500	1/4		4		3/4		2-1/8	
138B31251N	13344	5/16		.3125	5/16		4		13/16		2-1/8	
138B3150N5	13382		8.0	.3150		8.0		110.0		10.0		42.0
138B37501N	13346	3/8		.3750	3/8		4		1		2-1/8	
138B3937N5	13384		10.0	.3937		10.0		110.0		12.0		52.0
138B4724N5	13386		12.0	.4724		12.0		120.0		16.0		62.0
138B50001N	13348	1/2		.5000	1/2		4		1-1/4		2-1/8	
138B62501N	13350	5/8		.6250	5/8		6		1-5/8		3-3/8	
138B6299N5	13388		16.0	.6299		16.0		130.0		20.0		82.0
138B75001N	13352	3/4		.7500	3/4		6		1-5/8		3-3/8	
138B10000N	13354	1		1.0000	1		6		1-1/2		3-1/4	



Inch	
D1	Tolerance
1/4 - 1.0	+0.0000/-0.0005

Metric (mm)	
D1	Tolerance
2.00 - 16.00	+0.000/-0.013

Inch	
R	Tolerance
1/4 - 1	+0.0004/-0.0004

Metric (mm)	
R	Tolerance
2.0 - 16.0	+0.01/-0.01

ISO 9001:2008 Certified

TuffCut DM™ Series 156



2 Flute Ball

Series 156 is designed for high-productivity milling of hard and difficult to cut materials Rc 45-60. Coated with ALtima® 52 for materials Rc 52 and above.

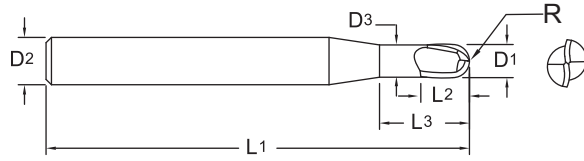

ALtima® 52		Diameter			Shank		Neck Diameter		OAL		Flute Length		Neck Length	
Tool No.	EDP	D1			D2 h5		D3		L1		L2		L3	
		Inch	mm	Decimal	Inch	mm	Inch	mm	Inch	mm	Inch	mm	Inch	mm
15601560A	15600	1/64		.0156	1/4				2-1/2		1/64			
156M0050N1A	15400		0.5	.0196		4.0		0.47		50		0.35		1
156M0050N2A	15401		0.5	.0196		4.0		0.47		50		0.35		2
156M0050N3A	15402		0.5	.0196		4.0		0.47		50		0.35		3
156M0050N4A	15403		0.5	.0196		4.0		0.47		50		0.35		4
156M0050N5A	15404		0.5	.0196		4.0		0.47		50		0.35		5
156M0050N6A	15406		0.5	.0196		4.0		0.47		50		0.35		6
15601960A	15602		0.5	.0196		6.0				63		0.50		
156M0060N2A	15409		0.6	.0236		4.0		0.57		50		0.40		2
156M0060N4A	15411		0.6	.0236		4.0		0.57		50		0.40		4
156M0060N6A	15413		0.6	.0236		4.0		0.57		50		0.40		6
156M0060N8A	15415		0.6	.0236		4.0		0.57		50		0.40		8
156M0060N10A	15417		0.6	.0236		4.0		0.57		50		0.40		10
15603120A	15604	1/32		.0312	1/4				2-1/2		1/32			
15603121A	15606	1/32		.0312	1/4		.0300		2-1/2		1/32		1/4	
15603122A	15608	1/32		.0312	1/4		.0300		2-1/2		1/32		5/16	
15603123A	15610	1/32		.0312	1/4		.0300		2-1/2		1/32		3/8	
15603124A	15612	1/32		.0312	1/4		.0300		2-1/2		1/32		1/2	
15603125A	15614	1/32		.0312	1/4		.0300		2-1/2		1/32		5/8	
156M0080N2A	15419		0.8	.0315		4.0		0.77		50		0.50		2
156M0080N4A	15420		0.8	.0315		4.0		0.77		50		0.50		4
156M0080N6A	15422		0.8	.0315		4.0		0.77		50		0.50		6
156M0080N8A	15423		0.8	.0315		4.0		0.77		50		0.50		8
156M0080N10A	15424		0.8	.0315		4.0		0.77		50		0.50		10
156M0100N2A	15425		1.0	.0394		4.0		0.96		50		0.80		2
156M0100N3A	15426		1.0	.0394		4.0		0.96		50		0.80		3
156M0100N4A	15427		1.0	.0394		4.0		0.96		50		0.80		4
156M0100N6A	15429		1.0	.0394		4.0		0.96		50		0.80		6

Inch	
D1	Tolerance
1/64 - 1/2	+0 /-.0005

Metric (mm)	
D1	Tolerance
0.50 - 12.00	+0 /-.015

Inch	
D2	Tolerance h5
.1182 - .2362	+0 /-.00020
.2363 - .3937	+0 /-.00024
.3938 - .7087	+0 /-.00031

Metric (mm)	
D2	Tolerance h5
3.01 - 6.00	+0 /-.005
6.01 - 10.00	+0 /-.006
10.01 - 18.00	+0 /-.008

Inch	
R	Tolerance
1/64 - 1/2	+0.0004/-.0004

Metric (mm)	
R	Tolerance
0.5 - 12.0	+0.01/-0.01



Series 156 Continued

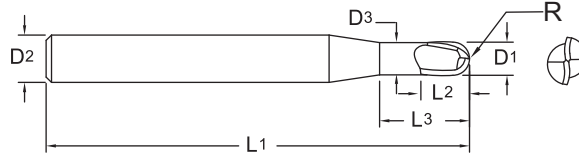
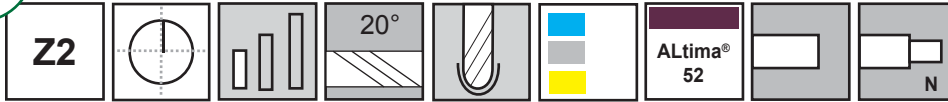

ALtima® 52		Diameter			Shank		Neck Diameter		OAL		Flute Length		Neck Length	
Tool No.	EDP	D1			D2 h5		D3		L1		L2		L3	
		Inch	mm	Decimal	Inch	mm	Inch	mm	Inch	mm	Inch	mm	Inch	mm
156M0100N10A	15431		1.0	.0394		4.0		0.96		50		0.80		10
156M0100N12A	15432		1.0	.0394		4.0		0.96		63		0.80		12
156M0100N14A	15433		1.0	.0394		4.0		0.96		63		0.80		14
156M0100N16A	15434		1.0	.0394		4.0		0.96		63		0.80		16
156M0100N18A	15435		1.0	.0394		4.0		0.96		63		0.80		18
156M0100N20A	15436		1.0	.0394		4.0		0.96		63		0.80		20
15603940A	15616		1.0	.0394		6.0				63		1.00		
15603941A	15618		1.0	.0394		6.0		0.96		63		1.00		6
15603942A	15620		1.0	.0394		6.0		0.96		63		1.00		8
15603943A	15622		1.0	.0394		6.0		0.96		63		1.00		10
15603944A	15624		1.0	.0394		6.0		0.96		63		1.00		12
15603945A	15626		1.0	.0394		6.0		0.96		63		1.00		16
156M0120N8A	15437		1.2	.0472		4.0		1.15		50		1.10		8
156M0120N12A	15438		1.2	.0472		4.0		1.15		63		1.10		12
156M0140N8A	15439		1.4	.0551		4.0		1.34		50		1.30		8
156M0140N12A	15440		1.4	.0551		4.0		1.34		63		1.30		12
156M0140N16A	15441		1.4	.0551		4.0		1.34		63		1.30		16
156M0150N4A	15442		1.5	.0591		4.0		1.44		50		1.35		4
156M0150N8A	15444		1.5	.0591		4.0		1.44		50		1.35		8
156M0150N16A	15446		1.5	.0591		4.0		1.44		63		1.35		16
156M0150N20A	15447		1.5	.0591		4.0		1.44		63		1.35		20
15605910A	15628		1.5	.0591		6.0				63		1.50		
15606250A	15630	1/16		.0625	1/4				2-1/2		1/16			
156M0160N8A	15448		1.6	.0630		4.0		1.54		50		1.40		8
156M0160N12A	15449		1.6	.0630		4.0		1.54		63		1.40		12
156M0160N16A	15450		1.6	.0630		4.0		1.54		63		1.40		16
156M0160N20A	15451		1.6	.0630		4.0		1.54		63		1.40		20
156M0180N8A	15452		1.8	.0709		4.0		1.73		50		1.60		8
156M0180N12A	15453		1.8	.0709		4.0		1.73		63		1.60		12
156M0180N16A	15454		1.8	.0709		4.0		1.73		63		1.60		16
156M0180N20A	15455		1.8	.0709		4.0		1.73		63		1.60		20
156M0200N3A	15456		2.0	.0787		4.0		1.92		50		1.70		3
156M0200N4A	15457		2.0	.0787		4.0		1.92		50		1.70		4
156M0200N6A	15458		2.0	.0787		4.0		1.92		50		1.70		6
156M0200N8A	15459		2.0	.0787		4.0		1.92		50		1.70		8
156M0200N10A	15460		2.0	.0787		4.0		1.92		50		1.70		10
156M0200N12A	15461		2.0	.0787		4.0		1.92		63		1.70		12
156M0200N16A	15463		2.0	.0787		4.0		1.92		63		1.70		16





Series 156 Continued

ALtima® 52		Diameter			Shank		Neck Diameter		OAL		Flute Length		Neck Length	
		D1			D2 h5		D3		L1		L2		L3	
Tool No.	EDP	Inch	mm	Decimal	Inch	mm	Inch	mm	Inch	mm	Inch	mm	Inch	mm
156M0200N20A	15465		2.0	.0787		4.0		1.92		63		1.70		20
156M0200N25A	15467		2.0	.0787		4.0		1.92		80		1.70		25
156M0200N30A	15468		2.0	.0787		4.0		1.92		80		1.70		30
156M0200N35A	15469		2.0	.0787		4.0		1.92		80		1.70		35
156M0200N40A	15470		2.0	.0787		4.0		1.92		80		1.70		40
15607870A	15632		2.0	.0787		6.0				63		2.00		
15607871A	15634		2.0	.0787		6.0		1.92		63		2.00		8
15607872A	15636		2.0	.0787		6.0		1.92		63		2.00		12
15607873A	15638		2.0	.0787		6.0		1.92		63		2.00		20
15609370A	15640	3/32		.0937	1/4					2-1/2		3/32		
15609371A	15642	3/32		.0937	1/4		.0898			2-1/2		3/32		5/16
15609372A	15644	3/32		.0937	1/4		.0898			2-1/2		3/32		1/2
15609373A	15646	3/32		.0937	1/4		.0898			2-1/2		3/32		3/4
156M0300N8A	15471		3.0	.1181		6.0		2.90		75		2.50		8
156M0300N10A	15472		3.0	.1181		6.0		2.90		75		2.50		10
156M0300N16A	15474		3.0	.1181		6.0		2.90		75		2.50		16
156M0300N25A	15476		3.0	.1181		6.0		2.90		75		2.50		25
156M0300N30A	15477		3.0	.1181		6.0		2.90		75		2.50		30
156M0300N35A	15478		3.0	.1181		6.0		2.90		75		2.50		35
15611810A	15648		3.0	.1181		6.0				75		3.00		
15611812A	15676		3.0	.1181		6.0		2.90		75		3.00		12
15611811A	15650		3.0	.1181		6.0		2.90		75		3.00		20
15612500A	15652	1/8		.1250	1/4					3		1/8		
15612501A	15654	1/8		.1250	1/4		.1211			3		1/8		3/4
15615620A	15656	5/32		.1562	1/4					3		5/32		
156M0400N10A	15480		4.0	.1575		6.0		3.90		75		3.00		10
156M0400N16A	15482		4.0	.1575		6.0		3.90		75		3.00		16
156M0400N25A	15484		4.0	.1575		6.0		3.90		75		3.00		25
156M0400N35A	15486		4.0	.1575		6.0		3.90		75		3.00		35
156M0400N40A	15487		4.0	.1575		6.0		3.90		75		3.00		40
156M0400N50A	15489		4.0	.1575		6.0		3.90		100		3.00		50
15615750A	15658		4.0	.1575		6.0				75		4.00		
15615751A	15678		4.0	.1575		6.0		3.90		75		4.00		12
15615752A	15679		4.0	.1575		6.0		3.90		75		4.00		20
15618750A	15659	3/16		.1875	1/4					3		3/16		
156M0500N25A	15490		5.0	.1968		6.0		4.90		75		3.50		25
156M0500N40A	15493		5.0	.1968		6.0		4.90		75		3.50		40
15619680A	15680		5.0	.1968		6.0				75		5.00		
15619681A	15681		5.0	.1968		6.0		4.90		75		5.00		12
15619682A	15682		5.0	.1968		6.0		4.90		75		5.00		25
156M0600N30A	15494		6.0	.2362		6.0		5.90		75		4.50		30
156M0600N50A	15495		6.0	.2362		6.0		5.90		100		4.50		50
15623620A	15660		6.0	.2362		6.0				75		6.00		
15623621A	15683		6.0	.2362		6.0		5.90		75		6.00		12
15623622A	15684		6.0	.2362		6.0		5.90		75		6.00		25
15625000A	15662	1/4		.2500	1/4					3		1/4		

2
Flute
Ball

Series 156 Continued

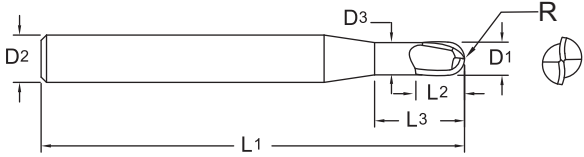

ALtima® 52		Diameter			Shank		Neck Diameter		OAL		Flute Length		Neck Length	
		D1			D2 h5		D3		L1		L2		L3	
Tool No.	EDP	Inch	mm	Decimal	Inch	mm	Inch	mm	Inch	mm	Inch	mm	Inch	mm
15631250A	15664	5/16		.3125	5/16				3-1/8		5/16			
156M0800N30A	15665		8.0	.3150		8.0		7.90		102		5.50		30
156M0800N50A	15667		8.0	.3150		8.0		7.90		102		5.50		50
15631500A	15666		8.0	.3150		8.0				80		8.00		
15637500A	15668	3/8		.3750	3/8				3-1/4		3/8			
156M1000N30A	15669		10.0	.3937		10.0		9.90		102		6.50		30
156M1000N50A	15671		10.0	.3937		10.0		9.90		102		6.50		50
15639370A	15670		10.0	.3937		10.0				82		10.00		
156M1200N30A	15673		12.0	.4724		12.0		11.90		102		7.50		30
156M1200N50A	15675		12.0	.4724		12.0		11.90		102		7.50		50
15647240A	15672		12.0	.4724		12.0				100		12.00		
15650000A	15674	1/2		.5000	1/2				4		1/2			



TuffCut DM™ Series 158

Z4

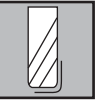
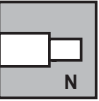
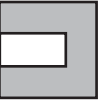
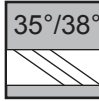
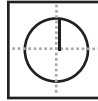

4
Flute

Series 158 was designed with similar TuffCut® XR geometry, but incorporates features that make it an excellent tool for die and mold steels and hard to machine materials up to 65 Rc. Coated with ALtima® 52 for materials Rc 52 and above.

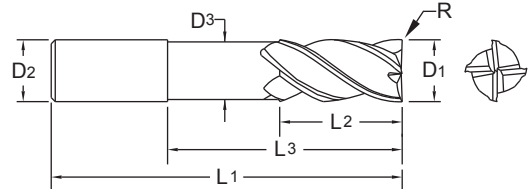

ALtima® 52		Diameter		Shank D2 h6	Neck Diameter D3	OAL L1	Flute Length L2	Neck Length L3	Corner Radius R
Tool No.	EDP	mm	Decimal						
15811800N3A	15522	3	.1181	6	2.9	50	5	9	
15811800N5A	15524	3	.1181	6	2.9	50	5	15	
15811800R012N3A	15526	3	.1181	6	2.9	50	5	9	0.3
15811800R012N5A	15528	3	.1181	6	2.9	50	5	15	0.3
15811800R031N5A	15530	3	.1181	6	2.9	50	5	15	0.8
15823600N3A	15532	6	.2362	6	5.8	100	9	18	
15823600N5A	15534	6	.2362	6	5.8	100	9	30	
15823600R012N3A	15536	6	.2362	6	5.8	100	9	18	0.3
15823600R012N5A	15538	6	.2362	6	5.8	100	9	30	0.3
15823600R059N5A	15540	6	.2362	6	5.8	100	9	30	1.5
15831500N3A	15542	8	.3150	8	7.6	100	12	24	
15831500N5A	15544	8	.3150	8	7.6	100	12	40	
15831500R012N3A	15546	8	.3150	8	7.6	100	12	24	0.3
15831500R012N5A	15548	8	.3150	8	7.6	100	12	40	0.3
15831500R079N5A	15550	8	.3150	8	7.6	100	12	40	2.0
15839300N3A	15552	10	.3937	10	9.6	100	15	30	
15839300N5A	15554	10	.3937	10	9.6	100	15	50	
15839300R012N3A	15556	10	.3937	10	9.6	100	15	30	0.3
15839300R012N5A	15558	10	.3937	10	9.6	100	15	50	0.3
15839300R079N5A	15560	10	.3937	10	9.6	100	15	50	2.0
15847200N3A	15562	12	.4724	12	11.4	100	18	36	
15847200N5A	15564	12	.4724	12	11.4	130	18	60	
15847200R012N3A	15566	12	.4724	12	11.4	100	18	36	0.3
15847200R012N5A	15568	12	.4724	12	11.4	130	18	60	0.3
15847200R079N5A	15570	12	.4724	12	11.4	130	18	60	2.0
15862900N3A	15572	16	.6299	16	15.2	130	24	48	
15862900N5A	15574	16	.6299	16	15.2	150	24	80	
15862900R012N3A	15576	16	.6299	16	15.2	130	24	48	0.3
15862900R012N5A	15578	16	.6299	16	15.2	150	24	80	0.3
15862900R118N5A	15580	16	.6299	16	15.2	150	24	80	3.0
15878700N5A	15582	20	.7874	20	19.2	150	30	100	
15878700R012N5A	15584	20	.7874	20	19.2	150	30	100	0.3
15878700R118N5A	15586	20	.7874	20	19.2	150	30	100	3.0

Metric (mm)	
D1	Tolerance
3.0 - 20.0	+0/-0.02

Metric (mm)	
D2	Tolerance (h6)
3	+0/-0.006
3.01 - 6.0	+0/-0.008
6.01 - 10.0	+0/-0.009
10.01 - 18.0	+0/-0.011
18.01 - 20.0	+0/-0.013

Metric (mm)	
R	Tolerance
3.0 - 20.0	+0.02/-0.02

156 / 158
TuffCut DM™

HIGH PERFORMANCE





TuffCut DM™ Series 157

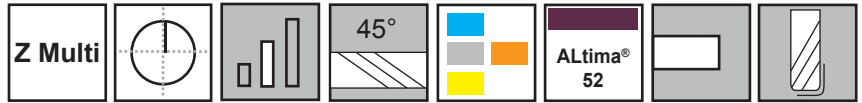

Multi-Flute designed for hardened materials Rc 50-65. Available as a Square End and in 7 standard corner radii. Coated with ALtima® 52 for materials Rc 52 and above.

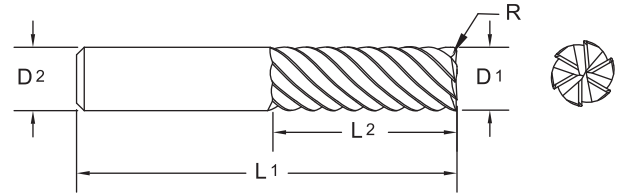

ALtima® 52		Diameter			Shank		OAL		Flute Length		Corner Radius		No. of Flutes
		D1			D2		L1		L2		R		
Tool No.	EDP	Inch	mm	Decimal	Inch	mm	Inch	mm	Inch	mm	Inch	mm	
15711810A	15700		3	.1181		6		75		10			4
15711811A	15701		3	.1181		6		75		10		0.50	4
15712500A	15702	1/8		.1250	1/4		3		3/8				4
15712501A	15703	1/8		.1250	1/4		3		3/8		0.015		4
15712502A	15704	1/8		.1250	1/4		3		3/8		0.020		4
15715620A	15705	5/32		.1562	1/4		3		15/32				4
15715621A	15706	5/32		.1562	1/4		3		15/32		0.015		4
15715622A	15707	5/32		.1562	1/4		3		15/32		0.020		4
15715750A	15708		4	.1575		6		75		12			4
15715751A	15709		4	.1575		6		75		12		0.50	4
15715752A	15710		4	.1575		6		75		12		0.75	4
15718750A	15711	3/16		.1875	1/4		3		9/16				4
15718751A	15712	3/16		.1875	1/4		3		9/16		0.015		4
15718752A	15713	3/16		.1875	1/4		3		9/16		0.020		4
15718753A	15714	3/16		.1875	1/4		3		9/16		0.030		4
15719680A	15715		5	.1968		6		90		15			4
15719681A	15716		5	.1968		6		90		15		0.50	4
15719682A	15717		5	.1968		6		90		15		0.75	4
15719683A	15718		5	.1968		6		90		15		1.00	4
15723620A	15719		6	.2362		6		90		15			6
15723621A	15720		6	.2362		6		90		15		0.50	6
15723622A	15721		6	.2362		6		90		15		0.75	6
15723623A	15722		6	.2362		6		90		15		1.00	6
15725000A	15723	1/4		.2500	1/4		3-1/2		5/8				6
15725001A	15724	1/4		.2500	1/4		3-1/2		5/8		0.015		6
15725002A	15725	1/4		.2500	1/4		3-1/2		5/8		0.020		6
15725003A	15726	1/4		.2500	1/4		3-1/2		5/8		0.030		6
15725004A	15727	1/4		.2500	1/4		3-1/2		5/8		0.045		6
15731250A	15728	5/16		.3125	5/16		4		3/4				6
15731251A	15729	5/16		.3125	5/16		4		3/4		0.015		6
15731252A	15730	5/16		.3125	5/16		4		3/4		0.020		6
15731253A	15731	5/16		.3125	5/16		4		3/4		0.030		6
15731254A	15732	5/16		.3125	5/16		4		3/4		0.045		6
15731500A	15733		8	.3150		8		100		20			6
15731501A	15734		8	.3150		8		100		20		0.50	6
15731502A	15735		8	.3150		8		100		20		0.75	6

Inch	
D1	Tolerance
1/8 - 3/16	-.0006/-0.0015
1/4 - 5/8	-.0008/-0.0019

Metric (mm)	
D1	Tolerance
3.0	-.005/-0.028
4.0 - 6.0	-.015/-0.038
8.0 - 16.0	-.020/-0.048
20.0 - 25.0	-.020/-0.053

Inch	
R	Tolerance
1/8 - 5/8	+0.0012/-0.0012

Metric (mm)	
R	Tolerance
3.0 - 25.0	+0.03/-0.03



Series 157 Continued

Multi-Flute

ALtima® 52		Diameter			Shank		OAL		Flute Length		Corner Radius		No. of Flutes
Tool No.	EDP	D1			D2		L1		L2		R		
		Inch	mm	Decimal	Inch	mm	Inch	mm	Inch	mm	Inch	mm	
15731503A	15736		8	.3150		8		100		20		1.00	6
15731504A	15737		8	.3150		8		100		20		1.50	6
15731505A	15810		8	.3150		8		100		20		2.00	6
15737500A	15738	3/8		.3750	3/8		4		1				6
15737501A	15739	3/8		.3750	3/8		4		1		0.015		6
15737502A	15740	3/8		.3750	3/8		4		1		0.020		6
15737503A	15741	3/8		.3750	3/8		4		1		0.030		6
15737504A	15742	3/8		.3750	3/8		4		1		0.045		6
15739370A	15743		10	.3937		10		100		25			6
15739371A	15744		10	.3937		10		100		25		0.50	6
15739372A	15745		10	.3937		10		100		25		0.75	6
15739373A	15746		10	.3937		10		100		25		1.00	6
15739374A	15747		10	.3937		10		100		25		1.50	6
15739375A	15812		10	.3937		10		100		25		2.00	6
15747240A	15748		12	.4724		12		100		30			6
15747241A	15749		12	.4724		12		100		30		0.50	6
15747242A	15750		12	.4724		12		100		30		0.75	6
15747243A	15751		12	.4724		12		100		30		1.00	6
15747244A	15752		12	.4724		12		100		30		1.50	6
15747245A	15753		12	.4724		12		100		30		2.00	6
15747247A	15814		12	.4724		12		100		30		3.00	6
15750000A	15754	1/2		.5000	1/2		4		1-1/4				6
15750001A	15755	1/2		.5000	1/2		4		1-1/4		0.015		6
15750002A	15756	1/2		.5000	1/2		4		1-1/4		0.020		6
15750003A	15757	1/2		.5000	1/2		4		1-1/4		0.030		6
15750004A	15758	1/2		.5000	1/2		4		1-1/4		0.045		6
15750005A	15759	1/2		.5000	1/2		4		1-1/4		0.060		6
15762500A	15760	5/8		.6250	5/8		6		1-9/16				6
15762501A	15761	5/8		.6250	5/8		6		1-9/16		0.015		6
15762502A	15762	5/8		.6250	5/8		6		1-9/16		0.020		6
15762503A	15763	5/8		.6250	5/8		6		1-9/16		0.030		6
15762504A	15764	5/8		.6250	5/8		6		1-9/16		0.045		6
15762505A	15765	5/8		.6250	5/8		6		1-9/16		0.060		6
15762506A	15766	5/8		.6250	5/8		6		1-9/16		0.090		6
15762990A	15767		16	.6299		16		150		40			6
15762991A	15768		16	.6299		16		150		40		0.50	6
15762992A	15769		16	.6299		16		150		40		0.75	6
15762993A	15770		16	.6299		16		150		40		1.00	6
15762994A	15771		16	.6299		16		150		40		1.50	6
15762995A	15772		16	.6299		16		150		40		2.00	6
15762996A	15773		16	.6299		16		150		40		2.50	6
15762997A	15774		16	.6299		16		150		40		3.00	6
15778740A	15783		20	.7874		20		150		45			8
15778741A	15784		20	.7874		20		150		45		0.50	8
15778742A	15785		20	.7874		20		150		45		0.75	8
15778743A	15786		20	.7874		20		150		45		1.00	8

157
TuffCut DM™

HIGH PERFORMANCE



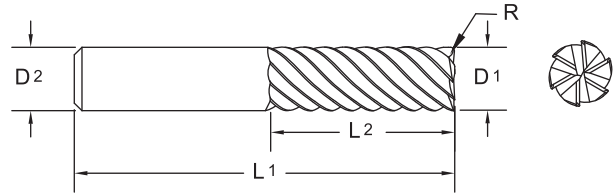
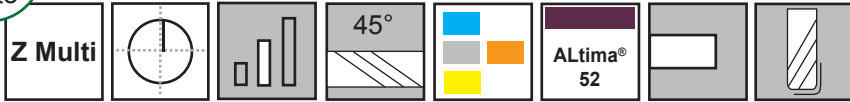

ALtima® 52		Diameter			Shank		OAL		Flute Length		Corner Radius		No. of Flutes
		D1			D2		L1		L2		R		
Tool No.	EDP	Inch	mm	Decimal	Inch	mm	Inch	mm	Inch	mm	Inch	mm	
15778744A	15787		20	.7874		20		150		45		1.50	8
15778745A	15788		20	.7874		20		150		45		2.00	8
15778746A	15789		20	.7874		20		150		45		2.50	8
15778747A	15790		20	.7874		20		150		45		3.00	8
15798430A	15791		25	.9843		25		150		50			10
15798431A	15792		25	.9843		25		150		50		0.50	10
15798432A	15793		25	.9843		25		150		50		0.75	10
15798433A	15794		25	.9843		25		150		50		1.00	10
15798434A	15795		25	.9843		25		150		50		1.50	10
15798435A	15796		25	.9843		25		150		50		2.00	10
15798436A	15797		25	.9843		25		150		50		2.50	10
15798437A	15798		25	.9843		25		150		50		3.00	10



Safety Note

Always wear the appropriate personal protective equipment such as safety glasses and protective clothing when using solid carbide or HSS cutting tools. Machines should be fully guarded.

ISO 9001:2008 Certified

TuffCut DM™ Series 192

Z Multi



ALtima®

Weldon
HB
DIN6535

3/8" (6mm)
Shanks & above

Multi-
Flute

Designed for high-speed machining of cast iron, mild steels and similar materials.

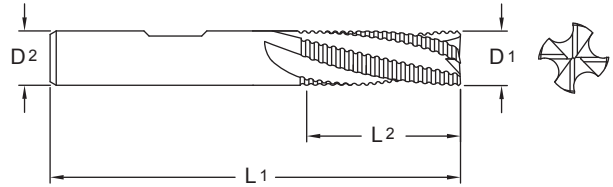

- High volumetric metal removal rates.
- Achieve 20% higher speed, 50% higher feed than a standard end mill.

ALtima®		Diameter			Shank		OAL		Flute Length		No. of Flutes
		D1			D2		L1		L2		
Tool No.	EDP	Inch	mm	Decimal	Inch	mm	Inch	mm	Inch	mm	
19225000A	95730	1/4		.2500	1/4		2		1/4		3
19225001A	95737	1/4		.2500	1/4		2-1/2		3/4		3
19231500A	95744		8	.3150		8		51		8	3
19231501A	95749		8	.3150		8		64		16	3
19237500A	95731	3/8		.3750	3/8		2		3/8		4
19237501A	95738	3/8		.3750	3/8		2-1/2		7/8		4
19239370A	95745		10	.3937		10		51		10	4
19239371A	95750		10	.3937		10		70		20	4
19247240A	95746		12	.4724		12		64		12	4
19247241A	95751		12	.4724		12		76		25	4
19250000A	95732	1/2		.5000	1/2		2-1/2		1/2		4
19250001A	95739	1/2		.5000	1/2		3		1		4
19262500A	95733	5/8		.6250	5/8		3		5/8		4
19262501A	95740	5/8		.6250	5/8		3-1/2		1-1/4		4
19262990A	95747		16	.6299		16		76		16	4
19262991A	95752		16	.6299		16		89		32	4
19275000A	95734	3/4		.7500	3/4		4		3/4		4
19275001A	95741	3/4		.7500	3/4		4		1-1/2		4
19278740A	95748		20	.7874		20		76		20	4
19278741A	95753		20	.7874		20		102		38	4

Inch	
D1	Tolerance
1/4 - 3/4	+ .000/- .005

Metric (mm)	
D1	Tolerance
8.00 - 20.00	+ .000/- .127

157 / 192
TuffCut DM™

HIGH PERFORMANCE



3
Flute

TuffCut® SS Series 112

Z3

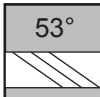

TiN



3/8" (6mm)
Shanks & above

Designed for milling stainless steel, titanium, inconel and other similar metals, where high cutting forces are generated. Works well as a finishing tool.

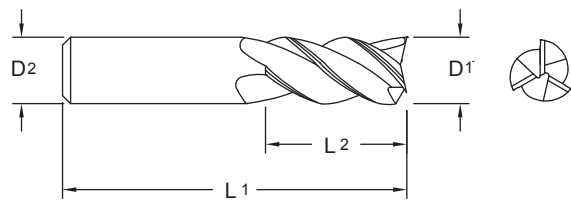

Uncoated		TiN		Diameter			Shank		OAL		Flute Length	
				D1			D2		L1		L2	
Tool No.	EDP	Tool No.	EDP	Inch	mm	Decimal	Inch	mm	Inch	mm	Inch	mm
11211810	11203	11211810T	11204		3.0	.1181		3.0		38		12.0
11212500	11205	11212500T	11206	1/8		.1250	1/8		1-1/2		3/8	
11213780	11207	11213780T	11208		3.5	.1378		4.0		51		12.0
11215620	11209	11215620T	11210	5/32		.1562	3/16		2		1/2	
11215750	11211	11215750T	11212		4.0	.1575		4.0		51		14.0
11217720	11213	11217720T	11214		4.5	.1772		5.0		51		14.0
11218750	11215	11218750T	11216	3/16		.1875	3/16		2		9/16	
11219680	11217	11219680T	11218		5.0	.1968		5.0		51		20.0
11221650	11219	11221650T	11220		5.5	.2165		6.0		64		20.0
11221870	11221	11221870T	11222	7/32		.2187	1/4		2-1/2		5/8	
11223620	11223	11223620T	11224		6.0	.2362		6.0		64		20.0
11225000	11225	11225000T	11226	1/4		.2500	1/4		2-1/2		3/4	
11227560	11227	11227560T	11228		7.0	.2756		8.0		64		20.0
11228120	11229	11228120T	11230	9/32		.2812	5/16		2-1/2		3/4	
11231250	11231	11231250T	11232	5/16		.3125	5/16		2-1/2		13/16	
11231500	11233	11231500T	11234		8.0	.3150		8.0		64		20.0
11235430	11235	11235430T	11236		9.0	.3543		9.0		64		20.0
11237500	11237	11237500T	11238	3/8		.3750	3/8		2-1/2		7/8	
11239370	11239	11239370T	11240		10.0	.3937		10.0		70		25.0
11243310	11241	11243310T	11242		11.0	.4331		11.0		70		25.0
11243750	11243	11243750T	11244	7/16		.4375	7/16		2-3/4		1	
11247240	11245	11247240T	11246		12.0	.4724		12.0		76		25.0
11250000	11247	11250000T	11248	1/2		.5000	1/2		3		1	
11255120	11249	11255120T	11250		14.0	.5512		14.0		89		30.0
11256250	11251	11256250T	11252	9/16		.5625	9/16		3-1/2		1-1/8	
11262500	11253	11262500T	11254	5/8		.6250	5/8		3-1/2		1-1/4	
11262990	11255	11262990T	11256		16.0	.6299		16.0		89		30.0
11270870	11257	11270870T	11258		18.0	.7087		18.0		102		35.0
11275000	11259	11275000T	11260	3/4		.7500	3/4		4		1-1/2	
11278740	11261	11278740T	11262		20.0	.7874		20.0		102		38.0
11286620	11263	11286620T	11264		22.0	.8662		22.0		102		40.0
11287500	11265	11287500T	11266	7/8		.8750	7/8		4		1-1/2	
11298430	11267	11298430T	11268		25.0	.9843		25.0		102		40.0
11210000	11201	11210000T	11202	1		1.0000	1		4		1-1/2	

Inch	
D1	Tolerance
1/8 - 1/4	+ .000/- .002
> 1/4 - 1	+ .000/- .003

Metric (mm)	
D1	Tolerance h10
3.00	+ .000/- .040
>3.00 - 6.00	+ .000/- .048
>6.00 - 10.00	+ .000/- .058
>10.00 - 18.00	+ .000/- .070
>18.00 - 25.00	+ .000/- .084

- Excellent surface finishes.
- High speed and feed capabilities.
- TiN Coating adds lubricity to prevent edge build up.
- High helix angle increases length of cutting edge engaged in the cut, reducing cutting load variations and prolonging tool life.



TuffCut® SS Series 113

Z6



6 Flute

Designed for milling stainless steel, titanium, inconel and other similar metals, where high cutting forces are generated. Works well as a finishing tool.

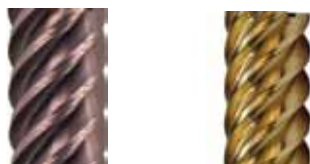
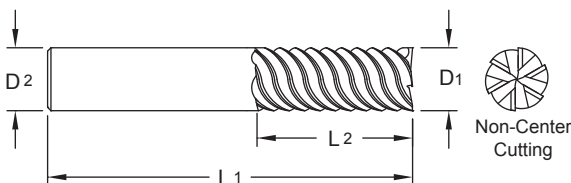

- TiN Coating adds lubricity to prevent edge build up.
- ALtima® coating provides high heat resistance that allows tools to be ran at higher speeds and feeds.
- 6 Flute geometry lowers cutting force vibration, permitting higher feeds (at comparable chip loads) and improved tool life.
- Weldon flats upon request.

Uncoated		ALtima®		TiN		Diameter			Shank		OAL		Flute Length	
Tool No.	EDP	Tool No.	EDP	Tool No.	EDP	D1			D2		L1		L2	
						Inch	mm	Decimal	Inch	mm	Inch	mm	Inch	mm
11311810	11303	11311810A	11384	11311810T	11304		3.0	.1181		3.0		38		12.0
11312500	11305			11312500T	11306	1/8		.1250	1/8		1-1/2		3/8	
11313780	11307			11313780T	11308		3.5	.1378		4.0		51		12.0
11315620	11309			11315620T	11310	5/32		.1562	3/16		2		1/2	
11315750	11311	11315750A	11385	11315750T	11312		4.0	.1575		4.0		51		14.0
11317720	11313			11317720T	11314		4.5	.1772		5.0		51		14.0
11318750	11315			11318750T	11316	3/16		.1875	3/16		2		9/16	
11319680	11317	11319680A	11386	11319680T	11318		5.0	.1968		5.0		51		20.0
11321650	11319			11321650T	11320		5.5	.2165		6.0		64		20.0
11321870	11321			11321870T	11322	7/32		.2187	1/4		2-1/2		5/8	
11323620	11323	11323620A	11387	11323620T	11324		6.0	.2362		6.0		64		20.0
11325000	11325			11325000T	11326	1/4		.2500	1/4		2-1/2		3/4	
11327560	11327			11327560T	11328		7.0	.2756		8.0		64		20.0
11328120	11329			11328120T	11330	9/32		.2812	5/16		2-1/2		3/4	
11331250	11331			11331250T	11332	5/16		.3125	5/16		2-1/2		13/16	
11331500	11333	11331500A	11388	11331500T	11334		8.0	.3150		8.0		64		20.0
11335430	11335			11335430T	11336		9.0	.3543		9.0		64		20.0
11337500	11337			11337500T	11338	3/8		.3750	3/8		2-1/2		7/8	
11339370	11339	11339370A	11389	11339370T	11340		10.0	.3937		10.0		70		25.0
11343310	11341			11343310T	11342		11.0	.4331		11.0		70		25.0

Inch	
D1	Tolerance
1/8 - 1/4	+ .000/- .002
> 1/4 - 1	+ .000/- .003

Metric (mm)	
D1	Tolerance h10
3.00	+ .000/- .040
>3.00 - 6.00	+ .000/- .048
>6.00 - 10.00	+ .000/- .058
>10.00 - 18.00	+ .000/- .070
>18.00 - 25.00	+ .000/- .084



6
Flute

Series 113 Continued

Z6					
-----------	--	--	--	--	--

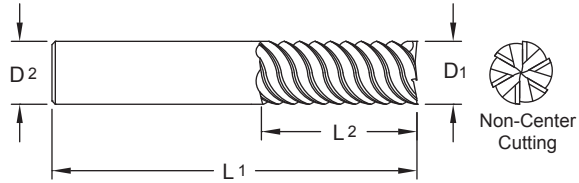
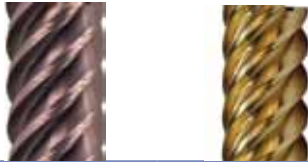

Uncoated		ALtima®		TiN		Diameter			Shank		OAL		Flute Length	
Tool No.	EDP	Tool No.	EDP	Tool No.	EDP	D1			D2		L1		L2	
						Inch	mm	Decimal	Inch	mm	Inch	mm	Inch	mm
11343750	11343			11343750T	11344	7/16		.4375	7/16		2-3/4		1	
11347240	11345	11347240A	11390	11347240T	11346		12.0	.4724		12.0		76		25.0
11350000	11347			11350000T	11348	1/2		.5000	1/2		3		1	
11355120	11349			11355120T	11350		14.0	.5512		14.0		89		30.0
11356250	11351			11356250T	11352	9/16		.5625	9/16		3-1/2		1-1/8	
11362500	11353			11362500T	11354	5/8		.6250	5/8		3-1/2		1-1/4	
11362990	11355	11362990A	11391	11362990T	11356		16.0	.6299		16.0		89		30.0
11370870	11357			11370870T	11358		18.0	.7087		18.0		102		35.0
11375000	11359			11375000T	11360	3/4		.7500	3/4		4		1-1/2	
11378740	11361	11378740A	11392	11378740T	11362		20.0	.7874		20.0		102		38.0
11386620	11363			11386620T	11364		22.0	.8662		22.0		102		40.0
11387500	11365			11387500T	11366	7/8		.8750	7/8		4		1-1/2	
11398430	11367			11398430T	11368		25.0	.9843		25.0		102		40.0
11310000	11301			11310000T	11302	1		1.0000	1		4		1-1/2	



ISO 9001:2008 Certified



RED BOX

Factory Reconditioning Service

Extend the life of your cutting tools with M.A. Ford®'s
Factory Reconditioning / Recoating Service.



SAVE

and

Go Green

with



**Drills
End Mills
Countersinks
Burs**

Simplified Pricing Structure.

No Minimum Order Value.

Original Coatings.

M.A. Ford® Quality Workmanship.

Tools Reground to Factory Specifications.

Quick Turnaround.

RETURN • RECONDITION • REDUCE COST

www.mafor.com/reconditioning for details.

800-553-8024 • 563-391-6220

For product information, call your local distributor.

TuffCut®

General Purpose End Mills

Square End/Corner Radius

4 Flute

TuffCut® GP Series 111
TuffCut® GP Series 114
TuffCut® GP Series 117
TuffCut® GP Series 163
TuffCut® GP Series 122
TuffCut® GP Series 132

3 Flute

TuffCut® GP Series 116
TuffCut® GP Series 169

2 Flute

TuffCut® GP Series 121
TuffCut® GP Series 164
TuffCut® GP Series 123

Ball Nose

4 Flute

TuffCut® GP Series 140
TuffCut® GP Series 165

3 Flute

TuffCut® GP Series 145

2 Flute

TuffCut® GP Series 150
TuffCut® GP Series 166



Made in USA



ISO 9001:2008 Certified



**TuffCut® GP
Series 111**

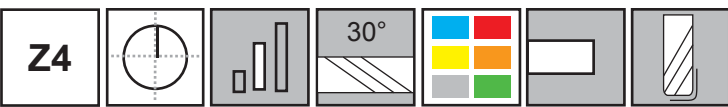

Designed for aggressive milling of most materials.

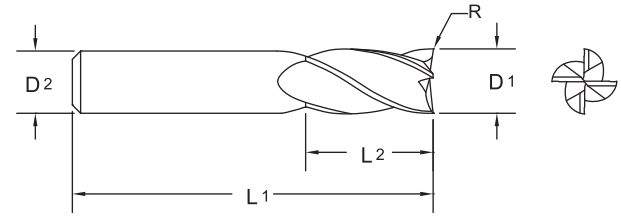

• Micro sizes available.

Tool No.	EDP	Diameter			Shank		OAL		Flute Length		Corner Radius	
		D1			D2		L1		L2		R	
		Inch	mm	Decimal	Inch	mm	Inch	mm	Inch	mm	Inch	mm
11100500	51001			.0050*	1/8		1-1/2		.015			
11100780	51003		0.2	.0078*		3.0		38		0.6		
11101000	51005			.0100*	1/8		1-1/2		.030			
11101180	51007		0.3	.0118*		3.0		38		0.9		
11101500	51009			.0150*	1/8		1-1/2		.045			
11101560	11011	1/64		.0156	1/8		1-1/2		1/32			
11101570	51013		0.4	.0157		3.0		38		1.2		
11101960	51015		0.5	.0196		3.0		38		1.5		
11102000	51017			.0200	1/8		1-1/2		.060			
11102360	51019		0.6	.0236		3.0		38		1.8		
11102500	51021			.0250	1/8		1-1/2		.075			
11102750	51023		0.7	.0275		3.0		38		2.1		
11103000	51025			.0300	1/8		1-1/2		.090			
11103120	11027	1/32		.0312	1/8		1-1/2		5/64			
11103150	51029		0.8	.0315		3.0		38		2.4		
11103500	51031			.0350	1/8		1-1/2		.105			
11103540	51033		0.9	.0354		3.0		38		2.7		
11103940	11035		1.0	.0394		3.0		38		3.0		
11104000	51039			.0400	1/8		1-1/2		.120			
11104330	51041		1.1	.0433		3.0		38		3.3		
11104500	51043			.0450	1/8		1-1/2		.135			
11104680	11045	3/64		.0468	1/8		1-1/2		7/64			
11104720	51047		1.2	.0472		3.0		38		3.6		
11105000	51049			.0500	1/8		1-1/2		.150			
11105120	51051		1.3	.0512		3.0		38		3.9		
11105500	51053			.0550	1/8		1-1/2		.165			
11105510	51055		1.4	.0551		3.0		38		4.2		
11105910	11057		1.5	.0591		3.0		38		6.0		
11105911	51057		1.5	.0591		3.0		38		4.5		
11106000	51061			.0600	1/8		1-1/2		.180			
11106250	11063	1/16		.0625	1/8		1-1/2		3/16			
11106300	51065		1.6	.0630		3.0		38		4.8		
11106500	51067			.0650	1/8		1-1/2		.195			
11106690	51069		1.7	.0669		3.0		38		5.1		

*End mills 0.015" (0.3mm) and smaller are non-center cutting.

Inch	
D1	Tolerance
1/64	+ .000/- .001
1/32 - 1/4	+ .000/- .002
>1/4 - 1-1/4	+ .000/- .003
D1 Micro Sizes*	Tolerance
.005 - .100	+ .0005/- .0005

*Inch decimal size range .005 - .100 only.

Metric (mm)	
D1	Tolerance h10
0.20 - 0.50	+ .000/- .025
0.60 - 3.00	+ .000/- .040
>3.00 - 6.00	+ .000/- .048
>6.00 - 10.00	+ .000/- .058
>10.00 - 18.00	+ .000/- .070
>18.00 - 30.00	+ .000/- .084
32.00	+ .000/- .100

Inch	
R	Tolerance
1/8 - 1	+ .002/- .002

Metric (mm)	
R	Tolerance
3.0 - 25.0	+ .05/- .05

Series 111 coated tools on page 258.



4
Flute

Series 111 Continued

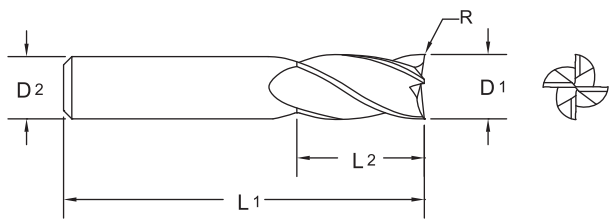
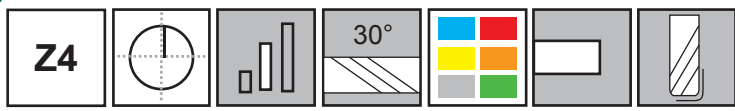

Tool No.	EDP	Diameter			Shank		OAL		Flute Length		Corner Radius	
		D1			D2		L1		L2		R	
		Inch	mm	Decimal	Inch	mm	Inch	mm	Inch	mm	Inch	mm
11107000	51071			.0700	1/8		1-1/2		.210			
11107090	51073		1.8	.0709		3.0		38		5.4		
11107480	51075		1.9	.0748		3.0		38		5.7		
11107500	51077			.0750	1/8		1-1/2		.225			
11107810	11079	5/64		.0781	1/8		1-1/2		3/16			
11107870	11081		2.0	.0787		3.0		38		9.0		
11107871	51081		2.0	.0787		3.0		38		6.0		
11108000	51085			.0800	1/8		1-1/2		.240			
11108500	51087			.0850	1/8		1-1/2		.255			
11109000	51089			.0900	1/8		1-1/2		.270			
11109370	11091	3/32		.0937	1/8		1-1/2		9/32			
11109500	51093			.0950	1/8		1-1/2		.285			
11109840	11095		2.5	.0984		3.0		38		12.0		
11110010	51099			.1000	1/8		1-1/2		.300			
11110930	11101	7/64		.1093	1/8		1-1/2		3/8			
11111810	11103		3.0	.1181		3.0		38		12.0		
11111811	51402		3.0	.1181		3.0		38		12.0		0.50
11112500	11105	1/8		.1250	1/8		1-1/2		3/8			
11112501	11108	1/8		.1250	1/8		1-1/2		1/2			
11112511	51401	1/8		.1250	1/8		1-1/2		3/8		0.015	
11112512	51403	1/8		.1250	1/8		1-1/2		3/8		0.020	
11113780	11111		3.5	.1378		4.0		51		12.0		
11114060	11112	9/64		.1406	3/16		2		1/2			
11115620	11113	5/32		.1562	3/16		2		1/2			
11115750	11115		4.0	.1575		4.0		51		14.0		
11115751	51404		4.0	.1575		4.0		51		14.0		0.50
11115752	51422		4.0	.1575		4.0		51		14.0		0.75
11117190	11116	11/64		.1719	3/16		2		5/8			
11117720	11117		4.5	.1772		5.0		51		14.0		
11118750	11119	3/16		.1875	3/16		2		5/8			
11118751	51405	3/16		.1875	3/16		2		5/8		0.015	
11118752	51407	3/16		.1875	3/16		2		5/8		0.020	
11118753	51409	3/16		.1875	3/16		2		5/8		0.030	
11119680	11121		5.0	.1968		5.0		51		20.0		
11119681	51406		5.0	.1968		5.0		51		20.0		0.50
11119682	51424		5.0	.1968		5.0		51		20.0		0.75
11119683	51440		5.0	.1968		5.0		51		20.0		1.00
11120310	11122	13/64		.2031	1/4		2-1/2		5/8			

Series 111 coated tools on page 258.



Series 111 Continued

4
Flute

Tool No.	EDP	Diameter			Shank		OAL		Flute Length		Corner Radius	
		D1			D2		L1		L2		R	
		Inch	mm	Decimal	Inch	mm	Inch	mm	Inch	mm	Inch	mm
11121650	11123		5.5	.2165		6.0		64		20.0		
11121870	11125	7/32		.2187	1/4			2-1/2		5/8		
11123440	11126	15/64		.2344	1/4			2-1/2		3/4		
11123620	11127		6.0	.2362		6.0		64		20.0		
11123621	51408		6.0	.2362		6.0		64		20.0		0.50
11123622	51426		6.0	.2362		6.0		64		20.0		0.75
11123623	51442		6.0	.2362		6.0		64		20.0		1.00
11125000	11129	1/4		.2500	1/4			2-1/2		3/4		
11125001	51411	1/4		.2500	1/4			2-1/2		3/4		0.015
11125002	51413	1/4		.2500	1/4			2-1/2		3/4		0.020
11125003	51415	1/4		.2500	1/4			2-1/2		3/4		0.030
11125004	51417	1/4		.2500	1/4			2-1/2		3/4		0.045
11127560	11131		7.0	.2756		8.0		64		20.0		
11128120	11133	9/32		.2812	5/16			2-1/2		3/4		
11131250	11135	5/16		.3125	5/16			2-1/2		13/16		
11131251	51419	5/16		.3125	5/16			2-1/2		13/16		0.015
11131252	51421	5/16		.3125	5/16			2-1/2		13/16		0.020
11131253	51423	5/16		.3125	5/16			2-1/2		13/16		0.030
11131254	51425	5/16		.3125	5/16			2-1/2		13/16		0.045
11131500	11137		8.0	.3150		8.0		64		20.0		
11131501	51410		8.0	.3150		8.0		64		20.0		0.50
11131502	51428		8.0	.3150		8.0		64		20.0		0.75
11131503	51444		8.0	.3150		8.0		64		20.0		1.00
11131504	51456		8.0	.3150		8.0		64		20.0		1.50
11135430	11139		9.0	.3543		9.0		64		20.0		
11137500	11141	3/8		.3750	3/8			2-1/2		1		
11137501	51427	3/8		.3750	3/8			2-1/2		1		0.015
11137502	51429	3/8		.3750	3/8			2-1/2		1		0.020
11137503	51431	3/8		.3750	3/8			2-1/2		1		0.030
11137504	51433	3/8		.3750	3/8			2-1/2		1		0.045
11139370	11143		10.0	.3937		10.0		70		25.0		
11139371	51412		10.0	.3937		10.0		70		25.0		0.50
11139372	51430		10.0	.3937		10.0		70		25.0		0.75
11139373	51446		10.0	.3937		10.0		70		25.0		1.00
11139374	51458		10.0	.3937		10.0		70		25.0		1.50
11143310	11145		11.0	.4331		11.0		70		25.0		
11143750	11147	7/16		.4375	7/16			2-3/4		1		
11147240	11149		12.0	.4724		12.0		76		25.0		
11147241	51414		12.0	.4724		12.0		76		25.0		0.50
11147242	51432		12.0	.4724		12.0		76		25.0		0.75
11147243	51448		12.0	.4724		12.0		76		25.0		1.00
11147244	51460		12.0	.4724		12.0		76		25.0		1.50
11147245	51468		12.0	.4724		12.0		76		25.0		2.00
11150000	11151	1/2		.5000	1/2			3		1		

111
TuffCut® GP

GENERAL PURPOSE

Series 111 coated tools on page 258.



Page 354

4
Flute

Series 111 Continued

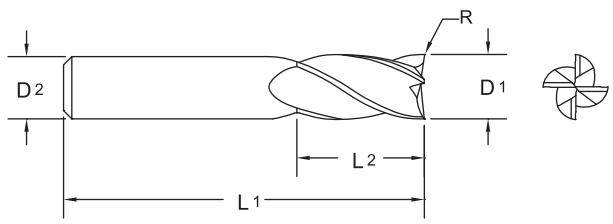
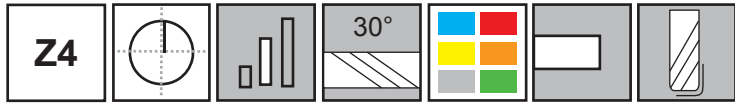

Tool No.	EDP	Diameter			Shank		OAL		Flute Length		Corner Radius	
		D1			D2		L1		L2		R	
		Inch	mm	Decimal	Inch	mm	Inch	mm	Inch	mm	Inch	mm
11150001	51435	1/2		.5000	1/2		3		1		0.015	
11150002	51437	1/2		.5000	1/2		3		1		0.020	
11150003	51439	1/2		.5000	1/2		3		1		0.030	
11150004	51441	1/2		.5000	1/2		3		1		0.045	
11150005	51443	1/2		.5000	1/2		3		1		0.060	
11155120	11153		14.0	.5512		14.0		89		30.0		
11156250	11155	9/16		.5625	9/16		3-1/2		1-1/8			
11162500	11157	5/8		.6250	5/8		3-1/2		1-1/4			
11162501	51445	5/8		.6250	5/8		3-1/2		1-1/4		0.015	
11162502	51447	5/8		.6250	5/8		3-1/2		1-1/4		0.020	
11162503	51449	5/8		.6250	5/8		3-1/2		1-1/4		0.030	
11162504	51451	5/8		.6250	5/8		3-1/2		1-1/4		0.045	
11162505	51453	5/8		.6250	5/8		3-1/2		1-1/4		0.060	
11162506	51455	5/8		.6250	5/8		3-1/2		1-1/4		0.090	
11162990	11159		16.0	.6299		16.0		89		30.0		
11162991	51416		16.0	.6299		16.0		89		30.0		0.50
11162992	51434		16.0	.6299		16.0		89		30.0		0.75
11162993	51450		16.0	.6299		16.0		89		30.0		1.00
11162994	51462		16.0	.6299		16.0		89		30.0		1.50
11162995	51470		16.0	.6299		16.0		89		30.0		2.00
11162996	51476		16.0	.6299		16.0		89		30.0		2.50
11162997	51482		16.0	.6299		16.0		89		30.0		3.00
11170870	11161		18.0	.7087		18.0		102		35.0		
11175000	11163	3/4		.7500	3/4		4		1-1/2			
11175001	51457	3/4		.7500	3/4		4		1-1/2		0.015	
11175002	51459	3/4		.7500	3/4		4		1-1/2		0.020	
11175003	51461	3/4		.7500	3/4		4		1-1/2		0.030	
11175004	51463	3/4		.7500	3/4		4		1-1/2		0.045	
11175005	51465	3/4		.7500	3/4		4		1-1/2		0.060	
11175006	51467	3/4		.7500	3/4		4		1-1/2		0.090	
11175007	51469	3/4		.7500	3/4		4		1-1/2		0.125	
11178740	11165		20.0	.7874		20.0		102		38.0		
11178741	51418		20.0	.7874		20.0		102		38.0		0.50
11178742	51436		20.0	.7874		20.0		102		38.0		0.75
11178743	51452		20.0	.7874		20.0		102		38.0		1.00
11178744	51464		20.0	.7874		20.0		102		38.0		1.50
11178745	51472		20.0	.7874		20.0		102		38.0		2.00
11178746	51478		20.0	.7874		20.0		102		38.0		2.50

Series 111 coated tools on page 258.



Series 111 Continued

Tool No.	EDP	Diameter			Shank		OAL		Flute Length		Corner Radius	
		D1			D2		L1		L2		R	
		Inch	mm	Decimal	Inch	mm	Inch	mm	Inch	mm	Inch	mm
11178747	51484		20.0	.7874		20.0		102		38.0		3.00
11186620	11167		22.0	.8662		22.0		102		40.0		
11187500	11169	7/8		.8750	7/8			4		1-1/2		
11198430	11171		25.0	.9843		25.0		102		40.0		
11198431	51420		25.0	.9843		25.0		102		40.0		0.50
11198432	51438		25.0	.9843		25.0		102		40.0		0.75
11198433	51454		25.0	.9843		25.0		102		40.0		1.00
11198434	51466		25.0	.9843		25.0		102		40.0		1.50
11198435	51474		25.0	.9843		25.0		102		40.0		2.00
11198436	51480		25.0	.9843		25.0		102		40.0		2.50
11198437	51486		25.0	.9843		25.0		102		40.0		3.00
11110000	11097	1.0		1.0000	1			4		1-1/2		
11110001	51471	1.0		1.0000	1			4		1-1/2		0.015
11110002	51473	1.0		1.0000	1			4		1-1/2		0.020
11110003	51475	1.0		1.0000	1			4		1-1/2		0.030
11110004	51477	1.0		1.0000	1			4		1-1/2		0.045
11110005	51479	1.0		1.0000	1			4		1-1/2		0.060
11110006	51481	1.0		1.0000	1			4		1-1/2		0.090
11110007	51483	1.0		1.0000	1			4		1-1/2		0.125
11112510	11107	1-1/4		1.2500	1-1/4			4-3/8		1-9/16		
11112600	11109		32.0	1.2600		32.0		111		40.0		

Series 111 coated tools on page 258.



Page 354



ISO 9001:2008 Certified



For product information, call your local distributor.

4
Flute

111
TuffCut® GP

GENERAL PURPOSE

4
Flute
NEW
Sizes

TuffCut® GP
Series 111 Coated

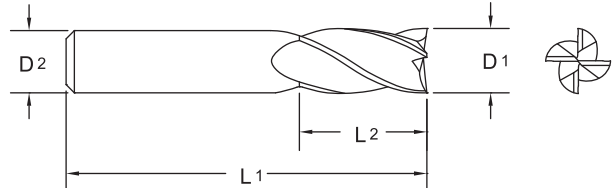

TiN		ALtima®		TiCN		Diameter			Shank		OAL		Flute Length	
Tool No.	EDP	Tool No.	EDP	Tool No.	EDP	D1			D2		L1		L2	
						Inch	mm	Decimal	Inch	mm	Inch	mm	Inch	mm
		11103940A	11036				1.0	.0394		3.0		38		3.0
		11105910A	11058				1.5	.0591		3.0		38		6.0
		11107870A	11082				2.0	.0787		3.0		38		9.0
		11109840A	11096				2.5	.0984		3.0		38		12.0
11111810T	11104	11111810A	11003	11111810C	11004		3.0	.1181		3.0		38		12.0
11112500T	11106	11112500A	11005	11112500C	11006	1/8		.1250	1/8		1-1/2		3/8	
11115750T	11118	11115750A	11007	11115750C	11008		4.0	.1575		4.0		51		14.0
11118750T	11120	11118750A	11009	11118750C	11010	3/16		.1875	3/16		2		5/8	
11119680T	11124	11119680A	11013	11119680C	11014		5.0	.1968		5.0		51		20.0
11123620T	11128	11123620A	11015	11123620C	11016		6.0	.2362		6.0		64		20.0
11125000T	11130	11125000A	11017	11125000C	11018	1/4		.2500	1/4		2-1/2		3/4	
11131250T	11136	11131250A	11019	11131250C	11020	5/16		.3125	5/16		2-1/2		13/16	
11131500T	11138	11131500A	11021	11131500C	11022		8.0	.3150		8.0		64		20.0
11137500T	11142	11137500A	11023	11137500C	11024	3/8		.3750	3/8		2-1/2		1	
11139370T	11144	11139370A	11025	11139370C	11026		10.0	.3937		10.0		70		25.0
11143750T	11148	11143750A	11029	11143750C	11030	7/16		.4375	7/16		2-3/4		1	
11147240T	11150	11147240A	11031	11147240C	11032		12.0	.4724		12.0		76		25.0
11150000T	11152	11150000A	11033	11150000C	11034	1/2		.5000	1/2		3		1	
11162500T	11158	11162500A	11037	11162500C	11038	5/8		.6250	5/8		3-1/2		1-1/4	
11162990T	11160	11162990A	11039	11162990C	11040		16.0	.6299		16.0		89		30.0
11175000T	11164	11175000A	11041	11175000C	11042	3/4		.7500	3/4		4		1-1/2	
11178740T	11166	11178740A	11043	11178740C	11044		20.0	.7874		20.0		102		38.0
11198430T	11172	11198430A	11047	11198430C	11048		25.0	.9843		25.0		102		40.0
11110000T	11098	11110000A	11001	11110000C	11002	1.0		1.0000	1		4		1-1/2	



Series 111 uncoated tools on page 253.

**TuffCut® GP
Series 114**

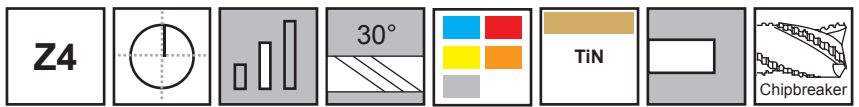

Chipbreaker end mill designed for aggressive milling of most materials.

- Allows high feed rates when roughing.
- Designed to minimize cutting forces, reduce or eliminate chatter and prolong tool life.
- Designed with tooth overlap to produce smooth part finish.

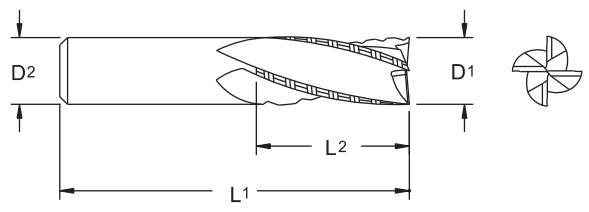

Uncoated		TiN		Diameter			Shank		OAL		Flute Length	
Tool No.	EDP	Tool No.	EDP	D1			D2		L1		L2	
				Inch	mm	Decimal	Inch	mm	Inch	mm	Inch	mm
11411810	11403	11411810T	11404		3.0	.1181		3.0		38		12.0
11412500	11405	11412500T	11406	1/8		.1250	1/8		1-1/2		3/8	
11413780	11407				3.5	.1378		4.0		51		12.0
11415620	11409			5/32		.1562	3/16		2		1/2	
11415750	11411				4.0	.1575		4.0		51		14.0
11417720	11413				4.5	.1772		5.0		51		14.0
11418750	11415	11418750T	11416	3/16		.1875	3/16		2		5/8	
11419680	11417	11419680T	11418		5.0	.1968		5.0		51		20.0
11421650	11419				5.5	.2165		6.0		64		20.0
11421870	11421			7/32		.2187	1/4		2-1/2		5/8	
11423620	11423	11423620T	11424		6.0	.2362		6.0		64		20.0
11425000	11425	11425000T	11426	1/4		.2500	1/4		2-1/2		3/4	
11427560	11427				7.0	.2756		8.0		64		20.0
11428120	11429			9/32		.2812	5/16		2-1/2		3/4	
11431250	11431	11431250T	11432	5/16		.3125	5/16		2-1/2		13/16	
11431500	11433	11431500T	11434		8.0	.3150		8.0		64		20.0
11435430	11435				9.0	.3543		9.0		64		20.0
11437500	11437	11437500T	11438	3/8		.3750	3/8		2-1/2		1	
11439370	11439	11439370T	11440		10.0	.3937		10.0		70		25.0
11443310	11441				11.0	.4331		11.0		70		25.0
11443750	11443	11443750T	11444	7/16		.4375	7/16		2-3/4		1	
11447240	11445	11447240T	11446		12.0	.4724		12.0		76		25.0
11450000	11447	11450000T	11448	1/2		.5000	1/2		3		1	
11455120	11449				14.0	.5512		14.0		89		30.0
11456250	11451			9/16		.5625	9/16		3-1/2		1-1/8	
11462500	11453	11462500T	11454	5/8		.6250	5/8		3-1/2		1-1/4	
11462990	11455	11462990T	11456		16.0	.6299		16.0		89		30.0
11470870	11457	11470870T	11458		18.0	.7087		18.0		102		35.0
11475000	11459	11475000T	11460	3/4		.7500	3/4		4		1-1/2	
11478740	11461	11478740T	11462		20.0	.7874		20.0		102		38.0
11486620	11463				22.0	.8662		22.0		102		40.0
11487500	11465			7/8		.8750	7/8		4		1-1/2	
11498430	11467				25.0	.9843		25.0		102		40.0
11410000	11401			1		1.0000	1		4		1-1/2	

Inch	
D1	Tolerance
1/8 - 1/4	+ .000/- .002
> 1/4 - 1	+ .000/- .003

Metric (mm)	
D1	Tolerance h10
3.00	+ .000/- .040
>3.00 - 6.00	+ .000/- .048
>6.00 - 10.00	+ .000/- .058
>10.00 - 18.00	+ .000/- .070
>18.00 - 25.00	+ .000/- .084

111 Coated / 114
TuffCut® GP

GENERAL PURPOSE



4
Flute

**TuffCut® GP
Series 117**

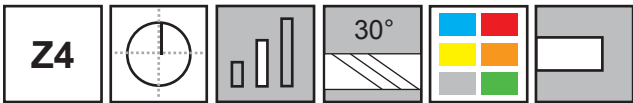

Recommended for use on close tolerance milling.

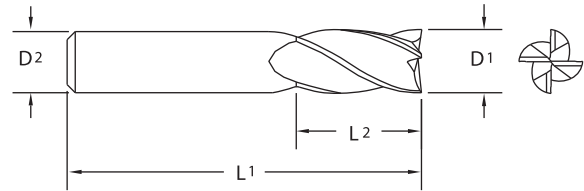

- NC tolerances on cutting diameter:
Imperial $+.001"/-0.000"$
Metric $+.025\text{mm}/-0.000\text{mm}$
- TiN and ALtima® coatings available.

Tool No.	EDP	Diameter			Shank		OAL		Flute Length	
		D1			D2		L1		L2	
		Inch	mm	Decimal	Inch	mm	Inch	mm	Inch	mm
11701560	11701	1/64		.0156	1/8		1-1/2		.040	
11703120	11703	1/32		.0312	1/8		1-1/2		5/64	
11703940	11705		1.0	.0394		3.0		38		3.0
11704680	11707	3/64		.0468	1/8		1-1/2		7/64	
11705910	11709		1.5	.0591		3.0		38		6.0
11706250	11711	1/16		.0625	1/8		1-1/2		3/16	
11707810	11713	5/64		.0781	1/8		1-1/2		15/64	
11707870	11715		2.0	.0787		3.0		38		9.0
11709370	11717	3/32		.0937	1/8		1-1/2		9/32	
11709840	11719		2.5	.0984		3.0		38		12.0
11710930	11723	7/64		.1093	1/8		1-1/2		21/64	
11711810	11725		3.0	.1181		3.0		38		12.0
11712500	11727	1/8		.1250	1/8		1-1/2		3/8	
11713780	11729		3.5	.1378		4.0		51		12.0
11715620	11731	5/32		.1562	3/16		2		1/2	
11715750	11733		4.0	.1575		4.0		51		14.0
11717720	11735		4.5	.1772		5.0		51		14.0
11718750	11737	3/16		.1875	3/16		2		9/16	
11719680	11739		5.0	.1968		5.0		51		20.0
11721650	11741		5.5	.2165		6.0		64		20.0
11721870	11743	7/32		.2187	1/4		2-1/2		5/8	
11723620	11745		6.0	.2362		6.0		64		20.0
11725000	11747	1/4		.2500	1/4		2-1/2		3/4	
11727560	11749		7.0	.2756		8.0		64		20.0
11728120	11751	9/32		.2812	5/16		2-1/2		3/4	
11731250	11753	5/16		.3125	5/16		2-1/2		13/16	
11731500	11755		8.0	.3150		8.0		64		20.0
11735430	11757		9.0	.3543		9.0		64		20.0
11737500	11759	3/8		.3750	3/8		2-1/2		7/8	
11739370	11761		10.0	.3937		10.0		70		25.0
11743310	11763		11.0	.4331		11.0		70		25.0
11743750	11765	7/16		.4375	7/16		2-3/4		1	

Inch	
D1	Tolerance
1/64 - 1	$+.001/-0.000$

Metric (mm)	
D1	Tolerance
1.00 - 25.00	$+.025/-0.000$



Series 117 Continued

Tool No.	EDP	Diameter			Shank		OAL		Flute Length	
		D1			D2		L1		L2	
		Inch	mm	Decimal	Inch	mm	Inch	mm	Inch	mm
11747240	11767		12.0	.4724		12.0		76		25.0
11750000	11769	1/2		.5000	1/2		3		1	
11755120	11771		14.0	.5512		14.0		89		30.0
11756250	11773	9/16		.5625	9/16		3-1/2		1-1/8	
11762500	11775	5/8		.6250	5/8		3-1/2		1-1/4	
11762990	11777		16.0	.6299		16.0		89		30.0
11770870	11779		18.0	.7087		18.0		102		35.0
11775000	11781	3/4		.7500	3/4		4		1-1/2	
11778740	11783		20.0	.7874		20.0		102		38.0
11786620	11785		22.0	.8662		22.0		102		40.0
11787500	11787	7/8		.8750	7/8		4		1-1/2	
11798430	11789		25.0	.9843		25.0		102		40.0
11710000	11721	1		1.0000	1		4		1-1/2	



Page 354

117
TuffCut® GP

GENERAL PURPOSE

4
Flute
NEW
Sizes

**TuffCut® GP
Series 163**

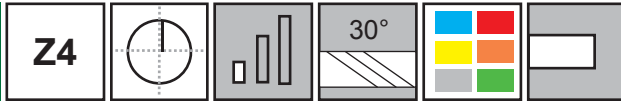

Designed for aggressive milling of most materials with reduced deflection, improved tool life and overall economy.

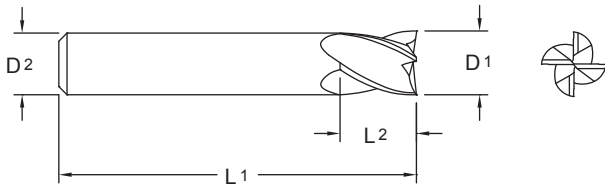

• Micro sizes available.

Tool No.	EDP	Diameter			Shank		OAL		Flute Length	
		D1			D2		L1		L2	
		Inch	mm	Decimal	Inch	mm	Inch	mm	Inch	mm
16300500	16302			.0050	1/8		1-1/2		.010	
16300600	16304			.0060	1/8		1-1/2		.012	
16300700	16306			.0070	1/8		1-1/2		.014	
16300800	16308			.0080	1/8		1-1/2		.016	
16300900	16312			.0090	1/8		1-1/2		.018	
16301000	16314			.0100	1/8		1-1/2		.020	
16301100	16318			.0110	1/8		1-1/2		.022	
16301200	16320			.0120	1/8		1-1/2		.024	
16301300	16328			.0130	1/8		1-1/2		.026	
16301400	16330			.0140	1/8		1-1/2		.028	
16301500	16334			.0150	1/8		1-1/2		.030	
16301560	16300	1/64		.0156	1/8		1-1/2		.023	
16301600	16338			.0160	1/8		1-1/2		.032	
16301700	16340			.0170	1/8		1-1/2		.034	
16301800	16344			.0180	1/8		1-1/2		.036	
16301900	16346			.0190	1/8		1-1/2		.038	
16302000	16348			.0200	1/8		1-1/2		.040	
16302100	16350			.0210	1/8		1-1/2		.042	
16302200	16352			.0220	1/8		1-1/2		.044	
16302300	16354			.0230	1/8		1-1/2		.046	
16302400	16356			.0240	1/8		1-1/2		.048	
16302500	16358			.0250	1/8		1-1/2		.050	
16302600	16360			.0260	1/8		1-1/2		.052	
16302700	16362			.0270	1/8		1-1/2		.054	
16302800	16364			.0280	1/8		1-1/2		.056	
16302900	16366			.0290	1/8		1-1/2		.058	
16303000	16368			.0300	1/8		1-1/2		.060	
16303100	16370			.0310	1/8		1-1/2		.062	
16303120	16301	1/32		.0312	1/8		1-1/2		1/16	
16303200	16372			.0320	1/8		1-1/2		.064	
16303300	16373			.0330	1/8		1-1/2		.066	
16303400	16374			.0340	1/8		1-1/2		.068	
16303500	16375			.0350	1/8		1-1/2		.070	
16303600	16376			.0360	1/8		1-1/2		.072	
16303700	16377			.0370	1/8		1-1/2		.074	
16303800	16378			.0380	1/8		1-1/2		.076	

Inch	
D1	Tolerance
1/64	+ .000/- .001
1/32 - 1/4	+ .000/- .002
>1/4 - 3/4	+ .000/- .003
D1 Micro Sizes*	Tolerance
.005 - .060	+ .0005/- .0005

* Inch decimal size range .005 - .060" only.

Metric (mm)	
D1	Tolerance h10
1.00 - 3.00	+ .000/- .040
>3.00 - 6.00	+ .000/- .048
>6.00 - 10.00	+ .000/- .058
>10.00 - 18.00	+ .000/- .070
>18.00 - 20.00	+ .000/- .084

Series 163 coated tools on page 265.



Series 163 Continued

Tool No.	EDP	Diameter			Shank		OAL		Flute Length	
		D1			D2		L1		L2	
		Inch	mm	Decimal	Inch	mm	Inch	mm	Inch	mm
16303900	16379			.0390	1/8		1-1/2		.078	
16303940	16303		1.0	.0394		3.0		38		2.0
16304000	16380			.0400	1/8		1-1/2		.080	
16304100	16381			.0410	1/8		1-1/2		.082	
16304200	16382			.0420	1/8		1-1/2		.084	
16304300	16383			.0430	1/8		1-1/2		.086	
16304400	16384			.0440	1/8		1-1/2		.088	
16304500	16385			.0450	1/8		1-1/2		.090	
16304600	16386			.0460	1/8		1-1/2		.092	
16304680	16305	3/64		.0468	1/8		1-1/2		3/32	
16304700	16387			.0470	1/8		1-1/2		.094	
16304800	16388			.0480	1/8		1-1/2		.096	
16304900	16389			.0490	1/8		1-1/2		.098	
16305000	16390			.0500	1/8		1-1/2		.100	
16305100	16391			.0510	1/8		1-1/2		.102	
16305200	16392			.0520	1/8		1-1/2		.104	
16305300	16393			.0530	1/8		1-1/2		.106	
16305400	16394			.0540	1/8		1-1/2		.108	
16305500	16395			.0550	1/8		1-1/2		.110	
16305600	16396			.0560	1/8		1-1/2		.112	
16305700	16397			.0570	1/8		1-1/2		.114	
16305800	16398			.0580	1/8		1-1/2		.116	
16305900	16399			.0590	1/8		1-1/2		.118	
16305910	16307		1.5	.0591		3.0		38		3.0
16306000	16324			.0600	1/8		1-1/2		.120	
16306250	16309	1/16		.0625	1/8		1-1/2		1/8	
16307810	16310	5/64		.0781	1/8		1-1/2		5/32	
16307870	16311		2.0	.0787		3.0		38		4.0
16309370	16313	3/32		.0937	1/8		1-1/2		3/16	
16309840	16315		2.5	.0984		3.0		38		5.0
16310930	16316	7/64		.1093	1/8		1-1/2		7/32	
16311810	16317		3.0	.1181		3.0		38		6.0
16312500	16319	1/8		.1250	1/8		1-1/2		1/4	
16313780	16321		3.5	.1378		4.0		51		7.0
16314060	16322	9/64		.1406	3/16		2		5/16	
16315620	16323	5/32		.1562	3/16		2		5/16	
16315750	16325		4.0	.1575		4.0		51		8.0
16317180	16326	11/64		.1718	3/16		2		3/8	
16317720	16327		4.5	.1772		5.0		51		9.0
16318750	16329	3/16		.1875	3/16		2		3/8	
16319680	16331		5.0	.1968		5.0		51		11.0
16320310	16332	13/64		.2031	1/4		2		1/2	
16321650	16333		5.5	.2165		6.0		51		12.0
16321870	16335	7/32		.2187	1/4		2		1/2	

Series 163 coated tools on page 265.



4
Flute

Series 163 Continued

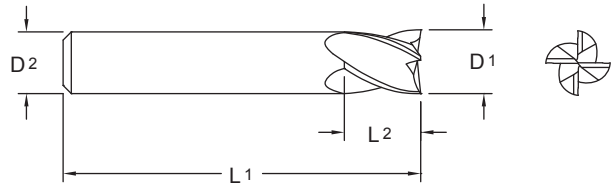
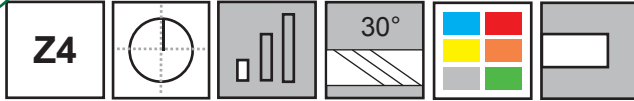

Tool No.	EDP	Diameter			Shank		OAL		Flute Length	
		D1			D2		L1		L2	
		Inch	mm	Decimal	Inch	mm	Inch	mm	Inch	mm
16323430	16336	15/64		.2343	1/4		2		1/2	
16323620	16337		6.0	.2362		6.0		51		13.0
16325000	16339	1/4		.2500	1/4		2		1/2	
16327560	16341		7.0	.2756		8.0		51		13.0
16328120	16342	9/32		.2812	5/16		2		1/2	
16331250	16343	5/16		.3125	5/16		2		1/2	
16331500	16345		8.0	.3150		8.0		51		13.0
16335430	16347		9.0	.3543		9.0		51		14.0
16337500	16349	3/8		.3750	3/8		2		5/8	
16339370	16351		10.0	.3937		10.0		51		14.0
16343310	16353		11.0	.4331		11.0		64		16.0
16343750	16355	7/16		.4375	7/16		2-1/2		5/8	
16347240	16357		12.0	.4724		12.0		64		16.0
16350000	16359	1/2		.5000	1/2		2-1/2		5/8	
16355120	16361		14.0	.5512		14.0		70		18.0
16362500	16363	5/8		.6250	5/8		3		3/4	
16362990	16365		16.0	.6299		16.0		76		20.0
16370870	16367		18.0	.7087		18.0		76		25.0
16375000	16369	3/4		.7500	3/4		3		1	
16378740	16371		20.0	.7874		20.0		76		25.0



Series 163 coated tools on page 265.



**TuffCut® GP
Series 163 Coated**

Z4



**4
Flute**

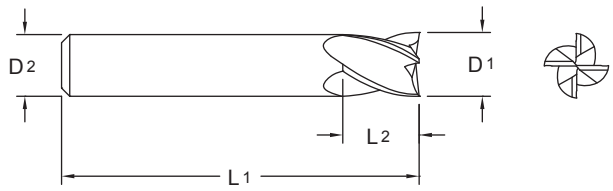

TiN		ALtima®		TiCN		Diameter			Shank		OAL		Flute Length	
						D1			D2		L1		L2	
Tool No.	EDP	Tool No.	EDP	Tool No.	EDP	Inch	mm	Decimal	Inch	mm	Inch	mm	Inch	mm
16311810T	56300	16311810A	56333	16311810C	56366		3.0	.1181		3.0		38		6.0
16312500T	56301	16312500A	56334	16312500C	56367	1/8		.1250	1/8		1-1/2		1/4	
16315750T	56305	16315750A	56338	16315750C	56371		4.0	.1575		4.0		51		8.0
16318750T	56308	16318750A	56341	16318750C	56374	3/16		.1875	3/16		2		3/8	
16319680T	56309	16319680A	56342	16319680C	56375		5.0	.1968		5.0		51		11.0
16323620T	56314	16323620A	56347	16323620C	56380		6.0	.2362		6.0		51		13.0
16325000T	56315	16325000A	56348	16325000C	56381	1/4		.2500	1/4		2		1/2	
16331250T	56318	16331250A	56351	16331250C	56384	5/16		.3125	5/16		2		1/2	
16331500T	56319	16331500A	56352	16331500C	56385		8.0	.3150		8.0		51		13.0
16337500T	56321	16337500A	56354	16337500C	56387	3/8		.3750	3/8		2		5/8	
16339370T	56322	16339370A	56355	16339370C	56388		10.0	.3937		10.0		51		14.0
16343750T	56324	16343750A	56357	16343750C	56390	7/16		.4375	7/16		2-1/2		5/8	
16347240T	56325	16347240A	56358	16347240C	56391		12.0	.4724		12.0		64		16.0
16350000T	56326	16350000A	56359	16350000C	56392	1/2		.5000	1/2		2-1/2		5/8	
16362500T	56328	16362500A	56361	16362500C	56394	5/8		.6250	5/8		3		3/4	
16362990T	56329	16362990A	56362	16362990C	56395		16.0	.6299		16.0		76		20.0
16375000T	56331	16375000A	56364	16375000C	56397	3/4		.7500	3/4		3		1	
16378740T	56332	16378740A	56365	16378740C	56398		20.0	.7874		20.0		76		25.0

Series 163 uncoated tools on page 262.



Page 354

163 / 163 Coated
TuffCut® GP

GENERAL PURPOSE

4
Flute

**TuffCut® GP
Series 122**

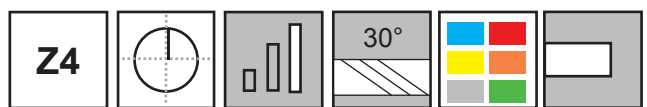

Designed for deep pocket milling and other applications where standard flute lengths are too short.

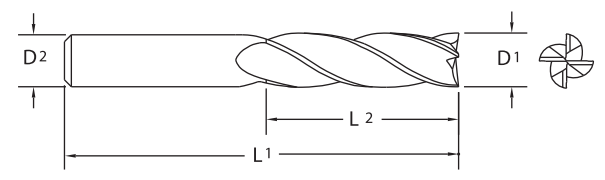

Tool No.	EDP	Diameter			Shank		OAL		Flute Length	
		D1			D2		L1		L2	
		Inch	mm	Decimal	Inch	mm	Inch	mm	Inch	mm
12211810	12203		3.0	.1181		3.0		64		25.0
12212500	12205	1/8		.1250	1/8		2-1/2		1	
12215750	12206		4.0	.1575		4.0		64		25.0
12218750	12207	3/16		.1875	3/16		3		1-1/8	
12219680	12208		5.0	.1968		5.0		64		25.0
12223620	12209		6.0	.2362		6.0		76		30.0
12225000	12211	1/4		.2500	1/4		3		1-1/4	
12227560	12212		7.0	.2756		8.0		83		30.0
12231250	12213	5/16		.3125	5/16		3-1/4		1-3/8	
12231500	12215		8.0	.3150		8.0		83		35.0
12235430	12216		9.0	.3543		10.0		89		35.0
12237500	12217	3/8		.3750	3/8		3-1/2		1-1/2	
12239370	12219		10.0	.3937		10.0		89		40.0
12243310	12220		11.0	.4331		12.0		102		40.0
12243750	12221	7/16		.4375	7/16		4		1-3/4	
12247240	12223		12.0	.4724		12.0		102		50.0
12250000	12225	1/2		.5000	1/2		4		2	
12262500	12227	5/8		.6250	5/8		4-5/8		2-1/2	
12262990	12229		16.0	.6299		16.0		117		65.0
12275000	12231	3/4		.7500	3/4		5-1/4		3	
12278740	12233		20.0	.7874		20.0		133		80.0
12298430	12235		25.0	.9843		25.0		152		80.0
12210000	12201	1		1.0000	1		6		3	

Inch	
D1	Tolerance
1/8 - 1/4	+0.000/-0.002
>1/4 - 1	+0.000/-0.003

Metric (mm)	
D1	Tolerance
3.00 - 6.00	+0.000/-0.051
7.00 - 25.00	+0.000/-0.076



**TuffCut® GP
Series 132**

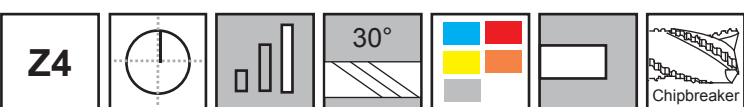

Chipbreakers are designed to minimize cutting forces, reduce or eliminate chatter and prolong tool life.

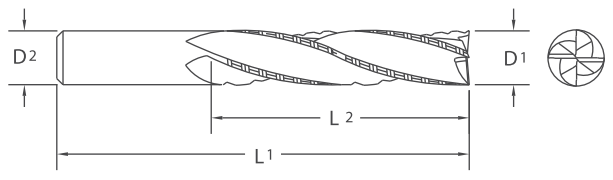

Tool No.	EDP	Diameter			Shank		OAL		Flute Length	
		D1			D2		L1		L2	
		Inch	mm	Decimal	Inch	mm	Inch	mm	Inch	mm
13211810	13203		3.0	.1181		3.0		64		25.0
13212500	13205	1/8		.1250	1/8		2-1/2		1	
13218750	13207	3/16		.1875	3/16		3		1-1/8	
13223620	13209		6.0	.2362		6.0		76		30.0
13225000	13211	1/4		.2500	1/4		3		1-1/4	
13231250	13213	5/16		.3125	5/16		3-1/4		1-3/8	
13231500	13215		8.0	.3150		8.0		83		35.0
13237500	13217	3/8		.3750	3/8		3-1/2		1-1/2	
13239370	13219		10.0	.3937		10.0		89		40.0
13243750	13221	7/16		.4375	7/16		4		1-3/4	
13247240	13223		12.0	.4724		12.0		102		50.0
13250000	13225	1/2		.5000	1/2		4		2	
13262500	13227	5/8		.6250	5/8		4-5/8		2-1/2	
13262990	13229		16.0	.6299		16.0		117		65.0
13275000	13231	3/4		.7500	3/4		5-1/4		3	
13278740	13233		20.0	.7874		20.0		133		80.0
13298430	13235		25.0	.9843		25.0		152		80.0
13210000	13201	1		1.0000	1		6		3	

Inch	
D1	Tolerance
1/8 - 1/4	+ .000/- .002
> 1/4 - 1	+ .000/- .003

Metric (mm)	
D1	Tolerance
3.00 - 6.00	+ .000/- .051
8.00 - 25.00	+ .000/- .076

- Chipbreaker geometry permits extremely high feed rates in roughing operations. Tools designed with tooth overlap to produce fairly smooth part finish.
- Designed for deep pocket milling and other applications where standard flute lengths are too short.
- TiN coating available.



122 / 132
TuffCut® GP

GENERAL PURPOSE



3
Flute

**TuffCut® GP
Series 116**

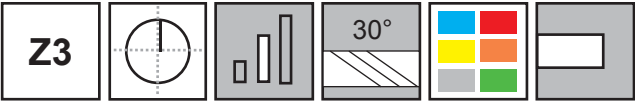

Designed for aggressive milling of most materials.

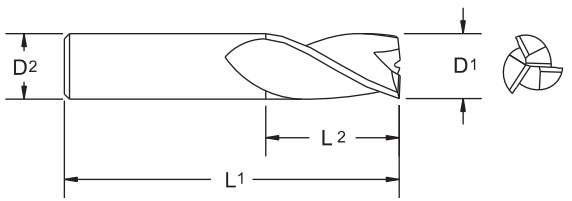

Tool No.	EDP	Diameter			Shank		OAL		Flute Length	
		D1			D2		L1		L2	
		Inch	mm	Decimal	Inch	mm	Inch	mm	Inch	mm
11601560	11601	1/64		.0156	1/8		1-1/2		1/32	
11603120	11603	1/32		.0312	1/8		1-1/2		5/64	
11603940	11605		1.0	.0394		3.0		38		3.0
11604680	11607	3/64		.0468	1/8		1-1/2		7/64	
11605910	11609		1.5	.0591		3.0		38		6.0
11606250	11611	1/16		.0625	1/8		1-1/2		3/16	
11607810	11613	5/64		.0781	1/8		1-1/2		3/16	
11607870	11615		2.0	.0787		3.0		38		9.0
11609370	11617	3/32		.0937	1/8		1-1/2		9/32	
11609840	11619		2.5	.0984		3.0		38		12.0
11610930	11623	7/64		.1093	1/8		1-1/2		3/8	
11611810	11625		3.0	.1181		3.0		38		12.0
11612500	11627	1/8		.1250	1/8		1-1/2		3/8	
11612501	11630	1/8		.1250	1/8		1-1/2		1/2	
11613780	11633		3.5	.1378		4.0		51		12.0
11614060	11634	9/64		.1406	3/16		2		1/2	
11615620	11635	5/32		.1562	3/16		2		1/2	
11615750	11637		4.0	.1575		4.0		51		14.0
11617190	11638	11/64		.1719	3/16		2		5/8	
11617720	11639		4.5	.1772		5.0		51		14.0
11618750	11641	3/16		.1875	3/16		2		5/8	
11619680	11643		5.0	.1968		5.0		51		20.0
11620310	11644	13/64		.2031	1/4		2-1/2		5/8	
11621650	11645		5.5	.2165		6.0		64		20.0
11621870	11647	7/32		.2187	1/4		2-1/2		5/8	
11623440	11648	15/64		.2344	1/4		2-1/2		3/4	
11623620	11649		6.0	.2362		6.0		64		20.0
11625000	11651	1/4		.2500	1/4		2-1/2		3/4	
11627560	11653		7.0	.2756		8.0		64		20.0
11628120	11655	9/32		.2812	5/16		2-1/2		3/4	
11631250	11657	5/16		.3125	5/16		2-1/2		13/16	
11631500	11659		8.0	.3150		8.0		64		20.0
11635430	11661		9.0	.3543		9.0		64		20.0
11637500	11663	3/8		.3750	3/8		2-1/2		1	
11639370	11665		10.0	.3937		10.0		70		25.0
11643310	11667		11.0	.4331		11.0		70		25.0

Inch	
D1	Tolerance
1/64	+ .000/- .001
1/32 - 1/4	+ .000/- .002
> 1/4 - 1-1/4	+ .000/- .003

Metric (mm)	
D1	Tolerance h10
1.00 - 3.00	+ .000/- .040
> 3.00 - 6.00	+ .000/- .048
> 6.00 - 10.00	+ .000/- .058
> 10.00 - 18.00	+ .000/- .070
> 18.00 - 30.00	+ .000/- .084
32.00	+ .000/- .100

Series 116 coated tools on page 270.



Series 116 Continued

Tool No.	EDP	Diameter			Shank		OAL		Flute Length	
		D1			D2		L1		L2	
		Inch	mm	Decimal	Inch	mm	Inch	mm	Inch	mm
11643750	11669	7/16		.4375	7/16		2-3/4		1	
11647240	11671		12.0	.4724		12.0		76		25.0
11650000	11673	1/2		.5000	1/2		3		1	
11655120	11675		14.0	.5512		14.0		89		30.0
11656250	11677	9/16		.5625	9/16		3-1/2		1-1/8	
11662500	11679	5/8		.6250	5/8		3-1/2		1-1/4	
11662990	11681		16.0	.6299		16.0		89		30.0
11670870	11683		18.00	.7087		18.0		102		35.0
11675000	11685	3/4		.7500	3/4		4		1-1/2	
11678740	11687		20.0	.7874		20.0		102		38.0
11686620	11689		22.0	.8662		22.0		102		40.0
11687500	11691	7/8		.8750	7/8		4		1-1/2	
11698430	11693		25.0	.9843		25.0		102		40.0
11610000	11621	1		1.0000	1		4		1-1/2	
11612510	11629	1-1/4		1.2500	1-1/4		4-3/8		1-9/16	
11612600	11631		32.0	1.2600		32.0		111		40.0

Series 116 coated tools on page 270.



Page 354

116
TuffCut® GP

GENERAL PURPOSE



Made in USA

ISO 9001:2008 Certified



For product information, call your local distributor.

3
Flute

TuffCut® GP
Series 116 Coated



NEW
Sizes

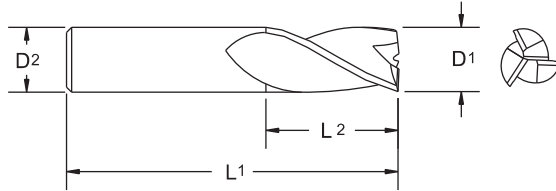

TiN		ALtima®		TiCN		Diameter			Shank		OAL		Flute Length	
Tool No.	EDP	Tool No.	EDP	Tool No.	EDP	D1			D2		L1		L2	
						Inch	mm	Decimal	Inch	mm	Inch	mm	Inch	mm
		11603940A	11606				1.0	.0394		3.0		38		3.0
		11605910A	11610				1.5	.0591		3.0		38		6.0
		11607870A	11616				2.0	.0787		3.0		38		9.0
		11609840A	11620				2.5	.0984		3.0		38		12.0
11611810T	11626	11611810A	51603	11611810C	51604		3.0	.1181		3.0		38		12.0
11612500T	11628	11612500A	51605	11612500C	51606	1/8		.1250	1/8		1-1/2		3/8	
11615750T	11636	11615750A	51607	11615750C	51608		4.0	.1575		4.0		51		14.0
11618750T	11642	11618750A	51609	11618750C	51610	3/16		.1875	3/16		2		5/8	
11619680T	11646	11619680A	51611	11619680C	51612		5.0	.1968		5.0		51		20.0
11623620T	11650	11623620A	51613	11623620C	51614		6.0	.2362		6.0		64		20.0
11625000T	11652	11625000A	51615	11625000C	51616	1/4		.2500	1/4		2-1/2		3/4	
11631250T	11658	11631250A	51617	11631250C	51618	5/16		.3125	5/16		2-1/2		13/16	
11631500T	11660	11631500A	51619	11631500C	51620		8.0	.3150		8.0		64		20.0
11637500T	11664	11637500A	51621	11637500C	51622	3/8		.3750	3/8		2-1/2		1	
11639370T	11666	11639370A	51623	11639370C	51624		10.0	.3937		10.0		70		25.0
11643750T	11670	11643750A	51625	11643750C	51626	7/16		.4375	7/16		2-3/4		1	
11647240T	11672	11647240A	51627	11647240C	51628		12.0	.4724		12.0		76		25.0
11650000T	11674	11650000A	51629	11650000C	51630	1/2		.5000	1/2		3		1	
11662500T	11680	11662500A	51631	11662500C	51632	5/8		.6250	5/8		3-1/2		1-1/4	
11662990T	11682	11662990A	51633	11662990C	51634		16.0	.6299		16.0		89		30.0
11675000T	11686	11675000A	51635	11675000C	51636	3/4		.7500	3/4		4		1-1/2	
11678740T	11688	11678740A	51637	11678740C	51638		20.0	.7874		20.0		102		38.0
11698430T	11694	11698430A	51639	11698430C	51640		25.0	.9843		25.0		102		40.0
11610000T	11622	11610000A	51601	11610000C	51602	1		1.0000	1		4		1-1/2	



Series 116 uncoated tools on page 268.



TuffCut® GP Series 116C Workhorse

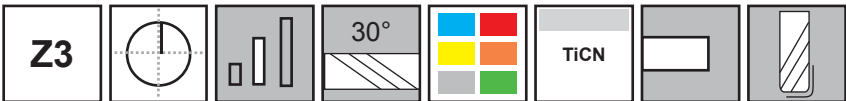

3
Flute

116 Coated / 116C Workhorse
TuffCut® GP

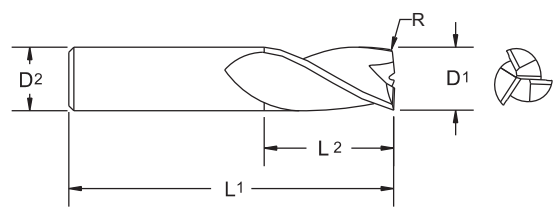

- Performs well in all materials including Stainless Steel, Inconel and Stellite.
- Produces long cuts at reasonable speeds on everyday equipment.
- Exceptional tool life at moderate speeds and feeds.
- Ideal for long cuts requiring accuracy and minimal tool wear deflection.
- Perfect Job Shop Tool.

TiCN		Diameter		Shank D2	OAL L1	Flute Length		Corner Radius R
		D1				L2		
Tool No.	EDP	Inch	Decimal	Inch	Inch	Inch	Inch	Inch
11612508C	11695	1/8	.1250	1/8	1-1/2	1/2		0.01
11615628C	11696	5/32	.1562	3/16	2	9/16		0.01
11618758C	11697	3/16	.1875	3/16	2	5/8		0.01
11621872C	11698	7/32	.2187	1/4	2-1/2	3/4		0.02
11625002C	11699	1/4	.2500	1/4	2-1/2	3/4		0.02
11628122C	11468	9/32	.2812	5/16	2-1/2	3/4		0.02
11631252C	11469	5/16	.3125	5/16	2-1/2	13/16		0.02
11634382C	11500	11/32	.3438	3/8	2-1/2	7/8		0.02
11637502C	11369	3/8	.3750	3/8	2-1/2	1		0.02
11640622C	11370	13/32	.4062	7/16	2-3/4	1		0.02
11643752C	11382	7/16	.4375	7/16	2-3/4	1		0.02
11646882C	11383	15/32	.4688	1/2	3	1-1/4		0.02
11650002C	11371	1/2	.5000	1/2	3	1-1/4		0.02
11650003C	11372	1/2	.5000	1/2	3	1-1/4		0.03
11662502C	11373	5/8	.6250	5/8	3-1/2	1-5/8		0.02
11662503C	11374	5/8	.6250	5/8	3-1/2	1-5/8		0.03
11675002C	11375	3/4	.7500	3/4	4	1-1/2		0.02
11675003C	11376	3/4	.7500	3/4	4	1-1/2		0.03
11610002C	11379	1	1.0000	1	4	1-1/2		0.02
11610003C	11380	1	1.0000	1	4	1-1/2		0.03
11610012C	11377	1	1.0000	1	4	2		0.02
11610013C	11378	1	1.0000	1	4	2		0.03

Inch	
D1	Tolerance
1/8 - 1/4	+0.00/-0.002
>1/4 - 1	+0.00/-0.003

Inch	
R	Tolerance
1/8 - 1	+0.002/-0.002

GENERAL PURPOSE



3
Flute

**TuffCut® GP
Series 169**

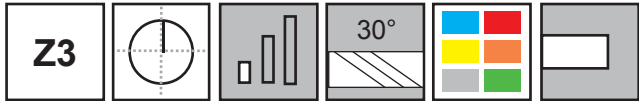

Designed for aggressive milling of most materials. Provides reduced deflection, improved tool life and overall economy.

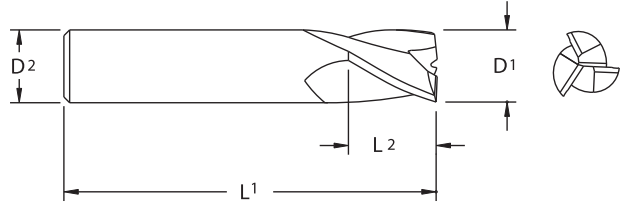

Tool No.	EDP	Diameter			Shank		OAL		Flute Length	
		D1			D2		L1		L2	
		Inch	mm	Decimal	Inch	mm	Inch	mm	Inch	mm
16901560	16900	1/64		.0156	1/8		1-1/2		.023	
16903120	16901	1/32		.0312	1/8		1-1/2		1/16	
16903940	16903		1.0	.0394		3.0		38		2.0
16904680	16905	3/64		.0468	1/8		1-1/2		3/32	
16905910	16907		1.5	.0591		3.0		38		3.0
16906250	16909	1/16		.0625	1/8		1-1/2		1/8	
16907810	16911	5/64		.0781	1/8		1-1/2		5/32	
16907870	16913		2.0	.0787		3.0		38		4.0
16909370	16915	3/32		.0937	1/8		1-1/2		3/16	
16909840	16917		2.5	.0984		3.0		38		5.0
16910930	16919	7/64		.1093	1/8		1-1/2		7/32	
16911810	16921		3.0	.1181		3.0		38		6.0
16912500	16923	1/8		.1250	1/8		1-1/2		1/4	
16913780	16925		3.5	.1378		4.0		51		7.0
16914060	16926	9/64		.1406	3/16		2		5/16	
16915620	16927	5/32		.1562	3/16		2		5/16	
16915750	16929		4.0	.1575		4.0		51		8.0
16917180	16930	11/64		.1718	3/16		2		3/8	
16917720	16931		4.5	.1772		5.0		51		9.0
16918750	16933	3/16		.1875	3/16		2		3/8	
16919680	16935		5.0	.1968		5.0		51		11.0
16920310	16936	13/64		.2031	1/4		2		1/2	
16921650	16937		5.5	.2165		6.0		51		12.0
16921870	16939	7/32		.2187	1/4		2		1/2	
16923430	16940	15/64		.2343	1/4		2		1/2	
16923620	16941		6.0	.2362		6.0		51		13.0
16925000	16943	1/4		.2500	1/4		2		1/2	
16927560	16945		7.0	.2756		8.0		51		13.0
16928120	16947	9/32		.2812	5/16		2		1/2	
16931250	16949	5/16		.3125	5/16		2		1/2	
16931500	16951		8.0	.3150		8.0		51		13.0
16935430	16953		9.0	.3543		9.0		51		14.0

Inch	
D1	Tolerance
1/64	+ .000/- .001
1/32 - 1/4	+ .000/- .002
>1/4 - 3/4	+ .000/- .003

Metric (mm)	
D1	Tolerance h10
1.00 - 3.00	+ .000/- .040
>3.00 - 6.00	+ .000/- .048
>6.00 - 10.00	+ .000/- .058
>10.00 - 18.00	+ .000/- .070
>18.00 - 20.00	+ .000/- .084

Series 169 coated tools on page 274.



Series 169 Continued

Tool No.	EDP	Diameter			Shank		OAL		Flute Length	
		D1			D2		L1		L2	
		Inch	mm	Decimal	Inch	mm	Inch	mm	Inch	mm
16937500	16955	3/8		.3750	3/8		2		5/8	
16939370	16957		10.0	.3937		10.0		51		14.0
16943310	16959		11.0	.4331		11.0		64		16.0
16943750	16961	7/16		.4375	7/16		2-1/2		5/8	
16947240	16963		12.0	.4724		12.0		64		16.0
16950000	16965	1/2		.5000	1/2		2-1/2		5/8	
16955120	16967		14.0	.5512		14.0		70		18.0
16962500	16969	5/8		.6250	5/8		3		3/4	
16962990	16971		16.0	.6299		16.0		76		20.0
16970870	16973		18.0	.7087		18.0		76		25.0
16975000	16975	3/4		.7500	3/4		3		1	
16978740	16977		20.0	.7874		20.0		76		25.0



Series 169 coated tools on page 274.



ISO 9001:2008 Certified

3

Flute **TuffCut® GP**
Series 169 Coated

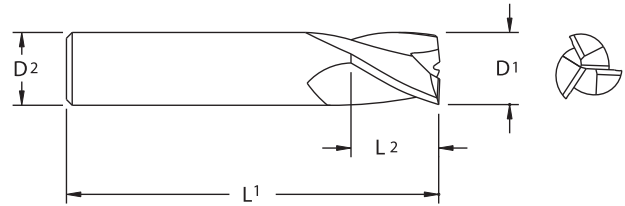

TiN		ALtima®		TiCN		Diameter			Shank		OAL		Flute Length	
Tool No.	EDP	Tool No.	EDP	Tool No.	EDP	D1			D2		L1		L2	
						Inch	mm	Decimal	Inch	mm	Inch	mm	Inch	mm
16911810T	56900	16911810A	56933	16911810C	56966		3.0	.1181		3.0		38		6.0
16912500T	56901	16912500A	56934	16912500C	56967	1/8		.1250	1/8		1-1/2		1/4	
16915750T	56905	16915750A	56938	16915750C	56971		4.0	.1575		4.0		51		8.0
16918750T	56908	16918750A	56941	16918750C	56974	3/16		.1875	3/16		2		3/8	
16919680T	56909	16919680A	56942	16919680C	56975		5.0	.1968		5.0		51		11.0
16923620T	56914	16923620A	56947	16923620C	56980		6.0	.2362		6.0		51		13.0
16925000T	56915	16925000A	56948	16925000C	56981	1/4		.2500	1/4		2		1/2	
16931250T	56918	16931250A	56951	16931250C	56984	5/16		.3125	5/16		2		1/2	
16931500T	56919	16931500A	56952	16931500C	56985		8.0	.3150		8.0		51		13.0
16937500T	56921	16937500A	56954	16937500C	56987	3/8		.3750	3/8		2		5/8	
16939370T	56922	16939370A	56955	16939370C	56988		10.0	.3937		10.0		51		14.0
16943750T	56924	16943750A	56957	16943750C	56990	7/16		.4375	7/16		2-1/2		5/8	
16947240T	56925	16947240A	56958	16947240C	56991		12.0	.4724		12.0		64		16.0
16950000T	56926	16950000A	56959	16950000C	56992	1/2		.5000	1/2		2-1/2		5/8	
16962500T	56928	16962500A	56961	16962500C	56994	5/8		.6250	5/8		3		3/4	
16962990T	56929	16962990A	56962	16962990C	56995		16.0	.6299		16.0		76		20.0
16975000T	56931	16975000A	56964	16975000C	56997	3/4		.7500	3/4		3		1	
16978740T	56932	16978740A	56965	16978740C	56998		20.0	.7874		20.0		76		25

Series 169 uncoated tools on page 272.



TuffCut® GP Series 169C Workhorse

Z3

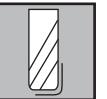
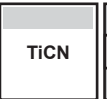
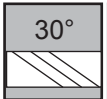
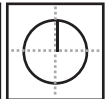

3
Flute

Designed for aggressive milling of most materials.

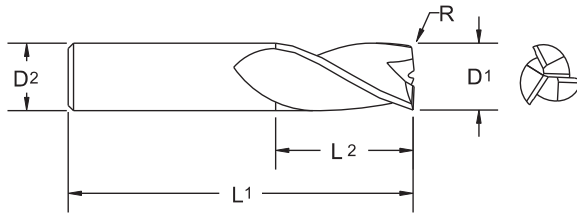

TiCN		Diameter		Shank	OAL	Flute Length		Corner Radius R
Tool No.	EDP	Inch	Decimal	D2 Inch	L1 Inch	L2 Inch		
16912508C	16978	1/8	.1250	1/8	1-1/2	1/4	0.01	
16915628C	16979	5/32	.1562	3/16	2	5/16	0.01	
16918758C	16980	3/16	.1875	3/16	2	3/8	0.01	
16921872C	16981	7/32	.2187	1/4	2	1/2	0.02	
16925002C	16982	1/4	.2500	1/4	2	1/2	0.02	
16928122C	11381	9/32	.2812	5/16	2	1/2	0.02	
16931252C	16983	5/16	.3125	5/16	2	1/2	0.02	
16934382C	16984	11/32	.3438	3/8	2	1/2	0.02	
16937502C	16985	3/8	.3750	3/8	2	5/8	0.02	
16940622C	16986	13/32	.4062	7/16	2-1/2	9/16	0.02	
16943752C	16987	7/16	.4375	7/16	2-1/2	5/8	0.02	
16946882C	16988	15/32	.4688	1/2	2-1/2	1/2	0.02	
16950002C	16989	1/2	.5000	1/2	2-1/2	5/8	0.02	
16950003C	16990	1/2	.5000	1/2	2-1/2	5/8	0.03	
16962502C	16991	5/8	.6250	5/8	3	3/4	0.02	
16962503C	16992	5/8	.6250	5/8	3	3/4	0.03	
16975002C	16993	3/4	.7500	3/4	3	1	0.02	
16975003C	16994	3/4	.7500	3/4	3	1	0.03	

Inch	
D1	Tolerance
1/8 - 1/4	+ .000/- .002
>1/4 - 3/4	+ .000/- .003

Inch	
R	Tolerance
1/8 - 3/4	+ .002/- .002

- Performs well in all materials including Stainless Steel, Inconel and Stellite.
- Produces long cuts at reasonable speeds on everyday equipment.
- Exceptional tool life at moderate speeds and feeds.
- Ideal for long cuts requiring accuracy and minimal tool wear deflection.
- Perfect Job Shop Tool.



Page 354

169 Coated / 169C Workhorse

TuffCut® GP

GENERAL PURPOSE

2
Flute

**TuffCut® GP
Series 121**

Z2

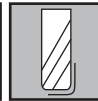
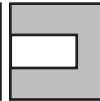
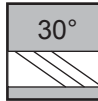
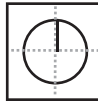

Designed for aggressive milling of most materials.

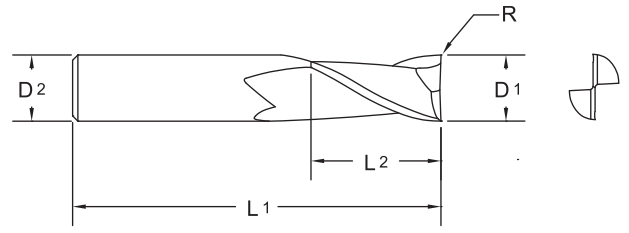

- Micro sizes available.

Tool No.	EDP	Diameter			Shank		OAL		Flute Length		Corner Radius	
		D1			D2		L1		L2		R	
		Inch	mm	Decimal	Inch	mm	Inch	mm	Inch	mm	Inch	mm
12100500	52101			.0050	1/8			1-1/2		.015		
12100600	52191			.0060	1/8			1-1/2		.018		
12100700	52192			.0070	1/8			1-1/2		.021		
12100780	52102		0.2	.0078		3.0		38		0.6		
12100800	52193			.0080	1/8			1-1/2		.024		
12100900	52194			.0090	1/8			1-1/2		.027		
12101000	52103			.0100	1/8			1-1/2		.030		
12101100	52195			.0110	1/8			1-1/2		.033		
12101180	52104		0.3	.0118		3.0		38		0.9		
12101200	52196			.0120	1/8			1-1/2		.036		
12101300	52197			.0130	1/8			1-1/2		.039		
12101400	52198			.0140	1/8			1-1/2		.042		
12101500	52105			.0150	1/8			1-1/2		.045		
12101560	12106	1/64		.0156	1/8			1-1/2		1/32		
12101570	52107		0.4	.0157		3.0		38		1.2		
12101600	52199			.0160	1/8			1-1/2		.048		
12101700	52250			.0170	1/8			1-1/2		.051		
12101800	52251			.0180	1/8			1-1/2		.054		
12101900	52252			.0190	1/8			1-1/2		.057		
12101960	52108		0.5	.0196		3.0		38		1.5		
12102000	52109			.0200	1/8			1-1/2		.060		
12102100	52253			.0210	1/8			1-1/2		.063		
12102200	52254			.0220	1/8			1-1/2		.066		
12102300	52255			.0230	1/8			1-1/2		.069		
12102360	52110		0.6	.0236		3.0		38		1.8		
12102400	52256			.0240	1/8			1-1/2		.072		
12102500	52111			.0250	1/8			1-1/2		.075		
12102600	52257			.0260	1/8			1-1/2		.078		
12102700	52258			.0270	1/8			1-1/2		.081		
12102750	52112		0.7	.0275		3.0		38		2.1		
12102800	52259			.0280	1/8			1-1/2		.084		
12102900	52260			.0290	1/8			1-1/2		.087		
12103000	52113			.0300	1/8			1-1/2		.090		
12103120	12114	1/32		.0312	1/8			1-1/2		5/64		

Inch	
D1	Tolerance
1/64	+ .000/- .001
1/32 - 1/4	+ .000/- .002
>1/4 - 1-1/4	+ .000/- .003
D1 Micro Sizes*	Tolerance
.005 - .100	+ .0005/- .0005

*Inch decimal size range .005-.100" only.

Metric (mm)	
D1	Tolerance h10
0.20 - 0.50	+ .000/- .025
0.60 - 3.00	+ .000/- .040
>3.00 - 6.00	+ .000/- .048
>6.00 - 10.00	+ .000/- .058
>10.00 - 18.00	+ .000/- .070
>18.00 - 30.00	+ .000/- .084
32.00	+ .000/- .100

Inch	
R	Tolerance
1/8 - 1	+ .002/- .002

Metric (mm)	
R	Tolerance
3.0 - 25.0	+ .05/- .05

Series 121 coated tools on page 281.



Series 121 Continued

2
Flute

121
TuffCut® GP

GENERAL PURPOSE

Tool No.	EDP	Diameter			Shank		OAL		Flute Length		Corner Radius	
		D1			D2		L1		L2		R	
		Inch	mm	Decimal	Inch	mm	Inch	mm	Inch	mm	Inch	mm
12103150	52115		0.8	.0315		3.0		38		2.4		
12103500	52116			.0350	1/8		1-1/2		.105			
12103540	52117		0.9	.0354		3.0		38		2.7		
12103940	12118		1.0	.0394		3.0		38		3.0		
12104000	52120			.0400	1/8		1-1/2		.120			
12104330	52121		1.1	.0433		3.0		38		3.3		
12104500	52122			.0450	1/8		1-1/2		.135			
12104680	12123	3/64		.0468	1/8		1-1/2		7/64			
12104720	52124		1.2	.0472		3.0		38		3.6		
12105000	52125			.0500	1/8		1-1/2		.150			
12105120	52126		1.3	.0512		3.0		38		3.9		
12105500	52127			.0550	1/8		1-1/2		.165			
12105510	52128		1.4	.0551		3.0		38		4.2		
12105910	12129		1.5	.0591		3.0		38		6.0		
12105911	52129		1.5	.0591		3.0		38		4.5		
12106000	52131			.0600	1/8		1-1/2		.180			
12106250	12132	1/16		.0625	1/8		1-1/2		3/16			
12106300	52133		1.6	.0630		3.0		38		4.8		
12106500	52134			.0650	1/8		1-1/2		.195			
12106690	52135		1.7	.0669		3.0		38		5.1		
12107000	52136			.0700	1/8		1-1/2		.210			
12107090	52137		1.8	.0709		3.0		38		5.4		
12107480	52138		1.9	.0748		3.0		38		5.7		
12107500	52139			.0750	1/8		1-1/2		.225			
12107810	12140	5/64		.0781	1/8		1-1/2		3/16			
12107870	12141		2.0	.0787		3.0		38		9.0		
12107871	52141		2.0	.0787		3.0		38		6.0		
12108000	52143			.0800	1/8		1-1/2		.240			
12108500	52144			.0850	1/8		1-1/2		.255			
12109000	52145			.0900	1/8		1-1/2		.270			
12109370	12146	3/32		.0937	1/8		1-1/2		9/32			
12109500	52147			.0950	1/8		1-1/2		.285			
12109840	12148		2.5	.0984		3.0		38		12.0		
12110010	52150			.1000	1/8		1-1/2		.300			
12110930	12151	7/64		.1093	1/8		1-1/2		3/8			
12111810	12152		3.0	.1181		3.0		38		12.0		
12111811	52402		3.0	.1181		3.0		38		12.0		0.500
12112500	12153	1/8		.1250	1/8		1-1/2		3/8			
12112511	52401	1/8		.1250	1/8		1-1/2		3/8			0.015
12112512	52403	1/8		.1250	1/8		1-1/2		3/8			0.020
12112501	12150	1/8		.1250	1/8		1-1/2		1/2			
12113780	12156		3.5	.1378		4.0		51		12.0		
12114060	12187	9/64		.1406	3/16		2		1/2			

Series 121 coated tools on page 281.



2
Flute

Series 121 Continued

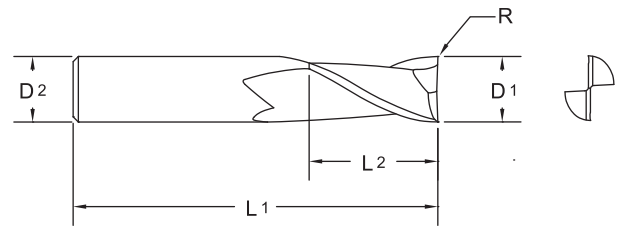
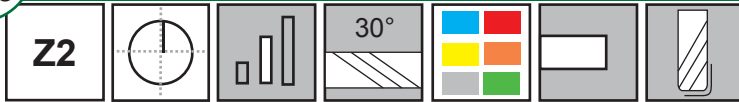

Tool No.	EDP	Diameter			Shank		OAL		Flute Length		Corner Radius	
		D1			D2		L1		L2		R	
		Inch	mm	Decimal	Inch	mm	Inch	mm	Inch	mm	Inch	mm
12115620	12157	5/32		.1562	3/16		2		1/2			
12115750	12158		4.0	.1575		4.0		51		14.0		
12115751	52404		4.0	.1575		4.0		51		14.0		0.500
12115752	52422		4.0	.1575		4.0		51		14.0		0.750
12117190	12188	11/64		.1719	3/16		2		5/8			
12117720	12159		4.5	.1772		5.0		51		14.0		
12118750	12160	3/16		.1875	3/16		2		5/8			
12118751	52405	3/16		.1875	3/16		2		5/8			0.015
12118752	52407	3/16		.1875	3/16		2		5/8			0.020
12118753	52409	3/16		.1875	3/16		2		5/8			0.030
12119680	12161		5.0	.1968		5.0		51		20.0		
12119681	52406		5.0	.1968		5.0		51		20.0		0.500
12119682	52424		5.0	.1968		5.0		51		20.0		0.750
12119683	52440		5.0	.1968		5.0		51		20.0		1.000
12120310	12189	13/64		.2031	1/4		2-1/2		5/8			
12121650	12162		5.5	.2165		6.0		64		20.0		
12121870	12163	7/32		.2187	1/4		2-1/2		5/8			
12123440	12190	15/64		.2344	1/4		2-1/2		3/4			
12123620	12164		6.0	.2362		6.0		64		20.0		
12123621	52408		6.0	.2362		6.0		64		20.0		0.500
12123622	52426		6.0	.2362		6.0		64		20.0		0.750
12123623	52442		6.0	.2362		6.0		64		20.0		1.000
12125000	12165	1/4		.2500	1/4		2-1/2		3/4			
12125001	52411	1/4		.2500	1/4		2-1/2		3/4			0.015
12125002	52413	1/4		.2500	1/4		2-1/2		3/4			0.020
12125003	52415	1/4		.2500	1/4		2-1/2		3/4			0.030
12125004	52417	1/4		.2500	1/4		2-1/2		3/4			0.045
12127560	12166		7.0	.2756		8.0		64		20.0		
12128120	12167	9/32		.2812	5/16		2-1/2		3/4			
12131250	12168	5/16		.3125	5/16		2-1/2		13/16			
12131251	52419	5/16		.3125	5/16		2-1/2		13/16			0.015
12131252	52421	5/16		.3125	5/16		2-1/2		13/16			0.020
12131253	52423	5/16		.3125	5/16		2-1/2		13/16			0.030
12131254	52425	5/16		.3125	5/16		2-1/2		13/16			0.045
12131500	12169		8.0	.3150		8.0		64		20.0		
12131501	52410		8.0	.3150		8.0		64		20.0		0.500
12131502	52428		8.0	.3150		8.0		64		20.0		0.750
12131503	52444		8.0	.3150		8.0		64		20.0		1.000
12131504	52456		8.0	.3150		8.0		64		20.0		1.500

Series 121 coated tools on page 281.



Series 121 Continued

Tool No.	EDP	Diameter			Shank		OAL		Flute Length		Corner Radius	
		D1			D2		L1		L2		R	
		Inch	mm	Decimal	Inch	mm	Inch	mm	Inch	mm	Inch	mm
12135430	12170		9.0	.3543		9.0		64		20.0		
12137500	12171	3/8		.3750	3/8		2-1/2		1			
12137501	52427	3/8		.3750	3/8		2-1/2		1		0.015	
12137502	52429	3/8		.3750	3/8		2-1/2		1		0.020	
12137503	52431	3/8		.3750	3/8		2-1/2		1		0.030	
12137504	52433	3/8		.3750	3/8		2-1/2		1		0.045	
12139370	12172		10.0	.3937		10.0		70		25.0		
12139371	52412		10.0	.3937		10.0		70		25.0		0.500
12139372	52430		10.0	.3937		10.0		70		25.0		0.750
12139373	52446		10.0	.3937		10.0		70		25.0		1.000
12139374	52458		10.0	.3937		10.0		70		25.0		1.500
12143310	12173		11.0	.4331		11.0		70		25.0		
12143750	12174	7/16		.4375	7/16		2-3/4		1			
12147240	12175		12.0	.4724		12.0		76		25.0		
12147241	52414		12.0	.4724		12.0		76		25.0		0.500
12147242	52432		12.0	.4724		12.0		76		25.0		0.750
12147243	52448		12.0	.4724		12.0		76		25.0		1.000
12147244	52460		12.0	.4724		12.0		76		25.0		1.500
12147245	52468		12.0	.4724		12.0		76		25.0		2.000
12150000	12176	1/2		.5000	1/2		3		1			
12150001	52435	1/2		.5000	1/2		3		1		0.015	
12150002	52437	1/2		.5000	1/2		3		1		0.020	
12150003	52439	1/2		.5000	1/2		3		1		0.030	
12150004	52441	1/2		.5000	1/2		3		1		0.045	
12150005	52443	1/2		.5000	1/2		3		1		0.060	
12155120	12177		14.0	.5512		14.0		89		30.0		
12156250	12178	9/16		.5625	9/16		3-1/2		1-1/8			
12162500	12179	5/8		.6250	5/8		3-1/2		1-1/4			
12162501	52445	5/8		.6250	5/8		3-1/2		1-1/4		0.015	
12162502	52447	5/8		.6250	5/8		3-1/2		1-1/4		0.020	
12162503	52449	5/8		.6250	5/8		3-1/2		1-1/4		0.030	
12162504	52451	5/8		.6250	5/8		3-1/2		1-1/4		0.045	
12162505	52453	5/8		.6250	5/8		3-1/2		1-1/4		0.060	
12162506	52455	5/8		.6250	5/8		3-1/2		1-1/4		0.090	
12162990	12180		16.0	.6299		16.0		89		30.0		
12162991	52416		16.0	.6299		16.0		89		30.0		0.500
12162992	52434		16.0	.6299		16.0		89		30.0		0.750
12162993	52450		16.0	.6299		16.0		89		30.0		1.000
12162994	52462		16.0	.6299		16.0		89		30.0		1.500
12162995	52470		16.0	.6299		16.0		89		30.0		2.000
12162996	52476		16.0	.6299		16.0		89		30.0		2.500
12162997	52482		16.0	.6299		16.0		89		30.0		3.000
12170870	12181		18.00	.7087		18.00		102		35.0		
12175000	12182	3/4		.7500	3/4		4		1-1/2			

Series 121 coated tools on page 281.



2
Flute

Series 121 Continued

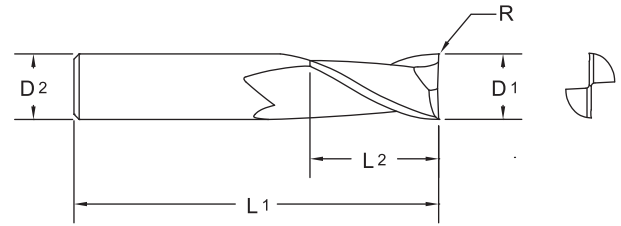
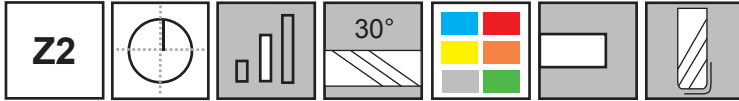

Tool No.	EDP	Diameter			Shank		OAL		Flute Length		Corner Radius	
		D1			D2		L1		L2		R	
		Inch	mm	Decimal	Inch	mm	Inch	mm	Inch	mm	Inch	mm
12175001	52457	3/4		.7500	3/4		4		1-1/2		0.015	
12175002	52459	3/4		.7500	3/4		4		1-1/2		0.020	
12175003	52461	3/4		.7500	3/4		4		1-1/2		0.030	
12175004	52463	3/4		.7500	3/4		4		1-1/2		0.045	
12175005	52465	3/4		.7500	3/4		4		1-1/2		0.060	
12175006	52467	3/4		.7500	3/4		4		1-1/2		0.090	
12175007	52469	3/4		.7500	3/4		4		1-1/2		0.125	
12178740	12183		20.0	.7874		20.0		102		38.0		
12178741	52418		20.0	.7874		20.0		102		38.0		0.500
12178742	52436		20.0	.7874		20.0		102		38.0		0.750
12178743	52452		20.0	.7874		20.0		102		38.0		1.000
12178744	52464		20.0	.7874		20.0		102		38.0		1.500
12178745	52472		20.0	.7874		20.0		102		38.0		2.000
12178746	52478		20.0	.7874		20.0		102		38.0		2.500
12178747	52484		20.0	.7874		20.0		102		38.0		3.000
12186620	12184		22.0	.8662		22.0		102		40.0		
12187500	12185	7/8		.8750	7/8		4		1-1/2			
12198430	12186		25.0	.9843		25.0		102		40.0		
12198431	52420		25.0	.9843		25.0		102		40.0		0.500
12198432	52438		25.0	.9843		25.0		102		40.0		0.750
12198433	52454		25.0	.9843		25.0		102		40.0		1.000
12198434	52466		25.0	.9843		25.0		102		40.0		1.500
12198435	52474		25.0	.9843		25.0		102		40.0		2.000
12198436	52480		25.0	.9843		25.0		102		40.0		2.500
12198437	52486		25.0	.9843		25.0		102		40.0		3.000
12110000	12149	1		1.0000	1		4		1-1/2			
12110001	52471	1		1.0000	1		4		1-1/2		0.015	
12110002	52473	1		1.0000	1		4		1-1/2		0.020	
12110003	52475	1		1.0000	1		4		1-1/2		0.030	
12110004	52477	1		1.0000	1		4		1-1/2		0.045	
12110005	52479	1		1.0000	1		4		1-1/2		0.060	
12110006	52481	1		1.0000	1		4		1-1/2		0.090	
12110007	52483	1		1.0000	1		4		1-1/2		0.125	
12112510	12154	1-1/4		1.2500	1-1/4		4-3/8		1-9/16			
12112600	12155		32.0	1.2600		32.0		111		40.0		

Series 121 coated tools on page 281.



TuffCut® GP Series 121 Coated

Z2

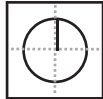

2 Flute

NEW Sizes

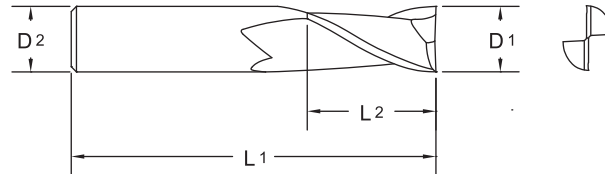

121 / 121 Coated
TuffCut® GP

GENERAL PURPOSE

TiN		ALtima®		TiCN		Diameter			Shank		OAL		Flute Length	
Tool No.	EDP	Tool No.	EDP	Tool No.	EDP	D1			D2		L1		L2	
Tool No.	EDP	Tool No.	EDP	Tool No.	EDP	Inch	mm	Decimal	Inch	mm	Inch	mm	Inch	mm
		12103940A	12119				1.0	.0394		3.0		38		3.0
		12105910A	12130				1.5	.0591		3.0		38		6.0
		12107870A	12142				2.0	.0787		3.0		38		9.0
		12109840A	12147				2.5	.0984		3.0		38		12.0
12111810T	12270	12111810A	52153	12111810C	52154		3.0	.1181		3.0		38		12.0
12112500T	12261	12112500A	52155	12112500C	52156	1/8		.1250	1/8		1-1/2		3/8	
12115750T	12278	12115750A	52157	12115750C	52158		4.0	.1575		4.0		51		14.0
12118750T	12262	12118750A	52159	12118750C	52160	3/16		.1875	3/16		2		5/8	
12119680T	12271	12119680A	52161	12119680C	52162		5.0	.1968		5.0		51		20.0
12123620T	12272	12123620A	52163	12123620C	52164		6.0	.2362		6.0		64		20.0
12125000T	12263	12125000A	52165	12125000C	52166	1/4		.2500	1/4		2-1/2		3/4	
12131250T	12264	12131250A	52167	12131250C	52168	5/16		.3125	5/16		2-1/2		13/16	
12131500T	12273	12131500A	52169	12131500C	52170		8.0	.3150		8.0		64		20.0
12137500T	12265	12137500A	52171	12137500C	52172	3/8		.3750	3/8		2-1/2		1	
12139370T	12274	12139370A	52173	12139370C	52174		10.0	.3937		10.0		70		25.0
12143750T	12266	12143750A	52175	12143750C	52176	7/16		.4375	7/16		2-3/4		1	
12147240T	12275	12147240A	52177	12147240C	52178		12.0	.4724		12.0		76		25.0
12150000T	12267	12150000A	52179	12150000C	52180	1/2		.5000	1/2		3		1	
12162500T	12268	12162500A	52181	12162500C	52182	5/8		.6250	5/8		3-1/2		1-1/4	
12162990T	12276	12162990A	52183	12162990C	52184		16.0	.6299		16.0		89		30.0
12175000T	12269	12175000A	52185	12175000C	52186	3/4		.7500	3/4		4		1-1/2	
12178740T	12277	12178740A	52187	12178740C	52188		20.0	.7874		20.0		102		38.0
12198430T	12280	12198430A	52189	12198430C	52190		25.0	.9843		25.0		102		40.0
12110000T	12279	12110000A	52151	12110000C	52152	1		1.0000	1		4		1-1/2	

Series 121 uncoated tools on page 276.



2
Flute
NEW
Sizes

TuffCut® GP Series 164

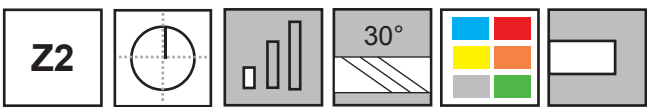

Designed for aggressive milling of most materials with reduced deflection, improved tool life and overall economy.

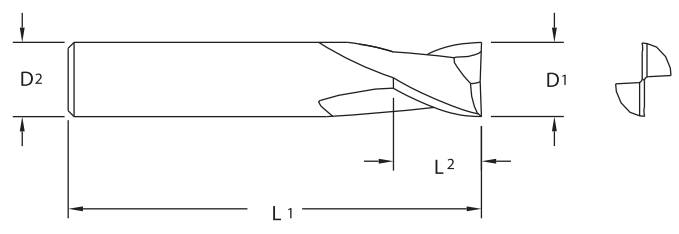

- Micro sizes available.

Tool No.	EDP	Diameter			Shank		OAL		Flute Length	
		D1			D2		L1		L2	
		Inch	mm	Decimal	Inch	mm	Inch	mm	Inch	mm
16400500	16468			.0050	1/8		1-1/2		.010	
16400600	16469			.0060	1/8		1-1/2		.012	
16400700	16470			.0070	1/8		1-1/2		.014	
16400780	16402		0.2	.0078		3.0		38		0.4
16400800	16471			.0080	1/8		1-1/2		.016	
16400900	16472			.0090	1/8		1-1/2		.018	
16401000	16473			.0100	1/8		1-1/2		.020	
16401100	16474			.0110	1/8		1-1/2		.022	
16401180	16404		0.3	.0118		3.0		38		0.6
16401200	16475			.0120	1/8		1-1/2		.024	
16401300	16476			.0130	1/8		1-1/2		.026	
16401400	16477			.0140	1/8		1-1/2		.028	
16401500	16478			.0150	1/8		1-1/2		.030	
16401560	16400	1/64		.0156	1/8		1-1/2		.023	
16401570	16406		0.4	.0157		3.0		38		0.8
16401600	16479			.0160	1/8		1-1/2		.032	
16401700	16480			.0170	1/8		1-1/2		.034	
16401800	16481			.0180	1/8		1-1/2		.036	
16401900	16482			.0190	1/8		1-1/2		.038	
16401960	16408		0.5	.0196		3.0		38		1.0
16402000	16483			.0200	1/8		1-1/2		.040	
16402100	16484			.0210	1/8		1-1/2		.042	
16402200	16485			.0220	1/8		1-1/2		.044	
16402300	16486			.0230	1/8		1-1/2		.046	
16402360	16412		0.6	.0236		3.0		38		1.2
16402400	16487			.0240	1/8		1-1/2		.048	
16402500	16488			.0250	1/8		1-1/2		.050	
16402600	16489			.0260	1/8		1-1/2		.052	
16402700	16490			.0270	1/8		1-1/2		.054	
16402750	16414		0.7	.0275		3.0		38		1.4
16402800	16491			.0280	1/8		1-1/2		.056	
16402900	16492			.0290	1/8		1-1/2		.058	
16403000	16493			.0300	1/8		1-1/2		.060	
16403100	16572			.0310	1/8		1-1/2		.062	

Inch	
D1	Tolerance
1/64	+ .000/- .001
1/32 - 1/4	+ .000/- .002
>1/4 - 3/4	+ .000/- .003
D1 Micro Sizes*	Tolerance
.005 - .060	+ .0005/- .0005

*Inch decimal size range .005-.060" only.

Metric (mm)	
D1	Tolerance h10
0.20 - 0.50	+ .000/- .025
0.60 - 3.00	+ .000/- .040
>3.00 - 6.00	+ .000/- .048
>6.00 - 10.00	+ .000/- .058
>10.00 - 18.00	+ .000/- .070
>18.00 - 20.00	+ .000/- .084

Series 164 coated tools on page 285.



Series 164 Continued

2
Flute

Tool No.	EDP	Diameter			Shank		OAL		Flute Length	
		D1			D2		L1		L2	
		Inch	mm	Decimal	Inch	mm	Inch	mm	Inch	mm
16403120	16401	1/32		.0312	1/8		1-1/2		1/16	
16403150	16418		0.8	.0315		3.0		38		1.6
16403200	16573			.0320	1/8		1-1/2		.064	
16403300	16574			.0330	1/8		1-1/2		.066	
16403400	16575			.0340	1/8		1-1/2		.067	
16403500	16494			.0350	1/8		1-1/2		.070	
16403540	16420		0.9	.0354		3.0		38		1.8
16403600	16576			.0360	1/8		1-1/2		.072	
16403700	16577			.0370	1/8		1-1/2		.074	
16403800	16578			.0380	1/8		1-1/2		.076	
16403900	16579			.0390	1/8		1-1/2		.078	
16403940	16403		1.0	.0394		3.0		38		2.0
16404000	16495			.0400	1/8		1-1/2		.080	
16404100	16580			.0410	1/8		1-1/2		.082	
16404200	16581			.0420	1/8		1-1/2		.084	
16404300	16582			.0430	1/8		1-1/2		.086	
16404330	16428		1.1	.0433		3.0		38		2.2
16404400	16583			.0440	1/8		1-1/2		.088	
16404500	16496			.0450	1/8		1-1/2		.090	
16404600	16584			.0460	1/8		1-1/2		.092	
16404680	16405	3/64		.0468	1/8		1-1/2		3/32	
16404700	16585			.0470	1/8		1-1/2		.094	
16404720	16430		1.2	.0472		3.0		38		2.4
16404800	16586			.0480	1/8		1-1/2		.096	
16404900	16587			.0490	1/8		1-1/2		.098	
16405000	16497			.0500	1/8		1-1/2		.100	
16405100	16588			.0510	1/8		1-1/2		.102	
16405120	16434		1.3	.0512		3.0		38		2.6
16405200	16589			.0520	1/8		1-1/2		.104	
16405300	16590			.0530	1/8		1-1/2		.106	
16405400	16591			.0540	1/8		1-1/2		.108	
16405500	16498			.0550	1/8		1-1/2		.110	
16405510	16438		1.4	.0551		3.0		38		2.8
16405600	16592			.0560	1/8		1-1/2		.112	
16405700	16593			.0570	1/8		1-1/2		.114	
16405800	16594			.0580	1/8		1-1/2		.116	
16405900	16595			.0590	1/8		1-1/2		.118	
16405910	16407		1.5	.0591		3.0		38		3.0
16406000	16499			.0600	1/8		1-1/2		.120	
16406250	16409	1/16		.0625	1/8		1-1/2		1/8	
16406300	16444		1.6	.0630		3.0		38		3.2
16406690	16446		1.7	.0669		3.0		38		3.4
16407090	16448		1.8	.0709		3.0		38		3.6
16407480	16450		1.9	.0748		3.0		38		3.8

Series 164 coated tools
on page 285.

164
TuffCut® GP

GENERAL PURPOSE



2
Flute

Series 164 Continued

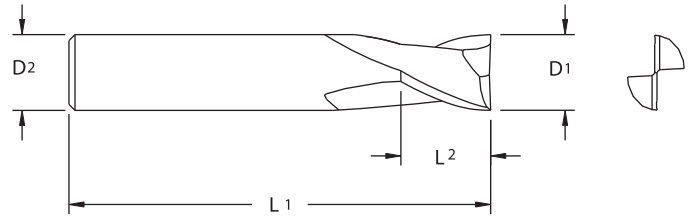
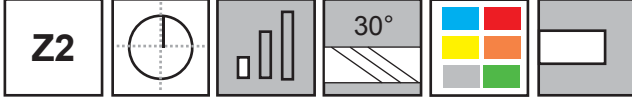

Tool No.	EDP	Diameter			Shank		OAL		Flute Length	
		D1			D2		L1		L2	
		Inch	mm	Decimal	Inch	mm	Inch	mm	Inch	mm
16407810	16410	5/64		.0781	1/8		1-1/2		5/32	
16407870	16411		2.0	.0787		3.0		38		4.0
16409370	16413	3/32		.0937	1/8		1-1/2		3/16	
16409840	16415		2.5	.0984		3.0		38		5.0
16410930	16416	7/64		.1093	1/8		1-1/2		7/32	
16411810	16417		3.0	.1181		3.0		38		6.0
16412500	16419	1/8		.1250	1/8		1-1/2		1/4	
16413780	16421		3.5	.1378		4.0		51		7.0
16414060	16422	9/64		.1406	3/16		2		5/16	
16415620	16423	5/32		.1562	3/16		2		5/16	
16415750	16425		4.0	.1575		4.0		51		8.0
16417180	16426	11/64		.1718	3/16		2		3/8	
16417720	16427		4.5	.1772		5.0		51		9.0
16418750	16429	3/16		.1875	3/16		2		3/8	
16419680	16431		5.0	.1968		5.0		51		11.0
16420310	16432	13/64		.2031	1/4		2		1/2	
16421650	16433		5.5	.2165		6.0		51		12.0
16421870	16435	7/32		.2187	1/4		2		1/2	
16423430	16436	15/64		.2343	1/4		2		1/2	
16423620	16437		6.0	.2362		6.0		51		13.0
16425000	16439	1/4		.2500	1/4		2		1/2	
16427560	16441		7.0	.2756		8.0		51		13.0
16428120	16442	9/32		.2812	5/16		2		1/2	
16431250	16443	5/16		.3125	5/16		2		1/2	
16431500	16445		8.0	.3150		8.0		51		13.0
16435430	16447		9.0	.3543		9.0		51		14.0
16437500	16449	3/8		.3750	3/8		2		5/8	
16439370	16451		10.0	.3937		10.0		51		14.0
16443310	16453		11.0	.4331		11.0		64		16.0
16443750	16455	7/16		.4375	7/16		2-1/2		5/8	
16447240	16457		12.0	.4724		12.0		64		16.0
16450000	16459	1/2		.5000	1/2		2-1/2		5/8	
16455120	16461		14.0	.5512		14.0		70		18.0
16462500	16463	5/8		.6250	5/8		3		3/4	
16462990	16465		16.0	.6299		16.0		76		20.0
16470870	16466		18.0	.7087		18.0		76		25.0
16475000	16467	3/4		.7500	3/4		3		1	
16478740	16462		20.0	.7874		20.0		76		25.0

Series 164 coated tools on page 285.



TuffCut® GP Series 164 Coated



2 Flute

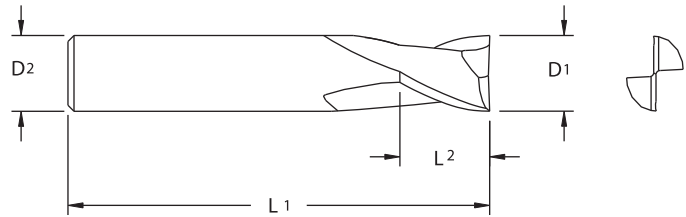

164 / 164 Coated
TuffCut® GP

TiN		ALtima®		TiCN		Diameter			Shank		OAL		Flute Length	
Tool No.	EDP	Tool No.	EDP	Tool No.	EDP	D1			D2		L1		L2	
						Inch	mm	Decimal	Inch	mm	Inch	mm	Inch	mm
16411810T	56400	16411810A	56433	16411810C	56466		3.0	.1181		3.0		38		6.0
16412500T	56401	16412500A	56434	16412500C	56467	1/8		.1250	1/8		1-1/2		1/4	
16415750T	56405	16415750A	56438	16415750C	56471		4.0	.1575		4.0		51		8.0
16418750T	56408	16418750A	56441	16418750C	56474	3/16		.1875	3/16		2		3/8	
16419680T	56409	16419680A	56442	16419680C	56475		5.0	.1968		5.0		51		11.0
16423620T	56414	16423620A	56447	16423620C	56480		6.0	.2362		6.0		51		13.0
16425000T	56415	16425000A	56448	16425000C	56481	1/4		.2500	1/4		2		1/2	
16431250T	56418	16431250A	56451	16431250C	56484	5/16		.3125	5/16		2		1/2	
16431500T	56419	16431500A	56452	16431500C	56485		8.0	.3150		8.0		51		13.0
16437500T	56421	16437500A	56454	16437500C	56487	3/8		.3750	3/8		2		5/8	
16439370T	56422	16439370A	56455	16439370C	56488		10.0	.3937		10.0		51		14.0
16443750T	56424	16443750A	56457	16443750C	56490	7/16		.4375	7/16		2-1/2		5/8	
16447240T	56425	16447240A	56458	16447240C	56491		12.0	.4724		12.0		64		16.0
16450000T	56426	16450000A	56459	16450000C	56492	1/2		.5000	1/2		2-1/2		5/8	
16462500T	56428	16462500A	56461	16462500C	56494	5/8		.6250	5/8		3		3/4	
16462990T	56429	16462990A	56462	16462990C	56495		16.0	.6299		16.0		76		20.0
16475000T	56431	16475000A	56464	16475000C	56497	3/4		.7500	3/4		3		1	
16478740T	56432	16478740A	56465	16478740C	56498		20.0	.7874		20.0		76		25.0

Series 164 uncoated tools on page 282.



For product information, call your local distributor.

GENERAL PURPOSE

2
Flute

**TuffCut® GP
Series 123**

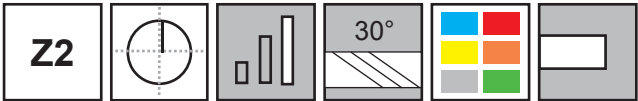

Designed for deep pocket milling and other applications where standard flute lengths are too short.

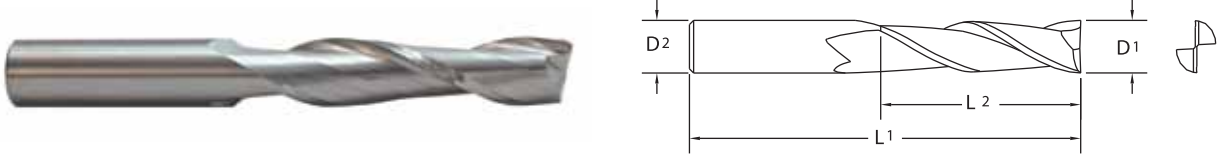

Tool No.	EDP	Diameter			Shank		OAL		Flute Length	
		D1			D2		L1		L2	
		Inch	mm	Decimal	Inch	mm	Inch	mm	Inch	mm
12311810	12303		3.0	.1181		3.0		64		25.0
12312500	12305	1/8		.1250	1/8		2-1/2		1	
12315750	12306		4.0	.1575		4.0		64		25.0
12318750	12307	3/16		.1875	3/16		3		1-1/8	
12319680	12308		5.0	.1968		5.0		64		25.0
12323620	12309		6.0	.2362		6.0		76		30.0
12325000	12311	1/4		.2500	1/4		3		1-1/4	
12327560	12312		7.0	.2756		8.0		83		30.0
12331250	12313	5/16		.3125	5/16		3-1/4		1-3/8	
12331500	12315		8.0	.3150		8.0		83		35.0
12335430	12316		9.0	.3543		10.0		89		35.0
12337500	12317	3/8		.3750	3/8		3-1/2		1-1/2	
12339370	12319		10.0	.3937		10.0		89		40.0
12343310	12320		11.0	.4331		12.0		102		40.0
12343750	12321	7/16		.4375	7/16		4		1-3/4	
12347240	12323		12.0	.4724		12.0		102		50.0
12350000	12325	1/2		.5000	1/2		4		2	
12362500	12327	5/8		.6250	5/8		4-5/8		2-1/2	
12362990	12329		16.0	.6299		16.0		117		65.0
12375000	12331	3/4		.7500	3/4		5-1/4		3	
12378740	12333		20.0	.7874		20.0		133		80.0
12398430	12335		25.0	.9843		25.0		152		80.0
12310000	12301	1		1.0000	1		6		3	

Inch	
D1	Tolerance
1/8 - 1/4	+0.000/-0.002
>1/4 - 1	+0.000/-0.003

Metric (mm)	
D1	Tolerance
3.00 - 6.00	+0.000/-0.051
7.00 - 25.00	+0.000/-0.076



ISO 9001:2008 Certified

**TuffCut® GP
Series 140**

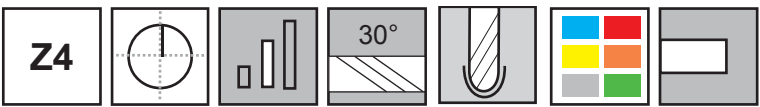

Manufactured with a full ball radius end. Designed for milling fillets or similar rounded corners in the bottom of a cut.



- Ideal for most ferrous metal applications.

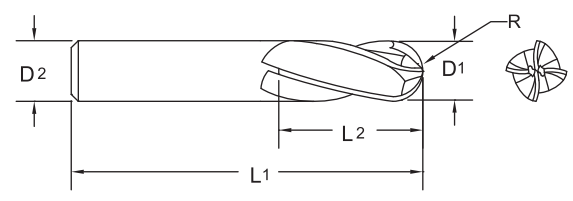

Tool No.	EDP	Diameter			Shank		OAL		Flute Length	
		D1			D2		L1		L2	
		Inch	mm	Decimal	Inch	mm	Inch	mm	Inch	mm
14003120	14001	1/32		.0312	1/8		1-1/2		5/64	
14003940	14003		1.0	.0394	3/8					3.0
14004680	14005	3/64		.0468	1/8		1-1/2		7/64	
14005910	14007		1.5	.0591	3/8			38		6.0
14006250	14009	1/16		.0625	1/8		1-1/2		3/16	
14007810	14011	5/64		.0781	1/8		1-1/2		3/16	
14007870	14013		2.0	.0787	3/8			38		9.0
14009370	14015	3/32		.0937	1/8		1-1/2		9/32	
14009840	14017		2.5	.0984	3/8			38		12.0
14010930	14021	7/64		.1093	1/8		1-1/2		3/8	
14011810	14023		3.0	.1181	3/8			38		12.0
14012500	14025	1/8		.1250	1/8		1-1/2		3/8	
14013780	14027		3.5	.1378	4/8			51		12.0
14015620	14029	5/32		.1562	3/16		2		1/2	
14015750	14031		4.0	.1575	4/8			51		14.0
14017720	14033		4.5	.1772	5/8			51		14.0
14018750	14035	3/16		.1875	3/16		2		5/8	
14019680	14037		5.0	.1968	5/8			51		20.0
14021650	14039		5.5	.2165	6/8			64		20.0
14021870	14041	7/32		.2187	1/4		2-1/2		5/8	
14023620	14043		6.0	.2362	6/8			64		20.0
14025000	14045	1/4		.2500	1/4		2-1/2		3/4	
14027560	14047		7.0	.2756	8/8			64		20.0
14028120	14049	9/32		.2812	5/16		2-1/2		3/4	
14031250	14051	5/16		.3125	5/16		2-1/2		13/16	
14031500	14053		8.0	.3150	8/8			64		20.0
14035430	14055		9.0	.3543	9/8			64		20.0
14037500	14057	3/8		.3750	3/8		2-1/2		1	
14039370	14059		10.0	.3937	10/8			70		25.0
14043310	14061		11.0	.4331	11/8			70		25.0
14043750	14063	7/16		.4375	7/16		2-3/4		1	
14047240	14065		12.0	.4724	12/8			76		25.0
14050000	14067	1/2		.5000	1/2		3		1	
14055120	14069		14.0	.5512	14/8			89		30.0
14056250	14071	9/16		.5625	9/16		3-1/2		1-1/8	
14062500	14073	5/8		.6250	5/8		3-1/2		1-1/4	
14062990	14075		16.0	.6299	16/8			89		30.0
14068750	14077	11/16		.6875	3/4		4		1-3/8	
14070870	14079		18.0	.7087	18/8			102		35.0
14075000	14081	3/4		.7500	3/4		4		1-1/2	
14078740	14083		20.0	.7874	20/8			102		38.0
14086620	14085		22.0	.8662	22/8			102		40.0
14087500	14087	7/8		.8750	7/8		4		1-1/2	
14098430	14089		25.0	.9843	25/8			102		40.0
14010000	14019	1		1.0000	1		4		1-1/2	

Inch	
D1	Tolerance
1/32 - 1/4	+0.000/-0.002
>1/4 - 1	+0.000/-0.003

Metric (mm)	
D1	Tolerance h10
1.00 - 3.00	+0.000/-0.040
>3.00 - 6.00	+0.000/-0.048
>6.00 - 10.00	+0.000/-0.058
>10.00 - 18.00	+0.000/-0.070
>18.00 - 25.00	+0.000/-0.084

Inch	
R	Tolerance
≤1/16	+0.001/-0.001
>1/16 - 1/8	+0.002/-0.002
>1/8	+0.003/-0.003







Metric (mm)	
R	Tolerance
≤1.5	+0.025/-0.025
1.6 - 3.0	+0.050/-0.050
>3.0	+0.075/-0.075

Series 140 coated tools on page 288.

123 / 140
TuffCut® GP

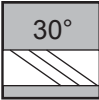
GENERAL PURPOSE

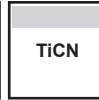
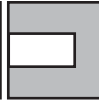

4 Flute Ball
TuffCut® GP Series 140 Coated
Z4



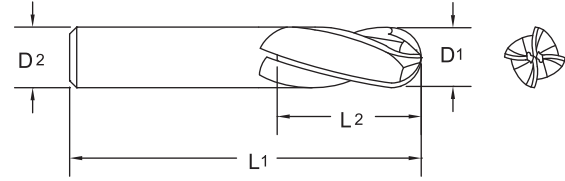





NEW Sizes



TiN		ALtima®		TiCN		Diameter			Shank		OAL		Flute Length	
Tool No.	EDP	Tool No.	EDP	Tool No.	EDP	D1			D2		L1		L2	
						Inch	mm	Decimal	Inch	mm	Inch	mm	Inch	mm
		14003940A	14108				1.0	.0394		3.0		38		3.0
		14005910A	14109				1.5	.0591		3.0		38		6.0
		14007870A	14110				2.0	.0787		3.0		38		9.0
		14009840A	14111				2.5	.0984		3.0		38		12.0
14011810T	14072	14011810A	14000	14011810C	14036		3.0	.1181		3.0		38		12.0
14012500T	14074	14012500A	14002	14012500C	14038	1/8		.1250	1/8		1-1/2		3/8	
14015750T	14076	14015750A	14004	14015750C	14040		4.0	.1575		4.0		51		14.0
14018750T	14078	14018750A	14006	14018750C	14042	3/16		.1875	3/16		2		5/8	
14019680T	14080	14019680A	14008	14019680C	14044		5.0	.1968		5.0		51		20.0
14023620T	14082	14023620A	14010	14023620C	14046		6.0	.2362		6.0		64		20.0
14025000T	14084	14025000A	14012	14025000C	14048	1/4		.2500	1/4		2-1/2		3/4	
14031250T	14086	14031250A	14014	14031250C	14050	5/16		.3125	5/16		2-1/2		13/16	
14031500T	14088	14031500A	14016	14031500C	14052		8.0	.3150		8.0		64		20.0
14037500T	14090	14037500A	14018	14037500C	14054	3/8		.3750	3/8		2-1/2		1	
14039370T	14091	14039370A	14020	14039370C	14056		10.0	.3937		10.0		70		25.0
14043750T	14092	14043750A	14022	14043750C	14058	7/16		.4375	7/16		2-3/4		1	
14047240T	14093	14047240A	14024	14047240C	14060		12.0	.4724		12.0		76		25.0
14050000T	14094	14050000A	14026	14050000C	14062	1/2		.5000	1/2		3		1	
14062500T	14095	14062500A	14028	14062500C	14064	5/8		.6250	5/8		3-1/2		1-1/4	
14062990T	14096	14062990A	14030	14062990C	14066		16.0	.6299		16.0		89		30.0
14075000T	14097	14075000A	14032	14075000C	14068	3/4		.7500	3/4		4		1-1/2	
14078740T	14098	14078740A	14034	14078740C	14070		20.0	.7874		20.0		102		38.0
14098430T	54003	14098430A	54004	14098430C	54005		25.0	.9843		25.0		102		40.0
14010000T	54000	14010000A	54001	14010000C	54002	1		1.0000	1		4		1-1/2	

Series 140 uncoated tools on page 287.



TuffCut® GP Series 165

Z4

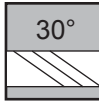
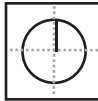

4
Flute
Ball

Manufactured with full ball radius end.

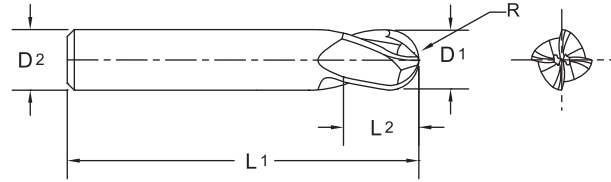

- Ideal for most ferrous metal applications

Tool No.	EDP	Diameter			Shank		OAL		Flute Length	
		D1			D2		L1		L2	
		Inch	mm	Decimal	Inch	mm	Inch	mm	Inch	mm
16501560	16500	1/64		.0156	1/8		1-1/2		.023	
16503120	16501	1/32		.0312	1/8		1-1/2		1/16	
16503940	16503		1.0	.0394		3.0		38		2.0
16504680	16505	3/64		.0468	1/8		1-1/2		3/32	
16505910	16507		1.5	.0591		3.0		38		3.0
16506250	16509	1/16		.0625	1/8		1-1/2		1/8	
16507810	16510	5/64		.0781	1/8		1-1/2		5/32	
16507870	16511		2.0	.0787		3.0		38		4.0
16509370	16513	3/32		.0937	1/8		1-1/2		3/16	
16509840	16515		2.5	.0984		3.0		38		5.0
16510930	16516	7/64		.1093	1/8		1-1/2		7/32	
16511810	16517		3.0	.1181		3.0		38		6.0
16512500	16519	1/8		.1250	1/8		1-1/2		1/4	
16513780	16521		3.5	.1378		4.0		51		7.0
16514060	16522	9/64		.1406	3/16		2		5/16	
16515620	16523	5/32		.1562	3/16		2		5/16	
16515750	16525		4.0	.1575		4.0		51		8.0
16517180	16526	11/64		.1718	3/16		2		3/8	
16517720	16527		4.5	.1772		5.0		51		9.0
16518750	16529	3/16		.1875	3/16		2		3/8	
16519680	16531		5.0	.1968		5.0		51		11.0
16520310	16532	13/64		.2031	1/4		2		1/2	
16521650	16533		5.5	.2165		6.0		51		12.0
16521870	16535	7/32		.2187	1/4		2		1/2	
16523430	16536	15/64		.2343	1/4		2		1/2	
16523620	16537		6.0	.2362		6.0		51		13.0
16525000	16539	1/4		.2500	1/4		2		1/2	
16527560	16541		7.0	.2756		8.0		51		13.0
16528120	16542	9/32		.2812	5/16		2		1/2	
16531250	16543	5/16		.3125	5/16		2		1/2	
16531500	16545		8.0	.3150		8.0		51		13.0
16535430	16547		9.0	.3543		9.0		51		14.0
16537500	16549	3/8		.3750	3/8		2		5/8	
16539370	16551		10.0	.3937		10.0		51		14.0
16543310	16553		11.0	.4331		11.0		64		16.0
16543750	16555	7/16		.4375	7/16		2-1/2		5/8	

Inch	
D1	Tolerance
1/64	+ .000/- .001
1/32 - 1/4	+ .000/- .002
>1/4 - 3/4	+ .000/- .003

Metric (mm)	
D1	Tolerance h10
1.00 - 3.00	+ .000/- .040
>3.00 - 6.00	+ .000/- .048
>6.00 - 10.00	+ .000/- .058
>10.00 - 18.00	+ .000/- .070
>18.00 - 20.00	+ .000/- .084

Inch	
R	Tolerance
≤ 1/16	+ .001/- .001
> 1/16 - 1/8	+ .002/- .002
> 1/8	+ .003/- .003

Metric (mm)	
R	Tolerance
≤ 1.5	+ .025/- .025
1.6 - 3.0	+ .050/- .050
> 3.0	+ .075/- .075

Series 165 coated tools on page 290.

140 Coated / 165
TuffCut® GP

GENERAL PURPOSE



4
Flute
Ball

Series 165 Continued

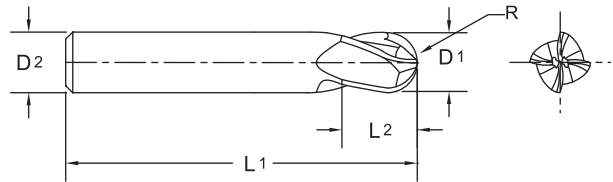
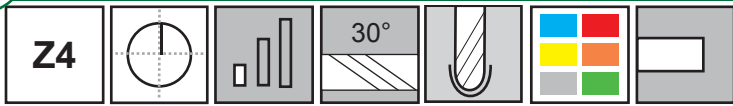

Tool No.	EDP	Diameter			Shank		OAL		Flute Length	
		D1			D2		L1		L2	
		Inch	mm	Decimal	Inch	mm	Inch	mm	Inch	mm
16547240	16557		12.0	.4724		12.0		64		16.0
16550000	16559	1/2		.5000	1/2		2-1/2		5/8	
16555120	16561		14.0	.5512		14.0		70		18.0
16562500	16563	5/8		.6250	5/8		3		3/4	
16562990	16565		16.0	.6299		16.0		76		20.0
16570870	16567		18.0	.7087		18.0		76		25.0
16575000	16569	3/4		.7500	3/4		3		1	
16578740	16571		20.0	.7874		20.0		76		25.0



4
Flute
Ball

TuffCut® GP
Series 165 Coated

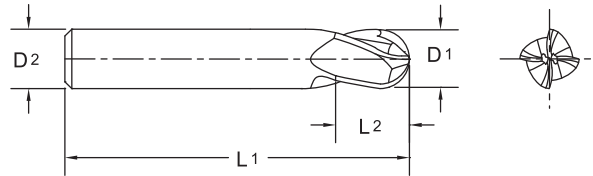

TiN		ALtima®		TiCN		Diameter			Shank		OAL		Flute Length	
D1		D2		L1		L2								
Tool No.	EDP	Tool No.	EDP	Tool No.	EDP	Inch	mm	Decimal	Inch	mm	Inch	mm	Inch	mm
16511810T	56500	16511810A	56533	16511810C	56566		3.0	.1181		3.0		38		6.0
16512500T	56501	16512500A	56534	16512500C	56567	1/8		.1250	1/8		1-1/2		1/4	
16515750T	56505	16515750A	56538	16515750C	56571		4.0	.1575		4.0		51		8.0
16518750T	56508	16518750A	56541	16518750C	56574	3/16		.1875	3/16		2		3/8	
16519680T	56509	16519680A	56542	16519680C	56575		5.0	.1968		5.0		51		11.0
16523620T	56514	16523620A	56547	16523620C	56580		6.0	.2362		6.0		51		13.0
16525000T	56515	16525000A	56548	16525000C	56581	1/4		.2500	1/4		2		1/2	
16531250T	56518	16531250A	56551	16531250C	56584	5/16		.3125	5/16		2		1/2	
16531500T	56519	16531500A	56552	16531500C	56585		8.0	.3150		8.0		51		13.0
16537500T	56521	16537500A	56554	16537500C	56587	3/8		.3750	3/8		2		5/8	
16539370T	56522	16539370A	56555	16539370C	56588		10.0	.3937		10.0		51		14.0
16543750T	56524	16543750A	56557	16543750C	56590	7/16		.4375	7/16		2-1/2		5/8	
16547240T	56525	16547240A	56558	16547240C	56591		12.0	.4724		12.0		64		16.0
16550000T	56526	16550000A	56559	16550000C	56592	1/2		.5000	1/2		2-1/2		5/8	
16562500T	56528	16562500A	56561	16562500C	56594	5/8		.6250	5/8		3		3/4	
16562990T	56529	16562990A	56562	16562990C	56595		16.0	.6299		16.0		76		20.0
16575000T	56531	16575000A	56564	16575000C	56597	3/4		.7500	3/4		3		1	
16578740T	56532	16578740A	56565	16578740C	56598		20.0	.7874		20.0		76		25.0



Series 165 uncoated tools on page 289.

TuffCut® GP Series 145

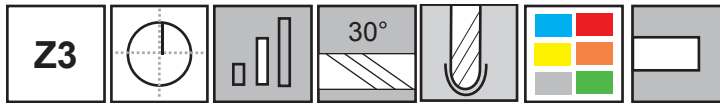

Manufactured with a full ball radius end. Designed for milling fillets or similar rounded corners in the bottom of a cut. Ideal for most ferrous metal applications. Inch sizes available as a special. Call customer service for pricing.

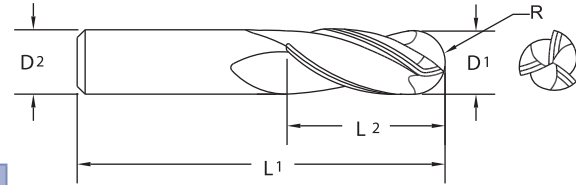

Tool No.	EDP	Diameter		Shank	OAL	Flute Length
		D1		D2	L1	L2
		mm	Decimal	mm	mm	mm
14503940	14501	1.0	.0394	3.0	38	3.0
14505910	14504	1.5	.0591	3.0	38	6.0
14507870	14507	2.0	.0787	3.0	38	9.0
14511810	14513	3.0	.1181	3.0	38	12.0
14515750	14519	4.0	.1575	4.0	51	14.0
14519680	14525	5.0	.1968	5.0	51	20.0
14523620	14531	6.0	.2362	6.0	64	20.0
14531500	14537	8.0	.3150	8.0	64	20.0
14539370	14543	10.0	.3937	10.0	70	25.0

Metric (mm)	
D1	Tolerance h10
1.00 - 3.00	+ .000/- .040
>3.00 - 6.00	+ .000/- .048
>6.00 - 10.00	+ .000/- .058

Metric (mm)	
R	Tolerance
≤1.5	+ .025/- .025
1.6 - 3.0	+ .050/- .050
>3.0	+ .075/- .075



TuffCut® GP Series 145 Coated

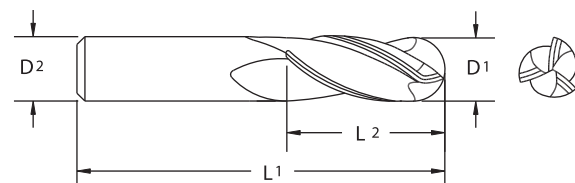

TiN		ALtima®		TiCN		Diameter		Shank	OAL	Flute Length
D1		D2		L1		L2				
Tool No.	EDP	Tool No.	EDP	Tool No.	EDP	mm	Decimal	mm	mm	mm
14511810T	14514	14511810A	14515	14511810C	14570	3.0	.1181	3.0	38	12.0
14515750T	14520	14515750A	14521	14515750C	14571	4.0	.1575	4.0	51	14.0
14519680T	14526	14519680A	14527	14519680C	14572	5.0	.1968	5.0	51	20.0
14523620T	14532	14523620A	14533	14523620C	14573	6.0	.2362	6.0	64	20.0
14531500T	14538	14531500A	14359	14531500C	14574	8.0	.3150	8.0	64	20.0
14539370T	14544	14539370A	14545	14539370C	14575	10.0	.3937	10.0	70	25.0



3 Flute Ball

165 / 165 Coated / 145 / 145 Coated
TuffCut® GP

GENERAL PURPOSE

3 Flute Ball

**TuffCut® GP
Series 150**

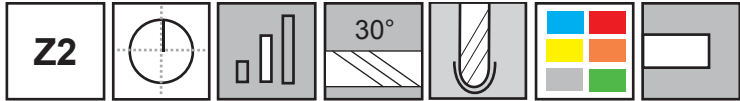

Manufactured with a full ball radius end. Designed for milling fillets or similar rounded corners in the bottom of a cut. Ideal for most ferrous metal applications.

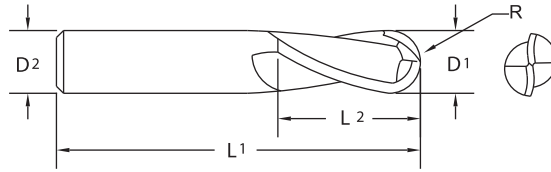

Tool No.	EDP	Diameter			Shank		OAL		Flute Length	
		D1			D2		L1		L2	
		Inch	mm	Decimal	Inch	mm	Inch	mm	Inch	mm
15001500	15002			.0150	1/8		1-1/2		.045	
15001570	15038		0.4	.0157		3		38		1.2
15001960	15040		0.5	.0196		3		38		1.5
15002000	15004			.0200	1/8		1-1/2		.060	
15002360	15042		0.6	.0236		3		38		1.8
15002500	15006			.0250	1/8		1-1/2		.075	
15002750	15044		0.7	.0275		3		38		2.1
15003000	15008			.0300	1/8		1-1/2		.090	
15003120	15001	1/32		.0312	1/8		1-1/2		5/64	
15003150	15046		0.8	.0315		3		38		2.4
15003500	15010			.0350	1/8		1-1/2		.105	
15003540	15048		0.9	.0354		3		38		2.7
15003940	15003		1.0	.0394		3		38		3.0
15004000	15012			.0400	1/8		1-1/2		.120	
15004330	15052		1.1	.0433		3		38		3.3
15004500	15014			.0450	1/8		1-1/2		.135	
15004680	15005	3/64		.0468	1/8		1-1/2		7/64	
15004720	15054		1.2	.0472		3		38		3.6
15005000	15016			.0500	1/8		1-1/2		.150	
15005120	15056		1.3	.0512		3		38		3.9
15005500	15018			.0550	1/8		1-1/2		.165	
15005510	15058		1.4	.0551		3		38		4.2
15005910	15007		1.5	.0591		3		38		6.0
15005911	15060		1.5	.0591		3		38		4.5
15006000	15020			.0600	1/8		1-1/2		.180	
15006250	15009	1/16		.0625	1/8		1-1/2		3/16	
15006300	15062		1.6	.0630		3		38		4.8
15006500	15022			.0650	1/8		1-1/2		.195	
15006690	15064		1.7	.0669		3		38		5.1
15007000	15024			.0700	1/8		1-1/2		.210	
15007090	15066		1.8	.0709		3		38		5.4
15007480	15068		1.9	.0748		3		38		5.7
15007500	15026			.0750	1/8		1-1/2		.225	
15007810	15011	5/64		.0781	1/8		1-1/2		3/16	

Inch	
D1	Tolerance
1/32 - 1/4	+ .000/- .002
>1/4 - 1	+ .000/- .003
D1 Micro Sizes*	
D1	Tolerance
.015 - .100	+ .0005/- .0005

*Inch decimal size range .015-.100" only.

Metric (mm)	
D1	Tolerance h10
0.40 - 0.50	+ .000/- .025
0.60 - 3.00	+ .000/- .040
>3.00 - 6.00	+ .000/- .048
>6.00 - 10.00	+ .000/- .058
>10.00 - 18.00	+ .000/- .070
>18.00 - 25.00	+ .000/- .084

Inch	
R	Tolerance
≤ 1/16	+ .001/- .001
>1/16 - 1/8	+ .002/- .002
>1/8	+ .003/- .003

Metric (mm)	
R	Tolerance
≤ 1.5	+ .025/- .025
1.6 - 3.0	+ .050/- .050
>3.0	+ .075/- .075

Series 150 coated tools on page 294.



Series 150 Continued

Tool No.	EDP	Diameter			Shank		OAL		Flute Length	
		D1			D2		L1		L2	
		Inch	mm	Decimal	Inch	mm	Inch	mm	Inch	mm
15007870	15013		2.0	.0787		3		38		9.0
15007871	15070		2.0	.0787		3		38		6.0
15008000	15028			.0800	1/8		1-1/2		.240	
15008500	15030			.0850	1/8		1-1/2		.255	
15009000	15032			.0900	1/8		1-1/2		.270	
15009370	15015	3/32		.0937	1/8		1-1/2		9/32	
15009500	15034			.0950	1/8		1-1/2		.285	
15009840	15017		2.5	.0984		3		38		12.0
15010010	15036			.1000	1/8		1-1/2		.300	
15010930	15021	7/64		.1093	1/8		1-1/2		3/8	
15011810	15023		3.0	.1181		3		38		12.0
15012500	15025	1/8		.1250	1/8		1-1/2		3/8	
15013780	15027		3.5	.1378		4		51		12.0
15015620	15029	5/32		.1562	3/16		2		1/2	
15015750	15031		4.0	.1575		4		51		14.0
15017720	15033		4.5	.1772		5		51		14.0
15018750	15035	3/16		.1875	3/16		2		5/8	
15019680	15037		5.0	.1968		5		51		20.0
15021650	15039		5.5	.2165		6		64		20.0
15021870	15041	7/32		.2187	1/4		2-1/2		5/8	
15023620	15043		6.0	.2362		6		64		20.0
15025000	15045	1/4		.2500	1/4		2-1/2		3/4	
15027560	15047		7.0	.2756		8		64		20.0
15028120	15049	9/32		.2812	5/16		2-1/2		3/4	
15031250	15051	5/16		.3125	5/16		2-1/2		13/16	
15031500	15053		8.0	.3150		8		64		20.0
15035430	15055		9.0	.3543		9		64		20.0
15037500	15057	3/8		.3750	3/8		2-1/2		1	
15039370	15059		10.0	.3937		10		70		25.0
15043310	15061		11.0	.4331		11		70		25.0
15043750	15063	7/16		.4375	7/16		2-3/4		1	
15047240	15065		12.0	.4724		12		76		25.0
15050000	15067	1/2		.5000	1/2		3		1	
15055120	15069		14.0	.5512		14		89		30.0
15056250	15071	9/16		.5625	9/16		3-1/2		1-1/8	
15062500	15073	5/8		.6250	5/8		3-1/2		1-1/4	
15062990	15075		16.0	.6299		16		89		30.0
15068750	15077	11/16		.6875	3/4		4		1-3/8	
15070870	15079		18.0	.7087		18		102		35.0
15075000	15081	3/4		.7500	3/4		4		1-1/2	
15078740	15083		20.0	.7874		20		102		38.0
15086620	15085		22.0	.8662		22		102		40.0
15087500	15087	7/8		.8750	7/8		4		1-1/2	
15098430	15089		25.0	.9843		25		102		40.0
15010000	15019	1		1.0000	1		4		1-1/2	

Series 150 coated tools
on page 294.



2
Flute
Ball

NEW
Sizes

**TuffCut® GP
Series 150 Coated**

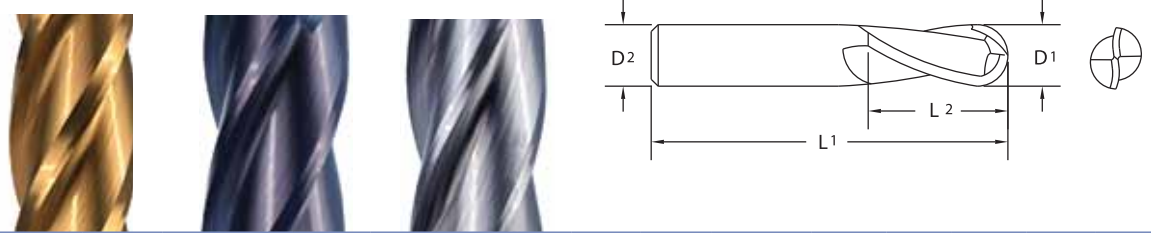

TiN		ALtima®		TiCN		Diameter			Shank		OAL		Flute Length	
Tool No.	EDP	Tool No.	EDP	Tool No.	EDP	D1			D2		L1		L2	
						Inch	mm	Decimal	Inch	mm	Inch	mm	Inch	mm
		15003940A	15050				1.0	.0394		3.0		38		3.0
		15005910A	15080				1.5	.0591		3.0		38		6.0
		15007870A	15082				2.0	.0787		3.0		38		9.0
		15009840A	15084				2.5	.0984		3.0		38		12.0
15011810T	55076	15011810A	55040	15011810C	55058		3.0	.1181		3.0		38		12.0
15012500T	55077	15012500A	55041	15012500C	55059	1/8		.1250	1/8		1-1/2		3/8	
15015750T	55078	15015750A	55042	15015750C	55060		4.0	.1575		4.0		51		14.0
15018750T	55079	15018750A	55043	15018750C	55061	3/16		.1875	3/16		2		5/8	
15019680T	55080	15019680A	55044	15019680C	55062		5.0	.1968		5.0		51		20.0
15023620T	55081	15023620A	55045	15023620C	55063		6.0	.2362		6.0		64		20.0
15025000T	55082	15025000A	55046	15025000C	55064	1/4		.2500	1/4		2-1/2		3/4	
15031250T	55083	15031250A	55047	15031250C	55065	5/16		.3125	5/16		2-1/2		13/16	
15031500T	55084	15031500A	55048	15031500C	55066		8.0	.3150		8.0		64		20.0
15037500T	55085	15037500A	55049	15037500C	55067	3/8		.3750	3/8		2-1/2		1	
15039370T	55086	15039370A	55050	15039370C	55068		10.0	.3937		10.0		70		25.0
15043750T	55087	15043750A	55051	15043750C	55069	7/16		.4375	7/16		2-3/4		1	
15047240T	55088	15047240A	55052	15047240C	55070		12.0	.4724		12.0		76		25.0
15050000T	55089	15050000A	55053	15050000C	55071	1/2		.5000	1/2		3		1	
15062500T	55090	15062500A	55054	15062500C	55072	5/8		.6250	5/8		3-1/2		1-1/4	
15062990T	55091	15062990A	55055	15062990C	55073		16.0	.6299		16.0		89		30.0
15075000T	55092	15075000A	55056	15075000C	55074	3/4		.7500	3/4		4		1-1/2	
15078740T	55093	15078740A	55057	15078740C	55075		20.0	.7874		20.0		102		38.0
15098430T	55097	15098430A	55098	15098430C	55099		25.0	.9843		25.0		102		40.0
15010000T	55094	15010000A	55095	15010000C	55096	1		1.0000	1		4		1-1/2	

Series 150 uncoated tools on page 292.



TuffCut® GP Series 166

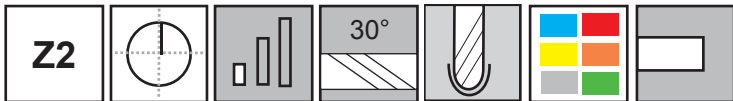

Manufactured with a full ball radius end. Designed for milling fillets or similar rounded corners in the bottom of a cut. Ideal for most ferrous metal applications.

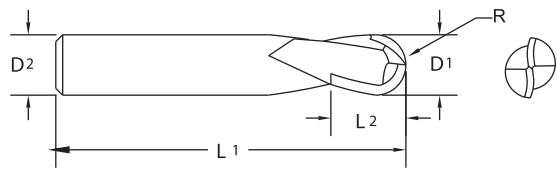

Tool No.	EDP	Diameter			Shank		OAL		Flute Length	
		D1			D2		L1		L2	
		Inch	mm	Decimal	Inch	mm	Inch	mm	Inch	mm
16601560	16600	1/64		.0156	1/8		1-1/2		.023	
16603120	16601	1/32		.0312	1/8		1-1/2		1/16	
16603940	16603		1.0	.0394		3.0		38		2.0
16604680	16605	3/64		.0468	1/8		1-1/2		3/32	
16605910	16607		1.5	.0591		3.0		38		3.0
16606250	16609	1/16		.0625	1/8		1-1/2		1/8	
16607810	16610	5/64		.0781	1/8		1-1/2		5/32	
16607870	16611		2.0	.0787		3.0		38		4.0
16609370	16613	3/32		.0937	1/8		1-1/2		3/16	
16609840	16615		2.5	.0984		3.0		38		5.0
16610930	16616	7/64		.1093	1/8		1-1/2		7/32	
16611810	16617		3.0	.1181		3.0		38		6.0
16612500	16619	1/8		.1250	1/8		1-1/2		1/4	
16613780	16621		3.5	.1378		4.0		51		7.0
16614060	16622	9/64		.1406	3/16		2		5/16	
16615620	16623	5/32		.1562	3/16		2		5/16	
16615750	16625		4.0	.1575		4.0		51		8.0
16617180	16626	11/64		.1718	3/16		2		3/8	
16617720	16627		4.5	.1772		5.0		51		9.0
16618750	16629	3/16		.1875	3/16		2		3/8	
16619680	16631		5.0	.1968		5.0		51		11.0
16620310	16632	13/64		.2031	1/4		2		1/2	
16621650	16633		5.5	.2165		6.0		51		12.0
16621870	16635	7/32		.2187	1/4		2		1/2	
16623430	16636	15/64		.2343	1/4		2		1/2	
16623620	16637		6.0	.2362		6.0		51		13.0
16625000	16639	1/4		.2500	1/4		2		1/2	
16627560	16641		7.0	.2756		8.0		51		13.0
16628120	16642	9/32		.2812	5/16		2		1/2	
16631250	16643	5/16		.3125	5/16		2		1/2	
16631500	16645		8.0	.3150		8.0		51		13.0
16635430	16647		9.0	.3543		9.0		51		14.0
16637500	16649	3/8		.3750	3/8		2		5/8	
16639370	16651		10.0	.3937		10.0		51		14.0
16643310	16653		11.0	.4331		11.0		64		16.0
16643750	16655	7/16		.4375	7/16		2-1/2		5/8	

Inch	
D1	Tolerance
1/64	+ .000/- .001
1/32 - 1/4	+ .000/- .002
> 1/4 - 3/4	+ .000/- .003

Metric (mm)	
D1	Tolerance h10
1.00 - 3.00	+ .000/- .040
> 3.00 - 6.00	+ .000/- .048
> 6.00 - 10.00	+ .000/- .058
> 10.00 - 18.00	+ .000/- .070
> 18.00 - 20.00	+ .000/- .084

Inch	
R	Tolerance
≤ 1/16	+ .001/- .001
> 1/16 - 1/8	+ .002/- .002
> 1/8	+ .003/- .003

Metric (mm)	
R	Tolerance
≤ 1.5	+ .025/- .025
1.6 - 3.0	+ .050/- .050
> 3.0	+ .075/- .075

Series 166 coated tools on page 296.

2 Flute Ball

150 Coated / 166 TuffCut® GP

GENERAL PURPOSE



2
Flute
Ball

Series 166 Continued

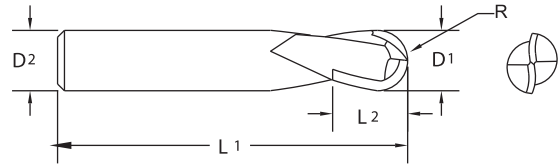
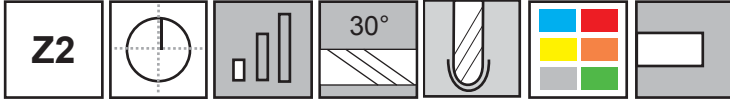

Tool No.	EDP	Diameter			Shank		OAL		Flute Length	
		D1			D2		L1		L2	
		Inch	mm	Decimal	Inch	mm	Inch	mm	Inch	mm
16647240	16657		12.0	.4724		12.0		64		16.0
16650000	16659	1/2		.5000	1/2		2-1/2		5/8	
16655120	16661		14.0	.5512		14.0		70		18.0
16662500	16663	5/8		.6250	5/8		3		3/4	
16662990	16665		16.0	.6299		16.0		76		20.0
16670870	16667		18.0	.7087		18.0		76		25.0
16675000	16669	3/4		.7500	3/4		3		1	
16678740	16671		20.0	.7874		20.0		76		25.0



2
Flute
Ball

TuffCut® GP Series 166 Coated

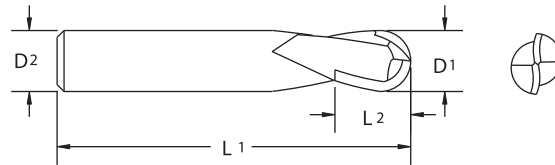

TiN		ALtima®		TiCN		Diameter			Shank		OAL		Flute Length	
						D1			D2		L1		L2	
Tool No.	EDP	Tool No.	EDP	Tool No.	EDP	Inch	mm	Decimal	Inch	mm	Inch	mm	Inch	mm
16611810T	56600	16611810A	56633	16611810C	56666		3.0	.1181		3.0		38		6.0
16612500T	56601	16612500A	56634	16612500C	56667	1/8		.1250	1/8		1-1/2		1/4	
16615750T	56605	16615750A	56638	16615750C	56671		4.0	.1575		4.0		51		8.0
16618750T	56608	16618750A	56641	16618750C	56674	3/16		.1875	3/16		2		3/8	
16619680T	56609	16619680A	56642	16619680C	56675		5.0	.1968		5.0		51		11.0
16623620T	56614	16623620A	56647	16623620C	56680		6.0	.2362		6.0		51		13.0
16625000T	56615	16625000A	56648	16625000C	56681	1/4		.2500	1/4		2		1/2	
16631250T	56618	16631250A	56651	16631250C	56684	5/16		.3125	5/16		2		1/2	
16631500T	56619	16631500A	56652	16631500C	56685		8.0	.3150		8.0		51		13.0
16637500T	56621	16637500A	56654	16637500C	56687	3/8		.3750	3/8		2		5/8	
16639370T	56622	16639370A	56655	16639370C	56688		10.0	.3937		10.0		51		14.0
16643750T	56624	16643750A	56657	16643750C	56690	7/16		.4375	7/16		2-1/2		5/8	
16647240T	56625	16647240A	56658	16647240C	56691		12.0	.4724		12.0		64		16.0
16650000T	56626	16650000A	56659	16650000C	56692	1/2		.5000	1/2		2-1/2		5/8	
16662500T	56628	16662500A	56661	16662500C	56694	5/8		.6250	5/8		3		3/4	
16662990T	56629	16662990A	56662	16662990C	56695		16.0	.6299		16.0		76		20.0
16675000T	56631	16675000A	56664	16675000C	56697	3/4		.7500	3/4		3		1	
16678740T	56632	16678740A	56665	16678740C	56698		20.0	.7874		20.0		76		25.0



Series 166 uncoated tools on page 295.

Where *high performance is the standard*[®]



Technical data provided should be considered advisory only as variations may be necessary depending on the particular application.

For product information, call your local distributor.

End Mill Icon Glossary



Number of Flutes



Workpiece Material Group

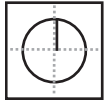

Center Cutting



Steels



Lengths



Stainless Steels

Coatings

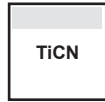

Cast Iron

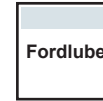

Special Alloys

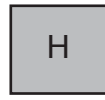

Hardened Steels
(35-65Rc)

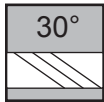

Helix Angle

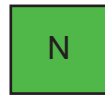

Non-Ferrous



Ball Nose

Coolant	Maximum
Max.	Coolant
Coolant	Minimal
MMS	Coolant

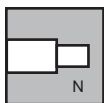

Neck Relief

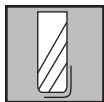

Corner Radius

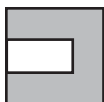

Shank

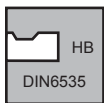

Shank/DIN

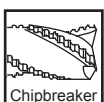

Chipbreaker

Cutting Calculations And Definitions		Metric	U.S.
ae	= Width of cut, radial depth of cut	(mm)	(inch)
ap	= Depth of cut, axial depth of cut	(mm)	(inch)
Dc	= Cutter diameter	(mm)	(inch)
f	= Feed per revolution	(mm/rev)	(IPR)
fz	= Feed per tooth	(mm/tooth)	(IPT)
zn	= Number of teeth	Number	
n	= RPM	(rev/min)	(rev/min)
Q	= Metal removal rate	(cm ³ /min)	(in ³ /min)
vc	= Cutting speed	(m/min)	(SFM)
vf	= Feed speed	(mm/min)	(IPM)
Dw	= Working diameter	(mm)	(inch)

Formulas

Inch

$$\text{RPM (n)} = \text{SFM (vc)} \times 3.82 / \text{Tool Diam.}$$

$$\text{IPM (vf)} = \text{RPM (n)} \times \text{IPR (f)}$$

Conversion Inch to Metric

$$\text{SFM (vc) to m/min (vc)} = \text{SFM (vc)} \times .3048$$

$$\text{IPM (vf) to mm/min (vf)} = \text{IPM (vf)} \times 25.4$$

Metric

$$\text{RPM (n)} = \text{m/min (vc)} \times 318.057 / \text{Tool Diam.}$$

$$\text{mm/min (vf)} = \text{RPM (n)} \times \text{mm/Revolution (f)}$$

Conversion Metric to Inch

$$\text{m/min (vc) to SFM (vc)} = (\text{m/min}) / .3048$$

$$\text{mm/min (vf) to IPM (vf)} = (\text{mm/min}) / 25.4$$



Safety Note

Always wear the appropriate personal protective equipment such as safety glasses and protective clothing when using solid carbide or HSS cutting tools. Machines should be fully guarded.

End Mill Troubleshooting

PROBLEM	POSSIBLE CAUSE	POSSIBLE SOLUTION
Excessive Flank Wear	Speed too high	Reduce the cutting speed RPM's (n).
	Improper feed speed (too slow)	Increase feed per tooth (fz).
	Hard workpiece material > 55 Rc	Try 90-100 SFM (vc) with multi-fluted tool (5 flutes+). Use ALtima® 52 hard coating.
	Recutting Chips	Change feed speed to change chip size or clear chips with coolant or air pressure.
	Milling Strategy	Ensure you are climb milling unless workpiece material has hard/abrasive outer skin or high impact tool steel like D2, then conventional milling technique is preferred for breakthrough. (see pg 302)
	Improper cutting angle	Change to correct cutting angle, tilt tool at 15 degrees.
	Too low a primary relief angle	Change to larger relief angle.
PROBLEM	POSSIBLE CAUSE	POSSIBLE SOLUTION
Excessive Corner Wear	No Corner Radius	Implementing corner radius on tool adds strength and increases tool life.
	Speed too high	Reduce the cutting speed RPM's (n).
	Tool Runout	Check tool runout in holder/spindle, <.0003" (.0076mm) desired. Hand ground flats can be suspect and common cause. Use collet, milling chuck, or shrink fit holders if possible.
	Tool Overhang	Ensure you are using shortest OAL possible, stub tool in holder. Utilize stronger necked tool for longer reaches.
PROBLEM	POSSIBLE CAUSE	POSSIBLE SOLUTION
Cutting Edge Chipping	Lack of rigidity (tool)	Use shortest end mill available, hold shank deeper in holder, investigate for tool slippage. Use short gage length holder.
	Lack of rigidity (workpiece)	Tighten workpiece fixture - a common problem.
	Feed too high	Decrease feed per tooth (fz)
	Feed too high on first pass	Decrease feed per tooth (fz) on first pass through workpiece skin or reduce radial width of cut (ae) first pass.
	Part Entry	Reduce FPT on entry - implement radius in or sweeping entrances - avoid 90° (perpendicular) entry.
	Milling Strategy	Ensure you are climb milling unless workpiece material has hard/abrasive outer skin or high impact tool steel like D2, then conventional milling technique is preferred for breakthrough. (see pg 302)
	Tool Overhang	Ensure you are using shortest OAL possible, stub tool in holder. Utilize stronger necked tool for longer reaches.
	Tool Runout	Check tool runout in holder/spindle, <.0003" (.0076mm) desired. Hand ground flats can be suspect and common cause. Use collet, milling chuck, or shrink fit holders if possible.
	Not enough rigidity of machine tool & holder	Change rigid machine tool or holder.
	Cutting Edge Prep	Ensure tool has proper edge prep for workpiece material.
	Teeth too sharp	Change to lower cutting angle, primary relief.

Technical data provided should be considered advisory only as variations may be necessary depending on the particular application.

[For product information, call your local distributor.](#)

End Mill Troubleshooting Continued

PROBLEM	POSSIBLE CAUSE	POSSIBLE SOLUTION
Breakage	Lack of rigidity (workpiece)	Tighten workpiece fixture - a common problem.
	Speed too low	Increase the cutting speed RPM's (n).
	Feed too high	Decrease feed per tooth (fz).
	Heavy depth of cut	Reduce width of cut, radial depth of cut (ae) & depth of cut, axial depth of cut (ap).
	Part Entry	Reduce FPT on entry - implement radius in or sweeping entrances - avoid 90° (perpendicular) entry.
	Milling Strategy	Review tool path and ensure there are no arbitrary moves, extreme arc of engagement increases & undesirable situations for the tool. Keep constant radial engagement. See tool path diagrams pg 302.
	Tool Overhang	Ensure you are using shortest OAL possible, stub tool in holder. Utilize stronger necked tool for longer reaches.
	Tool Runout	Check tool runout in holder/spindle, <.0003" (.0076mm) desired. Hand ground flats can be suspect and common cause. Use collet, milling chuck, or shrink fit holders if possible.
	Excessive edge wear	Recondition at earlier stage. Factory recondition service is recommended. See M.A. Ford's® Redbox reconditioning program on pg 470.
PROBLEM	POSSIBLE CAUSE	POSSIBLE SOLUTION
Built Up Edge (BUE)	Chip Welding to cutting edge	Utilize proper tool coating for workpiece material being cut. Climb mill preferred.
	Feed too low	Increase feed per tooth (fz).
	Speed too low	Increase the cutting speed RPM's (n).
	Coolant Strategy	Add coolant or readjust coolant flow, use through tool coolant if available. Check coolant mixture concentration.
PROBLEM	POSSIBLE CAUSE	POSSIBLE SOLUTION
Chip Packing	Insufficient chip room	Use end mill with fewer flutes.
	Feed too high	Decrease feed per tooth (fz).
	Heavy depth of cut	Reduce width of cut, radial depth of cut (ae) & depth of cut, axial depth of cut (ap).
	Not enough coolant	Apply more coolant to flush chips. Use air pressure or op. stop to clear chips away.
	Large heavy chip	Utilize chipbreaker style tool to cut chip size.
PROBLEM	POSSIBLE CAUSE	POSSIBLE SOLUTION
Poor Surface Finish	Feed too high	Decrease feed per tooth (fz).
	Speed too low	Increase the cutting speed RPM's (n).
	Too light width of cut	Increase width of cut, radial depth of cut (ae) to stabilize tool in cut.
	Tool Runout	Check tool runout in holder/spindle, <.0003" (.0076mm) desired. Hand ground flats can be suspect and common cause. Use collet, milling chuck, or shrink fit holders if possible.
	Built up Edge	Use Flood Coolant.
	Recutting Chips	Redirect/Evaluate coolant flush - or use fewer number of flutes.
	No end tooth concavity	Add margin (touch primary with oilstone).

Technical data provided should be considered advisory only as variations may be necessary depending on the particular application.

End Mill Troubleshooting Continued

PROBLEM	POSSIBLE CAUSE	POSSIBLE SOLUTION
Chatter/Vibration	Lack of rigidity (workpiece)	Tighten workpiece fixture - a common problem.
	Lack of rigidity (machine & holder)	Use better machine tool, holder or change condition. Ask your M.A. Ford® representative about BlueSwarf harmonic testing.
	Tool Runout	Check tool runout in holder/spindle, <.0003" (.0076mm) desired. Hand ground flats can be suspect and common cause. Use collet, milling chuck, or shrink fit holders if possible.
	Speed too high	Reduce the cutting speed RPM's (n).
	Feed too low	Increase feed per tooth (fz).
	Chip too thin	Utilize chip thinning adjustment multiplier.
	Arc of engagement violation	Use smaller tools and generate corner radii in pockets. Avoid tools that diameter matches workpiece corner radius, or rough plunge corners.
	Milling Strategy	Ensure you are climb milling unless workpiece material has hard/abrasive outer skin or high impact tool steel like D2 then conventional milling technique is preferred for breakthrough.
PROBLEM	POSSIBLE CAUSE	POSSIBLE SOLUTION
Tool Deflection	Tool Overhang	Ensure you are using shortest OAL possible, stub tool in holder. Utilize stronger necked tool for longer reaches.
	End mill Diameter	Increase diameter of end mill for higher strength to length ratio.
	Increase number of flutes	Higher number of flutes = larger core diameter = increased strength.
	Feed too high	Decrease feed per tooth (fz).
	Too high width of cut	Decrease width of cut, radial depth of cut (ae).
	Milling Strategy	Climb milling can help reduce the amount of deflection in some cases.
PROBLEM	POSSIBLE CAUSE	POSSIBLE SOLUTION
No Dimensional Accuracy (Wall Tapered)	Coolant Strategy	Add coolant or readjust coolant flow, use through tool coolant if available. Check coolant mixture concentration.
	Tool Deflection	See Tool Deflection above.
	Feed too high	Decrease feed per tooth (fz).
	Too high width of cut	Decrease width of cut, radial depth of cut (ae).
	Tool Runout	Check tool runout in holder/spindle, <.0003" (.0076mm) desired. Hand ground flats can be suspect and common cause. Use collet, milling chuck, or shrink fit holders if possible.

Milling Strategy Comparison



Conventional Machining

- Reduced Axial Depths Of Cut (ap) - Normally 1 x Tool Diameter
- Higher Radial Depths Of Cut (ae) - Normally 0.5 x Tool Diameter
- Lower Spindle Speed RPM (n)
- Lower Feed Rate (vf) (inch/min or mm/min)
- Slower Machining Time
- Low Metal Removal Rate (Q - in³/min or cm³/min)

High Speed Machining (HSM)

- Increased Axial Depths Of Cut (ap) - up to 2 x Tool Diameter
- Reduced Radial Depths Of Cut (ae) - 0.1/0.2 x Tool Diameter
- Higher Spindle Speed RPM (n)
- Higher Feed Rate (vf) (inch/min or mm/min)
- Faster Machining Time
- High Metal Removal Rate (Q - in³/min or cm³/min)

Contact Your Local M.A. Ford®
Representative For More Information On The Right
Milling Strategy For Your Application.

Milling Strategy Comparison continued

Conventional

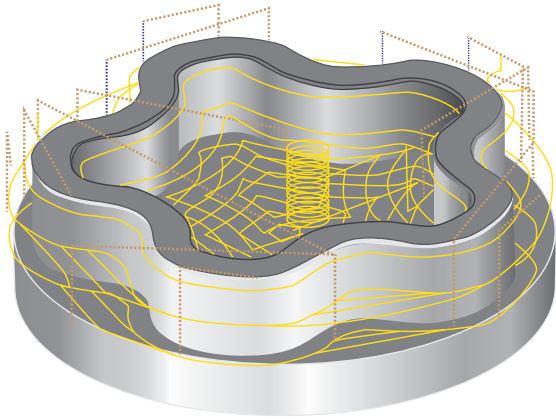

Tool Ø 12.0mm (.4724") 4 Flute

vc - 150m/min (5,905 in/min)

n - 3,975 RPM

fz - 0.06mm/z (.0024 in/z)

vf - 954mm/min (37.6 in/min)

ap - 2 x 12.0mm (.4724") 1xD

ae - 6.0mm (.2362") 0.5xD

Metal Removal Rate (MRR)

68.7 cm³/min (4.2 in³/min)

Machining Time

7 minutes 45 Seconds

High Speed

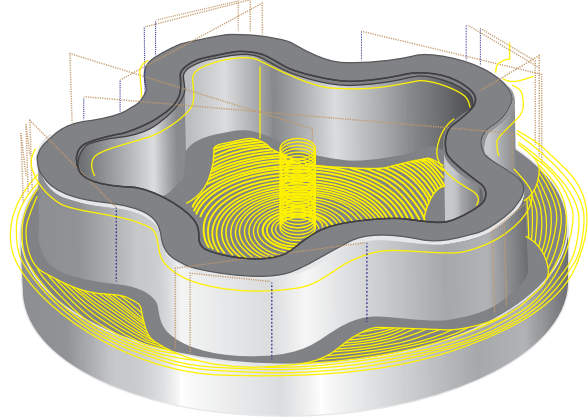

Tool Ø 12.0mm (.4724") 5 Flute

vc - 300m/min (11,811 in/min)

n - 8,000 RPM

fz - 0.15mm/z (.006 in/z)

vf - 6,000mm/min (240 in/min)

ap - 24.0mm (.945") 2xD

ae - 1.2mm (.047") 0.1xD

Metal Removal Rate (MRR)

172.8 cm³/min (10.5 in³/min)

Machining Time

3 minutes 35 Seconds

Contact Your Local M.A. Ford®
Representative For More Information On The Right
Milling Strategy For Your Application.

Radial Chip Thinning

During profile or side milling with a solid carbide end mill at 50% (a_e) radial width of cut, the chip formed is at full programmed thickness. When your radial depth of cut decreases to something less than 50%, the chip formed is not as thick. This is known as “radial chip thinning”. When less than 50% (a_e) radial depths are used, it becomes necessary to increase your feed to achieve full chip thickness. This means a higher programmed feed rate is needed to achieve the recommended chip thickness.

Programmers and Machinists have a tendency to lower feed rate due to previous experience. With the utilization of new programming methods, such as trochoidal and peel milling, manufacturers can increase productivity and tool life. These methods take advantage of much deeper (a_p) axial cuts with less (a_e) radial width of cut. With these methods, it’s possible to run higher surface footages (SFM or m/min) along with these higher feed rates (IPM or mm/min) because less heat is generated at the cutting zone. Plus, you’re utilizing chip thinning.

With the introduction of M.A. Ford®’s variable pitch tools, harmonics have virtually been eliminated, thus easing Programmers and Machinists fears of previous experiences. Advancements in our hard coatings enable our tools to withstand 900 degrees F, thus eliminating heat concerns. In addition, machine tools have advanced greatly to take advantage of these new methods. Use the following chart as a reference to increase feed rates by multiplying recommended feed rate by the increase feed factor, according to your (a_e) radial depth of cut as % of (D_c) cutter diameter.

(a_e) Radial Depth of Cut as to % of (D_c) Cutter Diameter	Increase Feed Factor
30%	1.10
25%	1.20
20%	1.20
15%	1.41
10%	1.80
7%	2.00
5%	2.30
3%	2.93
2%	3.60
1%	5.00

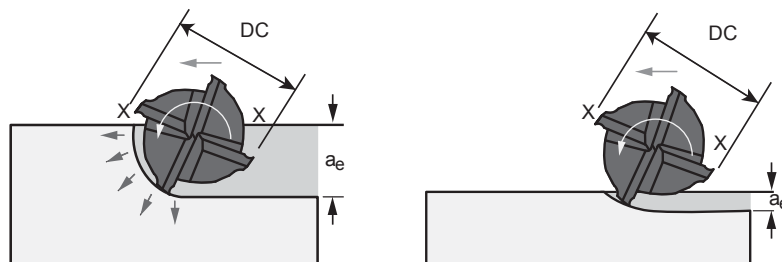

Technical data provided should be considered advisory only as variations may be necessary depending on the particular application.

Tool Engagement Angle

Sometimes referred to as “Arc of Engagement”, this is the degrees of engagement the end mill will contact the part during cut depths in the radial direction. Ideally you would like to engage the end mill at a constant engagement angle of 30-40 degrees. At this degree of engagement the tool will perform best because of acceptable loading while not exceeding deflection limits.

As the tool travels around the geometrical shape of the part features, it will encounter areas where it could exceed the acceptable engagement angle. Software manufacturers have created methods to calculate algorithms to avoid these situations. One such case would be the entry into a pocket corner. At 50% radial depth of cut (ae), the cutter runs along the pocket side with a tool engagement angle of 90 degrees. As it enters the corner, it can quickly jump to 180 degrees as shown in the example below.

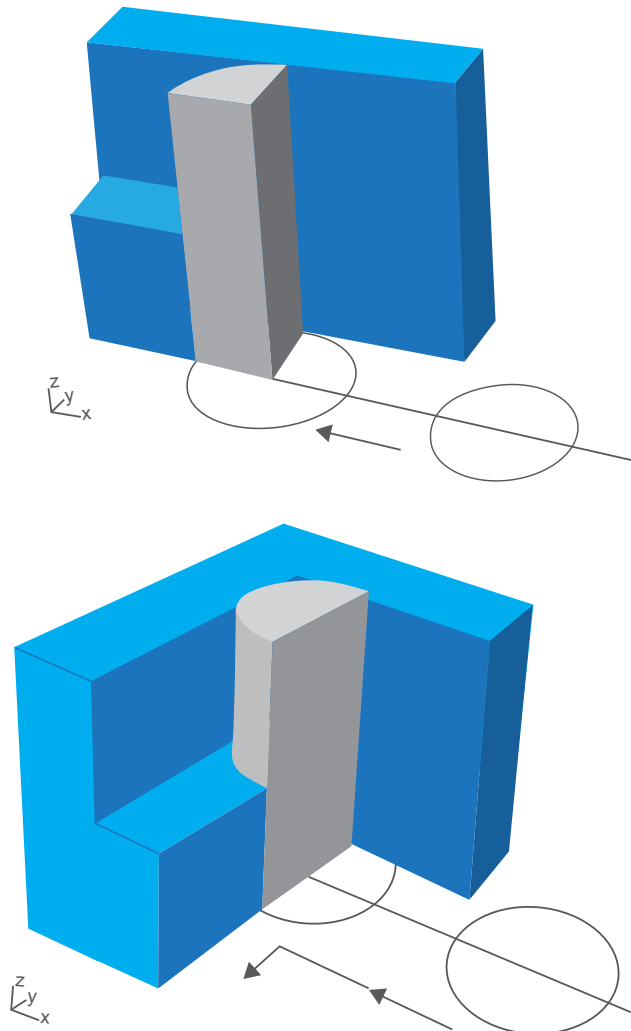

At this intersection, large engagement would cause tool chatter and even breakage. Using CAD CAM software to generate the corner avoids an abrupt stop and change of direction. It also keeps a constant arc of engagement while providing smooth chatter free cutting and long tool life.

Deflection

During the machining process, high cutting forces are directed on the end mill causing it to deflect. How much the end mill deflects depends on cutting parameters, tool diameter, tool stick out, and the elasticity coefficient (PSI) of the cutting tool material. The cutting tool strength will vary from different suppliers. At M.A. Ford®, we use only raw material of the highest quality and strength.

During roughing, deflection can be slightly higher than finishing. Deflection may be tolerable when roughing because at some point you will come back and finish cut your part. On larger carbide tools, deflection less than .001" (.025mm) is acceptable. However, on small micro end mills, deflection of less than .0005" (.0127mm) is acceptable.

Depending whether you are conventional milling or climb milling, deflection will be in different directions. With climb milling, deflection is in the direct opposite of the cut, but with conventional milling its direction is more parallel with the cut. This difference in direction will impart a different pattern finish on the wall of the workpiece. In climb milling, the tool engagement lines are more vertical and distinct. With conventional milling, your chip starts out thin and then gets thicker as your end mill continues through the cut; tool engagement lines are not as distinctly vertical.

M.A. Ford® has designed computer software to perform the many calculations required to determine tool deflection. All M.A. Ford® tools carry a Lot Number which can be traced back to that tool's DNA. With this information, we can plug the exact carbide TRS number into our software. How does this benefit you? We can increase cutting parameters to the point of maximum deflection, thus optimizing your operation parameters.

Please contact M.A. Ford®'s Tech Line (1-800-553-8024 or maftech@maford.com) with your tooling application questions.

ISO 9001:2008 Certified



Pocket Corners

Inside or pocket corners present a different challenge in two ways. First, if the corner radius is proportionally smaller than the related pocket size, it is necessary to use a much smaller diameter end mill to achieve the necessary radius. With a small diameter end mill there are restrictions from a cut depth standpoint; a small end mill will deflect when axial depth of cut (a_p) exceeds the end mills limits and breakage can occur.

Secondly, to rough the pocket the programmer may use a much larger end mill to remove large amounts of stock. If you plow into the rough corner with the small end mill, your tool engagement angle can cause the small end mill to deflect and chip or break. To avoid these problems, you must use one of two methods: peck milling or rest milling. Software packages again ease this procedure by maintaining low tool engagement angle.

Peck milling is a series of axial plunge moves to remove much of the stock remaining in the corner. Plunging directs forces axially on the machine spindle, thus eliminating radial force and deflection. This is particularly beneficial for light duty machines.

Rest milling is a series of circular moves while traveling in the Z direction, very similar to helical milling. This removes the remaining stock much like trochoidal milling but with the addition of Z movements.

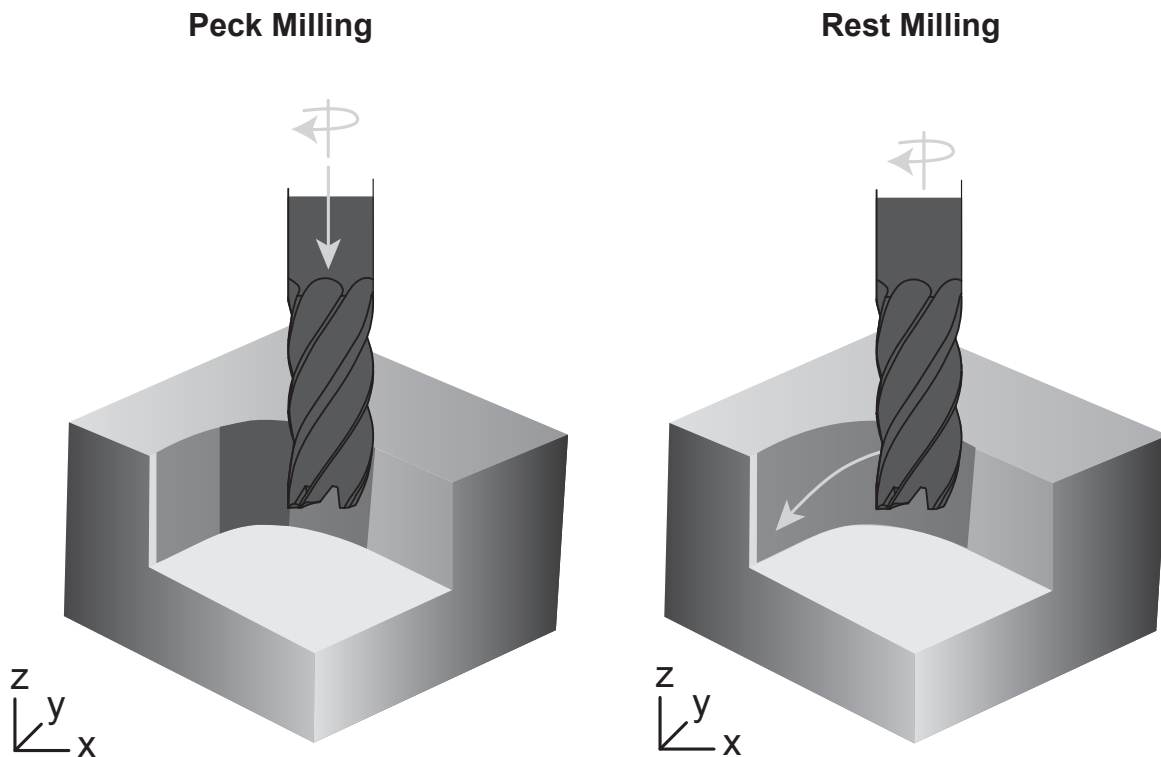

277 / 277N / 277W Recommended Cutting Data - Profile Milling Inch

Workpiece Material Group	ISO	Hardness	Coolant ● Preferred ○ Possible x Not Possible			Profiling (ae)				End Mill Diameter								
										1/8*	3/16*	1/4*	5/16	3/8	1/2	5/8	3/4	1
			5%	10%	25%	50%	*Profile milling at ≥ 50% ap is not recommended for diameters 1/4" and below.											
			2.3	1.8	1.2	1.0	← Multiply fz by this Factor based on ae. When finishing, use the standard fz per chart below. Only add chip thinning when roughing or semi-finishing.											
			vc - SFM				fz - in/tooth											
Low Carbon Steels 1018, 1020	P	up to 28 Rc	●	●	●	1475	1150	980	500	.0012	.0020	.0024	.0031	.0039	.0047	.0060	.0078	.0100
Medium Carbon Steels 1140, 1145	P	28 to 38 Rc	●	●	●	1130	900	840	250	.0012	.0020	.0024	.0031	.0039	.0047	.0060	.0078	.0100
Alloy Steels 4140, 4145	P	28 to 44 Rc	●	●	●	1035	840	765	250	.0012	.0020	.0024	.0031	.0039	.0047	.0060	.0078	.0100
Die / Tool Steels A2, D2, H13, P20	P	28 to 44 Rc	●	●	●	900	725	615	200	.0012	.0020	.0024	.0031	.0039	.0047	.0060	.0078	.0100
Hardened Steels A2, D2	H	45 to 50 Rc	●	○	○	610	495	325	250	.0006	0.001	.0012	.0016	.0020	.0024	.0030	.0040	.0050
Hardened Steels A2, D2	H	50 to 55 Rc	●	○	○	510	410	280	200	.0003	.0005	.0006	.0008	.0010	.0012	.0016	.0020	.0024
Stainless Steel - Easy to Machine 430F, 301, 303, 410, 416 Annealed, 420F, 430	M	up to 28 Rc	●	x	○	675	545	425	360	.0012	.0020	.0024	.0031	.0039	.0047	.0060	.0078	.0100
Stainless Steel - Austenitic 301, 302, 303 High Tensile, 304, 304L, 305, 420, 15-5PH, 17-4PH, 17-7PH	M	up to 28 Rc	●	x	○	525	430	400	210	.0012	.0020	.0024	.0031	.0039	.0047	.0060	.0078	.0100
Stainless Steel - Difficult to Machine 302B, 304B, 309, 310, 316, 316B, 316L, 316Ti, 317, 317L, 321	M	up to 28 Rc	●	x	○	410	330	295	210	.0012	.0020	.0024	.0031	.0039	.0047	.0060	.0078	.0100
Stainless Steel - Difficult to Machine 17-4 PH, PH13-8Mo, Nitronics	M	over 28 Rc	●	x	○	525	430	395	110	.0006	.0010	.0012	.0016	.0020	.0024	.0030	.0040	.0050
Cobalt Chrome Alloys	M	over 28 Rc	●	x	○	410	325	295	130	.0006	.0010	.0012	.0016	.0020	.0024	.0030	.0040	.0050
Duplex (22%)	M	over 28 Rc	●	x	○	245	195	180	130	.0006	.0010	.0012	.0016	.0020	.0024	.0030	.0040	.0050
Super Duplex (25%)	M	over 28 Rc	●	x	○	245	195	180	110	.0006	.0010	.0012	.0016	.0020	.0024	.0030	.0040	.0050
High Temp Alloys	S	up to 42 Rc	●	x	x	180	150	130	85	.0003	.0005	.0006	.0008	.0010	.0012	.0016	.0020	.0024
Inconel	S	up to 42 Rc	●	x	x	180	150	130	85	.0003	.0005	.0006	.0008	.0010	.0012	.0016	.0020	.0024
Titanium Alloys 6Al-4V, 5Al-2.5 Sn, 6Al-2 Sn-4Zr-6Mo, 3Al-8V-6Cr4Mo-4Zr, 10V-2Fe-3Al, 13V-11Cr-3Al	S	up to 42 Rc	●	x	x	525	425	330	175	.0003	.0005	.0006	.0008	.0010	.0012	.0016	.0020	.0024
Cast Iron - Gray CG, ASTM A48, CLASS 20, 25, 30, 35, SAE J431C, GRADES G1800, G3000, G3500, GG 10, 15, 20, 25, 30, 35, 40	K	up to 240 HB	●	○	○	1625	1295	870	350	.0012	.0020	.0024	.0031	.0039	.0047	.0060	.0078	.0100
Cast Iron - Ductile & Malleable CGI 60-40-18, 65-45-12, D4018, D4512, D5506, 32510, 35108, M3210, M4504, M5503, 250, 300, 350, 400, 450	K	over 240 HB	●	○	○	675	540	510	260	.0012	.0020	.0024	.0031	.0039	.0047	.0060	.0078	.0100

**Spindle Maximum - Should the calculated spindle speed be more than your actual spindle maximum, use this formula:
(Calculated Feed x Spindle Maximum)/Calculated Speed**

Technical data provided should be considered advisory only as variations may be necessary depending on the particular application.

TuffCut® XT

277 / 277N / 277W Recommended Cutting Data - Profile Milling Metric







Workpiece Material Group	ISO	Hardness	Coolant				Profiling (ae)				End Mill Diameter (mm)							
			• Preferred o Possible x Not Possible							3*	5*	6*	8	10	12	16	20	
						2.3	1.8	1.2	1.0	*Profile milling at ≥ 50% ap is not recommended for diameters 6mm and below.								
			Max.	Air	MMS	vc- m/min				← Multiply fz by this Factor based on ae. When finishing, use the standard fz per chart below. Only add chip thinning when roughing or semi-finishing.								
											fz - mm/tooth							
Low Carbon Steels 1018, 1020	P	up to 28 Rc	•	•	•	450	350	300	150	.0300	.0500	.0600	.0800	.1000	.1200	.1600	.2000	
Medium Carbon Steels 1140, 1145	P	28 to 38 Rc	•	•	•	345	275	255	75	.0300	.0500	.0600	.0800	.1000	.1200	.1600	.2000	
Alloy Steels 4140, 4145	P	28 to 44 Rc	•	•	•	315	255	230	75	.0300	.0500	.0600	.0800	.1000	.1200	.1600	.2000	
Die / Tool Steels A2, D2, H13, P20	P	28 to 44 Rc	•	•	•	275	220	187	60	.0300	.0500	.0600	.0800	.1000	.1200	.1600	.2000	
Hardened Steels A2, D2	H	45 to 50 Rc	•	o	o	185	150	100	75	.0150	.0250	.0300	.0400	.0500	.0600	.0800	.1000	
Hardened Steels A2, D2	H	50 to 55 Rc	•	o	o	155	125	85	60	.0070	.0120	.0150	.0200	.0250	.0300	.0400	.0500	
Stainless Steel - Easy to Machine 430F, 301, 303, 410, 416 Annealed, 420F, 430	M	up to 28 Rc	•	x	o	205	165	130	110	.0300	.0500	.0600	.0800	.1000	.1200	.1600	.2000	
Stainless Steel - Austenitic 301, 302, 303 High Tensile, 304, 304L, 305, 420, 15-5PH, 17-4PH, 17-7PH	M	up to 28 Rc	•	x	o	160	130	120	65	.0300	.0500	.0600	.0800	.1000	.1200	.1600	.2000	
Stainless Steel - Difficult to Machine 302B, 304B, 309, 310, 316, 316B, 316L, 316Ti, 317, 317L, 321	M	up to 28 Rc	•	x	o	125	100	90	65	.0300	.0500	.0600	.0800	.1000	.1200	.1600	.2000	
Stainless Steel - Difficult to Machine 17-4 PH, PH13-8Mo, Nitronics	M	over 28 Rc	•	x	o	160	130	120	35	.0150	.0250	.0300	.0400	.0500	.0600	.0800	.1000	
Cobalt Chrome Alloys	M	over 28 Rc	•	x	o	125	100	90	40	.0150	.0250	.0300	.0400	.0500	.0600	.0800	.1000	
Duplex (22%)	M	over 28 Rc	•	x	o	75	60	55	40	.0150	.0250	.0300	.0400	.0500	.0600	.0800	.1000	
Super Duplex (25%)	M	over 28 Rc	•	x	o	75	60	55	35	.0150	.0250	.0300	.0400	.0500	.0600	.0800	.1000	
High Temp Alloys	S	up to 42 Rc	•	x	x	55	45	40	25	.0070	.0120	.0150	.0200	.0250	.0300	.0400	.0500	
Inconel	S	up to 42 Rc	•	x	x	55	45	40	25	.0070	.0120	.0150	.0200	.0250	.0300	.0400	.0500	
Titanium Alloys 6Al-4V, 5Al-2.5 Sn, 6Al-2 Sn-4Zr-6Mo, 3Al-8V-6Cr4Mo-4Zr, 10V-2Fe-3Al, 13V-11Cr-3Al	S	up to 42 Rc	•	x	x	160	130	100	55	.0070	.0120	.0150	.0200	.0250	.0300	.0400	.0500	
Cast-Iron - Gray CG, ASTM A48, CLASS 20, 25, 30, 35, SAE J431C, GRADES G1800, G3000, G3500, GG 10, 15, 20, 25, 30, 35, 40	K	up to 240 HB	•	o	o	495	395	265	110	.0300	.0500	.0600	.0800	.1000	.1200	.1600	.2000	
Cast Iron - Ductile & Malleable CGI 60-40-18, 65-45-12, D4018, D4512, D5506, 32510, 35108, M3210, M4504, M5503, 250, 300, 350, 400, 450	K	over 240 HB	•	o	o	205	165	155	80	.0300	.0500	.0600	.0800	.1000	.1200	.1600	.2000	

Spindle Maximum - Should the calculated spindle speed be more than your actual spindle maximum, use this formula:
 (Calculated Feed x Spindle Maximum)/Calculated Speed

Technical data provided should be considered advisory only as variations may be necessary depending on the particular application.

For product information, call your local distributor.

277 / 277N / 277W Recommended Cutting Data - Slotting Inch

Workpiece Material Group	ISO	Hardness	Coolant			Slotting			End Mill Diameter								
			● Preferred ○ Possible x Not Possible						1/8*	3/16*	1/4*	5/16	3/8	1/2	5/8	3/4	1
						25%	50%	100%	*Slotting at > 25% ap is not recommended for diameters 1/4" and below.								
			Max.	Air	MMS	vc - SFM											
Low Carbon Steels 1018, 1020	P	up to 28 Rc	●	●	●	550	500	475	.0004	.0010	.0012	.0016	.0020	.0025	.0031	.0040	.0050
Medium Carbon Steels 1140, 1145	P	28 to 38 Rc	●	●	●	275	250	225	.0004	.0010	.0012	.0016	.0020	.0025	.0031	.0040	.0050
Alloy Steels 4140, 4145	P	28 to 44 Rc	●	●	●	275	250	225	.0004	.0010	.0012	.0016	.0020	.0025	.0031	.0040	.0050
Die / Tool Steels A2, D2, H13, P20	P	28 to 44 Rc	●	●	●	225	200	175	.0004	.0010	.0012	.0016	.0020	.0025	.0031	.0040	.0050
Hardened Steels A2, D2	H	45 to 50 Rc	●	○	○	275	250	225	.0003	.0005	.0006	.0008	.0010	.0012	.0016	.0020	.0024
Hardened Steels A2, D2	H	50 to 55 Rc	●	○	○	225	200	175	.0001	.0002	.0003	.0004	.0005	.0006	.0008	.0010	.0015
Stainless Steel - Easy to Machine 430F, 301, 303, 410, 416 Annealed, 420F, 430	M	up to 28 Rc	●	x	○	385	360	350	.0004	.0010	.0012	.0016	.0020	.0024	.0031	.0040	.0050
Stainless Steel - Austenitic 301, 302, 303 High Tensile, 304, 304L, 305, 420, 15-5PH, 17-4PH, 17-7PH	M	up to 28 Rc	●	x	○	225	210	200	.0004	.0010	.0012	.0016	.0020	.0024	.0031	.0040	.0050
Stainless Steel - Difficult to Machine 302B, 304B, 309, 310, 316, 316B, 316L, 316Ti, 317, 317L, 321	M	up to 28 Rc	●	x	○	225	210	200	.0004	.0010	.0012	.0016	.0020	.0024	.0031	.0040	.0050
Stainless Steel - Difficult to Machine 17-4 PH, PH13-8Mo, Nitronics	M	over 28 Rc	●	x	○	125	110	100	.0003	.0005	.0006	.0008	.0010	.0012	.0016	.0020	.0024
Cobalt Chrome Alloys	M	over 28 Rc	●	x	○	150	130	120	.0003	.0005	.0006	.0008	.0010	.0012	.0016	.0020	.0024
Duplex (22%)	M	over 28 Rc	●	x	○	150	130	120	.0003	.0005	.0006	.0008	.0010	.0012	.0016	.0020	.0024
Super Duplex (25%)	M	over 28 Rc	●	x	○	120	110	100	.0003	.0005	.0006	.0008	.0010	.0012	.0016	.0020	.0024
High Temp Alloys	S	up to 42 Rc	●	x	x	100	85	75	.0003	.0005	.0006	.0008	.0010	.0012	.0016	.0020	.0024
Inconel	S	up to 42 Rc	●	x	x	95	85	75	.0003	.0005	.0006	.0008	.0010	.0012	.0016	.0020	.0024
Titanium Alloys 6Al-4V, 5Al-2.5 Sn, 6Al-2 Sn-4Zr-6Mo, 3Al-8V-6Cr-4Mo-4Zr, 10V-2Fe-3Al, 13V-11Cr-3Al	S	up to 42 Rc	●	x	x	180	175	160	.0003	.0005	.0006	.0008	.0010	.0012	.0016	.0020	.0024
Cast Iron - Gray CG, ASTM A48, CLASS 20, 25, 30, 35, SAE J431C, GRADES G1800, G3000, G3500, GG 10, 15, 20, 25, 30, 35, 40	K	up to 240 HB	●	○	○	375	350	325	.0004	.0010	.0012	.0016	.0020	.0024	.0031	.0040	.0050
Cast Iron - Ductile & Malleable CGI 60-40-18, 65-45-12, D4018, D4512, D5506, 32510, 35108, M3210, M4504, M5503, 250, 300, 350, 400, 450	K	over 240 HB	●	○	○	275	260	250	.0004	.0010	.0012	.0016	.0020	.0024	.0031	.0040	.0050

**Spindle Maximum - Should the calculated spindle speed be more than your actual spindle maximum, use this formula:
(Calculated Feed x Spindle Maximum)/Calculated Speed**

TuffCut® XT

277 / 277N / 277W Recommended Cutting Data - Slotting Metric

Workpiece Material Group	ISO	Hardness	Coolant ● Preferred ○ Possible x Not Possible			Slotting			End Mill Diameter (mm)							
			Max.	Air	MMS	vc -m/min			3*	5*	6*	8	10	12	16	20
						25%	50%	100%	*Slotting at > 25% ap is not recommended for diameters 6mm and below.							
						fz - mm/tooth										
Low Carbon Steels 1018, 1020	P	up to 28 Rc	●	●	●	170	150	145	.0100	.0250	.0300	.0400	.0500	.0600	.0800	.1000
Medium Carbon Steels 1140, 1145	P	28 to 38 Rc	●	●	●	85	75	70	.0100	.0250	.0300	.0400	.0500	.0600	.0800	.1000
Alloy Steels 4140, 4145	P	28 to 44 Rc	●	●	●	85	75	70	.0100	.0250	.0300	.0400	.0500	.0600	.0800	.1000
Die / Tool Steels A2, D2, H13, P20	P	28 to 44 Rc	●	●	●	70	60	55	.0100	.0250	.0300	.0400	.0500	.0600	.0800	.1000
Hardened Steels A2, D2	H	45 to 50 Rc	●	○	○	85	75	70	.0070	.0120	.0150	.0200	.0250	.0300	.0400	.0500
Hardened Steels A2, D2	H	50 to 55 Rc	●	○	○	70	60	55	.0030	.0060	.0070	.0100	.0120	.0150	.0200	.0250
Stainless Steel - Easy to Machine 430F, 301, 303, 410, 416 Annealed, 420F, 430	M	up to 28 Rc	●	x	○	120	110	110	.0100	.0250	.0300	.0400	.0500	.0600	.0800	.1000
Stainless Steel - Austenitic 301, 302, 303 High Tensile, 304, 304L, 305, 420, 15-5PH, 17-4PH, 17-7PH	M	up to 28 Rc	●	x	○	70	65	60	.0100	.0250	.0300	.0400	.0500	.0600	.0800	.1000
Stainless Steel - Difficult to Machine 302B, 304B, 309, 310, 316, 316B, 316L, 316Ti, 317, 317L, 321	M	up to 28 Rc	●	x	○	70	65	60	.0100	.0250	.0300	.0400	.0500	.0600	.0800	.1000
Stainless Steel - Difficult to Machine 17-4 PH, PH13-8Mo, Nitronics	M	over 28 Rc	●	x	○	40	35	30	.0070	.0120	.0150	.0200	.0250	.0300	.0400	.0500
Cobalt Chrome Alloys	M	over 28 Rc	●	x	○	45	40	40	.0070	.0120	.0150	.0200	.0250	.0300	.0400	.0500
Duplex (22%)	M	over 28 Rc	●	x	○	45	40	40	.0070	.0120	.0150	.0200	.0250	.0300	.0400	.0500
Super Duplex (25%)	M	over 28 Rc	●	x	○	40	35	30	.0070	.0120	.0150	.0200	.0250	.0300	.0400	.0500
High Temp Alloys	S	up to 42 Rc	●	x	x	30	25	25	.0070	.0120	.0150	.0200	.0250	.0300	.0400	.0500
Inconel	S	up to 42 Rc	●	x	x	30	25	25	.0070	.0120	.0150	.0200	.0250	.0300	.0400	.0500
Titanium Alloys 6Al-4V, 5Al-2.5 Sn, 6Al-2 Sn-4Zr-6Mo, 3Al-8V-6Cr4Mo-4Zr, 10V-2Fe-3Al, 13V-11Cr-3Al	S	up to 42 Rc	●	x	x	55	55	50	.0070	.0120	.0150	.0200	.0250	.0300	.0400	.0500
Cast-Iron - Gray CG, ASTM A48, CLASS 20, 25, 30, 35, SAE J431C, GRADES G1800, G3000, G3500, GG 10, 15, 20, 25, 30, 35, 40	K	up to 240 HB	●	○	○	115	105	100	.0100	.0250	.0300	.0400	.0500	.0600	.0800	.1000
Cast Iron - Ductile & Malleable CGI 60-40-18, 65-45-12, D4018, D4512, D5506, 32510, 35108, M3210, M4504, M5503, 250, 300, 350, 400, 450	K	over 240 HB	●	○	○	85	80	75	.0100	.0250	.0300	.0400	.0500	.0600	.0800	.1000

Spindle Maximum - Should the calculated spindle speed be more than your actual spindle maximum, use this formula:

$$\text{(Calculated Feed x Spindle Maximum) / Calculated Speed}$$

Technical data provided should be considered advisory only as variations may be necessary depending on the particular application.

For product information, call your local distributor.

TuffCut® XT

278 / 278N / 278W Recommended Cutting Data - Profile Milling

Inch

Workpiece Material Group	ISO	Hardness	Coolant ● Preferred ○ Possible x Not Possible			Profiling (ae)				End Mill Diameter								
										1/8*	3/16*	1/4*	5/16	3/8	1/2	5/8	3/4	1
						5%	10%	25%	50%	*Profile Milling at ≥ 50% ap is not recommended for diameters 1/4" and below. ← Multiply fz by this Factor based on ae. When finishing, use the standard fz per chart below. Only add chip thinning when roughing or semi-finishing.								
						2.3	1.8	1.2	1.0									
						Max.	Air	MMS	vc - SFM				fz - in/tooth					
Low Carbon Steels 1018, 1020	P	up to 28 Rc	●	●	●	1475	1150	980	500	.0012	.0020	.0024	.0031	.0039	.0047	.0060	.0078	.0100
Medium Carbon Steels 1140, 1145	P	28 to 38 Rc	●	●	●	1130	900	830	250	.0012	.0020	.0024	.0031	.0039	.0047	.0060	.0078	.0100
Alloy Steels 4140, 4145	P	28 to 44 Rc	●	●	●	1035	840	755	250	.0012	.0020	.0024	.0031	.0039	.0047	.0060	.0078	.0100
Die / Tool Steels A2, D2, H13, P20	P	28 to 44 Rc	●	●	●	900	725	615	200	.0012	.0020	.0024	.0031	.0039	.0047	.0060	.0078	.0100
Hardened Steels A2, D2	H	45 to 50 Rc	●	○	○	610	495	325	250	.0006	.0010	.0012	.0016	.0020	.0024	.0030	.0040	.0050
Hardened Steels A2, D2	H	50 to 55 Rc	●	○	○	510	410	280	200	.0003	.0005	.0006	.0008	.0010	.0012	.0016	.0020	.0024
Stainless Steel - Easy to Machine 430F, 301, 303, 410, 416 Annealed, 420F, 430	M	up to 28 Rc	●	x	○	675	545	425	360	.0012	.0020	.0024	.0031	.0039	.0047	.0060	.0078	.0100
Stainless Steel - Austenitic 301, 302, 303 High Tensile, 304, 304L, 305, 420, 15-5PH, 17-4PH, 17-7PH	M	up to 28 Rc	●	x	○	525	430	400	210	.0012	.0020	.0024	.0031	.0039	.0047	.0060	.0078	.0100
Stainless Steel - Difficult to Machine 302B, 304B, 309, 310, 316, 316B, 316L, 316Ti, 317, 317L, 321	M	up to 28 Rc	●	x	○	410	330	295	210	.0012	.0020	.0024	.0031	.0039	.0047	.0060	.0078	.0100
Stainless Steel - Difficult to Machine 17-4 PH, PH13-8Mo, Nitronics	M	over 28 Rc	●	x	○	525	430	395	110	.0006	.0010	.0012	.0016	.0020	.0024	.0030	.0040	.0050
Cobalt Chrome Alloys	M		●	x	○	410	325	295	130	.0006	.0010	.0012	.0016	.0020	.0024	.0030	.0040	.0050
Duplex (22%)	M		●	x	○	245	195	180	130	.0006	.0010	.0012	.0016	.0020	.0024	.0030	.0040	.0050
Super Duplex (25%)	M		●	x	○	245	195	180	110	.0006	.0010	.0012	.0016	.0020	.0024	.0030	.0040	.0050
High Temp Alloys	S	up to 42 Rc	●	x	x	180	150	130	85	.0003	.0005	.0006	.0008	.0010	.0012	.0016	.0020	.0024
Inconel	S		●	x	x	180	150	130	85	.0003	.0005	.0006	.0008	.0010	.0012	.0016	.0020	.0024
Titanium Alloys 6Al-4V, 5Al-2.5 Sn, 6Al-2 Sn-4Zr-6Mo, 3Al-8V-6Cr-4Mo-4Zr, 10V-2Fe-3Al, 13V-11Cr-3Al	S	up to 42 Rc	●	x	x	525	425	330	175	.0003	.0005	.0006	.0008	.0010	.0012	.0016	.0020	.0024
Cast-Iron - Gray CG, ASTM A48, CLASS 20, 25, 30, 35, SAE J431C, GRADES G1800, G3000, G3500, GG 10, 15, 20, 25, 30, 35, 40	K	up to 240 HB	●	○	○	1625	1295	870	350	.0012	.0020	.0024	.0031	.0039	.0047	.0060	.0078	.0100
Cast Iron - Ductile & Malleable CGI 60-40-18, 65-45-12, D4018, D4512, D5506, 32510, 35108, M3210, M4504, M5503, 250, 300, 350, 400, 450	K	over 240 HB	●	○	○	675	540	510	260	.0012	.0020	.0024	.0031	.0039	.0047	.0060	.0078	.0100



Spindle Maximum - Should the calculated spindle speed be more than your actual spindle maximum, use this formula:
 (Calculated Feed x Spindle Maximum)/Calculated Speed

Technical data provided should be considered advisory only as variations may be necessary depending on the particular application.

TuffCut® XT

278 / 278N / 278W Recommended Cutting Data - Profile Milling

Metric

Workpiece Material Group	ISO	Hardness	Coolant • Preferred o Possible x Not Possible			Profiling (ae)				End Mill Diameter (mm)									
						5%		10%		25%		50%		3*	5*	6*	8	10	12
						2.3	1.8	1.2	1.0	*Profile Milling at ≥ 50% ap is not recommended for diameters 6mm and below.									
			Max.	Air	MMS	vc - m/min				← Multiply fz by this Factor based on ae. When finishing, use the standard fz per chart below. Only add chip thinning when roughing or semi-finishing.									
							fz - mm/tooth												
Low Carbon Steels 1018, 1020	P	up to 28 Rc	•	•	•	450	350	300	150	.0300	.0500	.0600	.0800	.1000	.1200	.1600	.2000	.2500	
Medium Carbon Steels 1140, 1145	P	28 to 38 Rc	•	•	•	345	275	255	75	.0300	.0500	.0600	.0800	.1000	.1200	.1600	.2000	.2500	
Alloy Steels 4140, 4145	P	28 to 44 Rc	•	•	•	315	255	230	75	.0300	.0500	.0600	.0800	.1000	.1200	.1600	.2000	.2500	
Die / Tool Steels A2, D2, H13, P20	P	28 to 44 Rc	•	•	•	275	220	185	60	.0300	.0500	.0600	.0800	.1000	.1200	.1600	.2000	.2500	
Hardened Steels A2, D2	H	45 to 50 Rc	•	o	o	185	150	100	75	.0150	.0250	.0300	.0400	.0500	.0600	.0800	.1000	.1250	
Hardened Steels A2, D2	H	50 to 55 Rc	•	o	o	155	125	85	60	.0070	.0120	.0150	.0200	.0250	.0300	.0400	.0500	.0620	
Stainless Steel - Easy to Machine 430F, 301, 303, 410, 416 Annealed, 420F, 430	M	up to 28 Rc	•	x	o	205	165	130	110	.0300	.0500	.0600	.0800	.1000	.1200	.1600	.2000	.2500	
Stainless Steel - Austenitic 301, 302, 303 High Tensile, 304, 304L, 305, 420, 15-5PH, 17-4PH, 17-7PH	M	up to 28 Rc	•	x	o	160	130	120	65	.0300	.0500	.0600	.0800	.1000	.1200	.1600	.2000	.2500	
Stainless Steel - Difficult to Machine 302B, 304B, 309, 310, 316, 316B, 316L, 316Ti, 317, 317L, 321	M	up to 28 Rc	•	x	o	125	100	90	65	.0300	.0500	.0600	.0800	.1000	.1200	.1600	.2000	.2500	
Stainless Steel - Difficult to Machine 17-4 PH, PH13-8Mo, Nitronics	M	over 28 Rc	•	x	o	160	130	120	35	.0150	.0250	.0300	.0400	.0500	.0600	.0800	.1000	.1250	
Cobalt Chrome Alloys	M		•	x	o	125	100	90	40	.0150	.0250	.0300	.0400	.0500	.0600	.0800	.1000	.1250	
Duplex (22%)	M		•	x	o	75	60	55	40	.0150	.0250	.0300	.0400	.0500	.0600	.0800	.1000	.1250	
Super Duplex (25%)	M		•	x	o	75	60	55	35	.0150	.0250	.0300	.0400	.0500	.0600	.0800	.1000	.1250	
High Temp Alloys	S	up to 42 Rc	•	x	x	55	45	40	25										
Inconel	S		•	x	x	55	45	40	25										
Titanium Alloys 6Al-4V, 5Al-2.5 Sn, 6Al-2 Sn-4Zr-6Mo, 3Al-8V-6Cr4Mo-4Zr, 10V-2Fe-3Al, 13V-11Cr-3Al	S	up to 42 Rc	•	x	x	160	130	100	55	.0070	.0120	.0150	.0200	.0250	.0300	.0400	.0500	.0620	
Cast-Iron - Gray CG, ASTM A48, CLASS 20, 25, 30, 35, SAE J431C, GRADES G1800, G3000, G3500, GG 10, 15, 20, 25, 30, 35, 40	K	up to 240 HB	•	o	o	495	395	265	110	.0300	.0500	.0600	.0800	.1000	.1200	.1600	.2000	.2500	
Cast Iron - Ductile & Malleable CGI 60-40-18, 65-45-12, D4018, D4512, D5506, 32510, 35108, M3210, M4504, M5503, 250, 300, 350, 400, 450	K	over 240 HB	•	o	o	205	165	155	80	.0300	.0500	.0600	.0800	.1000	.1200	.1600	.2000	.2500	







Spindle Maximum - Should the calculated spindle speed be more than your actual spindle maximum, use this formula:

$$\frac{\text{Calculated Feed} \times \text{Spindle Maximum}}{\text{Calculated Speed}}$$

Technical data provided should be considered advisory only as variations may be necessary depending on the particular application.

For product information, call your local distributor.

278 / 278N / 278W Recommended Cutting Data - Slotting Inch

Workpiece Material Group	ISO	Hardness	Coolant			Slotting			End Mill Diameter								
			● Preferred ○ Possible x Not Possible						1/8*	3/16*	1/4*	5/16	3/8	1/2	5/8	3/4	1
						25%	50%	100%	*Slotting at > 25% ap is not recommended for diameters 1/4" and below.								
			Max.	Air	MMS	vc - SFM											
Low Carbon Steels 1018, 1020	P	up to 28 Rc	•	•	•	550	500	475	.0004	.0010	.0012	.0016	.0020	.0025	.0031	.0040	.0050
Medium Carbon Steels 1140, 1145	P	28 to 38 Rc	•	•	•	275	250	225	.0004	.0010	.0012	.0016	.0020	.0025	.0031	.0040	.0050
Alloy Steels 4140, 4145	P	28 to 44 Rc	•	•	•	275	250	225	.0004	.0010	.0012	.0016	.0020	.0025	.0031	.0040	.0050
Die / Tool Steels A2, D2, H13, P20	P	28 to 44 Rc	•	•	•	225	200	175	.0004	.0010	.0012	.0016	.0020	.0025	.0031	.0040	.0050
Hardened Steels A2, D2	H	45 to 50 Rc	•	○	○	275	250	225	.0003	.0005	.0006	.0008	.0010	.0012	.0016	.0020	.0024
Hardened Steels A2, D2	H	50 to 55 Rc	•	○	○	225	200	175	.0001	.0002	.0003	.0004	.0005	.0006	.0008	.0010	.0015
Stainless Steel - Easy to Machine 430F, 301, 303, 410, 416 Annealed, 420F, 430	M	up to 28 Rc	•	x	○	385	360	350	.0002	.0004	.0008	.0012	.0014	.0018	.0022	.0026	.0038
Stainless Steel - Austenitic 301, 302, 303 High Tensile, 304, 304L, 305, 420, 15-5PH, 17-4PH, 17-7PH	M	up to 28 Rc	•	x	○	225	210	200	.0002	.0004	.0008	.0012	.0014	.0018	.0022	.0026	.0038
Stainless Steel - Difficult to Machine 302B, 304B, 309, 310, 316, 316B, 316L, 316Ti, 317, 317L, 321	M	up to 28 Rc	•	x	○	225	210	200	.0002	.0004	.0008	.0012	.0014	.0018	.0022	.0026	.0038
Stainless Steel - Difficult to Machine 17-4 PH, PH13-8Mo, Nitronics	M	over 28 Rc	•	x	○	125	110	100	.0003	.0005	.0006	.0008	.0010	.0012	.0016	.0020	.0024
Cobalt Chrome Alloys	M		•	x	○	150	130	120	.0003	.0005	.0006	.0008	.0010	.0012	.0016	.0020	.0024
Duplex (22%)	M		•	x	○	150	130	120	.0003	.0005	.0006	.0008	.0010	.0012	.0016	.0020	.0024
Super Duplex (25%)	M		•	x	○	120	110	100	.0003	.0005	.0006	.0008	.0010	.0012	.0016	.0020	.0024
High Temp Alloys	S	up to 42 Rc	•	x	x	100	85	75	.0003	.0005	.0006	.0008	.0010	.0012	.0016	.0020	.0024
Inconel	S		•	x	x	95	85	75	.0003	.0005	.0006	.0008	.0010	.0012	.0016	.0020	.0024
Titanium Alloys 6Al-4V, 5Al-2.5 Sn, 6Al-2 Sn-4Zr-6Mo, 3Al-8V-6Cr4Mo-4Zr, 10V-2Fe-3Al, 13V-11Cr-3Al	S	up to 42 Rc	•	x	x	180	175	160	.0003	.0005	.0006	.0008	.0010	.0012	.0016	.0020	.0024
Cast-Iron - Gray CG, ASTM A48, CLASS 20, 25, 30, 35, SAE J431C, GRADES G1800, G3000, G3500, GG 10, 15, 20, 25, 30, 35, 40	K	up to 240 HB	•	○	○	375	350	325	.0004	.0010	.0012	.0016	.0020	.0024	.0031	.0040	.0050
Cast Iron - Ductile & Malleable CGI 60-40-18, 65-45-12, D4018, D4512, D5506, 32510, 35108, M3210, M4504, M5503, 250, 300, 350, 400, 450	K	over 240 HB	•	○	○	275	260	250	.0004	.0010	.0012	.0016	.0020	.0024	.0031	.0040	.0050

Spindle Maximum - Should the calculated spindle speed be more than your actual spindle maximum, use this formula:

$$\text{Spindle Maximum} = \frac{\text{Calculated Feed} \times \text{Spindle Maximum}}{\text{Calculated Speed}}$$

278 / 278N / 278W Recommended Cutting Data - Slotting Metric

Workpiece Material Group	ISO	Hardness	Coolant			Slotting			End Mill Diameter (mm)								
			● Preferred ○ Possible x Not Possible						3*	5*	6*	8	10	12	16	20	25
						25%	50%	100%	*Slotting at > 25% ap is not recommended for diameters 6mm and below.								
			Max.	Air	MMS	vc - m/min			fz - mm/tooth								
Low Carbon Steels 1018, 1020	P	up to 28 Rc	●	●	●	170	150	145	.0100	.0250	.0300	.0400	.0500	.0600	.0800	.1000	.1250
Medium Carbon Steels 1140, 1145	P	28 to 38 Rc	●	●	●	85	75	70	.0100	.0250	.0300	.0400	.0500	.0600	.0800	.1000	.1250
Alloy Steels 4140, 4145	P	28 to 44 Rc	●	●	●	85	75	70	.0100	.0250	.0300	.0400	.0500	.0600	.0800	.1000	.1250
Die / Tool Steels A2, D2, H13, P20	P	28 to 44 Rc	●	●	●	70	60	55	.0100	.0250	.0300	.0400	.0500	.0600	.0800	.1000	.1250
Hardened Steels A2, D2	H	45 to 50 Rc	●	○	○	85	75	70	.0070	.0120	.0150	.0200	.0250	.0300	.0400	.0500	.0620
Hardened Steels A2, D2	H	50 to 55 Rc	●	○	○	70	60	55	.0030	.0060	.0070	.0100	.0120	.0150	.0200	.0250	.0370
Stainless Steel - Easy to Machine 430F, 301, 303, 410, 416 Annealed, 420F, 430	M	up to 28 Rc	●	x	○	120	110	110	.0100	.0250	.0300	.0400	.0500	.0600	.0800	.1000	.1250
Stainless Steel - Austenitic 301, 302, 303 High Tensile, 304, 304L, 305, 420, 15-5PH, 17-4PH, 17-7PH	M	up to 28 Rc	●	x	○	70	65	60	.0100	.0250	.0300	.0400	.0500	.0600	.0800	.1000	.1250
Stainless Steel - Difficult to Machine 302B, 304B, 309, 310, 316, 316B, 316L, 316Ti, 317, 317L, 321	M	up to 28 Rc	●	x	○	70	65	60	.0100	.0250	.0300	.0400	.0500	.0600	.0800	.1000	.1250
Stainless Steel - Difficult to Machine 17-4 PH, PH13-8Mo, Nitronics	M	over 28 Rc	●	x	○	40	35	30	.0070	.0120	.0150	.0200	.0250	.0300	.0400	.0500	.0620
Cobalt Chrome Alloys	M		●	x	○	45	40	40	.0070	.0120	.0150	.0200	.0250	.0300	.0400	.0500	.0620
Duplex (22%)	M		●	x	○	45	40	40	.0070	.0120	.0150	.0200	.0250	.0300	.0400	.0500	.0620
Super Duplex (25%)	M		●	x	○	40	35	30	.0070	.0120	.0150	.0200	.0250	.0300	.0400	.0500	.0620
High Temp Alloys	S	up to 42 Rc	●	x	x	30	25	25	.0070	.0120	.0150	.0200	.0250	.0300	.0400	.0500	.0620
Inconel	S	up to 42 Rc	●	x	x	30	25	25	.0070	.0120	.0150	.0200	.0250	.0300	.0400	.0500	.0620
Titanium Alloys 6Al-4V, 5Al-2.5 Sn, 6Al-2 Sn-4Zr-6Mo, 3Al-8V-6Cr4Mo-4Zr, 10V-2Fe-3Al, 13V-11Cr-3Al	S	up to 42 Rc	●	x	x	55	55	50	.0070	.0120	.0150	.0200	.0250	.0300	.0400	.0500	.0620
Cast-Iron - Gray CG, ASTM A48, CLASS 20, 25, 30, 35, SAE J431C, GRADES G1800, G3000, G3500, GG 10, 15, 20, 25, 30, 35, 40	K	up to 240 HB	●	○	○	115	105	100	.0100	.0250	.0300	.0400	.0500	.0600	.0800	.1000	.1250
Cast Iron - Ductile & Malleable CGI 60-40-18, 65-45-12, D4018, D4512, D5506, 32510, 35108, M3210, M4504, M5503, 250, 300, 350, 400, 450	K	over 240 HB	●	○	○	85	80	75	.0100	.0250	.0300	.0400	.0500	.0600	.0800	.1000	.1250

Spindle Maximum - Should the calculated spindle speed be more than your actual spindle maximum, use this formula:

$$\text{Spindle Maximum} = \frac{\text{Calculated Feed} \times \text{Spindle Maximum}}{\text{Calculated Speed}}$$

TuffCut® XT

279 Recommended Cutting Data - Contouring

Inch See pages 320-323 for profile milling and slotting data.

Semi Roughing / Roughing (25 - 48 Rc)						
Diameter	Decimal	Radius	Sfm	in/tooth Range	Max Ae	Max Ap
1/8	0.1250	0.063	820	.0008 - .0012	0.006	0.035
3/16	0.1875	0.094	1020	.0010 - .0017	0.009	0.053
1/4	0.2500	0.125	1235	.0010 - .0027	0.012	0.071
5/16	0.3125	0.156	1235	.0014 - .0032	0.016	0.094
3/8	0.3750	0.188	1235	.0018 - .0037	0.020	0.118
1/2	0.5000	0.250	1235	.0018 - .0040	0.024	0.142
5/8	0.6250	0.313	1235	.0020 - .0041	0.032	0.189
3/4	0.7500	0.375	1235	.0025 - .0045	0.038	0.225

Semi Finishing / Finishing (25 - 48 Rc)						
Diameter	Decimal	Radius	Sfm	in/tooth Range	Max Ae	Max Ap
1/8	0.125	0.063	820	.0008 - .0012	0.035	0.006
3/16	0.187	0.094	1020	.0010 - .0017	0.053	0.009
1/4	0.25	0.125	1235	.0010 - .0027	0.07	0.012
5/16	0.3125	0.156	1235	.0014 - .0032	0.094	0.016
3/8	0.375	0.188	1235	.0018 - .0037	0.118	0.02
1/2	0.5	0.25	1235	.0018 - .0040	0.141	0.024
5/8	0.625	0.312	1235	.0020 - .0041	0.188	0.031
3/4	0.75	0.375	1235	.0025 - .0045	0.225	0.0375

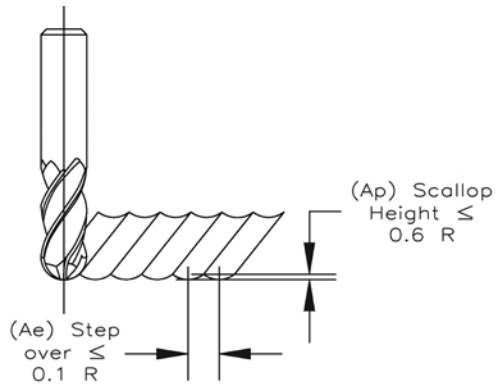

Coolant: High Pressure Air Blast

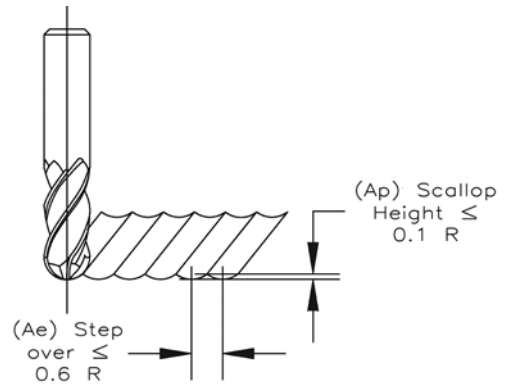

Coolant: High Pressure Air Blast

Titanium				
Diameter	Decimal	Radius	Sfm	In/tooth
1/8	0.125	0.063	500	0.0011
3/16	0.187	0.094	500	0.0015
1/4	0.25	0.125	500	0.0018
5/16	0.3125	0.156	500	0.0026
3/8	0.375	0.188	500	0.0031
1/2	0.5	0.25	500	0.0036
5/8	0.625	0.312	500	0.0039
3/4	0.75	0.375	500	0.0041

Titanium				
Diameter	Decimal	Radius	Sfm	In/tooth
1/8	0.125	0.063	150	0.0011
3/16	0.187	0.094	150	0.0015
1/4	0.25	0.125	150	0.0018
5/16	0.3125	0.156	150	0.0026
3/8	0.375	0.188	150	0.0031
1/2	0.5	0.25	150	0.0036
5/8	0.625	0.312	150	0.0039
3/4	0.75	0.375	150	0.0041

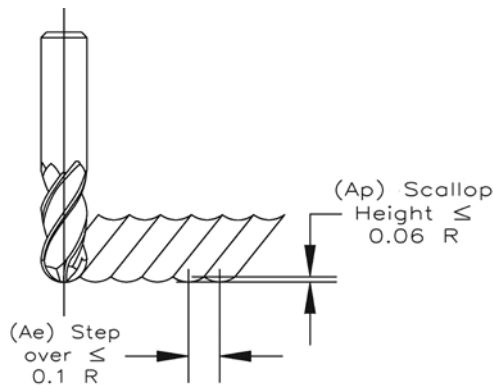

Coolant: High Pressure Air Blast

Technical data provided should be considered advisory only as variations may be necessary depending on the particular application.

TuffCut® XT

279 Recommended Cutting Data - Contouring

Metric See pages 320-323 for profile milling and slotting data.

Semi Roughing / Roughing (25 - 48 Rc)					
Diameter	Radius	meters/min	mm/tooth range	Max	Max
				Ae	Ap
3	1.5	250	.020 - .030	0.15	0.9
4	2	290	.025 - .040	0.2	1.2
5	2.5	315	.025 - .045	0.25	1.5
6	3	375	.025 - .065	0.3	1.8
8	4	375	.035 - .080	0.4	2.4
10	5	375	.045 - .090	0.5	3
12	6	375	.045 - .100	0.6	3.6
16	8	375	.050 - .105	0.8	4.8

Semi Finishing / Finishing (25 - 48 Rc)					
Diameter	Radius	meters/min	mm/tooth range	Max	Max
				Ae	Ap
3	1.5	250	.020 - .030	0.9	0.15
4	2	290	.025 - .040	1.2	0.2
5	2.5	315	.025 - .045	1.5	0.25
6	3	375	.025 - .065	1.8	0.3
8	4	375	.035 - .080	2.4	0.4
10	5	375	.045 - .090	3	0.5
12	6	375	.045 - .100	3.6	0.6
16	8	375	.050 - .105	4.8	0.8

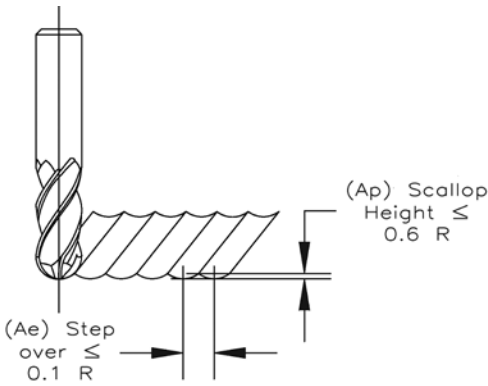

Coolant: High Pressure Air Blast

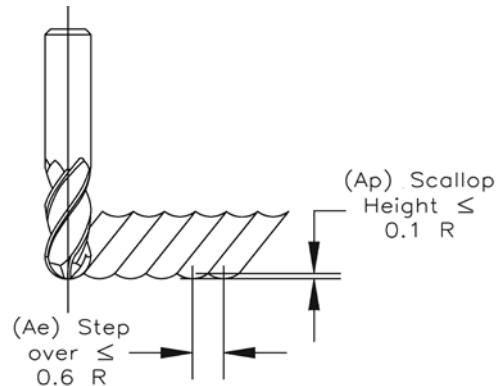

Coolant: High Pressure Air Blast

Titanium					
Diameter	Radius	meters/min	mm/tooth	Max	Max
				Ae	Ap
3	1.5	150	0.030	0.15	0.09
4	2	150	0.035	0.2	0.12
5	2.5	150	0.040	0.25	0.15
6	3	150	0.045	0.3	0.18
8	4	150	0.065	0.4	0.24
10	5	150	0.080	0.5	0.3
12	6	150	0.090	0.6	0.36
16	8	150	0.100	0.8	0.48

High Temp Alloys					
Diameter	Radius	meters/min	mm/tooth	Max	Max
				Ae	Ap
3	1.5	45	0.030	0.15	0.09
4	2	45	0.035	0.2	0.12
5	2.5	45	0.040	0.25	0.15
6	3	45	0.045	0.3	0.18
8	4	45	0.065	0.4	0.24
10	5	45	0.080	0.5	0.3
12	6	45	0.090	0.6	0.36
16	8	45	0.100	0.8	0.48

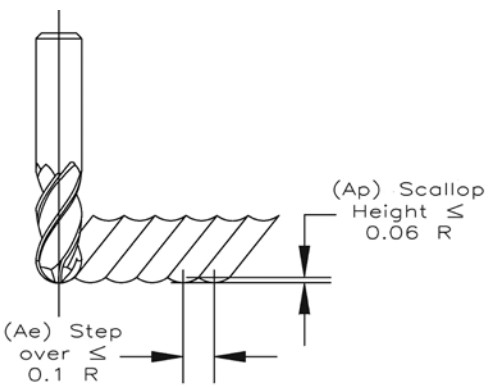

Coolant: Maximum Coolant Pressure

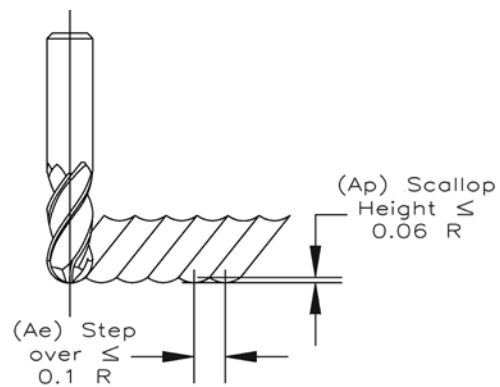



Coolant: Maximum Coolant Pressure

Technical data provided should be considered advisory only as variations may be necessary depending on the particular application.

For product information, call your local distributor.

TuffCut® XR7

180 / 180N / 180CB Recommended Cutting Data - Profile Milling Inch







Workpiece Material Group	ISO	Hardness	Coolant			Profiling (ae)			End Mill Diameter					
			● Preferred ○ Possible x Not Possible						1/4	3/8	1/2	5/8	3/4	1
			5.0	2.3	1.8				← Multiply fz by this Factor based on ae. When finishing, use the standard fz per chart below. Only add chip thinning when roughing or semi-finishing.					
			Max.	Air	MMS	vc - SFM	fz - in/tooth							
Low Carbon Steels 1018, 1020	P	up to 28 Rc	●	●	●	1475	1150	980	.0024	.0039	.0047	.0060	.0078	.0100
Medium Carbon Steels 1140, 1145	P	28 to 38 Rc	●	●	●	1130	900	840	.0024	.0039	.0047	.0060	.0078	.0100
Alloy Steels 4140, 4145	P	28 to 44 Rc	●	●	●	1035	840	765	.0024	.0039	.0047	.0060	.0078	.0100
Die / Tool Steels A2, D2, H13, P20	P	28 to 44 Rc	●	●	●	900	725	615	.0024	.0039	.0047	.0060	.0078	.0100
Stainless Steel - Easy to Machine 430F, 301, 303, 410, 416 Annealed, 420F, 430	M	up to 28 Rc	●	x	○	675	545	425	.0010-.0015	.0015-.0020	.0020-.0031	.0020-.0033	.0022-.0035	.0024-.0039
Stainless Steel - Austenitic 301, 302, 303 High Tensile, 304, 304L, 305, 420, 15-5PH, 17-4PH, 17-7PH	M	up to 28 Rc	●	x	○	525	430	400	.0010-.0015	.0015-.0020	.0020-.0031	.0020-.0033	.0022-.0035	.0024-.0039
Stainless Steel - Difficult to Machine 302B, 304B, 309, 310, 316, 316B, 316L, 316Ti, 317, 317L, 321	M	up to 28 Rc	●	x	○	410	330	295	.0010-.0015	.0015-.0020	.0020-.0031	.002-.0033	.0022-.0035	.0024-.0039
Stainless Steel - Difficult to Machine 17-4 PH, PH13-8Mo, Nitronics	M	over 28 Rc	●	x	○	525	430	395	.0010-.0015	.0015-.0020	.0020-.0031	.0020-.0033	.0022-.0035	.0024-.0039
Cobalt Chrome Alloys	M		●	x	○	410	325	295	.0015	.0020	.0031	.0033	.0035	.0039
Duplex (22%)	M		●	x	○	245	325	180	.0015	.0020	.0031	.0033	.0035	.0039
Super Duplex (25%)	M		●	x	○	245	195	180	.0015	.0020	.0031	.0033	.0035	.0039
High Temp Alloys	S	up to 42 Rc	●	x	x	180	150	130	.0010-.0015	.0015-.0020	.0020-.0031	.0020-.0033	.0022-.0035	.0024-.0039
Inconel	S		●	x	x	180	150	130	.0006-.0010	.0010-.0016	.0010-.0016	.0010-.0017	.0011-.0018	.0012-.0020
Titanium Alloys 6Al-4V, 5Al-2.5 Sn, 6Al-2 Sn-4Zr-6Mo, 3Al-8V-6Cr4Mo-4Zr, 10V-2Fe-3Al, 13V-11Cr-3Al	S	up to 42 Rc	●	x	x	525	425	330	.0006-.0010	.0010-.0016	.0010-.0016	.0010-.0017	.0011-.0018	.0012-.0020
Cast-Iron - Gray CG, ASTM A48, CLASS 20, 25, 30, 35, SAE J431C, GRADES G1800, G3000, G3500, GG 10, 15, 20, 25, 30, 35, 40	K	up to 240 HB	●	○	○	1625	1295	870	.0024	.0039	.0047	.0060	.0078	.0100
Cast Iron - Ductile & Malleable CGI 60-40-18, 65-45-12, D4018, D4512, D5506, 32510, 35108, M3210, M4504, M5503, 250, 300, 350, 400, 450	K	over 240 HB	●	○	○	675	540	510	.0012	.0031	.0039	.0047	.0078	.0100
Hardened Steels	H	40-50 Rc	●	○	○	610	495	325	.0014	.0024	.0030	.0040	.0048	.0064
Hardened Steels		50-55 Rc	●	○	○	510	410	280	.0008	.0016	.0018	.0024	.0028	.0038
Hardened Steels		>55 Rc	●	○	○	330	310	280	.0006	.0010	.0015	.0018	.0021	.0028

Spindle Maximum - Should the calculated spindle speed be more than your actual spindle maximum, use this formula:
(Calculated Feed x Spindle Maximum)/Calculated Speed

Technical data provided should be considered advisory only as variations may be necessary depending on the particular application.

TuffCut® XR7

180 / 180N / 180CB Recommended Cutting Data - Profile Milling Metric

Workpiece Material Group	ISO	Hardness	Coolant			Profiling (ae)			End Mill Diameter (mm)			
			● Preferred ○ Possible x Not Possible						12	16	18	20
						5%	10%	25%	← Multiply fz by this Factor based on ae. When finishing, use the standard fz per chart below. Only add chip thinning when roughing or semi-finishing.			
			Max.	Air	MMS	vc - m/min			fz - mm/tooth			
Low Carbon Steels 1018, 1020	P	up to 28 Rc	●	●	●	450	350	300	.1100	.1500	.1900	.2540
Medium Carbon Steels 1140, 1145	P	28 to 38 Rc	●	●	●	345	275	255	.1100	.1500	.1900	.2540
Alloy Steels 4140, 4145	P	28 to 44 Rc	●	●	●	315	255	230	.1100	.1500	.1900	.2540
Die / Tool Steels A2, D2, H13, P20	P	28 to 44 Rc	●	●	●	275	220	185	.1100	.1500	.1900	.2540
Stainless Steel - Easy to Machine 430F, 301, 303, 410, 416 Annealed, 420F, 430	M	up to 28 Rc	●	x	○	205	165	130	.050-.078	.050-.083	.055-.088	.060-.099
Stainless Steel - Austenitic 301, 302, 303 High Tensile, 304, 304L, 305, 420, 15-5PH, 17-4PH, 17-7PH	M	up to 28 Rc	●	x	○	160	130	120	.050-.078	.050-.083	.055-.088	.060-.099
Stainless Steel - Difficult to Machine 302B, 304B, 309, 310, 316, 316B, 316L, 316Ti, 317, 317L, 321	M	up to 28 Rc	●	x	○	125	100	90	.050-.078	.050-.083	.055-.088	.060-.099
Stainless Steel - Difficult to Machine 17-4 PH, PH13-8Mo, Nitronics	M	over 28 Rc	●	x	○	160	130	120	.050-.078	.050-.083	.055-.088	.060-.099
Cobalt Chrome Alloys	M	over 28 Rc	●	x	○	125	100	90	.0780	.0830	.0880	.0990
Duplex (22%)	M	over 28 Rc	●	x	○	75	60	55	.0780	.0830	.0880	.0990
Super Duplex (25%)	M	over 28 Rc	●	x	○	75	60	55	.0780	.0830	.0880	.0990
High Temp Alloys	S	up to 42 Rc	●	x	x	55	45	40	.025-.040	.025-.043	.027-.045	.030-.050
Inconel	S	up to 42 Rc	●	x	x	55	45	40	.025-.040	.025-.043	.027-.045	.030-.050
Titanium Alloys 6Al-4V, 5Al-2.5 Sn, 6Al-2 Sn-4Zr-6Mo, 3Al-8V-6Cr4Mo-4Zr, 10V-2Fe-3Al, 13V-11Cr-3Al	S	up to 42 Rc	●	x	x	160	130	100	.050-.078	.050-.083	.055-.088	.030-.050
Cast-Iron - Gray CG, ASTM A48, CLASS 20, 25, 30, 35, SAE J431C, GRADES G1800, G3000, G3500, GG 10, 15, 20, 25, 30, 35, 40	K	up to 240 HB	●	○	○	495	395	265	.1100	.1500	.1900	.2540
Cast Iron - Ductile & Malleable CGI 60-40-18, 65-45-12, D4018, D4512, D5506, 32510, 35108, M3210, M4504, M5503, 250, 300, 350, 400, 450	K	over 240 HB	●	○	○	205	165	155	.1100	.1500	.1900	.2540
Hardened Steels	H	40-50 Rc	●	○	○	185	150	100	.1016	.1168	.1310	.1524
Hardened Steels		50-55 Rc	●	○	○	155	125	85	.0610	.0762	.0857	.0889
Hardened Steels		>55 Rc	●	○	○	100	95	85	.0457	.0559	.0628	.0635

Spindle Maximum - Should the calculated spindle speed be more than your actual spindle maximum, use this formula:

$$\text{(Calculated Feed} \times \text{Spindle Maximum)} / \text{Calculated Speed}$$







Technical data provided should be considered advisory only as variations may be necessary depending on the particular application.

For product information, call your local distributor.

TuffCut® XR

279/177/177L/177S/177W/179/179L Recommended Cutting Data - Profile Milling

Inch 279/179/179L series - If axial depth (ap) is less than the ball diameter, the speed is figured using the effective cutting diameter. See pages 316-317 for 279 series contouring data.

Workpiece Material Group	ISO	Hardness	Coolant			Profiling (ae)				End Mill Diameter								
			● Preferred ○ Possible x Not Possible							1/8*	3/16*	1/4*	5/16	3/8	1/2	5/8	3/4	1
						2.3	1.8	1.2	1.0	*Profile Milling at ≥ 50% ap is not recommended for diameters 1/4" and below. ← Multiply fz by this Factor based on ae. When finishing, use the standard fz per chart below. Only add chip thinning when roughing or semi-finishing.								
			Max.	Air	MMS	vc - SFM												
Low Carbon Steels 1018, 1020	P	up to 28 Rc	●	●	●	1475	1150	980	500	.0012	.0020	.0024	.0031	.0039	.0047	.0060	.0078	.0100
Medium Carbon Steels 1140, 1145	P	28 to 38 Rc	●	●	●	1130	900	840	250	.0012	.0020	.0024	.0031	.0039	.0047	.0060	.0078	.0100
Alloy Steels 4140, 4145	P	28 to 44 Rc	●	●	●	1035	840	765	250	.0012	.0020	.0024	.0031	.0039	.0047	.0060	.0078	.0100
Die / Tool Steels A2, D2, H13, P20	P	28 to 44 Rc	●	●	●	900	725	615	200	.0012	.0020	.0024	.0031	.0039	.0047	.0060	.0078	.0100
Hardened Steels A2, D2	H	45 to 50 Rc	●	○	○	610	495	325	250	.0006	.0010	.0012	.0016	.0020	.0024	.0030	.0040	.0050
Hardened Steels A2, D2	H	50 to 55 Rc	●	○	○	510	410	280	200	.0003	.0005	.0006	.0008	.0010	.0012	.0016	.0020	.0024
Stainless Steel - Easy to Machine 430F, 301, 303, 410, 416 Annealed, 420F, 430	M	up to 28 Rc	●	x	○	675	545	425	360	.0012	.0020	.0024	.0031	.0039	.0047	.0060	.0078	.0100
Stainless Steel - Austenitic 301, 302, 303 High Tensile, 304, 304L, 305, 420, 15-5PH, 17-4PH, 17-7PH	M	up to 28 Rc	●	x	○	525	430	400	210	.0012	.0020	.0024	.0031	.0039	.0047	.0060	.0078	.0100
Stainless Steel - Difficult to Machine 302B, 304B, 309, 310, 316, 316B, 316L, 316Ti, 317, 317L, 321	M	up to 28 Rc	●	x	○	410	330	295	210	.0012	.0020	.0024	.0031	.0039	.0047	.0060	.0078	.0100
Stainless Steel - Difficult to Machine 17-4 PH, PH13-8Mo, Nitronics	M	over 28 Rc	●	x	○	525	430	395	110	.0006	.0010	.0012	.0016	.0020	.0024	.0030	.0040	.0050
Cobalt Chrome Alloys	M		●	x	○	410	325	295	130	.0006	.0010	.0012	.0016	.0020	.0024	.0030	.0040	.0050
Duplex (22%)	M		●	x	○	245	195	180	130	.0006	.0010	.0012	.0016	.0020	.0024	.0030	.0040	.0050
Super Duplex (25%)	M		●	x	○	245	195	180	110	.0006	.0010	.0012	.0016	.0020	.0024	.0030	.0040	.0050
High Temp Alloys	S	up to 42 Rc	●	x	x	180	150	130	85	.0003	.0005	.0006	.0008	.0010	.0012	.0016	.0020	.0024
Inconel	S		●	x	x	180	150	130	85	.0003	.0005	.0006	.0008	.0010	.0012	.0016	.0020	.0024
Titanium Alloys 6Al-4V, 5Al-2.5 Sn, 6Al-2 Sn-4Zr-6Mo, 3Al-8V-6Cr4Mo-4Zr, 10V-2Fe-3Al, 13V-11Cr-3Al	S	up to 42 Rc	●	x	x	525	425	330	175	.0003	.0005	.0006	.0008	.0010	.0012	.0016	.0020	.0024
Cast-Iron - Gray CG, ASTM A48, CLASS 20, 25, 30, 35, SAE J431C, GRADES G1800, G3000, G3500, GG 10, 15, 20, 25, 30, 35, 40	K	up to 240 HB	●	○	○	1625	1295	870	350	.0012	.0020	.0024	.0031	.0039	.0047	.0060	.0078	.0100
Cast Iron - Ductile & Malleable CGI 60-40-18, 65-45-12, D4018, D4512, D5506, 32510, 35108, M3210, M4504, M5503, 250, 300, 350, 400, 450	K	over 240 HB	●	○	○	675	540	510	260	.0012	.0020	.0024	.0031	.0039	.0047	.0060	.0078	.0100

Spindle Maximum - Should the calculated spindle speed be more than your actual spindle maximum, use this formula:
 (Calculated Feed x Spindle Maximum)/Calculated Speed

Technical data provided should be considered advisory only as variations may be necessary depending on the particular application.

279/177/177L/177S/177W/179/179L Recommended Cutting Data - Profile Milling

Metric 279/179/179L series - If axial depth (ap) is less than the ball diameter, the speed is figured using the effective cutting diameter. See pages 316-317 for 279 series contouring data.

Workpiece Material Group	ISO	Hardness	Coolant			Profiling (ae)				End Mill Diameter (mm)								
			● Preferred ○ Possible x Not Possible							3*	5*	6*	8	10	12	16	20	25
						2.3	1.8	1.2	1.0	*Profile Milling at ≥ 50% ap is not recommended for diameters 6mm and below.								
			Max.	Air	MMS	vc - m/min				← Multiply fz by this Factor based on ae. When finishing, use the standard fz per chart below. Only add chip thinning when roughing or semi-finishing.								
										fz - mm/tooth								
Low Carbon Steels 1018, 1020	P	up to 28 Rc	●	●	●	450	350	300	150	.0300	.0500	.0600	.0800	.1000	.1200	.1600	.2000	.2500
Medium Carbon Steels 1140, 1145	P	28 to 38 Rc	●	●	●	345	275	255	75	.0300	.0500	.0600	.0800	.1000	.1200	.1600	.2000	.2500
Alloy Steels 4140, 4145	P	28 to 44 Rc	●	●	●	315	255	230	75	.0300	.0500	.0600	.0800	.1000	.1200	.1600	.2000	.2500
Die / Tool Steels A2, D2, H13, P20	P	28 to 44 Rc	●	●	●	275	220	185	60	.0300	.0500	.0600	.0800	.1000	.1200	.1600	.2000	.2500
Hardened Steels A2, D2	H	45 to 50 Rc	●	○	○	185	150	100	75	.0150	.0250	.0300	.0400	.0500	.0600	.0800	.1000	.1250
Hardened Steels A2, D2	H	50 to 55 Rc	●	○	○	155	125	85	60	.0070	.0120	.0150	.0200	.0250	.0300	.0400	.0500	.0620
Stainless Steel - Easy to Machine 430F, 301, 303, 410, 416 Annealed, 420F, 430	M	up to 28 Rc	●	x	○	205	165	130	110	.0300	.0500	.0600	.0800	.1000	.1200	.1600	.2000	.2500
Stainless Steel - Austenitic 301, 302, 303 High Tensile, 304, 304L, 305, 420, 15-5PH, 17-4PH, 17-7PH	M	up to 28 Rc	●	x	○	160	130	120	65	.0300	.0500	.0600	.0800	.1000	.1200	.1600	.2000	.2500
Stainless Steel - Difficult to Machine 302B, 304B, 309, 310, 316, 316B, 316L, 316Ti, 317, 317L, 321	M	up to 28 Rc	●	x	○	125	100	90	65	.0300	.0500	.0600	.0800	.1000	.1200	.1600	.2000	.2500
Stainless Steel - Difficult to Machine 17-4 PH, PH13-8Mo, Nitronics	M	over 28 Rc	●	x	○	160	130	120	35	.0150	.0250	.0300	.0400	.0500	.0600	.0800	.1000	.1250
Cobalt Chrome Alloys	M		●	x	○	125	100	90	40	.0150	.0250	.0300	.0400	.0500	.0600	.0800	.1000	.1250
Duplex (22%)	M		●	x	○	75	60	55	40	.0150	.0250	.0300	.0400	.0500	.0600	.0800	.1000	.1250
Super Duplex (25%)	M		●	x	○	75	60	55	35	.0150	.0250	.0300	.0400	.0500	.0600	.0800	.1000	.1250
High Temp Alloys	S	up to 42 Rc	●	x	x	55	45	40	25	.0070	.0120	.0150	.0200	.0250	.0300	.0400	.0500	.0620
Inconel	S		●	x	x	55	45	40	25	.0070	.0120	.0150	.0200	.0250	.0300	.0400	.0500	.0620
Titanium Alloys 6Al-4V, 5Al-2.5 Sn, 6Al-2 Sn-4Zr-6Mo, 3Al-8V-6Cr4Mo-4Zr, 10V-2Fe-3Al, 13V-11Cr-3Al	S	up to 42 Rc	●	x	x	160	130	100	55	.0070	.0120	.0150	.0200	.0250	.0300	.0400	.0500	.0620
Cast-Iron - Gray CG, ASTM A48, CLASS 20, 25, 30, 35, SAE J431C, GRADES G1800, G3000, G3500, GG 10, 15, 20, 25, 30, 35, 40	K	up to 240 HB	●	○	○	495	395	265	110	.0300	.0500	.0600	.0800	.1000	.1200	.1600	.2000	.2500
Cast Iron - Ductile & Malleable CGI 60-40-18, 65-45-12, D4018, D4512, D5506, 32510, 35108, M3210, M4504, M5503, 250, 300, 350, 400, 450	K	over 240 HB	●	○	○	205	165	155	80	.0300	.0500	.0600	.0800	.1000	.1200	.1600	.2000	.2500

Spindle Maximum - Should the calculated spindle speed be more than your actual spindle maximum, use this formula:







$$\frac{\text{Calculated Feed} \times \text{Spindle Maximum}}{\text{Calculated Speed}}$$

Technical data provided should be considered advisory only as variations may be necessary depending on the particular application.

For product information, call your local distributor.

279/177/177L/177S/177W/179/179L Recommended Cutting Data - Slotting







Inch 279/179/179L series - If axial depth (ap) is less than the ball diameter, the speed is figured using the effective cutting diameter.
See 316-317 for 279 series contouring data.

Workpiece Material Group	I S O	Hardness	Coolant			Slotting			End Mill Diameter								
			• Preferred o Possible x Not Possible						1/8*	3/16*	1/4*	5/16	3/8	1/2	5/8	3/4	1
						25%	50%	100%	*Slotting at > 25% ap is not recommended for diameters 1/4" and below.								
			Max.	Air	MMS	vc - SFM											
Low Carbon Steels 1018, 1020	P	up to 28 Rc	•	•	•	550	500	475	.0004	.0010	.0012	.0016	.0020	.0025	.0031	.0040	.0050
Medium Carbon Steels 1140, 1145	P	28 to 38 Rc	•	•	•	275	250	225	.0004	.0010	.0012	.0016	.0020	.0025	.0031	.0040	.0050
Alloy Steels 4140, 4145	P	28 to 44 Rc	•	•	•	275	250	225	.0004	.0010	.0012	.0016	.0020	.0025	.0031	.0040	.0050
Die / Tool Steels A2, D2, H13, P20	P	28 to 44 Rc	•	•	•	225	200	175	.0004	.0010	.0012	.0016	.0020	.0025	.0031	.0040	.0050
Hardened Steels A2, D2	H	45 to 50 Rc	•	o	o	275	250	225	.0003	.0005	.0006	.0008	.0010	.0012	.0016	.0020	.0024
Hardened Steels A2, D2	H	50 to 55 Rc	•	o	o	225	200	175	.0001	.0002	.0003	.0004	.0005	.0006	.0008	.0010	.0015
Stainless Steel - Easy to Machine 430F, 301, 303, 410, 416 Annealed, 420F, 430	M	up to 28 Rc	•	x	o	385	360	350	.0004	.0010	.0012	.0016	.0020	.0024	.0031	.0040	.0050
Stainless Steel - Austenitic 301, 302, 303 High Tensile, 304, 304L, 305, 420, 15-5PH, 17-4PH, 17-7PH	M	up to 28 Rc	•	x	o	225	210	200	.0004	.0010	.0012	.0016	.0020	.0024	.0031	.0040	.0050
Stainless Steel - Difficult to Machine 302B, 304B, 309, 310, 316, 316B, 316L, 316Ti, 317, 317L, 321	M	up to 28 Rc	•	x	o	225	210	200	.0004	.0010	.0012	.0016	.0020	.0024	.0031	.0040	.0050
Stainless Steel - Difficult to Machine 17-4 PH, PH13-8Mo, Nitronics	M	over 28 Rc	•	x	o	125	110	100	.0003	.0005	.0006	.0008	.0010	.0012	.0016	.0020	.0024
Cobalt Chrome Alloys	M		•	x	o	150	130	120	.0003	.0005	.0006	.0008	.0010	.0012	.0016	.0020	.0024
Duplex (22%)	M		•	x	o	150	130	120	.0003	.0005	.0006	.0008	.0010	.0012	.0016	.0020	.0024
Super Duplex (25%)	M		•	x	o	120	110	100	.0003	.0005	.0006	.0008	.0010	.0012	.0016	.0020	.0024
High Temp Alloys	S	up to 42 Rc	•	x	x	100	85	75	.0003	.0005	.0006	.0008	.0010	.0012	.0016	.0020	.0024
Inconel	S		•	x	x	95	85	75	.0003	.0005	.0006	.0008	.0010	.0012	.0016	.0020	.0024
Titanium Alloys 6Al-4V, 5Al-2.5 Sn, 6Al-2 Sn-4Zr-6Mo, 3Al-8V-6Cr4Mo-4Zr, 10V-2Fe-3Al, 13V-11Cr-3Al	S	up to 42 Rc	•	x	x	180	175	160	.0003	.0005	.0006	.0008	.0010	.0012	.0016	.0020	.0024
Cast-Iron - Gray CG, ASTM A48, CLASS 20, 25, 30, 35, SAE J431C, GRADES G1800, G3000, G3500, GG 10, 15, 20, 25, 30, 35, 40	K	up to 240 HB	•	o	o	375	350	325	.0004	.0010	.0012	.0016	.0020	.0024	.0031	.0040	.0050
Cast Iron - Ductile & Malleable CGI 60-40-18, 65-45-12, D4018, D4512, D5506, 32510, 35108, M3210, M4504, M5503, 250, 300, 350, 400, 450	K	over 240 HB	•	o	o	275	260	250	.0004	.0010	.0012	.0016	.0020	.0024	.0031	.0040	.0050

Spindle Maximum - Should the calculated spindle speed be more than your actual spindle maximum, use this formula:
(Calculated Feed x Spindle Maximum)/Calculated Speed







279/177/177L/177S/177W/179/179L Recommended Cutting Data - Slotting

Metric 279/179/179L series - If axial depth (ap) is less than the ball diameter, the speed is figured using the effective cutting diameter.
See pages 316-317 for 279 series contouring data.

Workpiece Material Group	ISO	Hardness	Coolant			Slotting			End Mill Diameter (mm)								
			● Preferred ○ Possible x Not Possible						3*	5*	6*	8	10	12	16	20	25
						25%	50%	100%	*Slotting at > 25% ap is not recommended for diameters 6mm and below.								
			Max.	Air	MMS	vc - m/min			fz - mm/tooth								
Low Carbon Steels 1018, 1020	P	up to 28 Rc	●	●	●	170	150	145	.0100	.0250	.0300	.0400	.0500	.0600	.0800	.1000	.1250
Medium Carbon Steels 1140, 1145	P	28 to 38 Rc	●	●	●	85	75	70	.0100	.0250	.0300	.0400	.0500	.0600	.0800	.1000	.1250
Alloy Steels 4140, 4145	P	28 to 44 Rc	●	●	●	85	75	70	.0100	.0250	.0300	.0400	.0500	.0600	.0800	.1000	.1250
Die / Tool Steels A2, D2, H13, P20	P	28 to 44 Rc	●	●	●	70	60	55	.0100	.0250	.0300	.0400	.0500	.0600	.0800	.1000	.1250
Hardened Steels A2, D2	H	45 to 50 Rc	●	○	○	85	75	70	.0070	.0120	.0150	.0200	.0250	.0300	.0400	.0500	.0620
Hardened Steels A2, D2	H	50 to 55 Rc	●	○	○	70	60	55	.0030	.0060	.0070	.0100	.0120	.0150	.0200	.0250	.0370
Stainless Steel - Easy to Machine 430F, 301, 303, 410, 416 Annealed, 420F, 430	M	up to 28 Rc	●	x	○	120	110	110	.0100	.0250	.0300	.0400	.0500	.0600	.0800	.1000	.1250
Stainless Steel - Austenitic 301, 302, 303 High Tensile, 304, 304L, 305, 420, 15-5PH, 17-4PH, 17-7PH	M	up to 28 Rc	●	x	○	70	65	60	.0100	.0250	.0300	.0400	.0500	.0600	.0800	.1000	.1250
Stainless Steel - Difficult to Machine 302B, 304B, 309, 310, 316, 316B, 316L, 316Ti, 317, 317L, 321	M	up to 28 Rc	●	x	○	70	65	60	.0100	.0250	.0300	.0400	.0500	.0600	.0800	.1000	.1250
Stainless Steel - Difficult to Machine 17-4 PH, PH13-8Mo, Nitronics	M	over 28 Rc	●	x	○	40	35	30	.0070	.0120	.0150	.0200	.0250	.0300	.0400	.0500	.0620
Cobalt Chrome Alloys	M		●	x	○	45	40	40	.0070	.0120	.0150	.0200	.0250	.0300	.0400	.0500	.0620
Duplex (22%)	M		●	x	○	45	40	40	.0070	.0120	.0150	.0200	.0250	.0300	.0400	.0500	.0620
Super Duplex (25%)	M		●	x	○	40	35	30	.0070	.0120	.0150	.0200	.0250	.0300	.0400	.0500	.0620
High Temp Alloys	S	up to 42 Rc	●	x	x	30	25	25	.0070	.0120	.0150	.0200	.0250	.0300	.0400	.0500	.0620
Inconel	S	up to 42 Rc	●	x	x	30	25	25	.0070	.0120	.0150	.0200	.0250	.0300	.0400	.0500	.0620
Titanium Alloys 6Al-4V, 5Al-2.5 Sn, 6Al-2 Sn-4Zr-6Mo, 3Al-8V-6Cr4Mo-4Zr, 10V-2Fe-3Al, 13V-11Cr-3Al	S	up to 42 Rc	●	x	x	55	55	50	.0070	.0120	.0150	.0200	.0250	.0300	.0400	.0500	.0620
Cast-Iron - Gray CG, ASTM A48, CLASS 20, 25, 30, 35, SAE J431C, GRADES G1800, G3000, G3500, GG 10, 15, 20, 25, 30, 35, 40	K	up to 240 HB	●	○	○	115	105	100	.0100	.0250	.0300	.0400	.0500	.0600	.0800	.1000	.1250
Cast Iron - Ductile & Malleable CGI 60-40-18, 65-45-12, D4018, D4512, D5506, 32510, 35108, M3210, M4504, M5503, 250, 300, 350, 400, 450	K	over 240 HB	●	○	○	85	80	75	.0100	.0250	.0300	.0400	.0500	.0600	.0800	.1000	.1250







Spindle Maximum - Should the calculated spindle speed be more than your actual spindle maximum, use this formula:
(Calculated Feed x Spindle Maximum)/Calculated Speed

178 / 178N / 178W Recommended Cutting Data - Profile Milling Inch

Workpiece Material Group	ISO	Hardness	Coolant			Profiling (ae)				End Mill Diameter								
			• Preferred o Possible x Not Possible							1/8*	3/16*	1/4*	5/16	3/8	1/2	5/8	3/4	1
						5%	10%	25%	50%	*Profile Milling at ≥ 50% ap is not recommended for diameters 1/4" and below.								
			Max.	Air	MMS	vc - SFM				← Multiply fz by this Factor based on ae. When finishing, use the standard fz per chart below. Only add chip thinning when roughing or semi-finishing.								
										fz - in/tooth								
Low Carbon Steels 1018, 1020	P	up to 28 Rc	•	•	•	1475	1150	980	500	.0012	.0020	.0024	.0031	.0039	.0047	.0060	.0078	.0100
Medium Carbon Steels 1140, 1145	P	28 to 38 Rc	•	•	•	1130	900	840	250	.0012	.0020	.0024	.0031	.0039	.0047	.0060	.0078	.0100
Alloy Steels 4140, 4145	P	28 to 44 Rc	•	•	•	1035	840	765	250	.0012	.0020	.0024	.0031	.0039	.0047	.0060	.0078	.0100
Die / Tool Steels A2, D2, H13, P20	P	28 to 44 Rc	•	•	•	900	725	615	200	.0012	.0020	.0024	.0031	.0039	.0047	.0060	.0078	.0100
Hardened Steels A2, D2	H	45 to 50 Rc	•	o	o	610	495	325	250	.0006	.0010	.0012	.0016	.0020	.0024	.0030	.0040	.0050
Hardened Steels A2, D2	H	50 to 55 Rc	•	o	o	510	410	280	200	.0003	.0005	.0006	.0008	.0010	.0012	.0016	.0020	.0024
Stainless Steel - Easy to Machine 430F, 301, 303, 410, 416 Annealed, 420F, 430	M	up to 28 Rc	•	x	o	675	545	425	360	.0012	.0020	.0024	.0031	.0039	.0047	.0060	.0078	.0100
Stainless Steel - Austenitic 301, 302, 303 High Tensile, 304, 304L, 305, 420, 15-5PH, 17-4PH, 17-7PH	M	up to 28 Rc	•	x	o	525	430	400	210	.0012	.0020	.0024	.0031	.0039	.0047	.0060	.0078	.0100
Stainless Steel - Difficult to Machine 302B, 304B, 309, 310, 316, 316B, 316L, 316Ti, 317, 317L, 321	M	up to 28 Rc	•	x	o	410	330	295	210	.0012	.0020	.0024	.0031	.0039	.0047	.0060	.0078	.0100
Stainless Steel - Difficult to Machine 17-4 PH, PH13-8Mo, Nitronics	M	over 28 Rc	•	x	o	525	430	395	110	.0006	.0010	.0012	.0016	.0020	.0024	.0030	.0040	.0050
Cobalt Chrome Alloys	M		•	x	o	410	325	295	130	.0006	.0010	.0012	.0016	.0020	.0024	.0030	.0040	.0050
Duplex (22%)	M		•	x	o	245	195	180	130	.0006	.0010	.0012	.0016	.0020	.0024	.0030	.0040	.0050
Super Duplex (25%)	M		•	x	o	245	195	180	110	.0006	.0010	.0012	.0016	.0020	.0024	.0030	.0040	.0050
High Temp Alloys	S	up to 42 Rc	•	x	x	180	150	130	85	.0003	.0005	.0006	.0008	.0010	.0012	.0016	.0020	.0024
Inconel	S		•	x	x	180	150	130	85	.0003	.0005	.0006	.0008	.0010	.0012	.0016	.0020	.0024
Titanium Alloys 6Al-4V, 5Al-2.5 Sn, 6Al-2 Sn-4Zr-6Mo, 3Al-8V-6Cr-4Mo-4Zr, 10V-2Fe-3Al, 13V-11Cr-3Al	S	up to 42 Rc	•	x	x	525	425	330	175	.0003	.0005	.0006	.0008	.0010	.0012	.0016	.0020	.0024
Cast-Iron - Gray CG, ASTM A48, CLASS 20, 25, 30, 35, SAE J431C, GRADES G1800, G3000, G3500, GG 10, 15, 20, 25, 30, 35, 40	K	up to 240 HB	•	o	o	1625	1295	870	350	.0012	.0020	.0024	.0031	.0039	.0047	.0060	.0078	.0100
Cast Iron - Ductile & Malleable CGI 60-40-18, 65-45-12, D4018, D4512, D5506, 32510, 35108, M3210, M4504, M5503, 250, 300, 350, 400, 450	K	over 240 HB	•	o	o	675	540	510	260	.0012	.0020	.0024	.0031	.0039	.0047	.0060	.0078	.0100

Spindle Maximum - Should the calculated spindle speed be more than your actual spindle maximum, use this formula:
(Calculated Feed x Spindle Maximum)/Calculated Speed

178 / 178N / 178W Recommended Cutting Data - Profile Milling Metric

Workpiece Material Group	ISO	Hardness	Coolant			Profiling (ae)				End Mill Diameter (mm)								
			● Preferred ○ Possible x Not Possible							3*	5*	6*	8	10	12	16	20	25
						2.3	1.8	1.2	1.0	*Profile Milling at ≥ 50% ap is not recommended for diameters 6mm and below.								
			Max.	Air	MMS	vc - m/min				← Multiply fz by this Factor based on ae. When finishing, use the standard fz per chart below. Only add chip thinning when roughing or semi-finishing.								
										fz - mm/tooth								
Low Carbon Steels 1018, 1020	P	up to 28 Rc	●	●	●	450	350	300	150	.0300	.0500	.0600	.0800	.1000	.1200	.1600	.2000	.2500
Medium Carbon Steels 1140, 1145	P	28 to 38 Rc	●	●	●	345	275	265	75	.0300	.0500	.0600	.0800	.1000	.1200	.1600	.2000	.2500
Alloy Steels 4140, 4145	P	28 to 44 Rc	●	●	●	315	255	230	75	.0300	.0500	.0600	.0800	.1000	.1200	.1600	.2000	.2500
Die / Tool Steels A2, D2, H13, P20	P	28 to 44 Rc	●	●	●	275	220	185	60	.0300	.0500	.0600	.0800	.1000	.1200	.1600	.2000	.2500
Hardened Steels A2, D2	H	45 to 50 Rc	●	○	○	185	150	100	75	.0150	.0250	.0300	.0400	.0500	.0600	.0800	.1000	.1250
Hardened Steels A2, D2	H	50 to 55 Rc	●	○	○	155	125	85	60	.0070	.0120	.0150	.0200	.0250	.0300	.0400	.0500	.0620
Stainless Steel - Easy to Machine 430F, 301, 303, 410, 416 Annealed, 420F, 430	M	up to 28 Rc	●	x	○	205	165	130	110	.0300	.0500	.0600	.0800	.1000	.1200	.1600	.2000	.2500
Stainless Steel - Austenitic 301, 302, 303 High Tensile, 304, 304L, 305, 420, 15-5PH, 17-4PH, 17-7PH	M	up to 28 Rc	●	x	○	160	130	120	65	.0300	.0500	.0600	.0800	.1000	.1200	.1600	.2000	.2500
Stainless Steel - Difficult to Machine 302B, 304B, 309, 310, 316, 316B, 316L, 316Ti, 317, 317L, 321	M	up to 28 Rc	●	x	○	125	100	90	65	.0300	.0500	.0600	.0800	.1000	.1200	.1600	.2000	.2500
Stainless Steel - Difficult to Machine 17-4 PH, PH13-8Mo, Nitronics	M	over 28 Rc	●	x	○	160	130	120	35	.0150	.0250	.0300	.0400	.0500	.0600	.0800	.1000	.1250
Cobalt Chrome Alloys	M		●	x	○	125	100	90	40	.0150	.0250	.0300	.0400	.0500	.0600	.0800	.1000	.1250
Duplex (22%)	M		●	x	○	75	60	55	40	.0150	.0250	.0300	.0400	.0500	.0600	.0800	.1000	.1250
Super Duplex (25%)	M		●	x	○	75	60	55	35	.0150	.0250	.0300	.0400	.0500	.0600	.0800	.1000	.1250
High Temp Alloys	S	up to 42 Rc	●	x	x	55	45	40	25	.0070	.0120	.0150	.0200	.0250	.0300	.0400	.0500	.0620
Inconel	S		●	x	x	55	45	40	25	.0070	.0120	.0150	.0200	.0250	.0300	.0400	.0500	.0620
Titanium Alloys 6Al-4V, 5Al-2.5 Sn, 6Al-2 Sn-4Zr-6Mo, 3Al-8V-6Cr4Mo-4Zr, 10V-2Fe-3Al, 13V-11Cr-3Al	S	up to 42 Rc	●	x	x	160	130	100	55	.0070	.0120	.0150	.0200	.0250	.0300	.0400	.0500	.0620
Cast-Iron - Gray CG, ASTM A48, CLASS 20, 25, 30, 35, SAE J431C, GRADES G1800, G3000, G3500, GG 10, 15, 20, 25, 30, 35, 40	K	up to 240 HB	●	○	○	495	395	265	110	.0300	.0500	.0600	.0800	.1000	.1200	.1600	.2000	.2500
Cast Iron - Ductile & Malleable CGI 60-40-18, 65-45-12, D4018, D4512, D5506, 32510, 35108, M3210, M4504, M5503, 250, 300, 350, 400, 450	K	over 240 HB	●	○	○	205	165	155	80	.0300	.0500	.0600	.0800	.1000	.1200	.1600	.2000	.2500





Spindle Maximum - Should the calculated spindle speed be more than your actual spindle maximum, use this formula:

$$\frac{\text{Calculated Feed} \times \text{Spindle Maximum}}{\text{Calculated Speed}}$$

Technical data provided should be considered advisory only as variations may be necessary depending on the particular application.

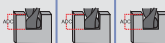





For product information, call your local distributor.

178 / 178N / 178W Recommended Cutting Data - Slotting Inch

Workpiece Material Group	ISO	Hardness	Coolant			Slotting			End Mill Diameter								
			• Preferred o Possible x Not Possible						1/8*	3/16*	1/4*	5/16	3/8	1/2	5/8	3/4	1
						25%	50%	100%	*Slotting at > 25% ap is not recommended for diameters 1/4" and below.								
			Max.	Air	MMS	vc - SFM			fz - in/tooth								
Low Carbon Steels 1018, 1020	P	up to 28 Rc	•	•	•	550	500	475	.0004	.0010	.0012	.0016	.0020	.0025	.0031	.0040	.0050
Medium Carbon Steels 1140, 1145	P	28 to 38 Rc	•	•	•	275	250	225	.0004	.0010	.0012	.0016	.0020	.0025	.0031	.0040	.0050
Alloy Steels 4140, 4145	P	28 to 44 Rc	•	•	•	275	250	225	.0004	.0010	.0012	.0016	.0020	.0025	.0031	.0040	.0050
Die / Tool Steels A2, D2, H13, P20	P	28 to 44 Rc	•	•	•	225	200	175	.0004	.0010	.0012	.0016	.0020	.0025	.0031	.0040	.0050
Hardened Steels A2, D2	H	45 to 50 Rc	•	o	o	275	250	225	.0003	.0005	.0006	.0008	.0010	.0012	.0016	.0020	.0024
Hardened Steels A2, D2	H	50 to 55 Rc	•	o	o	225	200	175	.0001	.0002	.0003	.0004	.0005	.0006	.0008	.0010	.0015
Stainless Steel - Easy to Machine 430F, 301, 303, 410, 416 Annealed, 420F, 430	M	up to 28 Rc	•	x	o	385	360	350	.0002	.0004	.0008	.0012	.0014	.0018	.0022	.0026	.0038
Stainless Steel - Austenitic 301, 302, 303 High Tensile, 304, 304L, 305, 420, 15-5PH, 17-4PH, 17-7PH	M	up to 28 Rc	•	x	o	225	210	200	.0002	.0004	.0008	.0012	.0014	.0018	.0022	.0026	.0038
Stainless Steel - Difficult to Machine 302B, 304B, 309, 310, 316, 316B, 316L, 316Ti, 317, 317L, 321	M	up to 28 Rc	•	x	o	225	210	200	.0002	.0004	.0008	.0012	.0014	.0018	.0022	.0026	.0038
Stainless Steel - Difficult to Machine 17-4 PH, PH13-8Mo, Nitronics	M	over 28 Rc	•	x	o	125	110	100	.0003	.0005	.0006	.0008	.0010	.0012	.0016	.0020	.0024
Cobalt Chrome Alloys	M		•	x	o	150	130	120	.0003	.0005	.0006	.0008	.0010	.0012	.0016	.0020	.0024
Duplex (22%)	M		•	x	o	150	130	120	.0003	.0005	.0006	.0008	.0010	.0012	.0016	.0020	.0024
Super Duplex (25%)	M		•	x	o	120	110	100	.0003	.0005	.0006	.0008	.0010	.0012	.0016	.0020	.0024
High Temp Alloys	S	up to 42 Rc	•	x	x	100	85	75	.0003	.0005	.0006	.0008	.0010	.0012	.0016	.0020	.0024
Inconel	S		•	x	x	95	85	75	.0003	.0005	.0006	.0008	.0010	.0012	.0016	.0020	.0024
Titanium Alloys 6Al-4V, 5Al-2.5 Sn, 6Al-2 Sn-4Zr-6Mo, 3Al-8V-6Cr4Mo-4Zr, 10V-2Fe-3Al, 13V-11Cr-3Al	S	up to 42 Rc	•	x	x	180	175	160	.0003	.0005	.0006	.0008	.0010	.0012	.0016	.0020	.0024
Cast-Iron - Gray CG, ASTM A48, CLASS 20, 25, 30, 35, SAE J431C, GRADES G1800, G3000, G3500, GG 10, 15, 20, 25, 30, 35, 40	K	up to 240 HB	•	o	o	375	350	325	.0004	.0010	.0012	.0016	.0020	.0024	.0031	.0040	.0050
Cast Iron - Ductile & Malleable CGI 60-40-18, 65-45-12, D4018, D4512, D5506, 32510, 35108, M3210, M4504, M5503, 250, 300, 350, 400, 450	K	over 240 HB	•	o	o	275	260	250	.0004	.0010	.0012	.0016	.0020	.0024	.0031	.0040	.0050

Spindle Maximum - Should the calculated spindle speed be more than your actual spindle maximum, use this formula:
 (Calculated Feed x Spindle Maximum)/Calculated Speed





178 / 178N / 178W Recommended Cutting Data - Slotting Metric

Workpiece Material Group	ISO	Hardness	Coolant			Slotting			End Mill Diameter (mm)								
			● Preferred ○ Possible x Not Possible						3*	5*	6*	8	10	12	16	20	25
						25%	50%	100%	*Slotting at > 25% ap is not recommended for diameters 6mm and below.								
			Max.	Air	MMS	vc - m/min			fz - mm/tooth								
Low Carbon Steels 1018, 1020	P	up to 28 Rc	●	●	●	170	150	145	.0100	.0250	.0300	.0400	.0500	.0600	.0800	.1000	.1250
Medium Carbon Steels 1140, 1145	P	28 to 38 Rc	●	●	●	85	75	70	.0100	.0250	.0300	.0400	.0500	.0600	.0800	.1000	.1250
Alloy Steels 4140, 4145	P	28 to 44 Rc	●	●	●	85	75	70	.0100	.0250	.0300	.0400	.0500	.0600	.0800	.1000	.1250
Die / Tool Steels A2, D2, H13, P20	P	28 to 44 Rc	●	●	●	70	60	55	.0100	.0250	.0300	.0400	.0500	.0600	.0800	.1000	.1250
Hardened Steels A2, D2	H	45 to 50 Rc	●	○	○	85	75	70	.0070	.0120	.0150	.0200	.0250	.0300	.0400	.0500	.0620
Hardened Steels A2, D2	H	50 to 55 Rc	●	○	○	70	60	55	.0030	.0060	.0070	.0100	.0120	.0150	.0200	.0250	.0370
Stainless Steel - Easy to Machine 430F, 301, 303, 410, 416 Annealed, 420F, 430	M	up to 28 Rc	●	x	○	120	110	110	.0050	.0100	.0200	.0300	.0350	.0450	.0550	.0650	.0950
Stainless Steel - Austenitic 301, 302, 303 High Tensile, 304, 304L, 305, 420, 15-5PH, 17-4PH, 17-7PH	M	up to 28 Rc	●	x	○	70	65	60	.0050	.0100	.0200	.0300	.0350	.0450	.0550	.0650	.0950
Stainless Steel - Difficult to Machine 302B, 304B, 309, 310, 316, 316B, 316L, 316Ti, 317, 317L, 321	M	up to 28 Rc	●	x	○	70	65	60	.0050	.0100	.0200	.0300	.0350	.0450	.0550	.0650	.0950
Stainless Steel - Difficult to Machine 17-4 PH, PH13-8Mo, Nitronics	M	over 28 Rc	●	x	○	40	35	30	.0070	.0120	.0150	.0200	.0250	.0300	.0400	.0500	.0620
Cobalt Chrome Alloys	M	over 28 Rc	●	x	○	45	40	40	.0070	.0120	.0150	.0200	.0250	.0300	.0400	.0500	.0620
Duplex (22%)	M	over 28 Rc	●	x	○	45	40	40	.0070	.0120	.0150	.0200	.0250	.0300	.0400	.0500	.0620
Super Duplex (25%)	M	over 28 Rc	●	x	○	40	35	30	.0070	.0120	.0150	.0200	.0250	.0300	.0400	.0500	.0620
High Temp Alloys	S	up to 42 Rc	●	x	x	30	25	25	.0070	.0120	.0150	.0200	.0250	.0300	.0400	.0500	.0620
Inconel	S	up to 42 Rc	●	x	x	30	25	25	.0070	.0120	.0150	.0200	.0250	.0300	.0400	.0500	.0620
Titanium Alloys 6Al-4V, 5Al-2.5 Sn, 6Al-2 Sn-4Zr-6Mo, 3Al-8V-6Cr4Mo-4Zr, 10V-2Fe-3Al, 13V-11Cr-3Al	S	up to 42 Rc	●	x	x	55	55	50	.0070	.0120	.0150	.0200	.0250	.0300	.0400	.0500	.0620
Cast-Iron - Gray CG, ASTM A48, CLASS 20, 25, 30, 35, SAE J431C, GRADES G1800, G3000, G3500, GG 10, 15, 20, 25, 30, 35, 40	K	up to 240 HB	●	○	○	115	105	100	.0100	.0250	.0300	.0400	.0500	.0600	.0800	.1000	.1250
Cast Iron - Ductile & Malleable CGI 60-40-18, 65-45-12, D4018, D4512, D5506, 32510, 35108, M3210, M4504, M5503, 250, 300, 350, 400, 450	K	over 240 HB	●	○	○	85	80	75	.0100	.0250	.0300	.0400	.0500	.0600	.0800	.1000	.1250

**Spindle Maximum - Should the calculated spindle speed be more than your actual spindle maximum, use this formula:
(Calculated Feed x Spindle Maximum)/Calculated Speed**





TuffCut® AL / X-AL

136 / 138 / 138N / 138R / 138NR Recommended Cutting Data - Profile Milling Inch

Workpiece Material Group	ISO	Coolant ● Preferred	Profile Milling (ae)				End Mill Diameter								
							1/8*	3/16*	1/4*	5/16	3/8	1/2	5/8	3/4	1
			10%	20%	30%	50%	ae > .3D use <1D ap ae < .2D use <2D ap *Profile Milling at > 25% ap is not recommended for diameters 1/4" and below.								
				3.8	3.1	2	1	← Multiply fz by this Factor based on ae. When finishing, use the standard fz per chart below. Only add chip thinning when roughing or semi-finishing.							
Max.	vc - SFM				fz - in/tooth										
Non-Ferrous - Aluminum / Aluminum Alloys < 10% Si	N	●	2000	1800	1200	900	.0025	.0037	.0050	.0062	.0075	.0100	.0125	.0150	.0200
Non-Ferrous - Aluminum / Aluminum Alloys > 10% Si	N	●	1500	1200	1000	800	.0025	.0037	.0050	.0062	.0075	.0100	.0125	.0150	.0200
Non-Ferrous - Brass	N	●	900	800	600	500	.0025	.0037	.0050	.0062	.0075	.0100	.0125	.0150	.0200
Non-Ferrous - Cu/Cu Alloys / Magnesium	N	●	1000	800	600	500	.0025	.0037	.0050	.0062	.0075	.0100	.0125	.0150	.0200
Non-Ferrous - Plastics	N	●	900	800	600	500	.0025	.0037	.0050	.0062	.0075	.0100	.0125	.0150	.0200

Above 20,000 RPM, Tool Balancing Required

136 / 138 / 138N / 138R / 138NR Recommended Cutting Data - Profile Milling Metric

Workpiece Material Group	ISO	Coolant ● Preferred	Profile Milling (ae)				End Mill Diameter (mm)						
							3*	5*	6*	8	10	14	16
			10%	20%	30%	50%	ae > .3D use <1D ap ae < .2D use <2D ap *Profile Milling at > 25% ap is not recommended for diameters 6mm and below.						
				3.8	3.1	2	1	← Multiply fz by this Factor based on ae. When finishing, use the standard fz per chart below. Only add chip thinning when roughing or semi-finishing.					
Max.	vc - m/min				fz - mm/tooth								
Non-Ferrous - Aluminum / Aluminum Alloys < 10% Si	N	●	600	550	365	275	.0600	.1000	.1200	.1600	.2000	.2800	.3200
Non-Ferrous - Aluminum / Aluminum Alloys > 10% Si	N	●	450	365	305	250	.0600	.1000	.1200	.1600	.2000	.2800	.3200
Non-Ferrous - Brass	N	●	275	250	180	150	.0600	.1000	.1200	.1600	.2000	.2800	.3200
Non-Ferrous - Cu/Cu Alloys / Magnesium	N	●	300	250	180	150	.0600	.1000	.1200	.1600	.2000	.2800	.3200
Non-Ferrous - Plastics	N	●	275	250	180	150	.0600	.1000	.1200	.1600	.2000	.2800	.3200





Above 20,000 RPM, Tool Balancing Required

Spindle Maximum - Should the calculated spindle speed be more than your actual spindle maximum, use this formula:
(Calculated Feed x Spindle Maximum)/Calculated Speed

Technical data provided should be considered advisory only as variations may be necessary depending on the particular application.





TuffCut® AL / X-AL

136 / 138 / 138N / 138R / 138NR Recommended Cutting Data - Slotting Inch

Workpiece Material Group	ISO	Coolant • Preferred	Slotting			End Mill Diameter								
						1/8*	3/16*	1/4*	5/16	3/8	1/2	5/8	3/4	1
			25%	50%	100%	*Slotting at > 25% ap is not recommended for diameters 1/4" and below.								
		Max.	vc - SFM			fz - in/tooth								
Non-Ferrous - Aluminum / Aluminum Alloys < 10% Si	N	•	2000	1500	1000	.0012	.0018	.0025	.0032	.0037	.0050	.0065	.0075	.0100
Non-Ferrous - Aluminum / Aluminum Alloys > 10% Si	N	•	1500	1200	800	.0012	.0018	.0025	.0032	.0037	.0050	.0065	.0075	.0100
Non-Ferrous - Brass	N	•	600	500	400	.0018	.0025	.0032	.0037	.0050	.0065	.0075	.0100	.0120
Non-Ferrous - Cu/Cu Alloys / Magnesium	N	•	500	400	300	.0018	.0025	.0032	.0037	.0050	.0065	.0075	.0100	.0120
Non-Ferrous - Plastics	N	•	1200	1000	800	.0018	.0025	.0032	.0037	.0050	.0065	.0075	.0100	.0120

Above 20,000 RPM, Tool Balancing Required

136 / 138 / 138N / 138R / 138NR Recommended Cutting Data - Slotting Metric

Workpiece Material Group	ISO	Coolant • Preferred	Slotting			End Mill Diameter (mm)							
						3*	5*	6*	8	10	14	16	20
			25%	50%	100%	*Slotting at > 25% ap is not recommended for diameters 6mm and below.							
		Max.	vc - m/min			fz - mm/tooth							
Non-Ferrous - Aluminum / Aluminum Alloys < 10% Si	N	•	600	450	300	.0300	.0450	.0630	.0810	.0930	.1270	.1650	.1900
Non-Ferrous - Aluminum / Aluminum Alloys > 10% Si	N	•	450	365	250	.0300	.0450	.0630	.0810	.0930	.1270	.1650	.1900
Non-Ferrous - Brass	N	•	180	150	120	.0450	.0630	.0810	.0930	.1270	.1650	.1900	.2540
Non-Ferrous - Cu/Cu Alloys / Magnesium	N	•	150	120	90	.0450	.0630	.0810	.0930	.1270	.1650	.1900	.2540
Non-Ferrous - Plastics	N	•	365	300	250	.0450	.0630	.0810	.0930	.1270	.1650	.1900	.2540

Above 20,000 RPM, Tool Balancing Required

Spindle Maximum - Should the calculated spindle speed be more than your actual spindle maximum, use this formula:



$$\frac{\text{Calculated Feed} \times \text{Spindle Maximum}}{\text{Calculated Speed}}$$

Technical data provided should be considered advisory only as variations may be necessary depending on the particular application.

For product information, call your local distributor.





TuffCut® AL / X-AL

134 / 134N / 134S / 135 / 135N Recommended Cutting Data - Profile Milling Inch

Workpiece Material Group	ISO	Coolant • Preferred	Profile Milling (ae)				End Mill Diameter							
							3/16*	1/4*	5/16	3/8	1/2	5/8	3/4	1
			10%	20%	30%	50%	ae > .3D use < 1D ap ae < .2D use < 2D ap *Profile Milling at > 25% ap is not recommended for diameters 1/4" and below.							
				3.8	3.1	2	1	← Multiply fz by this Factor based on ae. When finishing, use the standard fz per chart below. Only add chip thinning when roughing or semi-finishing.						
Max.	vc - SFM				fz - in/tooth									
Non-Ferrous - Aluminum / Aluminum Alloys < 10% Si	N	•	2000	1800	1200	900	.0018	.0025	.0032	.0037	.0050	.0065	.0075	.0100
Non-Ferrous - Aluminum / Aluminum Alloys > 10% Si	N	•	1500	1200	1000	800	.0018	.0025	.0032	.0037	.0050	.0065	.0075	.0100
Non-Ferrous - Brass	N	•	900	800	600	500	.0025	.0032	.0037	.0050	.0065	.0075	.0100	.0120
Non-Ferrous - Cu/Cu Alloys / Magnesium	N	•	1000	800	600	500	.0025	.0032	.0037	.0050	.0065	.0075	.0100	.0120
Non-Ferrous - Plastics	N	•	900	800	600	500	.0025	.0032	.0037	.0050	.0065	.0075	.0100	.0120

Above 20,000 RPM, Tool Balancing Required

134 / 134N / 134S / 135 / 135N Recommended Cutting Data - Profile Milling Metric

Workpiece Material Group	ISO	Coolant • Preferred	Profile Milling (ae)				End Mill Diameter (mm)								
							3*	5*	6*	8	10	14	16	18	25
			10%	20%	30%	50%	ae > .3D use < 1D ap ae < .2D use < 2D ap *Profile Milling at > 25% ap is not recommended for diameters 6mm and below.								
				3.8	3.1	2	1	← Multiply fz by this Factor based on ae. When finishing, use the standard fz per chart below. Only add chip thinning when roughing or semi-finishing.							
Max.	vc - m/min				fz - mm/tooth										
Non-Ferrous - Aluminum / Aluminum Alloys < 10% Si	N	•	600	550	365	275	.030	.045	.063	.081	.093	.127	.165	.190	.254
Non-Ferrous - Aluminum / Aluminum Alloys > 10% Si	N	•	450	365	305	250	.030	.045	.063	.081	.093	.127	.165	.190	.254
Non-Ferrous - Brass	N	•	275	250	180	150	.045	.063	.081	.093	.127	.165	.190	.254	.304
Non-Ferrous - Cu/Cu Alloys / Magnesium	N	•	300	250	180	150	.045	.063	.081	.093	.127	.165	.190	.254	.304
Non-Ferrous - Plastics	N	•	275	250	180	150	.045	.063	.081	.093	.127	.165	.190	.254	.304

Above 20,000 RPM, Tool Balancing Required

Spindle Maximum - Should the calculated spindle speed be more than your actual spindle maximum, use this formula:

$$\frac{\text{Calculated Feed} \times \text{Spindle Maximum}}{\text{Calculated Speed}}$$

Technical data provided should be considered advisory only as variations may be necessary depending on the particular application.

TuffCut® AL / X-AL

134 / 134N / 134S / 135 / 135N Recommended Cutting Data - Slotting Inch

Workpiece Material Group	ISO	Coolant • Preferred	Slotting			End Mill Diameter							
			25%	50%	100%	3/16*	1/4*	5/16	3/8	1/2	5/8	3/4	1
						*Slotting at > 25% ap is not recommended for diameters 1/4" and below.							
						Max.	vc - SFM			fz - in/tooth			
Non-Ferrous - Aluminum / Aluminum Alloys < 10% Si	N	•	2000	1500	1000	.004-.006	.004-.008	.006-.009	.007-.012	.010-.045	.015-.045	.015-.045	.015-.040
Non-Ferrous - Aluminum / Aluminum Alloys > 10% Si	N	•	1500	1200	800	.004-.006	.004-.008	.006-.009	.007-.012	.010-.045	.015-.045	.015-.045	.015-.040
Non-Ferrous - Brass	N	•	600	500	400	.004-.006	.004-.008	.006-.009	.007-.012	.010-.045	.015-.045	.015-.045	.015-.040
Non-Ferrous - Cu/Cu Alloys / Magnesium	N	•	500	400	300	.0025	.0032	.0037	.0050	.0065	.0075	.0100	.0120
Non-Ferrous - Plastics	N	•	1200	1000	800	.004-.006	.004-.008	.006-.009	.007-.012	.010-.045	.015-.045	.015-.045	.015-.040

Above 20,000 RPM, Tool Balancing Required

134 / 134N / 134S / 135 / 135N Recommended Cutting Data - Slotting Metric

Workpiece Material Group	ISO	Coolant • Preferred	Slotting			End Mill Diameter (mm)								
			25%	50%	100%	3*	5*	6*	8	10	14	16	20	25
						*Slotting at > 25% ap is not recommended for diameters 6mm and below.								
						Max.	vc - m/min			fz - mm/tooth				
Non-Ferrous - Aluminum / Aluminum Alloys < 10% Si	N	•	600	450	300	.076-.101	.101-.152	.101-.203	.152-.203	.177-.304	.254-1.143	.381-1.016	.381-1.016	.381-1.016
Non-Ferrous - Aluminum / Aluminum Alloys > 10% Si	N	•	450	365	250	.076-.101	.101-.152	.101-.203	.152-.203	.177-.304	.254-1.143	.381-1.016	.381-1.016	.381-1.016
Non-Ferrous - Brass	N	•	180	150	120	.076-.101	.101-.152	.101-.203	.152-.203	.177-.304	.254-1.143	.381-1.016	.381-1.016	.381-1.016
Non-Ferrous - Cu / Cu Alloys / Magnesium	N	•	150	120	90	.045	.063	.076	.093	.127	.165	.190	.254	.304
Non-Ferrous - Plastics	N	•	365	300	250	.076-.101	.101-.152	.101-.203	.152-.203	.177-.304	.254-1.143	.381-1.016	.381-1.016	.381-1.016

Above 20,000 RPM, Tool Balancing Required

Spindle Maximum - Should the calculated spindle speed be more than your actual spindle maximum, use this formula:

$$\frac{\text{Calculated Feed} \times \text{Spindle Maximum}}{\text{Calculated Speed}}$$





Technical data provided should be considered advisory only as variations may be necessary depending on the particular application.

For product information, call your local distributor.

TuffCut® AL / X-AL

135B / 135BN / 138B / 138BN Recommended Cutting Data - Profile Milling





Inch If axial depth (ap) is less than the ball diameter, the speed is figured using the effective cutting diameter.

Workpiece Material Group	ISO	Coolant • Preferred	Profile Milling (ae)				End Mill Diameter								
							1/8*	3/16*	1/4*	5/16	3/8	1/2	5/8	3/4	1
			10%	20%	30%	50%	ae > .3D use <1D ap ae < .2D use <2D ap *Profile Milling at > 25% ap is not recommended for diameters 1/4" and below.								
				3.8	3.1	2	1	← Multiply fz by this Factor based on ae. When finishing, use the standard fz per chart below. Only add chip thinning when roughing or semi-finishing.							
Max.	vc - SFM				fz - in/tooth										
Non-Ferrous - Aluminum / Aluminum Alloys < 10% Si	N	•	2000	1800	1200	900	.0010	.0018	.0025	.0030	.0037	.0050	.0065	.0075	.0100
Non-Ferrous Aluminum / Aluminum Alloys > 10% Si	N	•	1500	1200	1000	800	.0010	.0018	.0025	.0030	.0037	.0050	.0065	.0075	.0100
Non-Ferrous - Brass	N	•	900	800	600	500	.0015	.0025	.0032	.0040	.0050	.0060	.0075	.0100	.0120
Non-Ferrous - Cu/Cu Alloys / Magnesium	N	•	1000	800	600	500	.0015	.0025	.0032	.0040	.0050	.0060	.0075	.0100	.0120
Non-Ferrous - Plastics	N	•	900	800	600	500	.0015	.0025	.0032	.0040	.0050	.0060	.0075	.0100	.0120

Above 20,000 RPM, Tool Balancing Required

135B / 135BN / 138B / 138BN Recommended Cutting Data - Profile Milling

Metric If axial depth (ap) is less than the ball diameter, the speed is figured using the effective cutting diameter.

Workpiece Material Group	ISO	Coolant • Preferred	Profile Milling (ae)				End Mill Diameter (mm)						
							3*	5*	6*	8	10	14	16
			10%	20%	30%	50%	ae > .3D use <1D ap ae < .2D use <2D ap *Profile Milling at > 25% ap is not recommended for diameters 6mm and below.						
				3.8	3.1	2	1	← Multiply fz by this Factor based on ae. When finishing, use the standard fz per chart below. Only add chip thinning when roughing or semi-finishing.					
Max.	vc - m/min				fz - mm/tooth								
Non-Ferrous - Aluminum / Aluminum Alloys < 10% Si	N	•	600	550	365	275	.0300	.0450	.0630	.0810	.0930	.1270	.1650
Non-Ferrous Aluminum / Aluminum Alloys > 10% Si	N	•	450	365	305	250	.0300	.0450	.0630	.0810	.0930	.1270	.1650
Non-Ferrous - Brass	N	•	275	250	180	150	.0450	.0630	.0810	.0810	.1270	.1650	.1900
Non-Ferrous - Cu/Cu Alloys / Magnesium	N	•	300	250	180	150	.0450	.0630	.0810	.0810	.1270	.1650	.1900
Non-Ferrous - Plastics	N	•	275	250	180	150	.0450	.0630	.0810	.0810	0.1270	.1650	.1900

Above 20,000 RPM, Tool Balancing Required





Spindle Maximum - Should the calculated spindle speed be more than your actual spindle maximum, use this formula:
 (Calculated Feed x Spindle Maximum)/Calculated Speed

Technical data provided should be considered advisory only as variations may be necessary depending on the particular application.

TuffCut® AL / X-AL

135B / 135BN / 138B / 138BN Recommended Cutting Data - Slotting

Inch If axial depth (ap) is less than the ball diameter, the speed is figured using the effective cutting diameter.

Workpiece Material Group	ISO	Coolant • Preferred	Slotting			End Mill Diameter								
						1/8*	3/16*	1/4*	5/16	3/8	1/2	5/8	3/4	1
			25%	50%	100%	*Slotting at > 25% ap is not recommended for diameters 1/4" and below.								
		Max.	vc - SFM			fz - in/tooth								
Non-Ferrous - Aluminum / Aluminum Alloys < 10% Si	N	•	2000	1500	1000	.001-.002	.004-.006	.004-.008	.005-.009	.007-.012	.010-.020	.015-.020	.015-.020	.015-.020
Non-Ferrous - Aluminum / Aluminum Alloys > 10% Si	N	•	1500	1200	800	.001-.002	.004-.006	.004-.008	.005-.009	.007-.012	.010-.020	.015-.020	.015-.020	.015-.020
Non-Ferrous - Brass	N	•	600	500	400	.001-.002	.004-.006	.004-.008	.005-.009	.007-.012	.010-.020	.015-.020	.015-.020	.015-.020
Non-Ferrous - Cu/Cu Alloys / Magnesium	N	•	500	400	300	.001-.002	.004-.006	.004-.008	.005-.009	.007-.012	.010-.020	.015-.020	.015-.020	.015-.020
Non-Ferrous/Plastics		•	1200	1000	800	.001-.002	.004-.006	.004-.008	.005-.009	.007-.012	.010-.020	.015-.020	.015-.020	.015-.020

Above 20,000 RPM, Tool Balancing Required

135B / 135BN / 138B / 138BN Recommended Cutting Data - Slotting

Metric If axial depth (ap) is less than the ball diameter, the speed is figured using the effective cutting diameter.

Workpiece Material Group	ISO	Coolant • Preferred	Slotting			End Mill Diameter (mm)						
						3*	5*	6*	8	10	14	16
			25%	50%	100%	*Slotting at > 25% ap is not recommended for diameters 6mm and below.						
		Max.	vc - m/min			fz - mm/tooth						
Non-Ferrous - Aluminum / Aluminum Alloys < 10% Si	N	•	600	450	300	.076-.101	.101-.152	.101-.203	.152-.203	.177-.304	.254-.508	.381-.508
Non-Ferrous - Aluminum / Aluminum Alloys > 10% Si	N	•	450	365	250	.076-.101	.101-.152	.101-.203	.152-.203	.177-.304	.254-.508	.381-.508
Non-Ferrous - Brass	N	•	180	150	120	.076-.101	.101-.152	.101-.203	.152-.203	.177-.304	.254-.508	.381-.508
Non-Ferrous - Cu/Cu Alloys / Magnesium	N	•	150	120	90	.076-.101	.101-.152	.101-.203	.152-.203	.177-.304	.254-.508	.381-.508
Non-Ferrous - Plastics		•	365	300	250	.076-.101	.101-.152	.101-.203	.152-.203	.177-.304	.254-.508	.381-.508





Above 20,000 RPM, Tool Balancing Required

Spindle Maximum - Should the calculated spindle speed be more than your actual spindle maximum, use this formula:

$$\frac{(\text{Calculated Feed} \times \text{Spindle Maximum})}{\text{Calculated Speed}}$$





TuffCut® X-AL

138CE Recommended Cutting Data - Profile Milling Inch

Workpiece Material Group	ISO	Coolant Preferred	Profile Milling (ae)				End Mill Diameter								
							1/8*	3/16*	1/4*	5/16	3/8	1/2	5/8	3/4	1
			10%	20%	30%	50%	ae > .30D use < 1D ap ae < .20D use < 2D ap *Profile Milling at > 25% ap is not recommended for Diameters 1/4" and below.								
			3.8	3.1	2	1	← Multiply fz by this Factor based on ae. When finishing, use the standard fz per chart below. Only add chip thinning when roughing or semi-finishing.								
Max.	vc - SFM				fz - in/tooth										
Non-Ferrous - Aluminum / Aluminum Alloys < 10% Si	N	•	2000	1800	1200	900	.0025	.0037	.0050	.0062	.0075	.0100	.0125	.0150	.0200
Non-Ferrous - Aluminum / Aluminum Alloys > 10% Si	N	•	1500	1200	1000	800	.0025	.0037	.0050	.0062	.0075	.0100	.0125	.0150	.0200
Non-Ferrous - Brass	N	•	900	800	600	500	.0025	.0037	.0050	.0062	.0075	.0100	.0125	.0150	.0200
Non-Ferrous - Cu/Cu Alloys / Magnesium	N	•	1000	800	600	500	.0025	.0037	.0050	.0062	.0075	.0100	.0125	.0150	.0200
Non-Ferrous - Plastics	N	•	900	800	600	500	.0025	.0037	.0050	.0062	.0075	.0100	.0125	.0150	.0200

Above 20,000 RPM, Tool Balancing Required

138CE Recommended Cutting Data - Profile Milling Metric

Workpiece Material Group	ISO	Coolant Preferred	Profile Milling (ae)				End Mill Diameter (mm)				
							6*	8	10	14	16
			10%	20%	30%	50%	ae > .30D use < 1D ap ae < .20D use < 2D ap *Profile milling at > 25% ap is not recommended for Diameters 6mm and below.				
			3.8	3.1	2	1	← Multiply fz by this Factor based on ae. When finishing, use the standard fz per chart below. Only add chip thinning when roughing or semi-finishing.				
Max.	vc - m/min				fz - mm/tooth						
Non-Ferrous - Aluminum / Aluminum Alloys < 10% Si	N	•	600	550	365	275	.1200	.1600	.2000	.2800	.3200
Non-Ferrous - Aluminum / Aluminum Alloys > 10% Si	N	•	450	365	305	250	.1200	.1600	.2000	.2800	.3200
Non-Ferrous - Brass	N	•	275	250	180	150	.1200	.1600	.2000	.2800	.3200
Non-Ferrous - Cu/Cu Alloys / Magnesium	N	•	300	250	180	150	.1200	.1600	.2000	.2800	.3200
Non-Ferrous - Plastics	N	•	275	250	180	150	.1200	.1600	.2000	.2800	.3200





Above 20,000 RPM, Tool Balancing Required

Spindle Maximum - Should the calculated spindle speed be more than your actual spindle maximum, use this formula:

$$\frac{\text{Calculated Feed} \times \text{Spindle Maximum}}{\text{Calculated Speed}}$$



TuffCut® X-AL

138CE Recommended Cutting Data - Slotting Inch

Workpiece Material Group	I S O	Coolant • Preferred 	Slotting			End Mill Diameter								
						1/8*	3/16*	1/4*	5/16	3/8	1/2	5/8	3/4	1
			25%	50%	100%	*Slotting at > 25% ap is not recommended for diameters 1/4" and below.								
			Max.	vc - SFM			fz - in/tooth							
Non-Ferrous - Aluminum / Aluminum Alloys < 10% Si	N	•	2000	1500	1000	.0012	.0018	.0025	.0031	.0037	.0050	.0065	.0075	.0100
Non-Ferrous - Aluminum / Aluminum Alloys > 10% Si	N	•	1500	1200	800	.0012	.0018	.0025	.0031	.0037	.0050	.0065	.0075	.0100
Non-Ferrous - Brass	N	•	600	500	400	.0018	.0025	.0032	.0040	.0050	.0065	.0075	.0100	.0120
Non-Ferrous - Cu/Cu Alloys / Magnesium	N	•	500	400	300	.0018	.0025	.0032	.0040	.0050	.0065	.0075	.0100	.0120
Non-Ferrous - Plastics	N	•	1200	1000	800	.0018	.0025	.0032	.0040	.0050	.0065	.0075	.0100	.0120

Above 20,000 RPM, Tool Balancing Required

138CE Recommended Cutting Data - Slotting Metric

Workpiece Material Group	I S O	Coolant • Preferred 	Slotting			End Mill Diameter (mm)					
						6*	8	10	14	16	20
			25%	50%	100%	*Slotting at > 25% ap is not recommended for diameters 6mm and below.					
			Max.	vc - m/min			fz - mm/tooth				
Non-Ferrous - Aluminum / Aluminum Alloys < 10% Si	N	•	600	450	300	.0630	.0780	.0930	.1270	.1650	.1900
Non-Ferrous - Aluminum / Aluminum Alloys > 10% Si	N	•	450	365	250	.0630	.0780	.0930	.1270	.1650	.1900
Non-Ferrous - Brass	N	•	180	150	120	.0810	.1010	.1270	.1650	.1900	.2540
Non-Ferrous - Cu/Cu Alloys / Magnesium	N	•	150	120	90	.0810	.1010	.1270	.1650	.1900	.2540
Non-Ferrous - Plastics	N	•	365	300	250	.0810	.1010	.1270	.1650	.1900	.2540



Above 20,000 RPM, Tool Balancing Required



Spindle Maximum - Should the calculated spindle speed be more than your actual spindle maximum, use this formula:

$$\frac{\text{Calculated Feed} \times \text{Spindle Maximum}}{\text{Calculated Speed}}$$

156 Recommended Cutting Data - Contouring

Inch If axial depth (ap) is less than the ball diameter, the speed is figured using the effective cutting diameter.

Workpiece Material Group	I S O	Hardness	Coolant ● Preferred ○ Possible x Not Possible			End Mill Diameter											
						1/32		1/16		3/32		1/8		5/32		1/4	
			Max.	Air	MMS	RPM (n)	IPM (vf)	RPM (n)	IPM (vf)	RPM (n)	IPM (vf)	RPM (n)	IPM (vf)	RPM (n)	IPM (vf)	RPM (n)	IPM (vf)
Tool Steels & Die Steels O7, M1, M2, M3, M4, M7, T1, T2, T4, T5, T8, T15, A2, A3, A6, A7, H10, H11, H12, H13, H19, H21, L3, L6, L7, P2, P20, S1, S5, S7, S2100, A128, D2, D3, D4, D5, D7	P	28 to 44 Rc	●	●	●	30000	26.9	30000	62	25000	84	17500	95	14000	120	8750	140
Hardened Steels	H	40-45 Rc	●	○	○	30000	24	23500	57	22000	96	14500	90	11500	90	72500	70
Hardened Steels		46-55 Rc	●	○	○	30000	18	23500	37	20000	35	12000	35	9600	37	6000	38
Hardened Steels		55-60 Rc	●	○	○	30000	15	15000	15	10000	15	7000	15	5600	20	3500	18
Stainless Steel - Ferritic / Martensitic / PH	M	over 28 Rc	●	x	○	30000	26	30000	62	25000	85	17500	95	14000	120	8750	140

Workpiece Material Group	I S O	Hardness	Coolant ● Preferred ○ Possible x Not Possible			End Mill Diameter					
						5/16		3/8		1/2	
			Max.	Air	MMS	RPM (n)	IPM (vf)	RPM (n)	IPM (vf)	RPM (n)	IPM (vf)
Tool Steels & Die Steels O7, M1, M2, M3, M4, M7, T1, T2, T4, T5, T8, T15, A2, A3, A6, A7, H10, H11, H12, H13, H19, H21, L3, L6, L7, P2, P20, S1, S5, S7, S2100, A128, D2, D3, D4, D5, D7	P	28 to 44 Rc	●	●	●	7000	168	5800	125	4300	140
Hardened Steels	H	40-45 Rc	●	○	○	5800	68	4800	50	3625	45
Hardened Steels		46-55 Rc	●	○	○	4800	35	4000	30	3000	25
Hardened Steels		55-60 Rc	●	○	○	2800	15	2300	15	1750	10
Stainless Steel - Ferritic / Martensitic / PH	M	over 28 Rc	●	x	○	7000	170	5800	125	4300	140

Axial & Radial Depth - Roughing / Semi Finishing

30 - 40 Rc 10% of Diameter ap
 40 - 50 Rc 5% of Diameter ap
 50 - 60 Rc 4% of Diameter ap
 Radial Step Over 25%-40% of Diameter

Axial & Radial Depth - Finishing

< 40 Rc 3% of Diameter ap
 40 - 50 Rc 2% of Diameter ap
 50 - 60 Rc 1% of Diameter ap
 ae (step over) depends on finish requirement of the part.

156 Recommended Cutting Data - Contouring

Metric If axial depth (ap) is less than the ball diameter, the speed is figured using the effective cutting diameter.

Workpiece Material Group	ISO	Hardness	Coolant			End Mill Diameter (mm)											
			• Preferred ○ Possible x Not Possible			0.5		1.0		1.5		2.0		3.0		4.0	
			Max.	Air	MMS	RPM (n)	mm/min (vf)	RPM (n)	mm/min (vf)	RPM (n)	mm/min (vf)	RPM (n)	mm/min (vf)	RPM (n)	mm/min (vf)	RPM (n)	mm/min (vf)
Tool Steels & Die Steels O7, M1, M2, M3, M4, M7, T1, T2, T4, T5, T8, T15, A2, A3, A6, A7, H10, H11, H12, H13, H19, H21, L3, L6, L7, P2, P20, S1, S5, S7, 52100, A128, D2, D3, D4, D5, D7	P	28 to 44 Rc	•	•	•	30000	508	30000	683	25000	1575	17500	2133	14000	2392	8750	3050
Hardened Steels	H	40-45 Rc	•	○	○	30000	508	30000	608	23500	1450	22000	2442	14500	2283	11500	2233
Hardened Steels		46-55 Rc	•	○	○	30000	308	30000	458	23500	942	20000	892	12000	892	9600	942
Hardened Steels		55-60 Rc	•	○	○	30000	250	30000	383	15000	383	10000	383	7000	383	5600	508
Stainless Steel - Ferritic / Martensitic / PH	M	over 28 Rc	•	x	○	30000	508	30000	683	30000	1575	25000	2133	17500	2392	14000	3050

Workpiece Material Group	ISO	Hardness	Coolant			End Mill Diameter (mm)							
			• Preferred ○ Possible x Not Possible			6.0		8.0		10.0		12.0	
			Max.	Air	MMS	RPM (n)	mm/min (vf)	RPM (n)	mm/min (vf)	RPM (n)	mm/min (vf)	RPM (n)	mm/min (vf)
Tool Steels & Die Steels O7, M1, M2, M3, M4, M7, T1, T2, T4, T5, T8, T15, A2, A3, A6, A7, H10, H11, H12, H13, H19, H21, L3, L6, L7, P2, P20, S1, S5, S7, 52100, A128, D2, D3, D4, D5, D7	P	28 to 44 Rc	•	•	•	7000	3558	5800	4267	4300	3175	4300	3558
Hardened Steels	H	40-45 Rc	•	○	○	7250	1775	5800	1725	4800	1292	3625	1167
Hardened Steels		46-55 Rc	•	○	○	6000	967	4800	892	4000	758	3000	633
Hardened Steels		55-60 Rc	•	○	○	3500	458	2800	383	2300	383	1750	250
Stainless Steel - Ferritic / Martensitic / PH	M	over 28 Rc	•	x	○	8750	3558	7000	4267	5800	3175	4300	3558

Axial & Radial Depth - Roughing / Semi Finishing

30 - 40 Rc 10% of Diameter ap
 40 - 50 Rc 5% of Diameter ap
 50 - 60 Rc 4% of Diameter ap
 Radial Step Over 25%-40% of Diameter

Axial & Radial Depth - Finishing

< 40 Rc 3% of Diameter ap
 40 - 50 Rc 2% of Diameter ap
 50 - 60 Rc 1% of Diameter ap
 ae (step over) depends on finish requirement of the part.

158 Recommended Cutting Data - Cutting Conditions - Lower RPM (n) / High Feed (vf) Inch

Workpiece Material Group	Examples	Coolant ● Preferred ○ Possible x Not Possible			Tool Overhang	End Mill Diameter																
		Max.	Air	MMS		.1181 X R .0315 (3.0 x R 0.8mm)				.2362 X R .059 (6.0 x R 1.5mm)				.315 X R .0787 (8.0 x R 2.0mm)				.3937 X R .0787 (10.0 x R 2.0mm)				
						Axial Depth (ap)	Radial Depth (ae)	RPM (n)	IPM (vf)	Axial Depth (ap)	Radial Depth (ae)	RPM (n)	IPM (vf)	Axial Depth (ap)	Radial Depth (ae)	RPM (n)	IPM (vf)	Axial Depth (ap)	Radial Depth (ae)	RPM (n)	IPM (vf)	
Steels	P	Cast Iron/ Carbon Steels/ Alloy Steels 150-250 HB	●	●	●	5 x D	.0094	.0275	8,000	239	.0170	.0590	4,000	264	.0236	.0787	3,000	264	.0236	.1180	2,400	264
						6 X D	.0085	.0275			.0159	.0590			.0210	.0787			.0212	.1180		
						7 X D	.0078	.0275			.0147	.0590			.0196	.0787			.0196	.1180		
						8 X D	.0072	.0275			.0135	.0590			.0181	.0787			.0181	.1180		
						9 X D	.0059	.0275			.0112	.0590			.0149	.0787			.0149	.1180		
						10 X D	.0047	.0275			.0088	.0590			.0118	.0787			.0118	.1180		
Steels	P	Tool Steels 25-35 Rc	●	●	●	5 x D	.0094	.0275	7,400	200	.0170	.0590	3,700	224	.0236	.0787	2,800	225	.0236	.1180	2,200	222
						6 X D	.0085	.0275			.0159	.0590			.0210	.0787			.0212	.1180		
						7 X D	.0078	.0275			.0147	.0590			.0196	.0787			.0196	.1180		
						8 X D	.0072	.0275			.0135	.0590			.0181	.0787			.0181	.1180		
						9 X D	.0059	.0275			.0112	.0590			.0149	.0787			.0149	.1180		
						10 X D	.0047	.0275			.0088	.0590			.0118	.0787			.0118	.1180		
Hardened Steels	H	35-45 Rc H13/D2 P20/4140 8620	●	○	○	5 x D	.0094	.0275	6,900	146	.0170	.0590	3,400	160	.0236	.0787	2,600	164	.0236	.1180	2,100	165
						6 X D	.0085	.0275			.0159	.0590			.0210	.0787			.0212	.1180		
						7 X D	.0078	.0275			.0147	.0590			.0196	.0787			.0196	.1180		
						8 X D	.0072	.0275			.0135	.0590			.0181	.0787			.0181	.1180		
						9 X D	.0059	.0275			.0112	.0590			.0149	.0787			.0149	.1180		
						10 X D	.0047	.0275			.0088	.0590			.0118	.0787			.0118	.1180		
Hardened Steels	H	45 - 55 Rc H13/D2 P20/4140 8620	●	○	○	5 x D	.0066	.0275	5,300	112	.0124	.0590	2,700	127	.0165	.0787	2,000	125	.0165	.1180	1,600	125
						6 X D	.0059	.0275			.0111	.0590			.0148	.0787			.0148	.1180		
						7 X D	.0055	.0275			.0103	.0590			.0137	.0787			.0137	.1180		
						8 X D	.0050	.0275			.0095	.0590			.0126	.0787			.0126	.1180		
						9 X D	.0041	.0275			.0078	.0590			.0104	.0787			.0104	.1180		
						10 X D	.0033	.0275			.0062	.0590			.0082	.0787			.0082	.1180		
Hardened Steels	H	55-60 Rc H13/D2 P20/4140 8620	●	○	○	5 x D	.0047	.0275	5,300	45	.0088	.0590	2,700	50	.0118	.0787	2,000	50	.0118	.1180	1,600	50
						6 X D	.0042	.0275			.0079	.0590			.0106	.0787			.0106	.1180		
						7 X D	.0039	.0275			.0073	.0590			.0098	.0787			.0098	.1180		
						8 X D	.0036	.0275			.0067	.0590			.0090	.0787			.0090	.1180		
						9 X D	.0029	.0275			.0056	.0590			.0074	.0787			.0074	.1180		
						10 X D	.0023	.0275			.0044	.0590			.0059	.0787			.0059	.1180		

Technical data provided should be considered advisory only as variations may be necessary depending on the particular application.

158 Recommended Cutting Data - Cutting Conditions - Lower RPM (n) / High Feed (vf) Inch Continued



Workpiece Material Group	Examples	Coolant ● Preferred ○ Possible x Not Possible			Tool Overhang	End Mill Diameter											
		Max.	Air	MMS		.4724 x R .0787 (12.0 x R 2.0mm)				.6299 X R .1181 (16.0 x R 3.0mm)				.7874 X R .1181 (20.0 x R 3.0mm)			
						Axial Depth (ap)	Radial Depth (ae)	RPM (n)	IPM (vf)	Axial Depth (ap)	Radial Depth (ae)	RPM (n)	IPM (vf)	Axial Depth (ap)	Radial Depth (ae)	RPM (n)	IPM (vf)
Steels	P	●	●	●	5 x D	.0236	.1574	2,000	250	.0354	.1968	1,500	210	.0354	.2755	1,200	172
					6 X D	.0212	.1574			.0318	.1968			.0318	.2755		
					7 X D	.0196	.1574			.0295	.1968			.0295	.2755		
					8 X D	.0181	.1574			.0271	.1968			.0271	.2755		
					9 X D	.0149	.1574			.0224	.1968			.0226	.2755		
					10 X D	.0118	.1574			.0177	.1968			.0177	.2755		
Steels	P	●	●	●	5 x D	.0236	.1574	1,900	218	.0354	.1968	1,400	180	.0354	.2755	1,100	144
					6 X D	.0212	.1574			.0318	.1968			.0318	.2755		
					7 X D	.0196	.1574			.0295	.1968			.0295	.2755		
					8 X D	.0181	.1574			.0271	.1968			.0271	.2755		
					9 X D	.0149	.1574			.0224	.1968			.0226	.2755		
					10 X D	.0118	.1574			.0177	.1968			.0177	.2755		
Hardened Steels	H	●	○	○	5 x D	.0236	.1574	1,700	153	.0354	.1968	1,300	131	.0354	.2755	1,000	102
					6 X D	.0212	.1574			.0318	.1968			.0318	.2755		
					7 X D	.0196	.1574			.0295	.1968			.0295	.2755		
					8 X D	.0181	.1574			.0271	.1968			.0271	.2755		
					9 X D	.0149	.1574			.0224	.1968			.0226	.2755		
					10 X D	.0118	.1574			.0177	.1968			.0177	.2755		
Hardened Steels	H	●	○	○	5 x D	.0165	.1574	1,300	116	.0248	.1968	1,000	100	.0248	.2755	800	82
					6 X D	.0148	.1574			.0223	.1968			.0223	.2755		
					7 X D	.0137	.1574			.0206	.1968			.0206	.2755		
					8 X D	.0126	.1574			.0190	.1968			.0190	.2755		
					9 X D	.0104	.1574			.0157	.1968			.0157	.2755		
					10 X D	.0082	.1574			.0124	.1968			.0124	.2755		
Hardened Steels	H	●	○	○	5 x D	.0118	.1574	1,300	47	.0177	.1968	1,000	40	.0177	.2755	800	32
					6 X D	.0106	.1574			.0159	.1968			.0159	.2755		
					7 X D	.0098	.1574			.0147	.1968			.0147	.2755		
					8 X D	.0090	.1574			.0135	.1968			.0135	.2755		
					9 X D	.0074	.1574			.0112	.1968			.0112	.2755		
					10 X D	.0059	.1574			.0088	.1968			.0088	.2755		

158 Recommended Cutting Data - Cutting Conditions - Lower RPM (n) / High Feed (vf) Metric

Workpiece Material Group	Examples	Coolant			Tool Overhang	End Mill Diameter (mm)															
		<ul style="list-style-type: none"> • Preferred o Possible x Not Possible 				3.0 x R 0.8				6.0 x R 1.5				8.0 x R 2.0				10.0 x R 2.0			
		Max.	Air	MMS		Axial Depth (ap)	Radial Depth (ae)	RPM (n)	mm/min. (vf)	Axial Depth (ap)	Radial Depth (ae)	RPM (n)	mm/min. (vf)	Axial Depth (ap)	Radial Depth (ae)	RPM (n)	mm/min. (vf)	Axial Depth (ap)	Radial Depth (ae)	RPM (n)	mm/min. (vf)
Steels	P	•	•	•	5 x D	0.24	0.7	8,000	6,080	0.45	1.5	4,000	6,700	0.60	2.0	3,000	6,700	0.60	3.0	2,400	6,700
					6 X D	0.22	0.7			0.41	1.5			0.54	2.0			0.54	3.0		
					7 X D	0.20	0.7			0.38	1.5			0.50	2.0			0.50	3.0		
					8 X D	0.18	0.7			0.35	1.5			0.46	2.0			0.46	3.0		
					9 X D	0.15	0.7			0.29	1.5			0.38	2.0			0.38	3.0		
					10 X D	0.12	0.7			0.23	1.5			0.30	2.0			0.30	3.0		
Steels	P	•	•	•	5 x D	0.24	0.7	7,400	5,100	0.45	1.5	3,700	5,670	0.60	2.0	2,800	5,725	0.60	3.0	2,200	5,620
					6 X D	0.22	0.7			0.41	1.5			0.54	2.0			0.54	3.0		
					7 X D	0.20	0.7			0.38	1.5			0.50	2.0			0.50	3.0		
					8 X D	0.18	0.7			0.35	1.5			0.46	2.0			0.46	3.0		
					9 X D	0.15	0.7			0.29	1.5			0.38	2.0			0.38	3.0		
					10 X D	0.12	0.7			0.23	1.5			0.30	2.0			0.30	3.0		
Hardened Steels	H	•	o	o	5 x D	0.24	0.7	6,900	3,720	0.45	1.5	3,400	4,050	0.60	2.0	2,600	4,150	0.60	3.0	2,100	4,200
					6 X D	0.22	0.7			0.41	1.5			0.54	2.0			0.54	3.0		
					7 X D	0.20	0.7			0.38	1.5			0.50	2.0			0.50	3.0		
					8 X D	0.18	0.7			0.35	1.5			0.46	2.0			0.46	3.0		
					9 X D	0.15	0.7			0.29	1.5			0.38	2.0			0.38	3.0		
					10 X D	0.12	0.7			0.23	1.5			0.30	2.0			0.30	3.0		
Hardened Steels	H	•	o	o	5 x D	0.17	0.7	5,300	2,850	0.32	1.5	2,700	3,230	0.42	2.0	2,000	3,190	0.42	3.0	1,600	3,190
					6 X D	0.15	0.7			0.28	1.5			0.38	2.0			0.38	3.0		
					7 X D	0.14	0.7			0.26	1.5			0.35	2.0			0.35	3.0		
					8 X D	0.13	0.7			0.24	1.5			0.32	2.0			0.32	3.0		
					9 X D	0.11	0.7			0.20	1.5			0.27	2.0			0.27	3.0		
					10 X D	0.08	0.7			0.16	1.5			0.21	2.0			0.21	3.0		
Hardened Steels	H	•	o	o	5 x D	0.12	0.7	5,300	1,130	0.23	1.5	2,700	1,295	0.30	2.0	2,000	1,275	0.30	3.0	1,600	1,275
					6 X D	0.11	0.7			0.20	1.5			0.27	2.0			0.27	3.0		
					7 X D	0.10	0.7			0.19	1.5			0.25	2.0			0.25	3.0		
					8 X D	0.09	0.7			0.17	1.5			0.23	2.0			0.23	3.0		
					9 X D	0.08	0.7			0.14	1.5			0.19	2.0			0.19	3.0		
					10 X D	0.06	0.7			0.11	1.5			0.15	2.0			0.15	3.0		

Technical data provided should be considered advisory only as variations may be necessary depending on the particular application.



158 Recommended Cutting Data - Cutting Conditions - Lower RPM (n) / High Feed (vf) Metric Continued

Workpiece Material Group	Examples	Coolant			Tool Overhang	End Mill Diameter (mm)															
			Air			12.0 x R 2.0				16.0 x R 3.0				20.0 x R 3.0							
						Max.		MMS		Axial Depth (ap)	Radial Depth (ae)	RPM (n)	mm/min. (vf)	Axial Depth (ap)	Radial Depth (ae)	RPM (n)	mm/min. (vf)	Axial Depth (ap)	Radial Depth (ae)	RPM (n)	mm/min. (vf)
Steels	P	Cast Iron/ Carbon Steels/ Alloy Steels 150-250 HB	•	•	•	5 x D	0.60	4.0	2,000	6,350	0.90	5.0	1,500	5,350	0.90	7.0	1,200	4,360			
						6 X D	0.54	4.0			0.81	5.0			0.81	7.0					
						7 X D	0.50	4.0			0.75	5.0			0.75	7.0					
						8 X D	0.46	4.0			0.69	5.0			0.69	7.0					
						9 X D	0.38	4.0			0.57	5.0			0.57	7.0					
						10 X D	0.30	4.0			0.45	5.0			0.45	7.0					
Steels	P	Tool Steels 25-35 Rc	•	•	•	5 x D	0.60	4.0	1,900	5,530	0.90	5.0	1,400	4,580	0.90	7.0	1,100	3,650			
						6 X D	0.54	4.0			0.81	5.0			0.81	7.0					
						7 X D	0.50	4.0			0.75	5.0			0.75	7.0					
						8 X D	0.46	4.0			0.69	5.0			0.69	7.0					
						9 X D	0.38	4.0			0.57	5.0			0.57	7.0					
						10 X D	0.30	4.0			0.45	5.0			0.45	7.0					
Hardened Steels	H	35-45 Rc H13/D2 P20/4140 8620	•	o	o	5 x D	0.60	4.0	1,700	3,875	0.90	5.0	1,300	3,325	0.90	7.0	1,000	2,595			
						6 X D	0.54	4.0			0.81	5.0			0.81	7.0					
						7 X D	0.50	4.0			0.75	5.0			0.75	7.0					
						8 X D	0.46	4.0			0.69	5.0			0.69	7.0					
						9 X D	0.38	4.0			0.57	5.0			0.57	7.0					
						10 X D	0.30	4.0			0.45	5.0			0.45	7.0					
Hardened Steels	H	45 - 55 Rc H13/D2 P20/4140 8620	•	o	o	5 x D	0.42	4.0	1,300	2,950	0.63	5.0	1,000	2,550	0.63	7.0	800	2,070			
						6 X D	0.38	4.0			0.57	5.0			0.57	7.0					
						7 X D	0.35	4.0			0.53	5.0			0.53	7.0					
						8 X D	0.32	4.0			0.48	5.0			0.48	7.0					
						9 X D	0.27	4.0			0.40	5.0			0.40	7.0					
						10 X D	0.21	4.0			0.32	5.0			0.32	7.0					
Hardened Steels	H	55-60 Rc H13/D2 P20/4140 8620	•	o	o	5 x D	0.30	4.0	1,300	1,185	0.45	5.0	1,000	1,000	0.45	7.0	800	825			
						6 X D	0.27	4.0			0.41	5.0			0.41	7.0					
						7 X D	0.25	4.0			0.38	5.0			0.38	7.0					
						8 X D	0.23	4.0			0.35	5.0			0.35	7.0					
						9 X D	0.19	4.0			0.29	5.0			0.29	7.0					
						10 X D	0.15	4.0			0.23	5.0			0.23	7.0					

Technical data provided should be considered advisory only as variations may be necessary depending on the particular application.

For product information, call your local distributor.

157 Recommended Cutting Data - Profile Milling Inch

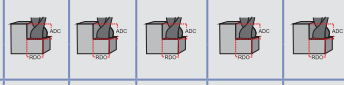
Workpiece Material Group	ISO	Hardness	Coolant ● Preferred ○ Possible x Not Possible			Profile Milling (ae)					End Mill Diameter*				
											*Axial depth during profile milling: OD < 1/4" .25D ap OD > 1/4" 1D ap				
						5%	10%	20%	30%	50%	← Multiply fz by this Factor based on ae. When finishing, use the standard fz per chart below. Only add chip thinning when roughing or semi-finishing.				
						2.3	1.8	1.2	1.1	1	fz - in/tooth				
Max.	Air	MMS	vc - SFM												
Free Machining & Low Carbon Steels 1006, 1008, 1015, 1018, 1020, 1022, 1025, 1117, 1140, 1141, 11L08, 11L14, 1213, 12L13, 12L14, 1215, 1330	P	up to 28 Rc	●	●	●	600	550	500	450	400	.0011	.0022	.0035	.0042	.0059
Medium Carbon & High Carbon Steels, Alloy Steels & Easy to Machine Tool Steels 1030, 1035, 1040, 1045, 1050, 1052, 1055, 1060, 1085, 1095, 1541, 1551, 9255, 2515, 3135, 3415, 4130, 4137, 4140, 4150, 4320, 4340, 4520, 5015, 5115, 5120, 5132, 5140, 5155, 6150, 8620, 9262, 9840, 52100, O1, O2, O6, S2, W1 to W310	P	28 to 38 Rc	●	●	●	600	550	500	450	400	.0011	.0022	.0035	.0042	.0059
Tool Steels & Die Steels O7, M1, M2, M3, M4, M7, T1, T2, T4, T5, T8, T15, A2, A3, A6, A7, H10, H11, H12, H13, H19, H21, L3, L6, L7, P2, P20, S1, S5, S7, 52100, A128, D2, D3, D4, D5, D7	P	28 to 44 Rc	●	●	●	550	500	450	400	375	.0011	.0020	.0033	.0040	.0055
Hardened Steels	H	40-50 Rc	●	○	○	360	340	300	280	260	.0007	.0014	.0024	.0030	.0040
Hardened Steels		50-55 Rc	●	○	○	360	340	300	280	260	.0004	.0008	.0016	.0018	.0024
Hardened Steels		>55 Rc	●	○	○	320	300	280	260	240	.0003	.0006	.0010	.0015	.0018
Stainless Steel - Ferritic	M	up to 28 Rc	●	x	○	550	525	500	450	425	.0010	.0020	.0033	.0040	.0055
Stainless Steel - Martensitic	M	up to 28 Rc	●	x	○	550	525	500	450	425	.0010	.0020	.0033	.0040	.0055
Stainless Steel - PH 302B, 304B, 309, 310, 316, 316B, 316L, 316Ti, 317, 317L, 321, PH13-8Mo, Nitronics	M	over 28 Rc	●	x	○	550	525	500	450	425	.0010	.0020	.0033	.0040	.0055
High Temp Alloys Nimonic, Inconel, Monel, Hastelloy	S	up to 42 Rc	●	x	x	165	165	130	115	100	.0004	.0008	.0016	.0018	.0024
Titanium Alloys 6Al-4V, 5Al-2.5 Sn, 6Al-2 Sn-4Zr-6Mo, 3Al-8V-6Cr4Mo-4Zr, 10V-2Fe-3Al, 13V-11Cr-3Al	S	up to 42 Rc	●	x	x	400	375	350	300	250	.0004	.0008	.0016	.0018	.0024



Spindle Maximum - Should the calculated spindle speed be more than your actual spindle maximum, use this formula:
 (Calculated Feed x Spindle Maximum)/Calculated Speed

157 Recommended Cutting Data - Profile Milling Metric

Workpiece Material Group	ISO	Hardness	Coolant			Profile Milling (ae)					End Mill Diameter (mm)*						
			● Preferred ○ Possible x Not Possible								3	6	8	10	12	16	20
						5%	10%	20%	30%	50%	*Axial depth during profile milling: OD < 6mm .25D ap OD > 6mm 1D ap						
			Max.	Air	MMS	vc - m/min					← Multiply fz by this Factor based on ae. When finishing, use the standard fz per chart below. Only add chip thinning when roughing or semi-finishing.						
								fz - mm/tooth									
Free Machining & Low Carbon Steels 1006, 1008, 1015, 1018, 1020, 1022, 1025, 1117, 1140, 1141, 11L08, 11L14, 1213, 12L13, 12L14, 1215, 1330	P	up to 28 Rc	●	●	●	183	168	152	137	122	.0280	.0559	.0889	.1067	.1498	.1778	.2032
Medium Carbon & High Carbon Steels, Alloy Steels & Easy to Machine Tool Steels 1030, 1035, 1040, 1045, 1050, 1052, 1055, 1060, 1085, 1095, 1541, 1551, 9255, 2515, 3135, 3415, 4130, 4137, 4140, 4150, 4320, 4340, 4520, 5015, 5115, 5120, 5132, 5140, 5155, 6150, 8620, 9262, 9840, 52100, O1, O2, O6, S2, W1 to W310	P	28 to 38 Rc	●	●	●	183	168	152	137	122	.0280	.0559	.0889	.1067	.1498	.1778	.2032
Tool Steels & Die Steels O7, M1, M2, M3, M4, M7, T1, T2, T4, T5, T8, T15, A2, A3, A6, A7, H10, H11, H12, H13, H19, H21, L3, L6, L7, P2, P20, S1, S5, S7, 52100, A128, D2, D3, D4, D5, D7	P	28 to 44 Rc	●	●	●	168	152	137	122	114	.0254	.0508	.0838	.1016	.1397	.1702	.1905
Hardened Steels	H	40-50 Rc	●	○	○	110	104	90	85	80	.0178	.0356	.0610	.0762	.1016	.1168	.1524
Hardened Steels		50-55 Rc	●	○	○	110	104	90	85	80	.0102	.0203	.0406	.0457	.0610	.0762	.0889
Hardened Steels		>55 Rc	●	○	○	100	90	85	80	75	.0076	.0152	.0254	.0381	.0457	.0559	.0635
Stainless Steel - Ferritic	M	up to 28 Rc	●	x	○	168	160	152	137	130	.0254	.0508	.0838	.1016	.1397	.1702	.1905
Stainless Steel - Martensitic	M	up to 28 Rc	●	x	○	168	160	152	137	130	.0254	.0508	.0838	.1016	.1397	.1702	.1905
Stainless Steel - PH 302B, 304B, 309, 310, 316, 316B, 316L, 316Ti, 317, 317L, 321, PH13-8Mo, Nitronics	M	over 28 Rc	●	x	○	168	160	152	137	130	.0254	.0508	.0838	.1016	.1397	.1702	.1905
High Temp Alloys Nimonic, Inconel, Monel, Hastelloy	S	up to 42 Rc	●	x	x	50	50	40	35	30	.0102	.0203	.0406	.0457	.0610	.0762	.0889
Titanium Alloys 6Al-4V, 5Al-2.5 Sn, 6Al-2 Sn-4Zr-6Mo, 3Al-8V-6Cr4Mo-4Zr, 10V-2Fe-3Al, 13V-11Cr-3Al	S	up to 42 Rc	●	x	x	122	114	107	90	75	.0102	.0203	.0406	.0457	.0610	.0762	.0889

Spindle Maximum - Should the calculated spindle speed be more than your actual spindle maximum, use this formula:
 (Calculated Feed x Spindle Maximum)/Calculated Speed







157 Recommended Cutting Data - Slotting Inch

Workpiece Material Group	ISO	Hardness	Coolant ● Preferred ○ Possible x Not Possible			Slotting			End Mill Diameter				
			●	○	x				1/8	1/4	3/8	1/2	5/8
						25%	50%	100%* *Trochoidal Milling	Axial Depth (ap) during slotting: OD > 1/4" .25D ap				
						Max.	Air	MMS	vc - SFM			fz - in/tooth	
Free Machining & Low Carbon Steels 1006, 1008, 1015, 1018, 1020, 1022, 1025, 1117, 1140, 1141, 11L08, 11L14, 1213, 12L13, 12L14, 1215, 1330	P	up to 28 Rc	●	●	●	480	480	400	.0005	.0011	.0017	.0021	.0029
Medium Carbon & High Carbon Steels, Alloy Steels & Easy to Machine Tool Steels 1030, 1035, 1040, 1045, 1050, 1052, 1055, 1060, 1085, 1095, 1541, 1551, 9255, 2515, 3135, 3415, 4130, 4137, 4140, 4150, 4320, 4340, 4520, 5015, 5115, 5120, 5132, 5140, 5155, 6150, 8620, 9262, 9840, 52100, O1, O2, O6, S2, W1 to W310	P	28 to 38 Rc	●	●	●	480	480	400	.0005	.0011	.0017	.0020	.0029
Tool Steels & Die Steels O7, M1, M2, M3, M4, M7, T1, T2, T4, T5, T8, T15, A2, A3, A6, A7, H10, H11, H12, H13, H19, H21, L3, L6, L7, P2, P20, S1, S5, S7, 52100, A128, D2, D3, D4, D5, D7	P	28 to 44 Rc	●	●	●	420	420	380	.0005	.0010	.0016	.0020	.0027
Hardened Steels	H	40-50 Rc	●	○	○	350	350	300	.0003	.0006	.0012	.0015	.0020
Hardened Steels		50-55 Rc	●	○	○	180	180	150	.0002	.0004	.0008	.0009	.0012
Hardened Steels		>55 Rc	●	○	○	150	150	100	.00015	.0003	.0005	.0007	.0009
Stainless Steel - Ferritic	M	up to 28 Rc	●	x	○	420	420	400	.0005	.0010	.0016	.0020	.0027
Stainless Steel - Martensitic	M	up to 28 Rc	●	x	○	420	420	400	.0005	.0010	.0016	.0020	.0027
Stainless Steel - PH 302B, 304B, 309, 310, 316, 316B, 316L, 316Ti, 317, 317L, 321, PH13-8Mo, Nitronics	M	over 28 Rc	●	x	○	400	400	380	.0005	.0010	.0016	.0020	.0027
High Temp Alloys Nimonic, Inconel, Monel, Hastelloy	S	up to 42 Rc	●	x	x	120	120	95	.0002	.0004	.0008	.0009	.0012
Titanium Alloys 6Al-4V, 5Al-2.5 Sn, 6Al-2 Sn-4Zr-6Mo, 3Al-8V-6Cr4Mo-4Zr, 10V-2Fe-3Al, 13V-11Cr-3Al	S	up to 42 Rc	●	x	x	200	200	175	.0002	.0004	.0008	.0009	.0012

Spindle Maximum - Should the calculated spindle speed be more than your actual spindle maximum, use this formula:

$$\frac{(\text{Calculated Feed} \times \text{Spindle Maximum})}{\text{Calculated Speed}}$$





157 Recommended Cutting Data - Slotting Metric

Workpiece Material Group	ISO	Hardness	Coolant			Slotting			End Mill Diameter (mm)						
			● Preferred ○ Possible x Not Possible						3	6	8	10	12	16	20
						25%	50%	100%* *Trochoidal Milling	Axial depth (ap) during slotting: OD > 6mm .25D ap						
			Max.	Air	MMS	vc - m/min			fz - mm/tooth						
Free Machining & Low Carbon Steels 1006, 1008, 1015, 1018, 1020, 1022, 1025, 1117, 1140, 1141, 11L08, 11L14, 1213, 12L13, 12L14, 1215, 1330	P	up to 28 Rc	●	●	●	146	146	122	.0122	.0279	.0432	.0533	.0737	.0762	.1016
Medium Carbon & High Carbon Steels, Alloy Steels & Easy to Machine Tool Steels 1030, 1035, 1040, 1045, 1050, 1052, 1055, 1060, 1085, 1095, 1541, 1551, 9255, 2515, 3135, 3415, 4130, 4137, 4140, 4150, 4320, 4340, 4520, 5015, 5115, 5120, 5132, 5140, 5155, 6150, 8620, 9262, 9840, 52100, O1, O2, O6, S2, W1 to W310	P	28 to 38 Rc	●	●	●	146	146	122	.0122	.0279	.0432	.0533	.0737	.0762	.1016
Tool Steels & Die Steels O7, M1, M2, M3, M4, M7, T1, T2, T4, T5, T8, T15, A2, A3, A6, A7, H10, H11, H12, H13, H19, H21, L3, L6, L7, P2, P20, S1, S5, S7, 52100, A128, D2, D3, D4, D5, D7	P	28 to 44 Rc	●	●	●	128	128	115	.0122	.0254	.0406	.0508	.0686	.0839	.0940
Hardened Steels	H	40-50 Rc	●	○	○	106	106	92	.0076	.0152	.0305	.0381	.0508	.0584	.0762
Hardened Steels		50-55 Rc	●	○	○	55	55	45	.0051	.0102	.0203	.0229	.0305	.0381	.0432
Hardened Steels		>55 Rc	●	○	○	45	45	30	.0038	.0076	.0127	.0178	.0229	.0279	.0305
Stainless Steel - Ferritic	M	up to 28 Rc	●	x	○	128	128	122	.0127	.0254	.0406	.0508	.0686	.0838	.0940
Stainless Steel - Martensitic	M	up to 28 Rc	●	x	○	128	128	122	.0127	.0254	.0406	.0508	.0686	.0838	.0940
Stainless Steel - PH 302B, 304B, 309, 310, 316, 316B, 316L, 316Ti, 317, 317L, 321, PH13-8Mo, Nitronics	M	over 28 Rc	●	x	○	122	122	115	.0127	.0254	.0406	.0508	.0686	.0838	.0940
High Temp Alloys Nimonic, Inconel, Monel, Hastelloy	S	up to 42 Rc	●	x	x	36	36	30	.0051	.0102	.0203	.0229	.0305	.0381	.0432
Titanium Alloys 6Al-4V, 5Al-2.5 Sn, 6Al-2 Sn-4Zr-6Mo, 3Al-8V-6Cr4Mo-4Zr, 10V-2Fe-3Al, 13V-11Cr-3Al	S	up to 42 Rc	●	x	x	60	60	55	.0051	.0102	.0203	.0229	.0305	.0381	.0432

Spindle Maximum - Should the calculated spindle speed be more than your actual spindle maximum, use this formula:

$$\frac{(\text{Calculated Feed} \times \text{Spindle Maximum})}{\text{Calculated Speed}}$$

192 Recommended Cutting Data - Profile Milling Inch

Workpiece Material Group	ISO	Hardness	Coolant ● P preferred ○ Possible x Not Possible			Profile Milling (ae)*					End Mill Diameter				
											1/4	3/8	1/2	5/8	3/4
						5%	10%	20%	30%	50%	ap < .7D Stub Length ap < 1.5D Standard Length				
						2.3	1.8	1.2	1.1	1	← Multiply fz by this Factor based on ae. When finishing, use the standard fz per chart below. Only add chip thinning when roughing or semi-finishing.				
Max.	Air	MMS	vc - SFM					fz - in/tooth							
Free Machining & Low Carbon Steels 1006, 1008, 1015, 1018, 1020, 1022, 1025, 1117, 1140, 1141, 11L08, 11L14, 1213, 12L13, 12L14, 1215, 1330	P	up to 28 Rc	●	●	●	1485	1485	1155	1000	825	.0033	.0047	.0066	.0078	.0090
Medium Carbon & High Carbon Steels, Alloy Steels & Easy to Machine Tool Steels 1030, 1035, 1040, 1045, 1050, 1052, 1055, 1060, 1085, 1095, 1541, 1551, 9255, 2515, 3135, 3415, 4130, 4137, 4140, 4150, 4320, 4340, 4520, 5015, 5115, 5120, 5132, 5140, 5155, 6150, 8620, 9262, 9840, 52100, O1, O2, O6, S2, W1 to W310	P	28 to 38 Rc	●	●	●	890	890	825	750	660	.0033	.0047	.0066	.0078	.0090
Tool Steels & Die Steels O7, M1, M2, M3, M4, M7, T1, T2, T4, T5, T8, T15, A2, A3, A6, A7, H10, H11, H12, H13, H19, H21, L3, L6, L7, P2, P20, S1, S5, S7, 52100, A 128, D2, D3, D4, D5, D7	P	28 to 44 Rc	●	●	●	750	750	660	560	430	.0033	.0047	.0066	.0078	.0090
Hardened Steels	H	35-45 Rc	●	○	○	450	450	410	300	165	.0029	.0039	.0059	.0070	.0078
Hardened Steels		45-55 Rc	●	○	○	380	380	350	250	150	.0020	.0029	.0039	.0051	.0061
Stainless Steel - Easy to Machine 430F, 301, 303, 410, 416 Annealed, 420F, 430, 430F	M	up to 28 Rc	●	x	○	500	500	430	400	350	.0033	.0047	.0066	.0078	.0090
Stainless Steel - Moderately Difficult 301, 302, 303 High Tensile, 304, 304L, 305, 420, 15-5PH, 17-4PH, 17-7PH	M	up to 28 Rc	●	x	○	430	430	400	370	330	.0025	.0033	.0049	.0059	.0066
Stainless Steel - Difficult to Machine 302B, 304B, 309, 310, 316, 316B, 316L, 316Ti, 317, 317L, 321, PH13-8Mo, Nitronics	M	over 28 Rc	●	x	○	430	430	400	360	330	.0025	.0033	.0049	.0059	.0066
High Temp Alloys Nimonic, Inconel, Monel, Hastelloy	S	up to 42 Rc	●	x	x	165	165	130	115	100	.0008	.0011	.0017	.0019	.0023
Titanium Alloys 6Al-4V, 5Al-2.5 Sn, 6Al-2 Sn-4Zr-6Mo, 3Al-8V-6Cr4Mo-4Zr, 10V-2Fe-3Al, 13V-11Cr-3Al	S	up to 42 Rc	●	x	x	400	400	370	300	250	.0008	.0011	.0017	.0019	.0023
Cast-Iron - Gray CG, ASTM A48, CLASS 20, 25, 30, 35, SAE J431C, GRADES G1800, G3000, G3500, GG 10, 15, 20, 25, 30, 35, 40	K	up to 240 HB	●	○	○	1180	1180	1120	800	630	.0033	.0047	.0066	.0078	.0090
Cast Iron - Ductile & Malleable CGI 60-40-18, 65-45-12, D4018, D4512, D5506, 32510, 35108, M3210, M4504, M5503, 250, 300, 350, 400, 450	K	over 240 HB	●	○	○	530	530	500	460	430	.0033	.0047	.0066	.0078	.0090

Technical data provided should be considered advisory only as variations may be necessary depending on the particular application.







192 Recommended Cutting Data - Profile Milling Metric

Workpiece Material Group	ISO	Hardness	Coolant			Profile Milling (ae)*					End Mill Diameter (mm)				
			• P preferred o Possible x Not Possible								8	10	12	16	20
			Max.	Air	MMS	2.3	1.8	1.2	1.1	1	ap < .7D Stub Length ap < 1.5D Standard Length				
						vc - m/min					Multiply fz by this Factor based on ae. When finishing, use the standard fz per chart below. Only add chip thinning when roughing or semi-finishing.				
								fz - mm/tooth							
Free Machining & Low Carbon Steels 1006, 1008, 1015, 1018, 1020, 1022, 1025, 1117, 1140, 1141, 11L08, 11L14, 1213, 12L13, 12L14, 1215, 1330	P	up to 28 Rc	•	•	•	450	450	350	300	250	.1000	.1200	.1700	.2000	.2300
Medium Carbon & High Carbon Steels, Alloy Steels & Easy to Machine Tool Steels 1030, 1035, 1040, 1045, 1050, 1052, 1055, 1060, 1085, 1095, 1541, 1551, 9255, 2515, 3135, 3415, 4130, 4137, 4140, 4150, 4320, 4340, 4520, 5015, 5115, 5120, 5132, 5140, 5155, 6150, 8620, 9262, 9840, 52100, O1, O2, O6, S2, W1 to W310	P	28 to 38 Rc	•	•	•	270	270	250	230	200	.1000	.1200	.1700	.2000	.2300
Tool Steels & Die Steels O7, M1, M2, M3, M4, M7, T1, T2, T4, T5, T8, T15, A2, A3, A6, A7, H10, H11, H12, H13, H19, H21, L3, L6, L7, P2, P20, S1, S5, S7, 52100, A 128, D2, D3, D4, D5, D7	P	28 to 44 Rc	•	•	•	230	230	200	170	130	.1000	.1200	.1700	.2000	.2300
Hardened Steels	H	35-45 Rc	•	o	o	135	135	125	90	50	.0900	.1000	.1500	.1800	.2000
Hardened Steels		45-55 Rc	•	o	o	115	115	105	75	45	.0660	.0760	.1000	.1320	.1550
Stainless Steel - Easy to Machine 430F, 301, 303, 410, 416 Annealed, 420F, 430, 430F	M	up to 28 Rc	•	x	o	155	155	130	125	110	.1000	.1200	.1700	.2000	.2300
Stainless Steel - Moderately Difficult 301, 302, 303 High Tensile, 304, 304L, 305, 420, 15-5PH, 17-4PH, 17-7PH	M	up to 28 Rc	•	x	o	130	130	125	115	100	.1000	.1200	.1700	.2000	.2300
Stainless Steel - Difficult to Machine 302B, 304B, 309, 310, 316, 316B, 316L, 316Ti, 317, 317L, 321, PH13-8Mo, Nitronics	M	over 28 Rc	•	x	o	130	130	120	110	100	.0760	.0860	.1250	.1500	.1750
High Temp Alloys Nimonic, Inconel, Monel, Hastelloy	S	up to 42 Rc	•	x	x	50	50	40	35	30	.0500	.0600	.0850	.1000	.1200
Titanium Alloys 6Al-4V, 5Al-2.5 Sn, 6Al-2 Sn-4Zr-6Mo, 3Al-8V-6Cr4Mo-4Zr, 10V-2Fe-3Al, 13V-11Cr-3Al	S	up to 42 Rc	•	x	x	125	125	115	90	75	.1000	.1200	.1700	.2000	.2300
Cast Iron - Gray CG, ASTM A48, CLASS 20, 25, 30, 35, SAE J431C, GRADES G1800, G3000, G3500, GG 10, 15, 20, 25, 30, 35, 40	K	up to 240 HB	•	o	o	360	360	340	245	195	.1000	.1200	.1700	.2000	.2300
Cast Iron - Ductile & Malleable CGI 60-40-18, 65-45-12, D4018, D4512, D5506, 32510, 35108, M3210, M4504, M5503, 250, 300, 350, 400, 450	K	over 240 HB	•	o	o	165	165	155	140	130	.1000	.1200	.1700	.2000	.2300

Technical data provided should be considered advisory only as variations may be necessary depending on the particular application.

For product information, call your local distributor.

192 Recommended Cutting Data - Slotting Inch

Workpiece Material Group	I S O	Hardness	Coolant			Slotting			End Mill Diameter				
			● P preferred ○ Possible x Not Possible						1/4*	3/8	1/2	5/8	3/4
						25%	50%	100%	*Slotting at > 25% ap is not recommended for Diameters 1/4" and below.				
			Max.	Air	MMS	vc - SFM			fz - in/tooth				
Free Machining & Low Carbon Steels 1006, 1008, 1015, 1018, 1020, 1022, 1025, 1117, 1140, 1141, 11L08, 11L14, 1213, 12L13, 12L14, 1215, 1330	P	up to 28 Rc	●	●	●	800	700	500	.0010	.0020	.0025	.0030	.0035
Medium Carbon & High Carbon Steels, Alloy Steels & Easy to Machine Tool Steels 1030, 1035, 1040, 1045, 1050, 1052, 1055, 1060, 1085, 1095, 1541, 1551, 9255, 2515, 3135, 3415, 4130, 4137, 4140, 4150, 4320, 4340, 4520, 5015, 5115, 5120, 5132, 5140, 5155, 6150, 8620, 9262, 9840, 52100, O1, O2, O6, S2, W1 to W310	P	28 to 38 Rc	●	●	●	650	550	450	.0010	.0020	.0025	.0030	.0035
Tool Steels & Die Steels O7, M1, M2, M3, M4, M7, T1, T2, T4, T5, T8, T15, A2, A3, A6, A7, H10, H11, H12, H13, H19, H21, L3, L6, L7, P2, P20, S1, S5, S7, 52100, A 128, D2, D3, D4, D5, D7	P	28 to 44 Rc	●	●	●	500	450	400	.0010	.0020	.0025	.0030	.0035
Hardened Steels	H	35-45 Rc	●	○	○	200	180	150	.0010	.0020	.0025	.0030	.0035
Hardened Steels		45-55 Rc	●	○	○	180	150	125	.0005	.0010	.0010	.0015	.0020
Stainless Steel - Easy to Machine 430F, 301, 303, 410, 416 Annealed, 420F, 430, 430F	M	up to 28 Rc	●	x	○	400	350	325	.0010	.0020	.0025	.0030	.0035
Stainless Steel - Moderately Difficult 301, 302, 303 High Tensile, 304, 304L, 305, 420, 15-5PH, 17-4PH, 17-7PH	M	up to 28 Rc	●	x	○	320	275	250	.0010	.0020	.0025	.0030	.0035
Stainless Steel - Difficult to Machine 302B, 304B, 309, 310, 316, 316B, 316L, 316Ti, 317, 317L, 321, PH13-8Mo, Nitronics	M	over 28 Rc	●	x	○	330	275	250	.0010	.0020	.0025	.0030	.0035
High Temp Alloys Nimonic, Inconel, Monel, Hastelloy	S	up to 42 Rc	●	x	x	110	100	95	.0005	.0010	.0010	.0015	.0020
Titanium Alloys 6Al-4V, 5Al-2.5 Sn, 6Al-2 Sn-4Zr-6Mo, 3Al-8V-6Cr-4Mo-4Zr, 10V-2Fe-3Al, 13V-11Cr-3Al	S	up to 42 Rc	●	x	x	230	210	195	.0008	.0009	.0011	.0017	.0019
Cast-Iron - Gray CG, ASTM A48, CLASS 20, 25, 30, 35, SAE J431C, GRADES G1800, G3000, G3500, GG 10, 15, 20, 25, 30, 35, 40	K	up to 240 HB	●	○	○	600	550	500	.0010	.0020	.0025	.0030	.0035
Cast Iron - Ductile & Malleable CGI 60-40-18, 65-45-12, D4018, D4512, D5506, 32510, 35108, M3210, M4504, M5503, 250, 300, 350, 400, 450	K	over 240 HB	●	○	○	320	275	250	.0010	.0020	.0025	.0030	.0035

Technical data provided should be considered advisory only as variations may be necessary depending on the particular application.

192 Recommended Cutting Data - Slotting Metric

Workpiece Material Group	ISO	Hardness	Coolant			Slotting*			End Mill Diameter (mm)				
			● Preferred	○ Possible	x Not Possible				8	10	12	16	20
						25%	50%	100%	*Slotting at > 25% ap is not recommended for Diameters 6mm and below.				
			Max.	Air	MMS	vc - m/min			fz - mm/tooth				
Free Machining & Low Carbon Steels 1006, 1008, 1015, 1018, 1020, 1022, 1025, 1117, 1140, 1141, 11L08, 11L14, 1213, 12L13, 12L14, 1215, 1330	P	up to 28 Rc	●	●	●	245	215	150	.0400	.0500	.0600	.0800	.1000
Medium Carbon & High Carbon Steels, Alloy Steels & Easy to Machine Tool Steels 1030, 1035, 1040, 1045, 1050, 1052, 1055, 1060, 1085, 1095, 1541, 1551, 9255, 2515, 3135, 3415, 4130, 4137, 4140, 4150, 4320, 4340, 4520, 5015, 5115, 5120, 5132, 5140, 5155, 6150, 8620, 9262, 9840, 52100, O1, O2, O6, S2, W1 to W310	P	28 to 38 Rc	●	●	●	200	170	140	.0400	.0500	.0600	.0800	.1000
Tool Steels & Die Steels O7, M1, M2, M3, M4, M7, T1, T2, T4, T5, T8, T15, A2, A3, A6, A7, H10, H11, H12, H13, H19, H21, L3, L6, L7, P2, P20, S1, S5, S7, 52100, A 128, D2, D3, D4, D5, D7	P	28 to 44 Rc	●	●	●	150	140	120	.0400	.0500	.0600	.0800	.1000
Hardened Steels	H	35-45 Rc	●	○	○	61	55	45	.0400	.0500	.0600	.0800	.1000
Hardened Steels		45-55 Rc	●	○	○	55	45	40	.0200	.0250	.0300	.0400	.0500
Stainless Steel - Easy to Machine 430F, 301, 303, 410, 416 Annealed, 420F, 430, 430F	M	up to 28 Rc	●	x	○	120	110	100	.0400	.0500	.0600	.0800	.1000
Stainless Steel - Moderately Difficult 301, 302, 303 High Tensile, 304, 304L, 305, 420, 15-5PH, 17-4PH, 17-7PH	M	up to 28 Rc	●	x	○	100	85	75	.0400	.0500	.0600	.0800	.1000
Stainless Steel - Difficult to Machine 302B, 304B, 309, 310, 316, 316B, 316L, 316Ti, 317, 317L, 321, PH13-8Mo, Nitronics	M	over 28 Rc	●	x	○	100	85	75	.0400	.0500	.0600	.0800	.1000
High Temp Alloys Nimonic, Inconel, Monel, Hastelloy	S	up to 42 Rc	●	x	x	35	30	30	.0200	.0250	.0300	.0400	.0500
Titanium Alloys 6Al-4V, 5Al-2.5 Sn, 6Al-2 Sn-4Zr-6Mo, 3Al-8V-6Cr4Mo-4Zr, 10V-2Fe-3Al, 13V-11Cr-3Al	S	up to 42 Rc	●	x	x	70	65	60	.0200	.0500	.0600	.0800	.1000
Cast-Iron - Gray CG, ASTM A48, CLASS 20, 25, 30, 35, SAE J431C, GRADES G1800, G3000, G3500, GG 10, 15, 20, 25, 30, 35, 40	K	up to 240 HB	●	○	○	185	170	150	.0400	.0500	.0600	.0800	.1000
Cast Iron - Ductile & Malleable CGI 60-40-18, 65-45-12, D4018, D4512, D5506, 32510, 35108, M3210, M4504, M5503, 250, 300, 350, 400, 450	K	over 240 HB	●	○	○	100	85	75	.0400	.0500	.0600	.0800	.1000

TuffCut® SS









112 / 113 Recommended Cutting Data - Profile Milling

Inch







Workpiece Material Group	ISO	Hardness	Coolant					Profile Milling (ae)					End Mill Diameter								
			● Preferred ○ Possible x Not Possible								1/8*	3/16*	1/4*	5/16	3/8	1/2	5/8	3/4	1		
						5%	10%	20%	30%	50%	*Profile milling at ≥ 50% ap is not recommended for diameters 1/4" and below.										
			Max.	Air	MMS	2.3	1.8	1.2	1.1	1	← Multiply fz by this Factor based on ae. When finishing, use the standard fz per chart below. Only add chip thinning when roughing or semi-finishing.										
			vc - SFM					fz - in/tooth													
Free Machining & Low Carbon Steels 1006, 1008, 1015, 1018, 1020, 1022, 1025, 1117, 1140, 1141, 11L08, 11L14, 1213, 12L13, 12L14, 1215, 1330	P	up to 28 Rc	●	●	●	1200	800	600	440	400	.0007	.0011	.0026	.0032	.0037	.0053	.0063	.0074	.0100		
Medium Carbon & High Carbon Steels, Alloy Steels & Easy to Machine Tool Steels 1030, 1035, 1040, 1045, 1050, 1052, 1055, 1060, 1085, 1095, 1541, 1551, 9255, 2515, 3135, 3415, 4130, 4137, 4140, 4150, 4320, 4340, 4520, 5015, 5115, 5120, 5132, 5140, 5155, 6150, 8620, 9262, 9840, 52100, O1, O2, O6, S2, W1 to W310	P	28 to 38 Rc	●	●	●	720	480	320	265	240	.0007	.0011	.0026	.0032	.0037	.0053	.0063	.0074	.0100		
Tool Steels & Die Steels O7, M1, M2, M3, M4, M7, T1, T2, T4, T5, T8, T15, A2, A3, A6, A7, H10, H11, H12, H13, H19, H21, L3, L6, L7, P2, P20, S1, S5, S7, 52100, A128, D2, D3, D4, D5, D7	P	28 to 44 Rc	●	●	●	600	400	320	220	200	.0007	.0011	.0026	.0032	.0037	.0053	.0063	.0074	.0100		
Hardened Steels	H	35-45 Rc	●	○	○	480	320	250	175	160	.0007	.0011	.0026	.0032	.0037	.0053	.0063	.0074	.0100		
Hardened Steels		45-55 Rc	●	○	○	360	240	200	175	150	.0004	.0007	.0017	.0021	.0024	.0035	.0042	.0049	.0070		
Hardened Steels		55-65 Rc	●	○	○	320	220	175	150	100	.0003	.0005	.0012	.0014	.0017	.0024	.0028	.0033	.0047		
Stainless Steel - Easy to Machine 430F, 301, 303, 410, 416 Annealed, 420F, 430, 430F	M	up to 28 Rc	●	x	○	1200	800	500	440	400	.0007	.0011	.0026	.0032	.0037	.0053	.0063	.0074	.0100		
Stainless Steel - Moderately Difficult 301, 302, 303 High Tensile, 304, 304L, 305, 420, 15-5PH, 17-4PH, 17-7PH	M	up to 28 Rc	●	x	○	600	400	300	220	200	.0007	.0011	.0026	.0032	.0037	.0053	.0063	.0074	.0100		
Stainless Steel - Difficult to Machine 302B, 304B, 309, 310, 316, 316B, 316L, 316Ti, 317, 317L, 321, PH13-8Mo, Nitronics	M	over 28 Rc	●	x	○	600	400	300	220	200	.0006	.0008	.0010	.0024	.0028	.0039	.0047	.0055	.0070		
High Temp Alloys Nimonic, Inconel, Monel, Hastelloy	S	up to 42 Rc	●	x	x	300	200	150	110	100	.0004	.0005	.0013	.0016	.0018	.0026	.0032	.0037	.0053		
Titanium Alloys 6Al-4V, 5Al-2.5 Sn, 6Al-2 Sn-4Zr-6Mo, 3Al-8V-6Cr4Mo-4Zr, 10V-2Fe-3Al, 13V-11Cr-3Al	S	up to 42 Rc	●	x	x	260	175	125	100	95	.0004	.0005	.0013	.0016	.0018	.0026	.0032	.0037	.0053		
Cast-Iron - Gray CG, ASTM A48, CLASS 20, 25, 30, 35, SAE J431C, GRADES G1800, G3000, G3500, GG 10, 15, 20, 25, 30, 35, 40	K	up to 240 HB	●	○	○	400	350	325	300	250	.0007	.0011	.0026	.0032	.0037	.0053	.0063	.0074	.0100		
Cast Iron - Ductile & Malleable CGI 60-40-18, 65-45-12, D4018, D4512, D5506, 32510, 35108, M3210, M4504, M5503, 250, 300, 350, 400, 450	K	over 240 HB	●	○	○	230	200	190	175	150	.0007	.0011	.0026	.0032	.0037	.0053	.0063	.0074	.0100		

Technical data provided should be considered advisory only as variations may be necessary depending on the particular application.

Metric

Workpiece Material Group	ISO	Hardness	Coolant			Profile Milling (ae)					End Mill Diameter (mm)								
			● Preferred ○ Possible x Not Possible								3*	5*	6*	8	10	12	16	20	25
			5%	10%	20%	30%	50%	*Profile milling at ≥ 50% ap is not recommended for diameters 6mm and below.											
						2.3	1.8	1.2	1.1	1	← Multiply fz by this Factor based on ae. When finishing, use the standard fz per chart below. Only add chip thinning when roughing or semi-finishing.								
Max.	Air	MMS	vc - m/min					fz - mm/tooth											
Free Machining & Low Carbon Steels 1006, 1008, 1015, 1018, 1020, 1022, 1025, 1117, 1140, 1141, 11L08, 11L14, 1213, 12L13, 12L14, 1215, 1330	P	up to 28 Rc	●	●	●	365	250	180	135	120	.0178	.0279	.0660	.0813	.0940	.1346	.1600	.1880	.2540
Medium Carbon & High Carbon Steels, Alloy Steels & Easy to Machine Tool Steels 1030, 1035, 1040, 1045, 1050, 1052, 1055, 1060, 1085, 1095, 1541, 1551, 9255, 2515, 3135, 3415, 4130, 4137, 4140, 4150, 4320, 4340, 4520, 5015, 5115, 5120, 5132, 5140, 5155, 6150, 8620, 9262, 9840, 52100, O1, O2, O6, S2, W1 to W310	P	28 to 38 Rc	●	●	●	220	150	100	80	75	.0178	.0279	.0660	.0813	.0940	.1346	.1600	.1880	.2540
Tool Steels & Die Steels O7, M1, M2, M3, M4, M7, T1, T2, T4, T5, T8, T15, A2, A3, A6, A7, H10, H11, H12, H13, H19, H21, L3, L6, L7, P2, P20, S1, S5, S7, 52100, A 128, D2, D3, D4, D5, D7	P	28 to 44 Rc	●	●	●	185	125	100	70	60	.0178	.0279	.0660	.0813	.0940	.1346	.1600	.1880	.2540
Hardened Steels	H	35-45 Rc	●	○	○	145	100	75	55	50	.0178	.0279	.0660	.0813	.0940	.1346	.1600	.1880	.2540
Hardened Steels		45-55 Rc	●	○	○	110	75	60	55	45	.0102	.0178	.0432	.0533	.0610	.0889	.1067	.1245	.1776
Hardened Steels		55-65 Rc	●	○	○	100	70	55	45	30	.0076	.0127	.0305	.0356	.0432	.0610	.0710	.0838	.1194
Stainless Steel - Easy to Machine 430F, 301, 303, 410, 416 Annealed, 420F, 430, 430F	M	up to 28 Rc	●	x	○	365	250	150	135	120	.0178	.0279	.0660	.0813	.0940	.1346	.1600	.1880	.2540
Stainless Steel - Moderately Difficult 301, 302, 303 High Tensile, 304, 304L, 305, 420, 15-5PH, 17-4PH, 17-7PH	M	up to 28 Rc	●	x	○	185	125	95	70	60	.0178	.0279	.0660	.0813	.0940	.1346	.1600	.1880	.2540
Stainless Steel - Difficult to Machine 302B, 304B, 309, 310, 316, 316B, 316L, 316Ti, 317, 317L, 321, PH13-8Mo, Nitronics	M	over 28 Rc	●	x	○	185	125	95	70	60	.0152	.0203	.0254	.0610	.0711	.0991	.1194	.1397	.1778
High Temp Alloys Nimonic, Inconel, Monel, Hastelloy	S	up to 42 Rc	●	x	x	90	60	45	35	30	.0102	.0127	.0330	.0406	.0457	.0660	.0813	.0940	.1346
Titanium Alloys 6Al-4V, 5Al-2.5 Sn, 6Al-2 Sn-4Zr-6Mo, 3Al-8V-6Cr4Mo-4Zr, 10V-2Fe-3Al, 13V-11Cr-3Al	S	up to 42 Rc	●	x	x	80	55	40	30	25	.0102	.0127	.0330	.0406	.0457	.0660	.0813	.0940	.1346
Cast Iron - Gray CG, ASTM A48, CLASS 20, 25, 30, 35, SAE J431C, GRADES G1800, G3000, G3500, GG 10, 15, 20, 25, 30, 35, 40	K	up to 240 HB	●	○	○	125	110	100	90	75	.0178	.0279	.0660	.0813	.0940	.1346	.1600	.1880	.2540
Cast Iron - Ductile & Malleable CGI 60-40-18, 65-45-12, D4018, D4512, D5506, 32510, 35108, M3210, M4504, M5503, 250, 300, 350, 400, 450	K	over 240 HB	●	○	○	70	65	60	55	45	.0178	.0279	.0660	.0813	.0940	.1346	.1600	.1880	.2540





112 Recommended Cutting Data - Slotting Inch

Workpiece Material Group	ISO	Hardness	Coolant			Slotting			End Mill Diameter								
			● Preferred ○ Possible x Not Possible						1/8*	3/16*	1/4*	5/16	3/8	1/2	5/8	3/4	1
						25%	50%	100%	*Slotting at > 25% ap is not recommended for diameters 1/4" and below.								
			Max.	Air	MMS	vc - SFM			fz - in/tooth								
Free Machining & Low Carbon Steels 1006, 1008, 1015, 1018, 1020, 1022, 1025, 1117, 1140, 1141, 11L08, 11L14, 1213, 12L13, 12L14, 1215, 1330	P	up to 28 Rc	●	●	●	440	420	400	.0004	.0005	.0013	.0015	.0014	.0026	.0031	.0036	.0051
Medium Carbon & High Carbon Steels, Alloy Steels & Easy to Machine Tool Steels 1030, 1035, 1040, 1045, 1050, 1052, 1055, 1060, 1085, 1095, 1541, 1551, 9255, 2515, 3135, 3415, 4130, 4137, 4140, 4150, 4320, 4340, 4520, 5015, 5115, 5120, 5132, 5140, 5155, 6150, 8620, 9262, 9840, 52100, O1, O2, O6, S2, W1 to W310	P	28 to 38 Rc	●	●	●	280	260	240	.0004	.0005	.0013	.0015	.0014	.0026	.0031	.0036	.0051
Tool Steels & Die Steels O7, M1, M2, M3, M4, M7, T1, T2, T4, T5, T8, T15, A2, A3, A6, A7, H10, H11, H12, H13, H19, H21, L3, L6, L7, P2, P20, S1, S5, S7, 52100, A 128, D2, D3, D4, D5, D7	P	28 to 44 Rc	●	●	●	240	220	200	.0004	.0005	.0013	.0015	.0014	.0026	.0031	.0036	.0051
Hardened Steels		35-45 Rc	●	○	○	400	360	320	.0004	.0005	.0012	.0014	.0016	.0023	.0028	.0033	.0050
Hardened Steels	H	45-55 Rc	●	○	○	280	260	240	.0002	.0004	.0005	.0010	.0012	.0017	.0021	.0024	.0035
Hardened Steels		55-65 Rc	●	○	○	200	180	160	.0002	.0003	.0006	.0006	.0006	.0012	.0014	.0017	.0024
Stainless Steel - Easy to Machine 430F, 301, 303, 410, 416 Annealed, 420F, 430, 430F	M	up to 28 Rc	●	x	○	440	420	400	.0004	.0005	.0013	.0015	.0014	.0026	.0031	.0036	.0051
Stainless Steel - Moderately Difficult 301, 302, 303 High Tensile, 304, 304L, 305, 420, 15-5PH, 17-4PH, 17-7PH	M	up to 28 Rc	●	x	○	280	240	200	.0004	.0005	.0013	.0015	.0016	.0026	.0031	.0036	.0051
Stainless Steel - Difficult to Machine 302B, 304B, 309, 310, 316, 316B, 316L, 316Ti, 317, 317L, 321, PH13-8Mo, Nitronics	M	over 28 Rc	●	x	○	240	220	200	.0004	.0005	.0013	.0015	.0016	.0026	.0031	.0036	.0051
High Temp Alloys Nimonic, Inconel, Monel, Hastelloy	S	up to 42 Rc	●	x	x	140	120	100	.0002	.0003	.0006	.0008	.0010	.0013	.0016	.0017	.0026
Titanium Alloys 6Al-4V, 5Al-2.5 Sn, 6Al-2 Sn-4Zr-6Mo, 3Al-8V-6Cr4Mo-4Zr, 10V-2Fe-3Al, 13V-11Cr-3Al	S	up to 42 Rc	●	x	x	115	100	90	.0002	.0003	.0006	.0008	.0010	.0013	.0016	.0017	.0026
Cast-Iron - Gray CG, ASTM A48, CLASS 20, 25, 30, 35, SAE J431C, GRADES G1800, G3000, G3500, GG 10, 15, 20, 25, 30, 35, 40	K	up to 240 HB	●	○	○	600	550	500	.0004	.0005	.0013	.0015	.0016	.0026	.0031	.0036	.0051
Cast Iron - Ductile & Malleable CGI 60-40-18, 65-45-12, D4018, D4512, D5506, 32510, 35108, M3210, M4504, M5503, 250, 300, 350, 400, 450	K	over 240 HB	●	○	○	320	275	250	.0004	.0005	.0013	.0015	.0016	.0026	.0031	.0036	.0051

Technical data provided should be considered advisory only as variations may be necessary depending on the particular application.

TuffCut® SS

112 Recommended Cutting Data - Slotting Metric

Workpiece Material Group	ISO	Hardness	Coolant			Slotting			End Mill Diameter (mm)								
			● Preferred ○ Possible x Not Possible						3*	5*	6*	8	10	12	16	20	25
						25%	50%	100%	*Slotting at > 25% ap is not recommended for diameters 6mm and below.								
			Max.	Air	MMS	vc - m/min			fz - mm/tooth								
Free Machining & Low Carbon Steels 1006, 1008, 1015, 1018, 1020, 1022, 1025, 1117, 1140, 1141, 11L08, 11L14, 1213, 12L13, 12L14, 1215, 1330	P	up to 28 Rc	●	●	●	135	130	120	.0089	.0127	.0330	.0381	.0356	.0660	.0787	.0914	.1295
Medium Carbon & High Carbon Steels, Alloy Steels & Easy to Machine Tool Steels 1030, 1035, 1040, 1045, 1050, 1052, 1055, 1060, 1085, 1095, 1541, 1551, 9255, 2515, 3135, 3415, 4130, 4137, 4140, 4150, 4320, 4340, 4520, 5015, 5115, 5120, 5132, 5140, 5155, 6150, 8620, 9262, 9840, 52100, O1, O2, O6, S2, W1 to W310	P	28 to 38 Rc	●	●	●	85	80	75	.0089	.0127	.0330	.0381	.0356	.0660	.0787	.0914	.1295
Tool Steels & Die Steels O7, M1, M2, M3, M4, M7, T1, T2, T4, T5, T8, T15, A2, A3, A6, A7, H10, H11, H12, H13, H19, H21, L3, L6, L7, P2, P20, S1, S5, S7, 52100, A 128, D2, D3, D4, D5, D7	P	28 to 44 Rc	●	●	●	75	70	60	.0089	.0127	.0330	.0381	.0356	.0660	.0787	.0914	.1295
Hardened Steels		35-45 Rc	●	○	○	125	110	100	.0089	.0114	.0305	.0356	.0406	.0584	.0711	.0838	.1270
Hardened Steels	H	45-55 Rc	●	○	○	85	80	75	.0051	.0089	.0135	.0254	.0305	.0432	.0533	.0610	.0889
Hardened Steels		55-65 Rc	●	○	○	60	55	50	.0051	.0064	.0142	.0145	.0150	.0305	.0356	.0432	.0610
Stainless Steel - Easy to Machine 430F, 301, 303, 410, 416 Annealed, 420F, 430, 430F	M	up to 28 Rc	●	x	○	135	130	120	.0089	.0127	.0330	.0381	.0356	.0660	.0787	.0914	.1295
Stainless Steel - Moderately Difficult 301, 302, 303 High Tensile, 304, 304L, 305, 420, 15-5PH, 17-4PH, 17-7PH	M	up to 28 Rc	●	x	○	85	75	60	.0089	.0127	.0330	.0381	.0356	.0660	.0787	.0914	.1295
Stainless Steel - Difficult to Machine 302B, 304B, 309, 310, 316, 316B, 316L, 316Ti, 317, 317L, 321, PH13-8Mo, Nitronics	M	over 28 Rc	●	x	○	75	70	60	.0089	.0127	.0330	.0381	.0356	.0660	.0787	.0914	.1295
High Temp Alloys Nimonic, Inconel, Monel, Hastelloy	S	up to 42 Rc	●	x	x	45	40	30	.0051	.0064	.0157	.0203	.0254	.0330	.0406	.0432	.0660
Titanium Alloys 6Al-4V, 5Al-2.5 Sn, 6Al-2 Sn-4Zr-6Mo, 3Al-8V-6Cr-4Mo-4Zr, 10V-2Fe-3Al, 13V-11Cr-3Al	S	up to 42 Rc	●	x	x	35	30	25	.0051	.0064	.0157	.0203	.0254	.0330	.0406	.0432	.0660
Cast-Iron - Gray CG, ASTM A48, CLASS 20, 25, 30, 35, SAE J431C, GRADES G1800, G3000, G3500, GG 10, 15, 20, 25, 30, 35, 40	K	up to 240 HB	●	○	○	185	170	150	.0089	.0127	.0330	.0381	.0406	.0660	.0787	.0914	.1295
Cast Iron - Ductile & Malleable CGI 60-40-18, 65-45-12, D4018, D4512, D5506, 32510, 35108, M3210, M4504, M5503, 250, 300, 350, 400, 450	K	over 240 HB	●	○	○	100	85	75	.0089	.0127	.0330	.0381	.0406	.0660	.0787	.0914	.1295

112 Slotting
TuffCut® SS

Technical Information

Technical data provided should be considered advisory only as variations may be necessary depending on the particular application.

For product information, call your local distributor.

General Purpose End Mill Recommended Cutting Data - Profile Milling

Length	2 Flute Series		3 Flute Series		4 Flute Series			
Stub	164	166	169		163		165	
Standard	121	150	116	145	111	140	117	114
Long Length	123*				122*			132*

*Chip thinning may not be possible with 122, 123 and 132 series if radial width of cut exceeds 20%.

For ball nose end mills - If axial depth (ap) is less than the ball diameter, the speed is figured using the effective cutting diameter.

Inch

For diameters 1/4" and below, see Micro Charts starting on page 363.

Workpiece Material Group	ISO	Hardness	Coolant					Profile Milling (ae)					End Mill Diameters					
			• Preferred o Possible x Not Possible								5/16	3/8	1/2	5/8	3/4	1		
			Water	Air	MMS	5%	10%	20%	30%	50%	ae > .3D use < 1D ap ae < .2D use < 2D ap							
			Max.	Air	MMS	vc - SFM Increase speeds by 30% for ALtima® coated tools					← Multiply fz by this Factor based on ae. When finishing, use the standard fz per chart below. Only add chip thinning when roughing or semi-finishing.							
			fz - in/tooth															
Free Machining & Low Carbon Steels 1006, 1008, 1015, 1018, 1020, 1022, 1025, 1117, 1140, 1141, 11L08, 11L14, 1213, 12L13, 12L14, 1215, 1330	P	up to 28 Rc	•	•	•	1050	700	385	375	350	.0027	.0032	.0045	.0054	.0063	.0090		
Medium Carbon & High Carbon Steels, Alloy Steels & Easy to Machine Tool Steels 1030, 1035, 1040, 1045, 1050, 1052, 1055, 1060, 1085, 1095, 1541, 1551, 9255, 2515, 3135, 3415, 4130, 4137, 4140, 4150, 4320, 4340, 4520, 5015, 5115, 5120, 5132, 5140, 5155, 6150, 8620, 9262, 9840, 52100, O1, O2, O6, S2, W1 to W310	P	28 to 38 Rc	•	•	•	630	420	320	250	210	.0027	.0032	.0045	.0054	.0063	.0090		
Tool Steels & Die Steels O7, M1, M2, M3, M4, M7, T1, T2, T4, T5, T8, T15, A2, A3, A6, A7, H10, H11, H12, H13, H19, H21, L3, L6, L7, P2, P20, S1, S5, S7, 52100, A 128, D2, D3, D4, D5, D7	P	28 to 44 Rc	•	•	•	525	350	300	275	250	.0027	.0032	.0045	.0054	.0063	.0090		
Hardened Steels	H	45-55 Rc	•	o	o	250	240	230	210	200	.0018	.0021	.0030	.0036	.0042	.0060		
Hardened Steels		55-65 Rc	•	o	o	200	180	160	150	100	.0013	.0014	.0021	.0024	.0029	.0041		
Stainless Steel - Easy to Machine 430F, 301, 303, 410, 416 Annealed, 420F, 430, 430F	M	up to 28 Rc	•	x	o	650	600	550	500	450	.0027	.0032	.0045	.0054	.0063	.0090		
Stainless Steel - Moderately Difficult 301, 302, 303 High Tensile, 304, 304L, 305, 420, 15-5PH, 17-4PH, 17-7PH	M	up to 28 Rc	•	x	o	525	400	350	300	250	.0027	.0032	.0045	.0054	.0063	.0090		
Stainless Steel - Difficult to Machine 302B, 304B, 309, 310, 316, 316B, 316L, 316Ti, 317, 317L, 321, PH13-8Mo, Nitronics	M	over 28 Rc	•	x	o	525	400	350	300	250	.0027	.0032	.0045	.0054	.0063	.0090		

General Purpose End Mill Recommended Cutting Data - Profile Milling

Length	2 Flute Series		3 Flute Series		4 Flute Series			
Stub	164	166	169		163		165	
Standard	121	150	116	145	111	140	117	114
Long Length	123*				122*			132*

*Chip thinning may not be possible with 122, 123 and 132 series if radial width of cut exceeds 20%.

For ball nose end mills - If axial depth (ap) is less than the ball diameter, the speed is figured using the effective cutting diameter.

Inch Continued

For diameters 1/4" and below, see Micro Charts starting on page 363.

Workpiece Material Group	ISO	Hardness	Coolant			Profile Milling (ae)					End Mill Diameter					
			• Preferred o Possible x Not Possible								5/16	3/8	1/2	5/8	3/4	1
			Max.	Air	MMS	2.3	1.8	1.2	1.1	1	ae > .3D use < 1D ap ae < .2D use < 2D ap					
			vc - SFM Increase speeds by 30% for ALtima® coated tools					← Multiply fz by this Factor based on ae. When finishing, use the standard fz per chart below. Only add chip thinning when roughing or semi-finishing.								
											fz - in/tooth					
High Temp Alloys Nimonic, Inconel, Monel, Hastelloy	S	up to 42 Rc	•	x	x	265	200	175	150	100	.0014	.0016	.0023	.0027	.0032	.0045
Titanium Alloys 6Al-4V, 5Al-2.5 Sn, 6Al-2 Sn-4Zr-6Mo, 3Al-8V-6Cr4Mo-4Zr, 10V-2Fe-3Al, 13V-11Cr-3Al	S	up to 42 Rc	•	x	x	230	200	175	150	125	.0014	.0016	.0023	.0027	.0032	.0045
Cast-Iron - Gray CG, ASTM A48, CLASS 20, 25, 30, 35, SAE J431C, GRADES G1800, G3000, G3500, GG 10, 15, 20, 25, 30, 35, 40	K	up to 240 HB	•	o	o	425	400	375	350	300	.0027	.0032	.0045	.0054	.0063	.0090
Cast Iron - Ductile & Malleable CGI 60-40-18, 65-45-12, D4018, D4512, D5506, 32510, 35108, M3210, M4504, M5503, 250, 300, 350, 400, 450	K	over 240 HB	•	o	o	320	300	250	225	200	.0027	.0032	.0045	.0054	.0063	.0090
Non-Ferrous, Plastics, Graphite	N		•			1000	960	920	880	840	.0027	.0032	.0045	.0054	.0063	.0090

General Purpose End Mill Recommended Cutting Data - Profile Milling

Length	2 Flute Series		3 Flute Series		4 Flute Series			
Stub	164	166	169		163		165	
Standard	121	150	116	145	111	140	117	114
Long Length	123*				122*			132*

*Chip thinning may not be possible with 122, 123 and 132 series if radial width of cut exceeds 20%.

For ball nose end mills - If axial depth (ap) is less than the ball diameter, the speed is figured using the effective cutting diameter.

Metric

For diameters 6mm and below, see Micro Charts starting on page 363.

Workpiece Material Group	ISO	Hardness	Coolant			Profile Milling (ae)					End Mill Diameter (mm)					
			• Preferred	o Possible	x Not Possible						8	10	12	16	20	25
						2.3	1.8	1.2	1.1	1	ae > .3D use < 1D ap ae < .2D use < 2D ap					
			Max.	Air	MMS	vc - m/min Increase speeds by 30% for ALtima® coated tools					fz - mm/tooth					
Free Machining & Low Carbon Steels 1006, 1008, 1015, 1018, 1020, 1022, 1025, 1117, 1140, 1141, 11L08, 11L14, 1213, 12L13, 12L14, 1215, 1330	P	up to 28 Rc	•	•	•	320	215	120	115	110	.0690	.0810	.1140	.1370	.1600	.2290
Medium Carbon & High Carbon Steels, Alloy Steels & Easy to Machine Tool Steels 1030, 1035, 1040, 1045, 1050, 1052, 1055, 1060, 1085, 1095, 1541, 1551, 9255, 2515, 3135, 3415, 4130, 4137, 4140, 4150, 4320, 4340, 4520, 5015, 5115, 5120, 5132, 5140, 5155, 6150, 8620, 9262, 9840, 52100, O1, O2, O6, S2, W1 to W310	P	28 to 38 Rc	•	•	•	200	130	100	75	65	.0690	.0810	.1140	.1370	.1600	.2290
Tool Steels & Die Steels O7, M1, M2, M3, M4, M7, T1, T2, T4, T5, T8, T15, A2, A3, A6, A7, H10, H11, H12, H13, H19, H21, L3, L6, L7, P2, P20, S1, S5, S7, 52100, A 128, D2, D3, D4, D5, D7	P	28 to 44 Rc	•	•	•	160	110	90	85	75	.0690	.0810	.1140	.1370	.1600	.2290
Hardened Steels	H	45-55 Rc	•	o	o	75	73	70	65	60	.0460	.0530	.0760	.0910	.1070	.1520
Hardened Steels		55-65 Rc	•	o	o	60	55	50	45	30	.0330	.0360	.0530	.0610	.0740	.1040
Stainless Steel - Easy to Machine 430F, 301, 303, 410, 416 Annealed, 420F, 430, 430F	M	up to 28 Rc	•	x	o	200	185	170	150	140	.0690	.0810	.1140	.1370	.1600	.2290
Stainless Steel - Moderately Difficult 301, 302, 303 High Tensile, 304, 304L, 305, 420, 15-5PH, 17-4PH, 17-7PH	M	up to 28 Rc	•	x	o	160	125	110	90	75	.0690	.0810	.1140	.1370	.1600	.2290
Stainless Steel - Difficult to Machine 302B, 304B, 309, 310, 316, 316B, 316L, 316Ti, 317, 317L, 321, PH13-8Mo, Nitronics	M	over 28 Rc	•	x	o	160	125	110	90	75	.0690	.0810	.1140	.1370	.1600	.2290

Technical data provided should be considered advisory only as variations may be necessary depending on the particular application.

General Purpose End Mill Recommended Cutting Data - Profile Milling

Length	2 Flute Series		3 Flute Series		4 Flute Series			
Stub	164	166	169		163		165	
Standard	121	150	116	145	111	140	117	114
Long Length	123*				122*			132*

*Chip thinning may not be possible with 122, 123 and 132 series if radial width of cut exceeds 20%.

For ball nose end mills - If axial depth (ap) is less than the ball diameter, the speed is figured using the effective cutting diameter.

Metric Continued

For diameters 6mm and below, see Micro Charts starting on page 363.

Workpiece Material Group	ISO	Hardness	Coolant					Profile Milling (ae)					End Mill Diameter (mm)					
			• Preferred o Possible x Not Possible								8	10	12	16	20	25		
						5%	10%	20%	30%	50%	ae > .3D use < 1D ap ae < .2D use < 2D ap							
			Max.	Air	MMS	vc - m/min Increase speeds by 30% for ALtima® coated tools					← Multiply fz by this Factor based on ae. When finishing, use the standard fz per chart below. Only add chip thinning when roughing or semi-finishing.							
			fz - mm/tooth															
High Temp Alloys Nimonic, Inconel, Monel, Hastelloy	S	up to 42 Rc	•	x	x	80	60	50	45	30	.0360	.0410	.0580	.0690	.0810	.1140		
Titanium Alloys 6Al-4V, 5Al-2.5 Sn, 6Al-2 Sn-4Zr-6Mo, 3Al-8V-6Cr4Mo-4Zr, 10V-2Fe-3Al, 13V-11Cr-3Al	S	up to 42 Rc	•	x	x	70	60	55	45	35	.0360	.0410	.0580	.0690	.0810	.1140		
Cast-Iron - Gray CG, ASTM A48, CLASS 20, 25, 30, 35, SAE J431C, GRADES G1800, G3000, G3500, GG 10, 15, 20, 25, 30, 35, 40	K	up to 240 HB	•	o	o	130	125	115	110	90	.0690	.0810	.1140	.1370	.1600	.2290		
Cast Iron - Ductile & Malleable CGI 60-40-18, 65-45-12, D4018, D4512, D5506, 32510, 35108, M3210, M4504, M5503, 250, 300, 350, 400, 450	K	over 240 HB	•	o	o	100	90	75	65	60	.0690	.0810	.1140	.1370	.1600	.2290		
Non-Ferrous, Plastic, Graphite	N		•			300	290	280	260	255	.0690	.0810	.1140	.1370	.1600	.2290		







General Purpose End Mill Recommended Cutting Data - Slotting

Length	2 Flute Series		3 Flute Series		4 Flute Series			
Stub	164	166	169		163		165	
Standard	121	150	116	145	111	140	117	114

For ball nose end mills - If axial depth (ap) is less than the ball diameter, the speed is figured using the effective cutting diameter.

Inch

For diameters 1/4" and below, see Micro Charts starting on page 363.

Workpiece Material Group	ISO	Hardness	Coolant			Slotting			End Mill Diameter					
			● Preferred ○ Possible x Not Possible						5/16	3/8	1/2	5/8	3/4	1
						25%	50%	100%	fz - in/tooth					
			Max.	Air	MMS	vc - SFM Increase speeds by 30% for ALtima® coated tools								
Free Machining & Low Carbon Steels 1006, 1008, 1015, 1018, 1020, 1022, 1025, 1117, 1140, 1141, 11L08, 11L14, 1213, 12L13, 12L14, 1215, 1330	P	up to 28 Rc	●	●	●	385	370	350	.0016	.0019	.0025	.0031	.0038	.0050
Medium Carbon & High Carbon Steels, Alloy Steels & Easy to Machine Tool Steels 1030, 1035, 1040, 1045, 1050, 1052, 1055, 1060, 1085, 1095, 1541, 1551, 9255, 2515, 3135, 3415, 4130, 4137, 4140, 4150, 4320, 4340, 4520, 5015, 5115, 5120, 5132, 5140, 5155, 6150, 8620, 9262, 9840, 52100, O1, O2, O6, S2, W1 to W310	P	28 to 38 Rc	●	●	●	245	230	210	.0016	.0019	.0025	.0031	.0038	.0050
Tool Steels & Die Steels O7, M1, M2, M3, M4, M7, T1, T2, T4, T5, T8, T15, A2, A3, A6, A7, H10, H11, H12, H13, H19, H21, L3, L6, L7, P2, P20, S1, S5, S7, 52100, A 128, D2, D3, D4, D5, D7	P	28 to 44 Rc	●	●	●	210	195	175	.0016	.0019	.0025	.0031	.0038	.0050
Hardened Steels	H	35-45 Rc	●	○	○	245	230	210	.0016	.0019	.0025	.0031	.0038	.0050
Hardened Steels		45-55 Rc	●	○	○	175	160	140	.0008	.0010	.0013	.0016	.0020	.0025
Hardened Steels		55-65 Rc	●	○	○	150	125	100	.0004	.0005	.0008	.0008	.0010	.0012
Stainless Steel - Easy to Machine 430F, 301, 303, 410, 416 Annealed, 420F, 430, 430F	M	up to 28 Rc	●	x	○	385	370	350	.0016	.0019	.0025	.0031	.0038	.0050
Stainless Steel - Moderately Difficult 301, 302, 303 High Tensile, 304, 304L, 305, 420, 15-5PH, 17-4PH, 17-7PH	M	up to 28 Rc	●	x	○	245	210	175	.0016	.0019	.0025	.0031	.0038	.0050
Stainless Steel - Difficult to Machine 302B, 304B, 309, 310, 316, 316B, 316L, 316Ti, 317, 317L, 321, PH13-8Mo, Nitronics	M	over 28 Rc	●	x	○	210	195	175	.0016	.0019	.0025	.0031	.0038	.0050

Technical data provided should be considered advisory only as variations may be necessary depending on the particular application.





General Purpose End Mill Recommended Cutting Data - Slotting

Length	2 Flute Series		3 Flute Series		4 Flute Series				
	Stub	164	166	169		163		165	
Standard	121	150	116	145	111	140	117	114	

For ball nose end mills - If axial depth (ap) is less than the ball diameter, the speed is figured using the effective cutting diameter.

Inch Continued

For diameters 1/4" and below, see Micro Charts starting on page 363.

Workpiece Material Group	ISO	Hardness	Coolant			Slotting			End Mill Diameter					
			● Preferred ○ Possible x Not Possible						5/16	3/8	1/2	5/8	3/4	1
						25%	50%	100%	fz - in/tooth					
			Max.	Air	MMS	vc - SFM Increase speeds by 30% for ALtima® coated tools								
High Temp Alloys Nimonic, Inconel, Monel, Hastelloy	S	up to 42 Rc	●	x	x	125	105	90	.0008	.0010	.0013	.0016	.0017	.0026
Titanium Alloys 6Al-4V, 5Al-2.5 Sn, 6Al-2 Sn-4Zr-6Mo, 3Al-8V-6Cr4Mo-4Zr, 10V-2Fe-3Al, 13V-11Cr-3Al	S	up to 42 Rc	●	x	x	100	90	80	.0008	.0010	.0013	.0016	.0017	.0026
Cast-Iron - Gray CG, ASTM A48, CLASS 20, 25, 30, 35, SAE J431C, GRADES G1800, G3000, G3500, GG 10, 15, 20, 25, 30, 35, 40	K	up to 240 HB	●	○	○	450	400	350	.0016	.0019	.0025	.0031	.0038	.0050
Cast Iron - Ductile & Malleable CGI 60-40-18, 65-45-12, D4018, D4512, D5506, 32510, 35108, M3210, M4504, M5503, 250, 300, 350, 400, 450	K	over 240 HB	●	○	○	300	250	225	.0016	.0019	.0025	.0031	.0038	.0050
Non-Ferrous, Plastic, Graphite	N		●			750	600	450	.0016	.0019	.0025	.0031	.0038	.0050







General Purpose End Mill Recommended Cutting Data - Slotting

Length	2 Flute Series		3 Flute Series		4 Flute Series			
Stub	164	166	169		163		165	
Standard	121	150	116	145	111	140	117	114

For ball nose end mills - If axial depth (ap) is less than the ball diameter, the speed is figured using the effective cutting diameter.

Metric

For diameters 6mm and below, see Micro Charts starting on page 363.

Workpiece Material Group	I S O	Hardness	Coolant			Slotting			End Mill Diameter (mm)					
			● Preferred ○ Possible x Not Possible						8	10	12	16	20	25
						25%	50%	100%	fz - mm/tooth					
			Max.	Air	MMS	vc - m/min Increase speeds by 30% for ALtima® coated tools								
Free Machining & Low Carbon Steels 1006, 1008, 1015, 1018, 1020, 1022, 1025, 1117, 1140, 1141, 11L08, 11L14, 1213, 12L13, 12L14, 1215, 1330	P	up to 28 Rc	●	●	●	120	110	107	.0400	.0500	.0600	.0800	.1000	.1250
Medium Carbon & High Carbon Steels, Alloy Steels & Easy to Machine Tool Steels 1030, 1035, 1040, 1045, 1050, 1052, 1055, 1060, 1085, 1095, 1541, 1551, 9255, 2515, 3135, 3415, 4130, 4137, 4140, 4150, 4320, 4340, 4520, 5015, 5115, 5120, 5132, 5140, 5155, 6150, 8620, 9262, 9840, 52100, O1, O2, O6, S2, W1 to W310	P	28 to 38 Rc	●	●	●	75	70	65	.0400	.0500	.0600	.0800	.1000	.1250
Tool Steels & Die Steels O7, M1, M2, M3, M4, M7, T1, T2, T4, T5, T8, T15, A2, A3, A6, A7, H10, H11, H12, H13, H19, H21, L3, L6, L7, P2, P20, S1, S5, S7, 52100, A 128, D2, D3, D4, D5, D7	P	28 to 44 Rc	●	●	●	65	60	55	.0400	.0500	.0600	.0800	.1000	.1250
Hardened Steels	H	35-45 Rc	●	○	○	55	50	45	.0400	.0500	.0600	.0800	.1000	.1250
Hardened Steels		45-55 Rc	●	○	○	55	50	45	.0200	.0250	.0300	.0400	.0500	.0620
Hardened Steels		55-65 Rc	●	○	○	50	45	40	.0100	.0120	.0150	.0200	.0250	.0300
Stainless Steel - Easy to Machine 430F, 301, 303, 410, 416 Annealed, 420F, 430, 430F	M	up to 28 Rc	●	x	○	120	115	110	.0400	.0500	.0600	.0800	.1000	.1250
Stainless Steel - Moderately Difficult 301, 302, 303 High Tensile, 304, 304L, 305, 420, 15-5PH, 17-4PH, 17-7PH	M	up to 28 Rc	●	x	○	75	65	55	.0400	.0500	.0600	.0800	.1000	.1250
Stainless Steel - Difficult to Machine 302B, 304B, 309, 310, 316, 316B, 316L, 316Ti, 317, 317L, 321, PH13-8Mo, Nitronics	M	over 28 Rc	●	x	○	65	60	55	.0400	.0500	.0600	.0800	.1000	.1250

Technical data provided should be considered advisory only as variations may be necessary depending on the particular application.







General Purpose End Mill Recommended Cutting Data - Slotting

Length	2 Flute Series		3 Flute Series		4 Flute Series			
Stub	164	166	169		163	165		
Standard	121	150	116	145	111	140	117	114

For ball nose end mills - If axial depth (ap) is less than the ball diameter, the speed is figured using the effective cutting diameter.

Metric Continued

For diameters 6mm and below, see Micro Charts starting on page 363.

Workpiece Material Group	ISO	Hardness	Coolant			Slotting			End Mill Diameter (mm)					
			● Preferred ○ Possible x Not Possible						8	10	12	16	20	25
						25%	50%	100%	fz - mm/tooth					
			Max.	Air	MMS	vc - m/min Increase speeds by 30% for ALtima® coated tools								
High Temp Alloys Nimonic, Inconel, Monel, Hastelloy	S	up to 42 Rc	●	x	x	40	35	30	.0100	.0120	.0150	.0200	.0250	.0300
Titanium Alloys 6Al-4V, 5Al-2.5 Sn, 6Al-2 Sn-4Zr-6Mo, 3Al-8V-6Cr4Mo-4Zr, 10V-2Fe-3Al, 13V-11Cr-3Al	S	up to 42 Rc	●	x	x	30	25	25	.0100	.0120	.0150	.0200	.0250	.0300
Cast Iron - Gray CG, ASTM A48, CLASS 20, 25, 30, 35, SAE J431C, GRADES G1800, G3000, G3500, GG 10, 15, 20, 25, 30, 35, 40	K	up to 240 HB	●	○	○	135	125	110	.0400	.0500	.0600	.0800	.1000	.1250
Cast Iron - Ductile & Malleable CGI 60-40-18, 65-45-12, D4018, D4512, D5506, 32510, 35108, M3210, M4504, M5503, 250, 300, 350, 400, 450	K	over 240 HB	●	○	○	90	75	70	.0400	.0500	.0600	.0800	.1000	.1250
Non-Ferrous, Plastic, Graphite	N		●			230	180	140	.0400	.0500	.0600	.0800	.1000	.1250

End Mill Terminology

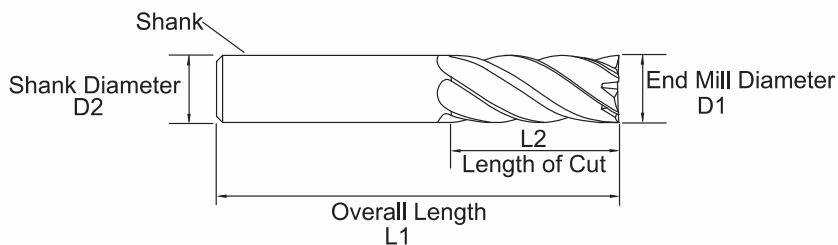

Length of Cut (Flute Length) – Always select the shortest Flute Length possible for your application. By selecting the shortest Flute Length, you can increase rigidity and allow for higher feed rates.

End Mill Diameter – Always select the largest diameter possible for your milling operation. Increasing your diameter by just 10%, can increase your rigidity by 25%.

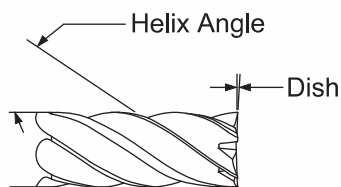

Helix Angle – Varies from 0 to 60 degrees. Higher helix angles can increase the number of teeth in a cut, and help in redirecting cutting forces. This is beneficial in harder to machine materials in particular. Changes in helix angle can also greatly affect the flute form of an end mill, and affect chip evacuation.

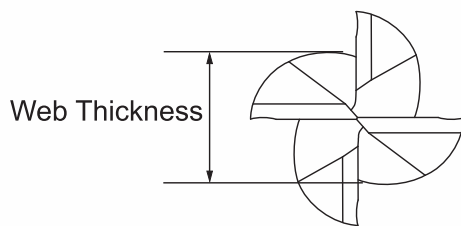

Web Thickness – The cross section of the fluting of the end mill. Larger webs allow for more rigidity, while smaller webs allow for better chip evacuation. This feature is highly dependent on the material being machined.

Rake Angle – The measurement of the curvature of the cutting edge in the face of the flute. A high rake angle will cut more aggressively, while a lower rake angle will increase the strength of the cutting edge.

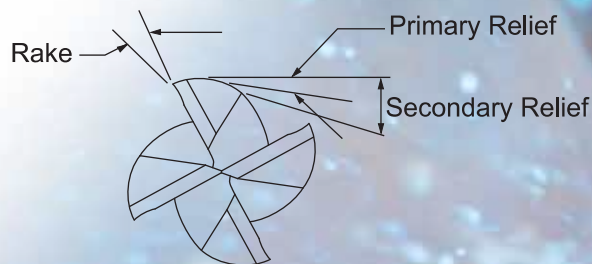

Primary Relief – The clearance directly behind the cutting edge. High primary relief angles will allow for more aggressive milling, while lower relief angles will increase the strength of the cutting edge. The primary relief will also affect the wear on a cutting edge. Lower primary relief angles can tend to develop larger wear lands.





Micro End Mill Recommended Cutting Data - Profile Milling

Length	2 Flute Series		3 Flute Series		4 Flute Series			
Standard	121	150	116	145	111	140	117	114
Long Length	123				122			132

Inch - Standard / Long Length

Ball Nose End Mills - If axial depth (ap) is less than the ball diameter, the speed is figured using the effective cutting diameter.

For diameters > 1/4", see Chart on page 354.

Workpiece Material Group	ISO	Hardness	Coolant			Profile Milling 	End Mill Diameter (Inch)								
			• Preferred	o Possible	x Not Possible		.0150	.0310	.0470	.0620	.0780	.0930	.1250	.1870	.2500
							13% Dia. ae				25% Dia. ae				
			Max.	Air	MMS		<2 Dia. ap				<2 Dia. ap				
vc - SFM Increase speed by 30% for ALtima® coated tools.						fz - in/tooth									
Free Machining & Low Carbon Steels 1006, 1008, 1015, 1018, 1020, 1022, 1025, 1117, 1140, 1141, 11L08, 11L14, 1213, 12L13, 12L14, 1215, 1330	P	up to 28 Rc	•	•	•	400	0.00007	0.00015	0.00023	0.00027	0.00034	0.00040	0.00054	0.00081	0.00100
Medium Carbon & High Carbon Steels, Alloy Steels & Easy to Machine Tool Steels 1030, 1035, 1040, 1045, 1050, 1052, 1055, 1060, 1085, 1095, 1541, 1551, 9255, 2515, 3135, 3415, 4130, 4137, 4140, 4150, 4320, 4340, 4520, 5015, 5115, 5120, 5132, 5140, 5155, 6150, 8620, 9262, 9840, 52100, O1, O2, O6, S2, W1 to W310	P	28 to 38 Rc	•	•	•	300	0.00007	0.00015	0.00023	0.00027	0.00034	0.00040	0.00054	0.00081	0.00100
Tool Steels & Die Steels O7, M1, M2, M3, M4, M7, T1, T2, T4, T5, T8, T15, A2, A3, A6, A7, H10, H11, H12, H13, H19, H21, L3, L6, L7, P2, P20, S1, S5, S7, 52100, A 128, D2, D3, D4, D5, D7	P	28 to 44 Rc	•	•	•	200	0.00007	0.00015	0.00023	0.00027	0.00034	0.00040	0.00054	0.00081	0.00100
Hardened Steels	H	45-55 Rc	•	o	o	100	0.00010	0.00030	0.00050	0.00140	0.00180	0.00210	0.00300	0.00360	0.00420
Stainless Steel - Easy to Machine 430F, 301, 303, 410, 416 Annealed, 420F, 430, 430F	M	up to 28 Rc	•	x	o	400	0.00007	0.00015	0.00023	0.00027	0.00034	0.00040	0.00054	0.00081	0.00100
Stainless Steel - Moderately Difficult 301, 302, 303 High Tensile, 304, 304L, 305, 420, 15-5PH, 17-4PH, 17-7PH	M	up to 28 Rc	•	x	o	200	0.00007	0.00015	0.00023	0.00027	0.00034	0.00040	0.00054	0.00081	0.00100
Stainless Steel - Difficult to Machine 302B, 304B, 309, 310, 316, 316B, 316L, 316Ti, 317, 317L, 321, PH13-8Mo, Nitronics	M	over 28 Rc	•	x	o	150	0.00007	0.00015	0.00023	0.00027	0.00034	0.00040	0.00054	0.00081	0.00100
Cast Iron	K	160-200 HB	•	o	o	400	0.00007	0.00015	0.00023	0.00027	0.00034	0.00040	0.00054	0.00081	0.00100
Malleable / Ductile Cast Iron	K	200-250 HB	•	o	o	250	0.00007	0.00015	0.00023	0.00027	0.00034	0.00040	0.00054	0.00081	0.00100
High Temp Alloys Nimonics, Inconel, Monel, Hastelloy	S	up to 42 Rc	•	x	x	70	0.00004	0.00008	0.00015	0.00023	0.00027	0.00034	0.00040	0.00054	0.00080
Titanium Alloys 6Al-4V, 5Al-2.5 Sn, 6Al-2 Sn-4Zr-6Mo, 3Al-8V-6Cr4Mo-4Zr, 10V-2Fe-3Al, 13V-11Cr-3Al	S	up to 42 Rc	•	x	x	150	0.00004	0.00008	0.00015	0.00023	0.00027	0.00034	0.00040	0.00054	0.00080
Aluminum < 10 % Si	N		•			750	0.00007	0.00015	0.00023	0.00027	0.00034	0.00040	0.00054	0.00081	0.00100
Aluminum > 10 % Si	N														

Technical data provided should be considered advisory only as variations may be necessary depending on the particular application.

For product information, call your local distributor.

Micro End Mill Recommended Cutting Data - Profile Milling

Length	2 Flute Series		3 Flute Series		4 Flute Series			
Standard	121	150	116	145	111	140	117	114
Long Length	123				122			132

Metric - Standard / Long Length

Ball Nose End Mills - If axial depth (ap) is less than the ball diameter, the speed is figured using the effective cutting diameter.

For diameters > 6mm, see Chart on page 354.

Workpiece Material Group	ISO	Hardness	Coolant			Profile Milling 	End Mill Diameter (mm)									
			● Preferred ○ Possible x Not Possible				vc - m/min Increase speed by 30% for ALtima® coated tools.	.4	.8	1.2	1.6	2.0	2.5	3.0	5.0	6.0
			Max.	Air	MMS			13% Dia. ae			25% Dia. ae					
								<2 Dia. ap			<2 Dia. ap					
												fz - mm/tooth				
Free Machining & Low Carbon Steels 1006, 1008, 1015, 1018, 1020, 1022, 1025, 1117, 1140, 1141, 11L08, 11L14, 1213, 12L13, 12L14, 1215, 1330	P	up to 28 Rc	●	●	●	122	0.00170	0.00380	0.00580	0.00680	0.00860	0.01010	0.01370	0.02050	0.02540	
Medium Carbon & High Carbon Steels, Alloy Steels & Easy to Machine Tool Steels 1030, 1035, 1040, 1045, 1050, 1052, 1055, 1060, 1085, 1095, 1541, 1551, 9255, 2515, 3135, 3415, 4130, 4137, 4140, 4150, 4320, 4340, 4520, 5015, 5115, 5120, 5132, 5140, 5155, 6150, 8620, 9262, 9840, 52100, O1, O2, O6, S2, W1 to W310	P	28 to 38 Rc	●	●	●	92	0.00170	0.00380	0.00580	0.00680	0.00860	0.01010	0.01370	0.02050	0.02540	
Tool Steels & Die Steels O7, M1, M2, M3, M4, M7, T1, T2, T4, T5, T8, T15, A2, A3, A6, A7, H10, H11, H12, H13, H19, H21, L3, L6, L7, P2, P20, S1, S5, S7, 52100, A 128, D2, D3, D4, D5, D7	P	28 to 44 Rc	●	●	●	60	0.00170	0.00380	0.00580	0.00680	0.00860	0.01010	0.01370	0.02050	0.02540	
Hardened Steels	H	45-55 Rc	●	○	○	30	0.00250	0.00760	0.01270	0.03500	0.04500	0.05300	0.07600	0.09100	0.10600	
Stainless Steel - Easy to Machine 430F, 301, 303, 410, 416 Annealed, 420F, 430, 430F	M	up to 28 Rc	●	x	○	122	0.00170	0.00360	0.00580	0.00680	0.00860	0.01010	0.01370	0.02050	0.02540	
Stainless Steel - Moderately Difficult 301, 302, 303 High Tensile, 304, 304L, 305, 420, 15-5PH, 17-4PH, 17-7PH	M	up to 28 Rc	●	x	○	61	0.00170	0.00360	0.00580	0.00680	0.00860	0.01010	0.01370	0.02050	0.02540	
Stainless Steel - Difficult to Machine 302B, 304B, 309, 310, 316, 316B, 316L, 316Ti, 317, 317L, 321, PH13-8Mo, Nitronics	M	over 28 Rc	●	x	○	45	0.00170	0.00360	0.00580	0.00680	0.00860	0.01010	0.01370	0.02050	0.02540	
Cast Iron	K	160-200 HB	●	○	○	120	0.00170	0.00360	0.00580	0.00680	0.00860	0.01010	0.01370	0.02050	0.02540	
Malleable / Ductile Cast Iron	K	200-250 HB	●	○	○	76	0.00170	0.00360	0.00580	0.00680	0.00860	0.01010	0.01370	0.02050	0.02540	
High Temp Alloys Nimonic, Inconel, Monel, Hastelloy	S	up to 42 Rc	●	x	x	22	0.00100	0.00200	0.00380	0.00580	0.00680	0.00860	0.01010	0.01370	0.02000	
Titanium Alloys 6Al-4V, 5Al-2.5 Sn, 6Al-2 Sn-4Zr-6Mo, 3Al-8V-6Cr-4Mo-4Zr, 10V-2Fe-3Al, 13V-11Cr-3Al	S	up to 42 Rc	●	x	x	45	0.00100	0.00200	0.00380	0.00580	0.00680	0.00860	0.01010	0.01370	0.02000	
Aluminum < 10 % Si	N		●			228	0.00170	0.00360	0.00580	0.00680	0.00860	0.01010	0.01370	0.02050	0.02540	
Aluminum > 10 % Si	N		●				0.00170	0.00360	0.00580	0.00680	0.00860	0.01010	0.01370	0.02050	0.02540	

Technical data provided should be considered advisory only as variations may be necessary depending on the particular application.





Micro End Mill Recommended Cutting Data - Profile Milling

Length	2 Flute Series		3 Flute Series	4 Flute Series	
Stub	164	166	169	163	165

Inch - Stub Length

Ball Nose End Mills - If axial depth (ap) is less than the ball diameter, the speed is figured using the effective cutting diameter.

For diameters > 1/4", see Chart on page 354.

Workpiece Material Group	ISO	Hardness	Coolant			Profile Milling 	End Mill Diameter (Inch)									
			• Preferred o Possible x Not Possible				vc - SFM Increase speed by 30% for ALtima® coated tools.	.0150	.0310	.0470	.0620	.0780	.0930	.1250	.1870	.2500
								13% Dia. ae			25% Dia. ae					
			Max.	Air	MMS			<1 Dia. ap			<1 Dia. ap					
fz - in/tooth																
Free Machining & Low Carbon Steels 1006, 1008, 1015, 1018, 1020, 1022, 1025, 1117, 1140, 1141, 11L08, 11L14, 1213, 12L13, 12L14, 1215, 1330	P	up to 28 Rc	•	•	•	400	0.00007	0.00015	0.00023	0.00027	0.00034	0.00040	0.00054	0.00081	0.00100	
Medium Carbon & High Carbon Steels, Alloy Steels & Easy to Machine Tool Steels 1030, 1035, 1040, 1045, 1050, 1052, 1055, 1060, 1085, 1095, 1541, 1551, 9255, 2515, 3135, 3415, 4130, 4137, 4140, 4150, 4320, 4340, 4520, 5015, 5115, 5120, 5132, 5140, 5155, 6150, 8620, 9262, 9840, 52100, O1, O2, O6, S2, W1 to W310	P	28 to 38 Rc	•	•	•	300	0.00007	0.00015	0.00023	0.00027	0.00034	0.00040	0.00054	0.00081	0.00100	
Tool Steels & Die Steels O7, M1, M2, M3, M4, M7, T1, T2, T4, T5, T8, T15, A2, A3, A6, A7, H10, H11, H12, H13, H19, H21, L3, L6, L7, P2, P20, S1, S5, S7, 52100, A 128, D2, D3, D4, D5, D7	P	28 to 44 Rc	•	•	•	200	0.00007	0.00015	0.00023	0.00027	0.00034	0.00040	0.00054	0.00081	0.00100	
Hardened Steels	H	45-55 Rc	•	o	o	100	0.00010	0.00030	0.00050	0.00140	0.00180	0.00210	0.00300	0.00360	0.00420	
Stainless Steel - Easy to Machine 430F, 301, 303, 410, 416 Annealed, 420F, 430, 430F	M	up to 28 Rc	•	x	o	400	0.00007	0.00015	0.00023	0.00027	0.00034	0.00040	0.00054	0.00081	0.00100	
Stainless Steel - Moderately Difficult 301, 302, 303 High Tensile, 304, 304L, 305, 420, 15-5PH, 17-4PH, 17-7PH	M	up to 28 Rc	•	x	o	200	0.00007	0.00015	0.00023	0.00027	0.00034	0.00040	0.00054	0.00081	0.00100	
Stainless Steel - Difficult to Machine 302B, 304B, 309, 310, 316, 316B, 316L, 316Ti, 317, 317L, 321, PH13-8Mo, Nitronics	M	over 28 Rc	•	x	o	150	0.00007	0.00015	0.00023	0.00027	0.00034	0.00040	0.00054	0.00081	0.00100	
Cast Iron	K	160-200 HB	•	o	o	400	0.00007	0.00015	0.00023	0.00027	0.00034	0.00040	0.00054	0.00081	0.00100	
Malleable / Ductile Cast Iron	K	200-250 HB	•	o	o	250	0.00007	0.00015	0.00023	0.00027	0.00034	0.00040	0.00054	0.00081	0.00100	
High Temp Alloys Nimonic, Inconel, Monel, Hastelloy	S	up to 42 Rc	•	x	x	70	0.00004	0.00008	0.00015	0.00023	0.00027	0.00034	0.00040	0.00054	0.00080	
Titanium Alloys 6Al-4V, 5Al-2.5 Sn, 6Al-2 Sn-4Zr-6Mo, 3Al-8V-6Cr4Mo-4Zr, 10V-2Fe-3Al, 13V-11Cr-3Al	S	up to 42 Rc	•	x	x	150	0.00004	0.00008	0.00015	0.00023	0.00027	0.00034	0.00040	0.00054	0.00080	
Aluminum < 10 % Si	N		•			750	0.00007	0.00015	0.00023	0.00027	0.00034	0.00040	0.00054	0.00081	0.00100	
Aluminum > 10 % Si	N		•			750	0.00007	0.00015	0.00023	0.00027	0.00034	0.00040	0.00054	0.00081	0.00100	

Micro End Mill Recommended Cutting Data - Profile Milling

Length	2 Flute Series		3 Flute Series	4 Flute Series	
Stub	164	166	169	163	165

Metric - Stub Length

Ball Nose End Mills - If axial depth (ap) is less than the ball diameter, the speed is figured using the effective cutting diameter.

For diameters > 6mm, see Chart on page 354.

Workpiece Material Group	ISO	Hardness	Coolant			Profile Milling 	End Mill Diameter (mm)									
			● Preferred ○ Possible x Not Possible				vc - m/min Increase speed by 30% for ALtima® coated tools.	.4	.8	1.2	1.6	2.0	2.5	3.0	5.0	6.0
			Max.	Air	MMS			13% Dia. ae				25% Dia. ae				
								<1 Dia. ap				<1 Dia. ap				
						fz - mm/tooth										
Free Machining & Low Carbon Steels 1006, 1008, 1015, 1018, 1020, 1022, 1025, 1117, 1140, 1141, 11L08, 11L14, 1213, 12L13, 12L14, 1215, 1330	P	up to 28 Rc	•	•	•	122	0.00170	0.00380	0.00580	0.00680	0.00860	0.01010	0.01370	0.02050	0.02540	
Medium Carbon & High Carbon Steels, Alloy Steels & Easy to Machine Tool Steels 1030, 1035, 1040, 1045, 1050, 1052, 1055, 1060, 1085, 1095, 1541, 1551, 9255, 2515, 3135, 3415, 4130, 4137, 4140, 4150, 4320, 4340, 4520, 5015, 5115, 5120, 5132, 5140, 5155, 6150, 8620, 9262, 9840, 52100, O1, O2, O6, S2, W1 to W310	P	28 to 38 Rc	•	•	•	92	0.00170	0.00380	0.00580	0.00680	0.00860	0.01010	0.01370	0.02050	0.02540	
Tool Steels & Die Steels O7, M1, M2, M3, M4, M7, T1, T2, T4, T5, T8, T15, A2, A3, A6, A7, H10, H11, H12, H13, H19, H21, L3, L6, L7, P2, P20, S1, S5, S7, 52100, A 128, D2, D3, D4, D5, D7	P	28 to 44 Rc	•	•	•	60	0.00170	0.00380	0.00580	0.00680	0.00860	0.01010	0.01370	0.02050	0.02540	
Hardened Steels	H	45-55 Rc	•	o	o	30	0.00250	0.00760	0.01270	0.03500	0.04500	0.05300	0.07600	0.09100	0.10600	
Stainless Steel - Easy to Machine 430F, 301, 303, 410, 416 Annealed, 420F, 430, 430F	M	up to 28 Rc	•	x	o	122	0.00170	0.00360	0.00580	0.00680	0.00860	0.01010	0.01370	0.02050	0.02540	
Stainless Steel - Moderately Difficult 301, 302, 303 High Tensile, 304, 304L, 305, 420, 15-5PH, 17-4PH, 17-7PH	M	up to 28 Rc	•	x	o	61	0.00170	0.00360	0.00580	0.00680	0.00860	0.01010	0.01370	0.02050	0.02540	
Stainless Steel - Difficult to Machine 302B, 304B, 309, 310, 316, 316B, 316L, 316Ti, 317, 317L, 321, PH13-8Mo, Nitronics	M	over 28 Rc	•	x	o	45	0.00170	0.00360	0.00580	0.00680	0.00860	0.01010	0.01370	0.02050	0.02540	
Cast Iron	K	160-200 HB	•	o	o	120	0.00170	0.00360	0.00580	0.00680	0.00860	0.01010	0.01370	0.02050	0.02540	
Malleable / Ductile Cast Iron	K	200-250 HB	•	o	o	76	0.00170	0.00360	0.00580	0.00680	0.00860	0.01010	0.01370	0.02050	0.02540	
High Temp Alloys Nimonics, Inconel, Monel, Hastelloy	S	up to 42 Rc	•	x	x	22	0.00100	0.00200	0.00380	0.00580	0.00680	0.00860	0.01010	0.01370	0.02000	
Titanium Alloys 6Al-4V, 5Al-2.5 Sn, 6Al-2 Sn-4Zr-6Mo, 3Al-8V-6Cr4Mo-4Zr, 10V-2Fe-3Al, 13V-11Cr-3Al	S	up to 42 Rc	•	x	x	45	0.00100	0.00200	0.00380	0.00580	0.00680	0.00860	0.01010	0.01370	0.02000	
Aluminum < 10 % Si	N		•			228	0.00170	0.00360	0.00580	0.00680	0.00860	0.01010	0.01370	0.02050	0.02540	
Aluminum > 10 % Si	N		•			228	0.00170	0.00360	0.00580	0.00680	0.00860	0.01010	0.01370	0.02050	0.02540	

Technical data provided should be considered advisory only as variations may be necessary depending on the particular application.

TuffCut® GP





Micro End Mill Recommended Cutting Data - Slotting

Length	2 Flute Series		3 Flute Series	
Standard	121	150	116	145
Long Length	123			

Inch - Standard / Long Length 2-3 Flute

Ball Nose End Mills - If axial depth (ap) is less than the ball diameter, the speed is figured using the effective cutting diameter.

For diameters > 1/4", see Chart on page 354.

Workpiece Material Group	ISO	Hardness	Coolant			Slotting	End Mill Diameter (Inch)								
			● Preferred	○ Possible	✗ Not Possible		.0150	.0310	.0470	.0620	.0780	.0930	.1250	.1870	.2500
							14%-Dia. ap			35%-Dia. ap					
			Max.	Air	MMS	vc - SFM Increase speed by 30% for ALtima® coated tools.	fz - in/tooth								
Free Machining & Low Carbon Steels 1006, 1008, 1015, 1018, 1020, 1022, 1025, 1117, 1140, 1141, 11L08, 11L14, 1213, 12L13, 12L14, 1215, 1330	P	up to 28 Rc	●	●	●	400	.0001	.0001	.0002	.0002	.0003	.0004	.0005	.0007	.0010
Medium Carbon & High Carbon Steels, Alloy Steels & Easy to Machine Tool Steels 1030, 1035, 1040, 1045, 1050, 1052, 1055, 1060, 1085, 1095, 1541, 1551, 9255, 2515, 3135, 3415, 4130, 4137, 4140, 4150, 4320, 4340, 4520, 5015, 5115, 5120, 5132, 5140, 5155, 6150, 8620, 9262, 9840, 52100, O1, O2, O6, S2, W1 to W310	P	28 to 38 Rc	●	●	●	300	.0001	.0001	.0002	.0002	.0003	.0003	.0004	.0007	.0009
Tool Steels & Die Steels O7, M1, M2, M3, M4, M7, T1, T2, T4, T5, T8, T15, A2, A3, A6, A7, H10, H11, H12, H13, H19, H21, L3, L6, L7, P2, P20, S1, S5, S7, 52100, A 128, D2, D3, D4, D5, D7	P	28 to 44 Rc	●	●	●	200	.0001	.0001	.0002	.0002	.0002	.0003	.0004	.0006	.0008
Hardened Steels	H	35-45 Rc	●	○	○	100	.0001	.0001	.0001	.0001	.0001	.0002	.0002	.0003	.0004
Stainless Steel - Easy to Machine 430F, 301, 303, 410, 416 Annealed, 420F, 430, 430F	M	up to 28 Rc	●	✗	○	400	.0001	.0001	.0002	.0002	.0003	.0004	.0005	.0007	.0010
Stainless Steel - Moderately Difficult 301, 302, 303 High Tensile, 304, 304L, 305, 420, 15-5PH, 17-4PH, 17-7PH	M	up to 28 Rc	●	✗	○	200	.0001	.0001	.0002	.0002	.0003	.0003	.0004	.0007	.0009
Stainless Steel - Difficult to Machine 302B, 304B, 309, 310, 316, 316B, 316L, 316Ti, 317, 317L, 321, PH13-8Mo, Nitronics	M	over 28 Rc	●	✗	○	150	.0001	.0001	.0001	.0001	.0002	.0002	.0003	.0004	.0005
Cast Iron	K	160-200 HB	●	○	○	400	.0001	.0001	.0002	.0002	.0003	.0004	.0005	.0007	.0010
Malleable / Ductile Cast Iron	K	200-250 HB	●	○	○	250	.0001	.0001	.0002	.0002	.0003	.0003	.0004	.0007	.0009
High Temp Alloys Nimonic, Inconel, Monel, Hastelloy	S	up to 42 Rc	●	✗	✗	70	.0001	.0001	.0001	.0001	.0002	.0002	.0003	.0004	.0005
Titanium Alloys 6Al-4V, 5Al-2.5 Sn, 6Al-2 Sn-4Zr-6Mo, 3Al-8V-6Cr4Mo-4Zr, 10V-2Fe-3Al, 13V-11Cr-3Al	S	up to 42 Rc	●	✗	✗	150	.0001	.0001	.0001	.0001	.0002	.0002	.0003	.0004	.0005
Aluminum < 10 % Si	N		●			750	.0002	.0003	.0005	.0006	.0007	.0008	.0011	.0017	.0022
Aluminum > 10 % Si	N		●			750	.0002	.0003	.0005	.0006	.0007	.0008	.0011	.0017	.0022

Technical data provided should be considered advisory only as variations may be necessary depending on the particular application.

For product information, call your local distributor.





Micro End Mill Recommended Cutting Data - Slotting

Length	2 Flute Series		3 Flute Series	
Standard	121	150	116	145
Long Length	123			

Metric - Standard / Long Length 2-3 Flute

Ball Nose End Mills - If axial depth (ap) is less than the ball diameter, the speed is figured using the effective cutting diameter.

For diameters > 6mm, see Chart on page 354.

Workpiece Material Group	ISO	Hardness	Coolant			Slotting	End Mill Diameter (mm)								
			• Preferred	o Possible	x Not Possible		.4	.8	1.2	1.6	2.0	2.5	3.0	5.0	6.0
							14%-Dia. ap				35%-Dia. ap				
			Max.	Air	MMS	vc-m/min Increase speed by 30% for ALtima® coated tools.	fz - mm/tooth								
Free Machining & Low Carbon Steels 1006, 1008, 1015, 1018, 1020, 1022, 1025, 1117, 1140, 1141, 11L08, 11L14, 1213, 12L13, 12L14, 1215, 1330	P	up to 28 Rc	•	•	•	122	.0018	.0033	.0051	.0058	.0074	.0089	.0119	.0180	.0241
Medium Carbon & High Carbon Steels, Alloy Steels & Easy to Machine Tool Steels 1030, 1035, 1040, 1045, 1050, 1052, 1055, 1060, 1085, 1095, 1541, 1551, 9255, 2515, 3135, 3415, 4130, 4137, 4140, 4150, 4320, 4340, 4520, 5015, 5115, 5120, 5132, 5140, 5155, 6150, 8620, 9262, 9840, 52100, O1, O2, O6, S2, W1 to W310	P	28 to 38 Rc	•	•	•	100	.0015	.0030	.0048	.0053	.0069	.0081	.0109	.0165	.0218
Tool Steels & Die Steels O7, M1, M2, M3, M4, M7, T1, T2, T4, T5, T8, T15, A2, A3, A6, A7, H10, H11, H12, H13, H19, H21, L3, L6, L7, P2, P20, S1, S5, S7, 52100, A 128, D2, D3, D4, D5, D7	P	28 to 44 Rc	•	•	•	60	.0013	.0028	.0043	.0048	.0061	.0074	.0098	.0147	.0198
Hardened Steels	H	35-45 Rc	•	o	o	30	.0008	.0015	.0023	.0028	.0033	.0041	.0056	.0081	.0109
Stainless Steel - Easy to Machine 430F, 301, 303, 410, 416 Annealed, 420F, 430, 430F	M	up to 28 Rc	•	x	o	122	.0018	.0033	.0051	.0058	.0074	.0089	.0119	.0180	.0241
Stainless Steel - Moderately Difficult 301, 302, 303 High Tensile, 304, 304L, 305, 420, 15-5PH, 17-4PH, 17-7PH	M	up to 28 Rc	•	x	o	60	.0015	.0030	.0048	.0053	.0069	.0081	.0109	.0165	.0218
Stainless Steel - Difficult to Machine 302B, 304B, 309, 310, 316, 316B, 316L, 316Ti, 317, 317L, 321, PH13-8Mo, Nitronics	M	over 28 Rc	•	x	o	45	.0010	.0020	.0030	.0033	.0043	.0051	.0069	.0102	.0137
Cast Iron	K	160-200 HB	•	o	o	120	.0018	.0033	.0051	.0058	.0074	.0089	.0119	.0180	.0241
Malleable / Ductile Cast Iron	K	200-250 HB	•	o	o	76	.0015	.0030	.0048	.0053	.0069	.0081	.0109	.0165	.0218
High Temp Alloys Nimonic, Inconel, Monel, Hastelloy	S	up to 42 Rc	•	x	x	22	.0010	.0020	.0030	.0033	.0043	.0051	.0069	.0102	.0137
Titanium Alloys 6Al-4V, 5Al-2.5 Sn, 6Al-2 Sn-4Zr-6Mo, 3Al-8V-6Cr4Mo-4Zr, 10V-2Fe-3Al, 13V-11Cr-3Al	S	up to 42 Rc	•	x	x	45	.0010	.0020	.0030	.0033	.0043	.0051	.0069	.0102	.0137
Aluminum < 10 % Si	N		•			228	.0038	.0078	.0114	.0139	.0175	.0208	.0279	.0419	.0558
Aluminum > 10 % Si	N														

Technical data provided should be considered advisory only as variations may be necessary depending on the particular application.





Micro End Mill Recommended Cutting Data - Slotting

Length	2 Flute Series		3 Flute Series
Stub	164	166	169

Inch - Stub Length 2-3 Flute

Ball Nose End Mills - If axial depth (ap) is less than the ball diameter, the speed is figured using the effective cutting diameter.

For diameters > 1/4", see Chart on page 354.

Workpiece Material Group	ISO	Hardness	Coolant			Slotting	End Mill Diameter (Inch)								
			● Preferred	○ Possible	✗ Not Possible		.0150	.0310	.0470	.0620	.0780	.0930	.1250	.1870	.2500
							14%-Dia. ap				35%-Dia. ap				
			Max.	Air	MMS		fz - in/tooth								
Free Machining & Low Carbon Steels 1006, 1008, 1015, 1018, 1020, 1022, 1025, 1117, 1140, 1141, 11L08, 11L14, 1213, 12L13, 12L14, 1215, 1330	P	up to 28 Rc	●	●	●	400	.0001	.0002	.0002	.0003	.0003	.0004	.0005	.0008	.0010
Medium Carbon & High Carbon Steels, Alloy Steels & Easy to Machine Tool Steels 1030, 1035, 1040, 1045, 1050, 1052, 1055, 1060, 1085, 1095, 1541, 1551, 9255, 2515, 3135, 3415, 4130, 4137, 4140, 4150, 4320, 4340, 4520, 5015, 5115, 5120, 5132, 5140, 5155, 6150, 8620, 9262, 9840, 52100, O1, O2, O6, S2, W1 to W310	P	28 to 38 Rc	●	●	●	300	.0001	.0001	.0002	.0002	.0003	.0004	.0005	.0007	.0010
Tool Steels & Die Steels O7, M1, M2, M3, M4, M7, T1, T2, T4, T5, T8, T15, A2, A3, A6, A7, H10, H11, H12, H13, H19, H21, L3, L6, L7, P2, P20, S1, S5, S7, 52100, A 128, D2, D3, D4, D5, D7	P	28 to 44 Rc	●	●	●	200	.0001	.0001	.0002	.0002	.0003	.0004	.0006	.0008	
Hardened Steels	H	35-45 Rc	●	○	○	100	.0001	.0001	.0001	.0001	.0002	.0002	.0003	.0004	
Stainless Steel - Easy to Machine 430F, 301, 303, 410, 416 Annealed, 420F, 430, 430F	M	up to 28 Rc	●	✗	○	400	.0001	.0001	.0002	.0002	.0003	.0004	.0005	.0007	.0010
Stainless Steel - Moderately Difficult 301, 302, 303 High Tensile, 304, 304L, 305, 420, 15-5PH, 17-4PH, 17-7PH	M	up to 28 Rc	●	✗	○	200	.0001	.0001	.0002	.0002	.0003	.0003	.0004	.0007	.0009
Stainless Steel - Difficult to Machine 302B, 304B, 309, 310, 316, 316B, 316L, 316Ti, 317, 317L, 321, PH13-8Mo, Nitronics	M	over 28 Rc	●	✗	○	150	.0001	.0001	.0001	.0001	.0002	.0002	.0003	.0004	.0005
Cast Iron	K	160-200 HB	●	○	○	400	.0001	.0002	.0002	.0003	.0003	.0004	.0005	.0008	.0010
Malleable / Ductile Cast Iron	K	200-250 HB	●	○	○	250	.0001	.0001	.0002	.0002	.0003	.0004	.0005	.0007	.0010
High Temp Alloys Nimonic, Inconel, Monel, Hastelloy	S	up to 42 Rc	●	✗	✗	70	.0001	.0001	.0001	.0001	.0002	.0002	.0003	.0004	.0005
Titanium Alloys 6Al-4V, 5Al-2.5 Sn, 6Al-2 Sn-4Zr-6Mo, 3Al-8V-6Cr4Mo-4Zr, 10V-2Fe-3Al, 13V-11Cr-3Al	S	up to 42 Rc	●	✗	✗	150	.0001	.0001	.0001	.0001	.0002	.0002	.0003	.0004	.0005
Aluminum < 10 % Si	N		●			750	.0002	.0003	.0005	.0006	.0007	.0008	.0011	.0017	.0022
Aluminum > 10 % Si	N														

Technical data provided should be considered advisory only as variations may be necessary depending on the particular application.

For product information, call your local distributor.





Micro End Mill Recommended Cutting Data - Slotting

Length	2 Flute Series		3 Flute Series
Stub	164	166	169

Metric - Stub Length 2-3 Flute

Ball Nose End Mills - If axial depth (ap) is less than the ball diameter, the speed is figured using the effective cutting diameter.

For diameters > 6mm, see Chart on page 354.

Workpiece Material Group	ISO	Hardness	Coolant			Slotting	End Mill Diameter (mm)								
			● Preferred	○ Possible	✗ Not Possible		.4	.8	1.2	1.6	2.0	2.5	3.0	5.0	6.0
							14%-Dia. ap			35%-Dia. ap					
			Max.	Air	MMS	vc - m/min Increase speed by 30% for ALtima® coated tools.	fz - mm/tooth								
Free Machining & Low Carbon Steels 1006, 1008, 1015, 1018, 1020, 1022, 1025, 1117, 1140, 1141, 11L08, 11L14, 1213, 12L13, 12L14, 1215, 1330	P	up to 28 Rc	●	●	●	122	.0017	.0038	.0056	.0066	.0081	.0099	.0132	.0198	.0254
Medium Carbon & High Carbon Steels, Alloy Steels & Easy to Machine Tool Steels 1030, 1035, 1040, 1045, 1050, 1052, 1055, 1060, 1085, 1095, 1541, 1551, 9255, 2515, 3135, 3415, 4130, 4137, 4140, 4150, 4320, 4340, 4520, 5015, 5115, 5120, 5132, 5140, 5155, 6150, 8620, 9262, 9840, 52100, O1, O2, O6, S2, W1 to W310	P	28 to 38 Rc	●	●	●	100	.0015	.0036	.0053	.0060	.0076	.0089	.0121	.0180	.0241
Tool Steels & Die Steels O7, M1, M2, M3, M4, M7, T1, T2, T4, T5, T8, T15, A2, A3, A6, A7, H10, H11, H12, H13, H19, H21, L3, L6, L7, P2, P20, S1, S5, S7, 52100, A 128, D2, D3, D4, D5, D7	P	28 to 44 Rc	●	●	●	60	.0013	.0028	.0043	.0048	.0061	.0074	.0098	.0147	.0198
Hardened Steels	H	35-45 Rc	●	○	○	30	.0008	.0015	.0023	.0028	.0033	.0041	.0056	.0081	.0109
Stainless Steel - Easy to Machine 430F, 301, 303, 410, 416 Annealed, 420F, 430, 430F	M	up to 28 Rc	●	✗	○	122	.0018	.0033	.0051	.0058	.0074	.0089	.0119	.0180	.0241
Stainless Steel - Moderately Difficult 301, 302, 303 High Tensile, 304, 304L, 305, 420, 15-5PH, 17-4PH, 17-7PH	M	up to 28 Rc	●	✗	○	60	.0015	.0030	.0048	.0053	.0069	.0081	.0109	.0165	.0218
Stainless Steel - Difficult to Machine 302B, 304B, 309, 310, 316, 316B, 316L, 316Ti, 317, 317L, 321, PH13-8Mo, Nitronics	M	over 28 Rc	●	✗	○	45	.0010	.0020	.0030	.0033	.0043	.0051	.0069	.0102	.0137
Cast Iron	K	160-200 HB	●	○	○	120	.0017	.0038	.0055	.0066	.0081	.0099	.0132	.0198	.0254
Malleable / Ductile Cast Iron	K	200-250 HB	●	○	○	76	.0015	.0035	.0053	.0060	.0076	.0088	.0121	.0180	.0241
High Temp Alloys Nimonic, Inconel, Monel, Hastelloy	S	up to 42 Rc	●	✗	✗	22	.0010	.0020	.0030	.0033	.0043	.0051	.0069	.0102	.0137
Titanium Alloys 6Al-4V, 5Al-2.5 Sn, 6Al-2 Sn-4Zr-6Mo, 3 Al-8V-6Cr-4Mo-4Zr, 10V-2Fe-3Al, 13V-11Cr-3Al	S	up to 42 Rc	●	✗	✗	45	.0010	.0020	.0030	.0033	.0043	.0051	.0069	.0102	.0137
Aluminum < 10 % Si	N		●			230	.0038	.0078	.0114	.0139	.0175	.0208	.0279	.0419	.0558
Aluminum > 10 % Si	N														

Technical data provided should be considered advisory only as variations may be necessary depending on the particular application.





Micro End Mill Recommended Cutting Data - Slotting

Length	4 Flute Series			
Standard	111	140	117	114
Long Length	122			132

Inch - Standard / Long Length 4 Flute

Ball Nose End Mills - If axial depth (ap) is less than the ball diameter, the speed is figured using the effective cutting diameter.

For diameters > 1/4", see Chart on page 354.

Workpiece Material Group	ISO	Hardness	Coolant			Slotting	End Mill Diameter (Inch)								
			● Preferred	○ Possible	✗ Not Possible		.0150	.0310	.0470	.0620	.0780	.0930	.1250	.1870	.2500
							14%-Dia. ap			35%-Dia. ap					
			Max.	Air	MMS	vc - SFM Increase speed by 30% for ALtima® coated tools.	fz - in/tooth								
Free Machining & Low Carbon Steels 1006, 1008, 1015, 1018, 1020, 1022, 1025, 1117, 1140, 1141, 11L08, 11L14, 1213, 12L13, 12L14, 1215, 1330	P	up to 28 Rc	●	●	●	400	.0001	.0001	.0002	.0002	.0003	.0004	.0005	.0007	.0010
Medium Carbon & High Carbon Steels, Alloy Steels & Easy to Machine Tool Steels 1030, 1035, 1040, 1045, 1050, 1052, 1055, 1060, 1085, 1095, 1541, 1551, 9255, 2515, 3135, 3415, 4130, 4137, 4140, 4150, 4320, 4340, 4520, 5015, 5115, 5120, 5132, 5140, 5155, 6150, 8620, 9262, 9840, 52100, O1, O2, O6, S2, W1 to W310	P	28 to 38 Rc	●	●	●	300	.0001	.0001	.0002	.0002	.0003	.0003	.0004	.0007	.0009
Tool Steels & Die Steels O7, M1, M2, M3, M4, M7, T1, T2, T4, T5, T8, T15, A2, A3, A6, A7, H10, H11, H12, H13, H19, H21, L3, L6, L7, P2, P20, S1, S5, S7, 52100, A 128, D2, D3, D4, D5, D7	P	28 to 44 Rc	●	●	●	200	.0001	.0001	.0002	.0002	.0002	.0003	.0004	.0006	.0008
Hardened Steels	H	35-45 Rc	●	○	○	100	.0001	.0001	.0001	.0001	.0001	.0002	.0002	.0003	.0004
Stainless Steel - Easy to Machine 430F, 301, 303, 410, 416 Annealed, 420F, 430, 430F	M	up to 28 Rc	●	✗	○	400	.0001	.0001	.0002	.0002	.0003	.0004	.0005	.0007	.0010
Stainless Steel - Moderately Difficult 301, 302, 303 High Tensile, 304, 304L, 305, 420, 15-5PH, 17-4PH, 17-7PH	M	up to 28 Rc	●	✗	○	200	.0001	.0001	.0002	.0002	.0003	.0003	.0004	.0007	.0009
Stainless Steel - Difficult to Machine 302B, 304B, 309, 310, 316, 316B, 316L, 316Ti, 317, 317L, 321, PH13-8Mo, Nitronics	M	over 28 Rc	●	✗	○	150	.0001	.0001	.0001	.0001	.0002	.0002	.0003	.0004	.0005
Cast Iron	K	160-200 HB	●	○	○	400	.0001	.0001	.0002	.0002	.0003	.0004	.0005	.0007	.0010
Malleable / Ductile Cast Iron	K	200-250 HB	●	○	○	250	.0001	.0001	.0002	.0002	.0003	.0003	.0004	.0007	.0009
High Temp Alloys Nimonic, Inconel, Monel, Hastelloy	S	up to 42 Rc	●	✗	✗	70	.0001	.0001	.0001	.0001	.0002	.0002	.0003	.0004	.0005
Titanium Alloys 6Al-4V, 5Al-2.5 Sn, 6Al-2 Sn-4Zr-6Mo, 3Al-8V-6Cr4Mo-4Zr, 10V-2Fe-3Al, 13V-11Cr-3Al	S	up to 42 Rc	●	✗	✗	150	.0001	.0001	.0001	.0001	.0002	.0002	.0003	.0004	.0005
Aluminum < 10 % Si	N		●			750	.0002	.0003	.0005	.0006	.0007	.0008	.0011	.0017	.0022
Aluminum > 10 % Si	N		●												

Technical data provided should be considered advisory only as variations may be necessary depending on the particular application.

For product information, call your local distributor.





Micro End Mill Recommended Cutting Data - Slotting

Length	4 Flute Series			
Standard	111	140	117	114
Long Length	122			132

Metric - Standard / Long Length 4 Flute

Ball Nose End Mills - If axial depth (ap) is less than the ball diameter, the speed is figured using the effective cutting diameter.

For diameters > 6mm, see Chart on page 354.

Workpiece Material Group	ISO	Hardness	Coolant			Slotting	End Mill Diameter (mm)									
			● Preferred ○ Possible x Not Possible					.4	.8	1.2	1.6	2.0	2.5	3.0	5.0	6.0
								14%-Dia. ap			35%-Dia. ap					
			Max.	Air	MMS			fz - mm/tooth								
Free Machining & Low Carbon Steels 1006, 1008, 1015, 1018, 1020, 1022, 1025, 1117, 1140, 1141, 11L08, 11L14, 1213, 12L13, 12L14, 1215, 1330	P	up to 28 Rc	●	●	●	122	.0018	.0033	.0051	.0058	.0074	.0089	.0119	.0180	.0241	
Medium Carbon & High Carbon Steels, Alloy Steels & Easy to Machine Tool Steels 1030, 1035, 1040, 1045, 1050, 1052, 1055, 1060, 1085, 1095, 1541, 1551, 9255, 2515, 3135, 3415, 4130, 4137, 4140, 4150, 4320, 4340, 4520, 5015, 5115, 5120, 5132, 5140, 5155, 6150, 8620, 9262, 9840, 52100, O1, O2, O6, S2, W1 to W310	P	28 to 38 Rc	●	●	●	100	.0015	.0030	.0048	.0053	.0069	.0081	.0109	.0165	.0218	
Tool Steels & Die Steels O7, M1, M2, M3, M4, M7, T1, T2, T4, T5, T8, T15, A2, A3, A6, A7, H10, H11, H12, H13, H19, H21, L3, L6, L7, P2, P20, S1, S5, S7, 52100, A 128, D2, D3, D4, D5, D7	P	28 to 44 Rc	●	●	●	60	.0013	.0028	.0043	.0048	.0061	.0074	.0098	.0147	.0198	
Hardened Steels	H	35-45 Rc	●	○	○	30	.0008	.0015	.0023	.0028	.0033	.0041	.0056	.0081	.0109	
Stainless Steel - Easy to Machine 430F, 301, 303, 410, 416 Annealed, 420F, 430, 430F	M	up to 28 Rc	●	x	○	122	.0018	.0033	.0051	.0058	.0074	.0089	.0119	.0180	.0241	
Stainless Steel - Moderately Difficult 301, 302, 303 High Tensile, 304, 304L, 305, 420, 15-5PH, 17-4PH, 17-7PH	M	up to 28 Rc	●	x	○	60	.0015	.0030	.0048	.0053	.0069	.0081	.0109	.0165	.0218	
Stainless Steel - Difficult to Machine 302B, 304B, 309, 310, 316, 316B, 316L, 316Ti, 317, 317L, 321, PH13-8Mo, Nitronics	M	over 28 Rc	●	x	○	45	.0010	.0020	.0030	.0033	.0043	.0051	.0069	.0102	.0137	
Cast Iron	K	160-200 HB	●	○	○	120	.0018	.0033	.0051	.0058	.0074	.0089	.0119	.0180	.0241	
Malleable / Ductile Cast Iron	K	200-250 HB	●	○	○	76	.0015	.0030	.0048	.0053	.0069	.0081	.0109	.0165	.0218	
High Temp Alloys Nimonic, Inconel, Monel, Hastelloy	S	up to 42 Rc	●	x	x	22	.0010	.0020	.0030	.0033	.0043	.0051	.0069	.0102	.0137	
Titanium Alloys 6Al-4V, 5Al-2.5 Sn, 6Al-2 Sn-4Zr-6Mo, 3Al-8V-6Cr4Mo-4Zr, 10V-2Fe-3Al, 13V-11Cr-3Al	S	up to 42 Rc	●	x	x	45	.0010	.0020	.0030	.0033	.0043	.0051	.0069	.0102	.0137	
Aluminum < 10 % Si	N		●			228	.0038	.0078	.0114	.0139	.0175	.0208	.0279	.0419	.0558	
Aluminum > 10 % Si	N															

Technical data provided should be considered advisory only as variations may be necessary depending on the particular application.





Micro End Mill Recommended Cutting Data - Slotting

Length	4 Flute Series	
Stub	163	165

Inch - Stub Length 4 Flute

Ball Nose End Mills - If axial depth (ap) is less than the ball diameter, the speed is figured using the effective cutting diameter.

For diameters > 1/4", see Chart on page 354.

Workpiece Material Group	ISO	Hardness	Coolant			Slotting	End Mill Diameter (Inch)								
			• Preferred	o Possible	x Not Possible		.0150	.0310	.0470	.0620	.0780	.0930	.1250	.1870	.2500
							14%-Dia. ap			35%-Dia. ap					
			Max.	Air	MMS	vc - SFM Increase speed by 30% for ALtima® coated tools.	fz - in/tooth								
Free Machining & Low Carbon Steels 1006, 1008, 1015, 1018, 1020, 1022, 1025, 1117, 1140, 1141, 11L08, 11L14, 1213, 12L13, 12L14, 1215, 1330	P	up to 28 Rc	•	•	•	400	.0001	.0001	.0002	.0002	.0003	.0004	.0005	.0007	.0010
Medium Carbon & High Carbon Steels, Alloy Steels & Easy to Machine Tool Steels 1030, 1035, 1040, 1045, 1050, 1052, 1055, 1060, 1085, 1095, 1541, 1551, 9255, 2515, 3135, 3415, 4130, 4137, 4140, 4150, 4320, 4340, 4520, 5015, 5115, 5120, 5132, 5140, 5155, 6150, 8620, 9262, 9840, 52100, O1, O2, O6, S2, W1 to W310	P	28 to 38 Rc	•	•	•	300	.0001	.0001	.0002	.0002	.0003	.0003	.0004	.0007	.0009
Tool Steels & Die Steels O7, M1, M2, M3, M4, M7, T1, T2, T4, T5, T8, T15, A2, A3, A6, A7, H10, H11, H12, H13, H19, H21, L3, L6, L7, P2, P20, S1, S5, S7, 52100, A 128, D2, D3, D4, D5, D7	P	28 to 44 Rc	•	•	•	200	.0001	.0001	.0002	.0002	.0002	.0003	.0004	.0006	.0008
Hardened Steels	H	35-45 Rc	•	o	o	100	.0001	.0001	.0001	.0001	.0001	.0002	.0002	.0003	.0004
Stainless Steel - Easy to Machine 430F, 301, 303, 410, 416 Annealed, 420F, 430, 430F	M	up to 28 Rc	•	x	o	400	.0001	.0001	.0002	.0002	.0003	.0004	.0005	.0007	.0010
Stainless Steel - Moderately Difficult 301, 302, 303 High Tensile, 304, 304L, 305, 420, 15-5PH, 17-4PH, 17-7PH	M	up to 28 Rc	•	x	o	200	.0001	.0001	.0002	.0002	.0003	.0003	.0004	.0007	.0009
Stainless Steel - Difficult to Machine 302B, 304B, 309, 310, 316, 316B, 316L, 316Ti, 317, 317L, 321, PH13-8Mo, Nitronics	M	over 28 Rc	•	x	o	150	.0001	.0001	.0001	.0001	.0002	.0002	.0003	.0004	.0005
Cast Iron	K	160-200 HB	•	o	o	400	.0001	.0001	.0002	.0002	.0003	.0004	.0005	.0007	.0010
Malleable / Ductile Cast Iron	K	200-250 HB	•	o	o	250	.0001	.0001	.0002	.0002	.0003	.0003	.0004	.0007	.0009
High Temp Alloys Nimonic, Inconel, Monel, Hastelloy	S	up to 42 Rc	•	x	x	70	.0001	.0001	.0001	.0001	.0002	.0002	.0003	.0004	.0005
Titanium Alloys 6Al-4V, 5Al-2.5 Sn, 6Al-2 Sn-4Zr-6Mo, 3Al-8V-6Cr-4Mo-4Zr, 10V-2Fe-3Al, 13V-11Cr-3Al	S	up to 42 Rc	•	x	x	150	.0001	.0001	.0001	.0001	.0002	.0002	.0003	.0004	.0005
Aluminum < 10 % Si	N		•			750	.0002	.0003	.0005	.0006	.0007	.0008	.0011	.0017	.0022
Aluminum > 10 % Si	N		•			750	.0002	.0003	.0005	.0006	.0007	.0008	.0011	.0017	.0022

Technical data provided should be considered advisory only as variations may be necessary depending on the particular application.

For product information, call your local distributor.





Micro End Mill Recommended Cutting Data - Slotting

Length	4 Flute Series	
Stub	163	165

Metric - Stub Length 4 Flute

Ball Nose End Mills - If axial depth (ap) is less than the ball diameter, the speed is figured using the effective cutting diameter.

For diameters > 6mm, see Chart on page 354.

Workpiece Material Group	ISO	Hardness	Coolant			Slotting	End Mill Diameter (mm)								
			• Preferred	o Possible	x Not Possible		.4	.8	1.2	1.6	2.0	2.5	3.0	5.0	6.0
							14%-Dia. ap			35%-Dia. ap					
			Max.	Air	MMS	vc - m/min Increase speed by 30% for ALtima® coated tools.	fz - mm/tooth								
Free Machining & Low Carbon Steels 1006, 1008, 1015, 1018, 1020, 1022, 1025, 1117, 1140, 1141, 11L08, 11L14, 1213, 12L13, 12L14, 1215, 1330	P	up to 28 Rc	•	•	•	122	.0018	.0033	.0051	.0058	.0074	.0089	.0119	.0180	.0241
Medium Carbon & High Carbon Steels, Alloy Steels & Easy to Machine Tool Steels 1030, 1035, 1040, 1045, 1050, 1052, 1055, 1060, 1085, 1095, 1541, 1551, 9255, 2515, 3135, 3415, 4130, 4137, 4140, 4150, 4320, 4340, 4520, 5015, 5115, 5120, 5132, 5140, 5155, 6150, 8620, 9262, 9840, 52100, O1, O2, O6, S2, W1 to W310	P	28 to 38 Rc	•	•	•	100	.0015	.0030	.0048	.0053	.0069	.0081	.0109	.0165	.0218
Tool Steels & Die Steels O7, M1, M2, M3, M4, M7, T1, T2, T4, T5, T8, T15, A2, A3, A6, A7, H10, H11, H12, H13, H19, H21, L3, L6, L7, P2, P20, S1, S5, S7, 52100, A 128, D2, D3, D4, D5, D7	P	28 to 44 Rc	•	•	•	60	.0013	.0028	.0043	.0048	.0061	.0074	.0098	.0147	.0198
Hardened Steels	H	35-45 Rc	•	o	o	30	.0008	.0015	.0023	.0028	.0033	.0041	.0056	.0081	.0109
Stainless Steel - Easy to Machine 430F, 301, 303, 410, 416 Annealed, 420F, 430, 430F	M	up to 28 Rc	•	x	o	122	.0018	.0033	.0051	.0058	.0074	.0089	.0119	.0180	.0241
Stainless Steel - Moderately Difficult 301, 302, 303 High Tensile, 304, 304L, 305, 420, 15-5PH, 17-4PH, 17-7PH	M	up to 28 Rc	•	x	o	60	.0015	.0030	.0048	.0053	.0069	.0081	.0109	.0165	.0218
Stainless Steel - Difficult to Machine 302B, 304B, 309, 310, 316, 316B, 316L, 316Ti, 317, 317L, 321, PH13-8Mo, Nitronics	M	over 28 Rc	•	x	o	45	.0010	.0020	.0030	.0033	.0043	.0051	.0069	.0102	.0137
Cast Iron	K	160-200 HB	•	o	o	120	.0018	.0033	.0051	.0058	.0074	.0089	.0119	.0180	.0241
Malleable / Ductile Cast Iron	K	200-250 HB	•	o	o	76	.0015	.0030	.0048	.0053	.0069	.0081	.0109	.0165	.0218
High Temp Alloys Nimonic, Inconel, Monel, Hastelloy	S	up to 42 Rc	•	x	x	22	.0010	.0020	.0030	.0033	.0043	.0051	.0069	.0102	.0137
Titanium Alloys 6Al-4V, 5Al-2.5 Sn, 6Al-2 Sn-4Zr-6Mo, 3Al-8V-6Cr4Mo-4Zr, 10V-2Fe-3Al, 13V-11Cr-3Al	S	up to 42 Rc	•	x	x	45	.0010	.0020	.0030	.0033	.0043	.0051	.0069	.0102	.0137
Aluminum < 10 % Si	N		•			228	.0038	.0078	.0114	.0139	.0175	.0208	.0279	.0419	.0558
Aluminum > 10 % Si	N		•												

Technical data provided should be considered advisory only as variations may be necessary depending on the particular application.

TrueSize® Reamers

Solid Carbide TrueSize® Reamers Deliver High-Precision Hole Finishes

In applications that require high-precision hole finishes, or tighter diameter control, M.A. Ford® True Size® Reamers can be used with confidence. Solid Carbide Reamers are available in a wide range of sizes for virtually all materials, including cast iron, aluminum, stainless steel, exotic alloys, plastics and other non-ferrous materials.

Complete Family of Standard and Metric Sizes

M.A. Ford® stocks over 900 inch and metric size reamers in its product line, ranging from .013 inch to 16mm diameter. These products are available for immediate shipment. M.A. Ford® also maintains an inventory of pre-finished blanks, which can be finished to your precise specifications and shipped within 72 hours upon request. See Rapid Turn Around Service on page 376 for more information.

Material Removal Parameters

For proper finishing with a reamer, the correct amount of material must be left in the hole. If the hole is too close to the finish size, the reamer will tend to burnish the hole, and excessive tool wear will occur. If too much material is left, chips can clog the flutes of the reamer, resulting in a poor finish, poor size control, and possible tool breakage.

Refer to chart Total Stock Allowance on pages 403-404 as a starting point for reaming operations.

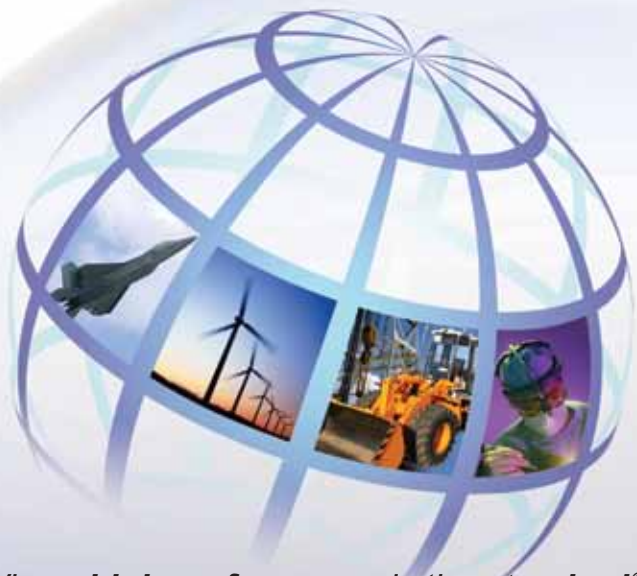

Where *high performance is the standard*®

TrueSize® Reamer Series

TrueSize® Series 270

TrueSize® Series 270L

TrueSize® Series 270P

TrueSize® Series 272

TrueSize® XP = Xtreme Precision 270P Straight Flute

One week turnaround on 270P orders.
(25 piece max.)

All M.A. Ford® Reamers
are ground between
centers to assure
maximum concentricity.



Made in USA

ISO 9001:2008 Certified



TrueSize® Carbide Range Reamer Straight Flute Series 270

TrueSize® Carbide Range Reamer Left Hand Spiral Series 270L

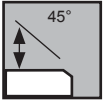

Before you order a 270 Series - check our listing of standard diameters in the 272 Series. Competitors special sizes are our standards!

Recommended for general purpose reaming in most non-ferrous and non-metallic materials. Kept in stock as a semi-finished tool. When orders are received tools can be promptly finish ground to the desired diameter. Specify size when ordering.



Need a Reamer Fast?

Request Rapid Turn Around Service. Straight Flute sizes above .0433" (1.10mm) and LHS sizes above .097" (2.46mm) can be shipped within 72 hours upon request. 25 piece order maximum.

- Right hand cutting
- 45° lead cutting angle

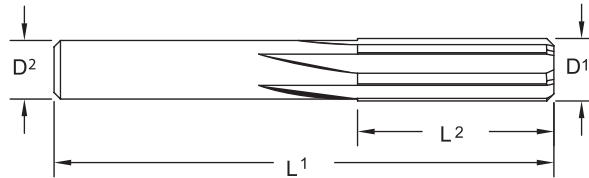

Inch	
D1	Tolerance
≤ 3/8	+0.001/+0.003
> 3/8	+0.001/+0.004
D2	Tolerance
≤ 3/8	+0.000/-0.001
> 3/8	+0.000/-0.001
L1	Tolerance
≤ 3/8	+/- 1/16
> 3/8	+/- 1/16
L2	Tolerance
≤ 3/8	+/- 1/16
> 3/8	+/- 1/16

Metric (mm)	
D1	Tolerance
0.35 - 16.0	DIN1420 H7
D2	Tolerance
0.35 - 16.0	+0.00/-0.03
L1	Tolerance
0.35 - 16.0	+/- 1.5
L2	Tolerance
0.35 - 16.0	+/- 1.5

DIN1420 H7	
D1	Tolerance (mm)
≤ 3mm	+0.004/+0.008
>3mm - 6mm	+0.005/+0.010
>6mm - 10mm	+0.006/+0.012
>10mm - 16mm	+0.008/+0.015



Series 270 / 270L Continued

Series 270		Series 270L		D2		L1		L2		Flutes	
D1 Diameter				Shank		OAL		Flute Length			
Inch	mm	Inch	mm	Inch	mm	Inch	mm	Inch	mm		
.0135-.0200	00.34-0.50	.0135-.0200	00.34-0.50	.0135-.0433 are no longer a standard item. Contact customer service for price and availability as a special quoted item. 800-553-8024 or 563-391-6220							
.0201-.0400	00.51-1.01	.0201-.0400	00.51-1.01								
.0401-.0433	01.02-1.09	.0401-.0433	01.02-1.09								
.0434-.0519	01.10-1.31	.0434-.0519	01.10-1.31	.043	1.09	1-1/2	38	3/8	9.5	4	
.0520-.0590	01.32-1.49	.0520-.0590	01.32-1.49	.046	1.17	1-1/2	38	3/8	9.5	4	
.0591-.0660	01.50-1.67	.0591-.0660	01.50-1.67	.058	1.47	1-1/2	38	3/8	9.5	4	
.0661-.0740	01.68-1.87	.0661-.0740	01.68-1.87	.065	1.65	1-3/4	44	1/2	12.5	4	
.0741-.0810	01.88-2.05	.0741-.0810	01.88-2.05	.073	1.85	1-3/4	44	1/2	12.5	4	
.0811-.0890	02.06-2.26	.0811-.0890	02.06-2.26	.080	2.03	2	51	1/2	12.5	4	
.0891-.0970	02.27-2.46	.0891-.0970	02.27-2.46	.088	2.24	2	51	1/2	12.5	4	
.0971-.1050	02.47-2.66	.0971-.1050	02.47-2.66	.096	2.44	2-1/4	57	5/8	16	4	
.1051-.1130	02.67-2.87	.1051-.1130	02.67-2.87	.104	2.64	2-1/4	57	5/8	16	4	
.1131-.1210	02.88-3.07	.1131-.1210	02.88-3.07	.112	2.84	2-1/4	57	5/8	16	4	
.1211-.1280	03.08-3.25	.1211-.1280	03.08-3.25	.120	3.05	2-1/4	57	5/8	16	4	
.1281-.1360	03.26-3.45	.1281-.1360	03.26-3.45	.127	3.23	2-1/2	64	3/4	19	4	
.1361-.1440	03.46-3.65	.1361-.1440	03.46-3.65	.135	3.43	2-1/2	64	3/4	19	4	
.1441-.1520	03.66-3.86	.1441-.1520	03.66-3.86	.143	3.63	2-1/2	64	3/4	19	4	
.1521-.1590	03.87-4.03	.1521-.1590	03.87-4.03	.151	3.84	2-1/2	64	3/4	19	4	
.1591-.1670	04.04-4.24	.1591-.1670	04.04-4.24	.158	4.01	2-3/4	70	7/8	22	4	
.1671-.1750	04.25-4.44	.1671-.1750	04.25-4.44	.166	4.22	2-3/4	70	7/8	22	4	
.1751-.1830	04.45-4.64	.1751-.1830	04.45-4.64	.174	4.42	2-3/4	70	7/8	22	4	
.1831-.1910	04.65-4.85	.1831-.1910	04.65-4.85	.182	4.62	2-3/4	70	7/8	22	4	
.1911-.1990	04.86-5.05	.1911-.1990	04.86-5.05	.190	4.83	3	76	1	25.5	4	
.1991-.2060	05.06-5.23	.1991-.2060	05.06-5.23	.198	5.03	3	76	1	25.5	4	
.2061-.2140	05.24-5.43	.2061-.2140	05.24-5.43	.205	5.21	3	76	1	25.5	4	
.2141-.2220	05.44-5.63	.2141-.2220	05.44-5.63	.213	5.41	3	76	1	25.5	4	
.2221-.2300	05.64-5.84	.2221-.2300	05.64-5.84	.221	5.61	3	76	1	25.5	4	
.2301-.2370	05.85-6.01	.2301-.2370	05.85-6.01	.229	5.82	3	76	1	25.5	4	
.2371-.2450	06.02-6.22	.2371-.2450	06.02-6.22	.236	5.99	3	76	1	25.5	4	
.2451-.2530	06.23-6.42	.2451-.2530	06.23-6.42	.244	6.20	3	76	1	25.5	4	
.2531-.2710	06.43-6.88	.2531-.2710	06.43-6.88	.252	6.40	3-1/4	83	1-1/8	28.5	6	
.2711-.2860	06.89-7.26	.2711-.2860	06.89-7.26	.270	6.86	3-1/4	83	1-1/8	28.5	6	
.2861-.3020	07.27-7.67	.2861-.3020	07.27-7.67	.285	7.24	3-1/4	83	1-1/8	28.5	6	
.3021-.3180	07.68-8.07	.3021-.3180	07.68-8.07	.301	7.65	3-1/4	83	1-1/8	28.5	6	
.3181-.3330	08.08-8.45	.3181-.3330	08.08-8.45	.317	8.05	3-1/2	89	1-1/4	32	6	
.3331-.3490	08.46-8.86	.3331-.3490	08.46-8.86	.332	8.43	3-1/2	89	1-1/4	32	6	
.3491-.3640	08.87-9.24	.3491-.3640	08.87-9.24	.348	8.84	3-1/2	89	1-1/4	32	6	
.3641-.3860	09.25-9.80	.3641-.3860	09.25-9.80	.363	9.22	3-1/2	89	1-1/4	32	6	
.3861-.4150	09.81-10.54			.380	9.65	3-1/2	89	1-1/4	32	6	
.4151-.4450	10.55-11.30			.410	10.41	3-3/4	95	1-3/8	35	6	
.4451-.4750	11.31-12.06			.440	11.18	3-3/4	95	1-3/8	35	6	
.4751-.5100	12.07-12.95			.470	11.93	4	102	1-1/2	38	6	
.5101-.5400	12.96-13.71			.505	12.83	4	102	1-1/2	38	6	
.5401-.5700	13.72-14.47			.535	13.59	4	102	1-1/2	38	6	
.5701-.6000	14.48-15.24			.565	14.35	4	102	1-3/4	44.5	6	
.6001-.6350	15.25-16.13			.595	15.11	4	102	1-3/4	44.5	6	



TrueSize® Carbide Range Reamer Precision Tolerance OD Series 270P

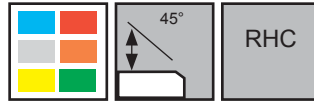

TrueSize® XP = Xtreme Precision 270P Straight Flute

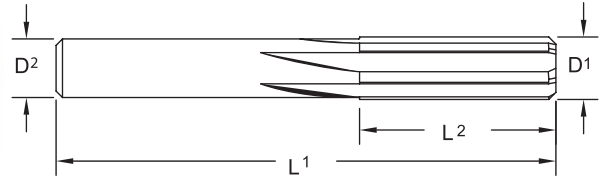

Series 270P		D2		L1		L2		Flutes
D1 Diameter		Shank		OAL		Flute Length		
Inch	mm	Inch	mm	Inch	mm	Inch	mm	
.0434-.0519	01.10-1.31	.043	1.09	1-1/2	38	3/8	9.5	4
.0520-.0590	01.32-1.49	.046	1.17	1-1/2	38	3/8	9.5	4
.0591-.0660	01.50-1.67	.058	1.47	1-1/2	38	3/8	9.5	4
.0661-.0740	01.68-1.87	.065	1.65	1-3/4	44	1/2	12.5	4
.0741-.0810	01.88-2.05	.073	1.85	1-3/4	44	1/2	12.5	4
.0811-.0890	02.06-2.26	.080	2.03	2	51	1/2	12.5	4
.0891-.0970	02.27-2.46	.088	2.24	2	51	1/2	12.5	4
.0971-.1050	02.47-2.66	.096	2.44	2-1/4	57	5/8	16	4
.1051-.1130	02.67-2.87	.104	2.64	2-1/4	57	5/8	16	4
.1131-.1210	02.88-3.07	.112	2.84	2-1/4	57	5/8	16	4
.1211-.1280	03.08-3.25	.120	3.05	2-1/4	57	5/8	16	4
.1281-.1360	03.26-3.45	.127	3.23	2-1/2	64	3/4	19	4
.1361-.1440	03.46-3.65	.135	3.43	2-1/2	64	3/4	19	4
.1441-.1520	03.66-3.86	.143	3.63	2-1/2	64	3/4	19	4
.1521-.1590	03.87-4.03	.151	3.84	2-1/2	64	3/4	19	4
.1591-.1670	04.04-4.24	.158	4.01	2-3/4	70	7/8	22	4
.1671-.1750	04.25-4.44	.166	4.22	2-3/4	70	7/8	22	4
.1751-.1830	04.45-4.64	.174	4.42	2-3/4	70	7/8	22	4
.1831-.1910	04.65-4.85	.182	4.62	2-3/4	70	7/8	22	4
.1911-.1990	04.86-5.05	.190	4.83	3	76	1	25.5	4
.1991-.2060	05.06-5.23	.198	5.03	3	76	1	25.5	4
.2061-.2140	05.24-5.43	.205	5.21	3	76	1	25.5	4
.2141-.2220	05.44-5.63	.213	5.41	3	76	1	25.5	4
.2221-.2300	05.64-5.84	.221	5.61	3	76	1	25.5	4
.2301-.2370	05.85-6.01	.229	5.82	3	76	1	25.5	4
.2371-.2450	06.02-6.22	.236	5.99	3	76	1	25.5	4
.2451-.2530	06.23-6.42	.244	6.20	3	76	1	25.5	4

- Recommended for precision reaming in most non-ferrous and non-metallic materials.
- Kept in stock as a semi-finished tool. When orders are received tools can be promptly finish ground to the desired diameter. 1 week turn around. (25 piece order maximum)
- Specify size when ordering.
- Right hand cutting
- 45° lead cutting angle.

Inch	
D1	Tolerance
.0434 - .2530	+ .0001/+ .0000
D2	Tolerance
.0434 - .2530	+ .000/- .001
L1/L2	Tolerance
.0434 - .2530	+/- 1/16

Metric	
D1	Tolerance
1.10 - 6.42	+ .0025/+ .0000
D2	Tolerance
1.10 - 6.42	+ .000/- 0.03
L1/L2	Tolerance
1.10 - 6.42	+/- 1.5



TrueSize® Carbide Reamer Series 272

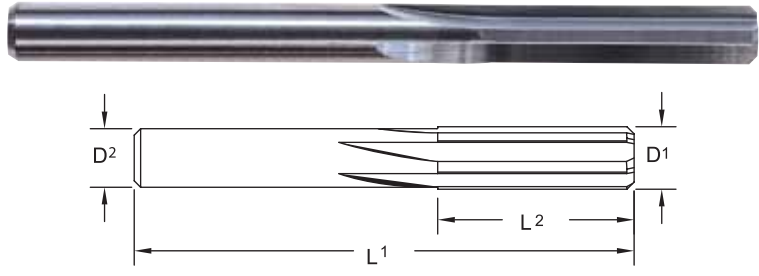

- Recommended for general purpose reaming.
- Straight flutes.
- Well suited for ferrous metals and many non-ferrous and non-metallic materials.
- Special sizes, shank diameters, flute lengths, step reamers, coating, etc. available as specials. Call Customer Service at 800-553-8024 for a quote.

If you don't see
the size you need -
Just Ask
Most special sizes
shipped within 72 hours
upon request.

Inch	
D1	Tolerance
≤ 3/8	+0.001/+0.003
> 3/8	+0.001/+0.004
D2	Tolerance
≤ 3/8	+0.000/-0.001
> 3/8	+0.000/-0.001
L1	Tolerance
≤ 3/8	+/- 1/16
> 3/8	+/- 1/16
L2	Tolerance
≤ 3/8	+/- 1/16
> 3/8	+/- 1/16

Metric (mm)	
D1	Tolerance
0.35 - 16.0	DIN1420 H7
D2	Tolerance
0.35 - 16.0	+0.00/-0.03
L1	Tolerance
0.35 - 16.0	+/- 1.5
L2	Tolerance
0.35 - 16.0	+/- 1.5

DIN1420 H7	
D1	Tolerance (mm)
≤ 3mm	+0.004/+0.008
>3mm - 6mm	+0.005/+0.010
>6mm - 10mm	+0.006/+0.012
>10mm - 16mm	+0.008/+0.015



Series 272 Continued

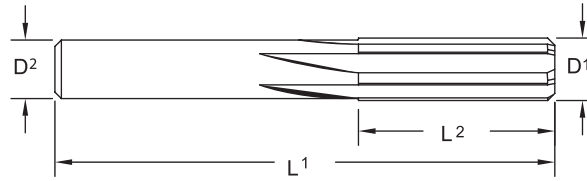
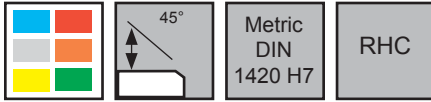

Tool No.	EDP	Diameter				Shank		OAL		Flute Length		Flutes
		D1				D2		L1		L2		
		Inch	Wire	mm	Decimal	Inch	mm	Inch	mm	Inch	mm	
27201300	03000				0.0130	0.0130		1-1/2		3/16		4
27201350	01001		80		0.0135	0.0135		1-1/2		3/16		4
27201380	01005			0.35	0.0138	0.0138	0.35		38		5.0	4
27201400	03001				0.0140	0.0140		1-1/2		3/16		4
27201450	01009		79		0.0145	0.0145		1-1/2		3/16		4
27201500	03002				0.0150	0.0150		1-1/2		3/16		4
27201550	03003				0.0155	0.0155		1-1/2		3/16		4
27201560	01013	1/64			0.0156	0.0156		1-1/2		3/16		4
27201570	01017			0.40	0.0157	0.0157	0.40		38		5.0	4
27201600	01021		78		0.0160	0.0160		1-1/2		3/16		4
27201650	03004				0.0165	0.0165		1-1/2		3/16		4
27201700	03005				0.0170	0.0170		1-1/2		3/16		4
27201750	03006				0.0175	0.0175		1-1/2		3/16		4
27201770	01025			0.45	0.0177	0.0177	0.45		38		5.0	4
27201800	01029		77		0.0180	0.0180		1-1/2		3/16		4
27201850	03007				0.0185	0.0185		1-1/2		3/16		4
27201900	03008				0.0190	0.0190		1-1/2		3/16		4
27201950	03009				0.0195	0.0195		1-1/2		3/16		4
27201970	01033			0.50	0.0197	0.0197	0.50		38		5.0	4
27202000	01037		76		0.0200	0.0200		1-1/2		3/16		4
27202050	03010				0.0205	0.0205		1-1/2		1/4		4
27202100	01041		75		0.0210	0.0210		1-1/2		1/4		4
27202150	03011				0.0215	0.0215		1-1/2		1/4		4
27202170	01045			0.55	0.0217	0.0217	0.55		38		6.5	4
27202200	03012				0.0220	0.0220		1-1/2		1/4		4
27202250	01049		74		0.0225	0.0225		1-1/2		1/4		4
27202300	03013				0.0230	0.0230		1-1/2		1/4		4
27202350	03014				0.0235	0.0235		1-1/2		1/4		4
27202360	01053			0.60	0.0236	0.0236	0.60		38		6.5	4
27202400	01057		73		0.0240	0.0240		1-1/2		1/4		4
27202450	03015				0.0245	0.0245		1-1/2		1/4		4
27202500	01061		72		0.0250	0.0250		1-1/2		1/4		4
27202550	03016				0.0255	0.0255		1-1/2		1/4		4
27202560	01065			0.65	0.0256	0.0256	0.65		38		6.5	4
27202600	01069		71		0.0260	0.0260		1-1/2		1/4		4
27202650	03017				0.0265	0.0265		1-1/2		1/4		4
27202700	03018				0.0270	0.0270		1-1/2		1/4		4
27202750	03019				0.0275	0.0275		1-1/2		1/4		4
27202760	01073			0.70	0.0276	0.0276	0.70		38		6.5	4
27202800	01077		70		0.0280	0.0280		1-1/2		1/4		4
27202850	03020				0.0285	0.0285		1-1/2		1/4		4
27202900	03021				0.0290	0.0290		1-1/2		1/4		4



Series 272 Continued

Tool No.	EDP	Diameter				Shank		OAL		Flute Length		Flutes
		D1				D2		L1		L2		
		Inch	Wire	mm	Decimal	Inch	mm	Inch	mm	Inch	mm	
27202920	01081		69		0.0292	0.0292		1-1/2		1/4		4
27202950	01085			0.75	0.0295	0.0295	0.75		38		6.5	4
27202951	03620				0.0295	0.0295		1-1/2		1/4		4
27203000	03022				0.0300	0.0300		1-1/2		1/4		4
27203050	03023				0.0305	0.0305		1-1/2		1/4		4
27203100	01089		68		0.0310	0.0310		1-1/2		1/4		4
27203120	01093	1/32			0.0312	0.0312		1-1/2		1/4		4
27203150	01097			0.80	0.0315	0.0315	0.80		38		6.5	4
27203151	03621				0.0315	0.0315		1-1/2		1/4		4
27203200	01101		67		0.0320	0.0320		1-1/2		1/4		4
27203250	03024				0.0325	0.0325		1-1/2		1/4		4
27203300	01105		66		0.0330	0.0330		1-1/2		1/4		4
27203350	01109			0.85	0.0335	0.0335	0.85		38		6.5	4
27203351	03622				0.0335	0.0335		1-1/2		1/4		4
27203400	03025				0.0340	0.0340		1-1/2		1/4		4
27203450	03026				0.0345	0.0345		1-1/2		1/4		4
27203500	01113		65		0.0350	0.0350		1-1/2		1/4		4
27203540	01117			0.90	0.0354	0.0354	0.90		38		6.5	4
27203550	03027				0.0355	0.0355		1-1/2		1/4		4
27203600	01121		64		0.0360	0.0360		1-1/2		1/4		4
27203650	03028				0.0365	0.0365		1-1/2		1/4		4
27203700	01125		63		0.0370	0.0370		1-1/2		1/4		4
27203740	01129			0.95	0.0374	0.0374	0.95		38		6.5	4
27203750	03029				0.0375	0.0375		1-1/2		1/4		4
27203800	01133		62		0.0380	0.0380		1-1/2		1/4		4
27203850	03030				0.0385	0.0385		1-1/2		1/4		4
27203900	01137		61		0.0390	0.0390		1-1/2		1/4		4
27203940	01141			1.00	0.0394	0.0394	1.00		38		6.5	4
27203950	03031				0.0395	0.0395		1-1/2		1/4		4
27204000	01145		60		0.0400	0.0400		1-1/2		1/4		4
27204050	03032				0.0405	0.0405		1-1/2		3/8		4
27204100	01149		59		0.0410	0.0410		1-1/2		3/8		4
27204130	01153			1.05	0.0413	0.0413	1.05		38		9.5	4
27204150	03033				0.0415	0.0415		1-1/2		3/8		4
27204200	01157		58		0.0420	0.0420		1-1/2		3/8		4
27204250	03034				0.0425	0.0425		1-1/2		3/8		4
27204300	01161		57		0.0430	0.0430		1-1/2		3/8		4
27204330	01165			1.10	0.0433	0.0433	1.09		38		9.5	4
27204350	03035				0.0435	0.0430		1-1/2		3/8		4
27204400	03036				0.0440	0.0430		1-1/2		3/8		4
27204450	03037				0.0445	0.0430		1-1/2		3/8		4
27204500	03038				0.0450	0.0430		1-1/2		3/8		4
27204520	01169			1.15	0.0452	0.0430	1.09		38		9.5	4
27204550	03039				0.0455	0.0430		1-1/2		3/8		4
27204600	03040				0.0460	0.0430		1-1/2		3/8		4
27204650	01173		56		0.0465	0.0430		1-1/2		3/8		4



Series 272 Continued

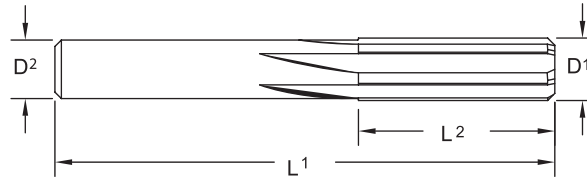
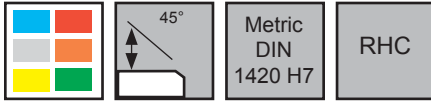

Tool No.	EDP	Diameter				Shank		OAL		Flute Length		Flutes
		D1				D2		L1		L2		
		Inch	Wire	mm	Decimal	Inch	mm	Inch	mm	Inch	mm	
27204680	01177	3/64			0.0468	0.0430		1-1/2		3/8		4
27204700	03041				0.0470	0.0430		1-1/2		3/8		4
27204720	01181			1.20	0.0472	0.0430	1.09		38		9.5	4
27204750	03042				0.0475	0.0430		1-1/2		3/8		4
27204800	03043				0.0480	0.0430		1-1/2		3/8		4
27204850	03044				0.0485	0.0430		1-1/2		3/8		4
27204900	03045				0.0490	0.0430		1-1/2		3/8		4
27204920	01185			1.25	0.0492	0.0430	1.09		38		9.5	4
27204950	03046				0.0495	0.0430		1-1/2		3/8		4
27205000	03047				0.0500	0.0430		1-1/2		3/8		4
27205050	03048				0.0505	0.0430		1-1/2		3/8		4
27205100	03049				0.0510	0.0430		1-1/2		3/8		4
27205110	01189			1.30	0.0511	0.0430	1.09		38		9.5	4
27205150	03050				0.0515	0.0430		1-1/2		3/8		4
27205200	01193		55		0.0520	0.0460		1-1/2		3/8		4
27205250	03051				0.0525	0.0460		1-1/2		3/8		4
27205300	03052				0.0530	0.0460		1-1/2		3/8		4
27205310	01197			1.35	0.0531	0.0460	1.17		38		9.5	4
27205350	03053				0.0535	0.0460		1-1/2		3/8		4
27205400	03054				0.0540	0.0460		1-1/2		3/8		4
27205450	03055				0.0545	0.0460		1-1/2		3/8		4
27205500	01201		54		0.0550	0.0460		1-1/2		3/8		4
27205510	01205			1.40	0.0551	0.0460	1.17		38		9.5	4
27205550	03056				0.0555	0.0460		1-1/2		3/8		4
27205600	03057				0.0560	0.0460		1-1/2		3/8		4
27205650	03058				0.0565	0.0460		1-1/2		3/8		4
27205700	03059				0.0570	0.0460		1-1/2		3/8		4
27205710	01209			1.45	0.0571	0.0460	1.17		38		9.5	4
27205750	03060				0.0575	0.0460		1-1/2		3/8		4
27205800	03061				0.0580	0.0460		1-1/2		3/8		4
27205850	03062				0.0585	0.0460		1-1/2		3/8		4
27205900	01213			1.50	0.0590	0.0460	1.17		38		9.5	4
27205901	03623				0.0590	0.0460		1-1/2		3/8		4
27205950	01217		53		0.0595	0.0580		1-1/2		3/8		4
27206000	03063				0.0600	0.0580		1-1/2		3/8		4
27206050	03064				0.0605	0.0580		1-1/2		3/8		4
27206100	01221			1.55	0.0610	0.0580	1.47		38		9.5	4
27206101	03624				0.0610	0.0580		1-1/2		3/8		4
27206150	03065				0.0615	0.0580		1-1/2		3/8		4
27206200	03066				0.0620	0.0580		1-1/2		3/8		4
27206250	01225	1/16			0.0625	0.0580		1-1/2		3/8		4
27206300	01229			1.60	0.0630	0.0580	1.47		38		9.5	4



Series 272 Continued

Tool No.	EDP	Diameter				Shank		OAL		Flute Length		Flutes
		D1				D2		L1		L2		
		Inch	Wire	mm	Decimal	Inch	mm	Inch	mm	Inch	mm	
27206301	03625				0.0630	0.0580		1-1/2		3/8		4
27206350	01233		52		0.0635	0.0580		1-1/2		3/8		4
27206400	03067				0.0640	0.0580		1-1/2		3/8		4
27206450	03068				0.0645	0.0580		1-1/2		3/8		4
27206490	01237			1.65	0.0649	0.0580	1.47		38		9.5	4
27206500	03069				0.0650	0.0580		1-1/2		3/8		4
27206550	03070				0.0655	0.0580		1-1/2		3/8		4
27206600	03071				0.0660	0.0580		1-1/2		3/8		4
27206650	03072				0.0665	0.0650		1-3/4		1/2		4
27206690	01241			1.70	0.0669	0.0650	1.65		44		12.5	4
27206700	01245		51		0.0670	0.0650		1-3/4		1/2		4
27206750	03073				0.0675	0.0650		1-3/4		1/2		4
27206800	03074				0.0680	0.0650		1-3/4		1/2		4
27206850	03075				0.0685	0.0650		1-3/4		1/2		4
27206890	01249			1.75	0.0689	0.0650	1.65		44		12.5	4
27206900	03076				0.0690	0.0650		1-3/4		1/2		4
27206950	03077				0.0695	0.0650		1-3/4		1/2		4
27207000	01253		50		0.0700	0.0650		1-3/4		1/2		4
27207050	03078				0.0705	0.0650		1-3/4		1/2		4
27207080	01257			1.80	0.0708	0.0650	1.65		44		12.5	4
27207100	03079				0.0710	0.0650		1-3/4		1/2		4
27207150	03080				0.0715	0.0650		1-3/4		1/2		4
27207200	03081				0.0720	0.0650		1-3/4		1/2		4
27207250	03082				0.0725	0.0650		1-3/4		1/2		4
27207280	01261			1.85	0.0728	0.0650	1.65		44		12.5	4
27207300	01265		49		0.0730	0.0650		1-3/4		1/2		4
27207350	03083				0.0735	0.0650		1-3/4		1/2		4
27207400	03084				0.0740	0.0650		1-3/4		1/2		4
27207450	03085				0.0745	0.0730		1-3/4		1/2		4
27207480	01269			1.90	0.0748	0.0730	1.85		44		12.5	4
27207500	03086				0.0750	0.0730		1-3/4		1/2		4
27207550	03087				0.0755	0.0730		1-3/4		1/2		4
27207600	01273		48		0.0760	0.0730		1-3/4		1/2		4
27207650	03088				0.0765	0.0730		1-3/4		1/2		4
27207670	01277			1.95	0.0767	0.0730	1.85		44		12.5	4
27207700	03089				0.0770	0.0730		1-3/4		1/2		4
27207750	03090				0.0775	0.0730		1-3/4		1/2		4
27207800	03091				0.0780	0.0730		1-3/4		1/2		4
27207810	01281	5/64			0.0781	0.0730		1-3/4		1/2		4
27207850	01285		47		0.0785	0.0730		1-3/4		1/2		4
27207870	01289			2.00	0.0787	0.0730	1.85		44		12.5	4
27207900	03092				0.0790	0.0730		1-3/4		1/2		4
27207950	03093				0.0795	0.0730		1-3/4		1/2		4
27208000	03094				0.0800	0.0730		1-3/4		1/2		4



Series 272 Continued

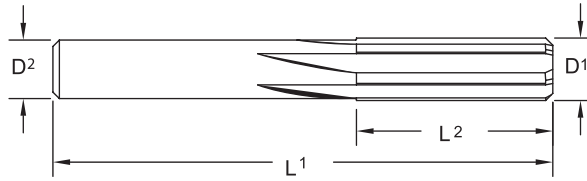
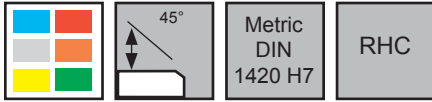

Tool No.	EDP	Diameter				Shank		OAL		Flute Length		Flutes
		D1				D2		L1		L2		
		Inch	Wire	mm	Decimal	Inch	mm	Inch	mm	Inch	mm	
27208050	03095				0.0805	0.0730		1-3/4		1/2		4
27208070	01293			2.05	0.0807	0.0730	1.85		44		12.5	4
27208100	01297		46		0.0810	0.0730		1-3/4		1/2		4
27208150	03096				0.0815	0.0800		2		1/2		4
27208200	01301		45		0.0820	0.0800		2		1/2		4
27208250	03097				0.0825	0.0800		2		1/2		4
27208270	01305			2.10	0.0827	0.0800	2.03		51		12.5	4
27208300	03098				0.0830	0.0800		2		1/2		4
27208350	03099				0.0835	0.0800		2		1/2		4
27208400	03100				0.0840	0.0800		2		1/2		4
27208450	03101				0.0845	0.0800		2		1/2		4
27208460	01309			2.15	0.0846	0.0800	2.03		51		12.5	4
27208500	03102				0.0850	0.0800		2		1/2		4
27208550	03103				0.0855	0.0800		2		1/2		4
27208600	01313		44		0.0860	0.0800		2		1/2		4
27208650	03104				0.0865	0.0800		2		1/2		4
27208660	01317			2.20	0.0866	0.0800	2.03		51		12.5	4
27208700	03105				0.0870	0.0800		2		1/2		4
27208750	03106				0.0875	0.0800		2		1/2		4
27208800	03107				0.0880	0.0800		2		1/2		4
27208850	03108				0.0885	0.0800		2		1/2		4
27208860	01321			2.25	0.0886	0.0800	2.03		51		12.5	4
27208900	01325		43		0.0890	0.0800		2		1/2		4
27208950	03109				0.0895	0.0880		2		1/2		4
27209000	03110				0.0900	0.0880		2		1/2		4
27209050	03111				0.0905	0.0880		2		1/2		4
27209060	01329			2.30	0.0906	0.0880	2.24		51		12.5	4
27209100	03112				0.0910	0.0880		2		1/2		4
27209150	03113				0.0915	0.0880		2		1/2		4
27209200	03114				0.0920	0.0880		2		1/2		4
27209250	01333			2.35	0.0925	0.0880	2.24		51		12.5	4
27209251	03626				0.0925	0.0880		2		1/2		4
27209300	03115				0.0930	0.0880		2		1/2		4
27209350	01337		42		0.0935	0.0880		2		1/2		4
27209370	01341	3/32			0.0937	0.0880		2		1/2		4
27209400	03116				0.0940	0.0880		2		1/2		4
27209450	01345			2.40	0.0945	0.0880	2.24		51		12.5	4
27209451	03627				0.0945	0.0880		2		1/2		4
27209500	03117				0.0950	0.0880		2		1/2		4
27209550	03118				0.0955	0.0880		2		1/2		4
27209600	01349		41		0.0960	0.0880		2		1/2		4
27209650	01353			2.45	0.0965	0.0880	2.24		51		12.5	4



Series 272 Continued

Tool No.	EDP	Diameter				Shank		OAL		Flute Length		Flutes
		D1				D2		L1		L2		
		Inch	Wire	mm	Decimal	Inch	mm	Inch	mm	Inch	mm	
27209651	03628				0.0965	0.0880		2		1/2		4
27209700	03119				0.0970	0.0880		2		1/2		4
27209750	03120				0.0975	0.0960		2-1/4		5/8		4
27209800	01357		40		0.0980	0.0960		2-1/4		5/8		4
27209840	01361			2.50	0.0984	0.0960	2.44		57		16.0	4
27209850	03121				0.0985	0.0960		2-1/4		5/8		4
27209900	03122				0.0990	0.0960		2-1/4		5/8		4
27209950	01365		39		0.0995	0.0960		2-1/4		5/8		4
27210000	03123				0.1000	0.0960		2-1/4		5/8		4
27210040	01366			2.55	0.1004	0.0960	2.44		57		16.0	4
27210050	03124				0.1005	0.0960		2-1/4		5/8		4
27210100	03125				0.1010	0.0960		2-1/4		5/8		4
27210150	01369		38		0.1015	0.0960		2-1/4		5/8		4
27210200	03126				0.1020	0.0960		2-1/4		5/8		4
27210240	01373			2.60	0.1024	0.0960	2.44		57		16.0	4
27210250	03127				0.1025	0.0960		2-1/4		5/8		4
27210300	03128				0.1030	0.0960		2-1/4		5/8		4
27210350	03129				0.1035	0.0960		2-1/4		5/8		4
27210400	01377		37		0.1040	0.0960		2-1/4		5/8		4
27210430	01378			2.65	0.1043	0.0960	2.44		57		16.0	4
27210450	03130				0.1045	0.0960		2-1/4		5/8		4
27210500	03131				0.1050	0.0960		2-1/4		5/8		4
27210550	03132				0.1055	0.1040		2-1/4		5/8		4
27210600	03133				0.1060	0.1040		2-1/4		5/8		4
27210630	01381			2.70	0.1063	0.1040	2.64		57		16.0	4
27210650	01385		36		0.1065	0.1040		2-1/4		5/8		4
27210700	03134				0.1070	0.1040		2-1/4		5/8		4
27210750	03135				0.1075	0.1040		2-1/4		5/8		4
27210800	03136				0.1080	0.1040		2-1/4		5/8		4
27210830	01389			2.75	0.1083	0.1040	2.64		57		16.0	4
27210850	03137				0.1085	0.1040		2-1/4		5/8		4
27210900	03138				0.1090	0.1040		2-1/4		5/8		4
27210940	01393	7/64			0.1094	0.1040		2-1/4		5/8		4
27210950	03139				0.1095	0.1040		2-1/4		5/8		4
27211000	01397		35		0.1100	0.1040		2-1/4		5/8		4
27211020	01401			2.80	0.1102	0.1040	2.64		57		16.0	4
27211050	03140				0.1105	0.1040		2-1/4		5/8		4
27211100	01405		34		0.1110	0.1040		2-1/4		5/8		4
27211150	03141				0.1115	0.1040		2-1/4		5/8		4
27211200	03142				0.1120	0.1040		2-1/4		5/8		4
27211220	01406			2.85	0.1122	0.1040	2.64		57		16.0	4
27211250	03143				0.1125	0.1040		2-1/4		5/8		4
27211300	01409		33		0.1130	0.1040		2-1/4		5/8		4
27211350	03144				0.1135	0.1120		2-1/4		5/8		4



Series 272 Continued

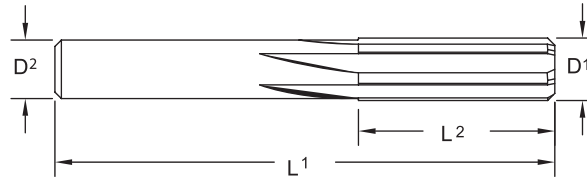
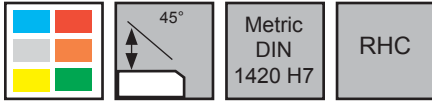

Tool No.	EDP	Diameter				Shank		OAL		Flute Length		Flutes
		D1				D2		L1		L2		
		Inch	Wire	mm	Decimal	Inch	mm	Inch	mm	Inch	mm	
27211400	03145				0.1140	0.1120		2-1/4		5/8		4
27211420	01413			2.90	0.1142	0.1120	2.84		57		16.0	4
27211450	03146				0.1145	0.1120		2-1/4		5/8		4
27211500	03147				0.1150	0.1120		2-1/4		5/8		4
27211550	03148				0.1155	0.1120		2-1/4		5/8		4
27211600	01417		32		0.1160	0.1120		2-1/4		5/8		4
27211610	01418			2.95	0.1161	0.1120	2.84		57		16.0	4
27211650	03149				0.1165	0.1120		2-1/4		5/8		4
27211700	03150				0.1170	0.1120		2-1/4		5/8		4
27211750	03151				0.1175	0.1120		2-1/4		5/8		4
27211800	03152				0.1180	0.1120		2-1/4		5/8		4
27211810	01421			3.00	0.1181	0.1120	2.84		57		16.0	4
27211850	03153				0.1185	0.1120		2-1/4		5/8		4
27211900	03154				0.1190	0.1120		2-1/4		5/8		4
27211950	03155				0.1195	0.1120		2-1/4		5/8		4
27212000	01425		31		0.1200	0.1120		2-1/4		5/8		4
27212010	01426			3.05	0.1201	0.1120	2.84		57		16.0	4
27212050	03156				0.1205	0.1120		2-1/4		5/8		4
27212100	03157				0.1210	0.1120		2-1/4		5/8		4
27212150	03158				0.1215	0.1200		2-1/4		5/8		4
27212200	01429			3.10	0.1220	0.1200	3.05		57		16.0	4
27212201	03629				0.1220	0.1200		2-1/4		5/8		4
27212250	03159				0.1225	0.1200		2-1/4		5/8		4
27212300	03160				0.1230	0.1200		2-1/4		5/8		4
27212350	03161				0.1235	0.1200		2-1/4		5/8		4
27212400	03162				0.1240	0.1200		2-1/4		5/8		4
27212401	01436			3.15	0.1240	0.1200	3.05		57		16.0	4
27212450	03163	1/8 DP2			0.1245	0.1200		2-1/4		5/8		4
27212470	01434				0.1247	0.1200		2-1/4		5/8		4
27212480	03164	1/8 DP1			0.1248	0.1200		2-1/4		5/8		4
27212490	03165	1/8 US			0.1249	0.1200		2-1/4		5/8		4
27212500	01433	1/8			0.1250	0.1200		2-1/4		5/8		4
27212550	03166				0.1255	0.1200		2-1/4		5/8		4
27212600	01437			3.20	0.1260	0.1200	3.05		57		16.0	4
27212601	03167	1/8 OS			0.1260	0.1200		2-1/4		5/8		4
27212650	03168				0.1265	0.1200		2-1/4		5/8		4
27212700	03169				0.1270	0.1200		2-1/4		5/8		4
27212750	03170				0.1275	0.1200		2-1/4		5/8		4
27212800	01441			3.25	0.1280	0.1200	3.05		57		16.0	4
27212801	03630				0.1280	0.1200		2-1/4		5/8		4
27212850	01445		30		0.1285	0.1270		2-1/2		3/4		4
27212900	03171				0.1290	0.1270		2-1/2		3/4		4



Series 272 Continued

Tool No.	EDP	Diameter				Shank		OAL		Flute Length		Flutes
		D1				D2		L1		L2		
		Inch	Wire	mm	Decimal	Inch	mm	Inch	mm	Inch	mm	
27212950	03172				0.1295	0.1270		2-1/2		3/4		4
27212990	01449			3.30	0.1299	0.1270	3.23		63		19.0	4
27213000	03173				0.1300	0.1270		2-1/2		3/4		4
27213050	03174				0.1305	0.1270		2-1/2		3/4		4
27213100	03175				0.1310	0.1270		2-1/2		3/4		4
27213150	03176				0.1315	0.1270		2-1/2		3/4		4
27213190	01453			3.35	0.1319	0.1270	3.23		63		19.0	4
27213200	03177				0.1320	0.1270		2-1/2		3/4		4
27213250	03178				0.1325	0.1270		2-1/2		3/4		4
27213300	03179				0.1330	0.1270		2-1/2		3/4		4
27213350	03180				0.1335	0.1270		2-1/2		3/4		4
27213390	01457			3.40	0.1339	0.1270	3.23		63		19.0	4
27213400	03181				0.1340	0.1270		2-1/2		3/4		4
27213450	03182				0.1345	0.1270		2-1/2		3/4		4
27213500	03183				0.1350	0.1270		2-1/2		3/4		4
27213550	03184				0.1355	0.1270		2-1/2		3/4		4
27213580	01461			3.45	0.1358	0.1270	3.23		63		19.0	4
27213600	01465		29		0.1360	0.1270		2-1/2		3/4		4
27213650	03185				0.1365	0.1350		2-1/2		3/4		4
27213700	03186				0.1370	0.1350		2-1/2		3/4		4
27213750	03187				0.1375	0.1350		2-1/2		3/4		4
27213780	01469			3.50	0.1378	0.1350	3.43		63		19.0	4
27213800	03188				0.1380	0.1350		2-1/2		3/4		4
27213850	03189				0.1385	0.1350		2-1/2		3/4		4
27213900	03190				0.1390	0.1350		2-1/2		3/4		4
27213950	03191				0.1395	0.1350		2-1/2		3/4		4
27213980	01473			3.55	0.1398	0.1350	3.43		63		19.0	4
27214000	03192				0.1400	0.1350		2-1/2		3/4		4
27214050	01477		28		0.1405	0.1350		2-1/2		3/4		4
27214060	01481	9/64			0.1406	0.1350		2-1/2		3/4		4
27214100	03193				0.1410	0.1350		2-1/2		3/4		4
27214150	03194				0.1415	0.1350		2-1/2		3/4		4
27214170	01485			3.60	0.1417	0.1350	3.43		63		19.0	4
27214200	03195				0.1420	0.1350		2-1/2		3/4		4
27214250	03196				0.1425	0.1350		2-1/2		3/4		4
27214300	03197				0.1430	0.1350		2-1/2		3/4		4
27214350	03198				0.1435	0.1350		2-1/2		3/4		4
27214370	01489			3.65	0.1437	0.1350	3.43		63		19.0	4
27214400	01493		27		0.1440	0.1350		2-1/2		3/4		4
27214450	03199				0.1445	0.1430		2-1/2		3/4		4
27214500	03200				0.1450	0.1430		2-1/2		3/4		4
27214550	03201				0.1455	0.1430		2-1/2		3/4		4
27214570	01497			3.70	0.1457	0.1430	3.63		63		19.0	4
27214600	03202				0.1460	0.1430		2-1/2		3/4		4



Series 272 Continued

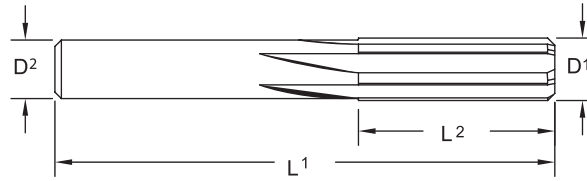
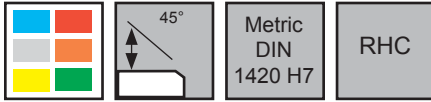

Tool No.	EDP	Diameter				Shank		OAL		Flute Length		Flutes	
		D1				D2		L1		L2			
		Inch	Wire	mm	Decimal	Inch	mm	Inch	mm	Inch	mm		
27214650	03203				0.1465	0.1430			2-1/2		3/4		4
27214700	01501		26		0.1470	0.1430			2-1/2		3/4		4
27214750	03204				0.1475	0.1430			2-1/2		3/4		4
27214760	01505			3.75	0.1476	0.1430	3.63		63		19.0		4
27214800	03205				0.1480	0.1430			2-1/2		3/4		4
27214850	03206				0.1485	0.1430			2-1/2		3/4		4
27214900	03207				0.1490	0.1430			2-1/2		3/4		4
27214950	01509		25		0.1495	0.1430			2-1/2		3/4		4
27214960	01513			3.80	0.1496	0.1430	3.63		63		19.0		4
27215000	03208				0.1500	0.1430			2-1/2		3/4		4
27215050	03209				0.1505	0.1430			2-1/2		3/4		4
27215100	03210				0.1510	0.1430			2-1/2		3/4		4
27215150	03211				0.1515	0.1430			2-1/2		3/4		4
27215160	01518			3.85	0.1516	0.1430	3.63		63		19.0		4
27215200	01517		24		0.1520	0.1430			2-1/2		3/4		4
27215250	03213				0.1525	0.1510			2-1/2		3/4		4
27215300	03214				0.1530	0.1510			2-1/2		3/4		4
27215350	01521			3.90	0.1535	0.1510	3.84		63		19.0		4
27215351	03631				0.1535	0.1510			2-1/2		3/4		4
27215400	01525		23		0.1540	0.1510			2-1/2		3/4		4
27215450	03215				0.1545	0.1510			2-1/2		3/4		4
27215500	03216				0.1550	0.1510			2-1/2		3/4		4
27215550	01529			3.95	0.1555	0.1510	3.84		63		19.0		4
27215551	03632				0.1555	0.1510			2-1/2		3/4		4
27215600	03217				0.1560	0.1510			2-1/2		3/4		4
27215620	01533	5/32			0.1562	0.1510			2-1/2		3/4		4
27215650	03218				0.1565	0.1510			2-1/2		3/4		4
27215700	01537		22		0.1570	0.1510			2-1/2		3/4		4
27215750	01541			4.00	0.1575	0.1510	3.84		63		19.0		4
27215751	03633				0.1575	0.1510			2-1/2		3/4		4
27215800	03219				0.1580	0.1510			2-1/2		3/4		4
27215850	03220				0.1585	0.1510			2-1/2		3/4		4
27215900	01545		21		0.1590	0.1510			2-1/2		3/4		4
27215940	01549			4.05	0.1594	0.1580	4.01		70		22.0		4
27215950	03221				0.1595	0.1580			2-3/4		7/8		4
27216000	03222				0.1600	0.1580			2-3/4		7/8		4
27216050	03223				0.1605	0.1580			2-3/4		7/8		4
27216100	01553		20		0.1610	0.1580			2-3/4		7/8		4
27216140	01557			4.10	0.1614	0.1580	4.01		70		22.0		4
27216150	03224				0.1615	0.1580			2-3/4		7/8		4
27216200	03225				0.1620	0.1580			2-3/4		7/8		4
27216250	03226				0.1625	0.1580			2-3/4		7/8		4



Series 272 Continued

Tool No.	EDP	Diameter				Shank		OAL		Flute Length		Flutes
		D1				D2		L1		L2		
		Inch	Wire	mm	Decimal	Inch	mm	Inch	mm	Inch	mm	
27216300	03227				0.1630	0.1580		2-3/4		7/8		4
27216340	01561			4.15	0.1634	0.1580	4.01		70		22.0	4
27216350	03228				0.1635	0.1580		2-3/4		7/8		4
27216400	03229				0.1640	0.1580		2-3/4		7/8		4
27216450	03230				0.1645	0.1580		2-3/4		7/8		4
27216500	03231				0.1650	0.1580		2-3/4		7/8		4
27216540	01565			4.20	0.1654	0.1580	4.01		70		22.0	4
27216550	03232				0.1655	0.1580		2-3/4		7/8		4
27216600	01569		19		0.1660	0.1580		2-3/4		7/8		4
27216650	03233				0.1665	0.1580		2-3/4		7/8		4
27216700	03234				0.1670	0.1580		2-3/4		7/8		4
27216730	01573			4.25	0.1673	0.1660	4.22		70		22.0	4
27216750	03235				0.1675	0.1660		2-3/4		7/8		4
27216800	03236				0.1680	0.1660		2-3/4		7/8		4
27216850	03237				0.1685	0.1660		2-3/4		7/8		4
27216900	03238				0.1690	0.1660		2-3/4		7/8		4
27216930	01577			4.30	0.1693	0.1660	4.22		70		22.0	4
27216950	01581		18		0.1695	0.1660		2-3/4		7/8		4
27217000	03239				0.1700	0.1660		2-3/4		7/8		4
27217050	03240				0.1705	0.1660		2-3/4		7/8		4
27217100	03241				0.1710	0.1660		2-3/4		7/8		4
27217130	01585			4.35	0.1713	0.1660	4.22		70		22.0	4
27217150	03242				0.1715	0.1660		2-3/4		7/8		4
27217190	01589	11/64			0.1719	0.1660		2-3/4		7/8		4
27217200	03243				0.1720	0.1660		2-3/4		7/8		4
27217250	03244				0.1725	0.1660		2-3/4		7/8		4
27217300	01593		17		0.1730	0.1660		2-3/4		7/8		4
27217320	01597			4.40	0.1732	0.1660	4.22		70		22.0	4
27217350	03245				0.1735	0.1660		2-3/4		7/8		4
27217400	03246				0.1740	0.1660		2-3/4		7/8		4
27217450	03247				0.1745	0.1660		2-3/4		7/8		4
27217500	03248				0.1750	0.1660		2-3/4		7/8		4
27217520	01601			4.45	0.1752	0.1740	4.42		70		22.0	4
27217550	03249				0.1755	0.1740		2-3/4		7/8		4
27217600	03250				0.1760	0.1740		2-3/4		7/8		4
27217650	03251				0.1765	0.1740		2-3/4		7/8		4
27217700	01605		16		0.1770	0.1740		2-3/4		7/8		4
27217720	01609			4.50	0.1772	0.1740	4.42		70		22.0	4
27217750	03252				0.1775	0.1740		2-3/4		7/8		4
27217800	03253				0.1780	0.1740		2-3/4		7/8		4
27217850	03254				0.1785	0.1740		2-3/4		7/8		4
27217900	03255				0.1790	0.1740		2-3/4		7/8		4
27217910	01613			4.55	0.1791	0.1740	4.42		70		22.0	4
27217950	03256				0.1795	0.1740		2-3/4		7/8		4



Series 272 Continued

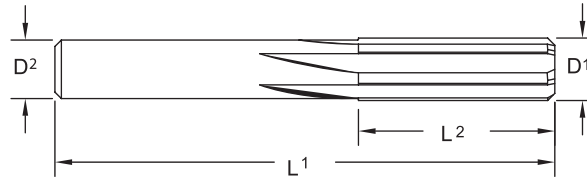
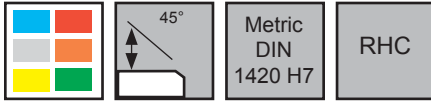

Tool No.	EDP	Diameter				Shank		OAL		Flute Length		Flutes
		D1				D2		L1		L2		
		Inch	Wire	mm	Decimal	Inch	mm	Inch	mm	Inch	mm	
27218000	01617		15		0.1800	0.1740		2-3/4		7/8		4
27218050	03257				0.1805	0.1740		2-3/4		7/8		4
27218100	03258				0.1810	0.1740		2-3/4		7/8		4
27218110	01621			4.60	0.1811	0.1740	4.42		70		22.0	4
27218150	03259				0.1815	0.1740		2-3/4		7/8		4
27218200	01625		14		0.1820	0.1740		2-3/4		7/8		4
27218250	03260				0.1825	0.1740		2-3/4		7/8		4
27218300	03261				0.1830	0.1740		2-3/4		7/8		4
27218310	01629			4.65	0.1831	0.1820	4.62		70		22.0	4
27218350	03262				0.1835	0.1820		2-3/4		7/8		4
27218400	03263				0.1840	0.1820		2-3/4		7/8		4
27218450	03264				0.1845	0.1820		2-3/4		7/8		4
27218500	01633			4.70	0.1850	0.1820	4.62		70		22.0	4
27218501	03265		13		0.1850	0.1820		2-3/4		7/8		4
27218550	03266				0.1855	0.1820		2-3/4		7/8		4
27218600	03267				0.1860	0.1820		2-3/4		7/8		4
27218650	03268				0.1865	0.1820		2-3/4		7/8		4
27218700	01637			4.75	0.1870	0.1820	4.62		70		22.0	4
27218701	03269	3/16 DP2			0.1870	0.1820		2-3/4		7/8		4
27218730	03270	3/16 DP1			0.1873	0.1820		2-3/4		7/8		4
27218740	03271	3/16 US			0.1874	0.1820		2-3/4		7/8		4
27218750	01641	3/16			0.1875	0.1820		2-3/4		7/8		4
27218800	03272				0.1880	0.1820		2-3/4		7/8		4
27218850	03273	3/16 OS			0.1885	0.1820		2-3/4		7/8		4
27218890	01645			4.80	0.1889	0.1820	4.62		70		22.0	4
27218900	01649		12		0.1890	0.1820		2-3/4		7/8		4
27218950	03274				0.1895	0.1820		2-3/4		7/8		4
27219000	03275				0.1900	0.1820		2-3/4		7/8		4
27219050	03276				0.1905	0.1820		2-3/4		7/8		4
27219090	01653			4.85	0.1909	0.1820	4.62		70		22.0	4
27219100	01657		11		0.1910	0.1820		2-3/4		7/8		4
27219150	03277				0.1915	0.1900		3		1		4
27219200	03278				0.1920	0.1900		3		1		4
27219250	03279				0.1925	0.1900		3		1		4
27219290	01661			4.90	0.1929	0.1900	4.83		76		25.5	4
27219300	03280				0.1930	0.1900		3		1		4
27219350	01665		10		0.1935	0.1900		3		1		4
27219400	03281				0.1940	0.1900		3		1		4
27219450	03282				0.1945	0.1900		3		1		4
27219490	01669			4.95	0.1949	0.1900	4.83		76		25.5	4
27219500	03283				0.1950	0.1900		3		1		4
27219550	03284				0.1955	0.1900		3		1		4



Series 272 Continued

Tool No.	EDP	Diameter				Shank		OAL		Flute Length		Flutes
		D1				D2		L1		L2		
		Inch	Wire	mm	Decimal	Inch	mm	Inch	mm	Inch	mm	
27219600	01673		9		0.1960	0.1900		3		1		4
27219650	03285				0.1965	0.1900		3		1		4
27219690	01677			5.00	0.1969	0.1900	4.83		76		25.5	4
27219700	03286				0.1970	0.1900		3		1		4
27219750	03287				0.1975	0.1900		3		1		4
27219800	03288				0.1980	0.1900		3		1		4
27219850	03289				0.1985	0.1900		3		1		4
27219880	01681			5.05	0.1988	0.1900	4.83		76		25.5	4
27219900	01685		8		0.1990	0.1900		3		1		4
27219950	03290				0.1995	0.1980		3		1		4
27220000	03291				0.2000	0.1980		3		1		4
27220050	03292				0.2005	0.1980		3		1		4
27220080	01689			5.10	0.2008	0.1980	5.03		76		25.5	4
27220100	01693		7		0.2010	0.1980		3		1		4
27220150	03293				0.2015	0.1980		3		1		4
27220200	03294				0.2020	0.1980		3		1		4
27220250	03295				0.2025	0.1980		3		1		4
27220280	01697			5.15	0.2028	0.1980	5.03		76		25.5	4
27220300	03296				0.2030	0.1980		3		1		4
27220310	01701	13/64			0.2031	0.1980		3		1		4
27220350	03297				0.2035	0.1980		3		1		4
27220400	01705		6		0.2040	0.1980		3		1		4
27220450	03298				0.2045	0.1980		3		1		4
27220470	01709			5.20	0.2047	0.1980	5.03		76		25.5	4
27220500	03299				0.2050	0.1980		3		1		4
27220550	01713		5		0.2055	0.1980		3		1		4
27220600	03300				0.2060	0.1980		3		1		4
27220650	03301				0.2065	0.2050		3		1		4
27220670	01717			5.25	0.2067	0.2050	5.21		76		25.5	4
27220700	03302				0.2070	0.2050		3		1		4
27220750	03303				0.2075	0.2050		3		1		4
27220800	03304				0.2080	0.2050		3		1		4
27220850	03305				0.2085	0.2050		3		1		4
27220870	01721			5.30	0.2087	0.2050	5.21		76		25.5	4
27220900	01725		4		0.2090	0.2050		3		1		4
27220950	03306				0.2095	0.2050		3		1		4
27221000	03307				0.2100	0.2050		3		1		4
27221050	03308				0.2105	0.2050		3		1		4
27221060	01729			5.35	0.2106	0.2050	5.21		76		25.5	4
27221100	03309				0.2110	0.2050		3		1		4
27221150	03310				0.2115	0.2050		3		1		4
27221200	03311				0.2120	0.2050		3		1		4
27221250	03312				0.2125	0.2050		3		1		4
27221260	01733			5.40	0.2126	0.2050	5.21		76		25.5	4



Series 272 Continued

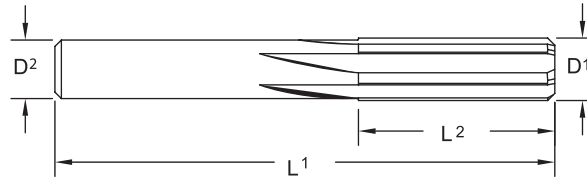
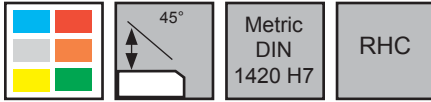

Tool No.	EDP	Diameter				Shank		OAL		Flute Length		Flutes
		D1				D2		L1		L2		
		Inch	Wire	mm	Decimal	Inch	mm	Inch	mm	Inch	mm	
27221300	01737		3		0.2130	0.2050		3		1		4
27221350	03313				0.2135	0.2050		3		1		4
27221400	03314				0.2140	0.2050		3		1		4
27221450	03315				0.2145	0.2130		3		1		4
27221460	01741			5.45	0.2146	0.2130	5.41		76		25.5	4
27221500	03316				0.2150	0.2130		3		1		4
27221550	03317				0.2155	0.2130		3		1		4
27221600	03318				0.2160	0.2130		3		1		4
27221650	01745			5.50	0.2165	0.2130	5.41		76		25.5	4
27221651	03634				0.2165	0.2130		3		1		4
27221700	03319				0.2170	0.2130		3		1		4
27221750	03320				0.2175	0.2130		3		1		4
27221800	03321				0.2180	0.2130		3		1		4
27221850	01749			5.55	0.2185	0.2130	5.41		76		25.5	4
27221851	03635				0.2185	0.2130		3		1		4
27221870	01753	7/32			0.2187	0.2130		3		1		4
27221900	03322				0.2190	0.2130		3		1		4
27221950	03323				0.2195	0.2130		3		1		4
27222000	03324				0.2200	0.2130		3		1		4
27222050	01757			5.60	0.2205	0.2130	5.41		76		25.5	4
27222051	03636				0.2205	0.2130		3		1		4
27222100	01761		2		0.2210	0.2130		3		1		4
27222150	03325				0.2215	0.2130		3		1		4
27222200	03326				0.2220	0.2130		3		1		4
27222240	01765			5.65	0.2224	0.2210	5.61		76		25.5	4
27222250	03327				0.2225	0.2210		3		1		4
27222300	03328				0.2230	0.2210		3		1		4
27222350	03329				0.2235	0.2210		3		1		4
27222400	03330				0.2240	0.2210		3		1		4
27222440	01769			5.70	0.2244	0.2210	5.61		76		25.5	4
27222450	03331				0.2245	0.2210		3		1		4
27222500	03332				0.2250	0.2210		3		1		4
27222550	03333				0.2255	0.2210		3		1		4
27222600	03334				0.2260	0.2210		3		1		4
27222640	01773			5.75	0.2264	0.2210	5.61		76		25.5	4
27222650	03335				0.2265	0.2210		3		1		4
27222700	03336				0.2270	0.2210		3		1		4
27222750	03337				0.2275	0.2210		3		1		4
27222800	01777		1		0.2280	0.2210		3		1		4
27222830	01781			5.80	0.2283	0.2210	5.61		76		25.5	4
27222850	03338				0.2285	0.2210		3		1		4
27222900	03339				0.2290	0.2210		3		1		4



Series 272 Continued

Tool No.	EDP	Diameter				Shank		OAL		Flute Length		Flutes
		D1				D2		L1		L2		
		Inch	Wire	mm	Decimal	Inch	mm	Inch	mm	Inch	mm	
27222950	03340				0.2295	0.2210		3		1		4
27223000	03341				0.2300	0.2210		3		1		4
27223030	01785			5.85	0.2303	0.2290	5.82		76		25.5	4
27223050	03342				0.2305	0.2290		3		1		4
27223100	03343				0.2310	0.2290		3		1		4
27223150	03344				0.2315	0.2290		3		1		4
27223200	03345				0.2320	0.2290		3		1		4
27223230	01789			5.90	0.2323	0.2290	5.82		76		25.5	4
27223250	03346				0.2325	0.2290		3		1		4
27223300	03347				0.2330	0.2290		3		1		4
27223350	03348				0.2335	0.2290		3		1		4
27223400	01793		A		0.2340	0.2290		3		1		4
27223430	01797			5.95	0.2343	0.2290	5.82		76		25.5	4
27223440	01801	15/64			0.2344	0.2290		3		1		4
27223450	03349				0.2345	0.2290		3		1		4
27223500	03350				0.2350	0.2290		3		1		4
27223550	03351				0.2355	0.2290		3		1		4
27223600	03352				0.2360	0.2290		3		1		4
27223620	01805			6.00	0.2362	0.2290	5.82		76		25.5	4
27223650	03353				0.2365	0.2290		3		1		4
27223700	03354				0.2370	0.2290		3		1		4
27223750	03355				0.2375	0.2360		3		1		4
27223800	01809		B		0.2380	0.2360		3		1		4
27223820	01810			6.05	0.2382	0.2360	5.99		76		25.5	4
27223850	03356				0.2385	0.2360		3		1		4
27223900	03357				0.2390	0.2360		3		1		4
27223950	03358				0.2395	0.2360		3		1		4
27224000	03359				0.2400	0.2360		3		1		4
27224020	01813			6.10	0.2402	0.2360	5.99		76		25.5	4
27224050	03360				0.2405	0.2360		3		1		4
27224100	03361				0.2410	0.2360		3		1		4
27224150	03362				0.2415	0.2360		3		1		4
27224200	01817		C		0.2420	0.2360		3		1		4
27224210	01818			6.15	0.2421	0.2360	5.99		76		25.5	4
27224250	03363				0.2425	0.2360		3		1		4
27224300	03364				0.2430	0.2360		3		1		4
27224350	03365				0.2435	0.2360		3		1		4
27224400	03366				0.2440	0.2360		3		1		4
27224410	01821			6.20	0.2441	0.2360	5.99		76		25.5	4
27224450	03367				0.2445	0.2360		3		1		4
27224500	03368				0.2450	0.2360		3		1		4
27224550	03369				0.2455	0.2440		3		1		4
27224600	01825		D		0.2460	0.2440		3		1		4
27224610	01829			6.25	0.2461	0.2440	6.20		76		25.5	4



Series 272 Continued

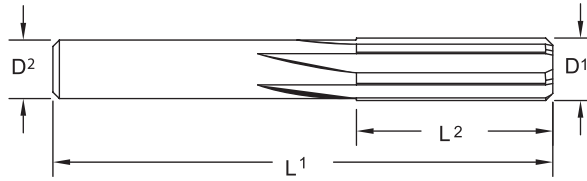
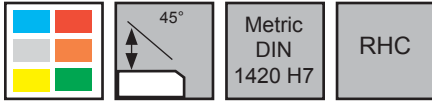

Tool No.	EDP	Diameter				Shank		OAL		Flute Length		Flutes
		D1				D2		L1		L2		
		Inch	Wire	mm	Decimal	Inch	mm	Inch	mm	Inch	mm	
27224650	03370				0.2465	0.2440		3		1		4
27224700	03371				0.2470	0.2440		3		1		4
27224750	03372				0.2475	0.2440		3		1		4
27224800	01833			6.30	0.2480	0.2440	6.20		76		25.5	4
27224801	03637				0.2480	0.2440		3		1		4
27224850	03373				0.2485	0.2440		3		1		4
27224900	03374				0.2490	0.2440		3		1		4
27224950	03375	1/4 DP2			0.2495	0.2440		3		1		4
27224980	03376	1/4 DP1			0.2498	0.2440		3		1		4
27224990	03377	1/4 US			0.2499	0.2440		3		1		4
27225000	01837	1/4	E		0.2500	0.2440		3		1		4
27225001	03378			6.35	0.2500	0.2440	6.20		76		25.5	4
27225050	03379				0.2505	0.2440		3		1		4
27225100	03380	1/4 OS			0.2510	0.2440		3		1		4
27225150	03381				0.2515	0.2440		3		1		4
27225190	01841			6.40	0.2519	0.2440	6.20		76		25.5	4
27225200	03382				0.2520	0.2440		3		1		4
27225250	03383				0.2525	0.2440		3		1		4
27225300	03384				0.2530	0.2440		3		1		4
27225390	01844			6.45	0.2539	0.2520	6.40		83		28.5	6
27225400	03385				0.2540	0.2520		3-1/4		1-1/8		6
27225500	03386				0.2550	0.2520		3-1/4		1-1/8		6
27225590	01845			6.50	0.2559	0.2520	6.40		83		28.5	6
27225600	03387				0.2560	0.2520		3-1/4		1-1/8		6
27225700	01849		F		0.2570	0.2520		3-1/4		1-1/8		6
27225800	03388				0.2580	0.2520		3-1/4		1-1/8		6
27225900	03389				0.2590	0.2520		3-1/4		1-1/8		6
27226000	03390				0.2600	0.2520		3-1/4		1-1/8		6
27226100	01853		G		0.2610	0.2520		3-1/4		1-1/8		6
27226200	03391				0.2620	0.2520		3-1/4		1-1/8		6
27226300	03392				0.2630	0.2520		3-1/4		1-1/8		6
27226400	03393				0.2640	0.2520		3-1/4		1-1/8		6
27226500	03394				0.2650	0.2520		3-1/4		1-1/8		6
27226560	01857	17/64			0.2656	0.2520		3-1/4		1-1/8		6
27226600	01861		H		0.2660	0.2520		3-1/4		1-1/8		6
27226700	03395				0.2670	0.2520		3-1/4		1-1/8		6
27226800	03396				0.2680	0.2520		3-1/4		1-1/8		6
27226900	03397				0.2690	0.2520		3-1/4		1-1/8		6
27227000	03398				0.2700	0.2520		3-1/4		1-1/8		6
27227100	03399				0.2710	0.2520		3-1/4		1-1/8		6
27227200	01865		I		0.2720	0.2700		3-1/4		1-1/8		6
27227300	03400				0.2730	0.2700		3-1/4		1-1/8		6



Series 272 Continued

Tool No.	EDP	Diameter				Shank		OAL		Flute Length		Flutes
		D1				D2		L1		L2		
		Inch	Wire	mm	Decimal	Inch	mm	Inch	mm	Inch	mm	
27227400	03401				0.2740	0.2700		3-1/4		1-1/8		6
27227500	03402				0.2750	0.2700		3-1/4		1-1/8		6
27227560	01869			7.00	0.2756	0.2700	6.86		83		28.5	6
27227600	03403				0.2760	0.2700		3-1/4		1-1/8		6
27227700	01873		J		0.2770	0.2700		3-1/4		1-1/8		6
27227800	03404				0.2780	0.2700		3-1/4		1-1/8		6
27227900	03405				0.2790	0.2700		3-1/4		1-1/8		6
27228000	03406				0.2800	0.2700		3-1/4		1-1/8		6
27228100	01877		K		0.2810	0.2700		3-1/4		1-1/8		6
27228120	01881	9/32			0.2812	0.2700		3-1/4		1-1/8		6
27228200	03407				0.2820	0.2700		3-1/4		1-1/8		6
27228300	03408				0.2830	0.2700		3-1/4		1-1/8		6
27228400	03409				0.2840	0.2700		3-1/4		1-1/8		6
27228500	03410				0.2850	0.2700		3-1/4		1-1/8		6
27228600	03411				0.2860	0.2700		3-1/4		1-1/8		6
27228700	03412				0.2870	0.2850		3-1/4		1-1/8		6
27228800	03413				0.2880	0.2850		3-1/4		1-1/8		6
27228900	03414				0.2890	0.2850		3-1/4		1-1/8		6
27229000	01885		L		0.2900	0.2850		3-1/4		1-1/8		6
27229100	03415				0.2910	0.2850		3-1/4		1-1/8		6
27229200	03416				0.2920	0.2850		3-1/4		1-1/8		6
27229300	03417				0.2930	0.2850		3-1/4		1-1/8		6
27229400	03418				0.2940	0.2850		3-1/4		1-1/8		6
27229500	01889		M		0.2950	0.2850		3-1/4		1-1/8		6
27229530	01893			7.50	0.2953	0.2850	7.24		83		28.5	6
27229600	03419				0.2960	0.2850		3-1/4		1-1/8		6
27229680	01897	19/64			0.2968	0.2850		3-1/4		1-1/8		6
27229700	03420				0.2970	0.2850		3-1/4		1-1/8		6
27229800	03421				0.2980	0.2850		3-1/4		1-1/8		6
27229900	03422				0.2990	0.2850		3-1/4		1-1/8		6
27230000	03423				0.3000	0.2850		3-1/4		1-1/8		6
27230100	03424				0.3010	0.2850		3-1/4		1-1/8		6
27230200	01901		N		0.3020	0.2850		3-1/4		1-1/8		6
27230300	03425				0.3030	0.3010		3-1/4		1-1/8		6
27230400	03426				0.3040	0.3010		3-1/4		1-1/8		6
27230500	03427				0.3050	0.3010		3-1/4		1-1/8		6
27230600	03428				0.3060	0.3010		3-1/4		1-1/8		6
27230700	03429				0.3070	0.3010		3-1/4		1-1/8		6
27230800	03430				0.3080	0.3010		3-1/4		1-1/8		6
27230900	03431				0.3090	0.3010		3-1/4		1-1/8		6
27231000	03432				0.3100	0.3010		3-1/4		1-1/8		6
27231050	01903				0.3105	0.3010		3-1/4		1-1/8		6
27231100	03433				0.3110	0.3010		3-1/4		1-1/8		6
27231150	01904				0.3115	0.3010		3-1/4		1-1/8		6
27231200	03434	5/16 DP2			0.3120	0.3010		3-1/4		1-1/8		6



Series 272 Continued

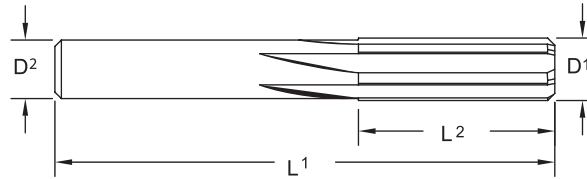
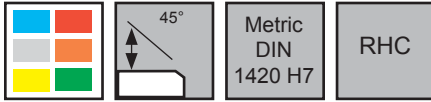

Tool No.	EDP	Diameter				Shank		OAL		Flute Length		Flutes	
		D1				D2		L1		L2			
		Inch	Wire	mm	Decimal	Inch	mm	Inch	mm	Inch	mm		
27231230	03435	5/16 DP1			0.3123	0.3010			3-1/4		1-1/8		6
27231240	03436	5/16 US			0.3124	0.3010			3-1/4		1-1/8		6
27231250	01905	5/16			0.3125	0.3010			3-1/4		1-1/8		6
27231300	03437				0.3130	0.3010			3-1/4		1-1/8		6
27231350	03438	5/16 OS			0.3135	0.3010			3-1/4		1-1/8		6
27231400	03439				0.3140	0.3010			3-1/4		1-1/8		6
27231500	01909			8.00	0.3150	0.3010	7.65		83		28.5		6
27231501	03638				0.3150	0.3010			3-1/4		1-1/8		6
27231600	01913		O		0.3160	0.3010			3-1/4		1-1/8		6
27231700	03440				0.3170	0.3010			3-1/4		1-1/8		6
27231800	03441				0.3180	0.3010			3-1/4		1-1/8		6
27231900	03442				0.3190	0.3170			3-1/2		1-1/4		6
27232000	03443				0.3200	0.3170			3-1/2		1-1/4		6
27232100	03444				0.3210	0.3170			3-1/2		1-1/4		6
27232200	03445				0.3220	0.3170			3-1/2		1-1/4		6
27232300	01917		P		0.3230	0.3170			3-1/2		1-1/4		6
27232400	03446				0.3240	0.3170			3-1/2		1-1/4		6
27232500	03447				0.3250	0.3170			3-1/2		1-1/4		6
27232600	03448				0.3260	0.3170			3-1/2		1-1/4		6
27232700	03449				0.3270	0.3170			3-1/2		1-1/4		6
27232800	03450				0.3280	0.3170			3-1/2		1-1/4		6
27232810	01921	21/64			0.3281	0.3170			3-1/2		1-1/4		6
27232900	03451				0.3290	0.3170			3-1/2		1-1/4		6
27233000	03452				0.3300	0.3170			3-1/2		1-1/4		6
27233100	03453				0.3310	0.3170			3-1/2		1-1/4		6
27233200	01925		Q		0.3320	0.3170			3-1/2		1-1/4		6
27233300	03454				0.3330	0.3170			3-1/2		1-1/4		6
27233400	03455				0.3340	0.3320			3-1/2		1-1/4		6
27233460	01929			8.50	0.3346	0.3320	8.43		89		32.0		6
27233500	03456				0.3350	0.3320			3-1/2		1-1/4		6
27233600	03457				0.3360	0.3320			3-1/2		1-1/4		6
27233700	03458				0.3370	0.3320			3-1/2		1-1/4		6
27233800	03459				0.3380	0.3320			3-1/2		1-1/4		6
27233900	01933		R		0.3390	0.3320			3-1/2		1-1/4		6
27234000	03460				0.3400	0.3320			3-1/2		1-1/4		6
27234100	03461				0.3410	0.3320			3-1/2		1-1/4		6
27234200	03462				0.3420	0.3320			3-1/2		1-1/4		6
27234300	03463				0.3430	0.3320			3-1/2		1-1/4		6
27234370	01937	11/32			0.3437	0.3320			3-1/2		1-1/4		6
27234400	03464				0.3440	0.3320			3-1/2		1-1/4		6
27234500	03465				0.3450	0.3320			3-1/2		1-1/4		6
27234600	03466				0.3460	0.3320			3-1/2		1-1/4		6
27234700	03467				0.3470	0.3320			3-1/2		1-1/4		6



Series 272 Continued

Tool No.	EDP	Diameter				Shank		OAL		Flute Length		Flutes
		D1				D2		L1		L2		
		Inch	Wire	mm	Decimal	Inch	mm	Inch	mm	Inch	mm	
27234800	01941		S		0.3480	0.3320		3-1/2		1-1/4		6
27234900	03468				0.3490	0.3320		3-1/2		1-1/4		6
27235000	03469				0.3500	0.3480		3-1/2		1-1/4		6
27235100	03470				0.3510	0.3480		3-1/2		1-1/4		6
27235200	03471				0.3520	0.3480		3-1/2		1-1/4		6
27235300	03472				0.3530	0.3480		3-1/2		1-1/4		6
27235400	03473				0.3540	0.3480		3-1/2		1-1/4		6
27235430	01945			9.00	0.3543	0.3480	8.84		89		32.0	6
27235500	03474				0.3550	0.3480		3-1/2		1-1/4		6
27235600	03475				0.3560	0.3480		3-1/2		1-1/4		6
27235700	03476				0.3570	0.3480		3-1/2		1-1/4		6
27235800	01949		T		0.3580	0.3480		3-1/2		1-1/4		6
27235900	03477				0.3590	0.3480		3-1/2		1-1/4		6
27235940	01953	23/64			0.3594	0.3480		3-1/2		1-1/4		6
27236000	03478				0.3600	0.3480		3-1/2		1-1/4		6
27236100	03479				0.3610	0.3480		3-1/2		1-1/4		6
27236200	03480				0.3620	0.3480		3-1/2		1-1/4		6
27236300	03481				0.3630	0.3480		3-1/2		1-1/4		6
27236400	03482				0.3640	0.3480		3-1/2		1-1/4		6
27236500	03483				0.3650	0.3630		3-1/2		1-1/4		6
27236600	03484				0.3660	0.3630		3-1/2		1-1/4		6
27236700	03485				0.3670	0.3630		3-1/2		1-1/4		6
27236800	01957		U		0.3680	0.3630		3-1/2		1-1/4		6
27236900	03486				0.3690	0.3630		3-1/2		1-1/4		6
27237000	03487				0.3700	0.3630		3-1/2		1-1/4		6
27237100	03488				0.3710	0.3630		3-1/2		1-1/4		6
27237200	03489				0.3720	0.3630		3-1/2		1-1/4		6
27237300	03490				0.3730	0.3630		3-1/2		1-1/4		6
27237400	01961			9.50	0.3740	0.3630	9.22		89		32.0	6
27237401	03639				0.3740	0.3630		3-1/2		1-1/4		6
27237450	03491	3/8 DP2			0.3745	0.3630		3-1/2		1-1/4		6
27237480	03492	3/8 DP1			0.3748	0.3630		3-1/2		1-1/4		6
27237490	03493	3/8 US			0.3749	0.3630		3-1/2		1-1/4		6
27237500	01965	3/8			0.3750	0.3630		3-1/2		1-1/4		6
27237600	03494	3/8 OS			0.3760	0.3630		3-1/2		1-1/4		6
27237700	01969		V		0.3770	0.3630		3-1/2		1-1/4		6
27237800	03495				0.3780	0.3630		3-1/2		1-1/4		6
27237900	03496				0.3790	0.3630		3-1/2		1-1/4		6
27238000	03497				0.3800	0.3630		3-1/2		1-1/4		6
27238100	03498				0.3810	0.3630		3-1/2		1-1/4		6
27238200	03499				0.3820	0.3630		3-1/2		1-1/4		6
27238300	03500				0.3830	0.3630		3-1/2		1-1/4		6
27238400	03501				0.3840	0.3630		3-1/2		1-1/4		6
27238500	03502				0.3850	0.3630		3-1/2		1-1/4		6
27238600	01973		W		0.3860	0.3630		3-1/2		1-1/4		6
27238700	03503				0.3870	0.3800		3-1/2		1-1/4		6



Series 272 Continued

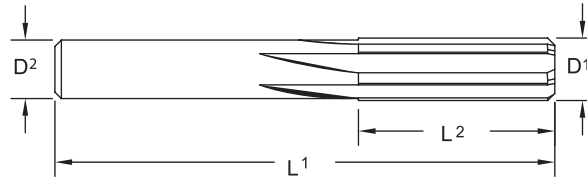
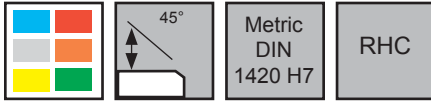

Tool No.	EDP	Diameter				Shank		OAL		Flute Length		Flutes	
		D1				D2		L1		L2			
		Inch	Wire	mm	Decimal	Inch	mm	Inch	mm	Inch	mm		
27238800	03504				0.3880	0.3800			3-1/2		1-1/4		6
27238900	03505				0.3890	0.3800			3-1/2		1-1/4		6
27239000	03506				0.3900	0.3800			3-1/2		1-1/4		6
27239060	01977	25/64			0.3906	0.3800			3-1/2		1-1/4		6
27239100	03507				0.3910	0.3800			3-1/2		1-1/4		6
27239200	03508				0.3920	0.3800			3-1/2		1-1/4		6
27239300	03509				0.3930	0.3800			3-1/2		1-1/4		6
27239370	01979			10.00	0.3937	0.3800	9.65		89		32.0		6
27239400	03510				0.3940	0.3800			3-1/2		1-1/4		6
27239500	03511				0.3950	0.3800			3-1/2		1-1/4		6
27239600	03512				0.3960	0.3800			3-1/2		1-1/4		6
27239700	01981		X		0.3970	0.3800			3-1/2		1-1/4		6
27239800	03513				0.3980	0.3800			3-1/2		1-1/4		6
27239900	03514				0.3990	0.3800			3-1/2		1-1/4		6
27240000	03515				0.4000	0.3800			3-1/2		1-1/4		6
27240100	03516				0.4010	0.3800			3-1/2		1-1/4		6
27240200	03517				0.4020	0.3800			3-1/2		1-1/4		6
27240300	03518				0.4030	0.3800			3-1/2		1-1/4		6
27240400	01983		Y		0.4040	0.3800			3-1/2		1-1/4		6
27240500	03519				0.4050	0.3800			3-1/2		1-1/4		6
27240600	03520				0.4060	0.3800			3-1/2		1-1/4		6
27240620	01985	13/32			0.4062	0.3800			3-1/2		1-1/4		6
27240700	03521				0.4070	0.3800			3-1/2		1-1/4		6
27240800	03522				0.4080	0.3800			3-1/2		1-1/4		6
27240900	03523				0.4090	0.3800			3-1/2		1-1/4		6
27241000	03524				0.4100	0.3800			3-1/2		1-1/4		6
27241100	03525				0.4110	0.3800			3-1/2		1-1/4		6
27241200	03526				0.4120	0.3800			3-1/2		1-1/4		6
27241300	01987		Z		0.4130	0.3800			3-1/2		1-1/4		6
27241340	01989			10.50	0.4134	0.3800	9.65		89		32.0		6
27241400	03527				0.4140	0.3800			3-1/2		1-1/4		6
27241500	03528				0.4150	0.3800			3-1/2		1-1/4		6
27241600	03529				0.4160	0.4100			3-3/4		1-3/8		6
27241700	03530				0.4170	0.4100			3-3/4		1-3/8		6
27241800	03531				0.4180	0.4100			3-3/4		1-3/8		6
27241900	03532				0.4190	0.4100			3-3/4		1-3/8		6
27242000	03533				0.4200	0.4100			3-3/4		1-3/8		6
27242100	03534				0.4210	0.4100			3-3/4		1-3/8		6
27242190	01991	27/64			0.4219	0.4100			3-3/4		1-3/8		6
27242200	03535				0.4220	0.4100			3-3/4		1-3/8		6
27242300	03536				0.4230	0.4100			3-3/4		1-3/8		6
27242400	03537				0.4240	0.4100			3-3/4		1-3/8		6



Series 272 Continued

Tool No.	EDP	Diameter				Shank		OAL		Flute Length		Flutes	
		D1				D2		L1		L2			
		Inch	Wire	mm	Decimal	Inch	mm	Inch	mm	Inch	mm		
27242500	03538				0.4250	0.4100			3-3/4		1-3/8		6
27242600	03539				0.4260	0.4100			3-3/4		1-3/8		6
27242700	03540				0.4270	0.4100			3-3/4		1-3/8		6
27242800	03541				0.4280	0.4100			3-3/4		1-3/8		6
27242900	03542				0.4290	0.4100			3-3/4		1-3/8		6
27243000	03543				0.4300	0.4100			3-3/4		1-3/8		6
27243100	03544				0.4310	0.4100			3-3/4		1-3/8		6
27243200	03545				0.4320	0.4100			3-3/4		1-3/8		6
27243300	03546				0.4330	0.4100			3-3/4		1-3/8		6
27243310	01993			11.00	0.4331	0.4100	10.41		95		35.0		6
27243400	03547				0.4340	0.4100			3-3/4		1-3/8		6
27243500	03548				0.4350	0.4100			3-3/4		1-3/8		6
27243600	03549				0.4360	0.4100			3-3/4		1-3/8		6
27243700	03550	7/16 DP2			0.4370	0.4100			3-3/4		1-3/8		6
27243730	03551	7/16 DP1			0.4373	0.4100			3-3/4		1-3/8		6
27243740	03552	7/16 US			0.4374	0.4100			3-3/4		1-3/8		6
27243750	01995	7/16			0.4375	0.4100			3-3/4		1-3/8		6
27243800	03553				0.4380	0.4100			3-3/4		1-3/8		6
27243850	03619	7/16 OS			0.4385	0.4100			3-3/4		1-3/8		6
27243900	03554				0.4390	0.4100			3-3/4		1-3/8		6
27244000	03555				0.4400	0.4100			3-3/4		1-3/8		6
27244100	03556				0.4410	0.4100			3-3/4		1-3/8		6
27244200	03557				0.4420	0.4100			3-3/4		1-3/8		6
27244300	03558				0.4430	0.4100			3-3/4		1-3/8		6
27244400	03559				0.4440	0.4100			3-3/4		1-3/8		6
27244500	03560				0.4450	0.4100			3-3/4		1-3/8		6
27244600	03561				0.4460	0.4400			3-3/4		1-3/8		6
27244700	03562				0.4470	0.4400			3-3/4		1-3/8		6
27244800	03563				0.4480	0.4400			3-3/4		1-3/8		6
27244900	03564				0.4490	0.4400			3-3/4		1-3/8		6
27245000	03565				0.4500	0.4400			3-3/4		1-3/8		6
27245100	03566				0.4510	0.4400			3-3/4		1-3/8		6
27245200	03567				0.4520	0.4400			3-3/4		1-3/8		6
27245270	01997			11.50	0.4527	0.4400	11.18		95		35.0		6
27245300	03568				0.4530	0.4400			3-3/4		1-3/8		6
27245310	01999	29/64			0.4531	0.4400			3-3/4		1-3/8		6
27245400	03569				0.4540	0.4400			3-3/4		1-3/8		6
27245500	03570				0.4550	0.4400			3-3/4		1-3/8		6
27245600	03571				0.4560	0.4400			3-3/4		1-3/8		6
27245700	03572				0.4570	0.4400			3-3/4		1-3/8		6
27245800	03573				0.4580	0.4400			3-3/4		1-3/8		6
27245900	03574				0.4590	0.4400			3-3/4		1-3/8		6
27246000	03575				0.4600	0.4400			3-3/4		1-3/8		6
27246100	03576				0.4610	0.4400			3-3/4		1-3/8		6
27246200	03577				0.4620	0.4400			3-3/4		1-3/8		6
27246300	03578				0.4630	0.4400			3-3/4		1-3/8		6



Series 272 Continued

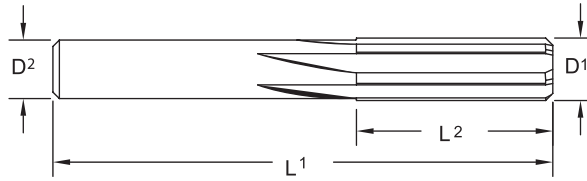
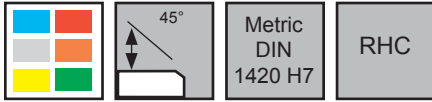

Tool No.	EDP	Diameter				Shank		OAL		Flute Length		Flutes
		D1				D2		L1		L2		
		Inch	Wire	mm	Decimal	Inch	mm	Inch	mm	Inch	mm	
27246400	03579				0.4640	0.4400		3-3/4		1-3/8		6
27246500	03580				0.4650	0.4400		3-3/4		1-3/8		6
27246600	03581				0.4660	0.4400		3-3/4		1-3/8		6
27246700	03582				0.4670	0.4400		3-3/4		1-3/8		6
27246800	03583				0.4680	0.4400		3-3/4		1-3/8		6
27246880	02001	15/32			0.4688	0.4400		3-3/4		1-3/8		6
27246900	03584				0.4690	0.4400		3-3/4		1-3/8		6
27247000	03585				0.4700	0.4400		3-3/4		1-3/8		6
27247100	03586				0.4710	0.4400		3-3/4		1-3/8		6
27247200	03587				0.4720	0.4400		3-3/4		1-3/8		6
27247240	02003			12.00	0.4724	0.4400	11.18		95		35.0	6
27247300	03588				0.4730	0.4400		3-3/4		1-3/8		6
27247400	03589				0.4740	0.4400		3-3/4		1-3/8		6
27247500	03590				0.4750	0.4400		3-3/4		1-3/8		6
27247600	03591				0.4760	0.4700		4		1-1/2		6
27247700	03592				0.4770	0.4700		4		1-1/2		6
27247800	03593				0.4780	0.4700		4		1-1/2		6
27247900	03594				0.4790	0.4700		4		1-1/2		6
27248000	03595				0.4800	0.4700		4		1-1/2		6
27248100	03596				0.4810	0.4700		4		1-1/2		6
27248200	03597				0.4820	0.4700		4		1-1/2		6
27248300	03598				0.4830	0.4700		4		1-1/2		6
27248400	03599				0.4840	0.4700		4		1-1/2		6
27248440	02005	31/64			0.4844	0.4700		4		1-1/2		6
27248500	03600				0.4850	0.4700		4		1-1/2		6
27248600	03601				0.4860	0.4700		4		1-1/2		6
27248700	03602				0.4870	0.4700		4		1-1/2		6
27248800	03603				0.4880	0.4700		4		1-1/2		6
27248900	03604				0.4890	0.4700		4		1-1/2		6
27249000	03605				0.4900	0.4700		4		1-1/2		6
27249100	03606				0.4910	0.4700		4		1-1/2		6
27249200	03607				0.4920	0.4700		4		1-1/2		6
27249300	03608				0.4930	0.4700		4		1-1/2		6
27249400	03609				0.4940	0.4700		4		1-1/2		6
27249500	03610				0.4950	0.4700		4		1-1/2		6
27249600	03611				0.4960	0.4700		4		1-1/2		6
27249700	03612				0.4970	0.4700		4		1-1/2		6
27249800	03613				0.4980	0.4700		4		1-1/2		6
27249900	03614				0.4990	0.4700		4		1-1/2		6
27249950	03615	1/2 DP2			0.4995	0.4700		4		1-1/2		6
27249980	03616	1/2 DP1			0.4998	0.4700		4		1-1/2		6
27249990	03617	1/2 US			0.4999	0.4700		4		1-1/2		6



Series 272 Continued

Tool No.	EDP	Diameter				Shank		OAL		Flute Length		Flutes
		D1				D2		L1		L2		
		Inch	Wire	mm	Decimal	Inch	mm	Inch	mm	Inch	mm	
27250000	02007	1/2			0.5000	0.4700		4		1-1/2		6
27250100	03618	1/2 OS			0.5010	0.4700		4		1-1/2		6
27251180	02009			13.00	0.5118	0.5050	12.83		102		38.0	6
27251560	02011	33/64			0.5156	0.5050		4		1-1/2		6
27253120	02013	17/32			0.5312	0.5050		4		1-1/2		6
27254690	02015	35/64			0.5469	0.5350		4		1-1/2		6
27255120	02017			14.00	0.5512	0.5350	13.59		102		38.0	6
27256250	02019	9/16			0.5625	0.5350		4		1-1/2		6
27257810	02021	37/64			0.5781	0.5650		4		1-3/4		6
27259050	02023			15.00	0.5905	0.5650	14.35		102		44.5	6
27259380	02025	19/32			0.5938	0.5650		4		1-3/4		6
27260940	02027	39/64			0.6094	0.5950		4		1-3/4		6
27262500	02029	5/8			0.6250	0.5950		4		1-3/4		6
27262990	02031			16.00	0.6299	0.5950	15.11		102		44.5	6



Made in USA



ISO 9001:2008 Certified

Troubleshooting Chart

Problem	Possible Solution																		
	Speed & Feed						Tool Geometry						Coolant & Stock Removal						
	Reduce Feed	Increase Feed	Reduce Speed	Increase Speed	Use Larger Reamer	Use Smaller Reamer	Bad Speed & Feed	Worn Tool Margin	Worn Cutting Edge	Uneven Lip Height	Chip Capacity of Reamer	Too Much Clearance	Grind Larger Back Taper	Bent Reamer	Insufficient Stock	Too Much Stock	Use Coolant	Run Dry	Poor Hole Prep
Burnishing		X								X				X					
Reamer Wear	X		X				X									X	X		X
Hole Quality	X		X				X	X	X	X					X	X	X		X
Hole Undersize	X		X		X			X	X						X	X	X		
Hole Oversize		X		X		X		X	X					X		X	X	X	X
Accuracy	X					X				X							X		
Chatter		X	X							X	X	X			X		X		
Out of Round Hole					X			X	X	X	X				X	X	X		
Hole Taper						X		X	X	X			X			X	X		
Bell Mouth		X					X	X	X		X		X	X			X		
Reamer Life		X	X				X			X		X					X		
Scoring in Bore							X	X	X	X					X	X	X		X
Deflection																			

Problem	Possible Solution													
	Set Up						Cutting Errors							
	Alignment	Holder Accuracy	Concentricity	Use Adjustable Holder	Use Floating Holder	Lack of Rigidity in Set-Up	Work Holding Error	Spindle Bearings	Tool Extended Too Far	Poor Regrind	Poor Machinability	Built Up Edge	Wrong Tool	Poor Chip Removal
Burnishing	X						X			X				
Reamer Wear	X	X					X			X	X		X	
Hole Quality	X		X				X			X	X	X	X	
Hole Undersize	X										X			
Hole Oversize	X		X				X			X	X	X	X	
Accuracy							X			X				
Chatter	X	X				X	X	X	X	X				
Out of Round Hole	X						X			X				
Hole Taper	X	X	X	X	X		X			X	X	X		
Bell Mouth	X	X	X	X	X		X			X	X			
Reamer Life	X	X	X			X	X	X	X	X				
Scoring in Bore			X								X	X		X
Deflection	X													

Technical data provided should be considered advisory only as variations may be necessary depending on the particular application.

Total Stock Allowance - Inch

Material		Drill Decimal Equivalent/Size										
		.0135	.029/.028	.055/.052	.113	.238	.3594	.4844	.6094	.7344	.8594	.9844/1.480
		#80	#69/#70	#54/#55	#33	LET "B"	23/64	31/64	39/64	47/64	55/64	63/64
		Reamer Diameter										
		.0150	.0320	.0625	.1250	.2500	.3750	.5000	.6250	.7500	.8750	1.000-1.500
		Total Stock Allowance										
Magnesium		.0014	.0030	.0060	.0110	.0120	.0150	.0160	.0180	.0200	.0210	.0220
Aluminum	<5%SI	.0014	.0030	.0060	.0110	.0120	.0150	.0160	.0180	.0200	.0210	.0220
	>5%SI	.0014	.0030	.0060	.0110	.0120	.0130	.0150	.0160	.0180	.0190	.0200
Brass & Soft Bronze	Brass	.0014	.0030	.0060	.0110	.0120	.0130	.0150	.0160	.0180	.0190	.0200
	Bronze	.0014	.0030	.0060	.0110	.0120	.0140	.0150	.0170	.0190	.0200	.0210
Copper & Hard Bronze		.0014	.0030	.0060	.0110	.0120	.0140	.0150	.0170	.0190	.0200	.0210
Cast Iron	Cast	.0013	.0028	.0055	.0099	.0110	.0130	.0140	.0160	.0180	.0190	.0200
	Ductile	.0013	.0028	.0055	.0099	.0110	.0130	.0140	.0150	.0170	.0180	.0190
Steel	<35% C	.0013	.0028	.0055	.0099	.0110	.0130	.0140	.0160	.0170	.0180	.0190
	>35% C	.0012	.0025	.0049	.0089	.0100	.0120	.0130	.0150	.0170	.0180	.0190
	Tool	.0012	.0025	.0049	.0089	.0100	.0120	.0130	.0150	.0170	.0180	.0190
	Hard	.0009	.0020	.0040	.0072	.0080	.0100	.0110	.0130	.0140	.0150	.0160
Stainless		.0012	.0025	.0049	.0089	.0100	.0120	.0130	.0150	.0160	.0170	.0180
High Temp Alloys	Soft	.0012	.0025	.0049	.0089	.0100	.0110	.0130	.0140	.0160	.0170	.0180
	Hard	.0010	.0023	.0044	.0081	.0090	.0100	.0120	.0130	.0140	.0150	.0160
Titanium		.0013	.0028	.0055	.0099	.0110	.0130	.0140	.0160	.0170	.0180	.0190

Dowel Pin Chart - Inch

Dowel Pin	Nominal Dowel Decimal	Tight Press Fit Reamer		Tight Press Fit Reamer 0.0005		Loose Press Fit Reamer		Tight Slip Fit		Loose Slip Fit Reamer	
Size	Decimal	0.0005	Tool No.	DP(2)	Tool No.	DP(1)	Tool No.	Reamer	Tool No.	OS	Tool No.
1/8	.1250	.1230	27212300	.1245	27212450	.1248	27212480	.1255	27212550	.1260	27212601
3/16	.1875	.1855	27218550	.1870	27218701	.1873	27218730	.1880	27218800	.1885	27218850
1/4	.2500	.2480	27224801	.2495	27224950	.2498	27224980	.2505	27225050	.2510	27225100
5/16	.3125	.3110	27231100	.3120	27231200	.3123	27231230	.3130	27231300	.3135	27231350
3/8	.3750	.3740	27237401	.3745	27237450	.3748	27237480	.3750	27237500	.3760	27237600
7/16	.4735	.4360	27243600	.4370	27243700	.4373	27243730	.4380	27243800	.4385	27243850
1/2	.5000	.4990	27249900	.4995	27249950	.4998	27249980	.5000	27250000	.5010	27250100

+ 0.0001/ +0.0003 Tolerance (Reamer) Normal Dowels are nominal Size +.0001/ -.0001

Safety Note

Always wear the appropriate personal protective equipment such as safety glasses and protective clothing when using solid carbide or HSS cutting tools. Machines should be fully guarded. Technical data provided should be considered advisory only as variations may be necessary depending on the particular application.

Technical data provided should be considered advisory only as variations may be necessary depending on the particular application.

Total Stock Allowance - Metric

Material		Drill Size (mm)										
		0.30	0.90	1.80	2.70	3.70	4.70	5.70	7.60	9.60	11.60	15.50
		Reamer Diameter										
		0.35	1.00	2.00	3.00	4.00	5.00	6.00	8.00	10.00	12.00	16.00
		Total Stock Allowance										
Magnesium		.04	.09	.19	.27	.29	.29	.30	.34	.38	.40	.46
Aluminum	<5%Si	.04	.09	.19	.27	.29	.29	.30	.34	.38	.40	.46
	>5%Si	.04	.09	.19	.27	.29	.29	.30	.32	.34	.37	.41
Brass & Soft Bronze	Brass	.04	.09	.19	.27	.29	.29	.30	.32	.34	.37	.41
	Bronze	.04	.09	.19	.27	.29	.29	.30	.33	.36	.38	.43
Copper & Hard Bronze		.04	.09	.19	.27	.29	.29	.30	.33	.36	.38	.43
Cast Iron	Cast	.03	.09	.17	.24	.26	.27	.28	.31	.33	.35	.41
	Ductile	.03	.09	.17	.24	.26	.27	.28	.31	.33	.35	.38
Steel	<35% C	.03	.09	.17	.24	.26	.27	.28	.31	.33	.35	.41
	>35% C	.03	.08	.15	.21	.23	.24	.25	.28	.31	.32	.38
	Tool	.03	.08	.15	.21	.23	.24	.25	.28	.31	.32	.38
	Hard	.02	.06	.12	.17	.19	.19	.20	.23	.26	.27	.33
Stainless		.03	.08	.15	.21	.23	.24	.25	.28	.31	.32	.38
High Temp Alloys	Soft	.03	.08	.15	.21	.23	.24	.25	.27	.29	.32	.36
	Hard	.03	.07	.14	.20	.21	.22	.23	.24	.26	.29	.33
Titanium		.03	.09	.17	.24	.26	.27	.28	.31	.33	.35	.41

Dowel Pin Chart - Metric

Dowel Pin	Nominal Dowel Decimal	Tight Press Fit Reamer		Tight Press Fit Reamer 0.013		Loose Press Fit Reamer		Tight Slip Fit		Loose Slip Fit Reamer	
Size (mm)	Decimal	0.013	Tool No.	DP(2)	Tool No.	DP(1)	Tool No.	Reamer	Tool No.	OS	Tool No.
2	0.0787	1.95	27207670	1.98	27207810	1.99	27207850	2.01	27207900	2.02	27207950
3	0.1181	2.95	27211610	2.98	27211750	3.00	27211800	3.01	27211850	3.02	27211900
4	0.1575	3.95	27215550	3.99	27215700	4.00	27215750	4.01	27215800	4.03	27215850
5	0.1969	4.95	27219490	4.99	27219650	5.00	27219690	5.02	27219750	5.03	27219800
6	0.2362	5.95	27223430	5.98	27223550	5.99	27223600	6.01	27223650	6.02	27223700
8	0.3150	7.95	27231300	7.98	27231400	8.00	27231500	8.00	27231500	8.03	27231600
10	0.3937	9.96	27239200	9.98	27239300	10.00	27239370	10.01	27239400	10.03	27239500
12	0.4724	11.96	27247100	11.99	27247200	12.00	27247240	12.01	27247300	12.01	27247300

Tolerance (Reamer) Per **DIN 1420 H7** Normal Dowels are nominal size +.0001" / -.0001" (+.0025/- .0025mm)

Technical data provided should be considered advisory only as variations may be necessary depending on the particular application.

Reamer Cutting Data - Inch

Workpiece Material Group	I S O	Hardness	vc-SFM	Reamer Diameter				
				f-IPR				
				≥ 1/16	>1/16 - 1/8	>1/8 - 1/4	>1/4 - 1/2	>1/2 - 1
Free Machining & Low Carbon Steels 1006, 1008, 1015, 1018, 1020, 1022, 1025, 1117, 1140, 1141, 11L08, 11L14, 1213, 12L13, 12L14, 1215, 1330	P	up to 28 Rc	200-300	.0005-.0030	.0020-.0060	.0040-.0100	.0060-.0150	.0100-.0300
Medium Carbon & High Carbon Steels, Alloy Steels & Easy to Machine Tool Steels 1030, 1035, 1040, 1045, 1050, 1052, 1055, 1060, 1085, 1095, 1541, 1551, 9255, 2515, 3135, 3415, 4130, 4137, 4140, 4150, 4320, 4340, 4520, 5015, 5115, 5120, 5132, 5140, 5155, 6150, 8620, 9262, 9840, 52100, O1, O2, O6, S2, W1 to W310	P	28 to 38 Rc	125-200	.0005-.0020	.0020-.0040	.0040-.0060	.0060-.0100	.0100-.0200
Tool Steels & Die Steels O7, M1, M2, M3, M4, M7, T1, T2, T4, T5, T8, T15, A2, A3, A6, A7, H10, H11, H12, H13, H19, H21, L3, L6, L7, P2, P20, S1, S5, S7, 52100, A 128, D2, D3, D4, D5, D7	P	28 to 44 Rc	50-125	.0002-.0010	.0010-.0020	.0020-.0040	.0040-.0060	.0060-.0100
Stainless Steel - Free Machining / Austenitic 304/316	M	up to 28 Rc	120-190	.0005-.0020	.0020-.0040	.0040-.0060	.0060-.0100	.0100-.0200
Stainless Steel - Ferritic / Martensitic	M	up to 28 Rc	80-120	.0002-.0020	.0010-.0040	.0020-.0060	.0040-.0100	.0060-.0200
Stainless Steel - Moderately Difficult 301, 302, 303 High Tensile, 304, 304L, 305, 420, 15-5PH, 17-4PH, 17-7PH	M	up to 28 Rc	60-100	.0002-.0020	.0010-.0040	.0020-.0060	.0040-.0100	.0060-.0200
Inconel 625/718	S	≤ 40 Rc	40-70	.0002-.0010	.0010-.0020	.0020-.0040	.0040-.0060	.0060-.0100
Stellite / Cobalt Chrome	S	≤ 40 Rc	30-45	.0002-.0010	.0010-.0020	.0020-.0040	.0040-.0060	.0060-.0100
Titanium 6Al-4V	S	≤ 40 Rc	35-50	.0002-.0020	.0010-.0040	.0020-.0060	.0040-.0100	.0060-.0200
Cast Iron - Gray CG, ASTM A48, CLASS 20, 25, 30, 35, SAE J431C, GRADES G1800, G3000, G3500, GG 10, 15, 20, 25, 30, 35, 40	K	up to 240 HB	150-250	.0002-.0020	.0010-.0040	.0020-.0060	.0040-.0100	.0060-.0200
Cast Iron - Ductile & Malleable CGI 60-40-18, 65-45-12, D4018, D4512, D5506, 32510, 35108, M3210, M4504, M5503, 250, 300, 350, 400, 450	K	over 240 HB	125-200	.0005-.0020	.0020-.0040	.0040-.0060	.0060-.0100	.0100-.0200
Cast Iron - (Martensitic) Hard	K		50-75	.0002-.0010	.0010-.0020	.0020-.0040	.0040-.0060	.0060-.0100
Aluminum/Aluminum Alloys	N		500-1000	.0005-.0030	.0020-.0060	.0040-.0100	.0060-.0150	.0100-.0300
Brass/Bronze Free Machining	N		250-400	.0005-.0020	.0020-.0040	.0040-.0060	.0060-.0100	.0100-.0200
Brass/Bronze (Hard)	N		150-250	.0002-.0010	.0010-.0020	.0020-.0040	.0040-.0060	.0060-.0100
Magnesium/Magnesium Alloys/Plastics/Bakelite Plastic - Glass Filled	N		500-1000	.0005-.0030	.0020-.0060	.0040-.0100	.0060-.0150	.0100-.0300
Copper/Hard Bronze	N		100-150	.0002-.0010	.0010-.0020	.0020-.0040	.0040-.0060	.0060-.0100
Hardened Steels	H	23-32 Rc	125-200	.0005-.0020	.0020-.0040	.0040-.0060	.0060-.0100	.0100-.0200
Hardened Steels	H	32-43 Rc	50-125	.0002-.0010	.0010-.0020	.0020-.0040	.0040-.0060	.0060-.0100
Hardened Steels	H	43-52 Rc	35-50	.0002-.0010	.0010-.0020	.0020-.0040	.0040-.0060	.0060-.0100
Hardened Steels	H	50+ Rc	15-35	.0002-.0010	.0010-.0020	.0020-.0040	.0040-.0060	.0060-.0100

Technical data provided should be considered advisory only as variations may be necessary depending on the particular application.

Reamer Cutting Data - Metric

Workpiece Material Group	I S O	Hardness	vc-m/min	Reamer Diameter (mm)				
				f-mm/rev				
				≥ 1.5	>1.5 - 3.0	>3.0 - 6.0	>6.0 - 12.0	>12.0 - 25.0
Free Machining & Low Carbon Steels 1006, 1008, 1015, 1018, 1020, 1022, 1025, 1117, 1140, 1141, 11L08, 11L14, 1213, 12L13, 12L14, 1215, 1330	P	up to 28 Rc	60-90	.010-.080	.050-.150	.100-.250	.150-.380	.250-.760
Medium Carbon & High Carbon Steels, Alloy Steels & Easy to Machine Tool Steels 1030, 1035, 1040, 1045, 1050, 1052, 1055, 1060, 1085, 1095, 1541, 1551, 9255, 2515, 3135, 3415, 4130, 4137, 4140, 4150, 4320, 4340, 4520, 5015, 5115, 5120, 5132, 5140, 5155, 6150, 8620, 9262, 9840, 52100, O1, O2, O6, S2, W1 to W310	P	28 to 38 Rc	40-60	.010-.050	.050-.100	.100-.150	.150-.250	.250-.510
Tool Steels & Die Steels O7, M1, M2, M3, M4, M7, T1, T2, T4, T5, T8, T15, A2, A3, A6, A7, H10, H11, H12, H13, H19, H21, L3, L6, L7, P2, P20, S1, S5, S7, 52100, A 128, D2, D3, D4, D5, D7	P	28 to 44 Rc	15-40	.010-.030	.030-.050	.050-.100	.100-.150	.150-.250
Stainless Steel - Free Machining / Austenitic 304/316	M	up to 28 Rc	35-60	.010-.050	.050-.100	.100-.150	.150-.250	.250-.500
Stainless Steel - Ferritic / Martensitic	M	up to 28 Rc	25-35					
Stainless Steel - Moderately Difficult 301, 302, 303 High Tensile, 304, 304L, 305, 420, 15-5PH, 17-4PH, 17-7PH	M	up to 28 Rc	20-30	.010-.050	.030-.100	.050-.150	.100-.250	.150-.500
Inconel 625/718	S	≤ 40 Rc	15-20	.010-.030	.030-.050	.050-.100	.100-.150	.150-.250
Stellite / Cobalt Chrome	S	≤ 40 Rc	10-15					
Titanium 6Al-4V	S	≤ 40 Rc	10-15	.010-.050	.030-.100	.050-.150	.100-.250	.150-.500
Cast Iron - Gray CG, ASTM A48, CLASS 20, 25, 30, 35, SAE J431C, GRADES G1800, G3000, G3500, GG 10, 15, 20, 25, 30, 35, 40	K	up to 240 HB	45-75	.010-.050	.030-.100	.050-.150	.100-.250	.150-.500
Cast Iron - Ductile & Malleable CGI 60-40-18, 65-45-12, D4018, D4512, D5506, 32510, 35108, M3210, M4504, M5503, 250, 300, 350, 400, 450	K	over 240 HB	40-60	.010-.050	.050-.100	.100-.150	.150-.250	.250-.500
Cast Iron - (Martensitic) Hard	K		15-25	.010-.030	.030-.050	.050-.100	.100-.150	.150-.250
Aluminum/Aluminum Alloys	N		150-300	.010-.080	.050-.150	.100-.250	.150-.380	.250-.760
Brass/Bronze Free Machining	N		75-120	.010-.050	.050-.100	.100-.150	.150-.250	.250-.500
Brass/Bronze (Hard)	N		45-75					
Magnesium/Magnesium Alloys/Plastics/Bakelite Plastic - Glass Filled	N		150-300	.010-.080	.050-.150	.100-.250	.150-.380	.250-.760
Copper/Hard Bronze	N		30-45	.010-.030	.030-.050	.050-.100	.100-.150	.150-.250
Hardened Steels	H	23-32 Rc	40-60	.010-.050	.050-.100	.100-.150	.150-.250	.250-.500
Hardened Steels	H	32-43 Rc	15-40					
Hardened Steels	H	43-52 Rc	10-15	.010-.030	.030-.050	.050-.100	.100-.150	.150-.250
Hardened Steels	H	50+ Rc	5-10	.010-.030	.030-.050	.050-.100	.100-.150	.150-.250

Technical data provided should be considered advisory only as variations may be necessary depending on the particular application.

Countersinks

Uniflute® Series 60
 Uniflute® Series 61
 Uniflute® Series 61B
 Uniflute® Series 61T
 Uniflute® Series 64 (61 Sets)
 Unicam Series 65
 Zero Flute Series 67
 Six Flute Series 78
 Six Flute Series 79
 Six Flute Series 79B
 Six Flute Series 79T
 Six Flute Series 79 Sets
 Three Flute Aircraft Series 92/92 Sets
 Single Flute Series 880 60°
 Single Flute Series 882 82°
 Single Flute Series 883 90°
 Three Flute Series 890 60°



Three Flute Series 892 82°
 Three Flute Series 893 90°
 Micro-Stop Series 83
 Micro-Stop Series 84
 Micro-Stop Series 86
 Micro-Stop Series 87
 Countersink Pilot Series 850
 Countersink Pilot Series 851
 Non-Marking Pads
 Micro-Stop Fixtures Series 80
 Application Data

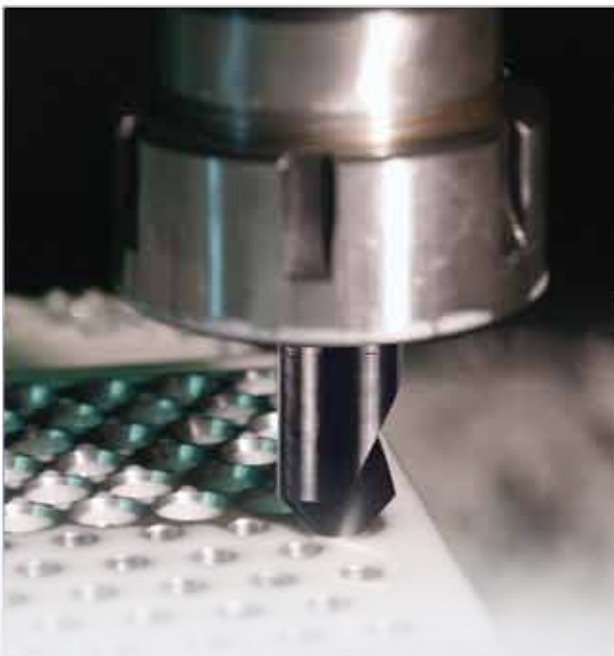

Made in USA



ISO 9001:2008 Certified

*Where **high performance** is the **standard**®*

The Original Countersink from M.A. Ford®

For Machine or Hand Countersinking

M.A. Ford® provides one of the most complete lines of high-speed steel and carbide countersinks. Tools are available in a variety of flute designs for countersinking virtually any material by machine or by hand.

Heat Treated Countersinks Deliver Increased Productivity and Tool Life

All M.A. Ford® HSS countersinks are heat treated in an electronically controlled vacuum furnace. This assures precise hardening and eliminates the possibility of decarburization. All heat treating is done in our own facilities for maximum control and assurance of desired hardness and toughness.

Most M.A. Ford® HSS countersinks receive an additional heat treat process known as the Steam Homogeneous Process. This process is like a final tempering, relieving internal grinding stresses. The result is a much tougher cutting edge that stays sharper, longer. Additionally, the Steam Homogeneous Process provides a tough, hard, porous oxide film on the tool that is sufficient enough to retain cutting oil, further reducing frictional heat and extending tool life.



Coated Countersinks



ALtima® Blaze

See pages 410 & 415.



TiN coating

See pages 411, 412, 416, 417, 419 & 420.

Coating Properties

	TiN	ALtima® Blaze
Micro Hardness (HV)	2300	3200
Max. Working Temperature	600° C 1112° F	1100° C 2012° F
Friction Coefficient	0.40	0.35

ALtima® Blaze

features high temperature hardness and oxidation resistance that provides extreme wear resistance under all machining conditions.

TiN

provides a higher surface hardness and increased lubricity over an uncoated tool.

Uniflute® Series 60

C	Z1	60° 82° 90° 100°	
---	----	---------------------------	--

Recommended for use on abrasive, non-metallic and non-ferrous materials.

- Easily resharpened.
- Can be used on hardened steel and work hardening alloys.
- Rigid set-ups and good machinery maintenance are a must.
- Not recommended for use in handheld tools.

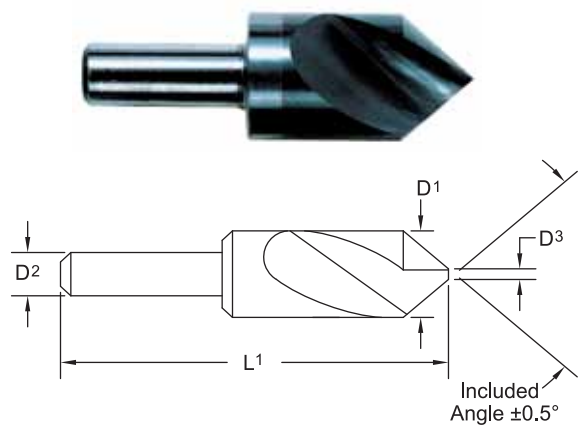

60°		82°		90°		100°		Diameter	Shank	Non-Cutting OD	OAL
Tool No.	EDP	Tool No.	EDP	Tool No.	EDP	Tool No.	EDP	D1	D2	D3 Max.	L1
60012501	60001	60012502	60006	60012503	60011	60012504	60016	1/8	1/8	.030*	1-1/2
60018701	60021	60018702	60026	60018703	60031	60018704	60036	3/16	3/16	.045	1-1/2
60025001	60041	60025002	60046	60025003	60051	60025004	60056	1/4	1/4	.045	2
60037501	60061	60037502	60066	60037503	60071	60037504	60076	3/8	1/4	.060	2
60050001	60081	60050002	60086	60050003	60091	60050004	60096	1/2	1/4	.060	2-3/8
60075001	60101	60075002	60106	60075003	60111	60075004	60116	3/4	1/2	.120	3
60100001	60121	60100002	60126	60100003	60131	60100004	60136	1	1/2	.120	3

*60° - .015 max.
Standard angles may be modified from 55° to 99°.

HSS Uniflute® Series 61

HSS	Z1	60° 82° 90° 100° 120°	
-----	----	-----------------------------------	--

This is the original single flute countersink designed for general purpose countersinking, chamfering or deburring.

- Self piloting and completely chatterless.
- No secondary burrs formed.
- Each size may be used on a wide range of hole diameters.
- Use on machine tool or in handheld tool applications.
- Easily resharpened.
- Steam homogeneous surface treatment (blackening) to prolong tool life and prevent galling.

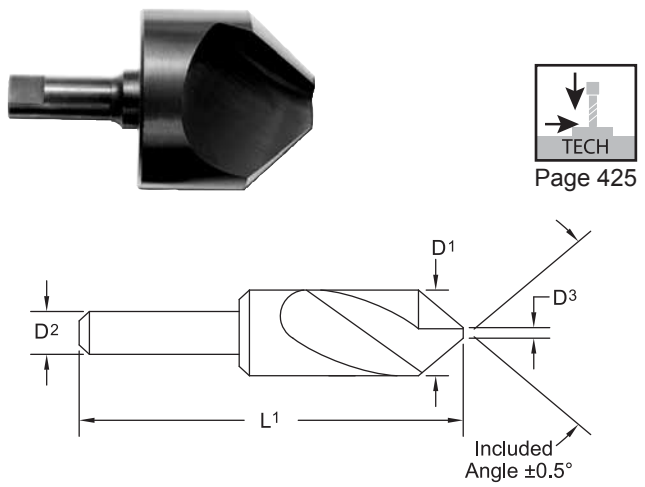

TECH
Page 425

60°		82°		90°		100°		120°		Dia.	Shank	Non-Cutting OD	OAL
Tool No.	EDP	Tool No.	EDP	Tool No.	EDP	Tool No.	EDP	Tool No.	EDP	D1	D2	D3 Max.	L1
61012501	61001	61012502	61006	61012503	61011	61012504	61016	61012506	61021	1/8	1/8	.030	1-1/2
61018701	61026	61018702	61031	61018703	61036	61018704	61041	61018706	61046	3/16	3/16	.045	1-1/2
61025001	61051	61025002	61056	61025003	61061	61025004	61066	61025006	61071	1/4	1/4	.045	2
61037501	61076	61037502	61081	61037503	61086	61037504	61091	61037506	61096	3/8	1/4	.060	2
61050001	61101	61050002	61106	61050003	61111	61050004	61116	61050006	61121	1/2	1/4	.060	2
61062501	61126	61062502	61131	61062503	61136	61062504	61141	61062506	61146	5/8	1/4	.060	2-1/4
61075001	61151	61075002	61156	61075003	61161	61075004	61166	61075006	61171	3/4	1/2	.120	2-3/4
61100001	61176	61100002	61181	61100003	61186	61100004	61191	61100006	61196	1	1/2	.120	2-3/4
61125001	61201	61125002	61206	61125003	61211					1-1/4	1/2*	.120	3
61150001	61216	61150002	61221	61150003	61226					1-1/2	3/4*	.250	3-1/2
61200001	61231	61200002	61236	61200003	61241					2	3/4*	.500	3-3/4
61250001	61246	61250002	61251	61250003	61256					2-1/2	3/4*	.750	5
61300001	61261	61300002	61266	61300003	61271					3	3/4*	1.000	5-1/4

*Straight shank with tang drive.
Standard angles may be modified from 55° to 119°.

For product information, call your local distributor.

HSS Uniflute® Series 61B

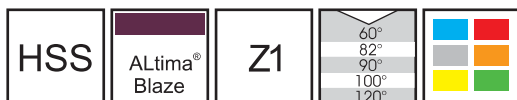

This is the original single flute countersink designed for general purpose countersinking, chamfering or deburring.

- Self piloting and completely chatterless.
- No secondary burs formed.
- Each size may be used on a wide range of hole diameters.
- Use on machine tool or in handheld tool applications.
- Easily sharpened.
- ALtima® Blaze for extreme wear resistance under all machining conditions.

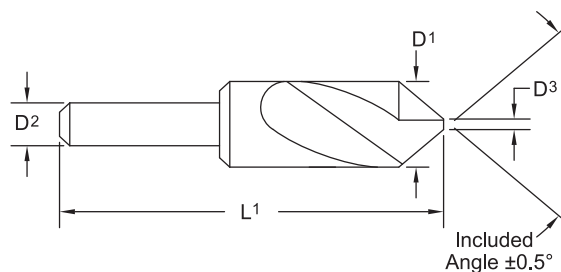

60°		82°		90°		Diameter	Shank	Non-Cutting OD	OAL
Tool No.	EDP	Tool No.	EDP	Tool No.	EDP	D1	D2	D3 Max.	L1
61B012501	61003	61B012502	61008	61B012503	61013	1/8	1/8	.030	1-1/2
61B018701	61028	61B018702	61033	61B018703	61038	3/16	3/16	.045	1-1/2
61B025001	61053	61B025002	61058	61B025003	61063	1/4	1/4	.045	2
61B037501	61078	61B037502	61083	61B037503	61088	3/8	1/4	.060	2
61B050001	61103	61B050002	61108	61B050003	61113	1/2	1/4	.060	2
61B062501	61128	61B062502	61133	61B062503	61138	5/8	1/4	.060	2-1/4
61B075001	61153	61B075002	61158	61B075003	61163	3/4	1/2	.120	2-3/4
61B100001	61178	61B100002	61183	61B100003	61188	1	1/2	.120	2-3/4

100°		120°		Diameter	Shank	Non-Cutting OD	OAL
Tool No.	EDP	Tool No.	EDP	D1	D2	D3 Max.	L1
61B012504	61018	61B012506	61023	1/8	1/8	.030	1-1/2
61B018704	61043	61B018706	61048	3/16	3/16	.045	1-1/2
61B025004	61068	61B025006	61073	1/4	1/4	.045	2
61B037504	61093	61B037506	61098	3/8	1/4	.060	2
61B050004	61118	61B050006	61123	1/2	1/4	.060	2
61B062504	61143	61B062506	61148	5/8	1/4	.060	2-1/4
61B075004	61168	61B075006	61173	3/4	1/2	.120	2-3/4
61B100004	61193	61B100006	61198	1	1/2	.120	2-3/4

Angles modified from 55° to 119° available as a special. Contact customer service for details.

Coating Properties		
	TiN	ALtima® Blaze
Micro Hardness (HV)	2300	3200
Max. Working Temperature	600° C 1112° F	1100° C 2012° F
Friction Coefficient	0.40	0.35



HSS Uniflute® Series 61T

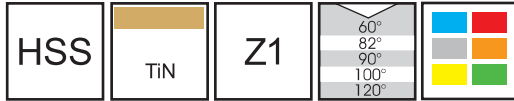

This is the original single flute countersink designed for general purpose countersinking, chamfering or deburring.

- Self piloting and completely chatterless.
- No secondary burrs formed.
- Each size may be used on a wide range of hole diameters.
- Use on machine tool or in handheld tool applications.
- Easily resharpened.
- TiN coating for higher surface hardness and increased lubricity.

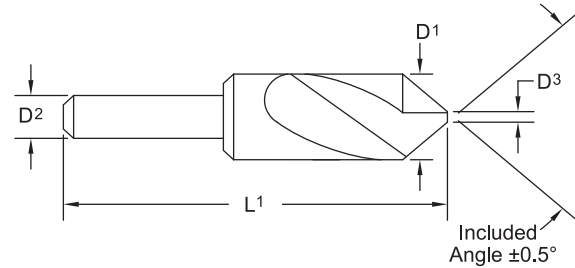

60°		82°		90°		Diameter	Shank	Non-Cutting OD	OAL
Tool No.	EDP	Tool No.	EDP	Tool No.	EDP	D1	D2	D3 Max.	L1
61T012501	61002	61T012502	61007	61T012503	61012	1/8	1/8	.030	1-1/2
61T018701	61027	61T018702	61032	61T018703	61037	3/16	3/16	.045	1-1/2
61T025001	61052	61T025002	61057	61T025003	61062	1/4	1/4	.045	2
61T037501	61077	61T037502	61082	61T037503	61087	3/8	1/4	.060	2
61T050001	61102	61T050002	61107	61T050003	61112	1/2	1/4	.060	2
61T062501	61127	61T062502	61132	61T062503	61137	5/8	1/4	.060	2-1/4
61T075001	61152	61T075002	61157	61T075003	61162	3/4	1/2	.120	2-3/4
61T100001	61177	61T100002	61182	61T100003	61187	1	1/2	.120	2-3/4

100°		120°		Diameter	Shank	Non-Cutting OD	OAL
Tool No.	EDP	Tool No.	EDP	D1	D2	D3 Max.	L1
61T012504	61017	61T012506	61022	1/8	1/8	.030	1-1/2
61T018704	61042	61T018706	61047	3/16	3/16	.045	1-1/2
61T025004	61067	61T025006	61072	1/4	1/4	.045	2
61T037504	61092	61T037506	61097	3/8	1/4	.060	2
61T050004	61117	61T050006	61122	1/2	1/4	.060	2
61T062504	61142	61T062506	61147	5/8	1/4	.060	2-1/4
61T075004	61167	61T075006	61172	3/4	1/2	.120	2-3/4
61T100004	61192	61T100006	61197	1	1/2	.120	2-3/4

Modified angles from 55° to 119° available as a special. Contact customer service for details.



Page 425

ISO 9001:2008 Certified

Uniflute® Series 64 Sets



Set of four Series 61 Uniflute® countersinks includes 1/4", 1/2", 3/4" and 1" diameter tools. Sets are available with 60°, 82°, 90°, 100° or 120° included angles. TiN coated sets available. Tools are packaged in plastic cases.

Set of seven Series 61 Uniflute® countersinks includes 3/16", 1/4", 3/8", 1/2", 5/8", 3/4" and 1" diameter tools. Sets are available with 60°, 82°, 90°, 100° or 120° included angles. Tools are packaged in plastic cases.

4 Piece Set No.	EDP	Included Angle
64100001	64001	60°
64100002	64006	82°
64100003	64011	90°
64100004	64016	100°
64100006	64021	120°

7 Piece Set No.	EDP	Included Angle
64100071	64003	60°
64100072	64008	82°
64100073	64013	90°
64100074	64018	100°
64100076	64023	120°

TiN 4 Piece Set No.	EDP	Included Angle
64T100001	64025	60°
64T100002	64027	82°
64T100003	64029	90°



Page 425

Unicam Series 65

Resharpener Fixture

The Unicam Resharpener Fixture is no longer available. Please contact customer service if you have any questions regarding this product.



Zero Flute Series 67

HSS

Z0

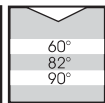

Designed for general purpose countersinking, chamfering or deburring.

- Efficient stock removal, chatter-free finish.
- 3/16" and 1/4" tools are double ended.
- Bright finish helps reduce chip build-up on cutting edge.

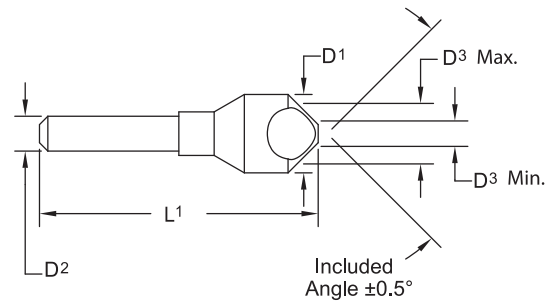

60°		82°		90°		Diameter		Shank		Non-Cutting OD		OAL
Tool No.	EDP	Tool No.	EDP	Tool No.	EDP	D1	D2	D3 Min.**	D3 Max.	L1		
67018701	67001	67018702	67006	67018703	67011	3/16	3/16	.06	.17	1-1/2		
67025001	67016	67025002	67021	67025003	67026	1/4	1/4	.09	.23	2		
67043701	67031	67043702	67036	67043703	67041	7/16	1/4	.15	.40	2		
67056201	67046	67056202	67051	67056203	67056	9/16	1/4	.19	.53	2		
67081201	67061	67081202	67066	67081203	67071	13/16	1/2	.25	.78	2-5/8		
67112501	67076	67112502	67081	67112503	67086	1-1/8	1/2	.44	1.03	2-7/8		
67150001	67091	67150002	67096	67150003	67101	1-1/2	1/2	.50	1.46	3-1/2		

**15% to 30% greater for 60° countersinks only.

Chatterless Six Flute Series 78

C

Z6

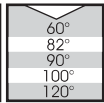

Solid Carbide construction (steel shanks on tools 3/8" diameter and larger) makes this countersink ideal for hardened steel, high temperature alloys and other tough jobs.

- Rigid set-ups and good machine tool maintenance are a must.
- Not recommended for handheld applications.

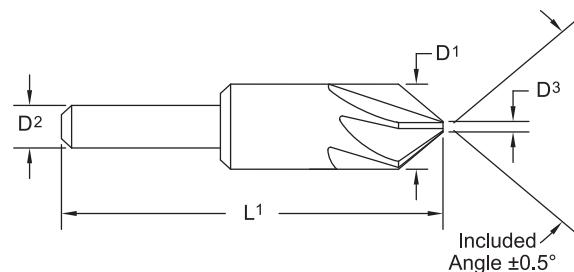

60°		82°		90°		100°		120°		Dia.	Shank	Non-Cutting OD	OAL
Tool No.	EDP	Tool No.	EDP	Tool No.	EDP	Tool No.	EDP	Tool No.	EDP	D1	D2	D3 Max.	L1
78012501	78001	78012502	78006	78012503	78011	78012504	78016	78012506	78021	1/8	1/8	0.03	1-1/2
78018701	78026	78018702	78031	78018703	78036	78018704	78041	78018706	78046	3/16	3/16	0.04	1-1/2
78025001	78051	78025002	78056	78025003	78061	78025004	78066	78025006	78071	1/4	1/4	0.06	2
78037501	78076	78037502	78081	78037503	78086	78037504	78091	78037506	78096	3/8	1/4	0.09	2
78050001	78101	78050002	78106	78050003	78111	78050004	78116	78050006	78121	1/2	3/8	0.15	2-1/4
78062501	78126	78062502	78131	78062503	78136	78062504	78141	78062506	78146	5/8	3/8	0.18	2-3/8
78075001	78151	78075002	78156	78075003	78161	78075004	78166	78075006	78171	3/4	1/2	0.21	2-3/4
78100001	78176	78100002	78181	78100003	78186	78100004	78191	78100006	78196	1	1/2	0.25	2-3/4
78125001	78201	78125002	78206	78125003	78211					1-1/4	1/2*	0.37	3
78150001	78216	78150002	78221	78150003	78226					1-1/2	3/4*	0.43	3-1/2

*Straight shank with tang drive.



Chatterless Six Flute Series 79

HSS	Z6	60° 82° 90° 100° 120°	
-----	----	-----------------------------------	--



Standard six flute countersinks are designed for economical, general purpose countersinking, chamfering or deburring. Because of the multiple flute design, chip loads are generally smaller. Even at maximum speeds, chatter-free machining is possible. Steam homogeneous surface treatment (blackening) is used to prolong tool life and prevent galling.

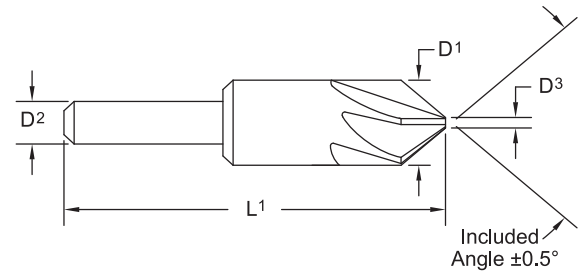

60°		82°		90°		Diameter	Shank	Non-Cutting OD	OAL
Tool No.	EDP	Tool No.	EDP	Tool No.	EDP	D1	D2	D3 Max.	L1
79012501	79021	79012502	79026	79012503	79031	1/8	1/8	0.03	1-1/2
79018701	79046	79018702	79051	79018703	79056	3/16	3/16	0.04	1-1/2
79025001	79071	79025002	79076	79025003	79081	1/4	1/4	0.06	2
79031201	79096	79031202	79101	79031203	79106	5/16	1/4	0.08	2
79037501	79121	79037502	79126	79037503	79131	3/8	1/4	0.09	2
79050001	79146	79050002	79151	79050003	79156	1/2	3/8	0.15	2
79062501	79171	79062502	79176	79062503	79181	5/8	3/8	0.18	2-1/4
79075001	79196	79075002	79201	79075003	79206	3/4	1/2	0.21	2-3/4
79087501	79221	79087502	79226	79087503	79231	7/8	1/2	0.23	2-3/4
79100001	79246	79100002	79251	79100003	79256	1	1/2	0.25	2-3/4
79125001	79271	79125002	79276	79125003	79281	1-1/4	1/2**	0.37	3
79150001	79296	79150002	79301	79150003	79306	1-1/2	3/4**	0.43	3-1/2
79200001	79321	79200002	79326	79200003	79331	2	3/4**	0.62	3-3/4
79250001	79346	79250002	79351	79250003	79356	2-1/2	3/4**	0.75	5
79300001	79361	79300002	79366	79300003	79371	3	3/4**	1	5-1/4

100°		120°		Diameter	Shank	Non-Cutting OD	OAL
Tool No.	EDP	Tool No.	EDP	D1	D2	D3 Max.	L1
79012504	79036	79012506	79041	1/8	1/8	0.03	1-1/2
79018704	79061	79018706	79066	3/16	3/16	0.04	1-1/2
79025004	79086	79025006	79091	1/4	1/4	0.06	2
79031204	79111	79031206	79116	5/16	1/4	0.08	2
79037504	79136	79037506	79141	3/8	1/4	0.09	2
79050004	79161	79050006	79166	1/2	3/8	0.15	2
79062504	79186	79062506	79191	5/8	3/8	0.18	2-1/4
79075004	79211	79075006	79216	3/4	1/2	0.21	2-3/4
79087504	79236	79087506	79241	7/8	1/2	0.23	2-3/4
79100004	79261	79100006	79266	1	1/2	0.25	2-3/4
79125004	79286	79125006	79291	1-1/4	1/2**	0.37	3
79150004	79311	79150006	79316	1-1/2	3/4**	0.43	3-1/2
79200004	79336	79200006	79341	2	3/4**	0.62	3-3/4

**Straight shank with tang drive.



Chatterless Six Flute Series 79B

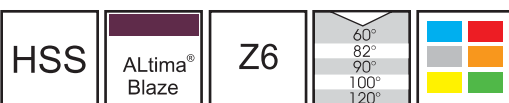

Standard six flute countersinks are designed for economical, general purpose countersinking, chamfering or deburring. Because of the multiple flute design, chip loads are generally smaller. Even at maximum speeds, chatter-free machining is possible.

ALtima® Blaze for extreme wear resistance under all machining conditions.

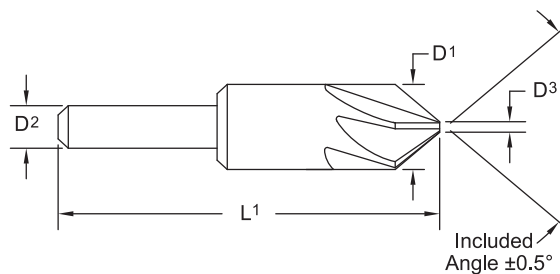

79 / 79B
Countersinks

60°		82°		90°		Diameter	Shank	Non-Cutting OD	OAL
Tool No.	EDP	Tool No.	EDP	Tool No.	EDP	D1	D2	D3 Max.	L1
79B012501	79023	79B012502	79028	79B012503	79033	1/8	1/8	0.03	1-1/2
79B018701	79048	79B018702	79053	79B018703	79058	3/16	3/16	0.04	1-1/2
79B025001	79073	79B025002	79078	79B025003	79083	1/4	1/4	0.06	2
79B037501	79123	79B037502	79128	79B037503	79133	3/8	1/4	0.09	2
79B050001	79148	79B050002	79153	79B050003	79158	1/2	3/8	0.15	2
79B062501	79173	79B062502	79178	79B062503	79183	5/8	3/8	0.18	2-1/4
79B075001	79198	79B075002	79203	79B075003	79208	3/4	1/2	0.21	2-3/4
79B100001	79248	79B100002	79253	79B100003	79258	1	1/2	0.25	2-3/4

100°		120°		Diameter	Shank	Non-Cutting OD	OAL
Tool No.	EDP	Tool No.	EDP	D1	D2	D3 Max.	L1
79B012504	79039	79B012506	79043	1/8	1/8	0.03	1-1/2
79B018704	79064	79B018706	79068	3/16	3/16	0.04	1-1/2
79B025004	79089	79B025006	79093	1/4	1/4	0.06	2
79B037504	79139	79B037506	79143	3/8	1/4	0.09	2
79B050004	79164	79B050006	79168	1/2	3/8	0.15	2
79B062504	79189	79B062506	79193	5/8	3/8	0.18	2-1/4
79B075004	79214	79B075006	79218	3/4	1/2	0.21	2-3/4
79B100004	79264	79B100006	79268	1	1/2	0.25	2-3/4

Coating Properties		
	TiN	ALtima® Blaze
Micro Hardness (HV)	2300	3200
Max. Working Temperature	600° C 1112° F	1100° C 2012° F
Friction Coefficient	0.40	0.35



Chatterless Six Flute Series 79T

HSS	TiN	Z6	60° 82° 90° 100° 120°	
-----	-----	----	-----------------------------------	--



Standard six flute countersinks are designed for economical, general purpose countersinking, chamfering or deburring. Because of the multiple flute design, chip loads are generally smaller. Even at maximum speeds, chatter-free machining is possible.

TiN coating for higher surface hardness and increased lubricity.

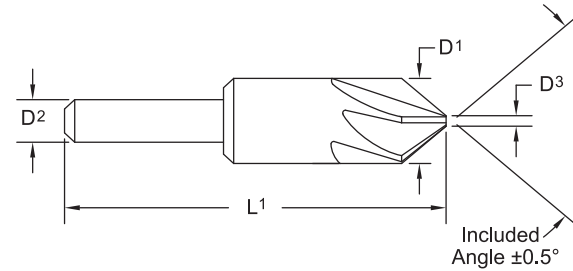

60°		82°		90°		Diameter	Shank	Non-Cutting OD	OAL
Tool No.	EDP	Tool No.	EDP	Tool No.	EDP	D1	D2	D3 Max.	L1
79T012501	79022	79T012502	79027	79T012503	79032	1/8	1/8	0.03	1-1/2
79T018701	79047	79T018702	79052	79T018703	79057	3/16	3/16	0.04	1-1/2
79T025001	79072	79T025002	79077	79T025003	79082	1/4	1/4	0.06	2
79T037501	79122	79T037502	79127	79T037503	79132	3/8	1/4	0.09	2
79T050001	79147	79T050002	79152	79T050003	79157	1/2	3/8	0.15	2
79T062501	79172	79T062502	79177	79T062503	79182	5/8	3/8	0.18	2-1/4
79T075001	79197	79T075002	79202	79T075003	79207	3/4	1/2	0.21	2-3/4
79T100001	79247	79T100002	79252	79T100003	79257	1	1/2	0.25	2-3/4

100°		120°		Diameter	Shank	Non-Cutting OD	OAL
Tool No.	EDP	Tool No.	EDP	D1	D2	D3 Max.	L1
79T012504	79037	79T012506	79042	1/8	1/8	0.03	1-1/2
79T018704	79062	79T018706	79067	3/16	3/16	0.04	1-1/2
79T025004	79087	79T025006	79092	1/4	1/4	0.06	2
79T037504	79137	79T037506	79142	3/8	1/4	0.09	2
79T050004	79162	79T050006	79167	1/2	3/8	0.15	2
79T062504	79187	79T062506	79192	5/8	3/8	0.18	2-1/4
79T075004	79212	79T075006	79217	3/4	1/2	0.21	2-3/4
79T100004	79262	79T100006	79267	1	1/2	0.25	2-3/4



Factory Regrinding Service Available.
 Call Customer Service for Details.
 800-553-8024 / 563-391-6220

Chatterless Six Flute Series 79 Sets

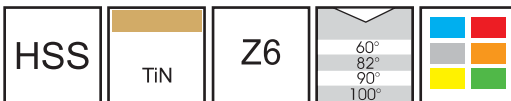

Set of four Series 79 countersinks includes 1/4", 1/2", 3/4" and 1" diameter tools. Sets are available with 60°, 82°, 90°, or 100° included angles. Tools are packaged in plastic cases. TiN coated sets available.

Set of seven Series 79 countersinks includes 1/4", 5/16", 3/8", 1/2", 5/8", 3/4" and 1" diameter tools. Sets are available with 60°, 82°, 90°, or 100° included angles. Tools are packaged in plastic cases.

4 Piece Set No.	EDP	Included Angle
79000011	79003	60°
79000012	79008	82°
79000013	79013	90°
79000014	79019	100°

7 Piece Set No.	EDP	Included Angle
79000001	79001	60°
79000002	79006	82°
79000003	79011	90°
79000004	79016	100°

TiN 4 Piece Set No.	EDP	Included Angle
79T000011	79380	60°
79T000012	79382	82°
79T000013	79384	90°



Page 425



Made in USA



ISO 9001:2008 Certified

Aircraft Series 92

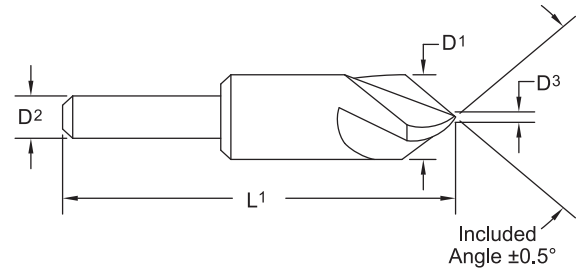

Designed for countersinking, chamfering and deburring aircraft type metals.

- Bright finish helps reduce chip build-up on the cutting edge.
- Spiral flute geometry for a clean, chatterless finish.
- Each size may be used on a wide range of hole diameters.

60°		82°		90°		Diameter	Shank	Non-Cutting OD	OAL
Tool No.	EDP	Tool No.	EDP	Tool No.	EDP	D1	D2	D3 Max.	L1
92025001	94101	92025002	94103	92025003	94105	1/4	1/4	0.07	1-1/4
92037501	94113	92037502	94115	92037503	94117	3/8	1/4	0.11	1-5/8
92050001	94125	92050002	94127	92050003	94129	1/2	1/4	0.15	2
92062501	94137	92062502	94139	92062503	94141	5/8	1/4	0.19	2-1/4
92075001	94149	92075002	94151	92075003	94153	3/4	1/2	0.23	3
92087501	94161	92087502	94163	92087503	94165	7/8	1/2	0.26	3
92100001	94173	92100002	94175	92100003	94177	1	1/2	0.30	3-1/4
92112501	94185	92112502	94187	92112503	94189	1-1/8	1/2	0.34	3-1/4
92125001	94197	92125002	94199	92125003	94201	1-1/4	5/8	0.38	3-1/2
92150001	94209	92150002	94211	92150003	94213	1-1/2	3/4	0.45	3-7/8
92200001	94221	92200002	94223	92200003	94225	2	3/4	0.60	4-1/4

100°		120°		Diameter	Shank	Non-Cutting OD	OAL
Tool No.	EDP	Tool No.	EDP	D1	D2	D3 Max.	L1
92025004	94107	92025006	94111	1/4	1/4	0.07	1-1/4
92037504	94119	92037506	94123	3/8	1/4	0.11	1-5/8
92050004	94131	92050006	94135	1/2	1/4	0.15	2
92062504	94143	92062506	94147	5/8	1/4	0.19	2-1/4
92075004	94155	92075006	94159	3/4	1/2	0.23	3
92087504	94167	92087506	94171	7/8	1/2	0.26	3
92100004	94179	92100006	94183	1	1/2	0.30	3-1/4
92112504	94191	92112506	94195	1-1/8	1/2	0.34	3-1/4
92125004	94203	92125006	94207	1-1/4	5/8	0.38	3-1/2
92150004	94215	92150006	94219	1-1/2	3/4	0.45	3-7/8
92200004	94227	92200006	94231	2	3/4	0.60	4-1/4

Standard angles maybe modified from 55° to 119°.



Aircraft Series 92 Sets

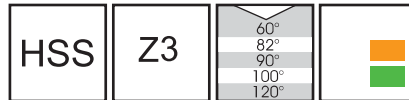

Set of five Series 92 countersinks include 1/4", 3/8", 1/2", 5/8" and 3/4" diameter tools. Sets are available with 60°, 82°, 90°, 100° or 120° included angles. Tools are packaged in plastic cases.

5 Piece Set No.	EDP	Included Angle
92000011	96380	60°
92000012	96381	82°
92000013	96382	90°
92000014	96383	100°
92000016	96385	120°



Single Flute Series 880 / 882 / 883



Single flute countersink designed for general purpose countersinking, chamfering or deburring. Metric Sizes.

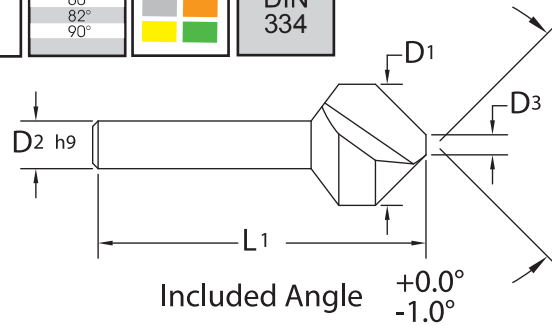

60° Included Angle

Uncoated		TiN		Diameter D1	Shank Dia. h9 D2	Non-Cutting OD Max. D3	OAL L1	Fastner Size
Tool No.	EDP	Tool No.	EDP					
88000630	88007	88000630T	88008	6.3	5	1.6	45	M3
88000800	88011	88000800T	88012	8.0	6	2.0	50	M4
88001250	88025	88001250T	88026	12.5	8	3.2	56	M6
88001600	88029	88001600T	88020	16.0	10	4.0	63	M8
88002000	88037	88002000T	88038	20.0	10	5.0	67	M10
88002500	88045	88002500T	88046	25.0	10	6.3	71	M12

- Self piloting and completely chatterless.
- No secondary burs formed.
- Each size may be used on a wide range of hole diameters.
- Use on a machine tool or in handheld tool applications.
- Bright finish helps reduce chip build-up on cutting edge.

82° Included Angle

Uncoated		TiN		Diameter D1	Shank Dia. h9 D2	Non-Cutting OD Max. D3	OAL L1	Fastner Size
Tool No.	EDP	Tool No.	EDP					
88200630	88207	88200630T	88208	6.3	5	1.5	45	M3
88200830	88213	88200830T	88214	8.3	6	2.0	50	M4
88201040	88219	88201040T	88220	10.4	6	2.5	50	M5
88201240	88223	88201240T	88224	12.4	8	2.8	56	M6
88201650	88233	88201650T	88234	16.5	10	3.2	60	M8
88202050	88239	88202050T	88240	20.5	10	3.5	63	M10
88202500	88243	88202500T	88244	25.0	10	3.8	67	M12

90° Included Angle

Uncoated		TiN		Diameter D1	Shank Dia. h9 D2	Non-Cutting OD Max. D3	OAL L1	Fastner Size
Tool No.	EDP	Tool No.	EDP					
88300430	88301	88300430T	88302	4.3	4	1.3	40	M2
88300500	88303	88300500T	88304	5.0	4	1.5	40	M2.5
88300600	88305	88300600T	88306	6.0	5	1.5	45	M3
88300630	88307	88300630T	88308	6.3	5	1.5	45	M3
88300700	88309	88300700T	88310	7.0	6	1.8	50	M3.5
88300800	88311	88300800T	88312	8.0	6	2.0	50	M4
88300830	88313	88300830T	88314	8.3	6	2.0	50	M4
88301000	88315	88301000T	88316	10.0	6	2.5	50	M5
88301040	88319	88301040T	88320	10.4	6	2.5	50	M5
88301150	88321	88301150T	88322	11.5	8	2.8	56	M6
88301240	88323	88301240T	88324	12.4	8	2.8	56	M6
88301500	88327	88301500T	88328	15.0	10	3.2	60	M8
88301650	88333	88301650T	88334	16.5	10	3.2	60	M8
88301900	88335	88301900T	88336	19.0	10	3.5	63	M10
88302050	88339	88302050T	88340	20.5	10	3.5	63	M10
88302300	88341	88302300T	88342	23.0	10	3.8	67	M12
88302500	88343	88302500T	88344	25.0	10	3.8	67	M12
88303100	88353	88303100T	88354	31.0	12	4.2	71	M16



Three Flute Series 890 / 892 / 893

HSS

TiN

Z3

60°
82°
90°

60°
DIN
334

90°
DIN
335

Designed for general purpose machining at greater feed rates than are possible with the single flute design. Metric Sizes.

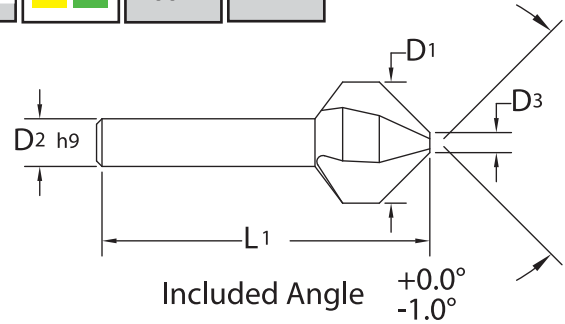

60° Included Angle

Uncoated		TiN		Diameter	Shank Dia. h9	Non-Cutting OD	OAL	Fastner Size
Tool No.	EDP	Tool No.	EDP	D1	D2	Max. D3	L1	
89000630	89007	89000630T	89008	6.3	5	1.6	45	M3
89000800	89011	89000800T	89012	8.0	6	2.0	50	M4
89001250	89025	89001250T	89026	12.5	8	3.2	56	M6
89001600	89029	89001600T	89020	16.0	10	4.0	63	M8
89002000	89037	89002000T	89038	20.0	10	5.0	67	M10
89002500	89045	89002500T	89046	25.0	10	6.3	71	M12

- Cam relief geometry for machining at greater feed rates.
- Bright finish helps reduce chip build-up on cutting edge.

82° Included Angle

Uncoated		TiN		Diameter	Shank Dia. h9	Non-Cutting OD	OAL	Fastner Size
Tool No.	EDP	Tool No.	EDP	D1	D2	Max. D3	L1	
89200630	89207	89200630T	89208	6.3	5	1.5	45	M3
89200830	89213	89200830T	89214	8.3	6	2.0	50	M4
89201040	89219	89201040T	89220	10.4	6	2.5	50	M5
89201240	89223	89201240T	89224	12.4	8	2.8	56	M6
89201650	89233	89201650T	89234	16.5	10	3.2	60	M8
89202050	89239	89202050T	89240	20.5	10	3.5	63	M10
89202500	89243	89202500T	89244	25.0	10	3.8	67	M12

90° Included Angle

Uncoated		TiN		Diameter	Shank Dia. h9	Non-Cutting OD	OAL	Fastner Size
Tool No.	EDP	Tool No.	EDP	D1	D2	Max. D3	L1	
89300430	89301	89300430T	89302	4.3	4	1.3	40	M2
89300500	89303	89300500T	89304	5.0	4	1.5	40	M2.5
89300600	89305	89300600T	89306	6.0	5	1.5	45	M3
89300630	89307	89300630T	89308	6.3	5	1.5	45	M3
89300700	89309	89300700T	89310	7.0	6	1.8	50	M3.5
89300800	89311	89300800T	89312	8.0	6	2.0	50	M4
89300830	89313	89300830T	89314	8.3	6	2.0	50	M4
89301000	89315	89301000T	88316	10.0	6	2.5	50	M5
89301040	89319	89301040T	89320	10.4	6	2.5	50	M5
89301150	89321	89301150T	89322	11.5	8	2.8	56	M6
89301240	89323	89301240T	89324	12.4	8	2.8	56	M6
89301500	89327	89301500T	89328	15.0	10	3.2	60	M8
89301650	89333	89301650T	89334	16.5	10	3.2	60	M8
89301900	89335	89301900T	89336	19.0	10	3.5	63	M10
89302050	89339	89302050T	89340	20.5	10	3.5	63	M10
89302300	89341	89302300T	89342	23.0	10	3.8	67	M12
89302500	89343	89302500T	89344	25.0	10	3.8	67	M12
89303100	89353	89303100T	89354	31.0	12	4.2	71	M16



Micro-Stop Series 83

HSS	Z2	82° 90° 100° 120°	
-----	----	----------------------------	--

- Integral pilot size must be specified to any diameter within the indicated range.
- May be ordered with a radius blend between the pilot and countersink angle. Specify any radius between .020" and .070". Contact Customer Service for special blend radius pricing.

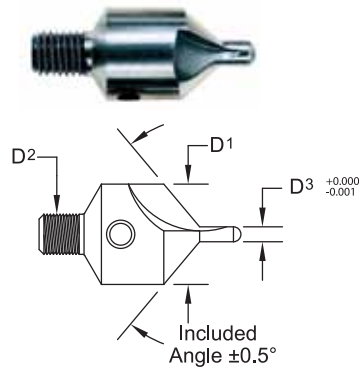

82°	90°	100°	120°	Diameter	Shank	Pilot Size Range
Tool No.	Tool No.	Tool No.	Tool No.	D1	D2	D3
83E00002	83E00003	83E00004	83E00006	3/8	1/4-28	1/16-3/16
83F00002	83F00003	83F00004	83F00006	7/16	1/4-28	3/32-3/16
83G00002	83G00003	83G00004	83G00006	1/2	1/4-28	3/32-1/4
83H00002	83H00003	83H00004	83H00006	5/8	1/4-28	5/32-3/8

Standard angles may be modified from 78° to 119°.

Micro-Stop Series 84

HSS	Z2	82° 90° 100° 120°	
-----	----	----------------------------	--

Use interchangeable steel pilots as shown on page 423.

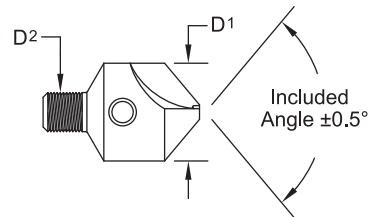

82°		90°		100°		120°		Diameter	Shank	Pilot Series
Tool No.	EDP	Tool No.	EDP	Tool No.	EDP	Tool No.	EDP	D1	D2	
84375002	84049	84375003	84055	84375004	84061	84375006	84067	3/8	1/4-28	850
84437502	84073	84437503	84079	84437504	84085	84437506	84091	7/16	1/4-28	850
84500002	84097	84500003	84103	84500004	84109	84500006	84115	1/2	1/4-28	850
84625002	84121	84625003	84127	84625004	84133	84625006	84139	5/8	1/4-28	851

Standard angles may be modified from 78° to 99°.



Micro-Stop Series 86 HSS Z3



- Integral pilot size must be specified to any diameter within the indicated range.
- May be ordered with a radius blend between the pilot and countersink angle. Specify any radius between .020" and .070". Contact Customer Service for special blend radius pricing.

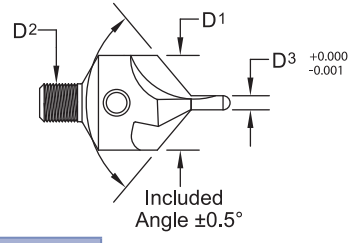

82°		90°		100°		120°		Diameter	Shank	Pilot Size Range
Tool No.	Tool No.	Tool No.	Tool No.	Tool No.	Tool No.	Tool No.	Tool No.	D1	D2	D3
86E00002	86E00003	86E00004	86E00006	3/8	1/4-28	1/16-3/16				
86F00002	86F00003	86F00004	86F00006	7/16	1/4-28	3/32-3/16				
86G00002	86G00003	86G00004	86G00006	1/2	1/4-28	3/32-1/4				
86H00002	86H00003	86H00004	86H00006	5/8	1/4-28	5/32-3/8				

Standard angles may be modified from 78° to 119°.

Micro-Stop Series 87 HSS Z3



Use interchangeable steel pilots as shown on page 423.

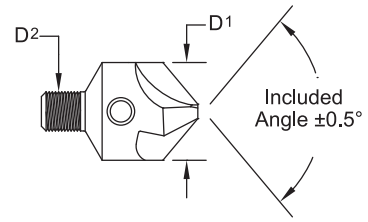

82°		90°		100°		120°		Diameter	Shank	Pilot Series
Tool No.	EDP	Tool No.	EDP	Tool No.	EDP	Tool No.	EDP	D1	D2	
87375002	87049	87375003	87052	87375004	87055	87375006	87058	3/8	1/4-28	850
87437502	87061	87437503	87064	87437504	87067	87437506	87070	7/16	1/4-28	850
87500002	87073	87500003	87076	87500004	87079	87500006	87082	1/2	1/4-28	850
87625002	87085	87625003	87088	87625004	87091	87625006	87094	5/8	1/4-28	851

Standard angles may be modified from 78° to 99°.



Countersink Pilot Series 850

HSS .086" Shank



Countersink Pilot Series 851

HSS .093" Shank



Tool No.	EDP	Tool No.	EDP	D1	
				Size	Decimal
85009370	85001	85109370	85034	3/32	.0937
85009800	85004			40	.0980
85012500	85007	85112500	85037	1/8	.1250
85012850	85010			30	.1285
85015620	85013			5/32	.1562
85015900	85016			21	.1590
85018750	85019	85118750	85040	3/16	.1875
85019350	85022			10	.1935
85021870	85025			7/32	.2187
85025000	85028	85125000	85043	1/4	.2500
85025700	85031			F	.2570
		85131250	85046	5/16	.3125
		85137500	85049	3/8	.3750

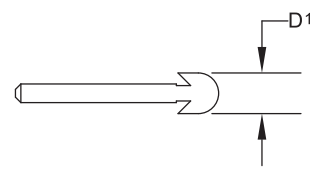

Special pilot diameters available on request.



ISO 9001:2008 Certified

Non-Marking Pad Series 8000006

Steel



- EDP 80011
- Steel non-marking pads offer long life.
 - Designed for 80000002 Micro-Stop Fixtures.

Non-Marking Pad Series 8000007

Plastic



- EDP 80016
- Plastic non-marking pads afford maximum workpiece protection. Imported.
 - Designed for 80000002 Micro-Stop Fixtures.

Non-Marking Pads are designed to protect workpiece surface finishes. They also help ensure perpendicular alignment with the workpiece.

Tool No.	EDP	Cutter Diameter		Shank	Thread
		Min.	Max.		
80000002	80006	N.A.	5/8	1/4	1/4-28
80000002E*	80007	N.A.	5/8	1/4	1/4-28
80000008	80021	3/4	7/8	3/8	7/16-20
80000009	80026	3/4	7/8	3/8	3/8-24
80000010	80031	3/4	1-1/8	3/8	7/16-20
80000011	80036	3/4	1-1/8	3/8	3/8-24
80000006	80011	Steel Non-Marking Pad			
80000006E	80012	Steel Non-Marking Pad for 80000002E			
80000007	80016	Plastic Non-Marking Pad			
80000007E	80017	Plastic Non-Marking Pad for 80000002E			

*External Threads



Page 425

Micro-Stop Fixtures Series 80

Micro-Stop fixtures are designed for precise countersinking and deburring operations that ensures perpendicular alignment with the workpiece and exact depth of cut control. When the fixture is properly adjusted, only the pilot or tip end of the cutter will extend beyond the end of the fixture. However, when the tool is fed into the hole, the cutting edge is exposed, and a cut is made to a pre-determined depth. Imported.

- Accommodates a complete selection of Micro-Stop countersinks and burring cutters.
- 120° seating angle ensures precise axial alignment of threaded shank tools.
- Use in hand tool or machine tool applications.
- Depth of cut control in .001" increments.



Application Data

Uniflute® Feed Rates

Uniflute® countersinks are designed with cam relief; therefore feed rates should not exceed .005” per revolution on larger diameter holes. Reduced feeds also are recommended for smaller holes. A controlled feed results in the chatter-free finishes associated with the Uniflute®.

Multiple Flute Feeds

Multiple flute countersinks are designed for increased feed rates. Because there is more than one cutting edge, chip loads are not excessive, and chatter can be controlled, allowing higher feeds.

Speeds

To determine optimum speed, start at the lower end of the speed range, and then increase speeds until performance is maximized. When a countersink is operated at excessive RPM (n), chatter may result, and cutting edges can overheat and become prematurely dull.

Minimum Body Diameter For 82° Flat Head Cap Screws

Screw Size	Series 67 Size	All other C'sinks Size
#4	7/16	1/4
#5	9/16	5/16
#6	9/16	5/16
#8	9/16	3/8
#10	9/16	1/2
#12	13/16	1/2
1/4	13/16	5/8
5/16	1-1/8	3/4
3/8	1-1/8	7/8
7/16	1-1/8	7/8
1/2	1-1/2	1
5/8	1-1/2	1-1/4
3/4	1-1/2	1-1/2

Material	vc - SFM			
	HSS	HSS TiN Coated	HSS ALtima® Blaze Coated	Carbide
Aluminum / Aluminum Alloys	150-250	190-315	240-400	300-500
Brass / Bronze (ordinary)	75-125	90-160	120-200	150-250
Iron - Cast (soft)	75-125	90-160	120-200	125-225
Iron - Cast (medium hard)	50-100	65-125	80-160	100-175
Iron - Hard Chilled	10-20	15-25	20-35	20-35
Iron - Malleable	80-90	100-115	130-145	90-150
Magnesium / Magnesium Alloys	125-250	160-310	200-400	250-400
Monel, High Nickel Steel	30-50	40-65	50-80	50-75
Plastics, Bakelite	100-250	125-315	160-400	250-400
Steel - Mild (.2 - .3 carbon)	80-100	100-125	130-160	120-170
Steel - Mild (.4 - .5 carbon)	70-80	85-100	115-130	80-150
Tool Steels (1.2 carbon)	50-60	65-75	80-100	60-100
Steel - Forgings	40-50	50-65	65-80	50-80
Steel - Alloys (300 - 400 Brinnell)	20-30	25-40	35-50	30-50
Steel - High Tensile (35 - 40 Rc)	30-40	40-50	50-65	40-60
Steel - High Tensile (40 - 45 Rc)	25-35	30-45	40-56	35-55
Steel - High Tensile (45 - 50 Rc)	15-25	20-30	25-40	25-40
Steel - High Tensile (50 - 55 Rc)	7-15	10-20	15-30	15-20
Stainless Steel - Free Machining	30-80	40-100	50-130	80-125
Stainless Steel - Work Hardening	15-50	20-65	30-80	50-75
Ti-75A (commercially pure Titanium)	50-60	65-75	80-100	60-90
Inconel Alloys	15-20	20-25	25-35	25-35

Diameter Gain in Size For Each .001” of Axial Depth in Hole

Included Angle	Axial Depth ap (inch)	Dia. Gain
30°	.0010	.0005
45°	.0010	.0008
60°	.0010	.0010
82°	.0010	.0017
90°	.0010	.0020
100°	.0010	.0028
120°	.0010	.0034

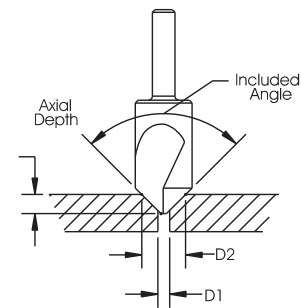

DIAMETER GAIN = D2-D1

ISO 9001:2008 Certified

Technical data provided should be considered advisory only as variations may be necessary depending on the particular application.

Material	vc - m/min.			
	HSS	HSS TiN Coated	HSS ALtima® Blaze Coated	Carbide
Aluminum / Aluminum Alloys	45-75	60-100	75-120	90-155
Brass / Bronze (ordinary)	25-40	30-50	35-60	45-80
Iron - Cast (soft)	25-40	30-50	35-60	40-70
Iron - Cast (medium hard)	15-30	20-40	25-50	30-55
Iron - Hard Chilled	3-10	5-10	5-10	5-10
Iron - Malleable	25-30	30-35	40-45	30-45
Magnesium / Magnesium Alloys	40-75	50-95	60-120	75-125
Monel, High Nickel Steel	10-15	10-20	15-25	15-25
Plastics, Bakelite	30-75	40-100	50-120	80-120
Steel - Mild (.2 - .3 carbon)	25-30	30-40	40-50	40-50
Steel - Mild (.4 - .5 carbon)	20-25	25-30	35-40	25-45
Tool Steels (1.2 carbon)	15-20	20-25	25-30	20-30
Steel - Forgings	10-15	15-20	20-25	15-25
Steel - Alloys (300 - 400 Brinnell)	5-10	10-15	10-15	10-15
Steel - High Tensile (35 - 40 Rc)	10-15	10-15	15-20	15-20
Steel - High Tensile (40 - 45 Rc)	8-15	10-15	10-20	10-20
Steel - High Tensile (45 - 50 Rc)	5-10	5-10	8-10	8-15
Steel - High Tensile (50 - 55 Rc)	2-5	3-5	5-10	5-6
Stainless Steel - Free Machining	10-25	10-30	15-40	25-40
Stainless Steel - Work Hardening	5-10	5-20	10-25	15-25
Ti-75A (commercially pure Titanium)	15-20	20-25	25-30	20-30
Inconel Alloys	5-6	5-10	5-10	8-15

Diameter Gain in Size For Each .025mm of Axial Depth in Hole

Included Angle	Axial Depth ap (mm)	Dia. Gain (mm)
30°	.025	.0127
45°	.025	.0203
60°	.025	.0254
82°	.025	.0432
90°	.025	.0508
100°	.025	.0711
120°	.025	.0864

Minimum Body Diameter For 90° Flat Head Cap Screws (mm)

Screw Size(mm)	C'sink Diameter
3	7
4	10
5	12
6	14
8	19
10	23
12	31

Conversion Formulas

$$(vc\text{-m/min} \times 318.057) / \text{Tool Diameter} = \text{RPM (n)}$$

$$(vc\text{-SFM} \times 3.82) / \text{Tool Diameter} = \text{RPM (n)}$$

*Tool Diameter must be in mm.



Made in USA

Safety Note

Always wear the appropriate personal protective equipment such as safety glasses and protective clothing when using solid carbide or HSS cutting tools. Machines should be fully guarded.

Technical data provided should be considered advisory only as variations may be necessary depending on the particular application.

Edge Hog® Burs

M.A. Ford® manufactures a complete line of Solid Carbide Burs available in three different cuts - Standard, Fine and Shear - to provide a range of finishes on ferrous, non-ferrous and non-metallic materials. Double Cut (Alternate Diamond Grind) Burs are available with left-hand flutes added to help break up chips. These burs are available in Standard and Fine Cut Versions. The following shapes are available:

- SA - Cylindrical Flat End
- SB - Cylindrical Flat End With End Cut
- SC - Cylindrical Radius End
- SD - Spherical
- SE - Elliptical
- SF - Tree Shape Radius End
- SG - Tree Shape Pointed End
- SH - Flame
- SJ - 60° Angle Tool
- SK - 90° Angle Tool
- SL - Conical Radius End
- SM - Conical
- SN - Back Taper
- Bur Sets



ISO 9001:2008 Certified



Where high performance is the standard®

Types of Cuts and Recommended Applications

Following are general guidelines for selecting the correct bur based upon material being machined.

Single (Standard)



A general-purpose right hand flute style is recommended when rapid stock removal and good workpiece finish are the parameters.

Fine



A general-purpose right hand flute style designed for producing higher quality finishes, when removing less stock, with more operator control.

Shear



A right hand flute style bur is recommended for rapid stock removal on softer, non-ferrous and non-metallic materials.

Double (Alternate Diamond Grind)



M.A. Ford® Carbide Burs are available in a Standard Alternate Diamond (Double Cut) and Fine Alternate Diamond style. An alternate diamond grind has left hand fluting added to standard or fine cut fluting. This additional fluting helps break up chips when working steel weldments or other materials that can produce small or sliver-type chips. A slight left hand cutting action typically provides the operator more control of the bur and grinder.

Optional Diamond Grind Available Upon Request



Diamond grind is left hand fluting added to single or fine cut burs. Like an alternate diamond grind, a diamond grind will also break up bothersome chips into an almost granular powder. More precise deburring is possible because of a more balanced left and right hand cutting action. The most rapid penetration achieved with a carbide bur is with diamond grind. A diamond grind will, however, reduce tool life. Recommended for ferrous and stainless steel materials.

Bur Application Chart				
Material	Type of Cut			
	Single	Double	Fine	Shear
Steel, Carbon & Alloys	x	x		
Steel, Nickel Chrome	x	x		
Steel, Stainless	x	x	x	
Steel, Weldments	x	x		
Cast Iron	x			
Titanium	x	x		
Steel, 40-60 Rc	x	x	x	
Wood				x
Aluminum	x	x		x
Brass, Bronze, Copper	x	x		
Carbon	x			
Fiberglass	x			
Hard Rubber	x			x
Magnesium				x
Masonite	x			x
Plastics	x			x
Zinc				x

All burs available with coating.

See page 472 for our coating options.

**Contact M.A. Ford at
800-553-8024 / 563-391-6220
for all your application questions.**

Specify type of cut when ordering.

Order by Tool No. / EDP or SCTI No.

SCTI No. - D Double Cut

SCTI No. - F Fine Cut

Example:

SA-41.....Single Cut

SA-41-D.....Double Cut

SA-41-F.....Fine Cut

Edge Hog® Series SA Inch

Includes Micro Sizes

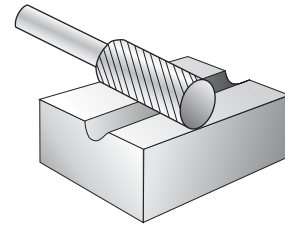

Cylindrical Flat End

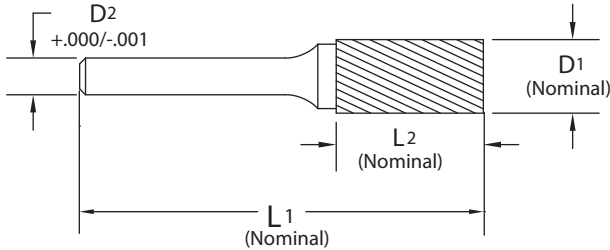

Specify type of cut when ordering.

SCTI	Type of Cut								Diameter	Shank	OAL	Flute Length
	Single		Double		Fine		Shear					
	Tool No.	EDP	Tool No.	EDP	Tool No.	EDP	Tool No.	EDP				
SA-41	69000020	69001	69000027	69009	69000030	69017			1/16	1/8	1-1/2	1/4
SA-42	69020020	69049	69020027	69057	69020030	69065			3/32	1/8	1-1/2	7/16
SA-43	69010020	69025	69010027	69033	69010030	69041			1/8	1/8	1-1/2	9/16
SA-43L3	69010020L3	69801	69010027L3	69803					1/8	1/8	3	9/16
SA-11	41125020	41037	41125027	41049	41125030	41061			1/8	1/4	2	1/2
SA-52	72010020	72001	72010027	72009	72010030	72017			5/32	1/8	1-1/2	1/2
SA-13	41156220	41073	41156227	41085	41156230	41097			5/32	1/4	2	5/8
SA-53	72030020	72049	72030027	72057	72030030	72065			3/16	1/8	1-1/2	1/2
SA-81	74010020	74001	74010027	74005	74010030	74009			3/16	3/16	2	5/8
SA-14	41187520	41109	41187527	41121	41187530	41133			3/16	1/4	2	5/8
SA-51	70010020	70013	70010027	70021	70010030	70029			1/4	1/8	2	1/2
SA-1	41250020	41145	41250027	41157	41250030	41169			1/4	1/4	2	5/8
SA-2	41312520	41181	41312527	41193	41312530	41205			5/16	1/4	2-3/4	3/4
SA-3	41375020	41217	41375027	41229	41375030	41241			3/8	1/4	2-3/4	3/4
SA-3NF							41375150	41601	3/8	1/4	2-3/4	3/4
SA-4	41437520	41273	41437527	41285	41437530	41297			7/16	1/4	3	1
SA-5	41500020	41309	41500027	41321	41500030	41333			1/2	1/4	3	1
SA-5NF							41500150	41616	1/2	1/4	3	1
SA-6	41625020	41365	41625027	41377	41625030	41389			5/8	1/4	3	1
SA-6NF							41625150	41631	5/8	1/4	3	1
SA-15	41750120	41457	41750127	41469	41750130	41481			3/4	1/4	2-1/2	1/2
SA-16	41750220	41493	41750227	41505	41750230	41517			3/4	1/4	2-3/4	3/4
SA-7	41750020	41421	41750027	41433	41750030	41445			3/4	1/4	3	1
SA-9	41100020	41001	41100027	41013	41100030	41025			1	1/4	3	1



Edge Hog® Series SA Metric

Includes Micro Sizes

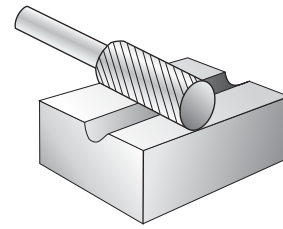

Cylindrical Flat End

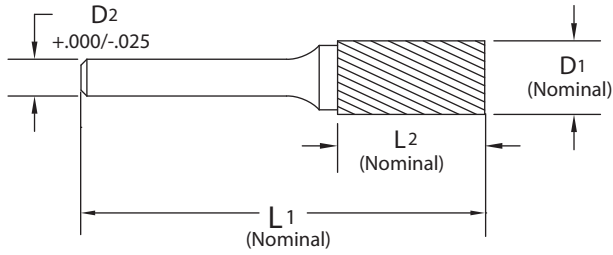

Specify type of cut when ordering.

SCTI	Type of Cut								Diameter D1	Shank D2	OAL L1	Flute Length L2
	Single		Double		Fine		Shear					
	Tool No.	EDP	Tool No.	EDP	Tool No.	EDP	Tool No.	EDP				
SA-41M	69000020M	69005	69000027M	69013	69000030M	69021			1.6	3.0	38.0	6.0
SA-42M	69020020M	69053	69020027M	69061	69020030M	69069			2.4	3.0	38.0	11.1
SA-11M	41125020M	41045	41125027M	41057	41125030M	41069			3.0	6.0	50.0	12.7
SA-43L76M	69010020L3M	69802	69010027L3M	69804					3.0	3.0	76.0	14.3
SA-43M	69010020M	69029	69010027M	69037	69010030M	69045			3.0	3.0	38.0	14.3
SA-52M	72010020M	72005	72010027M	72013	72010030M	72021			4.0	3.0	38.0	12.7
SA-13M	41156220M	41081	41156227M	41093	41156230M	41105			4.0	6.0	50.0	16.0
SA-53M	72030020M	72053	72030027M	72061	72030030M	72069			4.8	3.0	38.0	12.7
SA-14M	41187520M	41117	41187527M	41129	41187530M	41141			4.8	6.0	50.0	16.0
SA-1M	41250020M	41153	41250027M	41165	41250030M	41177			6.0	6.0	50.0	16.0
SA-51M	70010020M	70017	70010027M	70025	70010030M	70033			6.4	3.0	51.0	12.7
SA-2M	41312520M	41189	41312527M	41201	41312530M	41213			8.0	6.0	64.0	19.0
SA-3M	41375020M	41225	41375027M	41237	41375030M	41249			9.5	6.0	64.0	19.0
SA-3NFM							41375150M	41269	9.5	6.0	64.0	19.0
SA-3MZ	41393020M	41250	41393027M	41252	41393030M	41254			10.0	6.0	65.0	20.0
SA-4M	41437520M	41281	41437527M	41293	41437530M	41305			11.0	6.0	70.0	25.0
SA-5MZ	41472020M	41262	41472027M	41264	41472030M	41266			12.0	6.0	70.0	25.0
SA-5M	41500020M	41317	41500027M	41329	41500030M	41341			12.7	6.0	70.0	25.0
SA-5NFM							41500150M	41361	12.7	6.0	70.0	25.0
SA-6M	41625020M	41373	41625027M	41385	41625030M	41397			16.0	6.0	70.0	25.0
SA-6NFM							41625150M	41417	16.0	6.0	70.0	25.0
SA-15M	41750120M	41465	41750127M	41477	41750130M	41489			19.0	6.0	58.0	12.7
SA-16M	41750220M	41501	41750227M	41513	41750230M	41525			19.0	6.0	64.0	19.0
SA-7M	41750020M	41429	41750027M	41441	41750030M	41453			19.0	6.0	70.0	25.0
SA-9M	41100020M	41009	41100027M	41021	41100030M	41033			25.0	6.0	70.0	25.0



Edge Hog® Series SB Inch

Includes Micro Sizes

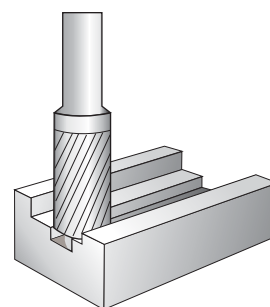

Cylindrical Flat End
End Cut

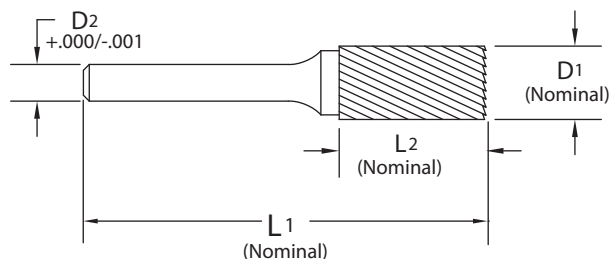

SA - Metric / SB - Inch
Edge Hog® Burs



Specify type of cut
when ordering.

SCTI	Type of Cut								Diameter	Shank	OAL	Flute Length
	Single		Double		Fine		Shear					
	Tool No.	EDP	Tool No.	EDP	Tool No.	EDP	Tool No.	EDP				
SB-11	41125020E	41041	41125027E	41053	41125030E	41065			1/8	1/4	2	1/2
SB-13	41156220E	41077	41156227E	41089	41156230E	41101			5/32	1/4	2	5/8
SB-14	41187520E	41113	41187527E	41125	41187530E	41137			3/16	1/4	2	5/8
SB-51	70000020E	70001	70000027E	70005	70000030E	70009			1/4	1/8	1-11/16	3/16
SB-1	41250020E	41149	41250027E	41161	41250030E	41173			1/4	1/4	2	5/8
SB-2	41312520E	41185	41312527E	41197	41312530E	41209			5/16	1/4	2-3/4	3/4
SB-3	41375020E	41221	41375027E	41233	41375030E	41245			3/8	1/4	2-3/4	3/4
SB-3NF							41375150E	41606	3/8	1/4	2-3/4	3/4
SB-4	41437520E	41277	41437527E	41289	41437530E	41301			7/16	1/4	3	1
SB-5	41500020E	41313	41500027E	41325	41500030E	41337			1/2	1/4	3	1
SB-5NF							41500150E	41621	1/2	1/4	3	1
SB-6	41625020E	41369	41625027E	41381	41625030E	41393			5/8	1/4	3	1
SB-6NF							41625150E	41636	5/8	1/4	3	1
SB-15	41750120E	41461	41750127E	41473	41750130E	41485			3/4	1/4	2-1/2	1/2
SB-16	41750220E	41497	41750227E	41509	41750230E	41521			3/4	1/4	2-3/4	3/4
SB-7	41750020E	41425	41750027E	41437	41750030E	41449			3/4	1/4	3	1
SB-9	41100020E	41005	41100027E	41017	41100030E	41029			1	1/4	3	1



Edge Hog® Series SB Metric

Includes Micro Sizes

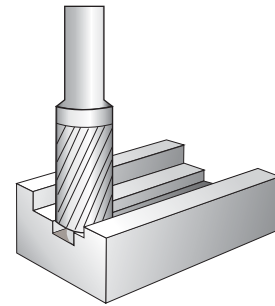
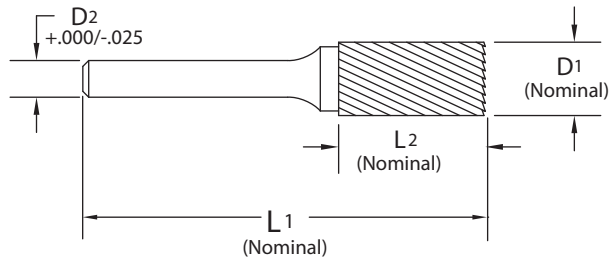

Cylindrical Flat End
End Cut



Specify type of cut
when ordering.

SCTI	Type of Cut								Dia.	Shank	OAL	Flute Length
	Single		Double		Fine		Shear					
	Tool No.	EDP	Tool No.	EDP	Tool No.	EDP	Tool No.	EDP				
SB-11M	41125020EM	41042	41125027EM	41054	41125030EM	41066			3.0	6.0	50.0	12.7
SB-13M	41156220EM	41078	41156227EM	41090	41156230EM	41102			4.0	6.0	50.0	16.0
SB-14M	41187520EM	41114	41187527EM	41126	41187530EM	41138			4.8	6.0	50.0	16.0
SB-1M	41250020EM	41150	41250027EM	41162	41250030EM	41174			6.0	6.0	50.0	16.0
SB-51M	70000020EM	70003	70000027EM	70007	70000030EM	70011			6.4	3.0	43.0	4.8
SB-2M	41312520EM	41186	41312527EM	41198	41312530EM	41210			8.0	6.0	64.0	19.0
SB-3M	41375020EM	41222	41375027EM	41234	41375030EM	41246			9.5	6.0	64.0	19.0
SB-3NFM							41375150EM	41271	9.5	6.0	64.0	19.0
SB-3MZ	41393020EM	41256	41393027EM	41258	41393030EM	41260			10.0	6.0	65.0	20.0
SB-4M	41437520EM	41278	41437527EM	41290	41437530EM	41302			11.0	6.0	70.0	25.0
SB-5MZ	41472020EM	41268	41472027EM	41270	41472030EM	41272			12.0	6.0	70.0	25.0
SB-5M	41500020EM	41314	41500027EM	41326	41500030EM	41338			12.7	6.0	70.0	25.0
SB-5NFM							41500150EM	41363	12.7	6.0	70.0	25.0
SB-6M	41625020EM	41370	41625027EM	41382	41625030EM	41394			16.0	6.0	70.0	25.0
SB-6NFM							41625150EM	41419	16.0	6.0	70.0	25.0
SB-15M	41750120EM	41462	41750127EM	41474	41750130EM	41486			19.0	6.0	58.0	12.7
SB-16M	41750220EM	41498	41750227EM	41510	41750230EM	41522			19.0	6.0	64.0	19.0
SB-7M	41750020EM	41426	41750027EM	41438	41750030EM	41450			19.0	6.0	70.0	25.0
SB-9M	41100020EM	41006	41100027EM	41018	41100030EM	41030			25.0	6.0	70.0	25.0



Edge Hog® Series SC Inch

Includes Micro Sizes

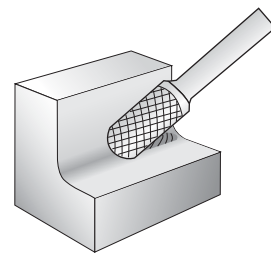

Cylindrical Radius End

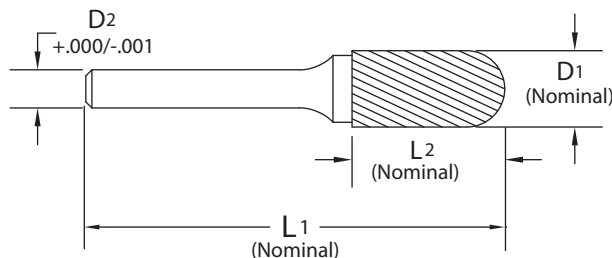

Specify type of cut when ordering.

SCTI	Type of Cut							Dia.	Shank	OAL	Flute Length	
	Single		Double		Fine		Shear					
	Tool No.	EDP	Tool No.	EDP	Tool No.	EDP	Tool No.					EDP
SC-41	69040020	69097	69040027	69105	69040030	69113			3/32	1/8	1-1/2	7/16
SC-11	42125020	42021	42125027	42029	42125030	42037			1/8	1/4	2	1/2
SC-42	69030020	69073	69030027	69081	69030030	69089			1/8	1/8	1-1/2	9/16
SC-42L3	69030020L3	69805	69030027L3	69807					1/8	1/8	3	9/16
SC-52	72020020	72025	72020027	72033	72020030	72041			5/32	1/8	1-1/2	1/2
SC-13	42156220	42045	42156227	42053	42156230	42061			5/32	1/4	2	5/8
SC-53	72040020	72073	72040027	72081	72040030	72089			3/16	1/8	1-1/2	1/2
SC-81	74020020	74013	74020027	74017	74020030	74021			3/16	3/16	2	5/8
SC-14	42187520	42069	42187527	42077	42187530	42085			3/16	1/4	2	5/8
SC-51	70020020	70037	70020027	70045	70020030	70053			1/4	1/8	2	1/2
SC-1	42250020	42093	42250027	42105	42250030	42117			1/4	1/4	2	5/8
SC-1L6	42250020L6	42801	42250027L6	42806	42250030L6	42811			1/4	1/4	6-5/8	5/8
SC-2	42312520	42129	42312527	42141	42312530	42153			5/16	1/4	2-3/4	3/4
SC-2L6	42312520L6	42816	42312527L6	42821	42312530L6	42826			5/16	1/4	6-3/4	3/4
SC-3	42375020	42165	42375027	42177	42375030	42189			3/8	1/4	2-3/4	3/4
SC-3L6	42375020L6	42831	42375027L6	42836	42375030L6	42841			3/8	1/4	6-3/4	3/4
SC-3NF							42375150	42601	3/8	1/4	2-3/4	3/4
SC-4	42437520	42213	42437527	42221	42437530	42229			7/16	1/4	3	1
SC-5	42500020	42237	42500027	42253	42500030	42265			1/2	1/4	3	1
SC-5L6	42500020L6	42846	42500027L6	42851	42500030L6	42856			1/2	1/4	7	1
SC-5NF							42500150	42621	1/2	1/4	3	1
SC-6	42625020	42289	42625027	42297	42625030	42305			5/8	1/4	3	1
SC-6NF							42625150	42641	5/8	1/4	3	1
SC-7	42750020	42325	42750027	42333	42750030	42341			3/4	1/4	3	1
SC-9	42100020	42001	42100027	42009	42100030	42017			1	1/4	3	1

SB - Metric / SC - Inch
Edge Hog® Burs



Edge Hog® Series SC Metric

Includes Micro Sizes

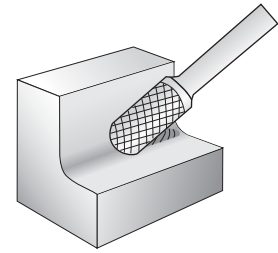

Cylindrical Radius End

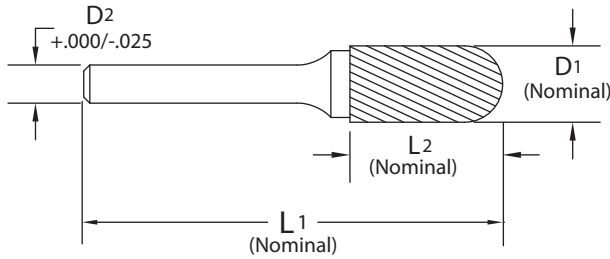

Specify type of cut when ordering.

SCTI	Type of Cut								Dia. D1	Shank D2	OAL L1	Flute Length L2
	Single		Double		Fine		Shear					
	Tool No.	EDP	Tool No.	EDP	Tool No.	EDP	Tool No.	EDP				
SC-41M	69040020M	69101	69040027M	69109	69040030M	69117			2.4	3.0	38.0	11.1
SC-11M	42125020M	42025	42125027M	42033	42125030M	42041			3.0	6.0	50.0	12.7
SC-42M	69030020M	69077	69030027M	69085	69030030M	69093			3.0	3.0	38.0	14.3
SC-42L76M	69030020L3M	69806	69030027L3M	69808					3.0	3.0	76.0	14.3
SC-52M	72020020M	72029	72020027M	72037	72020030M	72045			4.0	3.0	38.0	12.7
SC-13M	42156220M	42049	42156227M	42057	42156230M	42066			4.0	6.0	50.0	16.0
SC-53M	72040020M	72077	72040027M	72085	72040030M	72093			4.8	3.0	38.0	12.7
SC-14M	42187520M	42073	42187527M	42081	42187530M	42089			4.8	6.0	50.0	16.0
SC-1M	42250020M	42101	42250027M	42113	42250030M	42125			6.0	6.0	50.0	16.0
SC-1L6M	42250020L6M	42802	42250027L6M	42807	42250030L6M	42812			6.0	6.0	166.0	16.0
SC-51M	70020020M	70041	70020027M	70049	70020030M	70057			6.4	3.0	51.0	12.7
SC-2M	42312520M	42137	42312527M	42149	42312530M	42161			8.0	6.0	64.0	19.0
SC-2L6M	42312520L6M	42817	42312527L6M	42822	42312530L6M	42827			8.0	6.0	169.0	19.0
SC-3M	42375020M	42173	42375027M	42185	42375030M	42197			9.5	6.0	64.0	19.0
SC-3NFM							42375150M	42209	9.5	6.0	64.0	19.0
SC-3L6M	42375020L6M	42832	42375027L6M	42837	42375030L6M	42842			9.5	6.0	169.0	19.0
SC-3MZ	42393020M	42198	42393027M	42200	42393030M	42202			10.0	6.0	65.0	20.0
SC-4M	42437520M	42217	42437527M	42225	42437530M	42233			11.0	6.0	70.0	25.0
SC-5MZ	42472020M	42204	42472027M	42206	42472030M	42208			12.0	6.0	70.0	25.0
SC-5M	42500020M	42245	42500027M	42261	42500030M	42273			12.7	6.0	70.0	25.0
SC-5NFM							42500150M	42285	12.7	6.0	70.0	25.0
SC-5L6M	42500020L6M	42847	42500027L6M	42852	42500030L6M	42857			12.7	6.0	175.0	25.0
SC-6M	42625020M	42293	42625027M	42301	42625030M	42309			16.0	6.0	70.0	25.0
SC-6NFM							42625150M	42321	16.0	6.0	70.0	25.0
SC-7M	42750020M	42329	42750027M	42337	42750030M	42345			19.0	6.0	70.0	25.0
SC-9M	42100020M	42005	42100027M	42013					25.0	6.0	70.0	25.0



Edge Hog® Series SD Inch

Includes Micro Sizes

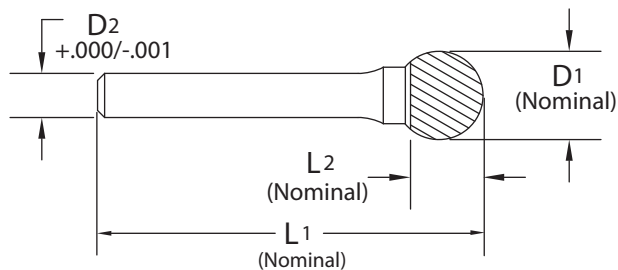
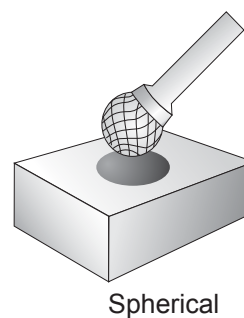

Specify type of cut when ordering.

SCTI	Type of Cut								Dia.	Shank	OAL	Flute Length
	Single		Double		Fine		Shear					
	Tool No.	EDP	Tool No.	EDP	Tool No.	EDP	Tool No.	EDP				
SD-41	69045020	69121	69045027	69129	69045030	69137			3/32	1/8	1-1/2	5/64
SD-11	43125020	43025	43125027	43033	43125030	43041			1/8	1/4	2	7/64
SD-42	69050020	69145	69050027	69153	69050030	69161			1/8	1/8	1-1/2	7/64
SD-42L3	69050020L3	69809	69050027L3	69811					1/8	1/8	3	7/64
SD-14	43187520	43049	43187527	43057	43187530	43065			3/16	1/4	2	5/32
SD-53	72050020	72097	72050027	72105	72050030	72113			3/16	1/8	1-1/2	5/32
SD-81	74030020	74025	74030027	74029	74030030	74033			3/16	3/16	2	5/32
SD-1	43250020	43073	43250027	43085	43250030	43097			1/4	1/4	2	7/32
SD-1L6	43250020L6	43801	43250027L6	43806	43250030L6	43811			1/4	1/4	6-7/32	7/32
SD-51	70030020	70061	70030027	70069	70030030	70077			1/4	1/8	1-23/32	7/32
SD-2	43312520	43109	43312527	43121	43312530	43133			5/16	1/4	2-9/32	9/32
SD-2L6	43312520L6	43816	43312527L6	43821	43312530L6	43826			5/16	1/4	6-9/32	9/32
SD-3	43375020	43145	43375027	43157	43375030	43169			3/8	1/4	2-5/16	5/16
SD-3L6	43375020L6	43831	43375027L6	43836	43375030L6	43841			3/8	1/4	6-5/16	5/16
SD-3NF							43375150	43601	3/8	1/4	2-5/16	5/16
SD-4	43437520	43189	43437527	43197	43437530	43205			7/16	1/4	2-3/8	3/8
SD-5	43500020	43213	43500027	43225	43500030	43237			1/2	1/4	2-7/16	7/16
SD-5L6	43500020L6	43846	43500027L6	43851	43500030L6	43856			1/2	1/4	6-7/16	7/16
SD-5NF							43500150	43621	1/2	1/4	2-7/16	7/16
SD-6	43625020	43257	43625027	43265	43625030	43273			5/8	1/4	2-9/16	9/16
SD-6NF							43625150	43641	5/8	1/4	2-9/16	9/16
SD-7	43750020	43289	43750027	43297	43750030	43305			3/4	1/4	2-11/16	11/16
SD-9	43100020	43001	43100027	43009	43100030	43017			1	1/4	2-15/16	15/16



Edge Hog® Series SD Metric

Includes Micro Sizes

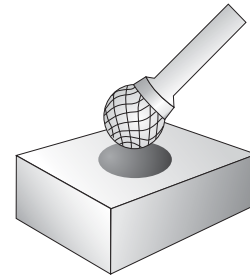

Spherical

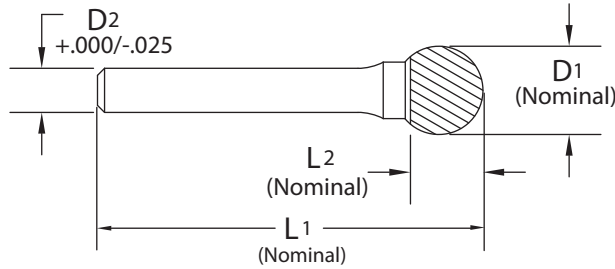

Specify type of cut when ordering.

SCTI	Type of Cut								Dia.	Shank	OAL	Flute Length
	Single		Double		Fine		Shear					
	Tool No.	EDP	Tool No.	EDP	Tool No.	EDP	Tool No.	EDP				
SD-41M	69045020M	69125	69045027M	69133	69045030M	69141			2.4	3.0	38.0	2.0
SD-11M	43125020M	43029	43125027M	43037	43125030M	43045			3.0	6.0	50.0	2.8
SD-42M	69050020M	69149	69050027M	69157	69050030M	69165			3.0	3.0	38.0	2.8
SD-42L76M	69050020L3M	69810	69050027L3M	69812					3.0	3.0	76.0	2.8
SD-14M	43187520M	43053	43187527M	43061	43187530M	43069			4.8	6.0	50.0	4.0
SD-53M	72050020M	72101	72050027M	72109	72050030M	72117			4.8	3.0	38.0	4.0
SD-1M	43250020M	43081	43250027M	43093	43250030M	43105			6.0	6.0	50.0	5.0
SD-1L6M	43250020L6M	43802	43250027L6M	43807	43250030L6M	43812			6.0	6.0	155.0	5.0
SD-51M	70030020M	70065	70030027M	70073	70030030M	70081			6.4	3.0	44.0	5.6
SD-2M	43312520M	43117	43312527M	43129	43312530M	43141			8.0	6.0	51.0	6.0
SD-2L6M	43312520L6M	43817	43312527L6M	43822	43312530L6M	43827			8.0	6.0	159.0	6.0
SD-3M	43375020M	43153	43375027M	43165	43375030M	43177			9.5	6.0	53.0	7.0
SD-3L6M	43375020L6M	43832	43375027L6M	43837	43375030L6M	43842			9.5	6.0	161.0	7.0
SD-3NFM							43375150M	43185	9.5	6.0	53.0	7.0
SD-3MZ	43393020M	43178	43393027M	43180	43393030M	43182			10.0	6.0	54.0	7.0
SD-4M	43437520M	43193	43437527M	43201	43437530M	43209			11.0	6.0	54.0	9.0
SD-5MZ	43472020M	43184	43472027M	43186	43472030M	43188			12.0	6.0	56.0	10.0
SD-5M	43500020M	43221	43500027M	43233	43500030M	43245			12.7	6.0	56.0	10.0
SD-5L6M	43500020L6M	43847	43500027L6M	43852	43500030L6M	43857			12.7	6.0	160.0	10.0
SD-5NFM							43500150M	43253	12.7	6.0	56.0	10.0
SD-6M	43625020M	43261	43625027M	43269	43625030M	43277			16.0	6.0	59.0	13.0
SD-6NFM							43625150M	43285	16.0	6.0	59.0	13.0
SD-7M	43750020M	43293	43750027M	43301	43750030M	43309			19.0	6.0	62.0	16.0
SD-9M	43100020M	43005	43100027M	43013	43100030M	43021			25.0	6.0	68.0	21.0



Edge Hog® Series SE Inch

Includes Micro Sizes

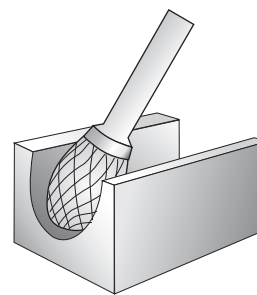

Elliptical

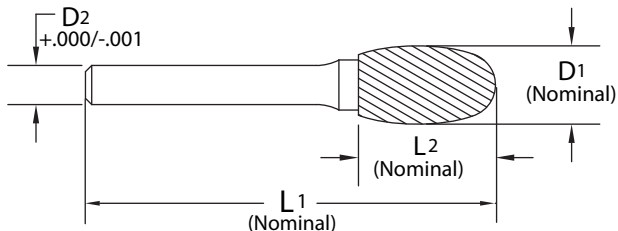

Specify type of cut when ordering.

SCTI	Type of Cut								Dia.	Shank	OAL	Flute Length
	Single		Double		Fine		Shear					
	Tool No.	EDP	Tool No.	EDP	Tool No.	EDP	Tool No.	EDP				
SE-41	69060020	69169	69060027	69177	69060030	69185			1/8	1/8	1-1/2	7/32
SE-41L3	69060020L3	69813	69060027L3	69815					1/8	1/8	3	7/32
SE-53	72060020	72121	72060027	72129	72060030	72137			3/16	1/8	1-1/2	9/32
SE-81	74040020	74037	74040027	74041	74040030	74045			3/16	3/16	2	9/32
SE-1	44250020	44001	44250027	44013	44250030	44025			1/4	1/4	2	3/8
SE-1L6	44250020L6	44801	44250027L6	44806	44250030L6	44811			1/4	1/4	6-3/8	3/8
SE-51	70040020	70085	70040027	70093	70040030	70101			1/4	1/8	1-7/8	3/8
SE-3	44375020	44073	44375027	44085	44375030	44097			3/8	1/4	2-5/8	5/8
SE-3L6	44375020L6	44831	44375027L6	44836	44375030L6	44841			3/8	1/4	6-5/8	5/8
SE-3NF							44375150	44601	3/8	1/4	2-5/8	5/8
SE-5	44500020	44117	44500027	44129	44500030	44141			1/2	1/4	2-7/8	7/8
SE-5L6	44500020L6	44846	44500027L6	44851	44500030L6	44856			1/2	1/4	6-7/8	7/8
SE-5NF							44500150	44621	1/2	1/4	2-7/8	7/8
SE-6	44625020	44161	44625027	44173	44625030	44185			5/8	1/4	3	1
SE-6NF							44625150	44641	5/8	1/4	3	1
SE-7	44750020	44205	44750027	44213	44750030	44221			3/4	1/4	3	1



Edge Hog® Series SE Metric

Includes Micro Sizes

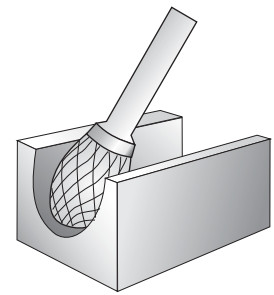
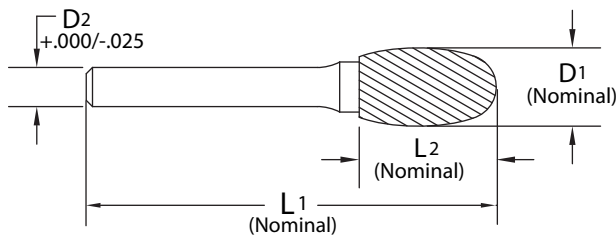

Elliptical

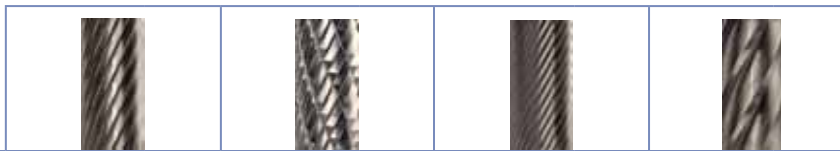

Specify type of cut when ordering a

SCTI	Type of Cut								Dia.	Shank	OAL	Flute Length
	Single		Double		Fine		Shear					
	Tool No.	EDP	Tool No.	EDP	Tool No.	EDP	Tool No.	EDP				
SE-41M	69060020M	69173	69060027M	69181	69060030M	69189			3.0	3.0	38.0	5.6
SE-41L76M	69060020L3M	69814	69060027L3M	69816					3.0	3.0	76.0	5.6
SE-53M	72060020M	72125	72060027M	72133	72060030M	72141			4.8	3.0	38.0	7.0
SE-1M	44250020M	44009	44250027M	44021	44250030M	44033			6.0	6.0	50.0	9.5
SE-1L6M	44250020L6M	44802	44250027L6M	44807	44250030L6M	44812			6.0	6.0	159.0	9.5
SE-51M	70040020M	70089	70040027M	70097	70040030M	70105			6.4	3.0	48.0	9.5
SE-3M	44375020M	44081	44375027M	44093	44375030M	44105			9.5	6.0	60.0	16.0
SE-3L6M	44375020L6M	44832	44375027L6M	44837	44375030L6M	44842			9.5	6.0	166.0	16.0
SE-3NFM							44375150M	44113	9.5	6.0	60.0	16.0
SE-5M	44500020M	44125	44500027M	44137	44500030M	44149			12.7	6.0	67.0	22.0
SE-5L6M	44500020L6M	44847	44500027L6M	44852	44500030L6M	44857			12.7	6.0	172.0	22.0
SE-5NFM							44500150M	44157	12.7	6.0	67.0	22.0
SE-6M	44625020M	44169	44625027M	44181	44625030M	44193			16.0	6.0	70.0	25.0
SE-6NFM							44625150M	44201	16.0	6.0	70.0	25.0
SE-7M	44750020M	44209	44750027M	44217	44750030M	44225			19.0	6.0	70.0	25.0



Edge Hog® Series SF Inch

Includes Micro Sizes

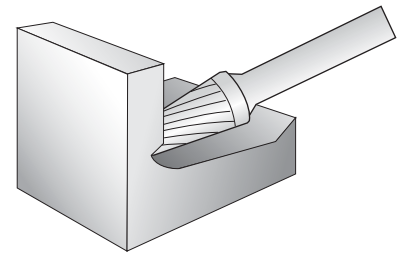

Tree Shape
Radius End

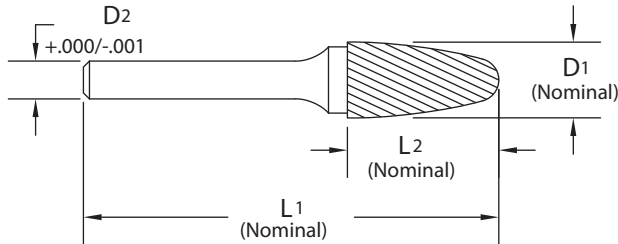

Specify type of cut
when ordering.

SCTI	Type of Cut								Dia.	Shank	OAL	Flute Length
	Single		Double		Fine		Shear					
	Tool No.	EDP	Tool No.	EDP	Tool No.	EDP	Tool No.	EDP				
SF-41	69070020	69193	69070027	69201	69070030	69209			1/8	1/8	1-1/2	1/4
SF-42	69080020	69217	69080027	69225	69080030	69233			1/8	1/8	1-1/2	1/2
SF-42L3	69080020L3	69817	69080027L3	69819					1/8	1/8	3	1/2
SF-11	45125020	45001	45125027	45009	45125030	45017			1/8	1/4	2	1/2
SF-53	72080020	72169	72080027	72177	72080030	72185			3/16	1/8	1-1/2	1/2
SF-81	74060020	74061	74060027	74065	74060030	74069			3/16	3/16	2	1/2
SF-51	70050020	70109	70050027	70117	70050030	70125			1/4	1/8	2	1/2
SF-1	45250020	45025	45250027	45037	45250030	45049			1/4	1/4	2	5/8
SF-1L6	45250020L6	45801	45250027L6	45806	45250030L6	45811			1/4	1/4	6-5/8	5/8
SF-3	45375020	45097	45375027	45109	45375030	45121			3/8	1/4	2-3/4	3/4
SF-3L6	45375020L6	45831	45375027L6	45836	45375030L6	45841			3/8	1/4	6-3/4	3/4
SF-3NF							45375150	45601	3/8	1/4	2-3/4	3/4
SF-4	45437520	45145	45437527	45153	45437530	45161			7/16	1/4	3	1
SF-13	45500120	45205	45500127	45213	45500130	45221			1/2	1/4	2-3/4	3/4
SF-5	45500020	45169	45500027	45181	45500030	45193			1/2	1/4	3	1
SF-5L6	45500020L6	45846	45500027L6	45851	45500030L6	45856			1/2	1/4	7	1
SF-5NF							45500150	45621	1/2	1/4	2-3/4	1
SF-6	45625020	45241	45625027	45253	45625030	45265			5/8	1/4	3	1
SF-6NF							45625150	45641	5/8	1/4	3	1
SF-7	45750120	45313	45750127	45321	45750130	45329			3/4	1/4	3	1
SF-14	45750020	45289	45750027	45297	45750030	45305			3/4	1/4	3-1/4	1-1/4
SF-15	45750220	45337	45750227	45345	45750230	45353			3/4	1/4	3-1/2	1-1/2



Edge Hog® Series SF Metric

Includes Micro Sizes

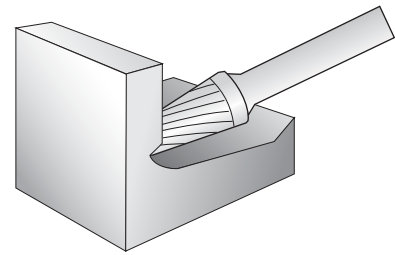
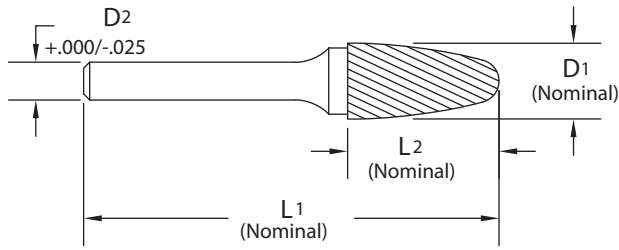

Tree Shape
Radius End



Specify type of cut
when ordering.

SCTI	Type of Cut								Dia.	Shank	OAL	Flute Length
	Single		Double		Fine		Shear					
	Tool No.	EDP	Tool No.	EDP	Tool No.	EDP	Tool No.	EDP				
SF-41M	69070020M	69197	69070027M	69205	69070030M	69213			3.0	3.0	38.0	6.0
SF-42M	69080020M	69221	69080027M	69229	69080030M	69237			3.0	3.0	38.0	12.7
SF-42L76M	69080020L3M	69818	69080027L3M	69820					3.0	3.0	76.0	12.7
SF-11M	45125020M	45005	45125027M	45013	45125030M	45021			3.0	6.0	50.0	12.7
SF-51M	70050020M	70113	70050027M	70121	70050030M	70129			6.4	3.0	51.0	12.7
SF-53M	72080020M	72173	72080027M	72181	72080030M	72189			4.8	3.0	38.0	12.7
SF-1M	45250020M	45033	45250027M	45045	45250030M	45057			6.0	6.0	50.0	16.0
SF-1L6M	45250020L6M	45802	45250027L6M	45807	45250030L6M	45812			6.0	6.0	166.0	16.0
SF-13M	45500120M	45209	45500127M	45217	45500130M	45225			12.7	6.0	64.0	19.0
SF-3M	45375020M	45105	45375027M	45117	45375030M	45129			9.5	6.0	64.0	19.0
SF-3L6M	45375020L6M	45832	45375027L6M	45837	45375030L6M	45842			9.5	6.0	169.0	19.0
SF-3NFM							45375150M	45141	9.5	6.0	64.0	19.0
SF-4M	45437520M	45149	45437527M	45157	45437530M	45165			11.0	6.0	70.0	25.0
SF-5M	45500020M	45177	45500027M	45189	45500030M	45201			12.7	6.0	70.0	25.0
SF-5L6M	45500020L6M	45847	45500027L6M	45852	45500030L6M	45857			12.7	6.0	175.0	25.0
SF-5MZ	45472020M	45130	45472027M	45132	45472030M	45134			12.0	6.0	70.0	25.0
SF-5NFM							45500150M	45237	12.7	6.0	70.0	25.0
SF-6M	45625020M	45249	45625027M	45261	45625030M	45273			16.0	6.0	70.0	25.0
SF-6NFM							45625150M	45285	16.0	6.0	70.0	25.0
SF-7M	45750120M	45317	45750127M	45325	45750130M	45333			19.0	6.0	70.0	25.0
SF-14M	45750020M	45293	45750027M	45301	45750030M	45309			19.0	6.0	76.0	31.0
SF-15M	45750220M	45341	45750227M	45349	45750230M	45357			19.0	6.0	84.0	38.0



Edge Hog® Series SG Inch

Includes Micro Sizes

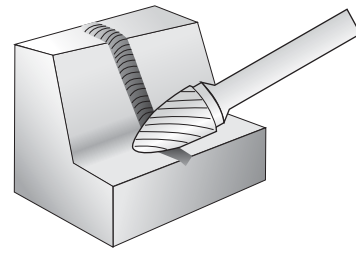

Tree Shape
Pointed End

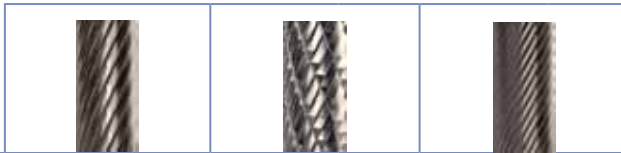
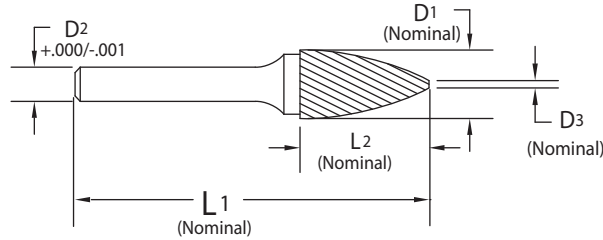

Specify type of cut
when ordering.

SCTI	Type of Cut						Dia.	Shank	End Dia.	OAL	Flute Length
	Single		Double		Fine						
	Tool No.	EDP	Tool No.	EDP	Tool No.	EDP					
SG-41	69090020	69241	69090027	69249	69090030	69257	1/8	1/8	.018	1-1/2	1/4
SG-43	69100020	69289	69100027	69297	69100030	69305	1/8	1/8	.018	1-1/2	3/8
SG-43L3	69100020L3	69825	69100027L3	69827			1/8	1/8	.018	3	3/8
SG-42	69095020	69265	69095027	69273	69095030	69281	1/8	1/8	.018	1-1/2	5/16
SG-42L3	69095020L3	69821	69095027L3	69823			1/8	1/8	.018	3	5/16
SG-53	72090020	72193	72090027	72201	72090030	72209	3/16	1/8	.025	1-1/2	1/2
SG-81	74070020	74073	74070027	74077	74070030	74081	3/16	3/16	.023	2	1/2
SG-51	70060020	70133	70060027	70141	70060030	70149	1/4	1/8	.030	2	1/2
SG-1	46250020	46001	46250027	46013	46250030	46025	1/4	1/4	.030	2	5/8
SG-1L6	46250020L6	46801	46250027L6	46806	46250030L6	46811	1/4	1/4	.030	6-5/8	5/8
SG-2	46312520	46037	46312527	46049	46312530	46061	5/16	1/4	.040	2-3/4	3/4
SG-3	46375020	46073	46375027	46085	46375030	46097	3/8	1/4	.040	2-3/4	3/4
SG-3L6	46375020L6	46831	46375027L6	46836	46375030L6	46841	3/8	1/4	.040	6-3/4	3/4
SG-5	46500020	46109	46500027	46121	46500030	46133	1/2	1/4	.050	3	1
SG-5L6	46500020L6	46846	46500027L6	46851	46500030L6	46856	1/2	1/4	.050	7	1
SG-13	46500120	46145	46500127	46153	46500130	46161	1/2	1/4	.050	2-3/4	3/4
SG-6	46625020	46169	46625027	46181	46625030	46193	5/8	1/4	.050	3	1
SG-7	46750020	46205	46750027	46213	46750030	46221	3/4	1/4	.050	3	1
SG-15	46750120	46229	46750127	46237	46750130	46245	3/4	1/4	.070	3-1/2	1-1/2



Edge Hog® Series SG Metric

Includes Micro Sizes

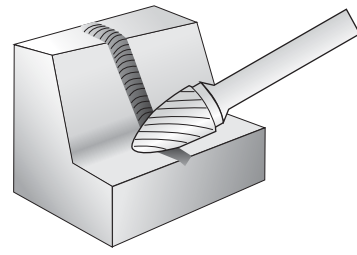

Tree Shape
Pointed End

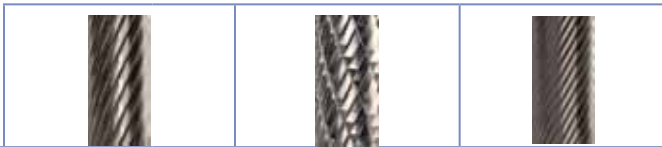
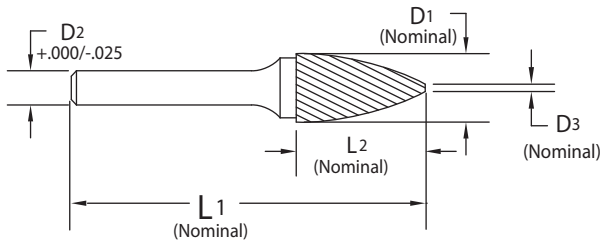

Specify type of cut
when ordering.

SCTI	Type of Cut						Dia.	Shank	End Dia.	OAL	Flute Length
	Single		Double		Fine						
	Tool No.	EDP	Tool No.	EDP	Tool No.	EDP					
SG-41M	69090020M	69245	69090027M	69253	69090030M	69261	3.0	3.0	0.46	38.0	6.0
SG-42M	69095020M	69269	69095027M	69277	69095030M	69285	3.0	3.0	0.46	38.0	8.0
SG-42L76M	69095020L3M	69822	69095027L3M	69824			3.0	3.0	0.46	76.0	8.0
SG-43M	69100020M	69293	69100027M	69301	69100030M	69309	3.0	3.0	0.46	38.0	9.5
SG-43L76M	69100020L3M	69826	69100027L3M	69828			3.0	3.0	0.46	76.0	9.5
SG-53M	72090020M	72197	72090027M	72205	72090030M	72213	4.8	3.0	0.64	38.0	12.7
SG-1M	46250020M	46009	46250027M	46021	46250030M	46033	6.0	6.0	0.76	50.0	16.0
SG-1L6M	46250020L6M	46802	46250027L6M	46807	46250030L6M	46812	6.0	6.0	0.76	166.0	16.0
SG-51M	70060020M	70137	70060027M	70145	70060030M	70153	6.4	3.0	0.76	51.0	12.7
SG-2M	46312520M	46045	46312527M	46057	46312530M	46069	8.0	6.0	1.02	64.0	19.0
SG-3M	46375020M	46081	46375027M	46093	46375030M	46105	9.5	6.0	1.02	64.0	19.0
SG-3L6M	46375020L6M	46832	46375027L6M	46837	46375030L6M	46842	9.5	6.0	1.02	169.0	19.0
SG-3MZ	46393020M	46098	46393027M	46100	46393030M	46102	10.0	6.0	1.14	65.0	20.0
SG-5MZ	46472020M	46104	46472027M	46106	46472030M	46108	12.0	6.0	1.27	70.0	25.0
SG-13M	46500120M	46149	46500127M	46157	46500130M	46165	12.7	6.0	1.27	64.0	19.0
SG-5M	46500020M	46117	46500027M	46129	46500030M	46141	12.7	6.0	1.27	70.0	25.0
SG-5L6M	46500020L6M	46847	46500027L6M	46852	46500030L6M	46857	12.7	6.0	1.27	175.0	25.0
SG-6M	46625020M	46177	46625027M	46189	46625030M	46201	16.0	6.0	1.27	70.0	25.0
SG-7M	46750020M	46209	46750027M	46217	46750030M	46225	19.0	6.0	1.27	70.0	25.0
SG-15M	46750120M	46233	46750127M	46241	46750130M	46249	19.0	6.0	1.78	84.0	38.0



Edge Hog® Series SH Inch

Includes Micro Sizes

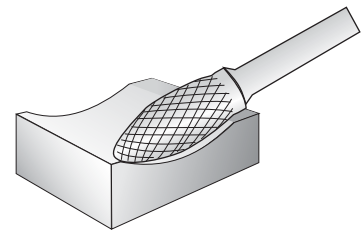

Flame

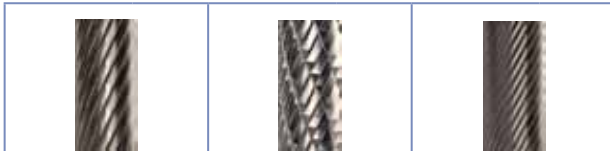
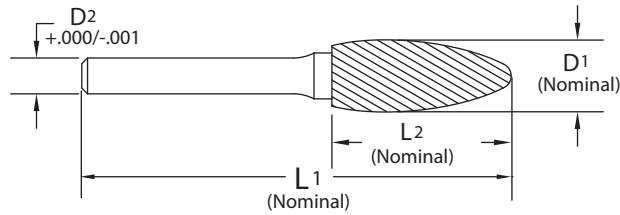

Specify type of cut
when ordering.

SCTI	Type of Cut						Dia.	Shank	OAL	Flute Length
	Single		Double		Fine					
	Tool No.	EDP	Tool No.	EDP	Tool No.	EDP				
SH-41	69160020	69513	69160027	69521	69160030	69529	1/8	1/8	1-1/2	1/4
SH-41L3	69160020L3	69837	69160027L3	69839			1/8	1/8	3	1/4
SH-53	72070020	72145	72070027	72153	72070030	72161	3/16	1/8	1-1/2	3/8
SH-81	74050020	74049	74050027	74053	74050030	74057	3/16	3/16	2	3/8
SH-1	49250020	49001	49250027	49013	49250030	49025	1/4	1/4	2	5/8
SH-2	49312520	49037	49312527	49049	49312530	49061	5/16	1/4	2-3/4	3/4
SH-2L6	49312520L6	49816	49312527L6	49821	49312530L6	49826	5/16	1/4	6-3/4	3/4
SH-5	49500020	49109	49500027	49121	49500030	49133	1/2	1/4	3-1/4	1-1/4
SH-5L6	49500020L6	49846	49500027L6	49851	49500030L6	49856	1/2	1/4	7-1/4	1-1/4
SH-6	49625020	49145	49625027	49157	49625030	49169	5/8	1/4	3-7/16	1-7/16
SH-7	49750020	49181	49750027	49189	49750030	49197	3/4	1/4	3-5/8	1-5/8



Edge Hog® Series SH Metric

Includes Micro Sizes

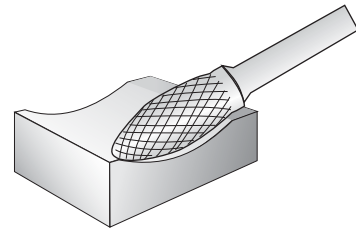

Flame

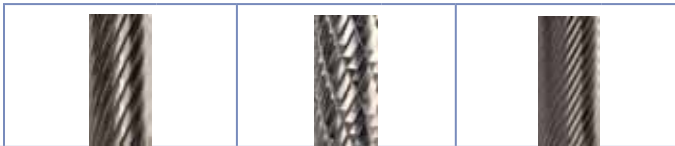
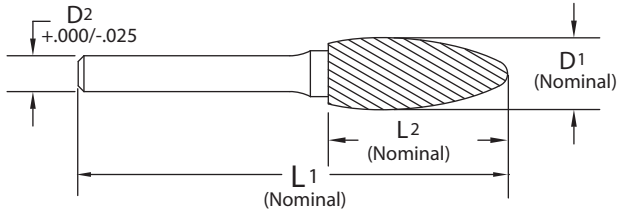

Specify type of cut
when ordering.

SCTI	Type of Cut						Dia.	Shank	OAL	Flute Length
	Single		Double		Fine					
	Tool No.	EDP	Tool No.	EDP	Tool No.	EDP				
SH-41M	69160020M	69517	69160027M	69525	69160030M	69533	3.0	3.0	38.0	6.0
SH-41L76M	69160020L3M	69838	69160027L3M	69840			3.0	3.0	76.0	6.0
SH-53M	72070020M	72149	72070027M	72157	72070030M	72165	4.8	3.0	38.0	9.5
SH-1M	49250020M	49009	49250027M	49021	49250030M	49033	6.0	6.0	50.0	16.0
SH-2M	49312520M	49045	49312527M	49057	49312530M	49069	8.0	6.0	64.0	19.0
SH-2L6M	49312520L6M	49817	49312527L6M	49822	49312530L6M	49827	8.0	6.0	169.0	19.0
SH-5M	49500020M	49117	49500027M	49129	49500030M	49141	12.7	6.0	76.0	31.0
SH-5L6M	49500020L6M	49847	49500027L6M	49852	49500030L6M	49857	12.7	6.0	181.0	31.0
SH-6M	49625020M	49153	49625027M	49165	49625030M	49177	16.0	6.0	81.0	36.0
SH-7M	49750020M	49185	49750027M	49193	49750030M	49201	19.0	6.0	86.0	41.0



Edge Hog® Series SJ Inch

Includes Micro Sizes



60° Carbide
Angle Tool

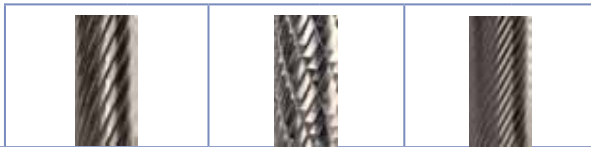
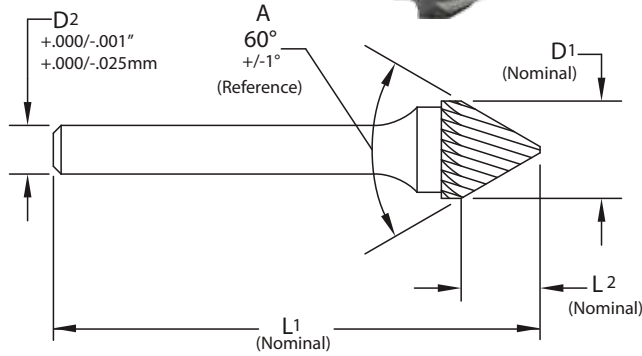
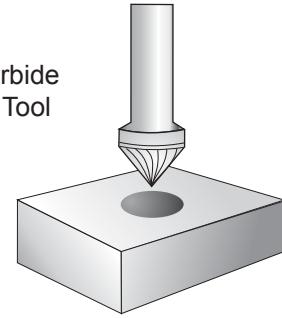

Specify type of cut
when ordering.

SCTI	Type of Cut						Dia.	Shank	OAL	Flute Length	Angle
	Single		Double		Fine						
	Tool No.	EDP	Tool No.	EDP	Tool No.	EDP					
SJ-42	69110020	69313	69110027	69321	69110030	69329	1/8	1/8	1-1/2	3/32	60°
SJ-82*	69112520	69337	69112527	69345			1/8	1/8	1-1/2	3/32	60°
SJ-1	29602500	29601	29602507	29605			1/4	1/4	2	3/16	60°
SJ-3	29603750	29609	29603757	29613			3/8	1/4	2-7/16	5/16	60°
SJ-5	29605000	29617	29605007	29621			1/2	1/4	2-35/46	7/16	60°
SJ-6	29606250	29625	29606257	29629			5/8	1/4	2-11/16	1/2	60°
SJ-7	29607500	29633	29607507	29637			3/4	1/4	2-51/64	9/16	60°
SJ-9	29610000	29641	29610007	29645			1	1/4	2-31/32	13/16	60°

*Double End

Edge Hog® Series SJ Metric

Includes Micro Sizes

SCTI	Type of Cut						Dia.	Shank	OAL	Flute Length	Angle
	Single		Double		Fine						
	Tool No.	EDP	Tool No.	EDP	Tool No.	EDP					
SJ-42M	69110020M	69317	69110027M	69325	69110030M	69333	3.0	3.0	38	2.4	60°
SJ-82M*	69112520M	69341	69112527M	69349			3.0	3.0	38	2.4	60°
SJ-1M	29602500M	29603	29602507M	29607			6.0	6.0	50	4.8	60°
SJ-3M	29603750M	29611	29603757M	29615			9.5	6.0	55	8.0	60°
SJ-5M	29605000M	29619	29605007M	29623			12.7	6.0	58	11.0	60°
SJ-6M	29606250M	29627	29606257M	29631			16.0	6.0	62	12.7	60°
SJ-7M	29607500M	29635	29607507M	29639			19.0	6.0	64	14.0	60°
SJ-9M	29610000M	29643	29610007M	29647			25.0	6.0	70	21.0	60°

*Double End



Edge Hog® Series SK Inch

Includes Micro Sizes

90° Carbide
Angle Tool

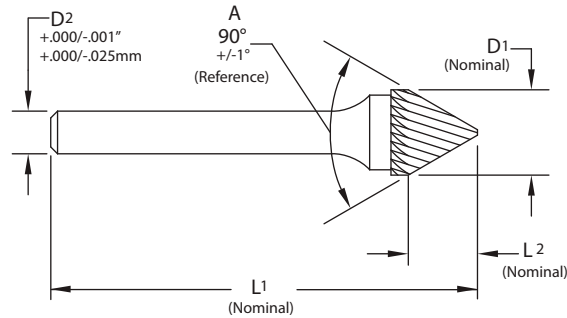
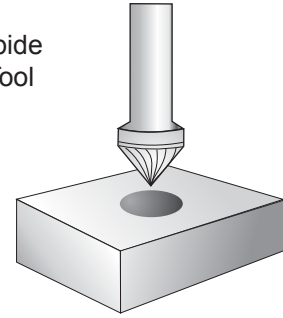

Specify type of cut
when ordering.

SCTI	Type of Cut				Dia. D1	Shank D2	OAL L1	Flute Length L2	Angle A
	Single		Double						
	Tool No.	EDP	Tool No.	EDP					
SK-42	69117520	69366	69117527	69367	1/8	1/8	1-1/2	1/16	90°
SK-82*	69115020	69353	69115027	69361	1/8	1/8	1-1/2	1/16	90°
SK-1	29702500	29701	29702507	29705	1/4	1/4	2	1/8	90°
SK-3	29703750	29709	29703757	29713	3/8	1/4	2-5/16	3/16	90°
SK-5	29705000	29717	29705007	29721	1/2	1/4	2-5/8	1/4	90°
SK-6	29706250	29725	29706257	29729	5/8	1/4	2-31/64	5/16	90°
SK-7	29707500	29733	29707507	29737	3/4	1/4	2-35/64	3/8	90°
SK-9	29710000	29741	29710007	29745	1	1/4	2-41/64	1/2	90°

*Double End

Edge Hog® Series SK Metric

Includes Micro Sizes

SCTI	Type of Cut				Dia. D1	Shank D2	OAL L1	Flute Length L2	Angle A
	Single		Double						
	Tool No.	EDP	Tool No.	EDP					
SK-42M	69117520M	69370	69117527M	69371	3.0	3.0	38.0	1.6	90°
SK-82M*	69115020M	69357	69115027M	69365	3.0	3.0	38.0	1.6	90°
SK-1M	29702500M	29703	29702507M	29707	6.0	6.0	50	3.0	90°
SK-3M	29703750M	29711	29703757M	29715	9.5	6.0	52	4.8	90°
SK-5M	29705000M	29719	29705007M	29723	12.7	6.0	53	6.4	90°
SK-6M	29706250M	29727	29706257M	29731	16.0	6.0	56	8.0	90°
SK-7M	29707500M	29735	29707507M	29739	19.0	6.0	58	9.5	90°
SK-9M	29710000M	29743	29710007M	29747	25.0	6.0	61	12.7	90°

*Double End



Edge Hog® Series SL Inch

Includes Micro Sizes

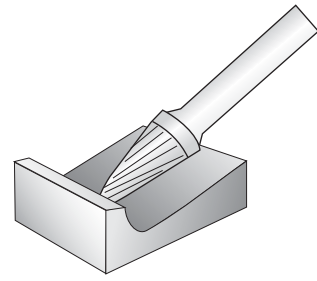

Conical Radius End

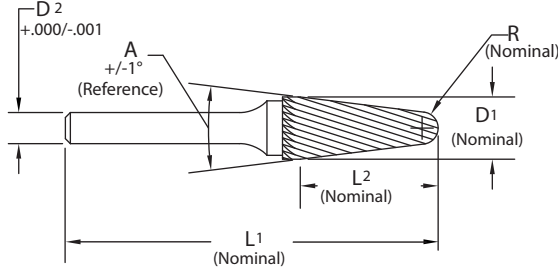

Specify type of cut when ordering.

SCTI	Type of Cut								Dia. D1	Shank D2	OAL L1	Flute Length L2	Angle A	Radius R
	Single		Double		Fine		Shear							
	Tool No.	EDP	Tool No.	EDP	Tool No.	EDP	Tool No.	EDP						
SL-42	69150020	69489	69150027	69497	69150030	69505			1/8	1/8	1-1/2	1/2	8°	.025
SL-42L3	69150020L3	69833	69150027L3	69835					1/8	1/8	3	1/2	8°	.025
SL-41	69145020	69465	69145027	69473	69145030	69481			1/8	1/8	1-1/2	3/8	8°	.039
SL-53	72120020	72265	72120027	72273	72120030	72281			3/16	1/8	1-1/2	1/2	14°	.030
SL-81	74100020	74109	74100027	74113	74100030	74117			3/16	3/16	2	1/2	14°	.030
SL-1	48250020	48001	48250027	48013	48250030	48025			1/4	1/4	2	5/8	14°	.060
SL-2	48312520	48037	48312527	48049	48312530	48061			5/16	1/4	3	15/16	14°	.060
SL-2L6	48312520L6	48816	48312527L6	48821	48312530L6	48826			5/16	1/4	7	15/16	14°	.060
SL-3	48375020	48073	48375027	48085	48375030	48097			3/8	1/4	3-3/16	1-1/8	14°	.060
SL-3L6	48375020L6	48831	48375027L6	48836	48375030L6	48841			3/8	1/4	7-3/16	1-1/8	14°	.060
SL-3NF							48375150	48601	3/8	1/4	3-3/16	1-1/8	14°	.060
SL-4	48500020	48121	48500027	48133	48500030	48145			1/2	1/4	3-1/4	1-3/16	14°	.130
SL-4L6	48500020L6	48846	48500027L6	48851	48500030L6	48856			1/2	1/4	7-1/4	1-3/16	14°	.130
SL-4NF							48500150	48621	1/2	1/4	3-1/4	1-3/16	14°	.130
SL-6	48625020	48169	48625027	48177	48625030	48185			5/8	1/4	3-7/16	1-5/16	14°	.187
SL-6NF							48625150	48641	5/8	1/4	3-7/16	1-5/16	14°	.187
SL-7	48750020	48205	48750027	48213	48750030	48221			3/4	1/4	3-5/8	1-9/16	14°	.230



Edge Hog® Series SL Metric

Includes Micro Sizes

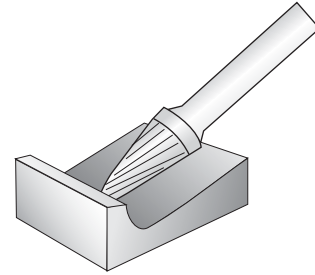
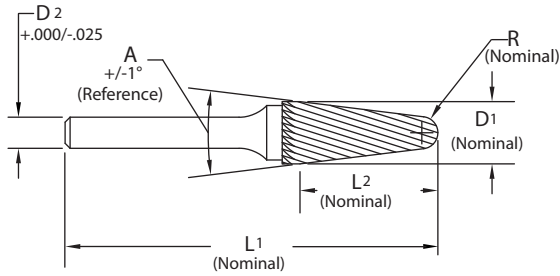

Conical Radius End

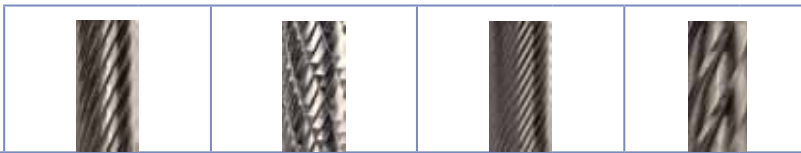

Specify type of cut when ordering.

SCTI	Type of Cut								Dia.	Shank	OAL	Flute Length	Angle	Radius
	Single		Double		Fine		Shear							
	Tool No.	EDP	Tool No.	EDP	Tool No.	EDP	Tool No.	EDP						
SL-41M	69145020M	69469	69145027M	69477	69145030M	69485			3.0	3.0	38.0	9.5	8°	0.99
SL-42M	69150020M	69493	69150027M	69501	69150030M	69509			3.0	3.0	38.0	12.7	8°	0.64
SL-42L76M	69150020L3M	69834	69150027L3M	69836					3.0	3.0	76.0	12.7	8°	0.64
SL-53M	72120020M	72269	72120027M	72277	72120030M	72285			4.8	3.0	38.0	12.7	14°	0.76
SL-1M	48250020M	48009	48250027M	48021	48250030M	48033			6.0	6.0	50.0	16.0	14°	1.52
SL-2M	48312520M	48045	48312527M	48057	48312530M	48069			8.0	6.0	71.0	24.0	14°	1.52
SL-2L6M	48312520L6M	48817	48312527L6M	48822	48312530L6M	48827			8.0	6.0	176.0	24.0	14°	1.52
SL-3M	48375020M	48081	48375027M	48093	48375030M	48105			9.5	6.0	75.0	28.0	14°	1.52
SL-3L6M	48375020L6M	48832	48375027L6M	48837	48375030L6M	48842			9.5	6.0	180.0	28.0	14°	1.52
SL-3NFM							48375150M	48117	9.5	6.0	75.0	28.0	14°	1.52
SL-4M	48500020M	48129	48500027M	48141	48500030M	48153			12.7	6.0	77.0	30.0	14°	3.30
SL-4L6M	48500020L6M	48847	48500027L6M	48852	48500030L6M	48857			12.7	6.0	182.0	30.0	14°	3.30
SL-4NFM							48500150M	48165	12.7	6.0	77.0	30.0	14°	3.30
SL-6M	48625020M	48173	48625027M	48181	48625030M	48189			16.0	6.0	80.0	33.0	14°	4.75
SL-6NFM							48625150M	48201	16.0	6.0	80.0	33.0	14°	4.75
SL-7M	48750020M	48209	48750027M	48217	48750030M	48225			19.0	6.0	86.0	39.0	14°	5.84



ISO 9001:2008 Certified

Edge Hog® Series SM Inch

Includes Micro Sizes

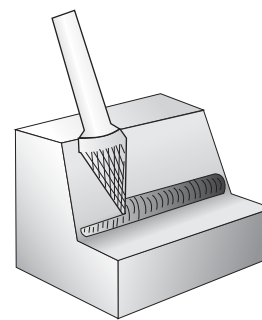

Conical

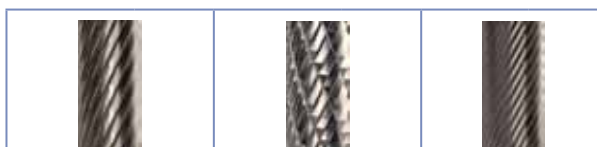
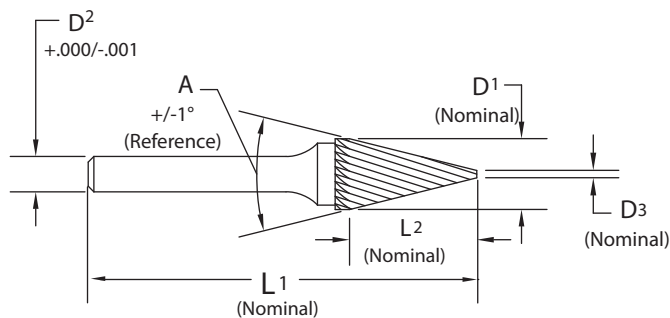

Specify type of cut when ordering.

SCTI	Type of Cut						Dia.	Shank	End Dia.	OAL	Flute Length	Angle
	Single		Double		Fine							
	Tool No.	EDP	Tool No.	EDP	Tool No.	EDP						
SM-45	69120020	69369	69120027	69377	69120030	69385	1/8	1/8	.018	1-1/2	3/16	32°
SM-41	69125020	69393	69125027	69401	69125030	69409	1/8	1/8	.043	1-1/2	3/8	12°
SM-43	69140020	69441	69140027	69449	69140030	69457	1/8	1/8	.045	1-1/2	5/8	7°
SM-42	69130020	69417	69130027	69425	69130030	69433	1/8	1/8	.014	1-1/2	7/16	14°
SM-42L3	69130020L3	69829	69130027L3	69831			1/8	1/8	.014	3	7/16	14°
SM-53	72100020	72217	72100027	72225	72100030	72233	3/16	1/8	.038	1-1/2	1/2	16°
SM-81	74080020	74085	74080027	74089	74080030	74093	3/16	3/16	.053	2	5/8	12°
SM-3	47250220	47049	47250227	47057	47250230	47065	1/4	1/4	.065	2	1	10°
SM-1	47250020	47001	47250027	47009	47250030	47017	1/4	1/4	.046	2	1/2	22°
SM-51	70070020	70157	70070027	70165	70070030	70173	1/4	1/8	.052	2-1/8	1/2	22°
SM-2	47250120	47025	47250127	47033	47250130	47041	1/4	1/4	.056	2	3/4	14°
SM-4	47375020	47073	47375027	47081	47375030	47089	3/8	1/4	.052	2-3/4	5/8	28°
SM-5	47500020	47097	47500027	47105	47500030	47113	1/2	1/4	.052	3	7/8	28°
SM-6	47625020	47121	47625027	47129	47625030	47137	5/8	1/4	.060	3-1/8	1	31°



Edge Hog® Series SM Metric

Includes Micro Sizes

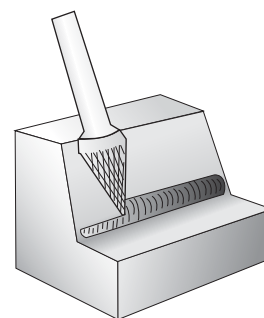
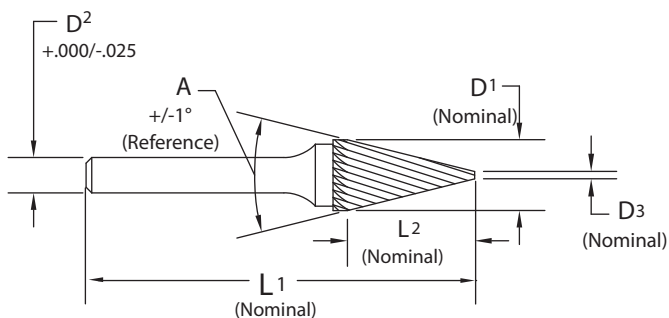

Conical

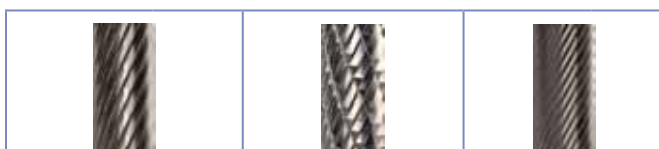

Specify type of cut when ordering.

SCTI	Type of Cut						Dia.	Shank	End Dia.	OAL	Flute Length	Angle
	Single		Double		Fine							
	Tool No.	EDP	Tool No.	EDP	Tool No.	EDP						
SM-45M	69120020M	69373	69120027M	69381	69120030M	69389	D1	D2	D3	L1	L2	A
SM-41M	69125020M	69397	69125027M	69405	69125030M	69413	3.0	3.0	1.09	38	9.5	12°
SM-42M	69130020M	69421	69130027M	69429	69130030M	69437	3.0	3.0	0.36	38	11.1	14°
SM-42L76M	69130020L3M	69830	69130027L3M	69832			3.0	3.0	0.36	76	11.1	14°
SM-43M	69140020M	69445	69140027M	69453	69140030M	69461	3.0	3.0	1.14	38	16.0	7°
SM-53M	72100020M	72221	72100027M	72229	72100030M	72237	4.8	3.0	0.97	38	12.7	16°
SM-1M	47250020M	47005	47250027M	47013	47250030M	47021	6.0	6.0	1.17	50	12.7	22°
SM-2M	47250120M	47029	47250127M	47037	47250130M	47045	6.0	6.0	1.42	50	19.0	14°
SM-3M	47250220M	47053	47250227M	47061	47250230M	47069	6.0	6.0	1.65	50	25.0	10°
SM-51M	70070020M	70161	70070027M	70169	70070030M	70177	6.4	3.0	1.32	54	12.7	22°
SM-4M	47375020M	47077	47375027M	47085	47375030M	47093	9.5	6.0	1.32	63	16.0	28°
SM-5M	47500020M	47101	47500027M	47109	47500030M	47117	12.7	6.0	1.32	69	22.0	28°
SM-6M	47625020M	47125	47625027M	47133	47625030M	47141	16.0	6.0	1.52	72	25.0	31°



Edge Hog® Series SN Inch

Includes Micro Sizes

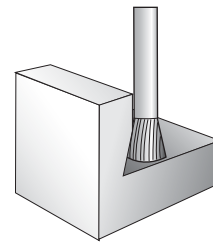

Backtaper

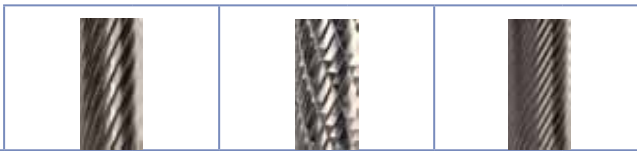
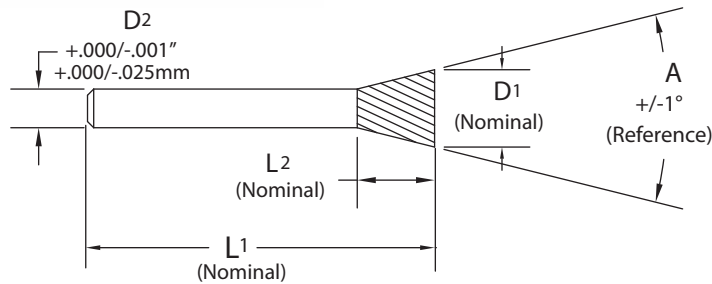

Specify type of cut when ordering.

SCTI	Type of Cut						Dia.	Shank	OAL	Flute Length		Angle	
	Single		Double		Fine					L1	L2		A
	Tool No.	EDP	Tool No.	EDP	Tool No.	EDP							
SN-41	69165020	69537	69165027	69545	69165030	69553	3/32	1/8	1-1/2	1/8	10°		
SN-42*	69170020E	69561	69170027E	69565	69170030E	69569	1/8	1/8	1-1/2	3/16	10°		
SN-53	72110020	72241	72110027	72249	72110030	72257	3/16	1/8	1-1/2	1/4	10°		
SN-81	74090020	74097	74090027	74101	74090030	74105	3/16	3/16	2	1/4	10°		
SN-51	70080020	70181	70080027	70189	70080030	70197	1/4	1/8	1-3/4	1/4	10°		
SN-1	50025020	50001	50025027	50009	50025030	50017	1/4	1/4	2	5/16	10°		
SN-2	50037520	50049	50037527	50057	50037530	50065	3/8	1/4	2-3/8	3/8	13°		
SN-4	50050020	50073	50050027	50081	50050030	50089	1/2	1/4	2-1/2	1/2	28°		
SN-6	50062520	50097	50062527	50105	50062530	50113	5/8	1/4	2-3/4	3/4	18°		
SN-7	50075020	50121	50075027	50129	50075030	50137	3/4	1/4	2-5/8	5/8	30°		

*End cut

Edge Hog® Series SN Metric

Includes Micro Sizes

SCTI	Type of Cut						Dia.	Shank	OAL	Flute Length		Angle	
	Single		Double		Fine					L1	L2		A
	Tool No.	EDP	Tool No.	EDP	Tool No.	EDP							
SN-41M	69165020M	69541	69165027M	69549	69165030M	69557	2.4	3.0	38.0	3.0	10°		
SN-42M*	69170020EM	69563	69170027EM	69567	69170030EM	69571	3.0	3.0	38.0	4.8	10°		
SN-53M	72110020M	72245	72110027M	72253	72110030M	72261	4.8	3.0	38.0	6.4	10°		
SN-51M	70080020M	70185	70080027M	70193	70080030M	70201	6.4	3.0	44.0	6.4	10°		
SN-1M	50025020M	50005	50025027M	50013	50025030M	50021	6.0	6.0	50.0	8.0	10°		
SN-2M	50037520M	50053	50037527M	50061	50037530M	50069	9.5	6.0	55.0	9.5	13°		
SN-4M	50050020M	50077	50050027M	50085	50050030M	50093	12.7	6.0	58.0	12.7	28°		
SN-6M	50062520M	50101	50062527M	50109	50062530M	50117	16.0	6.0	64.0	19.0	18°		
SN-7M	50075020M	50125	50075027M	50133	50075030M	50141	19.0	6.0	61.0	16.0	30°		

*End cut



Edge Hog® Series 71 Sets

Inch and Millimeter sizes

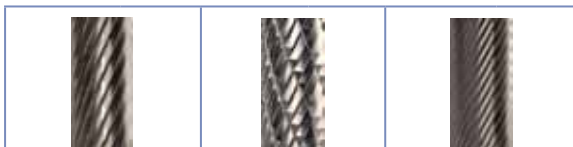

Specify type of cut when ordering.

Set No.	Type of Cut						Tools In Set
	Single		Double		Fine		
	Tool No.	EDP	Tool No.	EDP	Tool No.	EDP	
One	71010020	71001	71010027	71009	71010030	71017	SA-1, SC-1, SD-1, SG-1, SM-1
Two	71020020	71025	71020027	71033	71020030	71041	SA-43, SC-42, SD-42, SG-41, SM-45, SL-42
Three	71030020	71049	71030027	71057	71030030	71065	SA-43, SC-42, SC-41, SD-42, SE-41, SF-41, SG-41, SM-45, SL-42, SN-42
Four	71040020	71073	71040027	71081	71040030	71089	SA-51, SC-51, SD-51, SE-51, SF-51, SG-51, SM-51, SN-51

Set One

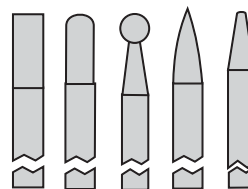

Inch: 1/4" Head/1/4" Shank

mm: 6mm Head/6mm Shank

Set No.	Type of Cut						Tools In Set (mm)
	Single		Double		Fine		
	Tool No.	EDP	Tool No.	EDP	Tool No.	EDP	
One	71010020M	71005	71010027M	71013	71010030M	71021	SA-1M, SC-1M, SD-1M, SG-1M, SM-1M
Two	71020020M	71029	71020027M	71037	71020030M	71045	SA-43M, SC-42M, SD-42M, SG-41M, SM-45M, SL-42M
Three	71030020M	71053	71030027M	71061	71030030M	71069	SA-43M, SC-41M, SC-42M, SD-42M, SE-41M, SF-41M, SG-41M, SM-45M, SL-42M, SN-42M
Four	71040020M	71077	71040027M	71085	71040030M	71093	SA-51M, SC-51M, SD-51M, SE-51M, SF-51M, SG-51M, SM-51M, SN-51M

Set Two

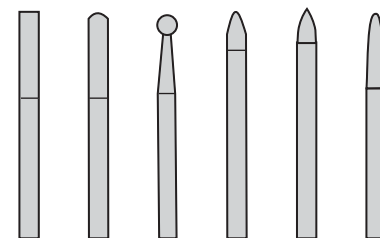

Inch: 1/8" Head/1/8" Shank

mm: 3mm Head/3mm Shank

Set Three

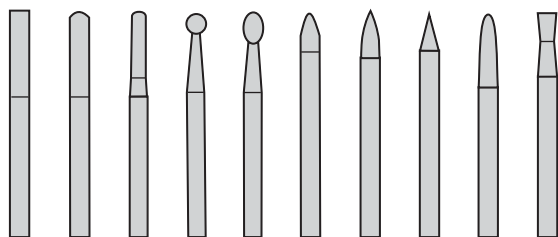

Inch: 1/8" Head/1/8" Shank

mm: 3mm Head/3mm Shank

Set Four

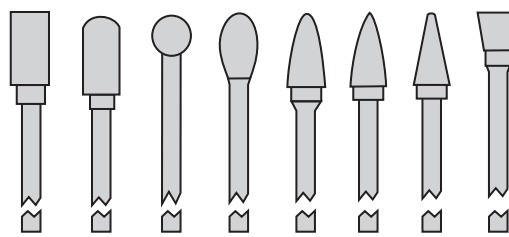

Inch: 1/4" Head/1/8" Shank

mm: 6.4mm Head/3mm Shank



Bur Troubleshooting Chart																			
Problem	Possible Solution																		
	Excessive Force	Heat From Rubbing Shank	Dull Tool	Improper Location In Collet	Bad Grinder Bearings	Bent Shank	Unstable Control of Process	Use Coarser Bur	Working in Soft Material	Use Anti-Stick Agent	Faster RPM	Slower RPM	Lighter Cuts	Switch to Fine Cut	Don't Use Double Grind	Faster Feed	Slower Feed	Cutting Abrasive Materials	Lacking Rigid Setup
Broken Braze	x	x	x																
Chatter No Control				x	x	x	x												x
Plugged Flutes								x	x	x	x	x	x						
Excessive Vibration				x	x	x	x			x	x				x	x			x
Poor Finish				x	x	x	x			x	x		x	x	x				x
Poor Life		x		x	x	x	x			x	x			x	x	x	x	x	x

Bur Fluting Chart Number of Flutes-zn (±10%)				
Tool Diameter		Single Cut	Fine Cut	Shear Cut
Inch	mm			
1/16	1.6	10	12	
5/64	2.0	10	12	
3/32	2.4	12	16	
1/8	3.0	12	20	
5/32	4.0	14	24	
3/16	4.8	15	24	
1/4	6.0	16	25	
5/16	8.0	18	30	
3/8	9.5	20	30	6
7/16	11.0	22	30	
1/2	12.7	24	35	8*
5/8	16.0	26	40	8**
3/4	19.0	30	40	
1	25.0	35	45	

Double (Alternate Diamond) Grind left hand fluting 40% of right hand fluting.
 Diamond Grind left hand fluting 80% of right hand fluting.
 *except SL-4NF and SL-4NFM 6 flutes
 **except SD-6NF, SD-6NFM, SE-6NF, SE-6NFM, SF-6NF and SF-6NFM 10 flutes

Operating Parameters			
Bur Tool Diameter		vc	
		1,500 SFM	3,000 SFM
		460 m/min.	920 m/min.
Inch	mm	RPM (n)	
1/8	3.0	45,000	90,000
1/4	6.0	23,000	45,000
3/8	9.5	15,000	30,000
1/2	12.7	11,000	22,000
3/4	19.0	7,500	15,000
1	25.0	5,500	10,000

Speeds and Feeds

Carbide burs should typically be operated between 1,500 and 3,000 SFM (460-920 m/min.). For burs ranging in size from 3/16" (4.8mm) to 3/8" (9.5mm) diameter, a 30,000 RPM (n) grinder is recommended. A 22,000 RPM (n) grinder will work effectively with burs ranging in size from 1/4" (6mm) to 1/2" (12.7mm) in diameter. Solid carbide burs that are 1/8" (3mm) diameter or less, can typically be run at speeds up to 75,000 RPM (n). However, these are general speed recommendations that may need to be adjusted.

For application questions, call **800-553-8024**.

Safety Note

Always wear the appropriate personal protective equipment such as safety glasses and protective clothing when using solid carbide or HSS cutting tools. Machines should be fully guarded. Technical data provided should be considered advisory only as variations may be necessary depending on the particular application.

Technical data provided should be considered advisory only as variations may be necessary depending on the particular application.

For product information, call your local distributor.

RED BOX

Factory Reconditioning Service

Extend the life of your cutting tools with M.A. Ford®'s
Factory Reconditioning / Recoating Service.



SAVE

and

Go Green

with



**Drills
End Mills
Countersinks
Burs**

Simplified Pricing Structure.

No Minimum Order Value.

Original Coatings.

M.A. Ford® Quality Workmanship.

Tools Reground to Factory Specifications.

Quick Turnaround.

RETURN • RECONDITION • REDUCE COST

www.maford.com/reconditioning for details.

800-553-8024 • 563-391-6220

Diamond Coated Routers The “Black Diamond”

Series 239

- GemX coating and uncoated options available
- Up cut router
- Excellent for composite materials and fiberglass applications

Diamond Grind Routers

Series 230CE / 231CE / 231BCE / 231DCE

Featuring **CERAE** coating

- Down cut routers
- Excellent for glass reinforced printed circuit boards, phenolic–epoxy and other highly abrasive materials

Diamond Grind Routers

Series 230 / 231 / 231B / 231D / 231F

- Uncoated
- Down cut routers
- Excellent for glass reinforced printed circuit boards, phenolic–epoxy and other highly abrasive materials

Routers are available with a non-cutting safe end or in three popular end-cutting styles.



M.A. Ford®'s New Diamond Coated Routers

Series 239 Coated with GemX Diamond Coating

M.A. Ford® Coating	M.A. Ford® Tool Number Designation	Microhardness (HV)	Maximum Service Temp.	Friction Coefficient
GemX	GX	10,000	600° C / 1100° F	0.10

Benefits

- Excellent for composite materials and fiberglass applications
- Long Tool life
- Cut more linear inches
- Faster cycle times
- High routing rate
- Delivers great edge quality
- No delamination or flaking

Features

- Rake angles specially designed to reduce cutting forces
- Cutting edges specially treated for optimized tool life
- Carbide substrate uniquely compatible to GemX coating
- GemX coating specifically designed for maximum tool life in composites

Applications

- Trimming
- Routing
- Pocketing
- Interpolation of holes
- Low plastic content CFRP

Series 239 Case Studies

Roughing	
Tool:	0.5" 14-Flute Router 0.5"Ø x 1" LOC x 3" OAL
Chuck:	HSK63A Haimer Shrink Fit Chuck P/N A63.140.1/2Z
Spindle Speed:	12,000 RPM
Feed Rate:	2,500 mm/min (98in/min)

Finishing	
Tool:	0.5" 14-Flute Router 0.5"Ø x 1" LOC x 3" OAL
Chuck:	HSK63A Haimer Shrink Fit Chuck P/N A63.140.1/2Z
Spindle Speed:	15,000 RPM
Feed Rate:	3,000 mm/min (118in/min)

Diamond Grind Routers Series 239



Diamond grind GemX coated or uncoated

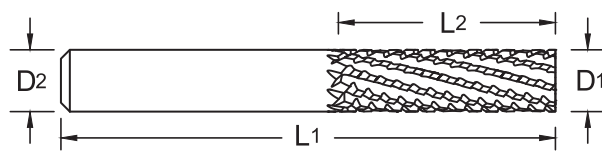

Bur End



End Mill



Safe End



Fishtail

Uncoated		GemX		Diameter			Shank		OAL		Flute Length		# Flutes (RHC)	End Cut
Tool Number	EDP	Tool Number	EDP	D1			D2		L1		L2			
				Inch	mm	Decimal	Inch	mm	Inch	mm	Inch	mm		
239M0300	24039				3.0	.1181		3.0		38		12.0	6	Safe
239M0300B	23945	239M0300BGX	23969		3.0	.1181		3.0		38		12.0	6	Bur
239M0300E	23946	239M0300EGX	23970		3.0	.1181		3.0		38		12.0	6	End Mill
239M0300F	23947	239M0300FGX	23971		3.0	.1181		3.0		38		12.0	6	Fishtail
23912500	23994			1/8		.1250	1/8		1-1/2		1/4		6	Safe
23912500B	23901	23912500BGX	23900	1/8		.1250	1/8		1-1/2		1/4		6	Bur
23912510	23996			1/8		.1250	1/8		1-1/2		3/8		6	Safe
23912510E	23903	23912510EGX	23902	1/8		.1250	1/8		1-1/2		3/8		6	End Mill
23912520	23997			1/8		.1250	1/8		1-1/2		1/2		8	Safe
23912520E	23905	23912520EGX	23904	1/8		.1250	1/8		1-1/2		1/2		8	End Mill
239M0400	24021				4.0	.1575		4.0		50		15.0	6	Safe
239M0400B	23948	239M0400BGX	23972		4.0	.1575		4.0		50		15.0	6	Bur
239M0400E	23949	239M0400EGX	23973		4.0	.1575		4.0		50		15.0	6	End Mill
239M0400F	23950	239M0400FGX	23974		4.0	.1575		4.0		50		15.0	6	Fishtail
23918700	23998			3/16		.1875	3/16		2		3/8		6	Safe
23918700B	23907	23918700BGX	23906	3/16		.1875	3/16		2		3/8		6	Bur
23918710	23999			3/16		.1875	3/16		2		9/16		6	Safe
23918710E	23909	23918710EGX	23908	3/16		.1875	3/16		2		9/16		6	End Mill
23918720	24000			3/16		.1875	3/16		2		3/4		8	Safe
23918720E	23911	23918720EGX	23910	3/16		.1875	3/16		2		3/4		8	End Mill
239M0500	24041				5.0	.1968		5.0		50		20.0	6	Safe
239M0500B	23951	239M0500BGX	23975		5.0	.1968		5.0		50		20.0	6	Bur
239M0500E	23952	239M0500EGX	23976		5.0	.1968		5.0		50		20.0	6	End Mill
239M0500F	23953	239M0500FGX	23977		5.0	.1968		5.0		50		20.0	6	Fishtail
239M0600	24043				6.0	.2362		6.0		63		20.0	10	Safe
239M0600B	23954	239M0600BGX	23978		6.0	.2362		6.0		63		20.0	10	Bur
239M0600E	23955	239M0600EGX	23979		6.0	.2362		6.0		63		20.0	10	End Mill
239M0600F	23956	239M0600FGX	23980		6.0	.2362		6.0		63		20.0	10	Fishtail
239M0601	24027				6.0	.2362		6.0		75		25.0	10	Safe
239M0601B	23957	239M0601BGX	23981		6.0	.2362		6.0		75		25.0	10	Bur
239M0601E	23958	239M0601EGX	23982		6.0	.2362		6.0		75		25.0	10	End Mill
239M0601F	23959	239M0601FGX	23983		6.0	.2362		6.0		75		25.0	10	Fishtail
23925000	24001			1/4		.2500	1/4		2-1/2		1/2		8	Safe
23925000B	23913	23925000BGX	23912	1/4		.2500	1/4		2-1/2		1/2		8	Bur

*Stock available for desired end features with a quicker turnaround than most manufacturing suppliers!



Series 239 Continued

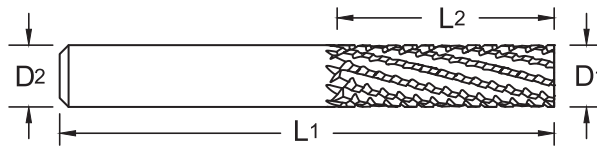

Uncoated		GemX		Diameter			Shank		OAL		Flute Length		# Flutes (RHC)	End Cut
Tool Number	EDP	Tool Number	EDP	D1			D2		L1		L2			
				Inch	mm	Decimal	Inch	mm	Inch	mm	Inch	mm		
23925010	24003			1/4		.2500	1/4		2-1/2		3/4		10	Safe
23925010B	23915	23925010BGX	23914	1/4		.2500	1/4		2-1/2		3/4		10	Bur
23925010E	23917	23925010EGX	23916	1/4		.2500	1/4		2-1/2		3/4		10	End Mill
23925020	24005			1/4		.2500	1/4		3		1		10	Safe
23925020B	23919	23925020BGX	23918	1/4		.2500	1/4		3		1		10	Bur
23925020E	23921	23925020EGX	23920	1/4		.2500	1/4		3		1		10	End Mill
23925030	23923	23925030GX	23922	1/4		.2500	1/4		4		1-1/4		12	Safe
23931200	24009			5/16		.3125	5/16		2 1/2		1		10	Safe
23931200E	23925	23931200EGX	23924	5/16		.3125	5/16		2-1/2		1		10	End Mill
239M0800	24045				8.0	.3150		8.0		75		25.0	10	Safe
239M0800B	23960	239M0800BGX	23984		8.0	.3150		8.0		75		25.0	10	Bur
239M0800E	23961	239M0800EGX	23985		8.0	.3150		8.0		75		25.0	10	End Mill
239M0800F	23962	239M0800FGX	23986		8.0	.3150		8.0		75		25.0	10	Fishtail
23937500	24011			3/8		.3750	3/8		2-1/2		3/4		12	Safe
23937500B	23927	23937500BGX	23926	3/8		.3750	3/8		2-1/2		3/4		12	Bur
23937510	24035			3/8		.3750	3/8		3		1-1/8		12	Safe
23937510B	23929	23937510BGX	23928	3/8		.3750	3/8		3		1-1/8		12	Bur
23937510E	23931	23937510EGX	23930	3/8		.3750	3/8		3		1-1/8		12	End Mill
23937520	24015			3/8		.3750	3/8		4		1-1/2		12	Safe
23937520B	23933	23937520BGX	23932	3/8		.3750	3/8		4		1-1/2		12	Bur
23937520E	23935	23937520EGX	23934	3/8		.3750	3/8		4		1-1/2		12	End Mill
23937530	23937	23937530GX	23936	3/8		.3750	3/8		4		2		12	Safe
239M1000	24047				10.0	.3937		10.0		90		30.0	12	Safe
239M1000B	23963	239M1000BGX	23987		10.0	.3937		10.0		90		30.0	12	Bur
239M1000E	23964	239M1000EGX	23988		10.0	.3937		10.0		90		30.0	12	End Mill
239M1000F	23965	239M1000FGX	23989		10.0	.3937		10.0		90		30.0	12	Fishtail
239M1200	24033				12.0	.4724		12.0		100		40.0	14	Safe
239M1200B	23966	239M1200BGX	23990		12.0	.4724		12.0		100		40.0	14	Bur
239M1200E	23967	239M1200EGX	23991		12.0	.4724		12.0		100		40.0	14	End Mill
239M1200F	23968	239M1200FGX	23992		12.0	.4724		12.0		100		40.0	14	Fishtail
23950000	24037			1/2		.5000	1/2		3		1		14	Safe
23950000B	23939	23950000BGX	23938	1/2		.5000	1/2		3		1		14	Bur
23950000E	23941	23950000EGX	23940	1/2		.5000	1/2		3		1		14	End Mill
23950010	23943	23950010GX	23942	1/2		.5000	1/2		4		2		16	Safe
23950010B	23993	23950010BGX	23944	1/2		.5000	1/2		4		2		16	Bur

*Stock available for desired end features with a quicker turnaround than most manufacturing suppliers!



Diamond Grind Routers Series 239

Recommended Cutting Data - Inch

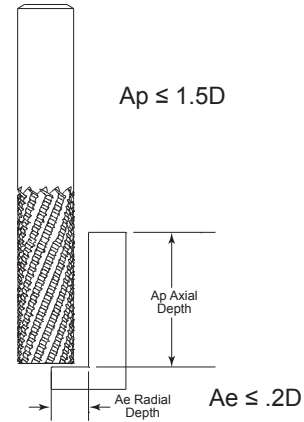
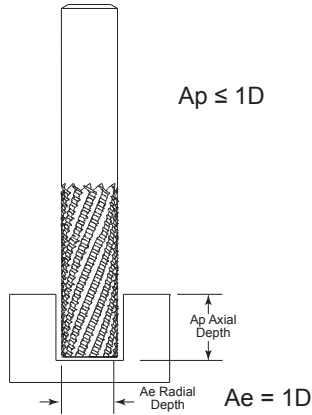

Slotting 300 (Sfm)		
Tool Diameter	RPM	IPM
1/8	9000	10
3/16	6000	12
1/4	5000	15
5/16	4000	18
3/8	3000	20
1/2	2000	25

Slotting 600 (Sfm)		
Tool Diameter	RPM	IPM
1/8	18000	20
3/16	12000	25
1/4	9000	30
5/16	7000	35
3/8	6000	40
1/2	5000	50

Feed adjustment to part thickness	
≤ 0.5D	x 150%
0.5D - 1D	x 120%
1D - 2D	x 80%
3D-4D	x 50%

Side Milling 400 (Sfm)		
Tool Diameter	RPM	IPM
1/8	12000	20
3/16	8000	25
1/4	6000	30
5/16	5000	35
3/8	4000	40
1/2	3000	50

Side Milling 800 (Sfm)		
Tool Diameter	RPM	IPM
1/8	24000	40
3/16	16000	50
1/4	12000	60
5/16	10000	70
3/8	8000	80
1/2	6000	100

** Tool must have end grind to slot.

Note: The parameters in this table are for common material thickness of 1/4". You must use the Radial Depth (Ae) of 20% or less for Side Milling. For best surface finish conventional mill is recommended. Higher feed rates are possible but surface finish may change.

Recommended Cutting Data - Metric

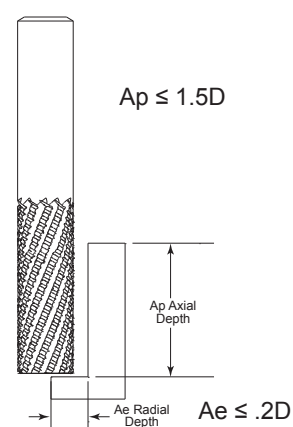
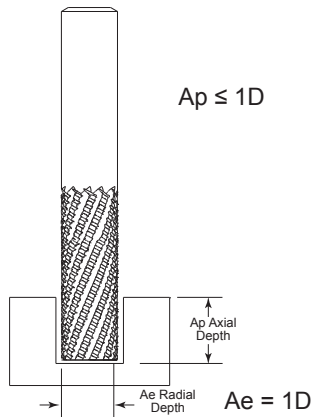

Slotting 90 (m/min)		
Tool Diameter	RPM	mm/min
3	9000	254
5	6000	304
6	5000	381
8	4000	457
10	3000	508
12	2000	635

Slotting 182 (m/min)		
Tool Diameter	RPM	mm/min
3	18000	508
5	12000	635
6	9000	762
8	7000	889
10	6000	1016
12	5000	1270

Feed adjustment to part thickness	
≤ 0.5D	x 150%
0.5D - 1D	x 120%
1D - 2D	x 80%
3D-4D	x 50%

Side Milling 120(m/min)		
Tool Diameter	RPM	mm/min
3	12000	508
5	8000	635
6	6000	762
8	5000	889
10	4000	1016
12	3000	1270

Side Milling 240 (m/min)		
Tool Diameter	RPM	mm/min
3	24000	1016
5	16000	1270
6	12000	1524
8	10000	1778
10	8000	2032
12	6000	2540

** Tool must have end grind to slot.

Note: The parameters in this table are for common material thickness of 6mm. You must use the Radial Depth (Ae) of 20% or less for Side Milling. For best surface finish conventional mill is recommended. Higher feed rates are possible but surface finish may change.

Technical data provided should be considered advisory only as variations may be necessary depending on the particular application.

**CERAedge® Coated Routers
Diamond Grind Routers
Series 230CE / 231CE
231BCE / 231DCE**

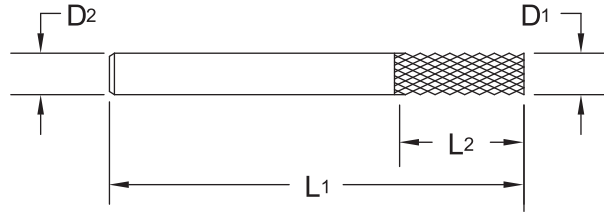

Diamond Grind

- Designed for routing of glass-reinforced printed circuit boards, phenolic-epoxy, composites and other highly abrasive materials.
- Ultra fine micrograin carbide.

Series 230CE

Down Cut
Safe End



Series 231CE

Down Cut
End Mill Type Point



Series 231BCE

Down Cut
Bur End Point



Series 231DCE

Down Cut
Drill Point



Series 230CE		Series 231CE		Diameter			Shank		OAL		Flute Length	
Tool No.	EDP	Tool No.	EDP	D1			D2		L1		L2	
				Inch	mm	Decimal	Inch	mm	Inch	mm	Inch	mm
23011810CE	90839	23111810CE	91047		3.0	.1181		3.0		38		12.5
23012500CE	90845	23112500CE	91071	1/8		.1250	1/8		1-1/2		1/2	
23018750CE	90847	23118750CE	91082	3/16		.1875	3/16		2		5/8	
23019680CE	90850	23119680CE	91094		5.0	.1968		5.0		51		16.0
23023620CE	90853	23123620CE	91106		6.0	.2362		6.0		51		19.0
23025010CE	90859	23125010CE	91130	1/4		.2500	1/4		2-1/2		3/4	

Series 231BCE		Series 231DCE		Diameter			Shank		OAL		Flute Length	
Tool No.	EDP	Tool No.	EDP	D1			D2		L1		L2	
				Inch	mm	Decimal	Inch	mm	Inch	mm	Inch	mm
23111810BCE	91050	23111810DCE	91053		3.0	.1181		3.0		38		12.5
23112500BCE	91074	23112500DCE	91077	1/8		.1250	1/8		1-1/2		1/2	
23118750BCE	91085	23118750DCE	91088	3/16		.1875	3/16		2		5/8	
23119680BCE	91097	23119680DCE	91100		5.0	.1968		5.0		51		16.0
23123620BCE	91109	23123620DCE	91112		6.0	.2362		6.0		51		19.0
23125010BCE	91133	23125010DCE	91136	1/4		.2500	1/4		2-1/2		3/4	

Routers are available with color coded depth setting rings upon request for 1/8" shanks.



**CERAedge® Coated Routers
Diamond Grind Routers
Series 230CE / 231CE
231BCE / 231DCE**

230CE / 231CE / 231BCE / 231DCE

Diamond Grind Routers

Recommended Cutting Data - Inch

Slotting 300 (Sfm)			Slotting 600 (Sfm)		
Tool Diameter	RPM	IPM	Tool Diameter	RPM	IPM
1/32	36000	29	1/32	73000	58
3/64	24000	24	3/64	48000	48
1/16	18000	27	1/16	36000	54
3/32	12000	24	3/32	24000	48
1/8	9100	22	1/8	18000	45
3/16	6100	18	3/16	12000	36
1/4	4500	16	1/4	9000	32
5/16	3600	14	5/16	7000	28

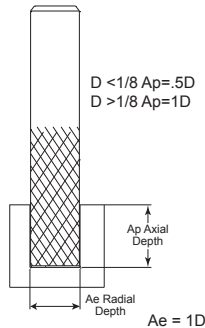

Side Milling 400 (Sfm)			Side Milling 900 (Sfm)		
Tool Diameter	RPM	IPM	Tool Diameter	RPM	IPM
1/32	48000	39	1/32	90000	72
3/64	32000	32	3/64	73000	73
1/16	24000	36	1/16	55000	83
3/32	16000	32	3/32	36000	72
1/8	12000	30	1/8	27000	68
3/16	8100	24	3/16	18000	54
1/4	6100	21	1/4	13000	46
5/16	4800	19	5/16	11000	44

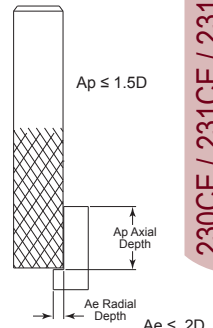

** Tool must have end grind in order to slot.

Note: The parameters in this table are for common material thickness of 1/4". You must use the Radial Depth (Ae) of 20% or less for Side Milling. For best surface finish conventional mill is recommended. Higher feed rates are possible but surface finish may change.

Recommended Cutting Data - Metric

Slotting 90 (m/min)			Slotting 182 (m/min)		
Tool Diameter	RPM	mm/min	Tool Diameter	RPM	mm/min
0.8	35000	141	0.8	72000	289
1	28000	226	1	57000	463
1.2	23000	306	1.2	48000	627
1.5	18000	376	1.5	38000	771
1.6	17000	388	1.6	36000	795
2	14000	423	2	28000	868
2.4	11000	447	2.4	24000	916
3	9400	480	3	19000	984
5	5600	395	5	11000	810
6	4700	423	6	9600	868
8	3500	353	8	7200	723

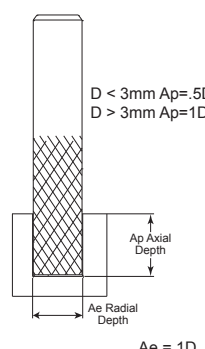

Side Milling 120(m/min)			Side Milling 240 (m/min)		
Tool Diameter	RPM	mm/min	Tool Diameter	RPM	mm/min
0.8	47000	190	0.8	95000	381
1	38000	305	1	76000	610
1.2	31000	413	1.2	63000	826
1.5	25000	508	1.5	50000	1017
1.6	23000	524	1.6	47000	1049
2	19000	572	2	38000	1145
2.4	15000	604	2.4	31000	1208
3	12000	648	3	25000	1297
5	7600	534	5	15000	1068
6	6300	572	6	12000	1145
8	4700	477	8	9500	954

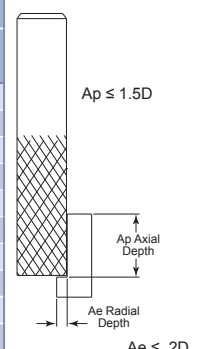

** Tool must have end grind in order to slot.

Note: The parameters in this table are for common material thickness of 6mm. You must use the Radial Depth (Ae) of 20% or less for Side Milling. For best surface finish conventional mill is recommended. Higher feed rates are possible but surface finish may change.



Made in USA

ISO 9001:2008 Certified

Safety Note

Always wear the appropriate personal protective equipment such as safety glasses and protective clothing when using solid carbide or HSS cutting tools. Machines should be fully guarded.

Technical data provided should be considered advisory only as variations may be necessary depending on the particular application.

Diamond Grind Routers

Diamond Grind Routers are designed specifically for routing printed circuit boards. These tools are available with a non-cutting safe end, or in four popular end-cutting styles all with down cut geometries.

Router Application Data

When machining circuit boards, board stack height should be limited to 2-1/2 times the router diameter. In general, as total stack height increases, cutting speed RPM (n) should be decreased.

Polyamid or Teflon circuit boards should not be stacked.

When routing outside edges, the router should be fed counterclockwise. Conversely, for inside edges, the router should be fed clockwise.

Speeds and Feeds

Diamond Grind Routers are designed to operate between 600 and 900 surface-feet-per-minute (180-275 vc-m/min) - Approximately 30,000 RPM (n) for a 3/32-inch (2.4mm) router and 23,000 RPM (n) for a 1/8-inch (3.175mm) router. Speeds must be reduced for Teflon circuit boards. See recommended cutting data charts on page 464.

Diamond Grind Routers should be fed approximately .002 inch-per-revolution (.05 mm/rev.). For a 3/32-inch (2.4mm) router, this is 60-80 IPM (1524-2032 mm/min.). A 1/8-inch (3.175mm) router should be fed approximately 40-50 IPM (1016-1270 mm/min.). See recommended cutting data charts on page 464.

If the feed rate is too low, heat will cause melting of epoxy materials, causing the router flutes to load up, reducing tool life. For multi-layer boards, feed rates should be reduced, depending on the number of inner layers. The higher the number of inner layers, the slower the feed rate must be. See recommended cutting data charts on page 464.

Safety Note

Always wear the appropriate personal protective equipment such as safety glasses and protective clothing when using solid carbide or HSS cutting tools. Machines should be fully guarded.

Technical data provided should be considered advisory only as variations may be necessary depending on the particular application.

Diamond Grind Routers Series

Series 230

Series 231

Series 231B

Series 231D

Series 231F

ISO 9001:2008 Certified



Diamond Grind Routers

Series 230 / 231

231B / 231D / 231F

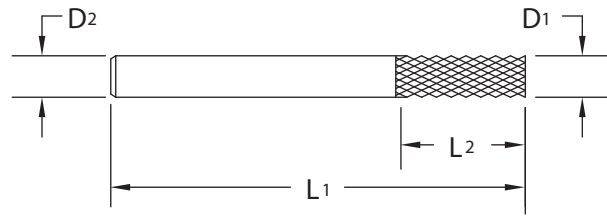

Designed for routing of glass-reinforced printed circuit boards, phenolic-epoxy and other highly abrasive materials.

Series 230

Down Cut
Safe End



- Ultra fine micrograin carbide.
- Routers are available with color coded depth setting rings upon request.

Series 231

Down Cut
End Mill Type Point



Series 231B

Down Cut
Bur End Point



Series 231D

Down Cut
Drill Point



Series 231F

Down Cut
Fishtail Point



Page 464

Series 230		Series 231		Series 231B		Series 231D		Series 231F		Diameter			Shank		OAL		Flute Length	
Tool No.	EDP	Tool No.	EDP	Tool No.	EDP	Tool No.	EDP	Tool No.	EDP	D1			D2		L1		L2	
										Inch	mm	Decimal	Inch	mm	Inch	mm	Inch	mm
23003120	90801	23103120	90901	23103120B	90904	23103120D	90907	23103120F	90910	1/32		.0312	1/8		1-1/2		1/8	
23003150	90804	23103150	90913	23103150B	90916	23103150D	90919	23103150F	90922		0.8	.0315		3.175		38		3.0
23003940	90807	23103940	90925	23103940B	90928	23103940D	90931	23103940F	90934		1.0	.0394		3.175		38		4.0
23004690	90810	23104690	90937	23104690B	90940	23104690D	90943	23104690F	90946	3/64		.0469	1/8		1-1/2		5/32	
23004720	90813	23104720	90949	23104720B	90952	23104720D	90955	23104720F	90958		1.2	.0472		3.175		38		4.0
23005910	90816	23105910	90961	23105910B	90964	23105910D	90967	23105910F	90970		1.5	.0591		3.000		38		5.0
23005911	90819	23105911	90973	23105911B	90976	23105911D	90979	23105911F	90982		1.5	.0591		3.175		38		5.0
23006251	90822	23106251	90985	23106251B	90988	23106251D	90991	23106251F	90994	1/16		.0625	1/8		1-1/2		3/16	
23006300	90825	23106300	90997	23106300B	91000	23106300D	91003	23106300F	91006		1.6	.0630		3.175		38		5.0
23007870	90828	23107870	91009	23107870B	91012	23107870D	91015	23107870F	91018		2.0	.0787		3.175		38		8.0
23009370	90831	23109370	91021	23109370B	91024	23109370D	91027	23109370F	91030	3/32		.0937	1/8		1-1/2		3/8	
23009450	90834	23109450	91033	23109450B	91036	23109450D	91039	23109450F	91042		2.4	.0945		3.175		38		9.5
23011810	90837	23111810	91045	23111810B	91048	23111810D	91051	23111810F	91054		3.0	.1181		3.000		38		12.5
23011811	90840	23111811	91057	23111811B	91060	23111811D	91063	23111811F	91066		3.0	.1181		3.175		38		12.5
23012500	90843	23112500	91069	23112500B	91072	23112500D	91075	23112500F	91078	1/8		.1250	1/8		1-1/2		1/2	
23018750	90846	23118750	91081	23118750B	91084	23118750D	91087	23118750F	91090	3/16		.1875	3/16		2		5/8	
23019680	90849	23119680	91093	23119680B	91096	23119680D	91099	23119680F	91102		5.0	.1968		5.000		51		16.0
23023620	90852	23123620	91105	23123620B	91108	23123620D	91111	23123620F	91114		6.0	.2362		6.000		51		19.0
23025000	90855	23125000	91117	23125000B	91120	23125000D	91123	23125000F	91126	1/4		.2500	1/4		2		3/4	
23025010	90858	23125010	91129	23125010B	91132	23125010D	91135	23125010F	91138	1/4		.2500	1/4		2-1/2		3/4	
23025020	90861	23125020	91141	23125020B	91144	23125020D	91147	23125020F	91150	1/4		.2500	1/4		3		3/4	
23031250	90864	23131250	91153	23131250B	91156	23131250D	91159	23131250F	91162	5/16		.3125	5/16		2-1/2		7/8	
23031500	90867	23131500	91165	23131500B	91168	23131500D	91171	23131500F	91174		8.0	.3150		8.000		64		22.0
23037500	90870	23137500	91177	23137500B	91180	23137500D	91183	23137500F	91186	3/8		.3750	3/8		2-1/2		7/8	

Diamond Grind Routers Series 230 / 231 231B / 231D / 231F

Recommended Cutting Data - Inch

Slotting 300 (Sfm)			Slotting 600 (Sfm)		
Tool Diameter	RPM	IPM	Tool Diameter	RPM	IPM
1/32	36000	29	1/32	73000	58
3/64	24000	24	3/64	48000	48
1/16	18000	27	1/16	36000	54
3/32	12000	24	3/32	24000	48
1/8	9100	22	1/8	18000	45
3/16	6100	18	3/16	12000	36
1/4	4500	16	1/4	9000	32
5/16	3600	14	5/16	7000	28

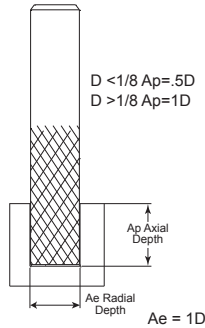

Side Milling 400 (Sfm)			Side Milling 900 (Sfm)		
Tool Diameter	RPM	IPM	Tool Diameter	RPM	IPM
1/32	48000	39	1/32	90000	72
3/64	32000	32	3/64	73000	73
1/16	24000	36	1/16	55000	83
3/32	16000	32	3/32	36000	72
1/8	12000	30	1/8	27000	68
3/16	8100	24	3/16	18000	54
1/4	6100	21	1/4	13000	46
5/16	4800	19	5/16	11000	44

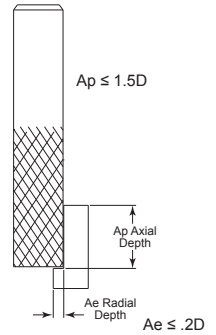

** Tool must have end grind in order to slot.

Note: The parameters in this table are for common material thickness of 1/4". You must use the Radial Depth (Ae) of 20% or less for Side Milling. For best surface finish conventional mill is recommended. Higher feed rates are possible but surface finish may change.

Recommended Cutting Data - Metric

Slotting 90 (m/min)			Slotting 182 (m/min)		
Tool Diameter	RPM	mm/min	Tool Diameter	RPM	mm/min
0.8	35000	141	0.8	72000	289
1	28000	226	1	57000	463
1.2	23000	306	1.2	48000	627
1.5	18000	376	1.5	38000	771
1.6	17000	388	1.6	36000	795
2	14000	423	2	28000	868
2.4	11000	447	2.4	24000	916
3	9400	480	3	19000	984
5	5600	395	5	11000	810
6	4700	423	6	9600	868
8	3500	353	8	7200	723

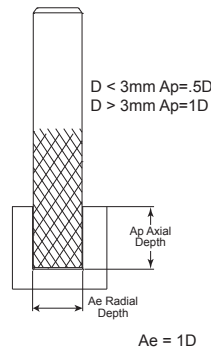

Side Milling 120(m/min)			Side Milling 240 (m/min)		
Tool Diameter	RPM	mm/min	Tool Diameter	RPM	mm/min
0.8	47000	190	0.8	95000	381
1	38000	305	1	76000	610
1.2	31000	413	1.2	63000	826
1.5	25000	508	1.5	50000	1017
1.6	23000	524	1.6	47000	1049
2	19000	572	2	38000	1145
2.4	15000	604	2.4	31000	1208
3	12000	648	3	25000	1297
5	7600	534	5	15000	1068
6	6300	572	6	12000	1145
8	4700	477	8	9500	954

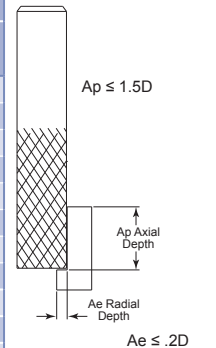

** Tool must have end grind in order to slot.

Note: The parameters in this table are for common material thickness of 6mm. You must use the Radial Depth (Ae) of 20% or less for Side Milling. For best surface finish conventional mill is recommended. Higher feed rates are possible but surface finish may change.



ISO 9001:2008 Certified

Safety Note

Always wear the appropriate personal protective equipment such as safety glasses and protective clothing when using solid carbide or HSS cutting tools. Machines should be fully guarded.

Technical data provided should be considered advisory only as variations may be necessary depending on the particular application.



ADVANCED PRODUCT GROUP

CERAedge[®]





CUSTOM Tool Division

Engineering & Manufacturing Excellence

The M.A. Ford® Custom Tool Division focuses on meeting the growing need for unique and increasingly complex special cutting tools. By partnering with select machine tool users the Custom Tool Division develops and supplies custom engineered carbide tools of unmatched quality which meet or exceed their productivity, delivery and utilized cost expectations. Custom tools are proven to increase speeds and feeds, save setup and handling time which in turn leads to faster run times, more efficient manufacturing and most importantly, **INCREASED PROFITS.**

To support your productivity improvement efforts, we offer the following services:

- Technical assistance in prototype custom tool design.
- Re-engineering of existing custom tooling to optimize tool performance.
- Tool manufacturing lead times which meet or exceed your delivery requirements.
- Immediate response to quotation request.
- Readily available technical phone support.
- Field representative support service.
- Emergency tool service.
- Custom tools of the highest quality.

Meeting the growing need for unique and increasingly complex high performance custom cutting tools in today's industry

We offer application development, design and manufacturing expertise in the following product classifications:

All tools in either Solid or Coolant Thru Configurations

- High Performance Drills and Step Drills
- Rockbit Drills (Flat Bottom - 150°)
- G-Drills and Step G-Drills
- Step Reamers
- Reamers
- Coolant Thru Specials
- Firearms Reamers (Chamber - Barrel - Muzzle - Throat)
- Custom End Mills
- Custom Form Tools

Call us today to increase your
productivity and profits with
Custom Tooling

1-877-522-2885

e-mail: customtools@maford.com

Stop Guessing. Start Knowing.

The BlueSwarf Dashboard™ is a revolutionary new product that dramatically improves the performance of milling using the science of machining dynamics. Dashboards™ control the dynamic frequencies and vibrations that limit milling operations and generate chatter.



EXPERT ANALYSIS - BlueSwarf Dashboards™ are a system of patented and proven services that begin with onsite measurements of your milling tools by M.A. Ford® and analysis by our staff of Ph.D.-level engineers. Interactive Dashboards™ are delivered for first time right and fully optimized machining.

- Eliminate Chatter
- Increase Metal Removal Rates
- Increase Tool Life
- Improve surface finishes
- Faster Set-Ups
- Reduce Energy Consumption

Fully interactive BlueSwarf Dashboards™ allow users, without extensive knowledge of chatter theory or mechanical vibrations, to take full advantage of the available improvements in process efficiency. BlueSwarf Dashboards™ allow process planners and programmers to select high-efficiency milling parameters for maximized material removal rates in a science-based pre-process manner, rather than relying on trial and error testing.

For more information on BlueSwarf Harmonics Analysis contact your local
M.A. Ford® Representative.

M.A. Ford® is an Authorized and Certified BlueSwarf Service Provider.



ISO 9001:2008 Certified



See something you would like to try?

Complete this form to request your FREE tool!*

Company Information:	
Company Name:	End User:
Requested By:	Contact Name:
Address:	Ship to Address:
City, State, Zip:	City, State, Zip:
Phone:	Phone: Ship Via:
Fax:	Fax:
e-mail Address:	e-mail Address:

Forms

M.A. Ford® Sales Rep.: _____

M.A. Ford® Trial Tool Requested:

Qty/Tool # _____

Qty/Tool # _____

Comments: _____

Additional Information:			
Application Description:			
Machine Type	Horizontal <input type="checkbox"/>	Vertical <input type="checkbox"/>	Other <input type="checkbox"/>
RPM		Horsepower	
Condition	Good <input type="checkbox"/>	Fair <input type="checkbox"/>	Poor <input type="checkbox"/>
Material:		Hardness	
Coolant?	Yes <input type="checkbox"/>	No <input type="checkbox"/>	Type

Current Tooling Appraisal:	
Current Tool:	
Mfg.	Part #
Feed Rate:	
RPM:	
Width/Depth of Cut:	
Hole Depth:	
No. Holes Produced:	
No. Parts Produced:	
Production Rate:	

*All requests subject to approval. An M.A. Ford® representative will contact you to discuss your application.

Please send this form to M.A. Ford® 7737 Northwest Blvd. Davenport, IA 52806 or
 Fax to: 800-892-9522 / 563-386-7660.
 Form available on line at www.maford.com

For product information, call your local distributor.

RED BOX

Factory Reconditioning Service

Extend the life of your cutting tools with M.A. Ford®'s
Factory Reconditioning / Recoating Service.



SAVE

and

Go Green

with



**Drills
End Mills
Countersinks
Burs**

Simplified Pricing Structure.

No Minimum Order Value.

Original Coatings.

M.A. Ford® Quality Workmanship.

Tools Reground to Factory Specifications.

Quick Turnaround.

RETURN • RECONDITION • REDUCE COST

www.maford.com/reconditioning for details.

800-553-8024 • 563-391-6220

QUALITY



The M.A. Ford® Quality Policy is:

- Know our customers.
- Know their requirements.
- Make continual improvements in satisfying those requirements.

These are the responsibilities of every individual who works at M.A. Ford®.



Steve Morency, CEO



Coatings

ALtima®

Aluminum Titanium Nitride (AlTiN). ALtima® is the original high performance coating. This coating allows tools to be run at higher speeds and feeds in a wide array of materials. Also, it allows the option of running tools dry due to the high oxidation temperature of the coating.

ALtima® Plus

This Aluminum Titanium Nitride (AlTiN) multi-layer coating has optimized coating structure, with pre and post treatment of the coating for optimized high performance drilling in any ferrous material.

ALtima® 52

Aluminum Titanium Nitride (AlTiN). ALtima® 52 is specially designed for milling hardened steels 52 Rc and above. It has very high hardness and the oxidation temperature of the coating makes this the absolute best choice for hardened steel milling. ALtima® 52 is designed to allow for dry machining.

ALtima® Blaze

Aluminum Chromium Nitride (AlCrN). ALtima® Blaze is designed to allow higher material removal rates. This coating has a higher oxidation temperature than a typical TiAlN coating. It has shown very good results in nickel alloys, titanium, and other difficult to machine materials. Tools coated with ALtima® Blaze can be used in dry machining.

ALtima® Micro

An ultra thin, nano structured, TiAlN coating developed specifically for micro tool applications.

Fordlube

Titanium DiBoride (TiB₂) is a unique coating with low Aluminum affinity, smooth surface finish and high hardness. It is ideal for Aluminum and Magnesium alloys as it prevents build-up on cutting edge, provides superior chip flow along with extended wear resistance.

GemX

A CVD diamond coating for composites and aluminum that offers the maximum hardness and wear resistance of any of our coatings.

TiN

Titanium Nitride (TiN). TiN coating has shown good results in low carbon steels and many iron-based applications. It is a very popular coating used in the industry today.

TiCN

Titanium Carbonitride (TiCN). TiCN is a multi-layer coating. Because of the multi-layer composition, TiCN is tougher than TiN, even though TiCN is harder. The added toughness of the TiCN coating makes it a good choice for mechanically stressed edges like in end mill applications. The higher hardness makes TiCN a good choice for abrasive applications where higher wear resistance is required.

CERAEedge®

CERAEedge® is a unique coating that provides excellent performance in titanium, aluminium, and composites.

HP AlTiN

An economical version of Aluminum Titanium Nitride (AlTiN). This coating provides the benefits of AlTiN with a lower overall cost.

Special Coatings

Upon request, M.A. Ford® can provide any commercially available coating. Any standard M.A. Ford® cutting tool can be provided with coating if requested.

Coating Properties

M.A. Ford® Coating	M.A. Ford® Tool Number Designation	Microhardness (HV)	Maximum Service Temp.	Friction Coefficient
ALtima®	A	3100	1100° C / 2012° F	0.42
ALtima® Plus	AP	3200	1100° C / 2012° F	0.25
ALtima® 52	A	3600	1200° C / 2192° F	0.40
ALtima® Blaze	B	3200	1100° C / 2012° F	0.35
ALtima® Micro	AM	3300	900° C / 1652° F	0.30-0.35
Fordlube	F	4000	700° C / 1292° F	0.30
GemX	GX	10000	600° C / 1100° F	0.10
TiN	T	2300	600° C / 1112° F	0.40
TiCN	C	3000	400° C / 752° F	0.40
CERAEedge®	CE	3400	1100° C / 2012° F	0.25
HP AlTiN	A	3000	927° C / 1700° F	0.25

CERAedge®

Ceramic Coating with Extreme Properties

- Hardness that makes it the 3rd hardest material when compared to industrial diamonds.
- Toughness that is comparable to Titanium.
- Lubricity that approaches Teflon.
- Extreme heat tolerance.
- Non-reactive to Titanium.

Coating Properties

M.A. Ford® Coating	Microhardness (HV)	Maximum Service Temp.	Friction Coefficient	Coating Thickness	Color
CERAedge®	3400	1100° C / 2012° F	.25	2-3 Microns	Light Gray

CERAedge® Applications

Titanium-clad composite material:

Hardness and lubricity ideal for composites
 Toughness that allows excellent machining of Titanium
 CERAedge® is perfect for machining of Titanium-clad composites!

Aluminum and high silicon aluminum materials:

Hardness and lubricity extend tool life by increasing wear and resistance.









See Standard Offering of these Products with CERAedge® coating		See Page
138CE	Series End Mills	235
207CE	Brad and Spur Point Drill	75
230CE	Safe End Diamond Grind Router	460
231CE	End Mill End Diamond Grind Router	460
231BCE	Bur End Diamond Grind Router	460
231DCE	Drill Point Diamond Grind Router	460

Test Data

Material Machined: 6061 Aluminum Extrusion
 M.A. Ford® Tool: 138 Series, 3 Flute End Mill, 1/2" (12.7mm) OD
 RPM: 22,000 RPM
 IPM: 300 (7,620 mm/minute)









	Competitor's Lubricious Coating	M.A. Ford® CERAedge® Coated
Parts Produced/Tool	5	42
Linear Inches/Tool (Linear m/tool)	10,690 (272)	92,976 (2,360)

Material Conversion Chart

								
	USA	France	Brazil	German W-nr	German DIN	UK	Spain	Japan JIS
FREE MACHINING STEEL	12L13	S250Pb		1.0718	9SMnPb28		F.2112 -	
	1108	10F1		1.0721	10S20	210M15	F.2121 -	
	11L08	10PbF2		1.0722	10SPb20		F.2122 -	
	1215	S300	1215	1.0723	15S20	210A15	F.210F.	
	12L14	S300Pb		1.0736	9SMn36	240M07 EN 1B	F.2113-	
			1.0737	9MnPb36			F.2114 -	
LOW CARBON STEEL	1010	AF34C10/XC10	1010	1.0301	C10	045M10		
	1015	AF37C12/XC18	1015	1.0401	C15	080M15;040A15	F.111	
	1020	AF42C20/XC25	1020	1.0402	C22	055M15 EN2C	F.112	
	1025	AF50C30		1.0406	C25	070M26	F.221	
	1212			1.0711	9S20	220M07		
	1213	S250	1213	1.0715	9SMn28	230M07	F.2111 -	
	1010	XC10	1010	1.1121	Ck10	040A10	F.1510 -	
	1022/1518	20M5		1.1133	20Mn5	120M19	F.1515 -	
	1015	XC15 / C15E	1015	1.1141	Ck15	080M15 EN 32C	F.1511 -	
	1020/1023	XC25 / C22E	1020	1.1151	Ck22	050A20	F.1120 -	
	1025	XC25 / C25E		1.1158	Ck25	070M26	F.1120 -	
	A350-LF5	15N6 / 15Ni6		1.5622	14Ni6		F.2641 -	
	3310/9314	12NC15		1.5752	14NiCr14	655M13/A12 EN 36A		
MEDIUM CARBON STEEL	1035	AF55C35 /XC38	1035	1.0501	C35	060A35	F.113	
	1045	AF65C45 /C45	1045	1.0503	C45	080M46	F.114	
	1040	AF60C40 /C40	1040	1.0511	C40		F.114.A	
	1055	C55	1055	1.0535	C55	070M55		
	1060	AF70C55 / C60	1060	1.0601	C60	080A62 EN 43D	F.115	
	1140	35MF6	1140	1.0726	35S20	212M36 EN 8M	F.210G.	
	1146	45MF4		1.0727	45S20	212M44		
	9255	51S7		1.0903	51Si7	250A53 EN 45	F.1450 -	
	9255	55S7	9254	1.0904	55Si7		F.1440-	
	9260	60S7		1.0909	60Si7	250A58	F.1441 -	
	9262	60SC7		1.0961	60SiCr7	250A61	F.1442 -	
	1330/1536	35M5 / 30Mn5		1.1165/66	30Mn5/34Mn5	120M36/150M28	F.1203	
	1335	40M5 / 36Mn5	1541	1.1167	36Mn5	150M36 EN 15	F.1203 -	
	1330	20M5 / 28Mn6	1330	1.117	28Mn6	150M28 EN 14A		
	1035	XC32 / C35R	1035	1.118	Cm35	080M36	F.1135 -	
	1040	XC42H1 / C40E	1040	1.1186	Ck40	060A40/080A40		S 40 C
	1045	XC42H1 / C45/XC45	1045	1.1191	Ck45	080M46/060A47	F.1140 -	S 45 C
	1045	XC42H1 /C45R	1045	1.1201	Cm45	080M46	F.1145 -	
	1055	XC55H1 / C55E	1055	1.1203	Ck55	060A57/070M55	F.1150 -	S55C
	1050	XC48H1 / C50E	1050	1.1206	Ck50	080M50		
1050	XC48H1TS	1050	1.1213	Cf53	060A52			
1060	XC60 / C60E/2C60	1060	1.1221	Ck60	060A62	F.511/F.512	S58C	
1070	XC68	1070	1.1231	Ck67	060A67			
ALLOY STEEL	1080/1078/1086	XC75 / C75E/XC90	1074	1.1248/1269	Ck75	060A78	F.513/514/515	
	1095	XC100	1095	1.1274	Ck101	060A96		
	4135/4142	34CD4 /42CD4		1.233	35CrMo4/47CrMo4	708A37/M40		SCM435TK
	3135/3140	35NC6		1.571/5711	36NiCr6/40NiCr6	640A35/M40 EN111A		
	8620/8720	20NCD2	8620	1.6523/43	21NiCrMo2	805M20/A20 EN 362	F.1522 -	SNCM220(H)
	8740	40NCD2	8640	1.6546	40NiCrMo22	311-Type7	F.1204 -	SNCM240
		18NCD6		1.6587	17CrNiMo8	820A16	F.1560 -	
	5132	32C4 / 34Cr4		1.7033	34Cr4	530A32 EN18B	F.8221 /F.224	SCR430(H)
	5135	38C4 / 37Cr4	5135	1.7034	37Cr4	530A36	F.1201 -	
	5140	42C4 / 41Cr4	5140	1.7035	41Cr4	530M40/A40 EN 18	F.1202 -	SCR440(H)
	5140	42C4TS	5140	1.7045	42Cr4	530A40	F.1202 -	SCR440
	5115	16MC5	5115	1.7131	16MnCr5	527M17	F.1515 -	
	5155	55C3		1.7176	55Cr3	527A60 EN 48	F.1431 -	SUP9(A)
	4130	25CD4 / 25CrMo4	4130	1.7218	25CrMo4	1717CDS110	F.8330 -	SCM420/430
	4135/4137	35CD4 / 34CrMo4		1.722	34CrMo4	708A37 EN 19B	F.8231 -	
4140/4142	42CD4 / 42CrMo4	4140	1.7225	42CrMo4	708M40 EN 19A	F.8232 -		
4150	50CrMo4	4150	1.7228	50CrMo4	708A47			
6150	50CV4 / 51CrV4	6151	1.8159	50CrV4	735A50 EN 47	F.1430 -		

Technical data provided should be considered advisory only as variations may be necessary depending on the particular application.









Material Conversion Chart

								
	USA	France	Brazil	German W-nr	German DIN	UK	Spain	Japan JIS
HIGH STRENGTH ALLOY STEEL	A355Cl.D	30CAD6.12		1.8507	34CrAlMo5	905M31	F.1741 -	
	A355Cl.A	40CAD6.12		1.8509	41CrAlMo7	905M39 EN 41B	F.1740 -	
		18NC13		1.5755	31NiCr14	653M31	F.123	
	9840	40NCD3		1.6511	36CrNiMo4	816M40 EN 110	F.1280	
	4340		4340	1.6562	40NiCrMo73	817M40		SNCM 447
		30CND8		1.658	30CrNiMo8	823M30		
	4340	35NCD6	4340	1.6582	34CrNiMo8	817M40 EN 24	F.1272	SNCM 447
		35NCD14		1.6746	32NiCrMo145	830M31	F.1262	
	35NCD16		1.6747	30NiCrMo166	835M30	F.1260		
	30CD12		1.8515	31CrMoV139	722M24 EN 40B	F.1712		
			1.8523	39CrMoV139	897M39 EN 40C			
STRUCTURAL STEEL	A570 (36)	E24-2NE / S235JRG2	A36	1.0038	RS137-2	4360-40C		STKM 12A
	A570 (40)	E28-2 / S275JR		1.0044	St44-2	4360-43A/B	A 430B	SM 400 A;B;C
	A570 (50)	A50-2 / E295		1.005	St50-2	4360-50B		SS490
		A60-2 / E335-A70-2/E360		1.006/1.007	St60-2/St70-2	4360-55E		
	A284/A573/A611	E24-3;-4 / S235J2G3		1.0116	St37-3	4360-40C/D-1449-37C	A360 C;D	
	A366/1012/A619	DC01		1.033/.0333	St12/13	1449 -2/3/4CR	AP 00/02	
	A620	DC04		1.0338	St14	1449 1CR; 2CR	AP 04	
	A516Gr.65;-55;	A37CP;AP / P235GH		1.0345	H I	1501Gr.161-360/400	A 37 RC I;RA II	
		A42CP;AP / P265GH		1.0425	H II	161-400;	A42 RC I	
	A537	A52CP;AP / P335GH		1.0473	19Mn6		A 47 RB II	
	A516 (70)	A48CP;AP / P295GH		1.0481	17Mn4		A 47 RC I; RA II	
		E36-3/4 / S355J2G3		1.057	St52-3	4360-50B;50C;50D	A 510 C;D	
	A204 (A)	15D3 / 15Mo3		1.5415	15Mo3	1501-240	F.2601 -	
	4520			1.5423	16Mo5	1503-245-420	F.2602 -	
	A350-LF3	12Ni14 / 12Ni14		1.5637	10Ni14	1501-503-690	F.152	
	3115	10NC6		1.5713	13NiCr6			
	3415	14NC11		1.5732	14NiCr10		F.1540	
	A182-F11;F12	15CD3.05		1.7335	13CrMo44	620Gr.27;31	F.2631	
	A387 (12)	15CD4.5		1.7337	16CrMo44	620Gr.27		
	A182F22	10CrMo9-10		1.738	10CrMo910	622Gr.31;45	TU.H	
A633Gr.E	E420RIFP / S420N		1.8902	StE420	4360-55E	AE 420 KG		
A633Gr.E	E460RIFP / S460N		1.8905	StE460		AE 460 KG		
HIGH TEMPERATURE ALLOYS	330	Z12NCS37.18		1.4864	X12NiCrSi3616	NA17	F.3313	
				1.4865	G-X40NiCrSi3818	330C40		
	B163	Z8NC3221		1.4876	X10NiCrAlTi3320	NA15(H)	F.3545	
	4544/SB127/164	NU30		2.436	NiCu30Fe	3072-76/NA13		
	4676			2.4375	NiCu30Al	3072-76/NA18/3146		
	5388 C	NC 17 DWY		2.4602	NiCr17Mo17FeW			
		NC 20 T		2.463	Ni-Cr20Ti	HR5/203-4/703-B		
		NC 20 TA		2.4631	NiCr20TiAl	HR 401HR601/736B		
		NCKD 20 ATV		2.4634	NiCo20Cr15MoAlTi	HR 3/5007		
	687	NCKD 20 AT		2.4636	NiCo15Cr15MoAlTi			
		NCK 20 D		2.465	NiCr20Co19MoTi	HR 10		
	5660C	Z8 NCDT 42		2.4662	NiCr15MoTi			
	5536E	Nc 22 FeD		2.4665	NiCr22Fe18Mo	HR 6/204		
		NC 19 FeNb		2.4668	NiCr19Fe19NbMo	HR 8		
	5542G	NC 15 Fe TNb		2.4669	NiCr16FeTi	HR 505		
	5391A	NC 13 AD		2.467	G-NiCr13Al6MoNb	HC 203		
		NK 15 CAT		2.4674	NiCo15Cr10MoAlTi	HC 204		
	5540	NC 15 Fe		2.4816	NiCr15Fe	3072-76		
	5581	NC 22 FeDNB		2.4856	NiCr22Mo9Nb			
		NC 21 FeDU		2.4858	NiCr21Mo	3072-76		
	NC 19 KDT		2.4973	NiCr19Co11MoTi				
684	NCK 19 DAT		2.4983	NiCr18Co18MoAlTi				
TITANIUM TITANIUM ALLOYS		T-35		3.7024/25	Ti 99.8	TA.1	Ti-PO1	
		T-U2		3.7124	TiCu2	TA.21-24/52-55/58	Ti-P11	
		T-A6ZD		3.7154	TiAl6Zr5Mo0.5Si0.2	TA.43/44	Ti-P67	
		T-A4DE		3.7184	TiAl4Mo4Sn2Si0.5	TA.45-51/57	Ti-P68	
	4941/42/51/4902	T-40		3.7034/35	Ti 99.7	TA.2/3/4/5	Ti-PO2	
	4901/21	T-60		3.7064/65	Ti99.5	TA.6/7/8/9	Ti-PO4	
	491128/35/54/65/67	T-A6V		3.7164/65	TiAl6V4	TA.10-13/28/56	Ti-P63	
	4900	T-50				DTD 5023/5283		

Technical data provided should be considered advisory only as variations may be necessary depending on the particular application.









For product information, call your local distributor.

Material Conversion Chart

								
	USA	France	Brazil	German W-nr	German DIN	UK	Spain	Japan JIS
STAINLESS STEELS	410S	Z3014		1.4001	X7Cr14	403S17	F.8401	
	405	Z6CA13 / Z6CrAl13		1.4002	X6CrAl13	405S17	F.3111	
	416	Z12CF13 / Z12CrS13		1.4005	X12CrS13	416S21	F.3411	SUS 416
	410/CA-15	Z12C13 / Z12Cr13	410	1.4006	X10Cr13	410S21 ENEN 56A	F.3401	SUS 410
	430	Z8Cr17 / Z6Cr17		1.4016	X6Cr17	430S15 EN 60	F.3113	SUS 430
	420	Z20C13 / Z20Cr13	420	1.4021	X20Cr13	420S37	F.3402	SUS 420
		Z40C14 / Z40Cr14		1.4034	X46Cr13	420S45 EN 56D	F.3405	
	431	Z15CN16.02		1.4057	X20CrNi172	431S29 EN 57	F.3427	
	430F	Z10CF17		1.4104	X12CrMoS17		F.3117	
	434	Z8CD17.01		1.4113	X6CrMo17	434S17		
	440C	Z100CD17		1.4125	X105CrMo17			
	304/304H	Z6CN18.09	304	1.4301	X5CrNi1810	304S15 EN 58E	F.3451	SUS304
	308; 305	Z8CN18.12		1.4303	X5CrNi1812	305S19	F.3513	
	303	Z10CNF18.09	303	1.4305	X10CrNiS189	303S21 EN 58M	F.3508	SUS303
	304L	Z2CN18.10/Z3CN19.10M		1.4306	G-X2CrNi189/1911	304S12/S11/C12	F.3503	SCS19
	CF-8	Z6CN18.10M		1.4308	G-X6CrNi189	304C15		
	301	Z12CN17.07	302	1.431	X12CrNi177	301S21	F.3517	
	304LN	Z2CN18.10Az		1.4311	X2CrNiN1810	304S62		
		Z10CN18.9M		1.4312	G-X10CrNi188	302C25		
	CA6-NM	Z4CND13.4M		1.4313	G-X5CrNi134	425C11		
	316/316L	Z6CND17.11	316	1.4401	X5CrNiMo17122	316S16/S31 EN 58J	F.3543	SUS316
	316L	Z2CND 18.13	316L	1.4404	X2CrNiMo17132	316S11/S12	F.3533	SUS316 L
	316LN	Z2CND 17.12Az		1.4406	2CrNiMoN17122	316S61		SUS316LN
	CF-8M			1.4408	G-X6CrNiMo1810	316C16	F.8414	
	316LN	Z2CND17.13Az		1.4429	X2CrNiMo17133	316S62		SUS316LN
	316L	Z2CND17.13		1.4435	X2CrNiMo18143	316S11/S12	F.3533	SUS316LN
	316	Z6CND17.12		1.4436	X5CrNiMo17133	316S16	F.3534	SUS316
	317L	Z2CND19.15		1.4438	X2CrNiMo18164	317S12		SUS317L
	329		329 (DUPLX)	1.446	X8CrNiMo275		F.3309	SUS329
	XM8/430Ti	Z8CT17		1.451	X6CrTi17		F.3114	
	409	Z6CT12		1.4512	X5CrTi12	409S19		
	321	Z6CNT18.10	321	1.4541	X6CrNiTi1810	321S12/S31 EN 58B	F.3523	SUS321
	630	Z6CNU17.04		1.4542	X5CrNiCuNb1714			SUS630
	347	Z6CNCNb18.10		1.455	X6CrNiNb1810	347S17/S31 EN 58F	F.3552	SUS347
	316Ti	Z6CNDT17.12		1.4571	X6CrNiMoTi17122	320S31/S17 EN 58J	F.3552	
	316Ti			1.4573	X10CrNiMoTi1812	320S33		
	316Cb	Z6CNDNb17.12/19.13		1.458	X6CrNiMoNb17122	318S17		
	HNV3	Z45CS9		1.4718	X45CrSi93	401S45 EN52	F.3220	
		Z10C13		1.4724	X10CrAl13	403S17	F.13152	
		Z40CSD10		1.4731	X40CrSiMo102		F.3221	
	430	Z10CAS18		1.4742	X10CrAl18	430S15	F.3153	SUS430
	HNV6	Z80CSN20.02		1.4747	X80CrNiSi20	443S65 EN 59	F.3222	
	446	Z10CAS24		1.4762	X10CrAl24		F.3154	SUH446
	309	Z15CNS20.12		1.4828	X15CrNiSi2012	309S24		
	309S	Z15CN24.13		1.4833	X7CrNi2314	309S24		
	314/310	Z15CNS25.20	314	1.4841	X15CrNiSi2520		F.3310	
	310S	Z12CN25.20	310	1.4845	X12CrNi2521	310S24	F.331	
HK			1.4848	G-X40CrNiSi2520	310C40	F.8452		
EV8	Z52CMN21.09		1.4871	X53CrMnNiN219	349S54	F.3217		
	Z35CNWS14.14		1.4873	X45CrNiW189	331S40	F.3211		
321	T6CNT18.12(B)		1.4878	X12CrNiTi189	321S20	F.3523	SUS321	
A353	Z8N9		1.5662	X8Ni9	1501-509;510	F.2645		
2515	Z18N5		1.568	12Ni19				

Technical data provided should be considered advisory only as variations may be necessary depending on the particular application.









Material Conversion Chart

								
	USA	France	Brazil	German W-nr	German DIN	UK	Spain	Japan JIS
TOOL STEELS	A532IBNiCr-LC			0.962	G-X260NiCr42	Grade2A		
	A532IANiCr-HC			0.9625	G-X330NiCr42	Grade2B		
	A532IDNi-HiCr			0.963	G-X300CrNiSi952	Grade2C,D,E		
	A532IID20%CrMo-LC			0.9645	G-X260CrMoNi2021	Grade3C		
	A532IIIA25%Cr			0.965	G-X260Cr27	Grade3D		
	A532IIIA25%Cr			0.9655	G-X300CrMo271	Grade3E		
	W108	Y190;Y180		1.1525	C80W1			
	W110	Y1105		1.1545	C105W1			SK3
	W112	Y2120		1.1663	C125W			
	W1			1.175/1625	C75W/C80W1	BW1A/BW1B	F.1507	
	L3	Y100C6	52100	1.2067	100Cr6	BL3	F.5230	
	D3	Z200C12	420 (1.2083)	1.208	X210Cr12	BD3	F.5212	
	L2			1.221	115CrV3			
	H11	Z38CDV5	H11	1.2343	X38CrMoV51	BH11	F.5317	
	H13	Z40CDV5	H13	1.2344	X40CrMoV51	BH13	F.5318	SKD61
	A2	Z100CDV5	A2	1.2363	X100CrMoV51	BA2	F.5227	SKD12
	H10	32DCV28	H10	1.2365	X32CrMoV33	BH10	F.5313	
	D2	Z160CDV12	D2	1.2379	X155CrVMo121	BD2		
		105WC13		1.2419	105WCr6		F.5233	
			D6 (VC131)	1.2436	X210CrW12		F.5213	
	O1		O1 (VND)	1.251	100MnCrW4	BO1	F.5220	SKS 31
	S1		S1 (VW3)	1.2542	45WCrV7	BS1	F.5241	
		55WC20		1.255	60WCrV7			
	H21	Z30WCV9	H20/H21	1.2581	X30WCrV93	BH21	F.5323	SKD5
				1.2601	X165CrMoV12		F.5211	
	H12	Z35CWDV5	H12	1.2606	X37CrMoW51	BH12		
	L6	55NCDV7	(VMO)	1.2713	55NiCrMoV6		F.528	
	W210	Y1105V		1.2833	100V1	BW2		
	2	90MV8		1.2842	90MnCrV8	BO2		
	T15			1.3202	S12-1-4-5	BT15	F.5563	
		Z130WKCDV10-10-04-03		1.3207	S10-4-3-10		F.553	
		Z85WDKCV06-05-05-04-02	M35	1.3243	S6-5-2-5		F.5613	
	M41	Z110WKCDV07-05-04-04-02		1.3246	S7-4-2-5		F.5613	
	M42	Z110DKCWW09-08-04-02-01	M42	1.3247	S2-10-1-8	BT42	F.5615	
	M33/M34			1.3249	S2-9-2-8	BM34	F.5611	
	T4	Z80WKCV18-05-04-01		1.3255	S18-1-2-5	BT4	F.5530	
	T5			1.3265	S18-1-2-10	BT5	F.5540	
	M3	Z90WDCV06-05-04-03		1.3342	SC6-5-2			
	M2	Z85WDCV06-05-04-02	M2	1.3343	S6-5-2	BM2	F.5603	
	M3Class2	Z130WDCV06-05-04-04	M3:2	1.3344	S6-5-3		F.5605	
H41/M1	Z85DCWV08-04-02-01		1.3346	S2-9-1	BM1			
M7	Z100DCWV09-04-02-02	M7	1.3348	S2-9-2		F.5607		
T1	Z80WCV18-04-01		1.3355	S18-0-1	BT1	F.5520		
A128(A)	Z120M12 / Z120Mn12		1.3401	X120Mn12		F.82551		
52100	100C6	52100	1.3505	100Cr6	534A99	F.1310		
HARDENED STEEL								
CAST ALUMINIUM	319,2	A-S5U		3.2151	G-AISI6Cu4	LM4/LM22	L-2660	
	380,1	A-S9U3		3.2161	G-AISI8Cu3	LM24	L-2630	
		A-S4G		3.2341	G-AISI5Mg	DTD716B		
	A356.2	A-S7G0,3		3.2371	G-AISI7Mg	2L99/LM25		
		A7-S10G		3.2373	G-AISI9Mg			
	A360	A-S10G		3.2381	G-AISI10Mg	LM9	L-2560	
	413,1	A-S12U		3.2583	G-AISI12Cu	LM20	L-2530	
	514,1	A-G6		3.3561	G-ALMg5	LM5		
	A413	A-S13		3.3581	G-AISI12	LM6	L-2520	
	520	A-G10-Y4		3.3591	G-ALMg10	LM10	L-2310	
	390				AISI17Cu4			
	393				AISI18-25CuNiMg	LM28/LM29		

Technical data provided should be considered advisory only as variations may be necessary depending on the particular application.

For product information, call your local distributor.

Material Conversion Chart

								
	USA	France	Brazil	German W-nr	German DIN	UK	Spain	Japan JIS
WROUGHT ALUMINIUM	1200	A4		3.0205	Al99	1C	L-3001	
	1050A	A5		3.0255	Al99,5	1B	L-3051	
	1350A	A5/L		3.0257	E-Al	1E	L-3052	
	1080A	A8		3.0285	Al99,8	1A	L-3081	
	1199	A99		3.0385	Al99,98R	1		
	3004	A-M1G		3.0526	AlMnMg1	N4	L-3820	
	2014	A-U4SG		3.1255	AlCuSiMn	H15	L-3130	
	2117	A-U2G		3.1305	AlCu2,5Mg0,5	3L86/HR13	L-3180	
	2017A	A-U4G		3.1325	AlCuMg1	H14	L-3120	
	2024	A-U4G1		3.1355	AlCuMg2	2L98	L3140	
	2003	A-U4Pb		3.1645	AlCuMgPb		L-3121	
	2011	A-U5PbBi		3.1655	AlCuBiPb	FC1	L-3182	
	6101B			3.2305	E-AlMgSi	91E	L-3431	
	6463	A85-GS		3.2307	Al99,85MgSl	BTR6		
	6181	A-SGMO,7		3.2315	Al-Si1 Mg	H30	L-3451	
	6060			3.3206	AlMGSi0,5	H9	L-3441	
	6101C	A-GS/L		3.3207	E-AlMgSi0,5	BTRE6		
	5005A	A-G0,6		3.3315	AlMg1	N41	L-3350	
	5050B	A-G1,5		3.3316	AlMg1,5	3L44	L-3380	
	5052	A-G2,5C		3.3523	AlMg2,5	N5Mg3,5	L-3360	
	5251	A-G2M		3.3525	AlMg2Mn0,3	N4		
	5754	A-G3M		3.3535	AlMg3		L-3390	
	5454	A-G2,5MC		3.3537	AlMg2,7Mn	N51		
	5083	5083		3.3547	AlMg4,5Mn	N8	L-3321	
	5056A			3.3555	AlMg5	N6	L-3320	
7020	A-Z5G		3.4335	AlZn4,5Mg1	H17	L-3741		
7075	A-Z5GU		3.4365	AlZnMgCu1,5	2L95	L-3710		
SG / NODULAR CAST IRON	60-40-18	FGS-400-12		0.704	GGG-40	420/12		
		FGS370-17		0.7043	GGG-40.3	370/17		
	65-45-12	FGS500-7		0.705	GGG-50	500/7		FDC500
	80-55-06	FGS 600-3		0.706	GGG-60	600/3		
	100-70-03	FGS 700-2		0.707	GGG-70	700/2		FDC700
	120-90-02	FGS 800-2		0.708	GGG-80	800/2		
		MB 35-7		0.8035	GTW-35-04	W 340/3		
		MB 40-10		0.804	GTW-40-05	W 410/4		
				0.8045	GTW-45-07			
	32 510	MN 35-10		0.8135	GTS-35-10	B 340/12		
	MP 50-5		0.8145	GTS-45-06	P 440/7			
	MP 60-3		0.8155	GTS-55-04	P 540/5			
			0.8165	GTS 65-02				
	MP 70-2		0.817	GTS 70-02	P 690/2			
GREY / WHITE CAST IRON	A48-40B	Ft25D / FGL250		0.6025	GG25	Grade 260	FG 25	
	A48-20B	Ft10D / FGL100		0.601	GG10		FG 10	
	A48-25B	Ft15D / FGL150		0.6015	GG15	Grade 150	FG 15	
	A48-30B	Ft20D / FGL200		0.602	GG20	Grade 220	FG20	
	A48-45B	Ft30D / FGL300		0.603	GG30	Grade 300	FG 30	
	A48-50B	Ft35D / FGL350		0.6035	GG35	Grade 350	FG35	
A48-60B	Ft40D / FGL400		0.604	GG40	Grade 400			
BRONZE ALUMINIUM- BRONZE TIN BRONZE	C 60 800	CuAl6		2.0918	CuAl5As			
	C 61 000	CuAl8		2.092	CuAl8			
	C 61 400	CuAl7Fe2		2.0932	CuAl8Fe3	CA 106		
	C 62 300	CuAl9Fe3Mn2		2.0936	CuAl10Fe3Mn2	CA 105		
	C 95 200	CuAl9Fe3		2.094	CuAl10Fe	AB 1		
	B 505	CuAl9Fe3		2.094	G-FeAlBzF50	AB 1		
		CuAl9Mn2		2.096	CuAl9Mn2			
	C 63 200	CuAl9Ni5Fe3Mn		2.0966	CuAl10Ni5Fe4	CA 104		
	C 95 800	CuAl9Ni5Fe		2.097	G-NiAlBzF50	AB 2		
		CuAl11Ni5Fe5		2.0978	CuA11Ni8Fe5			
C 94100	CuPb20Sn5		2.1188	G-CuPb20Sn	LB5			

Technical data provided should be considered advisory only as variations may be necessary depending on the particular application.

Material Conversion Chart

								
	USA	France	Brazil	German W-nr	German DIN	UK	Spain	Japan JIS
BRASS	C 21000/34500	CuZn5		2.022/2.032	CuZn5	CZ 125/101		
	C 85700	CuZn40-Y30		2.034	G-CuZn37Pb	PCB 3		
	C 28000/38500	CuZn40/44Pb2		2.036/2.041	CuZn40/44Pb2	CZ 109/CZ130		
	C 68700	CuZn22Al2		2.046	CuZn20Al2	CZ 110		
	C 44300			2.047	CuZn28Sn1	CZ 111		
	C 46400			2.053	CuZn38Sn1	CZ 112		
	C 67400			2.055	CuZn40Al2	CZ 114		
	C 86400			2.0591	G-CuZn38Al	PCB1, DCB 3		
	C 86400	CuZn40-Y30		2.0592	G-CuZn35Al1	HTB 1		
	C 86300			2.0598	G-CuZn25Al5	HTB 3		
	C 90500			2.105	G-CuSn10Zn	G1		
	C 90800	CuSn12		2.1052	G-CuSn12	Pb2		
	C 91700			2.106	G-CuSn12Ni	CT2		
	C 90250			2.1086	G-CuSn10	CT1		
	C 93200	CuSn7Pb6Zn4		2.109	G-CuSn7ZnPb			
	C 92410			2.1093	G-CuSn6ZnNi	LG4		
	C 83600	CuPb5Sn5Zn5		2.1096	G-CuSn5ZnZn/RG5	LG2		
	C 93700	CuPb10Sn10		2.1176	G-CuPb10Sn	LB2		
C 93800			2.1182	G-CuPb15Sn	LB1			
COPPER COPPER/NICKEL ALLOYS	C 96200			2.0815	G-CuNi10			
	C 71300	CiNi25		2.083	CuNi25	CN 105		
	C 96400			2.0835	G-CuNi30	CN 2		
	C 72150	CuNi44		2.0842	CuNi44Mn1			
	C 70600	CuNi10Fe1Mn		2.0872	CuNi10Fe1Mn	CN 102		
	C 71500	CuNi30Mn1Fe		2.0882	CuNi30Mn1Fe	CN 107		
	C 17000	CuBe1,7		2.1245	CuBe1,7	CB 101		
	C 17200	CuBe1,9		2.1247	CuBe2			
	C 17500			2.1285	CuCo2Be	C 112		
	C 71640	CuNi30Fe2Mn2			CuNi30Fe2Mn2	CN 108		
	OF	Cu-c1/C2		2.004	OF-Cu	Cu-OF C 103/110		
	C 11000	Cu-a1/A2		2.006	E-Cu57	Cu-ETP-2 C 101		
	C 11000	Cu-a1		2.0065	E-Cu58	Cu-ETP-2 C 101		
	C 1200	Cu-b2		2.0076	SW-Cu			
	C 12200	Cu-b1		2.009	SF-Cu	Cu-DHP C 106		

Technical data provided should be considered advisory only as variations may be necessary depending on the particular application.

For product information, call your local distributor.



**Corporate
Headquarters**

Davenport, Iowa



Manufacturing

Vero Beach, Florida

Leeds, UK

Nanjing, China



Sales Offices

Derby, UK

Hong Kong

Maharashtra, India

Worldwide Distribution World Class Service

Centrally located in Davenport, Iowa, with national and international distribution through an extensive network of distributors and manufacturer's representatives, M.A. Ford® responds effectively to customer tooling needs. Our extensive line of standard products are on the shelf for immediate shipping and technical support is just a phone call away.

Visit www.maford.com for your local M.A. Ford® representative.

Where *high performance* is the *standard*®

ISO 9001:2008 Certified



Made in USA



800-553-8024 • 563-391-6220
www.maford.com



Where **high performance** is the **standard**®

Also available:



M.A. Ford® Mfg. Co., Inc.

7737 Northwest Blvd.
Davenport, IA 52806 USA
Ph: 563-391-6220 or 800-553-8024
Fax: 563-386-7660 or 800-892-9522
e-mail: sales@maford.com
www.maford.com

M.A. Ford® Asia-Pacific, Ltd.

Unit 2501, 25/F
148 Electric Road
North Point
Hong Kong
Ph: + 852-2167-7150
Fax: +852-2167-8150
sales@mafordap.com

M.A. Ford Europe Ltd.

Unit 38, Royal Scot Road
Pride Park, Derby
DE24 8AJ UK
Tel: +44(0) 1332 267960
Fax: +44(0) 1332 267969
sales@mafordeurope.com
www.mafordeurope.com

M.A. Ford® Asia-Pacific Ltd. (India)

412A, Arcadia
Hiranandani Estate,
Thane (W) - 400607
Maharashtra, India
Ph: +91 22 41237421
Fax: +91 22 41233387
sales@mafordin.com