

Overview

HP ProLiant DL560 Generation9 (Gen9)

Business-critical workloads and virtualized environments require compact and powerful computing capacity. The HP ProLiant DL560 Gen9 Server is designed for exactly that. To deliver performance, scalability, and expandability in a dense 2U footprint. Deploy the ideal high-density four-socket server for multi-workload compute with the latest technology. It's designed to help you achieve greater performance at the right price.

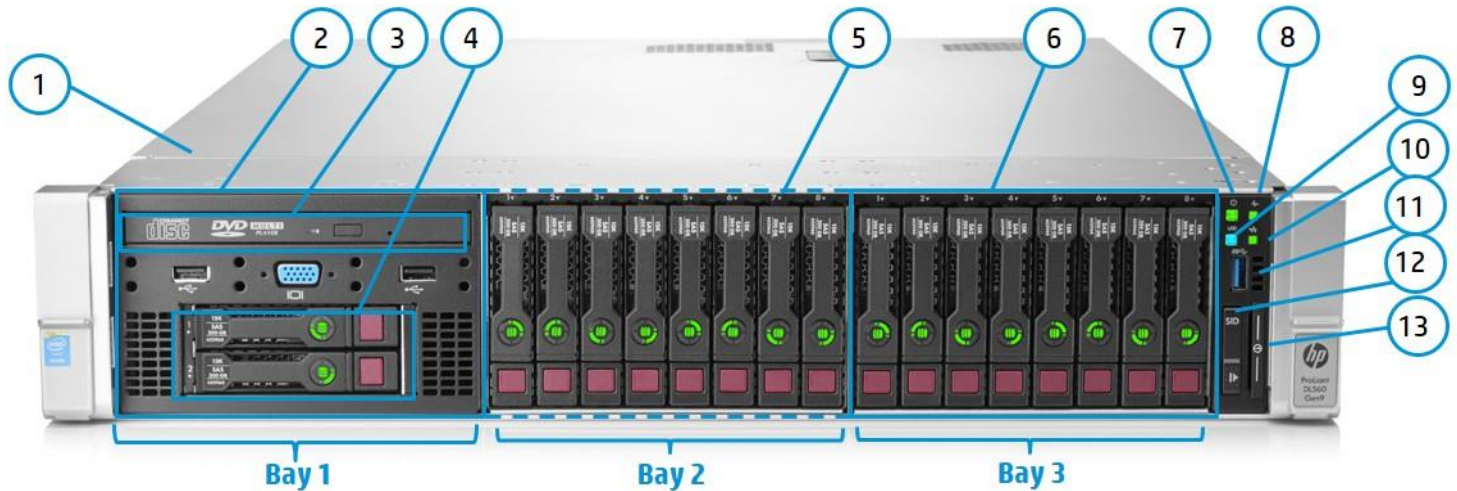

Front View

1. Quick removal access panel
2. Bay 1 – Optional 8 SFF Drive Bay or Universal Media Bay
3. Optional Optical drive. Requires Universal Media Bay
4. Optional 2 SFF HDDs. Requires Universal Media bay.
5. Bay 2 – Optional 8 SFF Drive Bay
6. Bay 3 – fixed 8 SFF Drive Bay
7. Power On/Standby button and system power LED button
8. Health Status LED
9. UID button
10. NIC Status LED
11. USB 3.0 connector
12. Systems Insight Display (SID) (optional)
13. Serial label pull tag

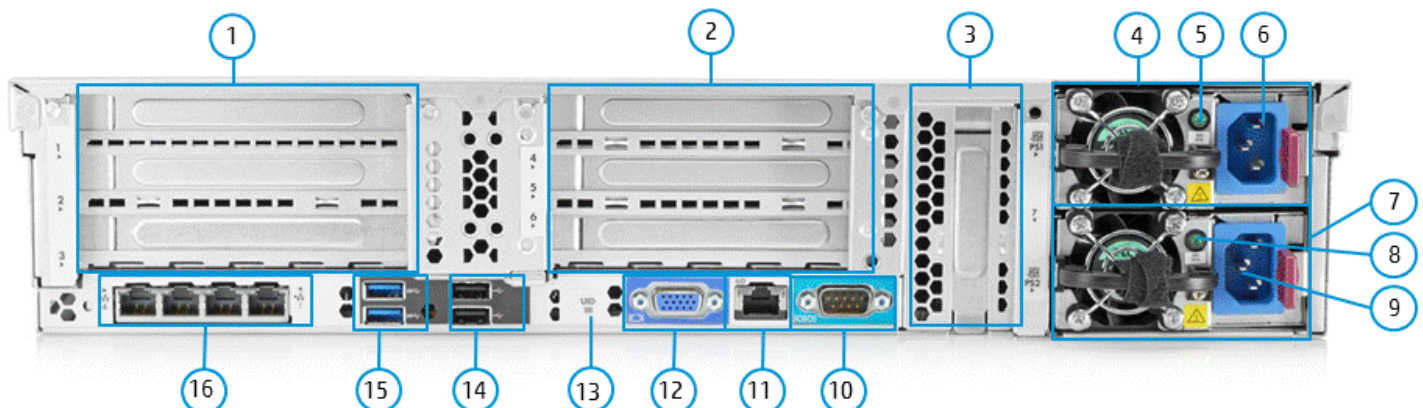

Rear View

Overview

1. PCIe Slots (Slots 1-3 top to bottom)
2. PCIe Slots (Slots 4-6 top to bottom)
3. PCIe Slot (Slot 7)
4. HP Common Slot Power Supply bay 1
5. Power supply power LED
6. Power supply power connection
7. HP Common Slot Power Supply bay 2
8. Power supply power LED
9. Power supply power connection
10. Serial connector
11. Dedicated iLO connector
12. VGA (video) connector
13. Unit ID LED
14. USB 2.0 connectors (2)
15. USB 3.0 connectors (3)
16. HP FlexibleLOM ports (Shown:4x1GbE/Optional:2x10GbE);port1 on right side

Standard Features

NOTE: For more information regarding Intel Xeon processors, please see the following <http://www.intel.com/xeon>.

Processor	Model	CPU frequency	Cores	L3 Cache	Power	QPI	DDR4 Hz
Up to four of the following depending on model	E5-4669v3	2.1GHz	18	45MB	135W	9.6GT/s	2133
	E5-4667v3	2.0GHz	16	40MB	135W	9.6GT/s	2133
	E5-4660v3	2.1GHz	14	35MB	120W	9.6GT/s	2133
	E5-4655v3	2.9GHz	6	30MB	135W	9.6GT/s	2133
	E5-4650v3	2.1GHz	12	30MB	105W	9.6GT/s	2133
	E5-4640v3	1.9GHz	12	30MB	105W	8.0GT/s	1866
	E5-4627v3	2.6GHz	10	25MB	135W	8.0GT/s	2133
	E5-4620v3	2.0GHz	10	25MB	105W	8.0GT/s	1866
	E5-4610v3	1.7GHz	10	25MB	105W	6.4GT/s	1600

NOTE: For the Standard Features shipped in the "Factory Integrated Models", please see the "Configuration Information - Factory Integrated Models" section.

Cache Memory	45MB (1 x 45MB) Level 3 cache (E5-4669 v3)
One of the following depending on model	40MB (1 x 40MB) Level 3 cache (E5-4667 v3)
	35MB (1 x 35MB) Level 3 cache (E5-4660 v3)
	30MB (1 x 30MB) Level 3 cache (E5-4650 v3, E5-4640 v3, E5-4655 v3)
	25MB (1 x 25MB) Level 3 cache (E5-4620 v3, E5-4627 v3, E5-4610 v3)

Chipset	Intel® C610 Series Chipset
	Intel® Xeon® E5-4600v3 Processor Family
	NOTE: For more information regarding Intel chipsets, please see the following URL: http://www.intel.com/products/server/chipsets/

On System Management Chipset	HP iLO (Firmware HP iLO4 2.0) 4GB NAND
-------------------------------------	--

Memory	Type:
One of the following depending on model	HP SmartMemory
	DDR4 Registered (RDIMM) or Load Reduced (LRDIMM)
	DIMM Slots Available 48 (12 DIMM slots per processor, 4 channels per processor, 3 DIMMs per channel)
	Maximum Capacity (LRDIMM) 1.5TB (48 x 32GB LRDIMM @2133MHz)
	Maximum Capacity (RDIMM) 1.5TB (48 x 32GB RDIMM @2133MHz)

NOTE: HP memory from previous generation servers are not qualified or warranted with this HP ProLiant Server. HP SmartMemory is required to realize the memory performance improvements and enhanced functionality listed in this document for Gen9. For additional information, please see the [HP SmartMemory QuickSpecs](#).

NOTE: LRDIMM and RDIMM are distinct memory technologies and cannot be mixed within a server.

NOTE: Depending on the memory configuration and processor model, the memory speed may run at 2133, 1866MHz, 1600MHz. Please see Memory Population Table below or the [Online Memory Configuration Tool](#).

NOTE: 64GB LRDIMM to be available in second half of 2015.

Memory Protection	Advanced ECC	Advanced ECC uses single device data correction to detect and correct single and all multibit error that occurs within a single DRAM chip.
	Online spare	Memory online spare mode detects a rank that is degrading and switches operation to the spare rank.
	Mirroring mode	Memory mirroring inter-socket stores a copy of memory with dynamic failover in case of failure. Once a DIMM in a mirrored set is detected as failed, the mirror failover uses its mirrored DIMM.
	Demand and Patrol Scrubbing	Memory demand and patrol scrubbing prevent accumulation of correctable errors and reduces the likelihood of unplanned downtime.

Standard Features

Failed DIMM Isolation	Failed DIMM isolation improves the service time thus improving the overall system availability.
Data Bus ECC Protection	Data Bus ECC protection provides automatic correction from a single data bit error and detection of double data error bits. Often called single error correction/double error detection (SEC/DED).
Memory Thermal Control	Memory thermal control is used to prevent DIMMs from overheating. Achieved by slowing down the memory access rate per the temperature monitored by DIMM sensor.
Memory Mirroring Inter-Socket	Memory mirroring inter-socket stores a copy of memory with dynamic failover in case of failure. Once a DIMM in a mirrored set is detected as failed, the mirror failover uses its mirrored DIMM.

Network Controller

The HP ProLiant DL560 Gen9 servers offer a flexible network technology - FlexibleLOM, which offers customers a choice of 1Gb, 10Gb, or 10Gb base-T Ethernet or converged networking in their embedded adapter. A range of NIC cards are also available to enhance networking capabilities.

NOTE: For additional details see the [Networking Section of this document](#).

Model	Adapter
Entry Model	HP Ethernet 1Gb 4-port 331FLR Adapter
Base Model	HP FlexFabric 10Gb 2P 533FLR-T Adapter
Performance Model	HP FlexFabric 10Gb 2P 533FLR-T Adapter

Expansion Slots

Primary Riser (Standard)	Expansion Slots #	Technology	Bus Width	Connector Width	Form Factor	Notes
	1	PCIe 3.0	x8	x16	Half Length/Full Height	Proc 1
	2	PCIe 3.0	x8	x16	Half Length/Full Height	Proc 1
	3	PCIe 3.0	x8	x8	Half Length/Full Height	Proc 1
Secondary Riser (Optional)	Expansion Slots #	Technology	Bus Width	Connector Width	Form Factor	Notes
	4	PCIe 3.0	x16	x16	Half Length/Full Height	Proc 2
	5	PCIe 3.0	x8	x16	Half Length/Full Height	Proc 2
	6	PCIe 3.0	x8	x8	Half Length/Full Height	Proc 2
Expansion Slot 7	Expansion Slots #	Technology	Bus Width	Connector Width	Form Factor	Notes
	7	PCIe 3.0	x8	x16	Half Length/Full Height	Proc 2

Storage Controller

One of the following depending on model

Entry Models	HP Dynamic Smart Array B140i Controller
Base Models	HP Flexible Smart Array P440ar/2GB controller
	The P440ar Flexible Smart Array controller is in its own dedicated slot, enables SAS drives and has 2GB Flash Backed Write Cache for data retention.
Performance Models	HP Smart Array P840/4GB Controller
	The P840 Flexible Smart Array controller enables SAS drives and has 4GB Flash Backed Write Cache for enhanced data retention.

Internal Storage Devices

One of the following depending on model

Hard Drives	None ship standard
Hard Drive Bays	(8) Hot plug SFF SAS/SATA HDD bays in Entry and Base Models, (16) in Performance Models; upgradable to a maximum of (24) For drives: Bay3 (8SFF) is standard; Bay 2 (8SFF) is populated next, followed by Bay 1(8SFF) If one of the two Optional Universal Media Bay Kits is chosen, a maximum of (18) SFF drives are available as versus (24). Universal Media Bay Kits occupy Bay1 and can include an optional Optical Disk Drive; a version has an optional 2SFF drive bay as well.
Optional Optical Drive	Available via Universal Media Bay kit; with and without (2)SFF drive bay

Standard Features

An optional optical drive can be added to either the Universal Media Bay Kit with 2SFF drive bay (793479-B21) or the Universal Media Bay Kit without 2SFF drive bay (795090-B21).

Maximum Internal Storage		CAPACITY	CONFIGURATION
	Hot Plug SFF SATA	48 TB	24 x 2 TB
	Hot Plug SFF SAS	48 TB	24 x 2 TB
	Hot Plug SFF SATA SSD	38 TB	24 x 1.6TB
	Hot Plug SFF SAS SSD	46 TB	24 x 1.92TB

Power Supply
One of the following depending on model

(1) HP 1200W Common Slot Platinum Hot Plug Power Supply
NOTE: Entry Models have a single HP 1200W Common Slot Platinum Hot Plug Power Supply.

(2) HP 1200W Common Slot Platinum Plus Hot Plug Power Supplies
NOTE: Base and Performance Models have redundant HP 1200W Common Slot Platinum Plus Hot Plug Power Supplies.

Common Slot Power Supplies One of the following depending on power requirements:

- HP 1500W Common Slot Platinum Plus Hot Plug Power Supply
- HP 1500W Common Slot 48VDC Hot Plug Power Supply
- HP 1200W Common Slot Platinum Plus Hot Plug Power Supply
- HP 1200W Common Slot Platinum Hot Plug Power Supply

NOTE: HP 1500W Common Slot Platinum Plus Hot Plug Power Supply supports high line voltage only.

Prior to making a power supply selection it is highly recommended that the HP Power Advisor is run to determine the right size power supply for your server configuration. The HP Power Advisor is located at: <http://www.hp.com/go/hppoweradvisor>.

HP's Common Slot (CS) power supplies allow for commonality of power supplies across a wide range of ProLiant and Integrity servers, as well as HP Storage solutions, and are designed to provide the highest power supply efficiency without degrading system performance. HP CS power supplies are tested by the Electric Power Research Institute (EPRI) and certified through the ECOS 80 Plus power supply program. HP CS power supply options provide efficiency ratings of up to 94% (80 Plus Platinum) and are available in several power output options including - 1200W, 1500W - allowing the customer to "right-size" a power supply for their specific server configuration. All HP Common Slot power sources are UL, CE Mark Compliant, hot-plug and support redundant configurations.

HP CS Platinum Plus power supplies are required when enabling HP's Intelligent Power Discovery (IPD) solution. IPD is the first technology to create an automated, energy-aware network between IT systems and facilities. This allows your company to reclaim millions of dollars in wasted power capacity and downtime costs across data centers. For more information on HP's IPD solution, go to <http://www.hp.com/go/ipd>.

NOTE: Mixing of power supplies in the same server is not supported. All power supplies must be of the same output and efficiency rating. If non-matched power supplies are inserted you will get errors and operation will fail.

NOTE: All pre-configured servers ship with a standard 6-foot IEC C-13/C-14 jumper cord (A0K02A). This jumper cord is also included with each standard AC power supply option kit. If a different power cord is required, please check the [ProLiant Power Cables](#) web page.

System Fans 6 Hot Plug Fans with N+1 redundancy

Interfaces		
	Serial	1 rear
	Video	1 front (optional with Universal Media Bay kit); 1 rear
	iLO 4 Remote Management	1
	Micro SD Slot	1 standard, 2 additional and redundant via option 741279-B21
	USB 2.0 Ports	5 total: 2 front (optional); 2 rear; 1 internal
	USB 3.0 Ports	4 total: 1 front; 2 rear, 1 internal

Standard Features

Operating Systems and Virtualization Software Support for ProLiant Servers

[Microsoft Windows Server](#)
[Red Hat Enterprise Linux \(RHEL\)](#)
[SUSE Linux Enterprise Server \(SLES\)](#)
[VMware](#)

NOTE: For more information on HP's Certified and Supported ProLiant Servers for OS and Virtualization Software and latest listing of software drivers available for your server, please visit our Support Matrix at: <http://www.hp.com/go/ossupport> and our driver download page <http://www.hp.com/support/DL560Gen9>.

Upgradeability

Upgradeable to four (4) processors
Up to 48 DIMM slots
7 PCIe 3.0 I/O slots for additional communications and storage expansion
NOTE: PCIe slot availability is dependent on the number of processors installed. Please refer to the "Expansion Slots" section for more details.
NOTE: The HP ProLiant DL560 Gen9 server has a dedicated FlexibleLOM slot and a slot for either a HP Flexible Smart Array or a Smart SAS HBA controller in addition to the 7 PCI 3.0 I/O expansion slots.
Embedded 10-Port SATA, B140i as standard
HP Flexible Smart Array, Smart Array or Smart HBA Controllers
FlexibleLOM slot for 1Gigabit or 10 Gigabit Ethernet or QDR/FDR InfiniBand networking options
Up to 24 SFF Drives; or 18 SFF Drives with optional Universal Media Bay
Optional System Insight Display
Redundant Power Supplies

Industry Standard Compliance

PCIe 3.0 Compliant
PCIe 2.0 Compliant
ACPI 2.0. Compliant
PXE Support
WOL Support
Microsoft® Logo certifications
USB 2.0 Support
USB 3.0 Support
Energy Star
ASHRAE A3/A4
NOTE: For additional technical thermal details regarding ambient temperatures, humidity and features support please visit: <http://www.hp.com/servers/ASHRAE>.

Graphics

Integrated Matrox G200 video standard

- 1280 x 1024 (32 bpp)
- 1920 x 1200 (16 bpp)

HP iLO 4 On System Management Memory

- 16 MB Flash
- 256 MB DDR 3 with ECC (112 MB after ECC and video)

HP Server UEFI/Legacy ROM

Legacy Mode or Unified Extensible Firmware Interface (UEFI) Mode

HP's ProLiant System BIOS is an EDK2 UEFI solution, and adheres to the latest revisions of UEFI Class 2 specifications which supports both legacy boot and UEFI boot operation. The HP ProLiant DL560 Gen9 defaults to UEFI boot operation and can be factory or field configured for legacy boot operation.

NOTE: For UEFI boot operation, boot environment and OS image installations should be configured properly to support UEFI.

NOTE: For more information on HP's ProLiant System BIOS and UEFI, see the UEFI Information Library: <http://www.hp.com/go/uefi/docs>.

NOTE: HP Legacy F10 Mode Setting (758959-B22) can be selected to configure the system in Legacy mode in the factory.

Standard Features

To modify the server configuration ROM default settings, press F9 in the HP ProLiant POST screen to enter the UEFI System Utilities screen. By default, the System Utilities menus are in the English language.

UEFI enables numerous new capabilities, including both industry standard functionality and features specific to HP ProLiant servers. Following are some of the features that UEFI enables and that the HP ProLiant DL560 Gen9 can support when configured for UEFI boot operation:

- **Secure Boot** - A new feature in which the system firmware, option card firmware, operating systems, and software collaborate to greatly enhance platform security.
- **Operating system specific functionality** - Microsoft Windows 2012 supports several features only when installed in UEFI mode.
- **Support for > 2.2 TB (using GPT) boot drives** - Such drives could previously only be used for boot drives when using RAID solutions such as HP Smart Array.
- **UEFI Shell** - Provides a pre-boot environment for running scripts and tools. The HP ProLiant UEFI Shell provides both standard capabilities as well as numerous enhancements.
- **PXE boot support for IPv6 networks.**
- **PXE Multicast Boot** allowing for faster PXE deployments for large numbers of servers.
- **Boot support for option cards that only support a UEFI option ROM.**

NOTE: When the server is configured for UEFI Boot Mode, PXE servers must be configured with a UEFI boot image. When the server boots in UEFI mode, it does not boot media with a legacy OS installation. This includes DOS targets and Windows or Linux systems installed in Legacy mode. The reverse is also true for servers that boot in Legacy mode.

Form Factor	2U Rack Form Factor
	Entry, Base and Performance pre-configured models ship with Gen9 Easy Install Rail Kits and Cable Management Arm kit
	3.44" (8.74 cm) Height x 17.54" (44.55 cm) Width x 29.5" (74.94 cm) Length

Embedded Management	HP Integrated Lights-Out (HP iLO) Monitor your servers for ongoing management, service alerting, reporting and remote management with iLO. Learn more at http://www.hp.com/go/ilo .
----------------------------	--

UEFI
Configure and boot your servers securely with industry standard Unified Extensible Firmware Interface (UEFI). Learn more at <http://www.hp.com/go/ProLiant/uefi>.

HP RESTful API
RESTful API is an application programming interface. RESTful Web Service API served by iLO's web server. Learn more at <http://www.hp.com/go/restfulapi>.

Intelligent Provisioning
Provision servers by discovering and deploying 1 to few servers with Intelligent Provisioning. Learn more at <http://www.hp.com/go/intelligentprovisioning>.

Embedded Remote Support
HP's embedded remote support, used with Insight Online direct connect or HP Insight Remote Support, allows HP ProLiant servers to transmit hardware events directly to HP or an HP Authorized Partner for automated phone home support. Learn more at <http://www.hp.com/go/insightonline/info>.

Server utilities	HP Smart Update Optimize firmware and driver updates with HP Smart Update solutions. Learn more at http://www.hp.com/go/smartupdate .
-------------------------	--

Standard Features

HP Systems Insight Manager (HP SIM)	HP SIM allows you to monitor the health of your HP ProLiant Servers and HP Integrity Servers, and also provides you with basic support for non-HP servers. HP SIM also integrates with HP SUM to provide quick and seamless firmware updates. Learn more at http://www.hp.com/go/sim .
HP OneView Standard	HP OneView Standard can inventory, monitor, alert, and report on your G6 thru Gen9 servers, with use of the REST API and HP OneView user interface. Annual support is optionally available. Learn more at http://www.hp.com/go/oneview .
Scripting Tool Kit and Windows PowerShell	Provision 1 to many servers using your own scripts to discover and deploy them with HP Scripting Tool Kit for Windows and Linux or HP Scripting Tools for Windows PowerShell. Learn more at http://www.hp.com/go/ProLiantSTK or http://www.hp.com/go/powershell .
HP RESTful Interface Tool	HP RESTful Interface tool is a scripting tool to provision servers using RESTful API Interface to discover and deploy servers at scale. Learn more at http://www.hp.com/go/restfulapi .
HP iLO Mobile Application	Enables the ability to access, deploy, and manage your server anytime from anywhere from select smartphones and mobile devices. For additional information please visit: http://www.hp.com/go/ilo/mobileapp .
HP Insight Online	HP Insight Online, available at no additional cost as part of your HP warranty, Care Pack or contractual support agreement with HP, is a personalized dashboard for simplified tracking of IT operations and support information from anywhere, anytime. Learn more at http://www.hp.com/go/insightonline/info .

Security	Power-on password Serial interface control Administrator's password
-----------------	---

Warranty	<p>This product is covered by a global limited warranty and supported by HP Services and a worldwide network of HP Authorized Channel Partners resellers. Hardware diagnostic support and repair is available for three years from date of purchase. Support for software and initial setup is available for 90 days from date of purchase. Enhancements to warranty services are available through HP Care Pack services or customized service agreements. Hard drives have either a one year or three year warranty; refer to the specific hard drive QuickSpecs for details.</p> <p>NOTE: Server Warranty includes 3-Year Parts, 3-Year Labor, 3-Year Onsite support with next business day response. Warranty repairs may be accomplished through the use of Customer Self Repair (CSR) parts. These parts fall into two categories: 1) Mandatory CSR parts are designed for easy replacement. A travel and labor charge will result when customers decline to replace a Mandatory CSR part; 2) Optional CSR parts are also designed for easy replacement but may involve added complexity. Customers may choose to have HP replace Optional CSR parts at no charge. Additional information regarding worldwide limited warranty and technical support is available at: http://h18004.www1.hp.com/products/servers/platforms/warranty/index.html.</p>
-----------------	---

Optional Features

Embedded Management	iLO Advanced	<p>HP iLO Advanced licenses offer smart remote functionality without compromise, for all HP ProLiant servers. The license includes the full integrated remote console, virtual keyboard, video, and mouse (KVM), multi-user collaboration, console record and replay, and GUI-based and scripted virtual media and virtual folders. You can also activate the enhanced security and power management functionality. Learn more about HP iLO Advanced at http://www.hp.com/go/iloadvanced.</p>
Server Management	HP Insight Control	<p>HP Insight Control, lets you deploy, migrate, monitor, remote control, and optimize your IT infrastructure through a single, simple management console. For more information, see http://www.hp.com/go/insightcontrol.</p>
	HP OneView Advanced	<p>HP OneView Advanced is converged management that reduces infrastructure complexity with automation simplicity. This modern architecture accelerates your IT operations across servers, storage, and network resources using software-defined approaches and automation. Learn more at http://www.hp.com/go/oneview.</p>
	HP Insight Cluster Management Utility (CMU)	<p>HP Insight Cluster Management Utility is a hyperscale-optimized management framework that includes software for the provisioning, control, performance management and monitoring of groups of nodes and infrastructure. Learn more at http://www.hp.com/go/cmu.</p>
Rack and Power Infrastructure	<p>HP Rack and Power Infrastructure products and services create highly efficient and intelligent solutions for existing or new IT data centers. HP Rack and Power infrastructure solutions – rack infrastructure, power protection and management, performance optimized data centers (PODs) – are the foundation you are looking for to help secure your long-term IT success. These products are designed to help you react to changes in the industry. They deliver efficient, easy-to-use capabilities to manage, monitor, deploy and provision infrastructure from entry to enterprise. As an industry leader, HP is uniquely positioned to address the key concerns of power, cooling, cable management and system access.</p> <p>Learn more at HP Rack and Power Infrastructure.</p>	
High Performance Clusters	HP Cluster Platforms	<p>HP Cluster Platforms are specifically engineered, factory-integrated large-scale ProLiant clusters optimized for High Performance Computing, with a choice of servers, networks and software. Operating system options include specially priced offerings for Red Hat Enterprise Linux and SUSE Linux Enterprise Server, as well as Microsoft Windows HPC Server. A Cluster Platform Configurator simplifies ordering. http://www.hp.com/go/clusters</p>
	HP HPC Interconnects	<p>High Performance Computing (HPC) interconnect technologies are available for this server as part of the HP Cluster Platform portfolio. These high-speed InfiniBand and Gigabit interconnects are fully supported by HP when integrated within an HP cluster. Flexible, validated solutions can be defined with the help of configuration tools. http://www.hp.com/techservers/clusters/ucp/index.html</p>
	HP Insight Cluster Management Utility	<p>HP Insight Cluster Management Utility (CMU) is an HP-licensed and HP-supported suite of tools that are used for lifecycle management of hyperscale clusters of Linux ProLiant systems. CMU includes software for the centralized provisioning, management and monitoring of nodes. CMU makes the administration of clusters user friendly, efficient, and effective. http://www.hp.com/go/cmu</p>
Storage Software	<p>Whether you need to solve a specific data protection, archiving, or storage command and control challenge, or deliver on strategic consolidation, compliance, or continuity initiatives, look no further than HP storage software. Our storage software helps you reduce costs, simplify storage infrastructure, protect vital assets and respond faster to business opportunities.</p>	
	<p>Storage software that gets the job done:</p>	
	<ul style="list-style-type: none"> • Data Protection and Recovery Software 	<p>Whether you're a large enterprise or a smaller business, HP data protection and recovery software will cost-effectively protect you against disaster and ensure business continuity.</p>

Optional Features

- **Data Archive and Migration Software**
HP's storage software enables you to comply with data retention and retrieval requirements, improve application performance, and reduce costs by efficiently migrating infrequently accessed or less valuable data to lower cost storage.
- **Storage Resource Management Software (SRM)**
HP's storage resource management software reduces operational costs and provides the command and control foundation you need to efficiently manage and visualize your physical and virtual environments.
- **Data Replication Software**
HP offers array-based and host-based replication software for use in disaster recovery, testing, application development and reporting.
- **Storage Device Management Software**
Maximize your investment in HP storage and networking with software that enables hardware-specific configuration, performance tuning and connectivity management.
- **HP StoreVirtual VSA**
With HP StoreVirtual VSA you can use the power of virtualization to turn a set of heterogeneous and disconnected physical disk drives in your servers and storage devices into a single pool of logical storage capacity.

NOTE: For more information available Storage Software including QuickSpecs, please see: <http://www.hp.com/go/storage/software>.

Solutions

Factory Express Portfolio for Servers and Storage

HP Factory Express offers configuration, customization, integration and deployment services for HP servers and storage products. Customers can choose how their factory solutions are built, tested, integrated, shipped and deployed.

Factory Express offers service packages for simple configuration, racking, installation, complex configuration and design services as well as individual factory services, such as image loading, asset tagging, and custom packaging. HP products supported through Factory Express include a wide array of servers and storage: HP Integrity, HP ProLiant, HP ProLiant Server Blades, HP BladeSystem, HP 9000 servers as well as the MSAxxxx, VA7xxx, EVA, XP, rackable tape libraries and configurable network switches.

For more information on Factory Express services for your specific server model please contact your sales representative or go to: <http://www.hp.com/go/factory-express>.

One Config Simple (SCE)

SCE is a guided self-service tool to help sales and non-technical people provide customers with initial configurations in 3 to 5 minutes. You may then send the configuration on for configuration help, or use in your existing ordering processes. If you require "custom" rack configuration or configuration for products not available in SCE, please contact HP's Customer Business Center or an Authorized Partner for assistance. <http://www.hp.com/products/configurator>.

Service and Support

Service and Support

HP Technology Services for Industry Standard Servers

HP Technology Services delivers confidence, reduces risk and helps customers realize agility and stability. Connect to HP to help prevent problems and solve issues faster. Our support technology lets you to tap into the knowledge of millions of devices and thousands of experts to stay informed and in control, anywhere, any time.

Protect your business beyond warranty with HP Care Pack Services

HP Care Pack Services enable you to order the right service level, length of coverage and response time as you purchase your new server, giving you full entitlement for the term you select.

Optimized Care

Supports maintaining servers at optimum performance availability

HP Proactive Care with 24x7 coverage, three year Care Pack Service

HP Proactive Care helps prevent problems and stabilize IT by utilizing secure, real-time, predictive analytics and proactive consultations when your products are connected to HP. This Care Pack Service combines three years' proactive reporting and advice with our highest level reactive coverage and enhanced escalation management, HP's 24x7, six hour call-to-repair hardware commitment. HP is the only leading manufacturer who makes this level of coverage available as a standard service offering for your most valuable servers. Service includes 24x7 collaborative software support for leading industry standard software running on your HP ProLiant server.

<http://h20195.www2.hp.com/v2/GetPDF.aspx/4AA3-8855ENW.pdf>

Standard Care Package

Supports maintaining high level of server availability

Foundation Care 24x7, three-year Care Pack Service

HP Proactive Care helps prevent problems and stabilize IT by utilizing secure, real-time, predictive analytics and proactive consultations when your products are connected to HP. This Care Pack Service combines three years' proactive reporting and advice with our 24x7 coverage and enhanced escalation management, four hour hardware response time and two hour call back for software questions on leading industry standard software running on your HP ProLiant server.

<http://h20195.www2.hp.com/v2/GetPDF.aspx/4AA3-8855ENW.pdf>

Related Services

HP ProLiant Server Hardware Installation

Provides for the basic hardware installation of HP branded servers, storage devices and networking options to assist you in bringing your new hardware into operation in a timely and professional manner.

<http://h20195.www2.hp.com/V2/GetPDF.aspx/5981-9356EN.pdf>

Factory Express for Servers and storage

HP Factory Express offers configuration, customization, integration and deployment services for HP servers and storage products. Customers can choose how their factory solutions are built, tested, integrated, shipped and deployed. For more information on Factory Express services for your specific server model please contact your sales representative or go to: <http://www.hp.com/go/factory-express>.

Data Privacy Services

Protect your data through better media management. HP Data privacy services help manage and protect sensitive data to reduce the risk of unauthorized access to private information and help meet compliance requirements. Our retention services allow you to keep drives and other devices upon failure, our removal services provide convenient data sanitization and our recovery services allow you to safely retire IT assets and capture any remaining value from the hardware.

<http://www.hp.com/services/dataprivacy>

Additional HP Care Pack services can be found at: <http://www.hp.com/go/cpc>

Connect your devices to HP

Unlock all of the benefits of your technology investment by connecting your products to HP. Achieve up to 77% reduction in down time, near 100% diagnostic accuracy and a single consolidated view of your environment. By connecting, you will receive 24x7 monitoring, pre-failure alerts, automatic call logging, and automatic parts dispatch. HP Proactive Care Service and HP Datacenter Care Service customers will also benefit from proactive activities to help prevent issues and increase optimization. All of these benefits are already available to you with your server storage and networking products, securely connected to HP support.

Service and Support

HP Support Center

Personalized online support portal with access to information, tools and experts to support HP business products. Submit support cases online, chat with HP experts, access support resources or collaborate with peers. Learn more <http://www.hp.com/go/hpsc>

HP's Support Center Mobile App** allows you to resolve issues yourself or quickly connect to an agent for live support. Now, you can get access to personalized IT support anywhere, anytime.

HP Insight Remote Support and HP Support Center are available at no additional cost with a HP warranty, HP Care Pack or HP contractual support agreement.

** HP Support Center Mobile App is subject to local availability

Parts and Materials

HP will provide HP-supported replacement parts and materials necessary to maintain the covered hardware product in operating condition, including parts and materials for available and recommended engineering improvements.

Parts and components that have reached their maximum supported lifetime and/or the maximum usage limitations as set forth in the manufacturer's operating manual, product quick-specs, or the technical product data sheet will not be provided, repaired, or replaced as part of these services.

The defective media retention service feature option applies only to Disk or eligible SSD/Flash Drives replaced by HP due to malfunction.

Pre-configured Models

For the Standard Features shipped in the "Factory Integrated Models", please see the "Configuration Information - Factory Integrated Models" section.

1. Pre-configured models ship with the configurations below. Options can be selected from the Core or Additional options section of this QuickSpecs.
2. HP does not allow factory integration of options into pre-configured models. Any additional options purchased will be shipped separately.
3. If you desire a custom configuration please see "Configuration Information - Factory Integrated Models" section of this QuickSpecs.
4. Not all models are available in all regions. Check with your local country HP offices for availability.

NOTE: All Pre-configured Models come populated with some hard drive blanks installed. Should the customer need additional hard drive blanks, they can order more using either P/N 666987-B21: HP SFF Hard Drive Blank Kit.

NOTE: All pre-configured servers ship with a standard 6-foot IEC C-13/C-14 jumper cord (AOK02A). This jumper cord is also included with each standard AC power supply option kit. If a different power cord is required, please check the [ProLiant Power Cables](#) web page.

Caution: HP recommends that a minimum of two people are required for all Rack Server installations. Please refer to your installation instructions for proper tools and number of people to use for any installation.

	Performance Models	Base Models
[SKU Number]	741066-B21	741065-B21
Model Name	HP ProLiant DL560 Gen9 E5-4640v3 4P 128GB-R P840/4GB 16SFF 2x1200W RPS Perf Server	HP ProLiant DL560 Gen9 E5-4620v3 2P 64GB-R P440ar/2GB 8SFF 2x1200W RPS Base Server
Processor	Intel® Xeon® E5-4640v3	Intel® Xeon® E5-4620v3
Number of Processors	Four	Two
Memory	128GB (8x16GB Registered DIMMs, 2133 MHz) NOTE: 48 DIMM slots available with Performance Model. Includes HP ProLiant DL560 Gen9 CPU Mezzanine Board.	64GB (4x16GB Registered DIMMs, 2133 MHz) NOTE: 24 DIMM slots available with Base Model; 2 more processor slots and 24 more DIMMs available via optional HP ProLiant DL560 Gen9 CPU Mezzanine Board Kit (795107-B21).
Network Controller	HP FlexFabric 10Gb 2P 533FLR-T Adapter	
Storage Controller	HP Flexible Smart Array P840/4GB Controller NOTE: Additional Storage controllers also available as options.	HP Flexible Smart Array P440ar/2GB NOTE: Additional stand up Storage controllers with up to 4GB FBWC available as options.
Hard Drive	None ship standard	
Internal Storage	16 SFF Drive Bays NOTE: Can be expanded upto a max of 24 SFF drives, with optional HP ProLiant DL560 Gen9 Bay1 8SFF Cage/Backplane Kit (795085-B21). Alternatively, optional Universal Media Bay Kits may be chosen for Bay1 - with 2SFF drive bay (793479-B21) or without (795090-B21). NOTE: Bay 3 and Bay 2 are populated.	8 SFF Drive Bays NOTE: Can be expanded upto a max of 24 SFF drives, with optional HP ProLiant DL560 Gen9 Bay2 8SFF Cage/Backplane Kit (795084-B21) and HP ProLiant DL560 Gen9 Bay1 8SFF Cage/Backplane Kit (795085-B21). Alternatively, optional Universal Media Bay Kits may also be chosen for Bay1 - with 2SFF drive bay (793479-B21) or without (795090-B21). NOTE: When considering drives Server comes with Bay 3 populated as default with 8SFF. Bay 2 must be populated before Bay1.
Optical Drive Bay	Optional via Universal Media Bay	
Optical Drive	Optional DVD-ROM (726536-B21) or DVD-RW (726537-B21) via the Universal Media Bay Kits (795090-B21 or 793479-B21)	
PCI-Express Slots	7 PCIe 3.0 slots available; Secondary 3 Slot Riser kit (793474-B21) installed	
Power Supply	(2) HP 1200W Common Slot Platinum Plus Hot Plug Power Supplies	
Fans	6 hot plug fans, redundant	
Management	HP OneView Advanced with iLO Advanced	Integrated Lights-Out 4 (iLO 4) ships standard
Energy Star	Meets Energy Star requirements	
Form Factor	Rack (2U), HP Easy Install Rails with CMA	
Warranty	Server Warranty includes 3-Year Parts, 3-Year Labor, 3-Year Onsite support with next business day response	

	Entry Models
[SKU Number]	741064-B21
Model Name	HP ProLiant DL560 Gen9 E5-4610v3 2P 32GB-R B140i 8SFF SATA 1200W PS Entry Server

Pre-configured Models

Processor	Intel® Xeon® E5-4610v3
Number of Processors	Two
Memory	32GB (2x16GB Registered DIMMs, 2133 MHz) NOTE: 24 DIMM slots available with Entry Model; 2 more processor slots and 24 more DIMMs available via optional HP ProLiant DL560 Gen9 CPU Mezzanine Board Kit (795107-B21).
Network Controller	HP Ethernet 1Gb 4P 331FLR Adapter
Storage Controller	HP Dynamic Smart Array B140i NOTE: Additional Storage controllers including HP Flexible Smart Array, HP Smart Array and HP Smart HBA also available as options, to enable both SAS capability as well as provide data retention with Flash Backed Write Cache (FBWC).
Hard Drive	None ship standard
Internal Storage	8 SFF Drive Bays NOTE: Can be expanded upto a max of 24 SFF drives, with optional HP ProLiant DL560 Gen9 Bay2 8SFF Cage/Backplane Kit (795084-B21) and HP ProLiant DL560 Gen9 Bay1 8SFF Cage/Backplane Kit (795085-B21). Alternatively, optional Universal Media Bay Kits may also be chosen for Bay1 - with 2SFF drive bay (793479-B21) or without (795090-B21). NOTE: Server comes with Bay 3 populated as default with 8SFF. When considering drives Bay 2 must be populated before Bay1.
Optical Drive Bay	Optional via Universal Media Bay
Optical Drive	Optional DVD-ROM (726536-B21) or DVD-RW (726537-B21) via the Universal Media Bay Kits (795090-B21 or 793479-B21)
PCI-Express Slots	4 PCIe 3.0 slots available; upgrade to 7 PCIe 3.0 slots would require optional Secondary Riser kit (793474-B21)
Power Supply	(1) HP 1200W Common Slot Platinum Hot Plug Power Supply
Fans	6 hot plug fans, redundant
Management	Integrated Lights-Out 4 (iLO 4) ships standard
Energy Star	Meets Energy Star requirements
Form Factor	Rack (2U), HP Easy Install Rails with CMA
Warranty	Server Warranty includes 3-Year Parts, 3-Year Labor, 3-Year Onsite support with next business day response

NOTE: For the Standard Features shipped in the "Factory Integrated Models", please see the "Configuration Information - Factory Integrated Models" section.

NOTE: Pre-configured models ship with the configurations below. Options can be selected from the Core or Additional options section of this QuickSpecs.

NOTE: HP does not allow factory integration of options into pre-configured models. Any additional options purchased will be shipped separately.

NOTE: If you desire a custom configuration please see "Configuration Information - Factory Integrated Models" section of this QuickSpecs.

NOTE: Not all models are available in all regions. Check with your local country HP offices for availability.

Country Code Key	xx1 = B21	Worldwide
	xx1 = 291	Japan
	xx1 = AA1	PRC

Configuration Information - Factory Integrated Models

This section lists some of the steps required to configure a Factory Integrated Model. To ensure only valid configurations are ordered, HP recommends the use of an HP approved configurator. Contact your local sales representative for information on configurable product offerings and requirements.

1. Factory Integrated Models must start with a CTO Server.
2. FIO indicates that this option is only available as a factory installable option.
3. All Factory Integrated Models will be populated with sufficient hard drive blanks based on the number of initial hard drives ordered with the server.
4. Some options may not be integrated at the factory. Contact your local sales representative for additional information.

Step 1: Base Configuration (choose one of the following configurable models)

[Chassis]	HP ProLiant DL560 Gen9 Configure-to-order Server
SKU Number	742657-B21
Processor	2U Server Chassis with 2 processor slots available; 4 processor configuration would require optional HP ProLiant DL560 Gen9 CPU Mezzanine Board kit
DIMM Slots	24 DIMM slots for RDIMM, LRDIMM DDR4 Memory
Storage Controller	HP Dynamic Smart Array B140i; additional options including Flexible Smart Array, Smart Array and Smart HBA controllers.
PCIe	4 PCIe 3.0 slots (all 4 available if second processor is chosen, which also enables +3 PCI 3.0 slots with optional Secondary Riser Kit upgrade)
Drive Cage	8SFF Hot Plug (Upgrades possible with +16SFF optional or +10 optional with optional Universal Media Bay Kit in Bay 1 with optional 2SFF). NOTE: Server comes with Bay 3 populated as default.
Network Controller	Flexible LOM slot (various options can be chosen for networking; NIC cards also available via expansion slots)
Fans	6 hot plug fans, redundant
Management	HP Integrated Lights-Out 4 (iLO4) standard management, HP iLO4 Embedded Remote Support Technology, HP Insight Control Server Provisioning, HP Insight Online, HP Active Health System, System Insight Display
USB	(8) USB 2.0 ports (2 front, 4 rear, 2 internal)

(Base Configuration Continued)

Intel® C610 Chipset

(2) video ports (1 front optional via the Universal Media Kit upgrade option, 1 rear)

(1) microSD card slot

(1) Trusted Platform Module (TPM) connector

BIOS Legacy mode (field configurable) or Unified Extensible Firmware Interface (UEFI) mode (default)

Easy Install rails and cable management arm are optional

NOTE: PCIe slot availability is dependent on the number of processors installed. Please refer to the "Expansion slots" section for more details.

NOTE: A minimum of one processor is required. The system supports one, two or four processors installed.

Step 2: Choose Required Options (only one of the following from each list unless otherwise noted)

HP Processors

Select one or two processors from Core options-Processor section below,

- If one processor is desired, select one xxxxxx-L21
- If two processors are desired, select one xxxxxx-L21 and one xxxxxx-B21.
- Up to 4 processors supported. Mixing different processor models is not supported.
- DDR4 speed is the maximum memory speed of the processor. Actual memory speed may depend on the quantity and type of DIMMs installed.

For the Intel® C610 Chipset E5-4600 Series, the letter preceding the model number indicates the Product Line (, E5); 4600x v#, 4 = number of CPUs in a Node, 6 is socket/segment designation, 00 = Processor SKU, x = L for low power SKUs and v3= version number.

HP Memory

Select one or more memory from Core options-Memory section below,

Configuration Information - Factory Integrated Models

- LRDIMM, RDIMM are all distinct memory technologies and cannot be mixed within a server. The majority of ProLiant Gen9 servers support LRDIMM and RDIMM.
- HP memory from previous generation servers are not qualified or warranted with this HP ProLiant Server. HP SmartMemory is required to realize the memory performance improvements and enhanced functionality listed in this document for Gen9.
- If only one processor is installed, only half of the total DIMM slots are available. When populating with two processors all DIMM slots are available.
- Kits described as LP include Low Power DIMMs. For more information on ProLiant Energy Efficient Features, see: <http://www.hp.com/go/proliant-energy-efficient>.
- Depending on the memory configuration and processor model, the memory speed may run at 2133MHz, 1866MHz or 1600MHz. Please see Memory Population Table or the Online Memory Configuration Tool at: <http://www.hp.com/go/ddr4config>.

HP Power Supplies Select one or more power supplies from Core Options-Power Supplies section below:

- Prior to selecting a power supply option, it is highly recommended that you review your server configuration in the HP Power Advisor tool to determine the right size power supply for your server configuration. The HP Power Advisor is located at: <http://www.hp.com/go/hppoweradvisor>.
- Mixing of power supplies in the same server is not supported. All power supplies must be of the same input voltage, output rating, and efficiency rating. If non-matching power supplies are installed, you may receive an error message and/or experience operational issues with your server.

Step 3: Choose Additional Factory Integratable Options

HP Unique Options Select one or more Unique options from Core options section below.

- This section may contain FIO options, please see the Unique options section below.
- FIO indicates that this option is only available as a factory installable option.

HP I/O Expansion Options Select one or more Riser Kit options from Core options section below.

- To take advantage of the additional PCI slot upgrade, the second processor must be installed.
- This section may contain FIO options, please see HP I/O Expansion Options section below.
- FIO indicates that this option is only available as a factory installable option.

HP Drives Select one or more drives from Core options-HP Drives section below:

- The components of a storage subsystem (e.g. the drive, the HBA/controller, firmware, and the server backplane) should operate at the same data transfer rate or the system bandwidth will be negotiated down to an acceptable level for all components.
- Hard drives have either a one year or three year warranty; refer to the specific hard drive QuickSpecs for details.
- The HP ProLiant Gen9 Smart Storage solutions are equipped with re-designed Small Form Factor (SFF 2.5 in) hot plug carriers for HP Qualified Hard Drives and Solid State Drives. These new carriers provide status and activity indicators as well as caution indicators for "Do Not Remove".

HP Flexible LOM Select a FlexibleLOM from Core options-Networking section below,

- Only one FlexibleLOM can be added to the server. These options are upgradeable and can be changed from the original configuration after the server is shipped.
- For 10Gb adapters, a minimum of two Gigabytes (2 GB) of server memory is required per each adapter.
- Please see the QuickSpecs for Technical Specifications and additional information: <http://www.hp.com/go/ProLiantNICs>.

HP Networking Select a standup NIC adapter from Core options-Networking section below,

Configuration Information - Factory Integrated Models

- Please see the QuickSpecs for Technical Specifications and additional information: <http://www.hp.com/go/ProLiantNICs>.
- These options are upgradeable and can be changed from the original configuration after the server is shipped.
- For 10Gb adapters, a minimum of two Gigabytes (2 GB) of server memory is required per each adapter.

HP Storage Controllers

Select one or more Storage options from Additional options section below.

- The embedded B140i controller will operate in UEFI only mode. For legacy support an additional controller will be needed, and for CTO orders please also select the Legacy mode settings part, 758959-B22
- This section may contain FIO options, please see HP Storage Controllers section below.
- FIO indicates that this option is only available as a factory installable option.

HP Rail Kits

Select one type of rail kit from Additional options section below.

- Please take a moment to review the installation documentation that comes with the server to help you with the installation of your Gen9 server.
- See HP Rack Options in Additional Options section of this QuickSpecs for more rack kit choices.

Caution: HP recommends that a minimum of two people are required for all Rack Server installations. Please refer to your installation instructions for proper tools and number of people to use for any installation.

HP OneView Advanced

Select the Converged Management option from Additional options section below.

- The FIO version of HP OneView Advanced, E5Y43A, loads the license key onto the physical server for immediate 'Connect and Go' operation when added into the management network of the HP OneView management appliance.
- HP OneView Advanced includes an HP iLO Advanced license -- and the right-to-use HP Insight Control, HP Insight Control server provisioning, and enterprise integrations for VMware vCenter and Microsoft System Center.

Core Options

NOTE: Some options may not be integrated at the factory. To ensure only valid configurations are ordered, HP recommends the use of an HP approved configurator. Contact your local sales representative for additional information.

HP Unique Options	HP ProLiant DL560 Gen9 CPU Mezzanine Board Kit NOTE: This kit is required if configured with 4 processors.	795107-B21
	HP ProLiant DL560 Gen9 Bay2 8SFF Cage/Backplane Kit NOTE: This optional kit adds 8SFF drives for Bay2.	795084-B21
	HP ProLiant DL560 Gen9 Bay1 8SFF Cage/Backplane Kit NOTE: This optional kit adds 8SFF drives for Bay1.	795085-B21
	HP ProLiant DL560 Gen9 Universal Media Bay Kit NOTE: An optional Optical Disk Drive can be added, either DVD-ROM (726536-B21) or DVD-RW (726537-B21).	795090-B21
	HP ProLiant DL560 Gen9 2SFF Universal Media Bay Kit NOTE: Universal Media Bay kit with a 2SFF drive bay; an optional Optical Disk Drive can be added, either DVD-ROM (726536-B21) or DVD-RW (726537-B21).	793479-B21
	HP ProLiant DL560 Gen9 Bay3 to H240 Slot 7/ Bay 3 to P840/440 Riser1 and 2SFF-UMBay SAS Cable Kit NOTE: Required for connecting Bay1 Universal Media Bay 2SFF drive bay to a P840/P440 controller, or if using controller H240 in slot7 attached to Bay3. Also needed if using controller P840/P440 in riser1 attached to Bay3.	797924-B21
	HP ProLiant DL 560 Gen9 Bay 1 to Riser1/AROC and Bay 2/3 to Riser2/Slot7 SAS Cable Kit NOTE: Required if controllers H240/P440ar/H240ar/B140i in riser1/AROC (Smart Array HBA Connector) need to be connected to Bay1, or if controllers P840/P440 in Riser2/slot7 need to be connected to Bay2/3. Also needed if controller P440 in slot7 needs to be connected to Bay2/3.	797945-B21
	HP ProLiant DL560 Gen9 Bay 2 to Riser1/AROC and Bay 2/3 to Riser1/2 SAS Cable Kit NOTE: Required if using controllers H240/P440ar/H240ar/B140i in riser1/AROC (Smart Array HBA Connector) which need to be connected to Bay2, or if using controllers P840/P440 in Riser1/2 which need to be connected to Bay2/3.	797946-B21
	HP ProLiant DL560 Gen9 SAS Expander Card	804228-B21

HP Processors

Entry Processors - E5-4600v3 series Processors

HP ProLiant DL560 Gen9 Intel® Xeon® E5-4610v3 (1.7GHz/10-core/25MB/105W) Processor Kit	742704-B21
HP ProLiant DL560 Gen9 Intel® Xeon® E5-4610v3 (1.7GHz/10-core/25MB/105W) FIO Processor Kit	742704-L21

Base Processors - E5-4600v3 series Processors

HP ProLiant DL560 Gen9 Intel® Xeon® E5-4620v3 (2.0GHz/10-core/25MB/105W) Processor Kit	742702-B21
HP ProLiant DL560 Gen9 Intel® Xeon® E5-4620v3 (2.0GHz/10-core/25MB/105W) FIO Processor Kit	742702-L21

Performance Processors - E5-4600v3 series Processors

HP ProLiant DL560 Gen9 Intel® Xeon® E5-4627v3 (2.6GHz/10-core/25MB/135W) Processor Kit	742706-B21
HP ProLiant DL560 Gen9 Intel® Xeon® E5-4627v3 (2.6GHz/10-core/25MB/135W) FIO Processor Kit	742706-L21
HP ProLiant DL560 Gen9 Intel® Xeon® E5-4640v3 (1.9GHz/12-core/30MB/105W) FIO Processor Kit	742700-L21
HP ProLiant DL560 Gen9 Intel® Xeon® E5-4640v3 (1.9GHz/12-core/30MB/105W) Processor Kit	742700-B21
HP ProLiant DL560 Gen9 Intel® Xeon® E5-4650v3 (2.1GHz/12-core/30MB/105W) Processor Kit	742698-B21
HP ProLiant DL560 Gen9 Intel® Xeon® E5-4650v3 (2.1GHz/12-core/30MB/105W) FIO Processor Kit	742698-L21
HP ProLiant DL560 Gen9 Intel® Xeon® E5-4655v3 (2.9GHz/6-core/30MB/135W) Processor Kit	742710-B21

Core Options

HP ProLiant DL560 Gen9 Intel® Xeon® E5-4655v3 (2.9GHz/6-core/30MB/135W) FIO Processor Kit	742710-L21
HP ProLiant DL560 Gen9 Intel® Xeon® E5-4660v3 (2.1GHz/14-core/35MB/120W) Processor Kit	742696-B21
HP ProLiant DL560 Gen9 Intel® Xeon® E5-4660v3 (2.1GHz/14-core/35MB/120W) FIO Processor Kit	742696-L21
HP ProLiant DL560 Gen9 Intel® Xeon® E5-4667v3 (2.0GHz/16-core/40MB/135W) Processor Kit	789024-B21
HP ProLiant DL560 Gen9 Intel® Xeon® E5-4667v3 (2.0GHz/16-core/40MB/135W) FIO Processor Kit	789024-L21
HP ProLiant DL560 Gen9 Intel® Xeon® E5-4669v3 (2.1GHz/18-core/45MB/135W) Processor Kit	742708-B21
HP ProLiant DL560 Gen9 Intel® Xeon® E5-4669v3 (2.1GHz/18-core/45MB/135W) FIO Processor Kit	742708-L21

HP Memory

NOTE: HP memory from previous generation servers are not qualified or warranted with this HP ProLiant Server. HP SmartMemory is required to realize the memory performance improvements and enhanced functionality listed in this document for Gen9. For additional information, please see the [HP SmartMemory QuickSpecs](#) .

NOTE: LRDIMM, RDIMM, UDIMM, and HDIMMs are all distinct memory technologies and cannot be mixed within a server. The majority of ProLiant Gen9 servers support LRDIMM, RDIMM and UDIMMs.

Registered DIMMs (RDIMMs)

HP 8GB (1x8GB) Single Rank x4 DDR4-2133 CAS-15-15-15 Registered Memory Kit	726718-B21
HP 16GB (1x16GB) Dual Rank x4 DDR4-2133 CAS-15-15-15 Registered Memory Kit	726719-B21
HP 32GB (1x32GB) Dual Rank x4 DDR4-2133 CAS-15-15-15 Registered Memory Kit	728629-B21
HP 8GB (1x8GB) Dual Rank x8 DDR4-2133 CAS-15-15-15 Registered Memory Kit	759934-B21

Load Reduced DIMMs (LRDIMMs)

HP 32GB (1x32GB) Quad Rank x4 DDR4-2133 CAS-15-15-15 Load Reduced Memory Kit	726722-B21
HP 16GB (1x16GB) Dual Rank x4 DDR4-2133 CAS-15-15-15 Load Reduced Memory Kit	726720-B21

HP Optical Drives

HP 9.5mm SATA DVD-ROM JackBlack Gen9 Optical Drive	726536-B21
NOTE: The optional Universal Media Bay Kits are required for this option. (HP ProLiant DL560 Gen9 Universal Media Bay kit: 795090-B21 or HP ProLiant DL560 Gen9 2SFF Universal Media Bay kit: 793479-B21).	
HP 9.5mm SATA DVD-RW JackBlack G9 Optical Drive	726537-B21
NOTE: The optional Universal Media Bay Kits are required for this option. (HP ProLiant DL560 Gen9 Universal Media Bay kit: 795090-B21 or HP ProLiant DL560 Gen9 2SFF Universal Media Bay kit: 793479-B21).	
HP Mobile USB Non Leaded System DVD RW Drive	701498-B21
NOTE: External drive option.	

HP Drives

NOTE: The components of a storage subsystem (e.g. the drive, the HBA/controller, firmware, and the server backplane) should operate at the same data transfer rate or the system bandwidth will be negotiated down to an acceptable level for all components.

NOTE: Hard drives have either a one year or three year warranty; refer to the specific hard drive QuickSpecs for details.

12G SAS Hot Plug with SmartDrive SFF (2.5-inch) Enterprise Drives

HP 600GB 12G SAS 15K rpm SFF (2.5-inch) SC Enterprise 3yr Warranty Hard Drive	759212-B21
HP 450GB 12G SAS 15K rpm SFF (2.5-inch) SC Enterprise 3yr Warranty Hard Drive	759210-B21
HP 300GB 12G SAS 15K rpm SFF (2.5-inch) SC Enterprise 3yr Warranty Hard Drive	759208-B21

12G SAS Hot Plug SFF (2.5-inch) Enterprise Drives

HP 1.2TB 12G SAS 10K rpm SFF (2.5-inch) SC Enterprise 3yr Warranty Hard Drive	781518-B21
HP 900GB 12G SAS 10K rpm SFF (2.5-inch) SC Enterprise 3yr Warranty Hard Drive	785069-B21
HP 600GB 12G SAS 10K rpm SFF (2.5-inch) SC Enterprise 3yr Warranty Hard Drive	781516-B21
HP 300GB 12G SAS 10K rpm SFF (2.5-inch) SC Enterprise 3yr Warranty Hard Drive	785067-B21

12G SAS Value Endurance Hot Plug SFF (2.5-inch) Enterprise Value Solid State

Core Options

HP 1.6TB 12G SAS Value Endurance SFF 2.5-in SC Enterprise Value 3yr Wty Solid State Drive	762263-B21
HP 800GB 12G SAS Value Endurance SFF 2.5-in SC Enterprise Value 3yr Wty Solid State Drive	762261-B21
12G SAS Hot Plug SFF (2.5-inch) SC 512e Drives	
HP 2TB 12G SAS 7.2K rpm SFF (2.5-inch) SC 512e 1yr Warranty Hard Drive	765466-B21
HP 1.8TB 12G SAS 10K rpm SFF (2.5-inch) SC Enterprise 512e 3yr Warranty Hard Drive	791034-B21
HP 1TB 12G SAS 7.2K rpm SFF (2.5-inch) SC 512e 1yr Warranty Hard Drive	765464-B21
HP 600GB 12G SAS 15K rpm SFF (2.5-inch) SC 512e Enterprise 3yr Warranty Hard Drive	748387-B21
12G SAS Hot Plug SFF (2.5-inch) SC Write Intensive Solid State Drives	
HP 800GB 12G SAS Write Intensive SFF 2.5-in SC 3yr Wty Solid State Drive	802586-B21
HP 400GB 12G SAS Write Intensive SFF 2.5-in SC 3yr Wty Solid State Drive	802582-B21
HP 200GB 12G SAS Write Intensive SFF 2.5-in SC 3yr Wty Solid State Drive	802578-B21
12G SAS Read Intensive Hot Plug SFF (2.5-inch) Solid State Drives	
HP 1.92TB 12G SAS Read Intensive SFF 2.5-in SC 3yr Wty Solid State Drive	802891-B21
NOTE: These drives support Gen8 servers and beyond only.	
6G SAS Hot Plug with SmartDrive SFF (2.5-inch) Enterprise Drives	
HP 1.2TB 6G SAS 10K rpm SFF (2.5-inch) SC Dual Port Enterprise 3yr Warranty Hard Drive	718162-B21
HP 900GB 6G SAS 10K rpm SFF (2.5-inch) SC Enterprise 3yr Warranty Hard Drive	652589-B21
HP 600GB 6G SAS 10K rpm SFF (2.5-inch) SC Enterprise 3yr Warranty Hard Drive	652583-B21
HP 450GB 6G SAS 10K rpm SFF (2.5-inch) SC Enterprise 3yr Warranty Hard Drive	652572-B21
HP 300GB 6G SAS 10K rpm SFF (2.5-inch) SC Enterprise 3yr Warranty Hard Drive	652564-B21
HP 146GB 6G SAS 15K rpm SFF (2.5-inch) SC Enterprise 3yr Warranty Hard Drive	652605-B21
6G SAS Hot Plug SmartDrive SFF (2.5-inch) Midline Drives	
HP 1TB 6G SAS 7.2K rpm SFF (2.5-inch) SC Midline 1yr Warranty Hard Drive	652749-B21
HP 500GB 6G SAS 7.2K rpm SFF (2.5-inch) SC Midline 1yr Warranty Hard Drive	652745-B21
6G SAS ME Hot Plug SFF (2.5-inch) Enterprise Mainstream H2 Solid State Drives	
HP 200GB 12G SAS Mainstream Endurance SFF 2.5-in ENT Mainstream SC 3yr Wty H2 Solid State Drive	779164-B21
HP 400GB 12G SAS Mainstream Endurance SFF 2.5-in ENT Mainstream SC 3yr Wty H2 Solid State Drive	779168-B21
HP 800GB 12G SAS Mainstream Endurance SFF 2.5-in ENT Mainstream SC 3yr Wty H2 Solid State Drive	779172-B21
HP 1.6TB 12G SAS Mainstream Endurance SFF 2.5-in ENT Mainstream SC 3yr Wty H2 Solid State Drive	779176-B21
NOTE: Please see the HP SAS Hard Drives QuickSpecs for Technical Specifications and additional information.	
6G SATA Hot Plug SFF (2.5 inch) SC Midline Hard Drives	
HP 500GB 6G SATA 7.2K rpm SFF (2.5-inch) SC Midline 1yr Warranty Hard Drive	655708-B21
HP 1TB 6G SATA 7.2K rpm SFF (2.5-inch) SC Midline 1yr Warranty Hard Drive	655710-B21
6G SATA Hot Plug SFF (2.5-inch) SC 512e Drives	
HP 1TB 6G SATA 7.2K rpm SFF (2.5-inch) SC 512e 1yr Warranty Hard Drive	765453-B21
HP 2TB 6G SATA 7.2K rpm SFF (2.5-inch) SC 512e 1yr Warranty Hard Drive	765455-B21
6G SATA Value Endurance Hot Plug SFF (2.5-inch) Enterprise Boot Solid State Drives	
HP 120GB 6G SATA Value Endurance SFF 2.5-in SC Enterprise Boot 3yr Wty Solid State Drive	717965-B21
HP 80GB 6G SATA Value Endurance SFF 2.5-in SC Enterprise Boot 3yr Wty Solid State Drive	734360-B21
6G SATA Value Endurance Hot Plug SFF (2.5-inch) Enterprise Value Solid State Drives	
HP 1.6TB 6G SATA Value Endurance SFF 2.5-in SC Enterprise Value 3yr Wty Solid State Drive	757339-B21
HP 800GB 6G SATA Value Endurance SFF 2.5-in SC Enterprise Value 3yr Wty Solid State Drive	717973-B21
HP 480GB 6G SATA Value Endurance SFF 2.5-in SC Enterprise Value 3yr Wty Solid State Drive	717971-B21

Core Options

HP 600GB 6G SATA Value Endurance SFF 2.5-in SC Enterprise Value 3yr Wty Solid State Drive	739898-B21
HP 300GB 6G SATA Value Endurance SFF 2.5-in SC Enterprise Value 3yr Wty Solid State Drive	739888-B21
HP 240GB 6G SATA Value Endurance SFF 2.5-in SC Enterprise Value 3yr Wty Solid State Drive	717969-B21
6G SATA ME Hot Plug SFF (2.5-inch) Enterprise Mainstream Solid State Drives	
HP 800GB 6G SATA Mainstream Endurance SFF 2.5-in SC Enterprise Mainstream 3yr Wty Solid State Drive	691868-B21
HP 400GB 6G SATA Mainstream Endurance SFF 2.5-in SC Enterprise Mainstream 3yr Wty Solid State Drive	691866-B21
HP 200GB 6G SATA Mainstream Endurance SFF 2.5-in SC Enterprise Mainstream 3yr Wty Solid State Drive	691864-B21
HP 100GB 6G SATA Mainstream Endurance SFF 2.5-in SC Enterprise Mainstream 3yr Wty Solid State Drive	691862-B21
6G SATA Value Endurance Hot Plug SFF (2.5-inch) SC Enterprise Value M1 Solid State Drives	
HP 120GB 6G SATA Value Endurance SFF 2.5-in SC Enterprise Value 3yr Wty M1 Solid State Drive	764923-B21
HP 240GB 6G SATA Value Endurance SFF 2.5-in SC Enterprise Value 3yr Wty M1 Solid State Drive	764925-B21
HP 480GB 6G SATA Value Endurance SFF 2.5-in SC Enterprise Value 3yr Wty M1 Solid State Drive	764927-B21
HP 800GB 6G SATA Value Endurance SFF 2.5-in SC Enterprise Value 3yr Wty M1 Solid State Drive	764929-B21
6G SATA Value Endurance Hot Plug SFF (2.5-inch) SC Enterprise Value G1 Solid State Drives	
HP 120GB 6G SATA Value Endurance SFF 2.5-in SC Enterprise Value 3yr Wty G1 Solid State Drive	756621-B21
HP 240GB 6G SATA Value Endurance SFF 2.5-in SC Enterprise Value 3yr Wty G1 Solid State Drive	756636-B21
HP 480GB 6G SATA Value Endurance SFF 2.5-in SC Enterprise Value 3yr Wty G1 Solid State Drive	756657-B21
6G SATA Light Endurance Hot Plug SFF (2.5-inch) SC Enterprise Light G1 Solid State Drives	
HP 960GB 6G SATA Light Endurance SFF 2.5-in SC Enterprise Light 3yr Wty G1 Solid State Drive	756601-B21
6G SATA Hot Plug SFF (2.5-inch) SC Read Intensive Solid State Drives	
HP 240GB 6G SATA Read Intensive SFF 2.5-in SC 3yr Wty Solid State Drive	789135-B21
HP 480GB 6G SATA Read Intensive SFF 2.5-in SC 3yr Wty Solid State Drive	789145-B21
HP 960GB 6G SATA Read Intensive SFF 2.5-in SC 3yr Wty Solid State Drive	789155-B21
NOTE: Please see the HP Solid State Drives QuickSpecs for Technical Specifications and additional information	
M.2 SSD	
HP Dual 120GB Value Endurance Solid State M.2 Enablement Kit for ProLiant ML/DL Servers	777894-B21
HP 120GB Value Endurance Solid State M.2 Enablement Kit for ProLiant ML/DL Servers	788028-B21
NOTE: For additional drive capability, an additional controller apart from the B140i will be required.	
Hard Drive Blank Kits	
HP Small Form Factor Hard Drive Blank Kit	666987-B21
Hard Drive Kits	
HP ProLiant DL560 Gen9 Bay2 8SFF Cage/Backplane Kit	795084-B21
HP ProLiant DL560 Gen9 Bay1 8SFF Cage/Backplane Kit	795085-B21
Media Bay Kits	
HP ProLiant DL560 Gen9 Universal Media Bay Kit	795090-B21
NOTE: Does not include a 2SFF Drive Bay. Optical drive is optional.	
HP ProLiant DL560 Gen9 2SFF Universal Media Bay Kit	793479-B21
NOTE: It includes a 2SFF Drive Bay. Optical drive is optional.	

Core Options

HP Networking

1 Gigabit Ethernet adapters

HP Ethernet 1Gb 4-port 331T Adapter	647594-B21
HP Ethernet 1Gb 2-port 361T Adapter	652497-B21
HP Ethernet 1Gb 2-port 332T Adapter	615732-B21
HP Ethernet 1Gb 4-port 366T Adapter	811546-B21

10 Gigabit Ethernet adapters

HP Ethernet 10Gb 2-port 530SFP Adapter	652503-B21
HP Ethernet 10Gb 2-port 546SFP+ Adapter	779793-B21
HP Ethernet 10Gb 2-port 557SFP+ Adapter	788995-B21
HP Ethernet 10Gb 2-port 560SFP+ Adapter	665249-B21
HP Ethernet 10Gb 2-port 530T Adapter	656596-B21
HP Ethernet 10Gb 2-port 561T Adapter	716591-B21

NOTE: A minimum of two Gigabytes (2 GB) of server memory is required per each adapter.

NOTE: Direct Attach Cable (DAC) for copper environments or fiber transceivers and cables for fiber-optic environments must be purchased separately. Please see the related NIC QuickSpecs for Technical Specifications and additional information:

<http://www.hp.com/go/ProLiantNICs>.

FlexibleLOM Adapters

HP Ethernet 1Gb 4-port 331FLR Adapter	629135-B22
HP Ethernet 1Gb 4-port 366FLR Adapter	665240-B21
HP FlexFabric 10Gb 2-port 533FLR-T Adapter	700759-B21
HP FlexFabric 10Gb 2-port 534FLR-SFP+ Adapter	700751-B21
HP Ethernet 10Gb 2-port 560FLR-SFP+ Adapter	665243-B21
HP Ethernet 10Gb 2-port 561FLR-T Adapter	700699-B21
HP Ethernet 10Gb 2-port 546FLR-SFP+ Adapter	779799-B21
HP FlexFabric 10Gb 2-port 556FLR-SFP+ Adapter	727060-B21

NOTE: Please see the QuickSpecs for Technical Specifications and additional information: <http://www.hp.com/go/ProLiantNICs>.

HP InfiniBand

HP InfiniBand FDR 2-port 545QSFP Adapter	702211-B21
HP InfiniBand FDR/Ethernet 10Gb/40Gb 2-port 544+QSFP Adapter	764284-B21
HP InfiniBand FDR/Ethernet 10Gb/40Gb 2-port 544+FLR-QSFP Adapter	764285-B21

NOTE: Adapter which can be installed in the FlexibleLOM slot

HP InfiniBand QDR/Ethernet 10Gb 2-port 544+FLR-QSFP Adapter	764286-B21
---	------------

NOTE: Adapter which can be installed in the FlexibleLOM slot

NOTE: Please see the [HP InfiniBand Options for HP ProLiant and Integrity Servers QuickSpecs](#) for additional information.

HP I/O Expansion Options

HP ProLiant DL560 Gen9 Secondary 3 Slot Riser Kit	793474-B21
---	------------

NOTE: This is an optional kit which can only be utilized when system is populated with at least two (2) processors.

HP Power Supplies

HP Common Slot Power Supply Kits

HP 1500W Common Slot Platinum Plus Hot Plug Power Supply Kit	684532-B21
--	------------

NOTE: 94% efficiency with support for HP Power Discovery Services.

NOTE: 1500W Common Slot Platinum Plus Hot Plug Power Supplies only support High Line Voltage.

HP 1500W Common Slot 48VDC Hot Plug Power Supply Kit	746708-B21
--	------------

HP 1200W Common Slot Platinum Plus Hot Plug Power Supply Kit	656364-B21
--	------------

NOTE: 94% efficiency with support for HP Power Discovery Services.

HP 1200W Common Slot Platinum Hot Plug Power Supply Kit	748287-B21
---	------------

NOTE: Prior to making a power supply selection it is highly recommended that the HP Power Advisor is run to determine the right size power supply for your server

Core Options

configuration. The HP Power Advisor is located at:

<http://www.hp.com/go/hppoweradvisor>.

NOTE: All power supplies in a server should match. Mixing Power Supplies is not supported.

NOTE: Option Kits contain the specified power supply and a PDU IEC cable.

NOTE: HP ProLiant servers ship with an IEC-IEC power cord used for rack mounting with Power Distribution Units (PDUs). For a full list of optional HP power cords please go to:

<http://www.hp.com/products/powercords>.

Additional Options

NOTE: Some options may not be integrated at the factory. To ensure only valid configurations are ordered, HP recommends the use of an HP approved configurator. Contact your local sales representative for additional information.

HP Insight Software	HP Insight Control	
	HP Insight Control including 1yr 24x7 Technical Support and Updates Single Server License	C6N27A
	HP Insight Control Server Provisioning Media Kit	BD883A
	HP Insight Control including 1yr 24x7 Support ProLiant ML/DL/BL-bundle Single Server FIO License	C6N36A
	NOTE: Electronic and Flexible-Quantity licenses can be used to purchase multiple licenses with a single activation key.	
	NOTE: Customer will receive a license entitlement certificate. The license entitlement certificate must be redeemed online or via fax in order to obtain the license activation key(s). Includes one year of 24 x 7 HP Software Technical Support and Update Service.	
	NOTE: Licenses ship without media. The HP Insight Control Media Kit can be ordered separately, or can be downloaded at: http://www.hp.com/go/insightupdates .	
	NOTE: For additional license options please see the HP Insight Control QuickSpecs .	
	HP Integrated Lights-Out (iLO) Advanced for ProLiant	
	HP iLO Advanced including 1yr 24x7 Technical Support and Updates Single Server License	512485-B21
	HP iLO Advanced 1 Server License with 3yr 24x7 Tech Support and Updates	BD505A
	HP iLO Advanced including 1yr 24x7 Technical Support and Updates E-LTU	E6U59ABE
	HP iLO Advanced including 3yr 24x7 Technical Support and Updates E-LTU	E6U64ABE
	NOTE: For additional license options please see the HP Integrated Lights-Out (iLO) QuickSpecs .	
	NOTE: For more information, visit: http://www.hp.com/go/ilo .	

HP Converged Infrastructure Management Software	HP OneView Advanced (with HP iLO Advanced)	
	HP OneView incl 3yr 24x7 Supp Phys 1 Svr Lic	E5Y34A
	HP OneView incl 3yr 24x7 Supp Flex Qty E-LTU	E5Y35AAE
	HP OneView for ProLiant DL Server incl 3yr 24x7 Supp FIO Bundle Physical 1 Svr Lic	E5Y43A
	HP Operations Analytics for HP OneView LTU	K8G29A
	HP Operations Analytics for HP OneView E-LTU	K8G29AAE
	HP OneView Media Kit Phys No Lic	E5Y37A
	NOTE: Full licenses of HP OneView Advanced also provide the right-to-use HP Insight Control without additional charge.	
	NOTE: Server provisioning (via 'HP Insight Control server provisioning') is licensed as part of HP OneView Advanced and provides multi-server OS and driver provisioning. Media kit #BD883A can be ordered for a physical copy of this software (USB flash drive).	
	NOTE: Licenses ship without media. The HP OneView Media Kit can be ordered separately, or can be downloaded at: http://www.hp.com/go/oneview .	
	NOTE: Electronic and Flexible-Quantity licenses can be used to purchase multiple licenses with a single activation key.	
	Please see the HP OneView QuickSpecs for Technical Specifications and additional information.	

High Performance Clusters	SUSE Linux Enterprise Server HPC Compute Node 1-2 Sockets 3 Year Subscription Flx LTU	M6K35A
	SUSE Linux Enterprise Server HPC Compute Node 1-2 Sockets 3 Year Subscription E-LTU	M6K35AAE
	SUSE Linux Enterprise Server HPC Head Node 1-2 Sockets 3 Year Subscription 24x7 Support Flx LTU	M6K36A
	SUSE Linux Enterprise Server HPC Head Node 1-2 Sockets 3 Year Subscription 24x7 Support E-LTU	M6K36AAE

HP PCIe Workload Accelerator Options	Value Endurance (VE) PCIe Workload Accelerators	
	HP 6.4TB FH/HL Value Endurance (VE) PCIe Workload Accelerator	763840-B21
	HP 3.2TB HH/HL Value Endurance (VE) PCIe Workload Accelerator	763838-B21
	HP 1.6TB HH/HL Value Endurance (VE) PCIe Workload Accelerator	763836-B21
	HP 1.3TB HH/HL Value Endurance (VE) PCIe Workload Accelerator	763834-B21

Additional Options

Light Endurance (LE) PCIe Workload Accelerators

HP 5.2TB FH/HL Light Endurance (LE) PCIe Workload Accelerator	775672-B21
HP 2.6TB HH/HL Light Endurance (LE) PCIe Workload Accelerator	775670-B21
HP 1.3TB HH/HL Light Endurance (LE) PCIe Workload Accelerator	775668-B21
HP 1.0TB HH/HL Light Endurance (LE) PCIe Workload Accelerator	775666-B21

NVMe PCIe Workload Accelerators

HP 1.6TB NVMe Mixed Use HH/HL PCIe Workload Accelerator	803202-B21
HP 1.6TB NVMe Write Intensive HH/HL PCIe Workload Accelerator	803197-B21
HP 2.0TB NVMe Mixed Use HH/HL PCIe Workload Accelerator	803204-B21
HP 800GB NVMe Mixed Use HH/HL PCIe Workload Accelerator	803200-B21
HP 800GB NVMe Write Intensive HH/HL PCIe Workload Accelerator	803195-B21

HP Storage Controllers

SAS Controllers

HP Smart Array Controllers

HP Smart Array P440/4GB FBWC 12Gb 1-port Int SAS Controller	726821-B21
HP Smart Array P440/4GB FBWC 12Gb 1-port Int FIO SAS Controller	761872-B21
HP Smart Array P840/4GB FBWC 12Gb 2-ports Int SAS Controller	726897-B21
HP Smart Array P840/4GB FBWC 12Gb 2-ports Int FIO SAS Controller	761874-B21
HP Smart Array P441/4GB FBWC 12Gb 2-ports Ext SAS Controller	726825-B21
HP Smart Array P841/4GB FBWC 12Gb 4-ports Ext SAS Controller	726903-B21

HP Flexible Smart Array Controllers

HP Smart Array P440ar/2GB FBWC 12Gb 2-ports Int SAS Controller	726736-B21
HP Smart Array P440ar/2GB FBWC 12Gb 2-ports Int FIO SAS Controller	749974-B21

HP Host Bus Adapter

HP H240ar 12Gb 2-ports Int Smart Host Bus Adapter	726757-B21
NOTE: Daughterboard card controller providing for direct attached storage without using a PCIe slot.	
HP H240ar 12Gb 2-ports Int FIO Smart Host Bus Adapter	749976-B21
NOTE: Daughterboard card controller providing for direct attached storage without using a PCIe slot.	
HP H240 12Gb 2-ports Int Smart Host Bus Adapter	726907-B21
HP H240 12Gb 2-ports Int FIO Smart Host Bus Adapter	761873-B21
HP H241 12Gb 2-ports Ext Smart Host Bus Adapter	726911-B21

Optional Upgrades

HP 96W Smart Storage Battery with 145mm Cable for DL/ML/SL Servers	727258-B21
--	------------

NOTE: If the server has an additional HP Smart Array P441/4G Controller, HP Smart Array P841/4G, or HP H241 controller selected and it does not have at least one of the following internal Controllers: HP Smart Array P440ar/2G FIO Controller or HP Smart Array P440/4G FIO Controller or HP Smart Array P840/4G FIO Controller, then the HP 96W Smart Storage Battery is required.

HP ProLiant DL560 Gen9 SAS Expander Card	804228-B21
--	------------

NOTE: The card has 24 ports for expansion.

HP ProLiant DL560 Gen9 Bay3 to H240 Slot 7/ Bay 3 to P840/440 Riser1 and 2SFF-UMBay SAS Cable Kit	797924-B21
---	------------

NOTE: Required for connecting Bay1 UMB 2SFF to a P840/P440 controller, or if using controller H240 in slot7 attached to Bay3. Also needed if using controller P840/P440 in riser1 attached to Bay3.

HP ProLiant DL 560 Gen9 Bay 1 to Riser1/AROC and Bay 2/3 to Riser2/Slot7 SAS Cable Kit	797945-B21
--	------------

NOTE: Required if controllers H240/P440ar/H240ar/B140i in riser1/AROC (Smart Array HBA Connector) need to be connected to Bay1, or if controllers P840/P440 in Riser2/slot7 need to be connected to Bay2/3. Also needed if controller P440 in slot7 needs to be connected to Bay2/3.

NOTE: Required if using controllers H240/P440ar/H240ar/B140i in riser1/AROC (Smart Array HBA Connector) which need to be connected to Bay2, or if using controllers P840/P440 in Riser1/2 which need to be connected to Bay2/3.

Additional Options

HP ProLiant DL560 Gen9 Bay 2 to Riser1/AROC and Bay 2/3 to Riser1/2 SAS Cable Kit

797946-B21

HP Tape Backup

NOTE: For the complete range of tape drives, autoloaders, libraries and media see: <http://www.hp.com/go/tape>. For hardware and software compatibility of HP tape backup products see: <http://www.hp.com/storage/SPOCK> and <http://www.hp.com/go/ebs>.

NOTE: For Internal drives to be connected to DL servers please make sure that you order rack mount kits as well.

Tape Autoloaders

HP 1/8 G2 Tape Autoloader

HP StoreEver 1/8 G2 LTO-6 Ultrium 6250 SAS Tape Autoloader COH18A

HP StoreEver 1U SAS Rack-mount Kit AE459B

HP MSL2024 Tape Library

HP MSL2024 0-Drive Tape Library AK379A

HP MSL4048 Tape Library

HP MSL4048 0-Drive Tape Library AK381A

HP Mini SAS High Density to 4-lane Mini SAS External Fanout 2 Meter Cable K2R09A

HP Mini SAS High Density to 4-lane Mini SAS External Fanout 4 Meter Cable K2R10A

HP StoreEver MSL6480

HP StoreEver MSL6480 Scaleable Expansion Module QU626A

HP StoreEver MSL6480 Scalable Base Module QU625A

Tape Drives

HP StoreEver LTO-3 Ultrium 920 SAS External Tape Drive EH848B

HP StoreEver LTO-5 Ultrium 3280 SAS External Tape Drive EH900B

HP StoreEver LTO-4 Ultrium 1760 SAS External Tape Drive EH920B

HP StoreEver LTO-4 Ultrium 1760 SCSI External Tape Drive EH922B

HP StoreEver LTO-5 Ultrium 3000 SAS External Tape Drive EH958B

HP StoreEver LTO-5 Ultrium 3280 SAS Tape Drive in 3U Rack-mount EJ013B

HP StoreEver LTO-5 Ultrium 3000 SAS Tape Drive in 1U Rack-mount EJ014B

HP StoreEver LTO-4 Ultrium 1760 SAS (1) in 1U Rack-mount Kit EH946C

HP StoreEver LTO-6 Ultrium 6250 Tape Drive in 1U Rack-mount Kit COL99A

HP StoreEver LTO-6 Ultrium 6650 SAS External Tape Drive EH964A

HP StoreEver LTO-6 Ultrium 6250 External Tape Drive EH970A

HP Disk Backup

HP RDX Removable Disk Backup System

HP RDX320 USB3.0 External Disk Backup System B7B63A

HP RDX500 USB 3.0 External Disk Backup System B7B66A

HP RDX1000 USB 3.0 External Disk Backup System B7B69A

HP RDX 2TB USB3.0 External Disk Backup System E7X53A

HP D3700 Enclosure QW967A

HP D3600 Enclosure QW968A

NOTE: For the complete range of RDX drives and media see:

<http://www.hp.com/go/rdx>. For hardware and software compatibility of HP disk backup products see: <http://www.hp.com/storage/SPOCK>.

NOTE: For Internal drives to be connected to DL servers please make sure that you order rack mount kit as well.

HP Storage Options

QLogic Fibre Channel HBAs

HP 81Q 8Gb 1-port PCIe Fibre Channel Host Bus Adapter AK344A

HP 82Q 8Gb 2-port PCIe Fibre Channel Host Bus Adapter AJ764A

HP StoreFabric SN1000Q 16GB 1-port PCIe Fibre Channel Host Bus Adapter QW971A

HP StoreFabric SN1000Q 16GB 2-port PCIe Fibre Channel Host Bus Adapter QW972A

Emulex Fibre Channel HBAs

HP 81E 8Gb 1-port PCIe Fibre Channel Host Bus Adapter AJ762B

HP 82E 8Gb 2-port PCIe Fibre Channel Host Bus Adapter AJ763B

HP StoreFabric SN1100E 16Gb Single Port Fibre Channel Host Bus Adapter C8R38A

Additional Options

HP StoreFabric SN1100E 16Gb Dual Port Fibre Channel Host Bus Adapter	C8R39A
HP Converged Network Adapters	
HP StoreFabric CN1100R Dual Port Converged Network Adapter	QW990A
HP StoreFabric CN1200E 10Gb Converged Network Adapter	E7Y06A

HP Disk Storage Systems

Disk Enclosures

HP D6000 w/35 4TB 6G SAS 7.2K LFF Dual Port MDL HDD 140TB Bundle	E7W30A
HP D6000 w/70 4TB 6G SAS 7.2K LFF Dual Port MDL HDD 280TB Bundle	E7W31A
HP D6000 Dual I/O Module Disk Enclosure	QQ695A
HP D6000 w/35 2TB 6G SAS 7.2K LFF Dual port MDL HDD 70TB Bundle	QQ697A
HP D6000 w/70 2TB 6G SAS 7.2K LFF Dual port MDL HDD 140TB Bundle	QQ698A
HP D6000 w/35 3TB 6G SAS 7.2K LFF Dual port MDL HDD 105TB Bundle	QQ699A
HP D6000 w/70 3TB 6G SAS 7.2K LFF Dual port MDL HDD 210TB Bundle	QQ700A
NOTE: Please see the HP D6000 Disk Enclosure QuickSpecs for Technical Specifications and additional information.	
HP D2600 w/12 4TB 6G SAS 7.2K LFF Dual Port MDL HDD 48TB Bundle	E7W32A
NOTE: Please see the HP D2000 Disk Enclosures QuickSpecs for Technical Specifications and additional information.	

HP Data Center Racks

HP 11000 G2 Series Racks

HP 11648 1075mm Pallet Universal Rack	H6J87A
HP 11648 1075mm Shock Universal Rack	H6J88A
HP 11642 1075mm Pallet Universal Rack	H6J65A
HP 11642 1075mm Shock Universal Rack	H6J66A
HP 11642 1200mm Pallet Universal Rack	H6J67A
HP 11642 1200mm Shock Universal Rack	H6J68A
HP 11636 1075mm Pallet Universal Rack	H6J77A
HP 11636 1075mm Shock Universal Rack	H6J78A
HP 11622 G2 1075mm Pallet Universal Rack	H6J83A
HP 11622 G2 1075mm Shock Universal Rack	H6J84A
HP 11614 1075mm Shock Universal Rack	H6J82A

NOTE: Please see the [HP 11000 G2 Series Racks QuickSpecs](#) for information on additional racks options and rack specifications.

HP Intelligent Series Rack

HP 647 1075mm Pallet Intelligent Series Rack	BW911A
HP 647 1075mm Shock Intelligent Series Rack	BW912A
HP 647 1200mm Pallet Intelligent Series Rack	BW913A
HP 647 1200mm Shock Intelligent Series Rack	BW914A
HP 642 1075mm Pallet Intelligent Series Rack	BW903A
HP 642 1075mm Shock Intelligent Series Rack	BW904A
HP 642 1200mm Pallet Intelligent Series Rack	BW907A
HP 642 1200mm Shock Intelligent Series Rack	BW908A
HP 636 1075mm Pallet Intelligent Series Rack	BW895A
HP 636 1075mm Shock Intelligent Series Rack	BW896A
HP 842 1075mm Pallet Intelligent Series Rack	BW917A
HP 842 1075mm Shock Intelligent Series Rack	BW918A

NOTE: Please see the [HP Intelligent Series Racks QuickSpecs](#) for information on additional racks options and rack specifications.

HP Value Series Rack

HP V142 1075mm deep Pallet 100 series Rack	AF046A
--	--------

NOTE: Please see the [HP Value Series Rack QuickSpecs](#) for information on additional racks options and rack specifications.

Additional Options

HP Power Distribution Units (PDUs)

HP Basic Power Distribution Unit (bPDU)

HP Basic Power Distribution Unit: 1U/0U Version

HP 1.9kVA 120 Volt L5-20 Input (12xNEMA 5-20R) NA/JP Basic PDU	H5M54A
HP 3.6kVA 200-240 Volt Detachable C20 Input (12xC13) WW Basic PDU	H5M56A
HP 2.8kVA 24A Low Voltage NA/JP Modular Power Distribution Unit	252663-D71
HP 4.9kVA 24A High Voltage NA/JP Core Modular Power Distribution Unit	252663-D74
HP 8.3kVA 40A High Voltage NA/JP Core Modular Power Distribution Unit	252663-D75
HP 7.3kVA 32A High Voltage INTL Core Modular Power Distribution Unit	252663-B33
HP 9.2kVA 40A High Voltage INTL Core Modular Power Distribution Unit	252663-B34
HP 8.6kVA 24A Three Phase NA/JP Modular Power Distribution Unit	AF512A
HP 11kVA 16A Three Phase INTL Modular Power Distribution Unit	AF513A
HP 14.4kVA 40A Three Phase NA/JP Modular Power Distribution Unit	AF519A
HP 17.3kVA 48A Three Phase NA/JP Modular Power Distribution Unit	AF511A
HP 22kVA 32A Three Phase INTL Core Modular Power Distribution Unit	AF518A

HP Basic Power Distribution Unit: Half Height Version

HP 2.8kVA 120 Volt L5-30 Input (18xNEMA 5-20R) NA/JP Basic PDU	H5M55A
HP 3.6kVA 200-240 Volt Detachable C20 Input (18xC13) WW Basic PDU	H5M57A
HP 4.9kVA 208 Volt L6-30 Input (20xC13) NA/JP Basic PDU	H5M58A
HP 7.3kVA 230 Volt IEC309 32A Input (20xC13) INTL Basic PDU	H5M68A
HP 8.6kVA 208 Volt L15-30 3-Phase Input (18xC13) NA/JP Basic PDU	H5M61A

HP Basic Power Distribution Unit: Mid Height Version

HP 4.9kVA 208 Volt L6-30 Input (24xC13/6xC19) NA/JP Basic PDU	H5M59A
HP 7.3kVA 230 Volt IEC309 32A Input (24xC13/6xC19) INTL Basic PDU	H5M70A
HP 8.3kVA 208 Volt CS8265C Input (30xC13/6xC19) NA/JP Basic PDU	H5M60A
HP 11kVA 230 Volt IEC309 63A Input (30xC13/6xC19) INTL Basic PDU	H5M71A
HP Hardwired 200-240 Volt Input (30xC13/6xC19) WW Basic PDU	H5M75A
HP 5.7kVA 208 Volt L21-20 3-Phase Input (24xC13/3xNEMA 5-20R) NA/JP Basic PDU	H5M63A
HP 8.6kVA 208 Volt L21-30 3-Phase Input (24xC13/3xC19/3xNEMA 5-20R) NA/JP Basic PDU	H5M64A
HP 8.6kVA 208 Volt L15-30 3-Phase Input (24xC13/6xC19) NA/JP Basic PDU	H5M62A
HP 11kVA 400 Volt IEC309 16A 3-Phase Input (30xC13/6xC19) INTL Basic PDU	H5M72A

HP Basic Power Distribution Unit: Full Height Version

HP 11kVA 400 Volt IEC309 16A 3-Phase Input (36xC13/6xC19) INTL Basic PDU	H5M73A
HP 11kVA 400 Volt IEC309 30A 3-Phase Input (36xC13/6xC19) NA Basic PDU	H5M67A

HP Basic Power Distribution Unit: 480/277 Volt Version

HP 19.9kVA 480 Volt IEC309 30A 3-Phase Input (30 Outlet) NA Basic PDU	H3X08A
HP 800VA - 277V Input / 230V Output NA Rack Mount Transformer	H3X09A

NOTE: Please see the [HP Basic Power Distribution Units QuickSpecs](#) for information on additional options and product specifications.

NOTE: To learn more about HP Basic Power Distribution Units (bPDU), please visit the HP website at <http://www.hp.com/go/pdu>.

NOTE: Additional HP Power Distribution Units are available. For a complete list of all HP PDUs and additional information please visit: <http://www.hp.com/go/rackandpower>.

HP Remote Monitoring Power Distribution Units (mPDU)

HP Remote Monitored Power Distribution Unit: 1U Version

HP 2.8kVA 120 Volt L5-30 Input (12xNEMA 5-20R)NA/JP Monitored PDU	D9N43A
HP 3.6kVA 200-240 Volt Detachable C20 Input (12xC13) WW Monitored PDU	D9N46A
HP 4.9kVA 208 Volt L6-30 Input (12xC13) NA/JP Monitored PDU	D9N44A
HP 4.9kVA 208 Volt L6-30 Input (12xC13) NA/JP Monitored PDU	G9Z05A
HP 7.3kVA 230 Volt IEC309 32A Input (12xC13) INTL Monitored PDU	G9Z06A
HP 17.3kVA 208 Volt IEC309 60A 3-Phase Watertight Input (12xC13/12xC19) NA/JP Monitored PDU	G9Z07A
HP 22kVA 400 Volt IEC309 32A 3-Phase Watertight Input (12xC13/12xC19) INTL Monitored PDU	G9Z08A

HP Remote Monitored Power Distribution Unit: Half Height Version

HP 3.6kVA 200-240 Volt Detachable C20 Input (16xC13) WW Monitored PDU	D9N45A
---	--------

HP Remote Monitored Power Distribution Unit: Mid Height Version

Additional Options

HP 4.9kVA 208 Volt L6-30 Input (20xC13/4xC19) NA/JP Monitored PDU	D9N47A
HP 7.3kVA 230 Volt IEC309 32A Input (20xC13/4xC19) INTL Monitored PDU	D9N48A
HP 8.6kVA 208 Volt L15-30 3-Phase Input (18xC13/3xC19) NA/JP Monitored PDU	D9N51A
HP 5.7kVA 208 Volt L21-20 3-Phase Input (18xC13/3xNEMA 5-20R) NA/JP Monitored PDU	D9N52A
HP 8.6kVA 208 Volt L21-30 3-Phase Input (20xC13/3xC19/3xNEMA 5-20R) NA/JP Monitored PDU	D9N53A
HP 11kVA 400 Volt IEC309 16A 3-Phase Input (18xC13/3xC19) INTL Monitored PDU	D9N55A
HP Remote Monitored Power Distribution Unit: Full Height Version	
HP 8.3kVA 208 Volt CS8265C Input (30xC13/3xC19) NA Monitored PDU	D9N49A
HP 7.3kVA 230 Volt IEC309 32A Input (32xC13/4xC19) INTL Monitored PDU	D9N50A
HP 11kVA 400 Volt IEC309 16A 3-Phase Input (30xC13/3xC19) INTL Monitored PDU	D9N57A
HP 14.4kVA 208 Volt CS8365C 3-Phase Input (12xC13/12xC19)NA Monitored PDU	D9N58A
HP 16.6kVA 400 Volt IEC309 30A 3-Phase Input (30xC13/3xC19) NA Monitored PDU	D9N61A
HP 17.3kVA 208 Volt IEC309 60A 3-Phase Input (24xC13/3xC19) NA/JP Monitored PDU	D9N54A
HP 17.3kVA 208 Volt IEC309 60A 3-Phase Input (12xC13/12xC19) NA/JP Monitored PDU	D9N59A
HP 22kVA 400 Volt IEC309 32A 3-Phase Input (12xC13/12xC19) INTL Monitored PDU	D9N60A
HP 22kVA 400 Volt IEC309 32A 3-Phase Input (30xC13/3xC19) INTL Monitored PDU	D9N56A
HP 16.6kVA 400 Volt IEC309 30A 3-Phase Input (12xC13/12xC19) NA Monitored PDU	D9N62A
HP 19.9kVA 480 Volt 3-Phase (30 Outlet) NA Monitored PDU	D9N63A
HP Environmental Sensor for Remote Monitored PDUs	
HP Environmental Sensor for Remote Monitored and Managed PDUs	E2D53A
NOTE: Please see the HP Remote Monitored Power Distribution Units QuickSpecs for information on additional options and product specifications.	
HP Intelligent Power Distribution Units (iPDU)	
iPDU Core Units	
HP 4.9kVA 24A Single Phase NA/JP Core Intelligent Modular Power Distribution Unit	AF520A
HP 8.3kVA 40A Single Phase NA/JP Core Intelligent Modular Power Distribution Unit	AF521A
HP 8.6kVA 24A Three Phase NA/JP Core Intelligent Modular Power Distribution Unit	AF522A
HP 14.4kVA 40A Three Phase NA/JP Intelligent Modular Power Distribution Unit	AF533A
HP 17.3kVA 48A Three Phase NA/JP Core Intelligent Modular Power Distribution Unit	AF523A
HP 7.3kVA 32A Single Phase INTL Core Intelligent Modular Power Distribution Unit	AF525A
HP 11kVA 16A Three Phase INTL Core Intelligent Modular Power Distribution Unit	AF526A
HP 22kVA 32A Three Phase INTL Core Intelligent Modular Power Distribution Unit	AF527A
HP 11.4kVA 16A 415V Three Phase L22-20 NA Core Intelligent Power Distribution Unit	AF900A
HP 17.3kVA 24A 415V Three Phase IEC309 NA Core Intelligent Power Distribution Unit	AF901A
HP 17.3kVA 48A 208V Three Phase 12 Outlet Core NA/JP Intelligent Power Distribution Unit	AF535A
HP 17.3kVA 24A 415V Three Phase 12 Outlet Core NA/JP Intelligent Power Distribution Unit	AF537A
HP 22kVA 32A 400V Three Phase 12 Outlet Core INTL Intelligent Power Distribution Unit	AF538A
NOTE: Please see the HP Intelligent Power Distribution Units QuickSpecs for information on additional options and product specifications.	
HP Managed Power Distribution Units (maPDU)	
HP 2.8kVA 120 Volt L5-30 Input (24x NEMA 5-20) NA/JP Managed PDU	H8B48A
HP 3.6kVA 200-240 Volt Detachable C20 Input (7xC13/1xC19) WW Managed PDU	H8B49A
HP 4.9kVA 208 Volt L6-30 Input (20xC13/4xC19) NA/JP Managed PDU	H8B50A
HP 7.3kVA 200-240 Volt IEC309 32A Input (20xC13/4xC19) INTL Managed PDU	H8B51A
HP 8.6kVA 208 Volt L15-30 3 Phase Input (18xC13/6xC19) NA/JP Managed PDU	H8B52A
HP 8.6kVA 208 Volt L21-30 3 Phase Input (20xC13/3xC19/1x NEMA 5-20) NA/JP Managed PDU	H8B53A
HP 11kVA 400 Volt IEC309 16A 3 Phase Input (21xC13/3xC19) INTL Managed PDU	H8B54A
HP 14.4kVA 208V CS8365C 3 Phase Input (12xC13/12xC19) NA/JP Managed PDU	H8B55A
HP 17.3kVA 208V IEC309 60A 3 Phase Input (12xC13/12xC19) NA/JP Managed PDU	H8B56A
NOTE: Please see the HP Managed Power Distribution Units QuickSpecs for information on additional options and product specifications.	
iPDU Kits with Standard Extension Bars	
HP 4.9kVA 24A Single Phase NA/JP Intelligent Modular Power Distribution Kit	AF531A

Additional Options

HP 8.6kVA 24A Three Phase NA/JP Intelligent Modular Power Distribution Kit	AF532A
HP 7.3kVA 32A Single Phase INTL Intelligent Modular Power Distribution Kit	AF534A
iPDU Extension Bars	
HP 5xC13 Intelligent PDU Extension Bar G2 Kit	AF547A
HP 5xC13 Outlets Power and UID LEDs Pair Standard Extension Bar	AF528A
NOTE: To learn more, please visit the HP Uninterruptible Power Systems (UPS) web page .	

HP Rack Mount Consoles, KVM Switches, and Keyboards

HP Location Discovery Services

HP Location Discovery Services LCD8500 Kit	TL052A
--	--------

HP Rack Mount Consoles

HP LCD8500 1U US Rackmount Console Kit	AF630A
HP LCD8500 1U UK Rackmount Console Kit	AF631A
HP LCD8500 1U DE Rackmount Console Kit	AF632A
HP LCD8500 1U FR Rackmount Console Kit	AF633A
HP LCD8500 1U JP Rackmount Console Kit	AF642A
HP LCD8500 1U RU Rackmount Console Kit	AF643A
HP LCD8500 1U INTL Rackmount Console Kit	AF644A
HP LCD8500 1U US TAA Rackmount Console Kit	AF645A

HP KVM Switches

HP TAA 0x2x16 G3 KVM Console Switch	AF653A
HP USB Remote Access Key for G3 KVM Console Switches	AF650A
HP KVM Console USB Interface Adapter	AF628A
HP KVM Console USB 2.0 Virtual Media CAC Interface Adapter	AF629A

HP USB Keyboard and Mouse

HP USB BFR with PVC Free US Keyboard/Mouse Kit	631341-B21
HP USB BFR with PVC Free UK Keyboard/Mouse Kit	631344-B21
HP USB BFR with PVC Free FR Keyboard/Mouse Kit	631346-B21
HP USB BFR with PVC Free ES Keyboard/Mouse Kit	631348-B21
HP USB BFR with PVC Free DE Keyboard/Mouse Kit	631358-B21
HP USB BFR with PVC Free JP Keyboard/Mouse Kit	631360-B21
HP USB BFR with PVC Free IT Keyboard/Mouse Kit	631362-B21
HP USB BFR with PVC Free CN Keyboard/Mouse Kit	631364-B21
HP USB BFR with PVC Free AE Keyboard/Mouse Kit	638212-B21
HP USB BFR with PVC Free RU Keyboard/Mouse Kit	638214-B21
HP USB BFR with PVC Free IN Keyboard/Mouse Kit	672097-D63
HP USB BFR with PVC Free AP-Intl Keyboard/Mouse Kit	672097-373
HP USB BFR with PVC Free Intl Keyboard/Mouse Kit	672097-B33
HP USB BFR with PVC Free PT Keyboard/Mouse Kit	672097-133
HP USB BFR with PVC Free TR Keyboard/Mouse Kit	672097-143
HP USB BFR with PVC Free CZ Keyboard/Mouse Kit	672097-223
HP USB BFR with PVC Free FI Keyboard/Mouse Kit	672097-353
HP USB BFR with PVC Free SE Keyboard/Mouse Kit	672097-103
HP USB BFR with PVC Free CH Keyboard/Mouse Kit	672097-113
HP USB BFR with PVC Free KR Keyboard/Mouse Kit	672097-KD3
HP 1U INT Rackmount Keyboard with USB	AG086A
HP 1U US Rackmount Keyboard with USB	AG072A

NOTE: Please see the QuickSpecs for Technical Specifications and additional information: http://h18000.www1.hp.com/products/quickspecs/13972_div/13972_div.html (Worldwide).

HP Server Console Switches

HP 0x1x8 G3 KVM Console Switch	AF651A
HP 0x2x16 G3 KVM Console Switch	AF652A

HP Server Console Switch G2 with Virtual Media & CAC

HP 0x2x16 KVM Server Console Switch G2 with Virtual Media CAC Software	AF618A
HP 0x2x32 KVM Server Console Switch G2 with Virtual Media CAC Software	AF619A

Additional Options

HP IP Console Switch G2 with Virtual Media & CAC

HP 1x4 USB/PS2 KVM Console Switch	AF611A
HP 1x1Ex8 KVM IP Console Switch G2 with Virtual Media CAC Software	AF620A
HP 2x1Ex16 KVM IP Console Switch G2 with Virtual Media CAC Software	AF621A
HP 4x1Ex32 KVM IP Console Switch G2 with Virtual Media CAC Software	AF622A

NOTE: Please see the QuickSpecs for Technical Specifications and additional information:

http://h18000.www1.hp.com/products/quickspecs/13474_div/13474_div.html
(Worldwide).

Rail Kits

NOTE: Gen9 rail kits have changed significantly from prior generation rail kits. Please take a moment to review the installation documentation that comes with the server to help you with the installation of your Gen9 server.

NOTE: Rail kits are optional for DL560 Gen9 and are no longer included standard with the server. Customers have the option to purchase their server without a rail kit.

NOTE: Ball bearing and Easy Install rail kits contain telescoping rails which allow for in-rack serviceability.

Caution: HP recommends that a minimum of two people are required for all Rack Server installations. Please refer to your installation instructions for proper tools and number of people to use for any installation.

HP 2U Large Form Factor Easy Install Rail Kit	733662-B21
NOTE: Does not include CMA (733664-B21).	
HP 2U Cable Management Arm for Easy Install Rail Kit	733664-B21
HP 2U Large Form Factor Ball Bearing Rail Kit	720864-B21
NOTE: Does not include CMA (720865-B21).	
HP 2U Cable Management Arm for Ball Bearing Rail Kit	720865-B21

HP Other Options

HP Rack LED Light Kit	BW939A
HP Kit LCD 1.83m Latch Display Port Cable	G7T29A
HP Advanced Power Manager Kit	741192-B21
HP ConvergedSystem Door Branding Kit	TK815A
HP ConvergedSystem Rack Light Kit	TK816A
HP ConvergedSystem Rack Side Panel 1075mm Kit	TK817A

HP Uninterruptible Power Systems (UPS)

HP DirectFlow Three Phase UPS Power Unit (1U UPS)

HP R12000 DirectFlow - 1U Rackmount Uninterruptible Power System	G9Y75A
HP R12000 DirectFlow - POD 1U Rackmount Uninterruptible Power System	AF478A

Input/Output Module Options for 1U UPS

HP 32A 400-415 Volt Three Phase INTL R12000 DirectFlow UPS IEC309 Input/Output Module	AF488A
HP 30A 400-415 Volt Three Phase NA R10000 DirectFlow UPS IEC309 Input/Output Module	AF489A
HP 32A 380 Volt Three Phase China R12000 DirectFlow UPS Unterminated Input/Output Module	AF490A
HP 30A 480 Volt Three Phase NA R12000 DirectFlow UPS L22-30 Input/Output Module	AF491A
HP 30A 480 Volt Three Phase NA R12000 DirectFlow UPS IEC309 Input/Output Module	AF492A
HP 30A 400-415 Volt Three Phase NA R12000 DirectFlow UPS IEC309 Input/Output Module	G9Y76A
HP DirectFlow UPS Management Card	AF493A

Power Unit (2U UPS)

HP R18000 DirectFlow - 2U Rackmount Uninterruptible Power System	AF479A
--	--------

Input/Output Module Options for 2U UPS

HP 32A 400-415 Volt Three Phase INTL R18000 DirectFlow UPS IEC309 Input/Output Module	AF483A
HP 30A 380 Volt Three Phase China R18000 DirectFlow UPS Unterminated Input/Output Module	AF485A
HP 30A 480 Volt Three Phase NA R18000 DirectFlow UPS IEC309 Input/Output Module	AF486A
HP 30A 480 Volt Three Phase NA R18000 DirectFlow UPS IEC309 Input/Output Module	AF487A
HP 30A 400 Volt Three Phase NA R18000 DirectFlow UPS IEC309 Input/Output Module	D9Q02A
HP 30A 400-415V Three Phase NA R18000 DirectFlow UPS 1:1 IEC309 Input/Output Module	AF484A

NOTE: All Input/Output Modules support dual output outlets except the AF484A.

Battery Pack Options

Additional Options

HP DirectFlow UPS - 1U Rackmount Lithium-ion Battery Pack	AF480A
HP DirectFlow UPS - 3U Rackmount VRLA Battery Pack	AF482A
HP WW DirectFlow Secondary Battery Cable	AF497A

NOTE: Please see the [HP DirectFlow Three Phase Uninterruptible Power System QuickSpecs](#) for information on additional options and product specifications.

HP Tower UPS

HP T750 G4 UPS Models

HP T750 G4 NA/JP Uninterruptible Power System	J2P85A
HP T750 G4 INTL Uninterruptible Power System	J2P88A

HP T1000 G4 UPS Models

HP T1000 G4 NA/JP Uninterruptible Power System	J2P86A
HP T1000 G4 INTL Uninterruptible Power System	J2P89A

HP T1500 G4 UPS Models

HP T1500 G4 NA/JP Uninterruptible Power System	J2P87A
HP T1500 G4 INTL Uninterruptible Power System	J2P90A

HP Rack/Tower UPS

HP R/T2200 G4 UPS Models

HP R/T2200 G4 NA/JP Uninterruptible Power System	J2R00A
--	--------

HP R/T3000 G4 UPS Models

HP R/T3000 G4 Low Voltage NA/JP Uninterruptible Power System	J2R01A
HP R/T3000 G4 High Voltage NA/JP Uninterruptible Power System	J2R02A
HP R/T3000 G4 High Voltage INTL Uninterruptible Power System	J2R04A

R1500 G4 Models

HP R1500 G4 NA Uninterruptible Power System	J2Q99A
HP R1500 G4 JP/TWN Uninterruptible Power System	J2R05A
HP R1500 G4 INTL Uninterruptible Power System	J2R03A

R7000 Uninterruptible Power System (UPS)

HP R7000 4U 50A High Voltage NA/JP Uninterruptible Power System	AF462A
HP R7000 4U IEC-32A High Voltage INTL Uninterruptible Power System	AF463A

R5000 Uninterruptible Power System (UPS)

HP R5000 3U L630 High Voltage NA/JP Uninterruptible Power System	AF460A
HP R5000 3U IEC309-32A High Voltage INTL Uninterruptible Power System	AF461A

Expansion modules for RP36000/3 UPS

HP RP12000/3 12000VA Three Phase INTL 6U Rackmount Uninterruptible Power System	AF437A
---	--------

HP UPS Options

HP R/T2200 G4 Extended Runtime Module	J2R09A
HP R/T3000 G4 Extended Runtime Module	J2R10A
HP 2U Rack/Tower UPS Shipping Kit	L4Q11A

NOTE: Please see the [HP Line Interactive Single Phase UPS QuickSpecs](#) for information on additional options and product specifications.

NOTE: To learn more, please visit the [HP Uninterruptible Power Systems \(UPS\) web page](#).

HP Power Cords

HP C13 - SEV 1011 CH 250V 10Amp 1.83m Power Cord	AF565A
HP C13 - DK-2.5A DK 250V 10Amp 1.83m Power Cord	AF566A
HP C13 - SABS-164 ZA 250V 10Amp 2.5m Power Cord	AF567A
HP C13 - CEE-VII EU 250V 10Amp 1.83m Power Cord	AF568A
HP C13 - BS-1363A UK/HK/SG 250V 10Amp 1.83m Power Cord	AF570A
HP C13 - CEI-23-50 IT/CL 250V 10Amp 1.83m Power Cord	AF571A
HP C13 - Nema 6-15P US 250V 15A JP 3.6m Power Cord	A0N33A
HP C13 - Nema 5-15P US/CA 110V 10Amp 1.83m Power Cord	AF556A
HP 8AWG W/Ground Lug 48V DC 3.0m Power Cord	J6X42A

HP USB and SD Options

HP Flash Media Kits for USB Drives

HP Dual 8GB microSD Enterprise Midline USB Kit	741279-B21
--	------------

Additional Options

NOTE: Please see the [HP Flash Media Kits QuickSpecs](#) for additional information.

HP Enterprise Mainstream Flash Media Kits for Memory Cards

HP 32GB microSD Enterprise Mainstream Flash Media Kit	700139-B21
HP 8GB microSD Enterprise Mainstream Flash Media Kit	726116-B21

HP Care Pack Services

Proactive Care

HP 3 year 24x7 DL560 Gen9 Proactive Care Service	U8QM3E
HP 3 year 24x7 with Defective Media Retention DL560 Gen9 Proactive Care Service	U8QM4E
HP 3 year Call to Repair DL560 Gen9 Proactive Care Service	U8QM9E
HP 3 year Call to Repair with Defective Media Retention DL560 Gen9 Proactive Care Service	U8QN0E
HP 3 year 24x7 w/Comprehensive Defective Material Retention DL560 Gen9 Proactive Care Service	U8QS3E
HP 3 year Call to Repair w/ComprehensiveDefectiveMaterialRetention DL560 Gen9 Proactive Care Service	U8QS6E
HP 3 year 24x7 DL560 Gen9 with OneView Proactive Care Service	U8QW0E
HP 3 year 24x7 with Defective Media Retention DL560 Gen9 with OneView Proactive Care Service	U8QW1E
HP 3 year Call to Repair DL560 Gen9 with OneView Proactive Care Service	U8QW6E
HP 3 year Call to Repair w/Defective Media Retention DL560 Gen9 with OneView Proactive Care Service	U8QW7E
HP 3 year 24x7 w/Comprehensive Defective Material Retention DL560 Gen9 w/OneView Proactive Care SVC	U8RB0E
HP 3 year Call to Repair wComprehensiveDefectiveMaterialRetention DL560 Gen9 w OV Proactive Care SVC	U8RB3E

Installation & Start-up Services

HP Install ProLiant DL560 Service	U6H58E
HP Startup ProLiant DL560 Service	U6H60E

NOTE: Reduce the time required to get your system up and running and help minimize disruptions to your business.

NOTE: For more information, customer/resellers can contact: <http://www.hp.com/services/carepack>.

Memory

HP SmartMemory

New HP SmartMemory now provides additional protection for your servers. With HP Authentication it can verify that you have true HP Qualified Memory in your HP ProLiant Gen9 server. With HP SmartMemory your new HP ProLiant server can take advantage of additional Gen9 enhancements in performance, durability and future manageability support through HP Active Health System.

For detailed memory configuration rules and guidelines, please use the [Online DDR4 Memory Configuration Tool](#).

Memory Subsystem Architecture Each Intel® Xeon® E5-4600v3 family processor socket contains four memory channels per installed processor with three DIMMs per channel for a total of twelve (12) DIMMs or a grand total of forty eight (48) DIMMs for the server.

Memory Population guidelines

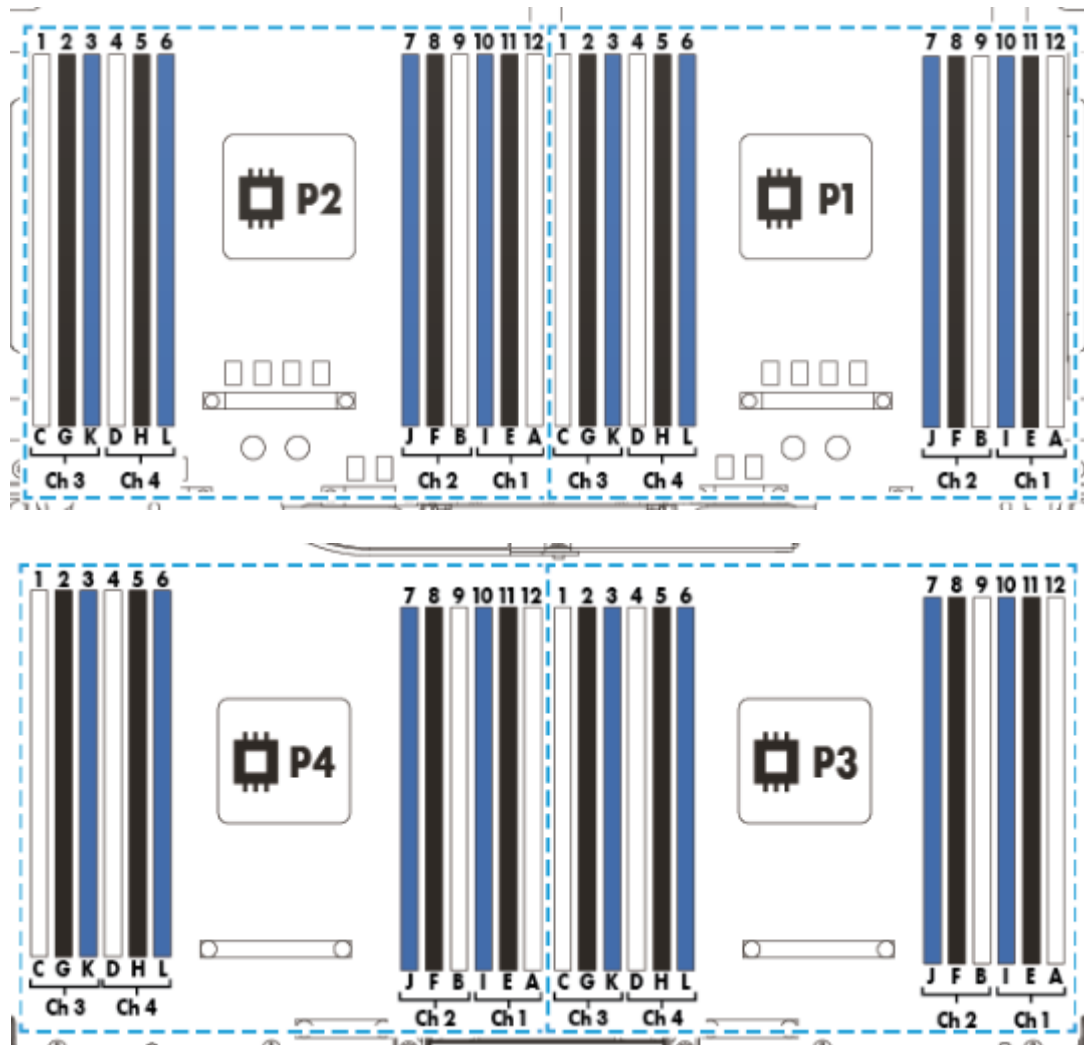

DIMM population order												
	1st slot of channel			2nd slot of channel			3rd slot of channel					
	A	B	C	D	E	F	G	H	I	J	K	L
Number of DIMMs to install	4											
	8											
	12											

Memory

General Memory Population Rules and Guidelines:

- To maximize performance, install two memory cartridges per processor and balance the total memory capacity between all installed processors.
- When multiple processors are installed, HP recommends installing the DIMMs in sequential alphabetical order: 4A, 9B, 1C, 12D, and so on.
- LRDIMMs support higher densities than single- and dual-rank RDIMMs, and higher speeds than quad-rank RDIMMs. This support enables you to install more high capacity DIMMs, resulting in higher system capacities and higher bandwidth.
- Do not mix LRDIMMs with any other DIMM type (RDIMM, LVDIMM).
- RDIMM population is limited to a maximum of eight logical ranks per channel. Therefore, only two quad rank RDIMMs are supported per channel. If there are more than eight physical ranks per channel, LRDIMMs rank multiplication provides support for three DIMMs per channel.
- Lockstep mode requires specific population requirements. See lock-step configuration below for more information.

NOTE: UDIMMs are not supported. This server does not support mixing LRDIMMs, RDIMMs, or UDIMMs. Attempting to mix any combination of these DIMMs can cause the server to halt during BIOS initialization. For detailed memory configuration rules and guidelines, use the Online DDR4 Memory Configuration Tool on the HP website (<http://www.hp.com/go/ddr3memory-configurator>).

Intel Gen9 Supported Memory Bandwidth for HP ProLiant Gen9 Intel® Xeon®E5-4600v3 Series Processor Family

Memory Bandwidth and Capacity					
[DIMM Type]	Registered DIMMs (RDIMMs)			Load Reduced (LRDIMMs)	Unbuffered with ECC DIMMs (UDIMMs)
DIMM Rank	Single Rank	Dual Rank			Quad Rank
DIMM Capacity	8GB	16GB	32GB	16GB	32GB
DIMM Native Speed (MT/s)	2133				
Voltage	Std Voltage 1.2V				
SLOTS THAT CAN BE POPULATED					
48 slot servers	48				
MAXIMUM CAPACITY (GB)					
	384	768	1536	768	1536
1 DIMM Per Channel	2133				
2 DIMM Per Channel	1866			2133	
3 DIMM Per Channel	1600				

Memory Speed by Processor Model

Processor Models	Supported Memory Speeds
E5-4627v3, E5-4650v3, E5-4655v3, E5-4660v3, E5-4667v3, E5-4669v3	2133/1866/1600MHz
E5-4620v3, E5-4640v3	1866/1600MHz

Memory

E5-4610v3	1600MHz
-----------	---------

Standard and Maximum Memory Capacity (Pre-configured Models)

Pre-Configured Models	Standard Memory	Maximum Memory Plus Optional Memory	Standard Memory Replaced with Optional Memory
E5-4640v3	128GB (8x16GB)	1408GB (40x32GB, 8x16GB)	1536GB (48x32GB)
E5-4620v3	64GB (4x16GB)	1472GB (44x32GB, 4x16GB)	1536GB (48x32GB)
E5-4610v3	32GB (2x16GB)	1504GB (46x32GB, 2x16GB)	1536GB (48x32GB)

DDR4 memory options part number decoder

NOTE: Capacity references are rounded to the common gigabyte (GB) values.

- 2GB = 2,048MB
- 4GB = 4,096MB
- 8GB = 8,192MB
- 16GB = 16,384MB
- 32GB = 32,768MB
- 64GB = 65,536MB

HP gggggg eRxxff DDR4 wwwwm a bb-ccd Kit

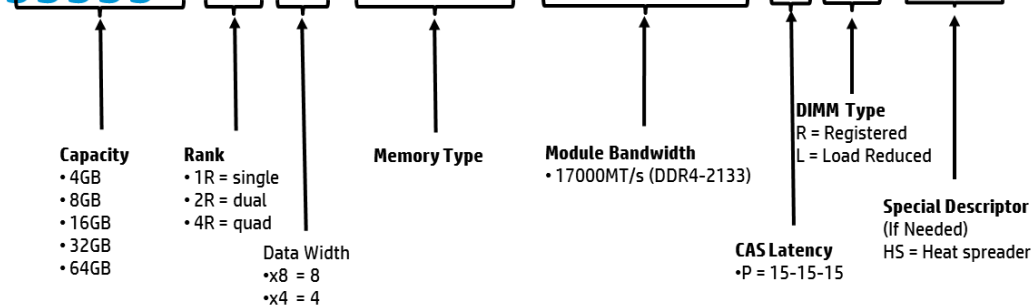

Storage

8 SFF (+2 SFF) hot-plug drive model with Universal Media Bay

1-8

8 x SFF SATA/SAS/SDD Hot Pluggable Hard drive bays

1-2

2 x SFF SATA/SAS/SSD Hot Pluggable Hard Drive Bays
Universal Media Bay Kit with 2xSFF drives

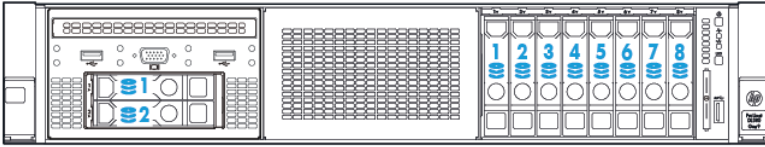

16 SFF (+2 SFF) hot-plug drive model with Universal Media Bay

1-16

16 x SFF SATA/SAS/SDD Hot Pluggable Hard drive bays

NOTE: If Universal Media Bay Kit is not chosen, even Bay 1 can be populated with 8xSFF drives to give a maximum of 24xSFF drives

1-2

2 x SFF SATA/SAS/SSD Hot Pluggable Hard Drive Bays
Universal Media Bay Kit with 2xSFF drives

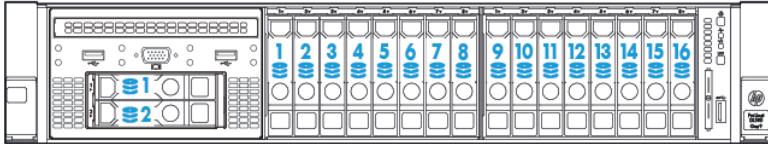

24 SFF hot-plug drive model without Universal Media Bay

1-24

24 x SFF SATA/SAS/SDD Hot Pluggable Hard drive bays

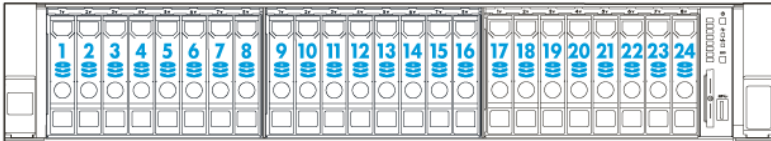

Technical Specifications

System Unit	Dimensions (H x W x D) (with bezel)	3.44" (8.74 cm) Height x 17.54" (44.55 cm) Width x 29.5" (74.94 cm) Length
	Weight (approximate)	Maximum: 69 lb (31.3 kg) (all hard drives, power supplies, DIMMs and processors installed) Minimum: 39.0 lb (17.69 kg)
	Input Requirements (per power supply)	Range Line Voltage 100 - 120 VAC (1200W PS only) 200 - 240 VAC (1200W & 1500W PS) Rated Input Current 9.2A (100 VAC), 6.6A (200 VAC) - 1200W PS 8.3A (200 VAC) - 1500W PS Rated Input Frequency 50 to 60 Hz Rated Input Power 1000 W (120 VAC), 1320 W (230VAC)- 1200W PS 1652 W (at 230 VAC) - 1500W PS
	BTU Rating	Maximum For 1200 W Power Supply: 3530 BTU/hr (at 100 VAC), 4600 BTU/hr (at 200 VAC) For 1500W Power Supply: 5749 BTU/hr (at 200 VAC), 5835 BTU/hr (at 240 VAC)
	Power Supply Output (per power supply)	Rated Steady-State Power For 1200 W Power Supply: 800 W (at 100 VAC), 900 W (at 120 VAC), 1200 W (at 200 to 240 VAC) For 1500 W Power Supply: 1500W (at 200 to 240VAC)
		Maximum Peak Power For 1200 W Power Supply: 800 W (at 100 VAC), 900 W (at 120 VAC), 1200 W (at 200 to 240 VAC) For 1500W Power Supply: 1500W (at 200 to 240 VAC)
	System Inlet Temperature	Standard Operating Support 10° to 35°C (50° to 95°F) at sea level with an altitude derating of 1.0°C per every 305 m (1.8°F per every 1000 ft) above sea level to a maximum of 3050 m (10,000 ft), no direct sustained sunlight. Maximum rate of change is 20°C/hr (36°F/hr). The upper limit and rate of change may be limited by the type and number of options installed. System performance during standard operating support may be reduced if operating with a fan fault or above 30°C (86°F).
		Extended Ambient Operating Support For approved hardware configurations, the supported system inlet range is extended to be: 5° to 10°C (41° to 50°F) and 35° to 40°C (95° to 104°F) at sea level with an altitude derating of 1.0°C per every 175 m (1.8°F per every 574 ft) above 900 m (2953 ft) to a maximum of 3050 m (10,000 ft). The approved hardware configurations for this system are listed at the URL: http://www.hp.com/servers/Ashrae
		For approved hardware configurations, the supported system inlet range is extended to be: 40° to 45°C (104° to 113°F) at sea level with an altitude derating of 1.0°C per every 125 m (1.8°F per every 410 ft) above 900 m (2953 ft) to a maximum of 3050 m (10,000 ft). The approved hardware configurations for this system are listed at the URL: http://www.hp.com/servers/Ashrae
	Non-operating	-30° to 60°C (-22° to 140°F). Maximum rate of change is 20°C/hr (36°F/hr).

NOTE: To review typical system power ratings use the HP Power Advisor which is available online located at url: <http://www.hp.com/go/proliant-energy-efficient> or <http://www.hp.com/go/hppoweradvisor>.

Technical Specifications

Relative Humidity	Operating	10% to 90% relative humidity (Rh), 28°C (82.4°F) maximum wet bulb temperature, non-condensing.
	(non-condensing) Non-operating	5 to 95% relative humidity (Rh), 38.7°C (101.7°F) maximum wet bulb temperature, non-condensing.
Altitude	Operating	3048 m (10,000 ft). This value may be limited by the type and number of options installed. Maximum allowable altitude change rate is 457 m/min (1500 ft/min).
	Non-operating	9144 m (30,000 ft). Maximum allowable altitude change rate is 457 m/min (1500 ft/min).
Acoustic Noise	Listed are the declared A-Weighted sound power levels (LWAd) and declared average bystander position A-Weighted sound pressure levels (LpAm) when the product is operating in a 23°C ambient environment. Noise emissions were measured in accordance with ISO 7779 (ECMA 74) and declared in accordance with ISO 9296 (ECMA 109).	
	Idle	
	L WAd	5.21 B
	L pAm	30.0
	Operating	
	L WAd	6.09 B
	L pAm	48.0
Emissions Classification (EMC)	FCC Rating	Class A
	Normative Standards	CISPR 22; EN55022; EN55024; FCC CFR 47, Pt 15; ICES-003; CNS13438; GB9254; K22;K24; EN 61000-3-2; EN 61000-3-3; EN 60950-1; IEC 60950-1

NOTE: Product conformance to cited product specifications is based on sample (type) testing, evaluation, or assessment. This product or family of products is eligible to bear the appropriate compliance logos and statements.

HP Dynamic Smart Array B140i Controller	Number of PCI links	Four
	PCI link rate	4 Gb/s
	Storage protocol support	SATA
	SAS/SATA peak data transfer rate	6 Gb/s
	Number of SAS/SATA links	10 links
	SAS/SATA connectivity	2x4 connectors; 2x1 connectors
	Expander support	No
	Drives supported (max)	Up to 10 Internal Drives
	RAID support	0, 1, 10, 5 SATA
	Software management	HP SSA, SMH, SIM
	Warranty	Server warranty
	HP Secure Encryption license	Not Supported
	HP SmartCache License	Not Supported
HP Smart Storage Administrator	Supported	

HP Ethernet 1Gb 4-port 331FLR Adapter	Network Interface	10Base-T/100Base-TX/1000Base-TX
	Compatibility	IEEE 802.3 10Base-T

Technical Specifications

	IEEE 802.3ab 1000Base-T
	IEEE 802.3u 100Base-TX
	IEEE 802.3x
	IEEE 802.3ad 1000Base-TX
	IEEE 802.3az
	IEEE 1588
Ports	
Data Transfer Method	PCI-Express 2.0 x4
Controller	
Network Transfer Rate	
Connector	
Cable Support	

Environment-friendly Products and Approach

End-of-life Management and Recycling

Hewlett-Packard offers end-of-life HP product return, trade-in, and recycling programs in many geographic areas. For trade-in information, please go to: <http://www.hp.com/go/green>. To recycle your product, please go to: <http://www.hp.com/go/green> or contact your nearest HP sales office. Products returned to HP will be recycled, recovered or disposed of in a responsible manner.

The EU WEEE directive (2002/95/EC) requires manufacturers to provide treatment information for each product type for use by treatment facilities. This information (product disassembly instructions) is posted on the Hewlett Packard web site at: <http://www.hp.com/go/green>. These instructions may be used by recyclers and other WEEE treatment facilities as well as HP OEM customers who integrate and re-sell HP equipment.

Summary of Changes

Date	Version History	Action	Description of Change
26-Jun-2015	From Version 1 to 2	Changed	Interfaces entry under Standard Features section was revised. Base configuration under Configuration Information - Factory Integrated Models section (Step 1) was revised.

© Copyright 2015 Hewlett-Packard Development Company, L.P.

The information contained herein is subject to change without notice. The only warranties for HP products and services are set forth in the express warranty statements accompanying such products and services. Nothing herein should be construed as constituting an additional warranty. HP shall not be liable for technical or editorial errors or omissions contained herein.

Intel® and Xeon® are registered trademarks of Intel Corporation in the U.S. and other countries.

Microsoft®, Windows®, and Windows Server® are U.S. registered trademarks of the Microsoft group of companies.

For hard drives, 1GB = 1 billion bytes. Actual formatted capacity is less.