

LA-5100

YAQUI: An Arbitrary
Lagrangian-Eulerian Computer Program
for Fluid Flow at All Speeds



DO NOT CIRCULATE

PERMANENT RETENTION

REQUIRED BY CONTRACT



los alamos
scientific laboratory
of the University of California
LOS ALAMOS, NEW MEXICO 87544

This report was prepared as an account of work sponsored by the United States Government. Neither the United States nor the United States Atomic Energy Commission, nor any of their employees, nor any of their contractors, subcontractors, or their employees, makes any warranty, express or implied, or assumes any legal liability or responsibility for the accuracy, completeness or usefulness of any information, apparatus, product or process disclosed, or represents that its use would not infringe privately owned rights.

Printed in the United States of America. Available from
National Technical Information Service
U. S. Department of Commerce
5285 Port Royal Road
Springfield, Virginia 22151
Price: Printed Copy \$3.00; Microfiche \$0.95

LA-5100

UC-32

ISSUED: March 1973



YAQUI: An Arbitrary Lagrangian-Eulerian Computer Program for Fluid Flow at All Speeds

by

Anthony A. Amsden
Cyril W. Hirt*

*Present address: Science Applications, Incorporated, P. O. Box 2351,
La Jolla, California 92037.

This work was performed under the joint auspices of the United States Atomic Energy Commission and the Defense Nuclear Agency (DNA Subtask No. HC-061, DNA Work Unit No. 15-Calculations at Low Altitude).

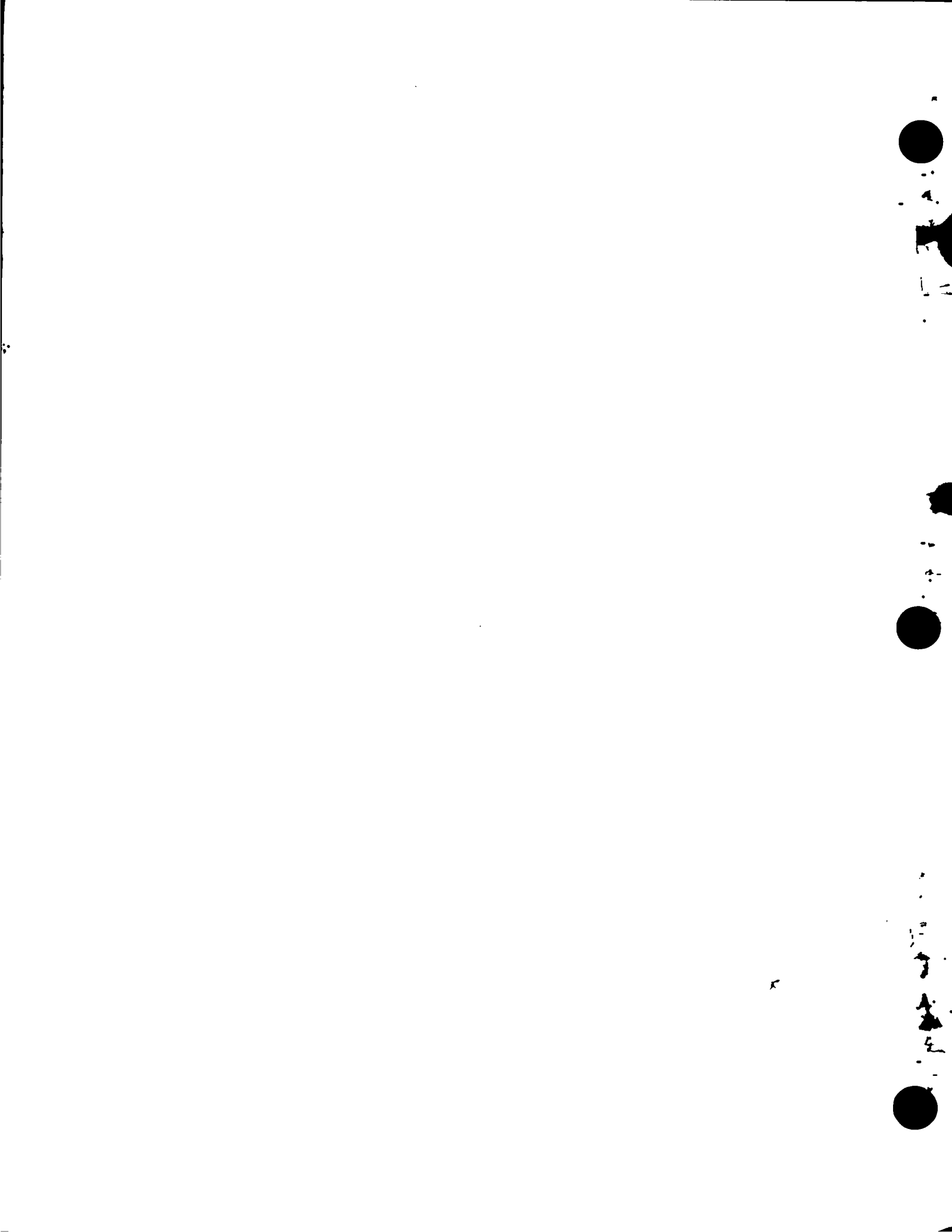

CONTENTS

	Page
Abstract	1
I. Basic Description of the Method (ICED-ALE)	1
A. Introduction	1
B. The Method Layout and the Computing Mesh	3
C. Initial Conditions and Preliminary Calculations	3
D. Phase 1 of the Calculation	4
E. Phase 2 of the Calculation	8
F. Phase 3 of the Calculation	10
G. Boundary Conditions	13
II. The YAQUI Computing Program	13
A. General Structure	13
B. The Indexing Notation	16
C. The Storage of Cell Data	16
D. The Three-Row Buffering Scheme	17
E. The Particle Option	21
1. The Particle Mover	21
2. Particle-Fluid Momentum Exchange	22
F. The Automatic Calculation of the Time Step and the Viscosity Coefficients	23
III. Using the YAQUI Program	26
A. Mesh Generation	26
B. Rezoning	27
C. The Input Data	29
D. Output--Plots, Prints, and Motion Pictures	33
E. Tape Dump and Restart	34
F. Incompressible Flow Calculations	34
G. The COMMON Block YSC2	35
IV. Some Computational Examples	39
A. One-Dimensional Shock Tube	39
B. A Low-Altitude Explosion	40
C. Particle-Fluid Momentum Exchange	44
D. Input Data and Results from a Sample Calculation	44
V. References	49
Appendix A. Flow Diagram for the YAQUI Program	69
Appendix B. FORTRAN IV Index Listing of the YAQUI Program	102

YAQUI:
AN ARBITRARY LAGRANGIAN-EULERIAN COMPUTER PROGRAM
FOR FLUID FLOW AT ALL SPEEDS

by

Anthony A. Amsden and Cyril W. Hirt

ABSTRACT

A numerical fluid-dynamics computing technique is presented that combines the Implicit Continuous-fluid Eulerian (ICE) and the Arbitrary Lagrangian-Eulerian (ALE) methods. An implicit treatment of the pressure equation similar to that in ICE enables the calculation of flows at all speeds from supersonic to far subsonic. In addition, the vertices of the computing grid may be moved with the fluid in normal Lagrangian fashion or be held fixed in a Eulerian manner, or be moved in some arbitrary way to give a continuous rezoning capability, as in the ALE method. Greater distortions in the fluid motion can be handled than would be allowed by a purely Lagrangian method, and with more resolution than is afforded by a purely Eulerian method. The report describes the combined (ICED-ALE) technique in the framework of a computer program called YAQUI, for which the complete flow diagram and FORTRAN index listing are provided. Representative calculations illustrate some of the features of YAQUI, and include both computer-generated plots and numerical listings.

I. BASIC DESCRIPTION OF THE METHOD (ICED-ALE)

A. Introduction

Over the past decade, there has been considerable progress in development of computer techniques for solution of multidimensional problems in fluid dynamics. A number of basic techniques have become well established, and useful and practical applications are being made to an ever-increasing range of problems in many fields. Because of computer storage and time limitations, numerical methods obviously cannot afford the luxury of following the dynamics of each and every molecule of the fluid at hand, but must, instead, depend upon following the dynamics of a finite, discrete set of fluid elements. Therefore, the region of interest is usually subdivided into a finite grid or mesh of computing zones, associating with each zone or vertex the local values of the quantities of interest, such as mass, energy, and velocity. The governing differential equations are approximated by finite-

difference forms in relation to the grid, and this set of equations is then solved repeatedly over the domain to advance the solution through finite intervals of time, analogous to the frames of a motion picture.

Given this basic description, however, there are two fundamentally important considerations beyond which the various techniques differ. The first of these considerations is the flow-speed regime of interest, and the second is the interrelationship of the grid and the fluid. These two points will be discussed separately and then brought together.

The types of fluid flows that have been most amenable to calculation are generally those that can be characterized as either compressible or incompressible. Compressible, or high-speed, flows are those in which the fluid speed is comparable to or faster than the local material sound speed, and they are therefore governed only by local influences. In the incompressible or low-speed regime, however,

fluid speeds are much less than material sound speeds, and disturbances at any point must, for all practical purposes, be felt instantaneously throughout the entire domain. As a result, the numerical stability restrictions for high-speed flows produce intolerably small time steps at low flow speeds. On the other hand, low-speed methods cannot sense compressibility effects produced by increased flow speeds, as no equation of state is used. Unfortunately, many fluid-dynamics problems of interest do not fall at either of these two extremes, and they are therefore not accurately calculated by either high- or low-speed methods. Examples are flows that are initially supersonic but rapidly become subsonic, or flows that are supersonic in one region or direction and far subsonic in another. Consequently, much effort is being placed on developing techniques to calculate in this intermediate regime.

The second point concerns the relationship between the fluid and the coordinate grid. Traditionally, there have been two basic viewpoints for both high- and low-speed flows. The first is Lagrangian, in which the mesh of grid points is embedded in the fluid and moves with it. Clear delineation of fluid interfaces and well-resolved details of the flow are afforded, but the approach is limited by its inability to cope easily with strong distortions, which so often characterize flows of interest. The second basic viewpoint, known as Eulerian, treats the mesh as a fixed reference frame through which the fluid moves. Strong distortions can be handled with relative ease, but generally at the expense of precise interface definition and resolution of detail.

Because of the obvious shortcomings of purely high-speed and purely low-speed methods, coupled with the shortcomings of purely Lagrangian vs purely Eulerian approaches, increasing emphasis is being placed on development of ever more sophisticated hybrid techniques.

Presently, the most successful method for calculating flows at all speeds is the Implicit Continuous-fluid Eulerian (ICE) technique,¹ in which the flow may vary from supersonic to far subsonic. This is enabled by an implicit treatment of the pressure calculation. The method is extremely versatile and can be used for calculations in one,

two, or three space dimensions, allowing for arbitrary equation of state.

Simultaneously, techniques have been developed that succeed to a great extent in combining the best features of both the Lagrangian and Eulerian approaches. In some methods, Lagrangian particles are used to define fluid interfaces or free surfaces, or to define the fluid itself, within a Eulerian mesh. There are other approaches, however, that have no basic dependence on particles. One such is the Arbitrary Lagrangian-Eulerian (ALE) method,² a low-speed technique that allows the vertices to move with the fluid in normal Lagrangian fashion or be held fixed in a Eulerian manner, or to move in some arbitrarily specified way to give a continuous rezoning capability. Greater distortions in the fluid motion can be handled than would be allowed by a purely Lagrangian method, with more resolution than is afforded by a purely Eulerian method.

This report describes a combination of the ICE and ALE schemes (ICED-ALE) in a computer program called YAQUI. It is based on the most recent improvements available in both the ICE and ALE methods, together with other improvements made possible by the marriage of the two schemes.

Although much more work remains to be done in the development of such hybrid techniques, YAQUI has established itself as a versatile tool for studying flows at all speeds and it has the capability of continuous rezoning.

The ICE technique was originally developed by F. H. Harlow, and the ALE technique by C. W. Hirt, who originated the ICED-ALE combination as it is represented in YAQUI. The code as it stands, however, represents the efforts of a number of people who have experimented with many alternatives along the way, and who have provided valuable contributions to its development. We are grateful for the help of our colleagues F. H. Harlow, T. D. Butler, H. M. Ruppel, J. U. Brackbill, R. A. Gentry, and W. E. Pracht of Group T-3, and for that of E. M. Jones and R. C. Anderson of Group J-10.

Inasmuch as the underlying technique has been discussed in detail elsewhere,² this report will start from that point. First, the finite-difference equations will be presented as they appear in YAQUI, then the code itself will be discussed in detail.

B. The Method Layout and the Computing Mesh

The basic hydrodynamic part of each cycle of the ICED-ALE method is divided into three distinct subsections or phases. The first phase is a typical, explicit Lagrangian calculation. The second is an iteration that provides advanced pressures for the momentum equations and advanced compression for the mass equation. These ensure the stability of the method with respect to sound-signal propagation. Finally, the third phase, called the rezone section, performs all the convective-flux calculations, which must be included if the mesh is not purely Lagrangian.

The computing mesh consists of a two-dimensional network of quadrilateral cells, and it will handle calculations in either cylindrical or plane (Cartesian) coordinates. Calculations in cylindrical coordinates are scaled to unit azimuthal angle, thus allowing the equations to be written without any π factors. The radial coordinate is denoted by r or x , and the axial coordinate by z or y , with the origin located at the lower left corner of the mesh. The coordinate names in the equations in this report are x and y . The coordinate named r is used to determine the geometry: r is always set equal to x for cylindrical coordinates, but the expressions automatically reduce to Cartesian expressions if all r 's are set to unity. The vertices of the cells are labeled with the indices i and j , which increase in the radial and axial directions, respectively. Cell centers are denoted by half-integer indices $i + 1/2$ and $j + 1/2$. The mesh of cells is \bar{I} cells wide by \bar{J} cells high.

The mesh illustrated in Fig. 1 is in cylindrical coordinates, where the cells are sections of toroids of revolution about the cylinder.

The variables in an ICED-ALE grid are of two types: those defined at vertices, and those defined at cell centers. The principal variables are shown in Fig. 2, where coordinates (x and y), velocities (u and v), and masses (M) are defined at vertices, and the densities (ρ), pressures (p), volumes (V), and energies are defined at the cell centers. E is the specific total energy, and I is the specific internal energy.

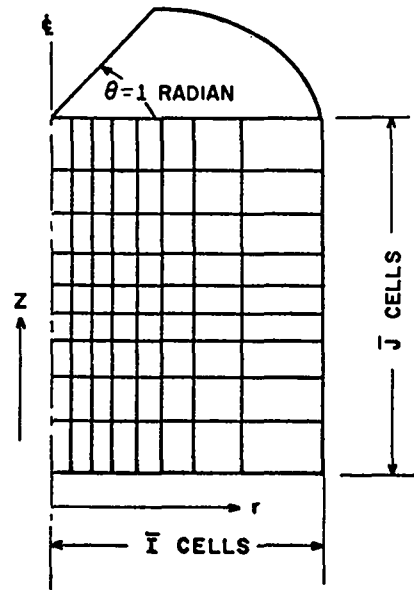

Fig. 1. A typical ICED-ALE mesh in cylindrical coordinates.

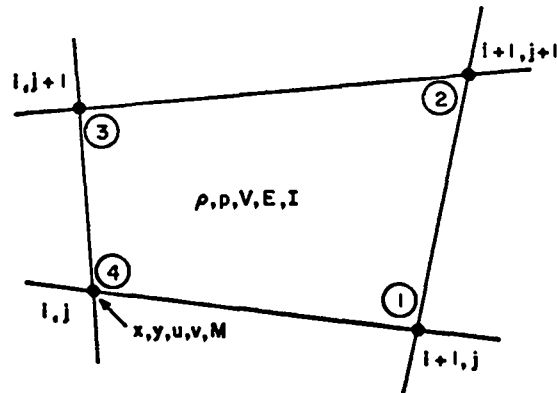

Fig. 2. A typical ICED-ALE cell showing the locations of the principal variables. The numbers are in the shorthand vertex notation used in the equations that follow and in the YAQUI code.

In the equations that follow, the superscript n denotes the beginning-of-cycle values. The advancement of the solution through a time step, of duration δt , provides values at the beginning of the next $(n+1)$ cycle. Intermediate values are typically labeled with a tilde for the results of Phase 1, or with a subscript L for the results of Phase 2.

C. Initial Conditions and Preliminary Calculations

Input Quantities: The input data supply the initial

values of x , y , u , and v at the vertices and ρ and I for cells.

Preliminary Calculations (each cycle):

(1) The radius of each vertex is calculated as

$r = x$ in cylindrical coordinates, or
 $r = 1$ in plane coordinates.

(2) Cell pressures are calculated at the beginning of each cycle using an equation of state

$$p = p(\rho, I) ,$$

although the equation of state may be bypassed for small Mach numbers. This is discussed further in Sec. III F, "Incompressible Flow Calculations."

(3) Cell volumes are given by

$$V_{i+\frac{1}{2}}^{j+\frac{1}{2}} = \frac{1}{3} \left[(r_1 + r_2 + r_3) ATR + (r_1 + r_3 + r_4) ABL \right] ,$$

where

$$ATR = \frac{1}{2} \left[x_1 (y_2 - y_3) + x_2 (y_3 - y_1) + x_3 (y_1 - y_2) \right] ,$$

$$ABL = \frac{1}{2} \left[x_1 (y_3 - y_4) + x_3 (y_4 - y_1) + x_4 (y_1 - y_3) \right] .$$

The subscript notation for vertex quantities has been simplified to that shown in Fig. 2. It is used throughout this report and in the YAQUI code.

(4) With the cell volumes defined, the masses at cell centers can be computed from

$$M_{i+\frac{1}{2}}^{j+\frac{1}{2}} = \rho_{i+\frac{1}{2}}^{j+\frac{1}{2}} V_{i+\frac{1}{2}}^{j+\frac{1}{2}} ,$$

but because most references are to the vertex masses, it is convenient to replace the cell masses immediately by vertex masses:

$$M_i^j = \frac{1}{4} \left(M_{i+\frac{1}{2}}^{j+\frac{1}{2}} + M_{i-\frac{1}{2}}^{j+\frac{1}{2}} + M_{i+\frac{1}{2}}^{j-\frac{1}{2}} + M_{i-\frac{1}{2}}^{j-\frac{1}{2}} \right) .$$

To maintain energy conservation throughout the entire calculational cycle, it is necessary to calculate and store E , the total specific energy per cell. However, the pressure iteration in Phase 2 requires a set of internal energies, I . One could get by with only a computer storage matrix of internal energies, by updating I during the iteration so that the total energy was conserved. The extra calculation required to do this, however, especially within an iteration, makes it seem reasonable to keep E and I separately. Therefore, we maintain a field of E 's throughout the cycle, where

initially

$$E_{i+\frac{1}{2}}^{j+\frac{1}{2}} = I_{i+\frac{1}{2}}^{j+\frac{1}{2}} + \frac{1}{8} \left(u_1^2 + u_2^2 + u_3^2 + u_4^2 + v_1^2 + v_2^2 + v_3^2 + v_4^2 \right) ,$$

to which we will later add the various work and dissipation terms.

D. Phase 1 of the Calculation

In this section we carry out a typical fully explicit Lagrangian calculation, with no grid motion, to obtain vertex values of the tilde velocities, \tilde{u} and \tilde{v} , and the change in total energy per unit mass, Q .

These three quantities are calculated in several steps. The following formulas show how these values accumulate from the contributions of each step. The appropriate initial values are, for each vertex,

$$\tilde{u}_i^j = u_i^j + \delta t A_x ,$$

and

$$\tilde{v}_i^j = v_i^j + \delta t A_y ,$$

where A_x and A_y are body accelerations or accelerations from other forces applied at the vertices, and the superscript n denotes the beginning-of-cycle values. In most cases of interest, A_x and A_y are set equal to the gravity components

$$A_{x_i}^j = g_r \quad \text{and} \quad A_{y_i}^j = g_z .$$

It is also helpful to insert a small, controlled, artificial diffusive acceleration into A_x and A_y at this point. To see the reason for this, consider the integration area that will be used for updating the velocity components at vertex $\binom{j}{i}$ in Fig. 3. The region is surrounded by dashed lines connecting the vertices $\binom{j}{i+1}$, $\binom{j+1}{i}$, $\binom{j}{i-1}$, and $\binom{j-1}{i}$ that will influence the accelerations at vertex $\binom{j}{i}$, but in the equations the acceleration computed from the surface stresses is independent of the vertex's location within the integration area. Although proper rezoning will tend to keep the vertex near the center of the region, and aid in

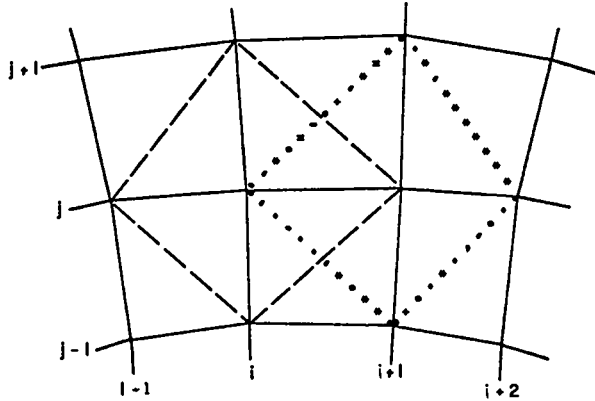

Fig. 3. Momentum-integration areas about cells (i, j) and $(i+1, j)$, indicated by dashed lines and dotted lines, respectively.

obtaining the most accurate results, consider the integration area for the next cell $(i+1, j)$, indicated by the dotted lines in Fig. 3. This indicates that values at four different vertices, $(i+2, j)$, $(i+1, j)$, (i, j) , and $(i+1, j-1)$, will enter. Although this definition of an integration area provides flexibility, there is a definite lack of communication between neighboring vertices, which can allow slight relative oscillations to arise in the velocity field. Introduction of a small restoring acceleration at each vertex, based upon the local velocity field, can prevent any vertex from deviating too strongly from its neighbors and couple the alternate nodes more strongly. This is done in YAQUI by introducing a weighted average of the neighboring vertex velocities. We can write

$$A_{x_i}^j = g_x + \frac{1}{a_{nc} \delta t} (n_{<u>_i^j} - n_{u_i^j}) ,$$

and

$$A_{y_i}^j = g_z + \frac{1}{a_{nc} \delta t} (n_{<v>_i^j} - n_{v_i^j}) ,$$

where

$$n_{<u>_i^j} = \frac{1}{4} (n_{u_{i+1}^j} + n_{u_i^{j+1}} + n_{u_{i-1}^j} + n_{u_i^{j-1}}) ,$$

$$n_{<v>_i^j} = \frac{1}{4} (n_{v_{i+1}^j} + n_{v_i^{j+1}} + n_{v_{i-1}^j} + n_{v_i^{j-1}}) ,$$

and a_{nc} is a coefficient that governs the amount of coupling, and upon which there is a stringent stability requirement, discussed in Sec. II F. It is

possible to interpret a_{nc} as the number of cycles required for the vertex velocity to nearly equal the average of the neighboring velocities. The effect of this formulation becomes more apparent if one considers the initial tilde velocities that result from it:

$$\tilde{u}_i^j = \left(1 - \frac{1}{a_{nc}}\right) n_{u_i^j} + \left(\frac{1}{a_{nc}}\right) n_{<u>_i^j} + \delta t g_x ,$$

and

$$\tilde{v}_i^j = \left(1 - \frac{1}{a_{nc}}\right) n_{v_i^j} + \left(\frac{1}{a_{nc}}\right) n_{<v>_i^j} + \delta t g_z ,$$

which show the effective interpolation among neighbors that is added in. Note that for $a_{nc} = 1.0$, the technique becomes identical to a procedure that Lax introduced many years ago. To avoid the difficulty of that procedure as $\delta t \rightarrow 0$, it would be appropriate to take $a_{nc} = a'_{nc} / \delta t$, in which case a'_{nc} is the actual relaxation time, rather than the number of cycles for relaxation.

Next, the appropriate initial vertex energy change is calculated as

$$Q_i^j = \delta t \left[\left(A_{x_i}^j n_{u_i^j} \right) + \left(A_{y_i}^j n_{v_i^j} \right) \right] .$$

One might expect to see, instead,

$$Q_i^j = \frac{\delta t}{2} \left[A_{x_i}^j (n_{u_i^j} + \tilde{u}_i^j) + A_{y_i}^j (n_{v_i^j} + \tilde{v}_i^j) \right] ,$$

but this is inappropriate because of the way we calculate Phase 1. The initial tilde velocities we have established contain only the body accelerations, and inserting this part into the initial Q's, before the pressure forces have been calculated, can cause the Q's, and hence the E's, to depart steadily from the correct value.

This effect would be manifested, for example, in a simple hydrostatic equilibrium, in which the velocities at time n are zero. To maintain equilibrium, we know that the final tilde velocities must also equal zero, but the gravitational accelerations in the initial tilde velocities would be repeatedly added into the Q's every cycle. This condition would not arise if we were to hold off the Q calculation until the final, complete tilde velocities were available. We choose, however, to

form the Q's simultaneously in the same next step that will adjust for the various forces applied through pressure and viscous stresses over the control volumes surrounding each vertex. The changes in the initial \bar{u} , \bar{v} , and Q values are computed by sweeping through the cells and suitably adjusting the four vertices of each cell. Thus the net result at each vertex is the cumulative contribution from each of four surrounding cells. This technique of initializing vertices and then accumulating contributions from the cells is preferable to sweeping the vertices themselves, as it is less dependent on boundary conditions and requires calculation of auxiliary cell quantities only once per cycle. Thus, the set of energy changes that we obtain at corner vertices is subsequently assigned to the adjacent cells in a manner that preserves total energy while updating the vertex velocities.

This second step for each vertex proceeds as follows. First, for each cell, we calculate the divergence, $D = \nabla \cdot \vec{u}$, and the components of the viscous stress tensor:³

$$\Pi_{xx} = 2\mu \frac{\partial u}{\partial x} + \lambda \nabla \cdot \vec{u} \quad ,$$

$$\Pi_{yy} = 2\mu \frac{\partial v}{\partial y} + \lambda \nabla \cdot \vec{u} \quad ,$$

$$\Pi_{xy} = \mu \left(\frac{\partial u}{\partial y} + \frac{\partial v}{\partial x} \right) \quad ,$$

$$\Pi_{\theta} = 2\mu \frac{u}{r} + \lambda \nabla \cdot \vec{u} \quad .$$

Here μ is the shear stress, and $\lambda = \zeta - \frac{2}{3} \mu$, where ζ is the coefficient of dilatational viscosity. The corresponding finite-difference equations for these quantities are:

$$\begin{aligned} D = \frac{1}{4V} \{ & (r_1 + r_2) [(u_1 + u_2) (y_2 - y_1) \\ & + (v_1 + v_2) (x_1 - x_2)] \\ & + (r_2 + r_3) [(u_2 + u_3) (y_3 - y_2) \\ & + (v_2 + v_3) (x_2 - x_3)] \\ & + (r_3 + r_4) [(u_3 + u_4) (y_4 - y_3) \\ & + (v_3 + v_4) (x_3 - x_4)] \end{aligned}$$

$$\begin{aligned} & + (r_4 + r_1) [(u_4 + u_1) (y_1 - y_4) \\ & + (v_4 + v_1) (x_4 - x_1)] \} \quad , \end{aligned}$$

$$\begin{aligned} \Pi_{xx} = \frac{\mu}{2V} \{ & (r_2 + r_1) (u_2 + u_1) (y_2 - y_1) \\ & + (r_3 + r_2) (u_3 + u_2) (y_3 - y_2) \\ & + (r_4 + r_3) (u_4 + u_3) (y_4 - y_3) \\ & + (r_1 + r_4) (u_1 + u_4) (y_1 - y_4) \\ & - \frac{CYL}{2} (u_1 + u_2 + u_3 + u_4) [(x_1 - x_3) (y_2 - y_4) \\ & + (x_2 - x_4) (y_3 - y_1)] \} + \lambda D \quad , \end{aligned}$$

$$\begin{aligned} \Pi_{yy} = \frac{\mu}{2V} \{ & (r_1 + r_2) (v_1 + v_2) (x_1 - x_2) \\ & + (r_2 + r_3) (v_2 + v_3) (x_2 - x_3) \\ & + (r_3 + r_4) (v_3 + v_4) (x_3 - x_4) \\ & + (r_4 + r_1) (v_4 + v_1) (x_4 - x_1) \} + \lambda D \quad , \end{aligned}$$

$$\begin{aligned} \Pi_{xy} = \frac{\mu}{4V} \{ & (r_1 + r_2) [(u_1 + u_2) (x_1 - x_2) \\ & + (v_1 + v_2) (y_2 - y_1)] \\ & + (r_2 + r_3) [(u_2 + u_3) (x_2 - x_3) \\ & + (v_2 + v_3) (y_3 - y_2)] \\ & + (r_3 + r_4) [(u_3 + u_4) (x_3 - x_4) \\ & + (v_3 + v_4) (y_4 - y_3)] \\ & + (r_4 + r_1) [(u_4 + u_1) (x_4 - x_1) \\ & + (v_4 + v_1) (y_1 - y_4)] \\ & - \frac{CYL}{2} (v_1 + v_2 + v_3 + v_4) [(x_1 - x_3) (y_2 - y_4) \\ & + (x_2 - x_4) (y_3 - y_1)] \} \quad , \end{aligned}$$

$$\Pi_{\theta} = \text{CYL} \left(\frac{\mu}{4V} \left\{ (u_1 + u_2 + u_3 + u_4) [(x_1 - x_3)(y_2 - y_4) + (x_2 - x_4)(y_3 - y_1)] \right\} + \lambda D \right) .$$

In the above equations, V is the cell volume and all the velocities on the right are the beginning-of-cycle values at time n , not tilde velocities. The coefficient CYL appearing in Π_{xx} , Π_{xy} , and Π_{θ} equals 1.0 when used in cylindrical coordinates, or 0.0 when used in plane coordinates. Note also the cyclic increase in index values in each term.

Next, with the D and Π terms calculated for a cell, the resulting changes in the \bar{u} and \bar{v} velocities can be calculated at the four cell vertices as follows. Start by defining

$$\text{PTH} = \frac{1}{4} \Pi_{\theta} \left[(x_1 - x_3)(y_2 - y_4) + (x_2 - x_4)(y_3 - y_1) \right] ,$$

then

$$\bar{u}_1 = \bar{u}_1 + \frac{\delta t}{2M_1} \left\{ \frac{1}{2} (r_2 + r_4) [\Pi_{xx}(y_4 - y_2) + \Pi_{xy}(x_2 - x_4)] + r_1(y_2 - y_4)p - \text{PTH} \right\} ,$$

$$\bar{u}_2 = \bar{u}_2 + \frac{\delta t}{2M_2} \left\{ \frac{1}{2} (r_3 + r_1) [\Pi_{xx}(y_1 - y_3) + \Pi_{xy}(x_3 - x_1)] + r_2(y_3 - y_1)p - \text{PTH} \right\} ,$$

$$\bar{u}_3 = \bar{u}_3 + \frac{\delta t}{2M_3} \left\{ \frac{1}{2} (r_4 + r_2) [\Pi_{xx}(y_2 - y_4) + \Pi_{xy}(x_4 - x_2)] + r_3(y_4 - y_2)p - \text{PTH} \right\} ,$$

$$\bar{u}_4 = \bar{u}_4 + \frac{\delta t}{2M_4} \left\{ \frac{1}{2} (r_1 + r_3) [\Pi_{xx}(y_3 - y_1) + \Pi_{xy}(x_1 - x_3)] + r_4(y_1 - y_3)p - \text{PTH} \right\} ,$$

$$\bar{v}_1 = \bar{v}_1 + \frac{\delta t}{2M_1} \left\{ \frac{1}{2} (r_2 + r_4) [\Pi_{xy}(y_4 - y_2) + (\Pi_{yy} - p)(x_2 - x_4)] \right\} ,$$

$$\bar{v}_2 = \bar{v}_2 + \frac{\delta t}{2M_2} \left\{ \frac{1}{2} (r_3 + r_1) [\Pi_{xy}(y_1 - y_3) + (\Pi_{yy} - p)(x_3 - x_1)] \right\} ,$$

$$\bar{v}_3 = \bar{v}_3 + \frac{\delta t}{2M_3} \left\{ \frac{1}{2} (r_4 + r_2) [\Pi_{xy}(y_2 - y_4) + (\Pi_{yy} - p)(x_4 - x_2)] \right\} ,$$

$$\bar{v}_4 = \bar{v}_4 + \frac{\delta t}{2M_4} \left\{ \frac{1}{2} (r_1 + r_3) [\Pi_{xy}(y_3 - y_1) + (\Pi_{yy} - p)(x_1 - x_3)] \right\} ,$$

where p is the cell pressure previously calculated from the equation of state. The energy changes are similarly calculated for each of the four vertices, but the p 's are handled in a special mass-weighted fashion to improve accuracy when contact surfaces are present. First, calculate the Q contributions without the work terms:

$$Q_1 = Q_1 + \frac{\delta t (r_2 + r_4)}{8M_1} \left\{ (u_2 + u_4) [\Pi_{xy}(x_2 - x_4) - \Pi_{xx}(y_2 - y_4)] - (v_2 + v_4) [\Pi_{xy}(y_2 - y_4) - \Pi_{yy}(x_2 - x_4)] \right\} ,$$

$$Q_2 = Q_2 + \frac{\delta t (r_3 + r_1)}{8M_2} \left\{ (u_3 + u_1) [\Pi_{xy}(x_3 - x_1) - \Pi_{xx}(y_3 - y_1)] - (v_3 + v_1) [\Pi_{xy}(y_3 - y_1) - \Pi_{yy}(x_3 - x_1)] \right\} ,$$

$$Q_3 = Q_3 + \frac{\delta t (r_4 + r_2)}{8M_3} \left\{ (u_4 + u_2) [\Pi_{xy}(x_4 - x_2) - \Pi_{xx}(y_4 - y_2)] - (v_4 + v_2) [\Pi_{xy}(y_4 - y_2) - \Pi_{yy}(x_4 - x_2)] \right\} ,$$

$$Q_4 = Q_4 + \frac{\delta t (r_1 + r_3)}{8M_4} \left\{ (u_1 + u_3) [\Pi_{xy}(x_1 - x_3) - \Pi_{xx}(y_1 - y_3)] - (v_1 + v_3) [\Pi_{xy}(y_1 - y_3) - \Pi_{yy}(x_1 - x_3)] \right\} .$$

When all cells have been so treated, we can distribute the vertex energy changes, Q , into the stored cell-center energies E , to form an $\langle \bar{E} \rangle$, which is denoted by brackets $\langle \rangle$ to identify that

the pressures were omitted from the Q terms:

$$\langle \bar{E} \rangle_{i+\frac{1}{2}}^{j+\frac{1}{2}} = n_{i+\frac{1}{2}}^{j+\frac{1}{2}} E_{i+\frac{1}{2}}^{j+\frac{1}{2}} + \frac{1}{4} (Q_1 + Q_2 + Q_3 + Q_4) .$$

Next, convert $\langle \bar{E} \rangle$ values throughout the mesh to \bar{E} 's by sweeping all cells. Define the following mass-weighted ratios for each cell:

$$P_{12} = \frac{M_{i+3/2}^{j+1/2} n_{i+3/2}^{j+1/2} p_{i+3/2}^{j+1/2} + M_{i+1/2}^{j+1/2} n_{i+1/2}^{j+1/2} p_{i+3/2}^{j+1/2}}{M_{i+3/2}^{j+1/2} + M_{i+1/2}^{j+1/2}} ,$$

$$P_{23} = \frac{M_{i+3/2}^{j+3/2} n_{i+3/2}^{j+3/2} p_{i+3/2}^{j+3/2} + M_{i+1/2}^{j+3/2} n_{i+1/2}^{j+3/2} p_{i+3/2}^{j+3/2}}{M_{i+3/2}^{j+3/2} + M_{i+1/2}^{j+3/2}} ,$$

$$P_{34} = \frac{M_{i-1/2}^{j+1/2} n_{i-1/2}^{j+1/2} p_{i-1/2}^{j+1/2} + M_{i+1/2}^{j+1/2} n_{i+1/2}^{j+1/2} p_{i-1/2}^{j+1/2}}{M_{i-1/2}^{j+1/2} + M_{i+1/2}^{j+1/2}} ,$$

$$P_{41} = \frac{M_{i+1/2}^{j-1/2} n_{i+1/2}^{j-1/2} p_{i+1/2}^{j-1/2} + M_{i-1/2}^{j-1/2} n_{i-1/2}^{j-1/2} p_{i+1/2}^{j-1/2}}{M_{i+1/2}^{j-1/2} + M_{i-1/2}^{j-1/2}} .$$

Although cell-center masses are no longer available, they can be approximated easily here by averaging four vertex masses. Finally, we can write

$$\begin{aligned} \bar{E}_{i+\frac{1}{2}}^{j+\frac{1}{2}} = & \langle \bar{E} \rangle_{i+\frac{1}{2}}^{j+\frac{1}{2}} - \frac{\delta t}{4M_{i+\frac{1}{2}}^{j+\frac{1}{2}}} \left\{ (r_1+r_2) P_{12} \left[(\bar{u}_1+\bar{u}_2)(y_2-y_1) \right. \right. \\ & + (\bar{v}_1+\bar{v}_2)(x_1-x_2) \left. \right] + (r_2+r_3) P_{23} \left[(\bar{u}_2+\bar{u}_3)(y_3-y_2) \right. \\ & + (\bar{v}_2+\bar{v}_3)(x_2-x_3) \left. \right] + (r_3+r_4) P_{34} \left[(\bar{u}_3+\bar{u}_4)(y_4-y_3) \right. \\ & + (\bar{v}_3+\bar{v}_4)(x_3-x_4) \left. \right] + (r_4+r_1) P_{41} \left[(\bar{u}_4+\bar{u}_1)(y_1-y_4) \right. \\ & \left. \left. + (\bar{v}_4+\bar{v}_1)(x_4-x_1) \right] \right\} . \end{aligned}$$

We have observed that this technique of calculating \bar{E} in two steps is useful in enhancing the sharpness of shock fronts as well as contact surfaces.

The E formulation does, indeed, conserve total energy, and this can be shown as follows. If we sum over all cells

$$\sum_k M_k E_k = \sum_k M_k^{old} E_k + \sum_k \frac{M_k}{4} (Q_1+Q_2+Q_3+Q_4) ,$$

or

$$(\text{New Total Energy}) = (\text{Old Total Energy})$$

$$+ \sum_{\ell} \left(\frac{M_1 + M_2 + M_3 + M_4}{4} \right) Q_{\ell} ,$$

where the last sum has been changed from cells to vertex ℓ , and the coefficient of Q_{ℓ} is precisely the mass of vertex ℓ . Energy conservation is ensured, because the $M_{\ell} Q_{\ell}$ cancel in pairs when summed.

This completes the calculations associated with Phase 1 of the ICED-ALE cycle. If, at this point, one were to move coordinates with the \bar{u} and \bar{v} velocities and calculate new densities, the result would be a typical, explicit, Lagrangian calculation.

E. Phase 2 of the Calculation

We now need an implicit treatment to eliminate the Courant-like restriction on high sound speed that usually is required to ensure computational stability. This is accomplished by iterating the tilde quantities from Phase 1 so as to provide an advanced-time set of pressures for use in the momentum equations. These pressures, in turn, must reflect the new densities that will be calculated with the new velocities. In other words, the new densities are computed from coordinates obtained using accelerations that are functions of the new densities. Such an implicit treatment can, indeed, prevent instabilities at high sound speeds. For a completely incompressible flow, for example, the iteration tends to keep the ρ of each cell constant as the sound speed approaches infinity. The implicit coupling of p and ρ forces the cell to return to its initial ρ value, as ρ changes force corresponding pressure changes.

The implicit Phase-2 calculation proceeds as follows. First, we initialize velocities, densities, and pressures, where

$$u_L = \bar{u} ,$$

$$v_L = \bar{v} ,$$

$$\rho_L = n \rho ,$$

$$p_L = n p .$$

The subscript L identifies those quantities to be updated during the iteration. (In Phase 3, u_L , v_L , and ρ_L will be further changed to their final

values, $n+1_u$, $n+1_v$, and $n+1_\rho$.) As the tilde quantities \tilde{u} , \tilde{v} , and $\tilde{\rho}$ need not be saved for any other purpose, one can simply rename the tilde velocity arrays and the pressure array without any actual storage transfers. The quantity $\tilde{\rho}$, however, appears again in the Phase-3 convective flux equations, thus requiring separate storage for the ρ_L values.

In addition to the starting values of u_L , v_L , ρ_L , and p_L , one must keep the \tilde{I} values available for each cell in order to compute cell pressures. The Q values are no longer needed after Phase 1.

Second, we sweep the mesh systematically in i and j and make the following calculations for each cell.

$$(1) \quad D = \frac{1}{4V} \left\{ (r_1+r_2) \left[(u_{L1}+u_{L2})(y_2-y_1) + (v_{L1}+v_{L2})(x_1-x_2) \right] + (r_2+r_3) \left[(u_{L2}+u_{L3})(y_3-y_2) + (v_{L2}+v_{L3})(x_2-x_3) \right] + (r_3+r_4) \left[(u_{L3}+u_{L4})(y_4-y_3) + (v_{L3}+v_{L4})(x_3-x_4) \right] + (r_4+r_1) \left[(u_{L4}+u_{L1})(y_1-y_4) + (v_{L4}+v_{L1})(x_4-x_1) \right] \right\} .$$

(Note that this is the same divergence equation that appeared in Phase 1, except that the velocities are at step L instead of time n.) From the mass equation, we define

$$(2) \quad S = \frac{1}{\delta t} (\rho_L - \tilde{\rho}) + \rho_L D ,$$

and

$$(3) \quad A = \frac{1}{\frac{1}{c^2} \left(\frac{1}{\delta t} + D \right) + 2\delta t \left(\frac{1}{\Delta r^2} + \frac{1}{\Delta z^2} \right)} .$$

This prescription for A is exact only when the cells are rectangular, but it is much simpler and quicker to calculate than the fully general value,

which may be preferable when the zoning deviates strongly from the rectangular, as errors in A alter the rate of convergence.

In the above,

$$c^2 = \left(\frac{\partial p}{\partial \rho} \right)_s$$

is the square of the adiabatic sound speed, and Δr and Δz represent the average δr and δz of the cell:

$$\Delta r = \frac{1}{2} (x_2 - x_4 + x_1 - x_3) ,$$

$$\Delta z = \frac{1}{2} (y_2 - y_4 + y_3 - y_1) .$$

If the mesh is strongly rotated or distorted, more sophisticated Δr and Δz expressions may be required.

Note that the adiabatic sound speed should be used here, because the Lagrangian representation in this phase is accomplishing the changes in pressure through simultaneous changes in ρ and I (even though the latter is not being calculated at this point). This is in contrast to the purely Eulerian calculation described in previous papers on ICE methodology,¹ in which the change of pressure through the iteration phase results from changes in density only, the full change in internal energy being calculated separately and incorporated into the pressure-change calculation as a separate step. In this purely Eulerian technique, it is the isothermal sound speed that is accordingly required in the implicit pressure-calculation phase.

(4) With D, S, and A defined, we can calculate the necessary pressure change for the cell,

$$\delta p = -\omega AS ,$$

where ω is a relaxation factor. Straight relaxation is given by $\omega = 1$. An optimum overrelaxation in many cases is $\omega = 1.5$ to 1.7, whereas $\omega > 2$ will lead to an unstable iteration.

(5) The convergence test is

$$\left| \frac{\delta p}{p_{\max}} \right| < \epsilon ,$$

where p_{\max} is a current maximum pressure in the system. If the test fails for any cell, a flag is set to indicate that another iteration pass through the mesh will be necessary.

(6) With δp calculated, we can update the ρ_L and p_L values for the cell.

$$\rho_L = \rho(p_L, n_I), \text{ or } \rho_L = \rho_L + \frac{\delta p}{c} ,$$

$$p_L = p_L + \delta p .$$

(7) Now we can adjust u_L and v_L values for the four vertices of the cell:

$$u_{L1} = u_{L1} + \frac{\delta t}{2M_1} r_1 (y_2 - y_4) \delta p ,$$

$$u_{L2} = u_{L2} + \frac{\delta t}{2M_2} r_2 (y_3 - y_1) \delta p ,$$

$$u_{L3} = u_{L3} + \frac{\delta t}{2M_3} r_3 (y_4 - y_2) \delta p ,$$

$$u_{L4} = u_{L4} + \frac{\delta t}{2M_4} r_4 (y_1 - y_3) \delta p ,$$

$$v_{L1} = v_{L1} + \frac{\delta t}{2M_1} \left(\frac{r_2 + r_4}{2} \right) (x_4 - x_2) \delta p ,$$

$$v_{L2} = v_{L2} + \frac{\delta t}{2M_2} \left(\frac{r_3 + r_1}{2} \right) (x_1 - x_3) \delta p ,$$

$$v_{L3} = v_{L3} + \frac{\delta t}{2M_3} \left(\frac{r_4 + r_2}{2} \right) (x_2 - x_4) \delta p ,$$

$$v_{L4} = v_{L4} + \frac{\delta t}{2M_4} \left(\frac{r_1 + r_3}{2} \right) (x_3 - x_1) \delta p .$$

When all cells satisfy the convergence test, the iteration, using the above seven steps, is terminated. At this point, the quantities u_L , v_L , ρ_L , and p_L describe the results of an implicit Lagrangian calculation that is not subject to the Courant condition. One could now move coordinates to complete the calculation if no rezoning were necessary. Note that ρ_L was calculated in terms of n_x^+ , not n_x^{+1} . The neglect of higher-order terms causes n_x^{+1} to differ slightly from ρ_L , but the approximation has not caused any difficulty. The ρ_L is used only in the pressure iteration, whereas in Phase 3 n_x^{+1} will be calculated from n_x by means of conservative fluxing in the mass equation.

In summary, at the end of Phase 2, we have in storage the n -time values of x , y , r , ρ , V , M , and I , as well as \bar{E} and the iterated values of u_L , v_L , p_L , and ρ_L .

F. Phase 3 of the Calculation

The final phase of the ICED-ALE cycle computes

the necessary rezoning changes, i.e., convective and diffusive fluxes.

Assume at this point that a field of grid vertex velocities, u_G and v_G , have been assigned in some appropriate fashion with respect to a fixed, Eulerian reference frame. Thus, for a purely Eulerian calculation,

$$u_G = v_G = 0 .$$

At the other extreme, a purely Lagrangian calculation would use

$$u_G = u_L ,$$

$$v_G = v_L .$$

In general, the grid velocities may be any designated functions, and as such they are neither purely Eulerian nor purely Lagrangian.

There are two types of quantities to be updated in the rezone: cell quantities M (or ρ) and E (or I), and vertex quantities u and v . The procedure is to compute the cell quantities first, then change n_x^{+1} to n_x^{+1} and compute the vertex quantities. Finally, n_x^{+1} can be calculated.

The rezoning can be accomplished using either the old n_x, n_y coordinates or the new n_x^{+1}, n_y^{+1} coordinates. The differences in rezoned quantities that result from these different coordinates are of order δt^2 , and they can be neglected for most purposes. Our procedure is to move the coordinates before the rezone calculations, as numerical methods are usually slightly more stable when time-advanced quantities are used. The new coordinates for all vertices are given by

$$n_x^{+1} = n_x + u_G \delta t ,$$

$$n_y^{+1} = n_y + v_G \delta t ,$$

and

$$n_r^{+1} = n_r^{+1} \text{ for cylindrical coordinates, or } 1.0 \text{ for plane coordinates.}$$

The mass and energy are rezoned on a cell-by-cell basis. For every cell, we must first calculate flux coefficients for each of the four faces, using the new coordinates:

$$\begin{aligned}
FR &= \frac{\delta t(r_1 + r_2)}{8} \left[(u_{G1} - u_{L1} + u_{G2} - u_{L2})(y_2 - y_1) \right. \\
&\quad \left. + (v_{G1} - v_{L1} + v_{G2} - v_{L2})(x_1 - x_2) \right] , \\
FT &= \frac{\delta t(r_2 + r_3)}{8} \left[(u_{G2} - u_{L2} + u_{G3} - u_{L3})(y_3 - y_2) \right. \\
&\quad \left. + (v_{G2} - v_{L2} + v_{G3} - v_{L3})(x_2 - x_3) \right] , \\
FL &= \frac{\delta t(r_3 + r_4)}{8} \left[(u_{G3} - u_{L3} + u_{G4} - u_{L4})(y_4 - y_3) \right. \\
&\quad \left. + (v_{G3} - v_{L3} + v_{G4} - v_{L4})(x_3 - x_4) \right] , \\
FB &= \frac{\delta t(r_4 + r_1)}{8} \left[(u_{G4} - u_{L4} + u_{G1} - u_{L1})(y_1 - y_4) \right. \\
&\quad \left. + (v_{G4} - v_{L4} + v_{G1} - v_{L1})(x_4 - x_1) \right] .
\end{aligned}$$

Note that the flux coefficients are zero in Lagrangian calculations, as $u_G = u_L$ and $v_G = v_L$, and that FR for cell $(i+\frac{1}{2}, j+\frac{1}{2})$ is equal to -FL for cell $(i+3/2, j+\frac{1}{2})$, and FT for cell $(i+\frac{1}{2}, j+\frac{1}{2})$ is equal to -FB for cell $(i+\frac{1}{2}, j+3/2)$.

Recall that the momentum equations in the tilde calculations already contain diffusion terms, through a general stress-tensor deviator, which are used to represent true viscosity or to ensure computational stability. A slight instability results, however, if old-time values are used in the convective flux terms in the mass and energy rezone, although the stability of the mass equation is enhanced by the use of the partially advanced density, ρ_L . In general, it seems preferable to prevent the instability at its source, rather than to add a separate diffusion process. (The truncation errors responsible for instability are not really

in a full "diffusion form" when more than one dimension is considered.) Therefore, we will use flux expressions that can be adjusted toward a partial donor-cell treatment. It is convenient to embody the flux coefficients, FR, FT, FL, and FB, within expressions that allow various differencing forms determined from input constants, α_0 and β_0 :

$$\alpha_R = \alpha_0 \text{ sign FR} + 4FR \beta_0 / \left(v_{i+3/2}^{j+\frac{1}{2}} + v_{i+\frac{1}{2}}^{j+\frac{1}{2}} \right) ,$$

$$\alpha_T = \alpha_0 \text{ sign FT} + 4FT \beta_0 / \left(v_{i+\frac{1}{2}}^{j+3/2} + v_{i+\frac{1}{2}}^{j+\frac{1}{2}} \right) ,$$

$$\alpha_L = \alpha_0 \text{ sign FL} + 4FL \beta_0 / \left(v_{i-\frac{1}{2}}^{j+\frac{1}{2}} + v_{i+\frac{1}{2}}^{j+\frac{1}{2}} \right) ,$$

$$\alpha_B = \alpha_0 \text{ sign FB} + 4FB \beta_0 / \left(v_{i+\frac{1}{2}}^{j-\frac{1}{2}} + v_{i+\frac{1}{2}}^{j+\frac{1}{2}} \right) ,$$

where "sign FR," for example, = $\begin{cases} +1 & \text{if } FR \geq 0 \\ -1 & \text{if } FR < 0 \end{cases}$,

and the input constants allow these combinations:

$$\alpha_0 = 0 \text{ and } \beta_0 = 0 \quad \Rightarrow \text{centered,}$$

$$\alpha_0 = 1 \text{ and } \beta_0 = 0 \quad \Rightarrow \text{donor cell,}$$

$$\alpha_0 = 0 \text{ and } \beta_0 = 2 \quad \Rightarrow \text{interpolated donor cell.}$$

Note, however, that α_0 must be sufficiently positive² for the mass equation to be stable. As full donor-cell differencing is too diffusive for most circumstances, generally $0 < \alpha_0 < 1$.

The new mass and energy for a cell $(i+\frac{1}{2}, j+\frac{1}{2})$ are given by

$$\begin{aligned}
n_{i+\frac{1}{2}}^{j+\frac{1}{2}} &= n(\rho V)_{i+\frac{1}{2}}^{j+\frac{1}{2}} + FR \left[(1-\alpha_R)\rho_{L_{i+\frac{1}{2}}}^{j+\frac{1}{2}} + (1+\alpha_R)\rho_{L_{i+3/2}}^{j+\frac{1}{2}} \right] \\
&\quad + FT \left[(1-\alpha_T)\rho_{L_{i+\frac{1}{2}}}^{j+\frac{1}{2}} + (1+\alpha_T)\rho_{L_{j+3/2}}^{j+\frac{1}{2}} \right] \\
&\quad + FL \left[(1-\alpha_L)\rho_{L_{i+\frac{1}{2}}}^{j+\frac{1}{2}} + (1+\alpha_L)\rho_{L_{i-\frac{1}{2}}}^{j+\frac{1}{2}} \right] \\
&\quad + FB \left[(1-\alpha_B)\rho_{L_{i+\frac{1}{2}}}^{j+\frac{1}{2}} + (1+\alpha_B)\rho_{L_{i+\frac{1}{2}}}^{j-\frac{1}{2}} \right] ,
\end{aligned}$$

and

$$\begin{aligned}
n+1 \rho_{i+\frac{1}{2}}^{j+\frac{1}{2}} &= \frac{1}{n+1 M_{i+\frac{1}{2}}^{j+\frac{1}{2}}} \left\{ \left(\frac{n}{M \bar{E}} \right)_{i+\frac{1}{2}}^{j+\frac{1}{2}} \right. \\
&+ FR \left[(1-\alpha_R) \left(\frac{n}{\rho \bar{E}} \right)_{i+\frac{1}{2}}^{j+\frac{1}{2}} + (1+\alpha_R) \left(\frac{n}{\rho \bar{E}} \right)_{i+\frac{3}{2}}^{j+\frac{1}{2}} \right] \\
&+ FT \left[(1-\alpha_T) \left(\frac{n}{\rho \bar{E}} \right)_{i+\frac{1}{2}}^{j+\frac{1}{2}} + (1+\alpha_T) \left(\frac{n}{\rho \bar{E}} \right)_{i+\frac{3}{2}}^{j+\frac{1}{2}} \right] \\
&+ FL \left[(1-\alpha_L) \left(\frac{n}{\rho \bar{E}} \right)_{i+\frac{1}{2}}^{j+\frac{1}{2}} + (1+\alpha_L) \left(\frac{n}{\rho \bar{E}} \right)_{i-\frac{1}{2}}^{j+\frac{1}{2}} \right] \\
&\left. + FB \left[(1-\alpha_B) \left(\frac{n}{\rho \bar{E}} \right)_{i+\frac{1}{2}}^{j+\frac{1}{2}} + (1+\alpha_B) \left(\frac{n}{\rho \bar{E}} \right)_{i+\frac{1}{2}}^{j-\frac{1}{2}} \right] \right\}
\end{aligned}$$

Before updating the vertex quantities, we next calculate $n+1 V$ (as per the equation in Sec. I C, item (3), which in turn allows us to calculate

$$n+1 \rho_{i+\frac{1}{2}}^{j+\frac{1}{2}} = \frac{n+1}{V} \left(\frac{M}{V} \right)_{i+\frac{1}{2}}^{j+\frac{1}{2}}$$

The new volume and density replace $n V$ and $n \rho$. The new vertex masses are then calculated using the M_i^j equation given in Sec. I C, item (4).

To adjust the vertex values of u_L and v_L for rezoning, we set initial values at all vertices, where

$$n+1 u_i^j = \left(\frac{n}{M} \right)_i^j u_{L_i}^j,$$

and

$$n+1 v_i^j = \left(\frac{n}{M} \right)_i^j v_{L_i}^j.$$

The second sweep adjusts the four corner vertex values of each cell in a manner analogous to that in the first two phases. For each cell in turn, we define several quantities:

$$\begin{aligned}
F13 &= \frac{\delta t \rho_{L_{i+\frac{1}{2}}}^{j+\frac{1}{2}} (r_1+r_3)}{16} \left[(u_{G1}^{-} u_{L1}^{+} + u_{G3}^{-} u_{L3}^{+}) (y_3 - y_1) \right. \\
&\left. + (v_{G1}^{-} v_{L1}^{+} + v_{G3}^{-} v_{L3}^{+}) (x_1 - x_3) \right],
\end{aligned}$$

$$\begin{aligned}
F24 &= \frac{\delta t \rho_{L_{i+\frac{1}{2}}}^{j+\frac{1}{2}} (r_4+r_2)}{16} \left[(u_{G4}^{-} u_{L4}^{+} + u_{G2}^{-} u_{L2}^{+}) (y_2 - y_4) \right. \\
&\left. + (v_{G4}^{-} v_{L4}^{+} + v_{G2}^{-} v_{L2}^{+}) (x_4 - x_2) \right],
\end{aligned}$$

$$\alpha 13 = \alpha_o \text{ sign } F13 + \beta_o \frac{4F13}{(v \rho_L)_{i+\frac{1}{2}}^{j+\frac{1}{2}}},$$

$$\alpha 24 = \alpha_o \text{ sign } F24 + \beta_o \frac{4F24}{(v \rho_L)_{i+\frac{1}{2}}^{j+\frac{1}{2}}}.$$

Here, the "sign" has the same meaning as it did in the mass- and energy-flux expressions given above, and the α_o and β_o are the same quantities as in those expressions or may be chosen independently. Because a greater proportion of donor-cell differencing is required to stabilize the mass equation than the momentum equations, it is well to use a different (smaller) α_o in the momentum equations. Given the values of F13, F24, $\alpha 13$, and $\alpha 24$ for a given cell, the vertex contributions are given by:

$$n+1 u_1 = n+1 u_1 - \frac{F24}{n+1 M_1} \left[u_{L3} (1-\alpha 24) + u_{L1} (1+\alpha 24) \right],$$

$$n+1 u_2 = n+1 u_2 - \frac{F13}{n+1 M_2} \left[u_{L4} (1-\alpha 13) + u_{L2} (1+\alpha 13) \right],$$

$$n+1 u_3 = n+1 u_3 + \frac{F24}{n+1 M_3} \left[u_{L3} (1-\alpha 24) + u_{L1} (1+\alpha 24) \right],$$

$$n+1 u_4 = n+1 u_4 + \frac{F13}{n+1 M_4} \left[u_{L4} (1-\alpha 13) + u_{L2} (1+\alpha 13) \right],$$

$$n+1 v_1 = n+1 v_1 - \frac{F24}{n+1 M_1} \left[v_{L3} (1-\alpha 24) + v_{L1} (1+\alpha 24) \right],$$

$$n+1 v_2 = n+1 v_2 - \frac{F13}{n+1 M_2} \left[v_{L4} (1-\alpha 13) + v_{L2} (1+\alpha 13) \right],$$

$$n+1 v_3 = n+1 v_3 + \frac{F24}{n+1 M_3} \left[v_{L3} (1-\alpha 24) + v_{L1} (1+\alpha 24) \right],$$

$$n+1 v_4 = n+1 v_4 + \frac{F13}{n+1 M_4} \left[v_{L4} (1-\alpha 13) + v_{L2} (1+\alpha 13) \right].$$

Finally, the new velocity field allows us to calculate the new specific internal energies for all cells:

$${}^{n+1}I_{i+\frac{1}{2}}^{j+\frac{1}{2}} = {}^{n+1}E_{i+\frac{1}{2}}^{j+\frac{1}{2}} - \frac{1}{8} \left(u_1^2 + u_2^2 + u_3^2 + u_4^2 + v_1^2 + v_2^2 + v_3^2 + v_4^2 \right),$$

where the u and v values are the $n+1$ values just calculated.

G. Boundary Conditions

Various boundary treatments can be used in an ICED-ALE program,² but we discuss here only the simple case of straight, rectangular reflective boundaries on all four sides of the mesh. (For ease of understanding, the version of the code presented in the following sections is limited to this one case.) The reflective boundaries considered are free-slip walls, the left boundary becoming the axis of symmetry for calculations in cylindrical coordinates. The criterion for any boundary condition is that velocities on boundary vertices be set in a suitable fashion. For free-slip walls, this means that normal wall velocities must be kept zero throughout the calculation. In the three phases of the calculational cycle, particular attention must therefore be given to the following:

- (1) After the Phase-1 tilde velocity calculations, normal wall velocities must be reset to zero, i.e., $\bar{u} = 0$ on the left and right boundaries, and $\bar{v} = 0$ on the top and bottom boundaries.
- (2) During the pressure iteration in Phase 2, the normal wall velocities must be kept zero. Therefore, the appropriate u_L and v_L component(s) must be set to zero in boundary cells before proceeding to the next cell in the iteration.
- (3) During the rezoning of cell quantities, cells adjacent to boundaries do refer to ρ and E values outside the walls, but these terms have zero coefficients, so they may be left unspecified.
- (4) After the ${}^{n+1}u$ and ${}^{n+1}v$ calculations, the normal wall velocities must be zeroed again, in a manner analogous to that used for the Phase-1 tilde velocities. As described here, the normal velocities are set assuming that the boundary is truly horizontal or vertical. Generally, however, any boundary (except the axis) may be curvilinear;

then the "normal" velocity becomes a function of both the u and v components, requiring more careful treatment.

It is important to note that no pressure boundary conditions are required in YAQUI. This is a direct benefit of the Phase-2 iteration procedure.

It is useful to surround the mesh with a band of fictitious cells (described in Sec. II B) to aid in the treatment of the boundary conditions. Generally, ρ and E should simply be set forever to zero in the fictitious cells. This allows calculation of appropriate zero fluxes at the boundaries in Phase 3. In many applications, however, it is useful to allow the rigid walls of the mesh to expand in the rezone. Then fluid is swept up, and appropriate ambient values of ρ and E must be maintained in the fictitious cells. An example of this is shown in the sample code version included in this report. Here a uniform exterior E is generated in the setup and is allowed to remain constant for all time. The rezone calculates appropriate exterior ρ_L values to maintain atmospheric equilibrium. These new exterior ρ_L values subsequently become the final exterior ${}^{n+1}\rho$ values for the cycle. Rezoning is discussed further in Sec. III B.

II. THE YAQUI COMPUTING PROGRAM

A. General Structure

Here we describe the principal structural details of the LASL ICED-ALE computing program, called YAQUI, whose flow diagram and listing appear in Appendixes A and B, respectively. YAQUI was written as a CDC-7600 production code for specific contractual purposes. As such, it embodies a number of features to make efficient use of computer storage and time. As was anticipated, however, the same basic code has been developed in several directions by a number of investigators, so it was purposely constructed in a modular form. The physical arrangement of these modules corresponds to their logical sequence in the computing cycle to the greatest degree practicable. The loss of efficiency in certain regions that results from having the entire code in FORTRAN IV, rather than machine language, is hopefully counterbalanced by increased readability for most users and the simplification of adapting it for use on computers other than the CDC-6600/7600 series.

As depicted in Fig. 4, YAQUI is built in an overlay fashion to minimize the use of small core memory (SCM), which is the "fast" memory on the CDC-7600. The main overlay, (0,0), which always resides in SCM, contains the main controlling program, YAQUI. Subserving to it are the programs in the two primary overlays, (1,0) and (2,0), which reside on disk storage. YASET is the setup program, and YAQUI1 performs the three-phase ICED-ALE calculations.

The structure within each of these three programs is further detailed in Fig. 5, which shows the UPDATE notation used in the actual code.

In addition to the main program, YAQUI, the (0,0) overlay contains the subroutines LØØP and FILMCØ. LØØP handles the three-row buffering scheme that shuttles cell data between large core memory (LCM) and the SCM common YSC1. The details of cell-data storage and the buffering scheme are given in Secs. II C and D. FILMCØ (for film coordinates) computes the scaling for the microfilm plots. Because these two subroutines are required by both of the primary overlays, it is expedient to place them in the main overlay. Because they are thus always resident, the primary overlays can access them at will. Also in the main overlay is the common YSC2, which contains all the SCM data that must be maintained from cycle to cycle, and which is the SCM portion of the information written on tape for restarting purposes.

Two LCM blocks are initially defined in the main program: YLC1 is the storage block for cell data, and YLC2 is the storage block for the optional particles, described in Sec. II E.

To set up a calculation from initial input data, the main program calls YASET, the (1,0) overlay program, from the disk, and surrenders control to it. This overlay is placed in SCM immediately

following the (0,0) overlay. YASET itself is only a two-instruction program: it prints "YASET CALLED," so that the user can monitor his path through the overlays, and then immediately calls subroutine YASET1. YASET1 performs the actual setup, and in turn calls upon PARTGEN, to generate particles if specified, and MESHMKR, which creates the computing mesh with its initial cell and vertex quantities. When the problem setup is complete, YASET1 returns control to the (0,0) main overlay program.

To calculate after setting up, the main program calls YAQUI1, the (2,0) primary overlay, from the disk, and surrenders control to it. Because this is an overlay of the same level as (1,0), it covers the image of (1,0) in SCM, being read in also to the locations immediately following the (0,0) overlay and thus making efficient use of SCM space. Like YASET, YAQUI1 is a two-instruction program: it prints "YAQUI2 CALLED," and immediately calls subroutine YAQUI2. Should the program abort because of an unexpected error, the user can quickly ascertain which program he is in, inasmuch as the range of instruction addresses for both the (1,0) and (2,0) overlays is the same.

YAQUI2 is the largest section of code in the entire computer program. It contains the three-phase ICED-ALE, whose calculational cycles are repeated continuously under the direction of the "Control Region." This region is strategically placed immediately after the n_p calculation, at which point in the cycle all the quantities that represent the complete solution at a given instant in problem time are available. The control region provides all microfilm plots and cell data prints. Also, it updates the problem time, t , by the current δt , performs tape dumps and tape restarts, and senses problem completion or an impending operating-system time limit. In the latter two events, it returns control to the main program, which, in turn, searches the input queue for further tasks. If there are none, the job is ended.

YAQUI2 makes use of two subroutines: PARTMØV moves and plots particles, and REZØNE calculates new grid vertex velocities, u_G and v_G , and new vertex coordinates, x , y , and r , for Phase 3 if the flow is neither pure Lagrangian nor pure Eulerian. If, however, the flow is pure Lagrangian or pure Eulerian, these velocities and the new coordinates

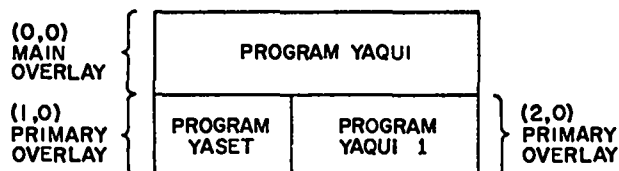

Fig. 4. The YAQUI 3 program overlay structure.

YAQUI CODE STRUCTURE

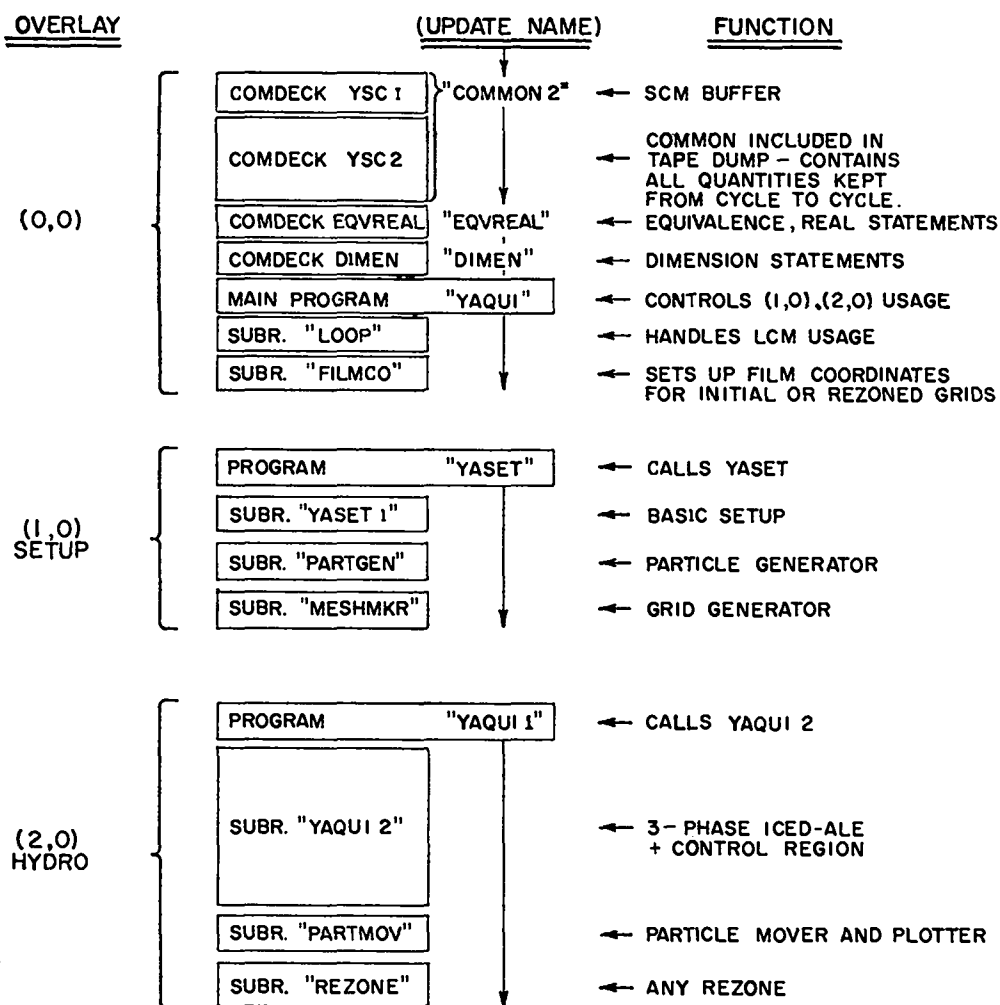

Fig. 5. Detailed breakdown of the YAQUI overlays, describing the functions of all sections and the UPDATE nomenclature.

are directly calculated in YAQUI2 in a simple, straightforward fashion. The REZONE package is really a "roll-your-own" section in which the user creates rezoning logic appropriate to his particular needs. (In the version of YAQUI presented here, the REZONE subroutine is an example of a possible way to follow the rise of debris from an atmospheric burst.)

To restart a calculation from a tape dump, the main program bypasses the (1,0) overlay and

calls (2,0) directly. The restart condition is sensed immediately by YAQUI2, and the control region reads in the tape dump, placing the data in SCM and LCM as required, and turns control over to the point in the calculational cycle that will continue the problem from where it left off when the tape dump was made.

B. The Indexing Notation

An examination of Fig. 2 shows some variables centered at vertices and some at cell centers, a common occurrence in Lagrangian computing methods. In FORTRAN, one can reference x_i^j simply as "X(I,J)," but $p_{i+\frac{1}{2}}^{j+\frac{1}{2}}$ cannot be referenced by a "half-integer" index, so the convention has evolved that "P(I,J)" refers to this pressure. Thus the indices I and J refer to a quantity lying at the lower left vertex of a cell, or at the cell center, depending upon where the quantity is defined. In YAQUI, "(I,J)" is replaced simply by "(IJ)," as only single subscripts are used for computer efficiency. In the YAQUI subscript notation, the letter "P" stands for "+," and "M" stands for "-." Thus, we write

$$\begin{aligned} IJ &= (i,j) , \\ IPJ &= (i+1,j) , \\ IJM &= (i,j-1) , \\ IPJP &= (i+1,j+1) , \\ &\text{etc.} \end{aligned}$$

Such a notation permits easy readability of programmed difference equations in the code. Figure 6 shows the single subscripts typically seen in reference to vertex quantities, and Fig. 7 shows subscripts referring to cell quantities.

As the number of vertices in either direction is one greater than the number of cells, it is apparent that the grid in computer storage must be at least $(\bar{I}+1)$ by $(\bar{J}+1)$ in size. Because our indexing refers to cell centers and lower left vertices, we must allow one extra column of storage

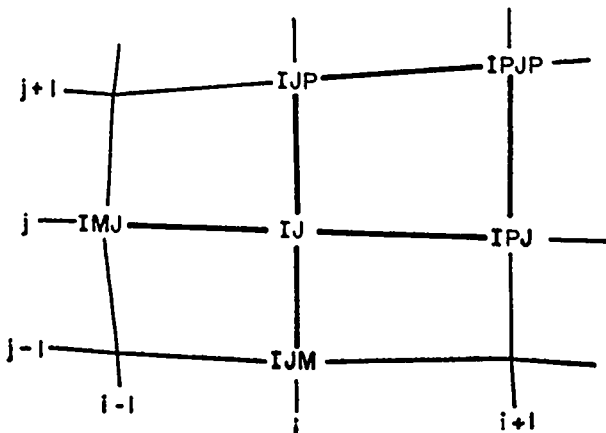

Fig. 6. Single subscript notation for vertex quantities.

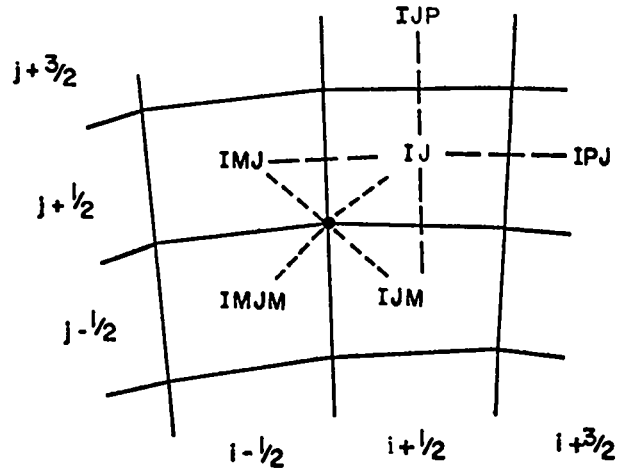

Fig. 7. Single subscript notation for cell quantities.

on the right and one extra row along the top. YAQUI includes one extra row along the bottom in addition, giving a mesh that is $(\bar{I}+1)$ by $(\bar{J}+2)$ in extent. These exterior zones are known as fictitious cells, and having them on three sides helps in the treatment of expanding meshes and certain boundary conditions. Note that fictitious cells are not used on the left, however. The code was basically intended for calculations in cylindrical coordinates, in which the left boundary is an axis of symmetry. In plane coordinates, it becomes a rigid free-slip wall, or plane of symmetry. The omission of fictitious cells on the left implies that no fluxing will ever be desired on that side, and the code would have to be modified to allow such a feature. The actual YAQUI mesh for the conceptual mesh of Fig. 1 is shown in Fig. 8. Coordinates are not calculated for fictitious cell vertices.

Obviously, double DØ loops in FORTRAN to cover all vertices would have the limits $J = 2$ to $JP2$ and $I = 1$ to IPl . Similarly, loops to cover all cell centers would have the limits $J = 2$ to $JP1$ and $I = 1$ to $IBAR$.

C. The Storage of Cell Data

The YAQUI code was designed for running finely resolved calculations, implying several thousand computing cells. In addition to the basic fluid dynamics, space has been left in SCM for the later

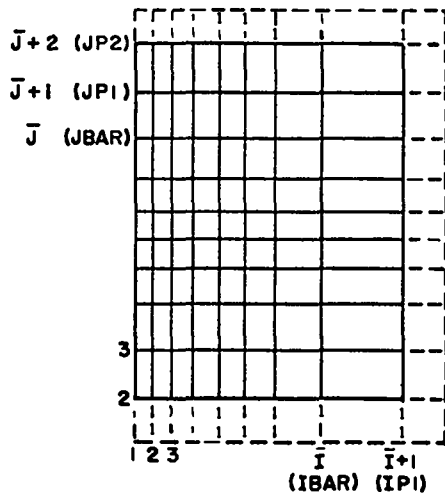

Fig. 8. An actual YAQUI mesh, corresponding to the conceptual mesh of Fig. 1, showing vertex notation. Fictitious cells are denoted by dashed lines.

inclusion of code to deal with other physical phenomena, such as magnetohydrodynamics, turbulence, and chemistry effects. Therefore, all cell data are maintained on LCM, and the code deals with only three rows of cells at a time in SCM processing. Clearly, the optimum procedure is that which requires the minimum number of read/write references to LCM. Accordingly, the cell variables are stored in an "interleaved" fashion, in which all the variables for a given cell are stored contiguously, followed by all the variables for the next cell, etc. (Contrast this with the traditional method of storing cell variables in individual \bar{I} by \bar{J} blocks for each variable. This scheme is appropriate when the computing code is designed for smaller meshes that will always fit in SCM.) In the version of YAQUI presented here, the full calculational cycle, including the optional particles, requires 35 different cell variables, but we are able to get by with using only 14 storage words per cell. This is made possible by retaining quantities during a cycle only as long as they are needed, and then using their storage words for other quantities. Figure 9 shows the allocation of the 14 storage words for a YAQUI cell in the (1,0) and (2,0) overlays. The ordering from left to right corresponds to the actual order in which quantities are calculated in the code. A black dot implies that the quantity currently in the

given storage word is referenced to calculate the quantity specified at the top of the column. The open dots in the rezone imply that x , r , y , and V may be referenced, depending upon the particular rezone. Note that the vertex masses, M_v , and the cell volumes, V , are stored as reciprocals for increased computer efficiency. Because most references to M_v and V are in denominators of equations, the time-consuming divide operation is thus avoided much of the time.

The quantities $2\delta t \left(\frac{1}{\Delta r^2} + \frac{1}{\Delta z^2} \right)$, known in the code as DELSM, and $1/c^2$, known as RCSQ, are invariant through the Phase-2 iteration. It is, therefore, expedient to compute their values throughout the mesh beforehand to avoid needless and repetitive calculation within the iteration itself.

In the convective-flux part of Phase 3, the "n+1" values of M_c (the cell mass), $1/M_v$ (the vertex mass), and u and v are initially stored in vacant slots. Their "n" values are still required through the calculation of the momentum equations, after which the new masses and velocities can be transferred to their ordinary storage words. This places them in their proper locations as the "n" values going into Phase 1 of the next cycle.

The contour quantity (CQ) in the control region denotes the field of some chosen cell variable for which a contour plot is drawn on microfilm. The quantities referred to in the PARTMOV subroutine are described in Sec. II E.

Charts such as Fig. 9 have proven extremely useful in initially planning the storage before-a code is written, but they are equally useful thereafter as an aid in visualizing what quantities are available at a given point in the calculational cycle, and where storage vacancies exist.

YLCl, the storage block for cell data on LCM, contains a single array, AAl, dimensioned at 131000_{10} words in the version of the code presented here. Because 14 words per cell are used in this version, a maximum of 9357 cells (the product of $\bar{I}+1$ and $\bar{J}+2$) are available.

D. The Three-Row Buffering Scheme

Subroutine LOPP, in the (0,0) main overlay, shuttles the cell data between the large LCM array and a small buffer in SCM where it is operated on.

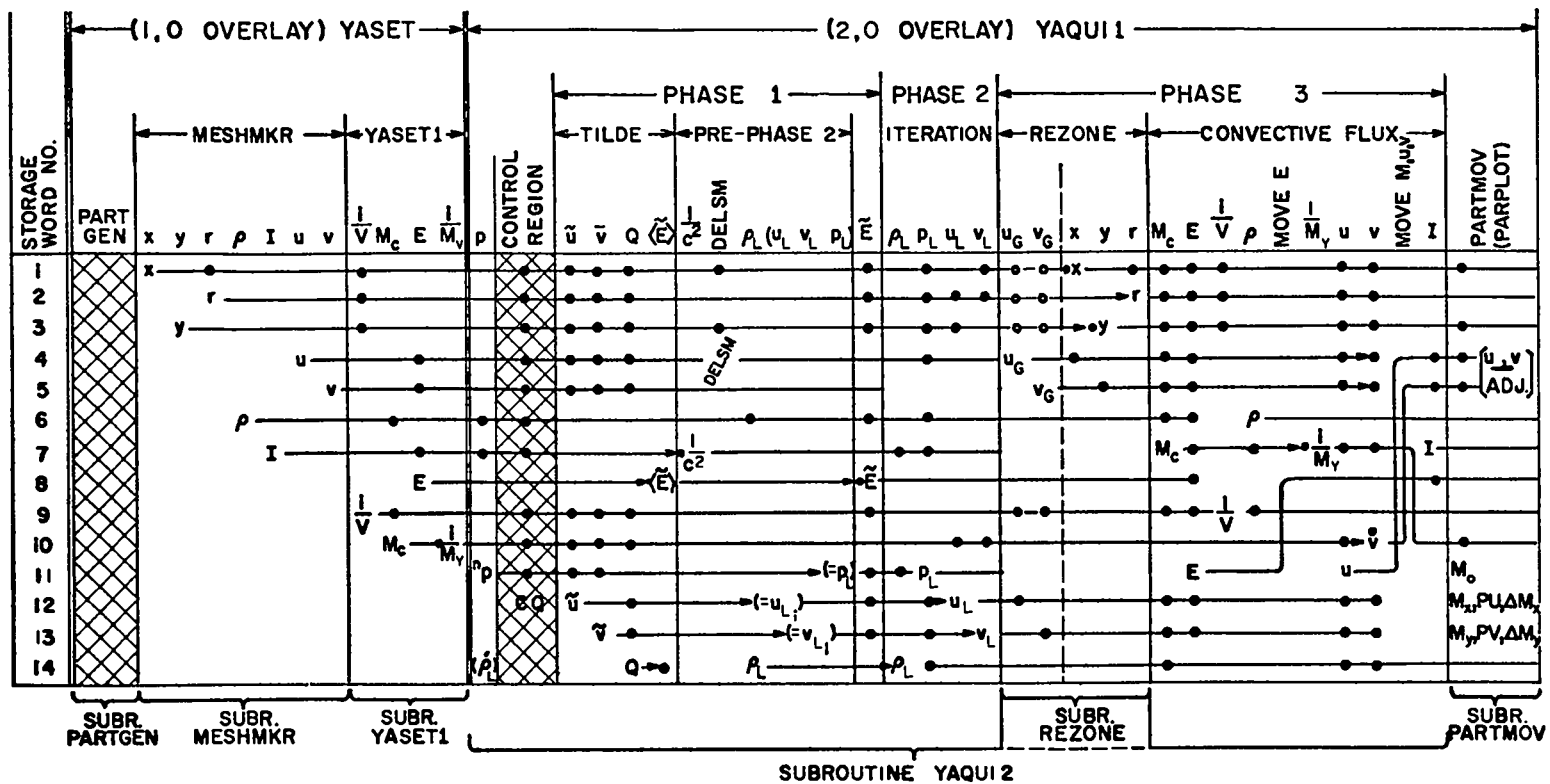

Number Word	Equivalence	Code Name	Number Word	Equivalence	Code Name
1	x	X	8	$E, \langle \bar{E} \rangle, \bar{E}$	E, ETIL, ETIL
2	r	R	9	$1/V$	RVØL
3	y	Y	10	$\bar{M}_c, 1/\bar{M}_v, n+1_v$	M, RM, VP
4	$u, 2\delta t \left(\frac{1}{\Delta r^2} + \frac{1}{\Delta z^2} \right), u_G$	U, DELSM, UG	11	$\bar{p}, \bar{p}_L, n+1_E, n+1_u, \bar{M}_0$	P, PL, EP, UP, PMO
5	v, v_G	V, VG	12	$\bar{u}, u_L, \bar{M}_x, \bar{P}_U$	UTIL, UL, PMX, PU, (CQ)
6	ρ	RØ	13	$\bar{v}, v_L, \bar{M}_y, \bar{P}_V$	VTIL, VL, PMY, PV
7	$I, 1/c^2, n+1_{M_c}, 1/n+1_{M_v}$	SIE, RCSQ, MP, RMP	14	$Q, \bar{\rho}_L$	Q, RØL

Fig. 9. The storage of cell data in YAQUI, showing how the 14 words per cell are allocated.

Generally, LØØP maintains three rows of the grid in SCM at a time: the row being processed and the rows above and below. All calculations affecting cell data are actually performed directly on the current contents of the buffer. Because the cell data are interleaved in storage, all quantities pertaining to the three rows of cells are instantly available. The schematic flow diagram and sample FORTRAN double DØ-loop in Fig. 10 show how the buffering takes place.

(1) Before the "DØ" statements are entered, a CALL is made to the START entry of LØØP. START reads in the entire contents of the bottommost three rows of the grid from LCM to the SCM buffer, placing row $j = 1$ in the buffer section designated "row 1/3"; likewise row $j = 2$ is read into "row 2/3," and row $j = 3$ is read into "row 3/3." Rows 1/3, 2/3, and 3/3 are contiguous in SCM, and like their counterparts in LCM each contains $NQI = NQ * IP1$ words, where NQ is the number of quantities, or storage words, per cell. With the three rows read in, the calling program needs to know how to access data in the buffer. This information is provided by the setting of the indices IJM, IJ, and IJP to point to the first words for the $i = 1$ column of cells in each row. Thus, IJM is set to the first-word address (f.w.a.) of SCM row 1/3; similarly, IJ points to the f.w.a. of 2/3, and IJP points to the f.w.a. of 3/3. Note the indicator IBUF which is set to 1; it will control the subsequent reading and writing of individual rows and the resetting of the three indices. With the first three rows of cells read in and the basic indices set, control is returned to the calling program.

(2) The double DØ loops are initiated. Secondary indices are needed for cells not lying immediately above or below cell IJ, so $IPJ (= i+1, j)$ and $IPJP (= i+1, j+1)$, which initially refer to the $i=2$ column of cells, are easily obtained by applying increments of the number-of-storage-words-per-cell, NQ , to the primary indices IJ and IJP. In the example shown in Fig. 10, we are able to calculate the radius of a cell as the simple average of the radii of its four vertices. The terminal statement of the inner DØ loop, which counts columns within each row, is statement No. 89. Note how the primary indices, IJ and IJP, are first advanced to the next column in the row. The inner

loop is repeated until the row is completed, at which time control passes to the "CALL LØØP" statement.

(3) The LØØP entry immediately writes row IJM back onto LCM, and depending on the setting of IBUF, goes to statement No. 10, 20, or 30. Because IBUF was initially set to 1, control passes to statement No. 10 in our example. Now the indices IJP, IJ, and IJM are reset to point to different SCM rows -- IJP to the vacated row 1/3, IJ to 3/3, and IJM to 2/3. IBUF is reset to 2 to control the next entry to LØØP, and control passes to statement No. 40 which will read row $j = 4$, the new IJP row, into SCM row 1/3. Note that no unnecessary shuffling of data in SCM has taken place: row $j-1$ was read out and replaced by row $j+1$, and the three indices were reset to point to where the rows $j+1$, j , and $j-1$ are located. As depicted at the bottom of Fig. 10, the grid rows in SCM are in their actual logical order only every third row.

(4) LØØP returns to statement No. 99 in the sample calling program, and rows are processed similarly until all the rows specified by the J DØ-loop have been processed, at which time control passes to the "CALL DØNE" statement.

(5) The DØNE entry is really only a cleaning-up operation: because further reading is unnecessary, it merely writes the final two rows, j and $j+1$ (JP1 and JP2, respectively) back out onto LCM.

Not indicated in the flow of Fig. 10 is the incrementing of the relative address indices for reading and writing LCM. These are initially set to 0, and incremented by NQI as processing progresses up the mesh.

Given this three-row buffering subroutine, the user needs only to include the CALLs to START, LØØP, and DØNE at the appropriate points in the DØ-loops and to increment by NQ words for each cell within a row. Other than that, the logic he must know is no more complex than if the data were entirely in SCM.

The number of storage words per cell in the YAQUI version presented here is seen to be $NQ = 14$, as per Fig. 9. This may be increased very simply by adding the new variables to the EQUIVALENCE and DIMENSION statements in the Comdecks EQVREAL and DIMEN, respectively, and redefining NQ in the (0,0) main program at one place only.

«ENTRY LOOP»

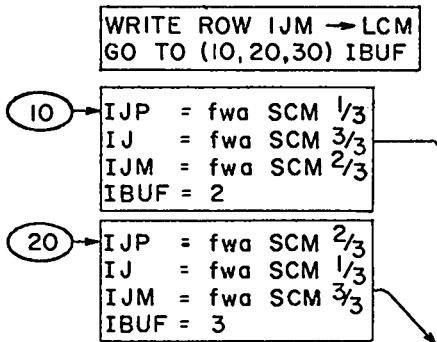

«ENTRY START»

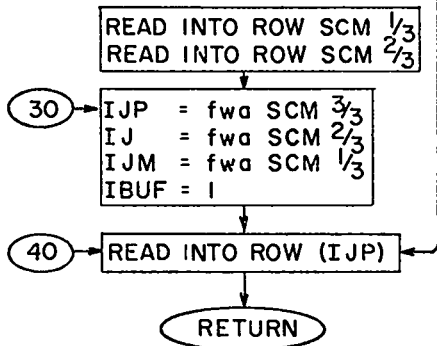

«ENTRY DONE»

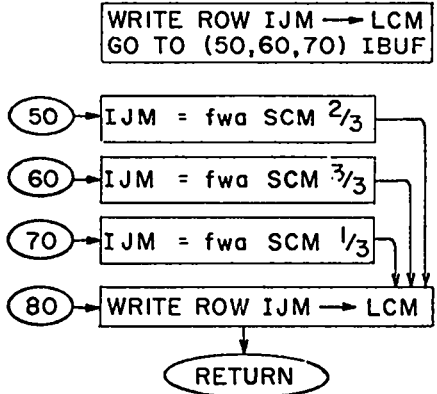

SCM BUFFER

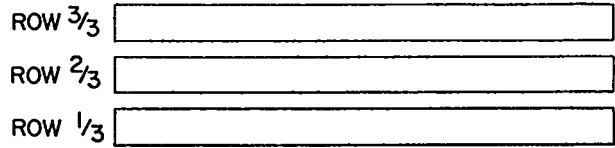

INTERLEAVED STORAGE at NQ WDS./CELL

LOOP EXAMPLE :

```

    CALL START
    DO 99 J = 2, JPI
    DO 89 I = 1, IBAR
      IPJ = IJ + NQ
      IPJP = IJP + NQ
      R = .25 * [R(IPJ) + R(IPJP) + R(IJP) + R(IJ)]
      }
    IJ = IPJ
    IJP = IPJP
    CALL LOOP
    CONTINUE
    CALL DONE
  
```

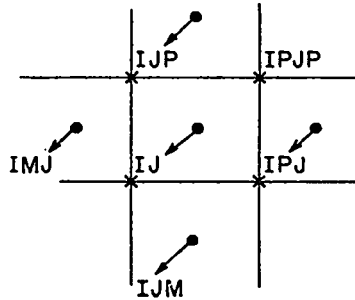

	J	J	J	J	J	J	J
ROW $\frac{3}{3}$ →	(IJP) 3	(IJ) 3	(IJM) 3	(IJP) 6	(IJ) 6	(IJM) 6	(IJP) 9
ROW $\frac{2}{3}$ →	(IJ) 2	(IJM) 2	(IJP) 5	(IJ) 5	(IJM) 5	(IJP) 8	(IJ) 8
ROW $\frac{1}{3}$ →	(IJM) 1	(IJP) 4	(IJ) 4	(IJM) 4	(IJP) 7	(IJ) 7	(IJM) 7

Fig. 10. YAQUI three-row buffer.

The SCM buffer is in common YSC1 which contains a single array, AASC, dimensioned at 4242₁₀ words in this YAQUI version. Because AASC must be able to hold three complete rows at once, NQ = 14 means $\bar{I} < 100$.

Other entry points in the LOOP subroutine, not shown in Fig. 10, allow the user to access any cell at random easily, and to perform DØ loops with the J index reversed so as to sweep from top to bottom. Examples of this flexible routine are seen in numerous places throughout YAQUI.

E. The Particle Option

The basic ICED-ALE scheme has no dependence upon particles, but deals entirely with field variables related to the computing grid. It is useful, however, to include particles in many problems of interest. These may serve either as true "markers," which are carried along by the flow but have no influence upon it, or they may act upon the surrounding fluid. In the latter case, we must store velocity components, a mass, and a drag coefficient for each particle, in addition to the usual coordinates. This permits calculation of momentum changes experienced by the particles owing to fluid forces, these changes in turn being subtracted from the fluid momentum on a cell-by-cell basis.

For simplicity, we shall first discuss the basic particle-moving scheme used in YAQUI, and then describe the inclusion of the momentum-exchange feature.

1. The Particle Mover. Our technique for moving particles in a general, quadrilateral grid is based on use of a temporary, uniform rectangular cell grid superimposed on the YAQUI grid. Given a velocity field related to a uniform grid, particles are easily moved by an ordinary interpolated area-weighting scheme. The problem, then, is to define a velocity field on the superimposed grid (hereafter called the particle grid) so that it reasonably approximates the velocity field of the current YAQUI grid. This is done as follows.

(a) First, we define the particle grid by specifying its cell-edge lengths, Δx and Δy , and its overall dimensions PXR and PYT. Because we use a vacant part of the YAQUI cell storage to store particle grid quantities, we do not allow the number

of zones in either the r or z direction to exceed that of the YAQUI grid. We generally, however, run at this maximum for the best resolution. In most calculations, the dimensions Δx and Δy are chosen so that the particle grid just encompasses the region covered by the regular rectilinear or curvilinear grid, although in some cases when particles are used solely in some specific region, the particle grid may be placed only over the region of interest.

(b) The second step, after definition and location of the particle grid, is to sweep the YAQUI vertices systematically and do the following for each.

- If the vertex lies outside the particle grid, skip to the next vertex. To be included, the vertex must have $x \leq \text{PXR}$ and $\text{PYB} \leq y \leq \text{PYT}$, where PYB is the y coordinate of the bottom of the particle grid.
- Determine (i,j) of the particle-grid cell that contains the vertex.
- Assign to each of the four corners of the particle-grid cell (i,j) x and y momenta (M_x and M_y) and mass (M_0) according to

$$\left(M_x \right)_{i+1}^j = \left(M_x \right)_{i+1}^j + \mu (w) (\Delta y - h) / \Delta x \Delta y ,$$

$$\left(M_x \right)_{i+1}^{j+1} = \left(M_x \right)_{i+1}^{j+1} + \mu (w) (h) / \Delta x \Delta y ,$$

$$\left(M_x \right)_i^{j+1} = \left(M_x \right)_i^{j+1} + \mu (\Delta x - w) (h) / \Delta x \Delta y ,$$

$$\left(M_x \right)_i^j = \left(M_x \right)_i^j + \mu (\Delta x - w) (\Delta y - h) / \Delta x \Delta y ,$$

where w and h are defined as shown in Fig. 11. Use similar expressions with the same weighting factors for M_y and M_0 .

(c) Finally, after momenta and mass have been assigned from all YAQUI vertices onto the appropriate particle-grid vertices, we calculate the u and v velocities of the particle-grid vertices as

$$PU = M_x / M_0 \quad \text{and} \quad PV = M_y / M_0 ,$$

which are the velocities to be used in moving the particles.

(d) To move a particle, we first determine in which cell (i,j) of the particle grid it is located.

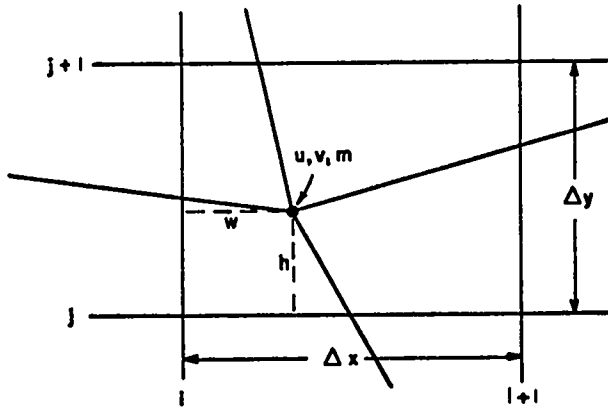

Fig. 11. Assigning YAQUI vertex quantities to the surrounding particle-grid cell.

It is then moved according to an interpolated velocity based on the corner velocities of the particle-grid cell. If the particle lies at positions (w, h) as shown in Fig. 12, then

$$u_p = \left[PU_{i+1}^j (w)(\Delta y - h) + PU_{i+1}^{j+1} (w)(h) + PU_i^{j+1} (\Delta x - w)(h) + PU_i^j (\Delta x - w)(\Delta y - h) \right] / \Delta x \Delta y ,$$

$$x_p^{n+1} = x_p^n + \delta t u_p ,$$

and similarly for the v_p velocity and y_p coordinate.

2. Particle-Fluid Momentum Exchange. In particle-fluid momentum exchange, the particles do not

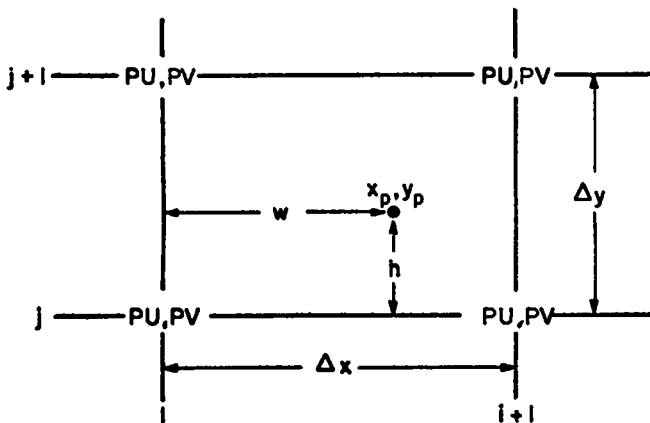

Fig. 12. Area weighting the particle p within the particle grid cell.

necessarily move with the fluid velocity. The basic particle mover is extended to include reaction with the surrounding fluid as follows.

(a) In addition to storing PU and PV for all particle-grid vertices, we store the quantities ΔM_x and ΔM_y , which are the x and y momentum changes caused by fluid forces suffered by the particles near each vertex. These quantities must therefore be subtracted from the fluid momentum on a cell-by-cell basis. In YAQUI, we felt that to within the accuracy of the particle mover itself, we could split the word storage used for particle-grid velocities, combine PU and ΔM_x at one-half word each, and similarly combine PV and ΔM_y .

(b) The calculation of ΔM_x and ΔM_y proceeds as follows. The velocity of each particle is governed by the equation of motion

$$u_p^{n+1} = \frac{u_p^n + \delta t \eta_p (u_{f1} + u_{rand}) + \delta t g_x}{1 + \delta t \eta_p} ,$$

in which u_{f1} is the u_p of the previous equation — the area-weighted value of the particle-grid velocities at the particle location, u_{rand} is the velocity contribution from turbulent fluctuations,⁴ and η_p is a drag coefficient. The x -momentum change of the particle is

$$\left(\overline{\Delta M_x} \right)_p = m_p \delta t \eta_p \left(u_{f1} - u_p^{n+1} + u_{rand} \right) ,$$

where m_p is the particle mass. This momentum change is distributed to the particle-grid vertices in much the same manner that u_{f1} was calculated. Thus, if the particle is in cell (i, j) , the corresponding changes at the vertices are given by

$$\left(\overline{\Delta M_x} \right)_{i+1}^j = \left(\overline{\Delta M_x} \right)_{i+1}^j + \frac{w(\Delta y - h)}{\Delta x \Delta y} \left(\overline{\Delta M_x} \right)_p ,$$

$$\left(\overline{\Delta M_x} \right)_{i+1}^{j+1} = \left(\overline{\Delta M_x} \right)_{i+1}^{j+1} + \frac{wh}{\Delta x \Delta y} \left(\overline{\Delta M_x} \right)_p ,$$

$$\left(\overline{\Delta M_x} \right)_i^{j+1} = \left(\overline{\Delta M_x} \right)_i^{j+1} + \frac{(\Delta x - w)h}{\Delta x \Delta y} \left(\overline{\Delta M_x} \right)_p ,$$

$$\left(\overline{\Delta M_x} \right)_i^j = \left(\overline{\Delta M_x} \right)_i^j + \frac{(\Delta x - w)(\Delta y - h)}{\Delta x \Delta y} \left(\overline{\Delta M_x} \right)_p .$$

A similar distribution is performed for ΔM_y , where

$$\left(\overline{\Delta M}_y\right)_p = m_p \delta t \eta_p \left(v_{fl} - {}^{n+1}v_p + v_{rand} \right) .$$

Because ΔM_x and ΔM_y are calculated through a summation, their values must be initialized at zero each cycle.

Note that whereas the basic particle mover required that the particle coordinates (x_p, y_p) be stored from cycle to cycle, the momentum exchange requires in addition $u_p, v_p, m_p,$ and η_p . In YAQUI, particle-storage words are split like particle-grid storage. Thus, the six quantities per particle are kept in three words, where x_p is combined with u_p , y_p is combined with v_p , and η_p is combined with m_p .

(c) After all particles have been moved and their momentum changes recorded at the particle-grid vertices, these momentum changes must be inserted into the fluid momentum field. This is done by sweeping the YAQUI vertices in the same manner as that used to set up the particle-grid velocities: Determine in which particle-grid cell (i,j) each Lagrangian vertex, is located. Because the mass, M_o , associated with each particle-grid vertex is still in storage, the change in velocity components of the Lagrangian vertices can be calculated easily. The adjusted velocity component, u , of Fig. 11 is given by

$$u = u - \left[\left(\frac{\Delta M_x}{M_o} \right)_{i+1}^j (w) (\Delta y - h) + \left(\frac{\Delta M_x}{M_o} \right)_{i+1}^{j+1} (w) (h) + \left(\frac{\Delta M_x}{M_o} \right)_i^{j+1} (\Delta x - w) (h) + \left(\frac{\Delta M_x}{M_o} \right)_i^j (\Delta x - w) (\Delta y - h) \right] / \Delta x \Delta y ,$$

and v is given similarly, with ΔM_x replaced by ΔM_y . These expressions conserve momentum.

The YAQUI particle mover has been written with the momentum-exchange feature built in. To calculate with true marker particles only, however, we merely set all $m_p = 0$, $\eta_p \rightarrow \infty$, and $u_{rand} = v_{rand} = 0$, and bypass all ΔM_x and ΔM_y calculations.

Two-fluid dynamics can be performed without using particles in a purely Lagrangian manner when

the fluid distortions are not severe,² whereas for incompressible flows involving large distortions, two-fluid dynamics can be calculated by tying the particle motions strongly to the fluid in which the particles are embedded. The particle masses are chosen so as to supplement the density already contributed by the background fluid, the sum of that density and the particle density being the total density of the second fluid. (More generally, the presence of a spatially varying density in the second fluid can likewise be represented by appropriate choice of particle masses.) The masses can be negative or positive.

In the absence of a free surface, the effects of gravity are most efficiently represented by separating the pressure of the background fluid into two parts, the uniform gradient in equilibrium with gravity and the departure from this. As a result, only the departure pressure is obtained by iteration, its boundary condition being zero gradient on the top and bottom walls. The gravitational acceleration on the particles (i.e., on the difference between the densities of the fluids) then remains as the only exterior force field. To allow for this, one must accordingly supply a separate specification for the gravitational acceleration on the particles, designated by g_{zp} .

Particle storage in YAQUI is maintained in the LCM block named YLC2, which contains a single array, AA2, dimensioned at 131000₁₀ words. Because the particle data are stored using three words per particle, a maximum of 43,666 particles may be used in the version of the code presented here.

F. The Automatic Calculation of the Time Step and the Viscosity Coefficients

The automatic calculation of the time step, δt , is included as an option in YAQUI, primarily on the basis of two stability conditions, one of which is imposed by the viscous stresses, with coefficients λ and μ , and the other of which is associated with the convective fluxes for Eulerian calculations, or with the prevention of negative volumes for Lagrangian calculations.

The viscous-stress stability conditions are tested in the Phase-1 calculations in conjunction with the calculation of the viscosity coefficients for the stress-tensor terms. As described below, the code creates effective values of λ and μ on a

cell-by-cell basis, as determined by a combination of input quantities and local flow conditions. From these considerations, it then calculates a tentative δt , labeled δt_v , for use in the next cycle of calculation.

The convective-flux limitation can be imposed during the rezoning of M and E in Phase 3. From an examination of the flux coefficients FR, FT, FL, and FB, calculated for each cell as defined in Sec. I F, along with the divergence, D, and α_0 , the code obtains another competing tentative δt , labeled δt_c .

The δt actually chosen for the next calculational cycle, then, is the smaller of δt_v and δt_c , $\delta t = \min(\delta t_v, \delta t_c)$. Subsequently, the initial values of δt_v and δt_c that go into the next cycle's tests differ by some factor, δt_{fac} , which is usually slightly larger than unity, times the new δt just chosen. This permits the δt to increase when conditions become more stable. Because the δt is always chosen for the next cycle of calculation, it can be argued that it is always a cycle behind. Ideally, the δt chosen should be for use in the present cycle, as it is based upon present conditions, but this would be more difficult to accomplish. The one-cycle lag, however, presents no problems, as the δt is always small enough that significant changes in the flow field occur only over a number of cycles of calculation. Accuracy considerations alone demand this, in addition to the requirements of numerical stability.

There is a great deal of latitude in how the viscosity coefficients may be determined for Phase 1. Governing the use of the input values of λ and μ is the input quantity ξ , an integer exponent used in conjunction with ρ_1^j . Three possible forms of viscosity are allowed, depending upon the definition of ξ :

- (1) $\xi = 1$ will allow a read-in value of artificial kinematic viscosity. The input values of λ and μ must be chosen with regard to the numerical stability requirements for expected flow conditions.²
- (2) $\xi = 0$ is used when the input values of λ and μ represent the real, physical coefficients of viscosity.
- (3) $\xi = -1$ forces the code to seek its own viscosity on the basis of local numerical-stability conditions in the flow. Note that the actual numerical

values of the input λ and μ are immaterial when $\xi = -1$. Only the ratio λ/μ will be considered for dividing the total viscosity between λ and μ .

The effective λ and μ used in the viscous terms of the equations are, in all three cases, given by

$$(\lambda_{eff})_i^j = k\lambda_{input}$$

and

$$(\mu_{eff})_i^j = k\mu_{input}$$

where

$$k = (\rho_1^j)^\xi$$

when $\xi = 1$ or 0. When $\xi = -1$, k is determined directly from the numerical-stability requirement

$$\frac{\lambda + 2\mu}{\rho} > \frac{1}{2} u^2 \delta t + \frac{1}{2} u' \delta x^2$$

We define

$$k = \frac{\rho(1 + \epsilon)}{\lambda + 2\mu} \left(\frac{1}{2} u_1^2 \delta t + \frac{(u\delta x)_{max}}{n} \right)$$

where ϵ is a coefficient, u_1^2 is the square of a representative velocity at vertex $(j)_i$ of the cell,

$$u_1^2 = (u^2 + v^2)_i^j$$

and $u'\delta x^2$ is approximated by the maximum $u\delta x$ of the cell times a factor $(1/n)$,

$$u'\delta x^2 = \frac{(u\delta x)_{max}}{n} = \frac{1}{n} \max(|u_1^j \Delta r|, |v_1^j \Delta z|)$$

in which Δr and Δz have the usual definitions of average δr and δz :

$$\Delta r = \frac{1}{2} (x_2 - x_4 + x_1 - x_3)$$

$$\Delta z = \frac{1}{2} (y_2 - y_4 + y_3 - y_1)$$

Use of ξ has removed the restriction for infinitesimal δt 's that would otherwise be required in very low-density regions, as when $\xi = 1$ or -1 , $\lambda = \rho$ times some quantity, and $\mu = \rho$ times some quantity,

so that the condition we must satisfy for stability,

$$\frac{(\lambda + 2\mu) \delta t}{\rho_{\min}} < \frac{1}{2} \left(\frac{\delta r^2 \delta z^2}{\delta r^2 + \delta z^2} \right),$$

becomes

$$\text{some quantity times } \delta t < \frac{1}{2} \left(\frac{\delta r^2 \delta z^2}{\delta r^2 + \delta z^2} \right),$$

and the dependence upon ρ_{\min} has been entirely removed. Moreover, for $\xi = 1$, λ has been converted to a kinematic form more convenient for artificial viscosity in problems involving large density variations.

The λD term appearing in the Π_{xx} , Π_{yy} , and Π_{θ} equations is calculated as

$$(\lambda D)_i^j = \min(D_i^j, 0) (\lambda_{\text{eff}})_i^j,$$

as D is applied only in compressive regions, that is, when it is negative.

With the viscous effects included through the stress tensors, the crucial equation for determining δt_v is the stability condition

$$\delta t < \left[\frac{2(\lambda + 2\mu)}{\rho} \left(\frac{1}{\Delta r^2} + \frac{1}{\Delta z^2} \right) \right]^{-1},$$

which roughly states that momentum must diffuse less than one cell width per time step. Because $(\lambda + 2\mu) = \frac{4}{3}\mu + \zeta$, the right side of the above expression is always positive. Further, the alternate node coupler in Phase 1 introduces another stability condition, which can be shown to always be

$$\text{ANC} \left(\equiv \frac{1}{a_{\text{nc}}} \right) < 1.$$

Combining these two conditions, we obtain

$$\text{Quantity}_i^j = \frac{\rho_i^j (1 - \text{ANC}) \Delta r^2 \Delta z^2}{2 \left[(\lambda_{\text{eff}}) + 2(\mu_{\text{eff}}) \right]_i^j (\Delta r^2 + \Delta z^2)},$$

from which δt_v may be reset as

$$\delta t_v = \min(\delta t_v, \text{Quantity}_i^j),$$

thus allowing every cell a chance to participate in the selection.

As mentioned earlier, several criteria in Phase 3 influence the choice of δt_c . One requirement is that material cannot be fluxed more than one cell width per time step, as the flux approximations are based on the implicit assumption that exchanges occur only between adjacent cells. Therefore, δt_c must be based in part upon the quantity

$$\left[\max(|FR|, |FT|, |FL|, |FB|) / \text{Volume} \right]_i^j,$$

if the flow has any Eulerian features. In Lagrangian cases, $D\delta t$ can provide the same measure that flux/volume does for Eulerian cases, as both expressions have the appropriate $\frac{\delta u}{\delta x} \delta t$ dimensions.

Besides monitoring these two quantities, δt_c must take into account the differencing scheme itself. It can be shown that for stability we must require

$$\frac{U\delta t}{\delta x} < \frac{2\alpha_o}{1 + \alpha_o^2},$$

in which $U = u_{\text{fluid}} - u_{\text{grid}}$, and α_o is a measure of the donor-cell proportion in the mass equation, as described in Sec. I F. (The right side of the above condition has its maximum when $\alpha_o = 1$.) For accuracy, we restrict the limit to only a quarter of this amount:

$$\frac{\alpha_o}{2(1 + \alpha_o^2)}.$$

Combining these three conditions, then, yields the crucial quantity for determining δt_c :

$$\text{Quantity}_i^j = \frac{\delta t \left[\frac{\alpha_o}{2(1 + \alpha_o^2)} \right]}{\left(\frac{|\text{flux}|_{\text{max}}}{\text{Volume}} \right)_i^j + \delta t |D|_i^j},$$

according to which we reset δt_c , if necessary, by

$$\delta t_c = \min(\delta t_c, \text{Quantity}_i^j),$$

on a cell-to-cell basis, as we did to calculate δt_v . (For computational purposes, the denominators of both the above and the previous "Quantity_i^j" expressions should contain an added constant (on

the order of 10^{-10}) to ensure that they do not vanish.)

III. USING THE YAQUI PROGRAM

A. Mesh Generation

The generation of the initial mesh and fluid configuration in YAQUI is the responsibility of the (1,0) subroutine, MESHMKR. This subroutine must provide the starting x , y , r , u , and v values for all vertices, and ρ and I values for all zones. Data punched on input cards, described fully in Sec. C below, provide MESHMKR the information necessary to perform this task for a variety of circumstances.

The first consideration is to define the coordinates for all vertices. The input quantities \bar{I} , \bar{J} , δr , and δz (= IBAR, JBAR, DR, and DZ in the program) are the four fundamental quantities in grid generation. They permit creation of a grid of uniform δr by δz zones whose origin, vertex (1,2), lies at coordinates (0,0, 0.0). The addition of a fifth quantity y_B (= YB), the y coordinate of vertex (1,2), allows the entire mesh to be displaced upward. This is useful for calculations involving expanding meshes. The initial, basic part of MESHMKR generates exactly this uniform grid.

The version of MESHMKR presented here further allows the option of nonuniform zoning. As depicted in Fig. 13, the previously generated grid lines may be shifted vertically and horizontally, with zone size increasing continuously outside of some remaining inner area of uniform zones. The region of uniform zones occupies I_{uniform} (= IUNF) by J_{uniform} (= JUNF) zones, centered at J_{center} (= JCEN) zones up from the $j = 2$ bottom boundary line. IUNF and JUNF may range from values of 1 and 2, respectively, implying variable zones throughout, up to values of IBAR and JBAR, implying uniform zones throughout. The input coefficient FREZ provides the expansion ratio for the zones lying outside the IUNF by JUNF region. A relationship of the form $x_i = x_{i-1} + \text{FREZ} (x_{i-1} - x_{i-2})$ is used to locate grid lines lying to the right of IUNF, above $\text{JCEN} + \frac{\text{JUNF}}{2}$, and below $\text{JCEN} - \frac{\text{JUNF}}{2}$. For accuracy, FREZ generally should not exceed about 1.1. The above expression will retain uniform zoning throughout if FREZ = 1.0. A simple program modification would allow for different expansion rates in the two directions.

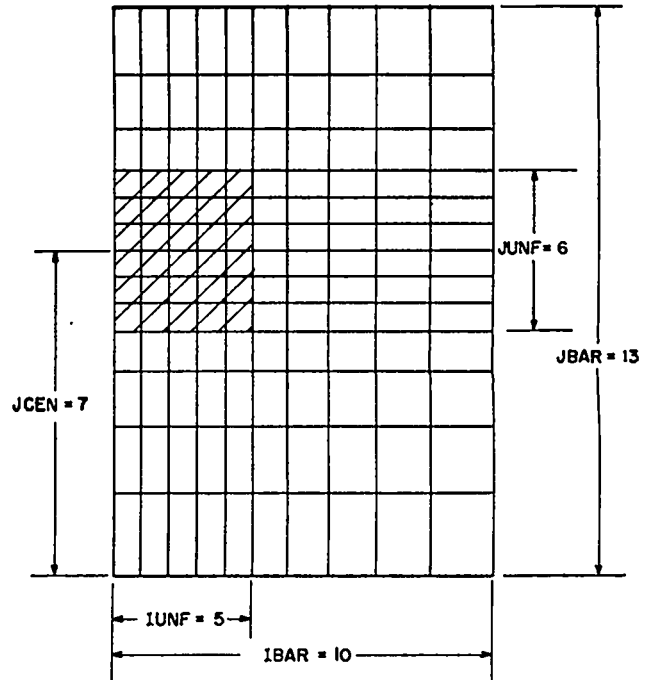

Fig. 13. An initial YAQUI grid with variable zoning. The region of uniform δr and δz zones (IUNF zones by JUNF zones, centered at JCEN zones up from the bottom) is denoted by shading.

If variable zoning is employed (FREZ > 1.0), user calculation of YB would be inconvenient, so, instead, the input quantity REZYO, which is the y coordinate of the center of expansion, y_0 , determines the vertical placement of the mesh. REZYO refers to the YAQUI vertex (1, JCEN + 2), and allows YAQUI to calculate the actual value of YB.

Although the variable zoning shown in Fig. 13 for this version of MESHMKR is of a simple rectangular form, we emphasize that neither the technique nor the code is by any means limited to this. MESHMKR may be modified easily to create any curvilinear grid, and, indeed, simple iterative techniques⁵ have been used in MESHMKR to define a variety of more complex grid shapes for special applications.

With the basic grid (x , y , and r values) defined, the second consideration is the initial u , v , ρ , and I values to define the fluid. Input data cards are read which define regions containing integral numbers of zones, and specify the initial

values of the four variables assigned to all zones lying within each region. Use of these data cards is fully described in Sec. C below.

This version of MESHMKR includes the special capability of setting up atmospheric-explosion calculations. In this case, it creates an entire background of ambient atmosphere through use of one of the fluid-region data cards. In addition, ρ and E values are initialized in the external or fictitious zones, as the grid will later be expanded in the REZONE. MESHMKR then adjusts the uniform ρ field of this ambient atmosphere to a state of gravitational equilibrium by use of an algorithm that accounts for nonuniform zoning.

When combining variable zoning with an equilibrium atmosphere, the user must consider zone height in relation to scale height. It is computationally inaccurate to allow a zone height to exceed one scale height, and for zones larger than this, a change in sign can be introduced into the ρ field. Therefore, it is wise to ensure that the condition

$$\delta z < \frac{(\gamma - 1)I_{amb}}{|g_z|}$$

is satisfied throughout the mesh. In the above expression, I_{amb} is the ambient specific internal energy. As coded in this report, I_{amb} (given by REZSIE) is a constant, but when atmospheric conditions allow it to increase with increasing altitude, larger zones may be employed in the region of increased I_{amb} . However, the above condition must still be satisfied.

Upon the ambient background, the spherical burst may be defined in any manner that the user wishes. We usually employ a special set of data cards to define the upper right quadrant of the burst. These cards are provided by a one-dimensional spherical code whose purpose is to calculate the early-time dynamics. The cards are arranged in relation to a set of uniform Eulerian zones, each data card in the set specifying a pair of relative i and j cell indices and the associated ρ , I , v , and u values. With a j index specified in YAQUI to correspond to the center of the burst, MESHMKR creates only the upper right and the mirror-image lower right quadrants, taking advantage of the cylindrical symmetry of the burst. The data are

superimposed over the previously defined ambient atmosphere, overwriting a part of it that is restricted to lie within the IUNF by JUNF area, whose uniform zones are identical in size to those of the one-dimensional code. (This restriction would be unnecessary if one were to interpolate the input data separately.) The velocity components specified on the data cards are located at cell edges, creating a minor complication, as YAQUI velocities must be centered at the vertices. As a result, MESHMKR must store these velocity values in temporary locations as they are read in. After the entire set of data cards has been processed, MESHMKR can transform the field through appropriate averaging to form a vertex-centered velocity field.

Whatever logic the user chooses to employ in grid generation, MESHMKR's work is finished when all initial x , y , r , u , v , ρ , and I values have been defined and appropriately stored. This information enables YASET1 to calculate the initial values of the remaining basic cell and vertex quantities (M_c , V , E , and M_v) in a straightforward manner.

B. Rezoning

Rezoning, which is grid motion relative to fluid motion, occurs in any flow that is not purely Lagrangian. Indeed, purely Eulerian flow is a rezone flow, and is unique only in that the grid motion is such as to maintain the grid in a fixed location. When rezoning occurs, there is a convective flux of mass, momentum, and energy from one zone to its neighbors, which must be properly accounted for. For fluxing accuracy, the grid velocities or the time step must be restricted so that fluid is fluxed less than one cell per cycle, as it is assumed in the equations that exchanges take place only between neighboring zones.

These considerations are dealt with in Phase 3, in which grid velocities, u_G and v_G , and from them the resulting new x , y , and r coordinates, are determined. For the extremes of purely Lagrangian and purely Eulerian flows, these grid velocities may be specified quite simply. In the Lagrangian limit, the grid velocities are identical to the Lagrangian velocities resulting from Phase 2, $u_G = u_L$ and $v_G = v_L$. In the Eulerian limit, the grid velocities are identically zero. In YAQUI, these two cases are treated in Phase 3 in YAQUI2 itself. The (2,0) subroutine REZONE is called to

define the grid velocities and the resulting coordinates for any flow that is neither of these two extremes. This "roll your own" subroutine allows the user to force the grid to follow one or more features of the flow continuously.

The sample REZONE included here shows just one of a variety of possible schemes for following the dynamics of an atmospheric-explosion calculation. It is a good example because it shows the three basic objectives that must be met by a rezone for such a calculation.

- (1) The mesh must be expanded so as to maintain the boundaries ahead of the strong radially expanding shock,
- (2) The mesh must rise in the atmosphere at the rate of fireball rise, and
- (3) The zoning must resolve the details of the torus in the central region finely, but may be much coarser in the outlying regions, for computer efficiency.

(The variable zoning discussed in Sec. III A and shown in Fig. 13 can provide a good beginning for this last aspect.) The following briefly explains how REZONE meets these three objectives in this version.

- (1) The mesh expansion is controlled by monitoring the largest absolute u_L or v_L fluid velocity (u_{\max}) along a column or (v_{\max}) along a row, several cells in from each rigid boundary, thereby allowing signals to be sensed before they can reach the boundaries. The normal grid velocity assigned to the boundary vertices is then calculated to be the square root of the product of this maximum velocity times the largest absolute u_L or v_L velocity (v_{\max}) in the entire grid:

$$(u_G)_{i=1} = 0 \text{ for all } j,$$

$$(u_G)_{i=IP1} = \left[v_{\max} (u_{\max})_{i=\bar{I}-6} \right]^{1/2} \text{ for all } j,$$

$$(v_G)_{j=2} = \left[v_{\max} (v_{\max})_{j=9} \right]^{1/2} \text{ for all } i,$$

$$(v_G)_{j=JP2} = \left[v_{\max} (v_{\max})_{j=\bar{J}-14} \right]^{1/2} \text{ for all } i.$$

- (2) The overall upward rise or translational velocity (v_T) of the mesh can be determined by tracking the rising maximum point of some representative feature of the flow. We have found that the

vorticity will serve this purpose if care is taken. Although the rising fireball torus will soon develop a strong vorticity field, the vorticity profile flattens with time, developing a vertically elongated plateau of the larger values. Upon this plateau, the maximum point itself may move around significantly from cycle to cycle. If the grid translation is tied to such a shifting point, the result is discontinuous up and down translation, perhaps moving the grid several zone heights all at once. A smoother and more reliable quantity to follow than the pure vorticity would be some weighted average vorticity. One possible form that we have used successfully is based upon the quantity

$$y_c = \sum_k y_k \omega_k / \sum_k \omega_k, \text{ which is summed over all cells}$$

except those near the rigid boundaries. Then v_T is calculated as

$$v_T = \text{maximum of } \left[0, \frac{\Omega_G}{\delta t} \frac{(y_c - y_{cen})}{2} \right],$$

where y_{cen} is the y coordinate about which the fireball should be kept centered, and Ω_G is an under-relaxation factor used to ensure smooth rezoning.

- (3) The technique for rezoning the interior grid lines also makes use of the center of maximum vorticity, requiring the radial center,

$$x_c = \sum_k x_k \omega_k / \sum_k \omega_k, \text{ as well as the vertical } y_c,$$

to move. The interior vertices are then made to satisfy the relations

$$\bar{x}_i = \frac{1}{2} (x_{i+1}^n + x_{i-1}^n) + \beta_G (x_c - x_i^n) \text{ for all } j,$$

and

$$\bar{y}_j = \frac{1}{2} (y_{j+1}^n + y_{j-1}^n) + \beta_G (y_c - y_j^n) \text{ for all } i,$$

where the coefficient β_G determines how tightly the vertices are drawn in towards the center of vorticity (x_c, y_c), and therefore governs the level of resolution in the fireball torus.

In terms of grid velocities, these results are obtained by setting

$$(u_G)_i = \frac{\Omega_G}{\delta t} (\bar{x}_i - x_i^n) \text{ for all } j,$$

and

$$(v_G)_j = \frac{\Omega_G}{\delta t} (\bar{y}_j - n_{y_j}) + v_T \text{ for all } i.$$

The minimum zone size is related not only to the value of β_G , but also to the value of \bar{I} . For a given \bar{I} , it is helpful to be able to estimate a priori an appropriate value for β_G to achieve some desired level of resolution. The relationship can be shown to be

$$\delta r_{\min} \approx \frac{2\beta_F x_R}{(1 + \beta_G + \beta_F)^{\bar{I}-1} - (1 + \beta_G - \beta_F)^{\bar{I}-1}}$$

where δr_{\min} is the minimum δr after relaxation of the grid, x_R is the x coordinate of the right boundary after all grid expansion has taken place, and $\beta_F = (2\beta_G + \beta_G^2)^{1/2}$. The procedure is to obtain solutions for various values of β_G , but the final β_G chosen as optimum for a given problem will probably differ slightly from the value suggested by the relationship, and it is generally obtained empirically.

The rest of the REZONE subroutine, from statement No. 1200 to the end, is somewhat more general than the preceding part. New values of x, y, and r are calculated for all vertices, using the values of u_G and v_G , in expressions identical to those in Phase 3 of YAQUI2. This is done in REZONE, however, to enable the following adjustments to be made before RETURNing.

- (1) The particle grid parameters are adjusted to fit the new grid.
- (2) Subroutine FILMCØ is called to adjust all the film-plot scaling parameters, and finally,
- (3) The ρ_L values in the exterior zones are recalculated using the new coordinates.

C. The Input Data

Formatted input data cards provide the information necessary to specify a problem setup. The number of cards required varies according to the problem. However, the following cards must always appear.

Card No. 1: IBAR, JBAR, IUNF, JUNF, JCEN, DR, DZ, CYL, GRDVEL, AO, AOM, BO, KXI (Format 5I4, 7F8.3, I4), where:

IBAR = \bar{I} , the number of real zones in the r or x direction.

JBAR = \bar{J} , the number of real zones in the z or y direction.

IUNF, JUNF, JCEN, and FREZ (see Card No. 4 below) allow one form of variable orthogonal zoning in the initial grid generation. Refer to Sec. III A and to Fig. 13.

DR = δr , the cell size in the r or x direction in the uniform region.

DZ = δz , the cell size in the z or y direction in the uniform region.

(Note: The user may wish to completely override the specifications of IUNF, JUNF, JCEN, DR, and DZ in MESHMKR.)

CYL = 1.0 for cylindrical geometry, or = 0.0 for plane geometry.

GRDVEL = "grid velocity," 0.0 = pure Eulerian, 1.0 = pure Lagrangian, 2.0 = REZØNE.

AO = α_0 coefficient in the Phase-3 momentum equations.

AOM = α_0 coefficient in the Phase-3 mass and energy equations.

BO = β_0 coefficient in the Phase-3 mass, energy, and momentum equations.

KXI = ξ , the exponent of ρ that determines the form of viscosity in the problem. Refer to Sec. II F.

Card No. 2: NAME (Format 10A8), where columns 2-80 of this card are used for problem identification on prints and plots. Column 1 should not be used because it is treated as a carriage control. If desired, the card may be entirely blank, but it must always be included.

Card No. 3: MU, LAM, ØM, EPS, GR, GZ, ASQ, RØN, GM1 (Format 9F8.3), where:

MU = u_{input} } Viscosity coefficients. Refer to Secs. I D and II F.

LAM = λ_{input} }

ØM = ω , the Phase-2 iteration relaxation parameter. The value $\omega > 1$ provides overrelaxation, whereas $\omega > 2$ is unstable. Refer to Sec. I E.

EPS = ϵ , the Phase-2 iteration convergence criterion, typically on the order of 10^{-5} (specifying convergence to within 10^{-5} of the maximum pressure in the system at a given instant), but ϵ may be greater or smaller depending

upon the problem. Refer to Sec. I E.

- GR = g_x , gravity felt by the fluid in the r or x direction, which may be + or - to pull rightward or leftward, respectively.
- GZ = g_z , gravity felt by the fluid in the z or y direction, which may be + or - to pull upward or downward, respectively.

The quantities ASQ, RØN, and GMI are applicable to the stiffened gas equation of state, which appears in the code version of this report.

- ASQ = a^2 , the zero-temperature sound speed.
- RØN = ρ_0 , normal material density,
- GMI = $(\gamma-1)$, where γ is a constant characteristic of the gas, becoming the ratio of specific heat at constant pressure to the specific heat at constant volume, $\gamma = c_p/c_v$, if the gas is truly polytropic.

Card No. 4: FREZ, YB, REZY0, REZUE, REZVE, REZVT, REZRØN, REZSIE (Format 8F8.3), where: FREZ, YB, and REZY0 are parameters relating to the zoning and grid location in the initial grid generation. Refer to Sec. III A.

REZUE } Available for use in REZONE to specify
 REZVE } grid expansion (u_e, v_e) and translation
 REZVT } (v_T) velocities, if these velocities
 are constant.

REZRØN = the ρ_0 of the ambient atmosphere at altitude REZY0 at $t = t_0$.

REZSIE = the specific internal energy of the ambient atmosphere. In the code listing in this report, REZSIE is a value that remains constant in space and time.

Card No. 5: IBP, JBP, PDR, PDZ, PYB, GZP, IMØMX (Format 2I4, 4F8.3, I4). This card supplies the parameters for the optional particles described in Sec. II E.

- IBP = \bar{I} particles } If no particles are to be
 used, set IBP = 0. Then
 the rest of Card No. 5 is
 JBP = \bar{J} particles } unused, so proceed to
 Card No. 6. For particle

usage, IBP and JBP are the \bar{I} and \bar{J} of the particle overlay grid. $IBP < 1BAR$, and $JBP < JBAR$.

- PDR = Δx } the (uniform) Δx and Δy of the
 particle-grid cells. See Fig. 11.
 PDZ = Δy } In variable-zoned meshes, these
 values are calculated automatically
 in the setup. Similarly, PDR and
 PDZ are recalculated by REZØNE. In
 both places, the code version pre-
 sented here "stretches" the parti-
 cle grid to just cover the farthest
 points on the bottom, top, and
 right edges of the YAQUI grid.
- PYB = YB particles, the displacement of the
 particle-grid lower edge measured rel-
 ative to YB. To superimpose exactly,
 set PYB = 0.0 and allow the code to
 adjust the particle grid automatically,
 as described above.

- GZP = g_z felt by the particles, which may or
 may not be equal to GZ (see Card No. 3).
- IMØMX = 1.0 for the momentum-exchange option,
 = 0.0 otherwise.

Card No. 6: T, DT, T20MD, TLIMD, TWFIN, LPR, ICØLØR (Format 5F8.3, 2I4), where:

- T = t_0 , the problem starting time, usually
 zero.
- DT = δt_0 , the initial δt . The first cycle
 is automatically run with $\delta t = \delta t_0/10$,
 then the second and third cycles are
 run with $\delta t = \delta t_0$. From cycle 4 on,
 the δt is chosen automatically as de-
 scribed in Sec. II F.
- T20MD = 1.0 to force tape dumps every 20 min
 of central processor (CP) time for
 restarting purposes, or = 0.0 to by-
 pass this option.
- TLIMD = 1.0 to force a tape dump and RETURN to
 the (0,0) overlay just before reaching
 the CP time limit specified on the JØB
 card; > 1.0 to force tape dump and RE-
 TURN immediately after cycle 0 output;
 = 0.0 to run out to a full time limit
 with no tape dump.
- TWFIN = problem finish time. When this is
 reached ($t \geq TWFIN$), control will RE-
 TURN to the (0,0) overlay.

(Upon RETURN to (0,0) for either the TLMD or TWFIN condition, the (0,0) main program YAQUI searches the input queue for further tasks.)

LPR = Printing Control, where:
 0 = movie option, 1 = zone prints on microfilm only, 2 = zone prints on both film and printer, 3 = zone prints on printer only. These are described more fully in Sec. III D.

ICOLOR > 0 plots particles in red, and anything else on film in white, obviously effective only with color processing. ICOLOR < 0 implies normal black-and-white processing.

Card No. 7: (DT(N), N=1,10) is used in conjunction with

Card No. 8: (DT(N), N=1,10) (both are Format 10F8.3), where DT_n specifies the problem-time output interval for both plots and prints. DT_n specifies the time at which to change to DT_{n+1}. As an example, assume that t is in seconds, and that output is wanted every 1/4 sec for the first second, then every 1/2 sec up to 4 sec of problem time, then every 1 sec until t = 10, then every 2 sec until t = 50, and every 10 sec until t = 200. One would use DT (1-10) = 0.25, 0.5, 1.0, 2.0, 10.0, DT (1-10) = 1.0, 4.0, 10.0, 50.0, 200.0.

To keep the output time interval fixed throughout a run, specify DT (1) = (interval) and DT (1) > TWFIN.

(Note: When an output time is being approached, the automatic δt routine will choose a special δt for one cycle so that the output occurs at the precise time desired.)

The above eight cards pertain to all YAQUI setups. They have defined a basic grid and provided the parameters for its use. What remains to be defined is the contents of this grid -- particle regions and fluid regions. Because these regions vary with the problem geometry, the number of cards

in the rest of the input deck varies widely. The procedure beyond Card No. 8 is to define the particle regions first, if any exist, then finally to define fluid regions.

Card No. 9: DRPAR, DZPAR, XC, YC, XD, YD, UPAR, VPAR, MTE, DRAG (Format 10F8.3).

This is a particle-region card, to be expected only if IBP > 0 on Card No.

5. One card of the above format must be provided for each discrete particle region in the mesh. In the present version of PARTGEN, a particle region may be one of two shapes -- cylindrical or spherical (rectangular or circular in plane geometry). These two general shapes are shown in Fig. 14 with the named dimensions that specify them. The four dimensions (XC, YC, XD, and YD) are input in true distance units because the particle regions are not constrained to follow zone edges. For a cylinder, XC and YC specify the coordinates of the lower left corner, and XD and YD specify those of the upper right corner. For a sphere, YD must always be identically zero to enable PARTGEN to distinguish it from a cylinder. YC specifies the position of the center, measured up the axis, and XD specifies the sphere radius. Note that the y dimensions are defined relative to y = 0, not relative to the bottom of the mesh. (This was allowed so that particles might originally be placed outside an expanding mesh, but the user should not try to move any particle while it is still outside the mesh, as the present logic in PARTMOV assumes that all particles lie within the mesh.)

DRPAR	}	Particle spacing in the r or x and z
DZPAR		or y directions, in problem units.
XC	}	Particle-region dimensions in problem units, relative to x = 0 and y = 0.
YC		
XD		
YD		
		See Fig. 14.

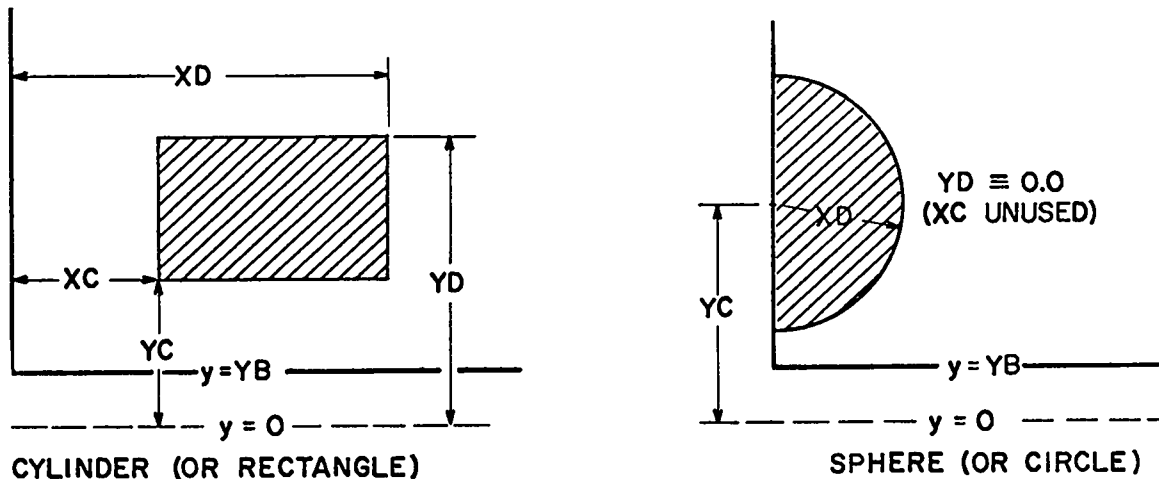

Fig. 14. Particle-region shapes available in PARTGEN. Note that the named dimensions are measured from $x = 0$ and $y = 0$.

- UPAR } Initial u and v velocity components for
- VPAR } the particles in this region; will be
- 0.0 for true marker particles.
- MTE Mass per particle = $MTE \cdot r_{\text{particle}}$. Use
- MTE = 0.0 for markers.
- DRAG Drag coefficient, η , for these parti-
- cles. Use DRAG = 10^{10} for markers.

Particle-region cards are processed individually, and the number of particle regions is unlimited. If particles are used at all, the set of particle-region cards terminates with the final card having $DRPAR \leq 0.0$ and the rest of the card is unused. Therefore, the number of particle-region cards in a YAQUI deck is either zero, or two or more.

Card No. 9: if no particles are used. If particles are used, however, then this card follows the $DRPAR = 0.0$ card: NB, NR, NT, NL, UI, VI, R01, SIEI (Format 4I4, 4F8.3). This is a fluid-region card, one card of this format being provided for each discrete fluid region in the mesh. The allowed fluid region covers some specified number of zones, as shown in Fig. 15 with the named dimensions that define it. The four dimensions (NB, NR, NT, NL) are given in integer numbers of cells to emphasize that the four corners of the region must coincide with cell vertices. Thus, NL and NB specify how many cells in from the left and up to the vertex

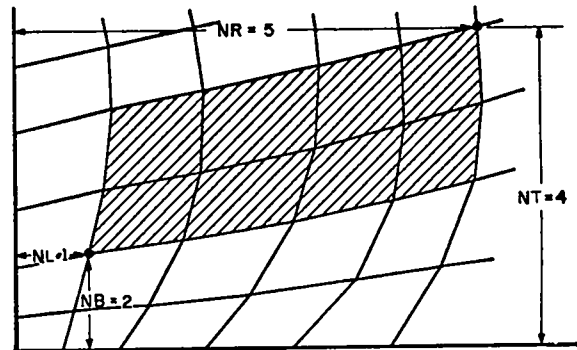

Fig. 15. The basic fluid region available in MESHMKR, defined by the number of zones over and up to two corners.

where the lower left corner of the region is located, and NR and NT similarly locate the vertex of the upper right corner. Even if the grid is not originally orthogonal, specifying two diagonal corners uniquely specifies the zones that will be included in the region. To use a single fluid region as an entire ambient background, set $NL = NB = 0$, $NR = \bar{I}$, and $NT = \bar{J}$.

- NB } numbers of zones (integers only). Refer
- NR } to Fig. 15.
- NT }
- NL }
- UI = u_I } the initial velocity components to
- VI = v_I } be assigned to all vertices in the
- fluid region.

$R\emptyset I = \rho_I$ } the initial density and specific
 $SIEI = SIE_I$ } internal energy to be assigned
 to all zones in the fluid region.

Fluid-region cards, like particle-region cards, are processed individually, and the number of fluid regions is also unlimited. The version of MESHMKR presented in the code listing in this report expects that at least one fluid region will be defined by this type of card. The set of fluid-region cards terminates with the final card having NR = 0 and the rest of the card unused. Therefore, a minimum of two fluid-region cards must be present in a YAQUI deck.

To set up an atmospheric-explosion calculation, as described in Sec. III A, the final NR card (following the ambient fluid NR card) has NR = 1000, instead of NR = 0, with NT = the j index of the burst point in the full YAQUI grid. Generally, NT = JCEN+2, where JCEN was defined on Card No. 1. The set of special data cards follows the NR = 1000 card, and contains I, JJ, R \emptyset I, SIEI, VI, and UI (format 2I5, 4(4X,E11.5)), one card per Eulerian zone. The j index is called JJ here to emphasize that it is relative to the definition j = 1 at the burst point on the data cards. VI is the v velocity centered on the top edge of the Eulerian zone, and UI is the u velocity centered along the right edge. These cards are read and processed individually, the set terminating with a card having I = 0.

This completes the discussion of the input data cards. The final card normally placed at the end of the input deck is in reality the first card for the next problem. The first quantity on Card No. 1 is IBAR, and its value determines the action to be taken by YAQUI. If IBAR > 0, it is valid for use as \bar{I} , and YASET is called. The value IBAR = 0 indicates a tape restart, and IBAR < 0 indicates that the end of data has been reached. Thus a negative IBAR card is the appropriate way to terminate a deck, and hence, the run.

D. Output--Plots, Prints, and Motion Pictures

The YAQUI output is in the usual two forms--visual information on microfilm or motion-picture film, and printed information on microfilm or fan-fold paper. Both forms are automatically provided at cycles 0 and 1, and thereafter at intervals specified by DT \emptyset and DT \emptyset C in the input data. The microfilm plots are generally the most useful

output, and they are made on the III FR-80 or the S-C 4020 C \emptyset M (computer output microfilm) devices. Six plots are provided in the basic code version: particles, zones, velocity vectors and contours of density (isopycnics), internal energy (isotherma) and vorticity.

The particle plots are made by plotting the x_p and y_p coordinates of all particles, and are provided automatically when particles are used.

The zone plot is included for all Lagrangian or REZ \emptyset NE runs (GRDV \emptyset L \geq 1.). For purely Eulerian calculations (GRDV \emptyset L = 0.), the zone plot is provided only at cycle 0. The labels of minimum and maximum δr and δz on the zone plot are really unambiguous only for orthogonal grids. The general form used in their calculation was intended to make the labels meaningful for slightly distorted grids.

The velocity-vector plot shows the direction of fluid flow and the relative magnitude of the velocities. Vectors are plotted originating at each vertex, denoted by a "+," and have a length and direction proportional to the vertex velocity components. If (x_1, y_1) are the coordinates of vertex (i,j), the coordinates of the vector end point (x_2, y_2) are given by

$$x_2 = x_1 + (u_i^j) (DR\emptyset U) ,$$

and

$$y_2 = y_1 + (v_i^j) (DR\emptyset U) ,$$

where DR \emptyset U is a scaling coefficient defined as

$$DR\emptyset U = (0.9) (VEL_{\max}) \left(\frac{x_{i=IP1}}{\bar{I}} \right) .$$

This coefficient is recalculated whenever a velocity-vector plot is drawn, and it scales the length of a vector drawn for the largest u or v velocity in the system at that instant (VEL_{\max}) to be 9/10ths the length of the average zone $(x_{i=IP1}/\bar{I})$. This method ensures that the vectors are always of reasonable length, regardless of velocity magnitude. The plot is deleted if there are no significant velocities in the entire system.

The contour plots are drawn by a routine that creates plots for any cell-centered quantity stored in CQ, and they are composed of connected vector

segments joining points of equal quantity, just as the lines on a contour map join points of equal altitude. The plots may be either linear or logarithmic in contour increment. Logarithmic plots are more useful for atmospheric studies and are provided for the isopycnics and isotherms, whereas the vorticity plot is linear.

The printed information consists primarily of a listing of the principal field variables over the entire grid. One line is printed for each zone, giving the 12 quantities $i, j, x_1^j, y_1^j, u_1^j, v_1^j, I_1^j, \rho_1^j, v_1^j, D_1^j, M_{v_1}^j$, and p_1^j for the zone or its lower left vertex.

A two-line short print is provided every cycle, and it contains the following 13 quantities:

T is the current problem time.
 CYC is the current cycle number.
 DT is the current δt .
 GRINDS = $\delta CP / (\bar{I} * \bar{J})$, the elapsed central processor (CP) time for the cycle just finished, divided by the total number of zones. The CP time per cell per cycle is a useful indicator of the code's computing efficiency.
 CIRC, or circulation, is a measure of fluid velocities near the rigid mesh boundaries, intended primarily for atmospheric calculations. Interaction of signals with the outer boundaries often shows up as a significant change in the value of CIRC.
 ITERS is the number of iterations in the preceding Phase 2.
 CPTIME is the current CP clock time.
 DTV is the competing δt_v calculated during the previous cycle, in which
 IDTV and JDTV are the i and j indices of the zone that limits δt_v most severely.
 DTC is the competing δt_c , and, similarly,
 IDTC and JDTC are the i and j indices of the zone that limits δt_c most severely.
 For either δt_v or δt_c , if the printout indicates that the limiting zone is zone (1,2), the tentative next time step, $\delta t_v = \delta t_c = (\delta t) (\delta t_{fac})$, is small enough to satisfy the stability and accuracy requirements at every point in the mesh.

The short print is provided on fanfold paper regardless of the LPR setting, and on microfilm if LPR = 1 or LPR = 2. LPR primarily controls the destination of the full zone prints, where:

LPR = 1 gives zone prints on microfilm only,
 LPR = 2 gives zone prints on film and paper,
 LPR = 3 gives zone prints on paper only.
 If LPR = 0, no information is printed on microfilm. This case is intended for motion picture use, and the only microfilm output is a particle plot. For movies, the user should hold the δt constant, and set $DT\emptyset = \delta t$ or $2\delta t$. The code is easily altered to provide some plot other than a particle plot for the movie if desired, or to have a frame shared by several different types of plots.

E. Tape Dump and Restart

Tape dumps are staged out as Fileset 8 in the control region under influence of the quantities T2OMD and/or TLMD, as described in Sec. III C. The quantities dumped are the contents of the SCM common YSC2, the LCM block YLCL, and, if particles are used, the LCM block YLC2.

A tape restart is performed by staging in the dump tape as Fileset 7. The input deck consists of an IBAR = 0 data card, where JBAR = the dump number on the tape and is used as a check.

F. Incompressible Flow Calculations

Conceptually, the YAQUI code in this report should be able to calculate a truly incompressible flow, defined as a flow in which the sound speed is vastly greater than the fluid speed. Practically, however, the code should be slightly modified to render it suitable for handling such calculations. The equations we use are intended for flows containing compressibility effects, and they, indeed, differ from those we would choose for a fully incompressible flow technique.

In incompressible flow, variations in I can be neglected unless buoyancy effects are important, and as ρ is essentially a constant for each fluid element, the mass equation reduces to the requirement for vanishing velocity divergence. Using an equation of state is therefore unnecessary, because the changes in pressure arise as a direct consequence of the dynamics. In YAQUI, however, the equation of state is inherent: Phase 2 assumes it through the appearance of c^2 , and the equation of state is used directly to update p_L into the new p_L^{n+1} , to account for ρ changes that occurred in the Phase-3 convection. Nevertheless, the implicit treatment¹ should still enable YAQUI to handle incompressible flows. In practice, we see this to be true for Mach numbers

down to about 0.01. For lower Mach numbers, however, there are three features in YAQUI that introduce difficulties. The first difficulty occurs in the (Lagrangian) iterative phase, where we compute ρ_L from an equation that leaves δt^2 errors. The second arises in the convective flux calculation, which is treated explicitly in Phase 3. This introduces nonzero values into the velocity divergence and, consequently, allows the densities to change. The third arises in the internal energy calculation, in which the nonvanishing values of $\nabla \cdot \vec{u}$ introduce fluctuations into the internal energy field. When the overall level of internal energy is high, these fluctuations are reflected in large variations of $n^+ p$, which cannot be efficiently corrected in the subsequent pressure iteration. As a solution to the problem, we have bypassed the equation-of-state calculation after cycle 0, and instead used $n^+ p = p_L$ in incompressible flows. Yet another choice would be to iterate Phase 2 to much greater accuracy, which would not be very economical, especially in view of the vastly increased computer time requirements. We cannot run with the limit of $\epsilon = 0$ in Phase 2, but rather use a value more on the order of, say, 10^{-5} , which leaves relative errors of that order in p_L .

These considerations can be illustrated with the stiffened gas equation of state, appearing in the code version of this report. For this, n_p is given by

$$n_p = a^2 (\rho - \rho_0) + (\gamma - 1) \rho^n I$$

The incompressible limit can be described by $a^2 \rightarrow \infty$ forcing the $(\gamma - 1)\rho I$ part of the equation to be negligible, or by $I \rightarrow \infty$. Because true ∞ cannot be used on the computer, we might choose, say, $a^2 = 10^{10}$. Even this less-than-infinite a^2 is large enough to magnify any slight ρ errors into appreciable variations in the p field.

To implement the $n^+ p = p_L$ logic in YAQUI, the storage requirements must be considered. Examination of Fig. 9 reveals that p_L , in storage word 11, is not saved in Phase 3. The simplest way to preserve p_L throughout the cycle is to create a 15th word of storage and store p_L in it after Phase 2. Then, at the beginning of the next cycle, $n^+ p$ can be set from it quite easily. Note that then one must set $NQ = 15$.

The standard Phase-2 treatment is to bypass the updating of the vertices of any cell whose δp satisfies the convergence test, the argument being that the slightly improved accuracy is generally not worth the extra computer time required to obtain it. When using $n^+ p = p_L$, however, it becomes more appropriate to update the vertices of all cells, whether or not the convergence test was satisfied.

G. The COMMON Block YSC2

The following list provides the names, descriptions, and sources of all quantities in the SCM COMMON YSC2 in the (0,0) overlay. This COMMON is of fundamental importance in communication between the various overlays and their subroutines. It contains all the SCM-based information that must be maintained from cycle to cycle, and it is the SCM portion of the tape-dump data.

The sources in the list are keyed to the following symbols:

- I = Supplied as part of the standard input data. The parenthetical symbol that follows I specifies where this quantity is read.
- 0 = (0,0) Main Overlay
- L = (0,0) Subroutine LOP
- F = (0,0) Subroutine FILMCP
- S = (1,0) Subroutine YASET1
- P = (1,0) Subroutine PARTGEN
- 2 = (2,0) Subroutine YAQUI2
- R = (2,0) Subroutine REZONE

Multiple sources indicate that the quantity is recalculated.

<u>NAME</u>	<u>DESCRIPTION</u>	<u>SOURCE</u>
AA	Dummy word, always the first word in the COMMON.	--
ANC	a_{NC} , alternate node-coupler coefficient.	S
ASQ	a^2 , the zero-temperature sound speed for the stiffened gas equation of state.	I(S)
AO	α_o , determines Phase-3 momentum differencing form.	I(0)
AOFAC	$\alpha_{oM} \sqrt{2(1 + \alpha_{oM}^2)}$, used in calculating δt_c .	S
ACM	α_{oM} , the α_o used in Phase-3 M and E calculation.	I(0)
BO	β_o , determines Phase-3 differencing form, used with α_o and α_{oM} .	I(0)
CØLAMU	$(1 + \epsilon)/(\lambda + 2\mu)$, used in Phase-1 viscosity-coefficient calculation.	S
CYL	= 1. if cylindrical coordinates, = 0. if plane coordinates.	I(0)
DR	δr , the cell size in the radial direction if uniformly zoned.	I(0)
DT	δt , the time step, subject to automatic recalculation.	I(S),2
DTC	δt_c , competing δt based on Phase-3 convective flux and divergence considerations.	2
DTFAC	Initial δt_v and δt_c each cycle are given by $\delta t_v = \delta t_c = (\delta t) (\delta t_{fac})$.	2
DTGR	$\delta t * g_r$.	2
DTGZ	$\delta t * g_z$.	2
DTGZP	$\delta t * g_{zp}$.	2
DTØ	Problem time interval between outputs (plots and prints).	I(S)
DTØC	Problem time at which to change to next DTØ in the set.	I(S)
DTØ16	$\delta t/16$.	2
DTØ2	$\delta t/2$.	2
DTØ4	$\delta t/4$.	2
DTØ8	$\delta t/8$.	2
DTPØS	δt possible for the cycle, but actual δt may be reduced to adjust to output time.	2
DTV	δt_v , competing δt based on Phase-1 viscous-stress considerations.	2
DT8	$\delta t * 8$.	2
DZ	δz , the cell size in the axial direction if uniformly zoned.	I(0)
EM10	10^{-10} , epsilon added to terms to ensure that they do not vanish.	S
EPS	ϵ , convergence criterion for the Phase-2 iteration.	I(S)
FIBP	Floating-point equivalent of \bar{I}_p .	P
FIPXL	Floating-point frame coordinate for left edge of particle plot.	F
FIPXR	Floating-point frame coordinate for right edge of particle plot.	F
FIPYB	Floating-point frame coordinate for bottom edge of particle plot.	F
FIPYT	Floating-point frame coordinate for top edge of particle plot.	F
FIXL	Floating-point frame coordinate for left edge of regular plots.	F
FIXR	Floating-point frame coordinate for right edge of regular plots.	F
FIYB	Floating-point frame coordinate for bottom edge of regular plots.	F
FIYT	Floating-point frame coordinate for top edge of regular plots.	F
FJBP	Floating-point equivalent of \bar{J}_p .	P
FREZ	Expansion coefficient for zoning; = 1.0 if uniform throughout.	I(S)
GGMI	$\gamma(\gamma-1)$, in which γ is the equation-of-state specific heat ratio if the gas is truly polytropic.	S
GM1	$(\gamma-1)$.	I(S)
GR	g_r , gravity component in the r direction, \pm .	I(S)
GRDVEL	= 0. if pure Eulerian, = 1. if Lagrangian, = 2. if REZONE.	I(0)
GZ	g_z , gravity component in the z direction, \pm .	I(S)
GZP	g_{zp} , g_z felt by the particles. May be equal to GZ.	I(S)

<u>NAME</u>	<u>DESCRIPTION</u>	<u>SOURCE</u>
I	Index i. In COMMON because of ENTRY SETIJ in LOPP.	--
IBAR	\bar{I} , the number of interior fluid zones in the r direction.	I(0)
IBP	\bar{I}_p , the number of particle-grid zones in the r direction.	I(S)
IBP1	$\bar{I}_p + 1$, index of rightmost column of particle-grid vertices.	P
ICOLOR	= 1 for color movie, = 0 for black and white processing.	I(S)
IDT	Index for DT and DT0 tables.	S,2
IJ	Index for cell (i,j), initialized by LOPP.	L
IJM	Index for cell (i,j-1), initialized by LOPP.	L
IJP	Index for cell (i,j+1), initialized by LOPP.	L
IJPS	Index for cell (i,j+1), saved for later reference to cell (1,j+1).	L
IMOM3	IMOMX*1000, forces resetting of J in statement No. 2020 in PARTMOV if IMOMX = 1.	P
IMOMX	= 1 if particle-fluid momentum exchange, = 0 otherwise.	I(S)
IM1	$\bar{I}-1$, index of next-to-last zone or vertex in column.	S
IM6	$\bar{I}-6$, in usual large grids, this column is in somewhat from the right.	S
IPAR	L0CF(AA2), the address of LCM block AA2, for tape dump.	P
IPXL	Integer frame coordinate for left edge of particle plot.	F
IPXR	Integer frame coordinate for right edge of particle plot.	F
IPYB	Integer frame coordinate for bottom edge of particle plot.	F
IPYT	Integer frame coordinate for top edge of particle plot.	F
IP1	$\bar{I}+1$, index of rightmost column of grid vertices.	S
IP2	$\bar{I}+2$, index used in reversed D0 loops.	S
ISCF1	ISC2-NQ, the relative first word address (f.w.a.) of $i = \bar{I} + 1$ zone in SCM buffer row 1/3.	S
ISCF2	ISCF1 + NQI, the relative f.w.a. of $i = \bar{I} + 1$ zone in SCM buffer row 2/3.	S
ISC2	NQI+1, the relative f.w.a. of $i = 1$ zone in SCM buffer row 2/3.	S
ISC3	ISC2+NQI, the relative f.w.a. of $i = 1$ zone in SCM buffer row 3/3.	S
ITV	JP1*NQI, the relative f.w.a. of the $\bar{J} + 2$ row in LCM storage.	S
IUNF	I_{UNF} , the number of zones with uniform initial δr (DR).	I(0)
IXL	Integer frame coordinate for left edge of regular plots.	F
IXR	Integer frame coordinate for right edge of regular plots.	F
IYB	Integer frame coordinate for bottom edge of regular plots.	F
IYT	Integer frame coordinate for top edge of regular plots.	F
J	Index j. In COMMON because of ENTRY RLR0W and WLR0W in LOPP.	--
JBAR	\bar{J} , the number of interior fluid zones in the z direction.	I(0)
JBP	\bar{J}_p , the number of particle-grid zones in the z direction.	I(S)
JBP2	$\bar{J}_p + 2$, index of the topmost row of particle-grid vertices.	P
JCEN	Number of zones up to center of uniform-grid region.	I(0)
JM10	$\bar{J}-10$. In usual large grids, this row is down from the top.	S
JM14	$\bar{J}-14$. In usual large grids, this row is down from the top.	S
JP1	$\bar{J}+1$, index of topmost row of interior zones.	S
JP2	$\bar{J}+2$, index of topmost row of grid vertices.	S
JP4	$\bar{J}+4$, index used in reversed D0 loops and in LCM clearing.	S
JP402	$(\bar{J}+4)/2$, j index at midpoint of full YAQUI grid.	S
JUNF	J_{UNF} , the number of zones with uniform initial δz (DZ).	I(0)
JUNF02	$J_{UNF}/2$ uniform zones lie above JCEN, and $J_{UNF}/2$ lie below.	S
KXI	ξ , the ρ exponent that determines the viscosity form.	I(0)
LAM	λ_{input} viscosity coefficient. A real number.	I(S)

<u>NAME</u>	<u>DESCRIPTION</u>	<u>SOURCE</u>
LJP2	First word address of last zone in row JP2 when in usual SCM buffer row.	S
LPB	Number of words, truncated to a multiple of 3, that will fit in NQI-wd. SCM row.	P
LPR	Determines output options of film and printer.	I(S)
MU	μ_{input} viscosity coefficient. A real number.	I(S)
NAME	The problem identification from input card No. 2, up to 79 characters.	I(S)
NCYC	Number of calculational cycles completed.	S,2
NLC	Number of words of LCM block AA1 actually in use, for tape dump.	S
NPS	Number of words of LCM particle block AA2 actually in use, for tape dump.	P
NPT	Total number of particles generated.	P
NQ	Number of quantities, or storage words, per cell.	0
NQI	$NQ*IP1$, the number of words for a full row of zones.	S
NQIB	$NQ*IBAR$, the number of words back to zone $i = 1$ when at $i = \bar{I} + 1$ in SCM.	S
NQI2	$NQI*2$, the number of words in two full rows of zones, for PARTMØV.	P
NSC	Number of words in this SCM CØMMØN, for tape dump.	S,2
NUMIT	Number of iterations required for Phase-2 convergence.	2
NUMTD	Number of the next tape dump.	S,2
ØM	ω , the Phase-2 iteration relaxation parameter.	I(S)
ØMANC	$(1-a_{NC})$, used in δt_v calculation.	S
ØMCYL	$(1-CYL)$, used in calculating r from x .	S
ØMEM10	$(1-10^{-10})$.	S
ØPEM10	$(1+10^{-10})$.	S
PDR	The uniform Δx of the particle grid.	S,P,R
PDZ	The uniform Δy of the particle grid.	S,P,R
PXCØNV	Frame-conversion coefficient for particle-plot x direction.	F
PXL	X coordinate of left edge of particle grid, in problem units.	F
PXR	X coordinate of right edge of particle grid, in problem units.	F
PXRP	$PXR*ØPEM10$, test comparand in particle-grid mapping.	F
PYB	Y coordinate of bottom edge of particle grid, in problem units.	S,F,R
PYBM	$PYB*ØMEM10$, test comparand in particle-grid mapping.	F
PYCØNV	Frame-conversion coefficient for particle-plot y direction.	F
PYT	Y coordinate of top edge of particle grid, in problem units.	F
PYTP	$PYT*ØPEM10$, test comparand in particle-grid mapping.	F
RDT	$1/\delta t$.	2
REZRØN	ρ_o of the ambient atmosphere at altitude REZY0 at $t = t_o$.	I(S)
REZSIE	The (constant) specific internal energy of the ambient atmosphere.	I(S)
REZUE	Grid-expansion u velocity, available for REZØNE use.	I(S),R
REZVE	Grid-expansion v velocity, available for REZØNE use.	I(S),R
REZVT	Grid-translation velocity, available for REZØNE use.	I(S),R
REZY0	Y coordinate of center of expansion, refers to YAQUI vertex (1,JCEN+2).	I(S)
RIBAR	Reciprocal of \bar{I} .	S
RIBJB	Reciprocal of $\bar{I}*\bar{J}$, used in control region grind calculation.	S
RIBP	Reciprocal of \bar{I}_p .	P
RJBP	Reciprocal of \bar{J}_p .	P
RØMFR	Reciprocal of $(1.-FREZ)$.	S
RØN	ρ_o , normal density for equation-of-state use.	I(S)
RPDR	Reciprocal of Δx .	F
RPDRDZ	Reciprocal of $(\Delta x*\Delta y)$.	F

<u>NAME</u>	<u>DESCRIPTION</u>	<u>SOURCE</u>
RPDZ	Reciprocal of Δy .	F
T	t, the problem time.	I(S),2
THIRD	1./3.	S
TLIMD	= 1.0 to force a tape dump & RETURN before time limit.	I(S)
TOUT	The next output time for plots/prints.	S,2
TWFIN	Time-When-to-Finish: calculation completed when $t \geq$ TWFIN.	I(S)
TZOMD	= 1.0 to force tape dumps every 20' CP time.	I(S)
VV	Velocity-vector plot-scaling coefficient, = 9/10 average δr .	F
XC0NV	Frame-conversion coefficient for regular plots, x direction.	F
XL	X coordinate of leftmost vertex of the grid, in problem units.	F
XR	X coordinate of rightmost vertex of the grid, in problem units.	F
YB	Y coordinate of bottommost vertex of the grid, in problem units.	F
YC0NV	Frame-conversion coefficient for regular plots, y direction.	F
YT	Y coordinate of topmost vertex of the grid, in problem units.	F
ZZ	Dummy word, always the final word in the C0MM0N.	--

IV. SOME CALCULATIONAL EXAMPLES

Here we present results from several YAQUI calculations. Emphasis is on the method's versatility in handling a given problem, rather than on presenting a wide variety of different examples.²

The flexibility of the Arbitrary Lagrangian-Eulerian approach is illustrated in the calculation of a one-dimensional shock tube, performed first in a Lagrangian fashion, and then with a full Eulerian rezone. This example is followed by sequences at very early times from three calculations of a low-altitude explosion, first Lagrangian, next Eulerian, then with the REZONE subroutine as presented in this report.

The versatility of the YAQUI particle technique is illustrated at one extreme by the marker particles carried along with the fluid in the low-altitude explosion calculations, where the particles have no influence on the flow, and at the other extreme by calculations in which the particles govern the fluid dynamics through the momentum-exchange feature.

Finally, we present listed results from a particle-fluid momentum-exchange calculation, for those readers who may find a benchmark calculation useful.

Detailed discussions of various YAQUI calculations will be presented elsewhere, and no attempt is made here to describe a variety of late-time results.

A. One-Dimensional Shock Tube

The two examples in Figs. 16 and 17 were selected from a series of one-dimensional shock-tube test cases; although they do not necessarily represent the best that YAQUI can do for this problem, they clearly demonstrate that satisfactory results can be obtained in both the Lagrangian and Eulerian limits. The figures show the profiles (heavy lines) of velocity, pressure, specific internal energy, and density from a pure Lagrangian (GRDVEL = 1.0) calculation and then a pure Eulerian (GRDVEL = 0.0) calculation of a 2:1 density-ratio shock tube, along with the theoretical solution (lighter lines) to the problem.³

The calculations were performed in a plane mesh 60 cells long by 1 cell high, allowing 30 cells for each fluid region. The initial p was 0.2 on the left and 0.1 on the right, and the initial specific internal energy was 0.18. The initial cell size was $\delta r = \delta z = 1/3$, the viscosity coefficients were $\lambda = 0.002$ and $\mu = 0.0$, and, in addition, the gas was polytropic with $\gamma = 5/3$. The Eulerian shock tube was run with full donor-cell differencing ($\alpha_0 = \alpha_{0M} = 1.0$, $\beta_0 = 0.0$). At $t = 0$, the diaphragm separating the two fluid regions was instantaneously removed, causing a shock to advance into the lower density region, and a rarefaction to propagate back from the contact surface into the higher density region. In both calculations, δt was held constant at 0.1, and the profiles shown in Figs. 16 and 17 are at $t = 10.0$. Such calculations typically require

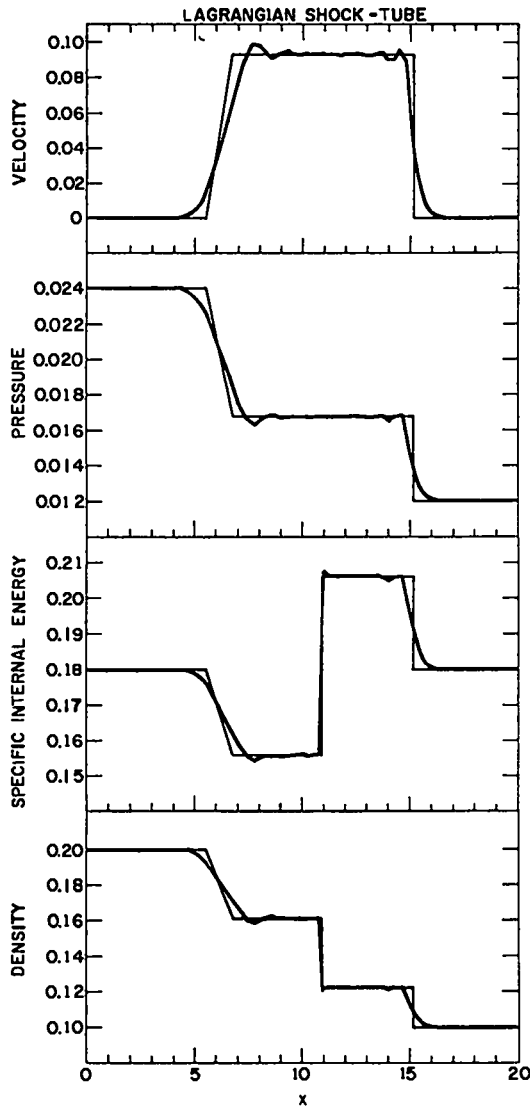

Fig. 16. One-dimensional YAQUI Lagrangian calculation of a 2:1-density-ratio shock tube.

20 to 30 sec of CDC-7600 time to run to $t = 15.0$, producing plots and prints every unit of time.

B. A Low-Altitude Explosion

These examples demonstrate three distinct approaches to the treatment of grid motion in a typical low-altitude explosion calculation. The sets of six plots in each of Figs. 18, 19, 21, 23, and 24 represent the marker particles, computing mesh, and velocity vectors (top) and isopycnic, isotherm, and vorticity contour plots (bottom).

Figure 18 shows the various plots at time $t = 0$, immediately after superposing the explosion density, energy, and velocity data, which were provided by a one-dimensional spherical code, onto a

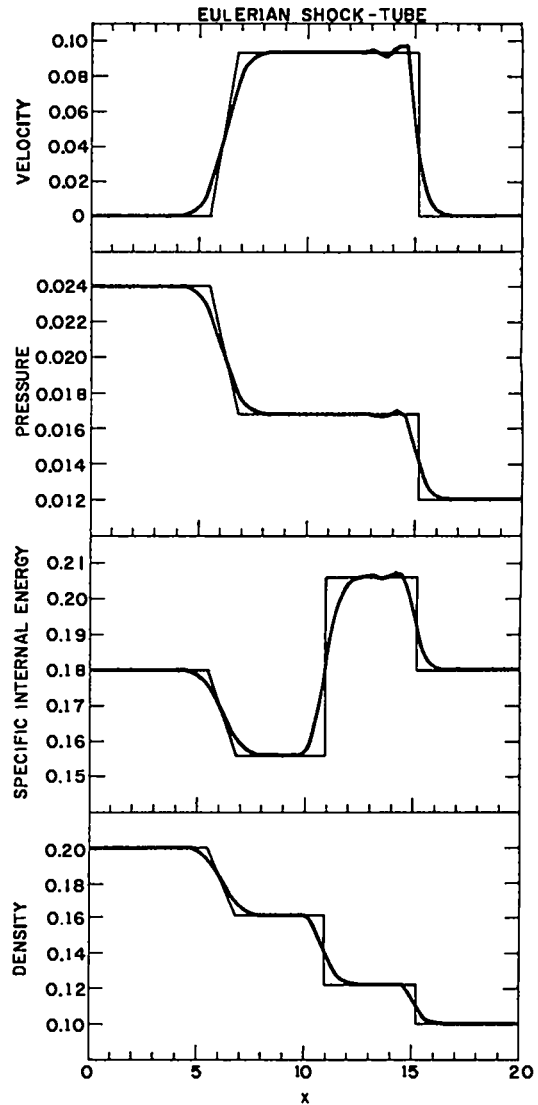

Fig. 17. One-dimensional YAQUI Eulerian calculation of a 2:1-density-ratio shock tube.

uniform 26 by 52 cell YAQUI computing grid that already contained an appropriate ambient background. This procedure was described in Sec. III A. In the particle plot, the explosion debris is represented by a hemisphere of particles, surrounded by more widely spaced particles in an adjacent region of the ambient atmosphere. These marker particles do not enter directly into the calculation, but are used solely as an aid to flow visualization. Note that the velocity, density, and energy fields are well developed, but that the vorticity field is not, and indeed, will not be well established for about the first two seconds of problem time.

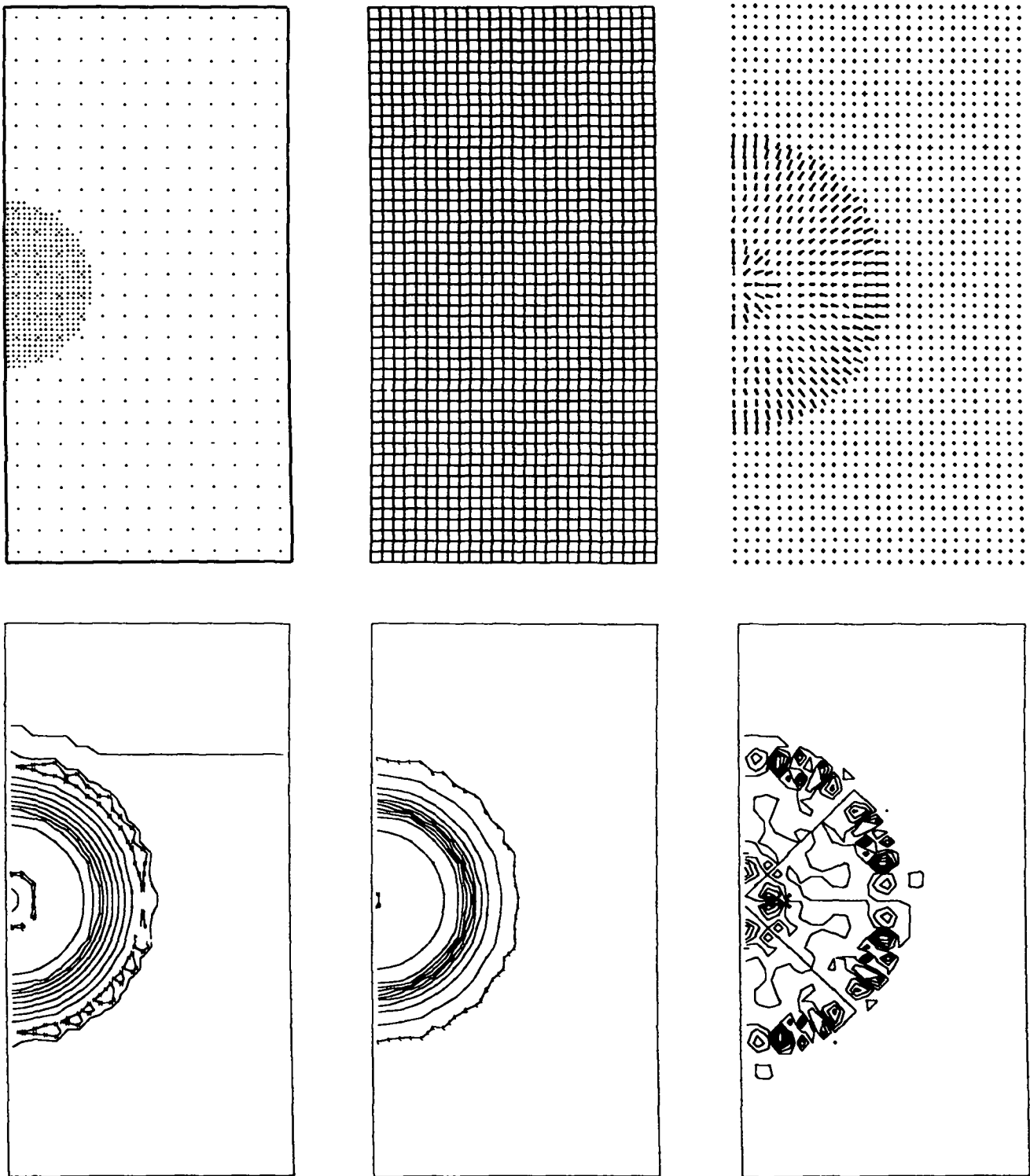

Fig. 18. YAQUI low-altitude explosion calculation at $t = 0$. The six plots represent the marker particles, computing mesh, and velocity vectors (top) and isopycnic, isotherm, and vorticity contour plots (bottom).

Figure 19 shows the same six plots at $t = 1$ sec from a calculation of this problem in which the interior vertices were allowed to move in a purely Lagrangian fashion ($GRDVEL = 1.0$). The rigid walls of the computing mesh are held fixed, causing the strong radially expanding shock to reflect back into the central region shortly after $t = 2$ sec. This effect is visible in Fig. 20, which shows the appearance of the velocity vectors at $t = 2$ and $t = 3$ sec.

Figure 21 shows the six basic plots from a pure Eulerian calculation ($GRDVEL = 0.0$) of the same problem at $t = 1$ sec. More resolution is available in the central region, and less resolution is given to the shock front, than in the Lagrangian calculation. As in the Lagrangian calculation, the walls are rigid, and the $t = 2$ and $t = 3$ sec velocity-vector plots of Fig. 22 show the same strong wall reflection as did Fig. 20.

In reality, the edges of an atmospheric region are not rigid walls, so to calculate such an atmospheric explosion beyond the first two or so seconds, with this degree of resolution, would require one of several possible alternatives:

- (1) A vastly larger computing mesh could be used, but this obviously is not economical in terms of computer storage and time requirements.
- (2) Continuative outflow boundaries would allow the strong radially expanding shock to leave the system with a minimum of upstream disturbance, but the subsequent rise of the explosion debris sucks material up behind it in the central column, causing the bottom and right walls of the mesh to become inflow boundaries. Appropriate inflow conditions are difficult to define, suggesting again a larger computing mesh to avoid this difficulty.
- (3) A third choice, which we exploit in YAQUI, is to allow the entire mesh to expand at a rate that will keep the reflective boundaries out ahead of the radial shock while it has significant strength. At the same time, we vary the sizes of the interior zones to provide high resolution in the central region and much coarser resolution in the outlying regions, which still allows the use of the same number of cells.

Figures 23 and 24 show such a calculation, using the REZONE subroutine exactly as provided in the code version of this report. The problem input

is identical to the preceding cases except that $GRDVEL = 2.0$. As the problem proceeds, the mesh is continuously enlarged at a rate that depends upon the magnitude of the velocities approaching the boundaries. This expansion leaves a region without particles around the outer regions of the mesh, which is already evident by $t = 1$ sec (Fig. 23). By $t = 5$ sec (Fig. 24), the initial mesh radius has already increased by 50%, allowing the calculation to run to much later times without boundary interference than do either the Lagrangian or pure Eulerian approaches. Note in Fig. 24 that the velocities near the rigid walls are negligible, and that the vorticity field has become well established.

Because the computer is programmed to draw pictures of a fixed size, the frame scales of Figs. 23 and 24 differ and are further quite different from the scale in the preceding figures. (Information printed on the film below each plot provides the necessary specifications to properly interpret the plot.)

Figures 23 and 24 represent only the early stages of a calculation that has been made feasible through the use of continuous rezoning and mesh expansion. These techniques, combined with an appropriate mesh translation that follows the debris rise, allow the dynamics to be followed for several hundred seconds of problem time. A wide variety of REZONE subroutines have been used with success, each tailored to provide optimum results for a particular problem.

We generally enhance this approach by combining it with an initial grid containing variable cell sizes, as described in Sec. III A. Figure 25 shows a setup configuration for the same problem, in which the cells are expanded ($FREZ = 1.1$) beyond a uniformly zoned 16 by 32 cell central region. This affords high resolution where required, at the same time allowing the continuous rezoning and expansion to take place much more gradually, as in this particular case the initial mesh encompasses a much larger volume.

The CDC-7600 CP time per cell per cycle (grinds) averages approximately 0.50 msec at two iterations per cycle, increasing by about 0.03 to 0.04 msec for each additional iteration required for convergence in Phase 2. Calculations such as

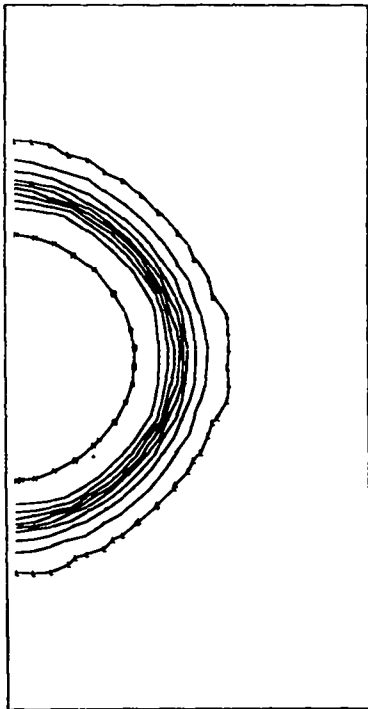
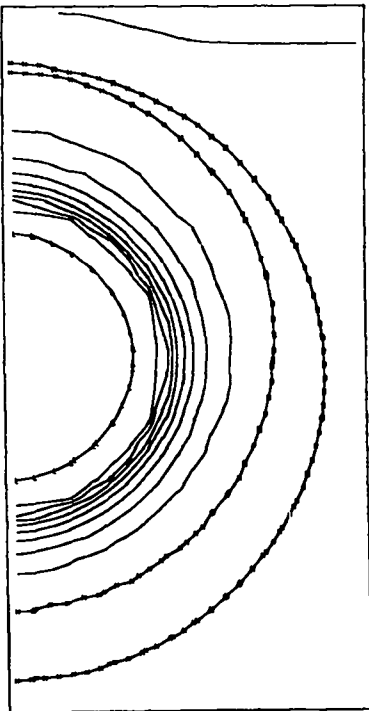
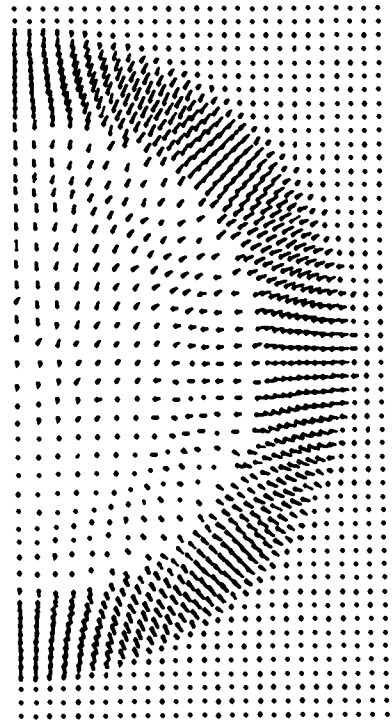
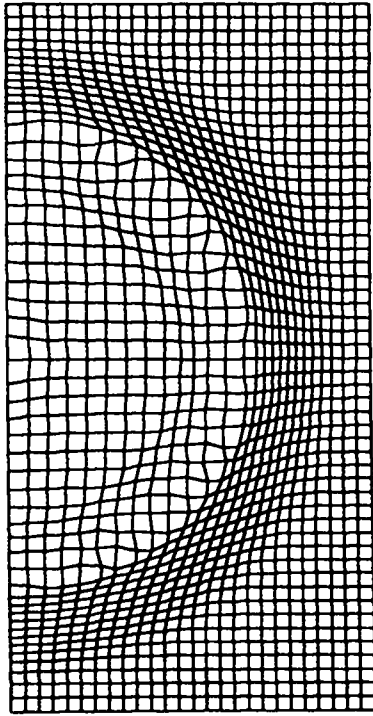
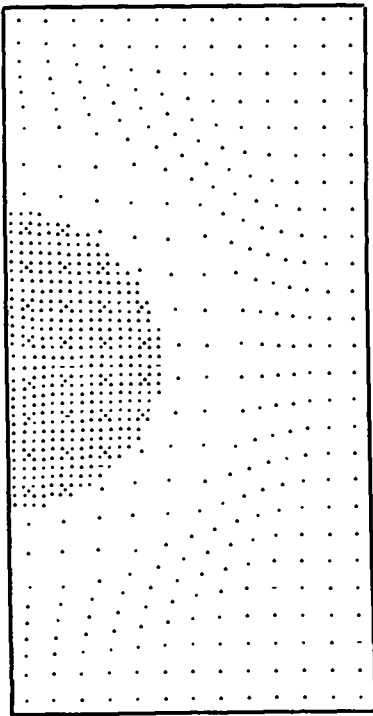

Fig. 19. A Lagrangian calculation at $t = 1$ sec of the problem setup of Fig. 18.

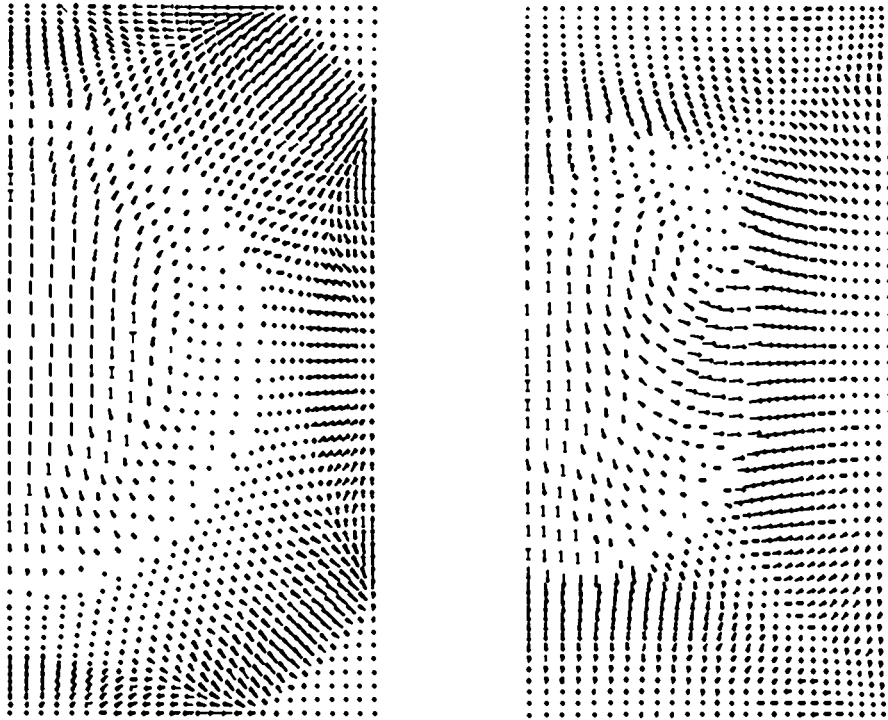

Fig. 20. Velocity-vector plots at $t = 2$ and $t = 3$ sec of the problem shown in Fig. 19, showing shock reflection from the boundaries.

this, with 1500- to 1600-cell meshes, can be followed to over 200 sec of problem time in well under 1h of CDC-7600 time, with generous amounts of output along the way.

C. Particle-Fluid Momentum Exchange

An example of the particle-fluid momentum-exchange feature described in Sec. II E 2 is illustrated in the particle-drag problem of Fig. 26. The first set of three frames show the initial particles, velocity vectors, and the (Eulerian) computing grid with cylindrical symmetry and rigid free-slip boundaries. In this calculation, a sphere of particles, each of which has a finite mass and drag coefficient, is immersed in a fluid of uniform density and energy, representing a two-fluid configuration in which the density of the heavier spherical part is given by the sum of the background fluid and particle densities. Initially, there are no velocities in the system; the entire dynamics of the calculation result from a gravitational force upon the particles but not upon the fluid. This causes the sphere of particles to fall and deform, producing a pronounced circulation pattern within the fluid.

The evolution of this process is shown in the remaining seven sets of plots in Fig. 26, at times of 9, 12, 15, 18, 21, 24, and 27. Each set of three frames consists of a particle plot and the velocity vectors and vorticity contours for the fluid. Note that the effects of drag soon retard the leading edge of the sphere relative to the shielded trailing edge. The sphere is deformed into a cup, with a vortex ring around the rim. At time $t = 21$, the cup collides with the bottom wall of the mesh and is seen gradually settling into place thereafter. By time $t = 27$, only the rolled rim retains any definition, but it, too, will soon collapse into the rest of the particles. The circulation pattern will persist for some time, until viscous effects gradually damp it out.

D. Input Data and Results from a Sample Calculation

The following pages are abstracted from the microfilm output of a particle-fluid momentum-exchange test calculation. They are included as an aid to the reader who uses YAQUI, allowing him to set up the same problem and compare results.

The input data are listed in their entirety, and include all information necessary to specify the

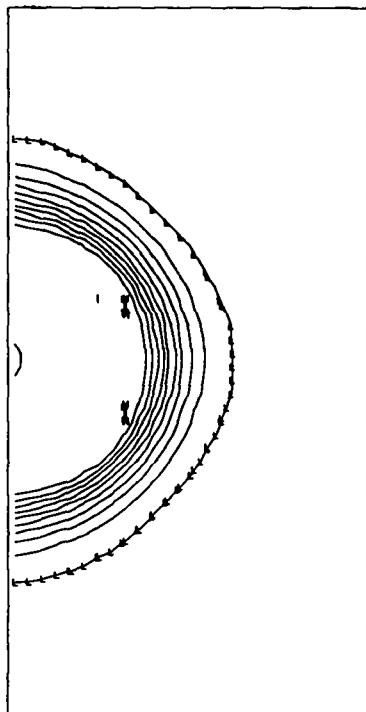
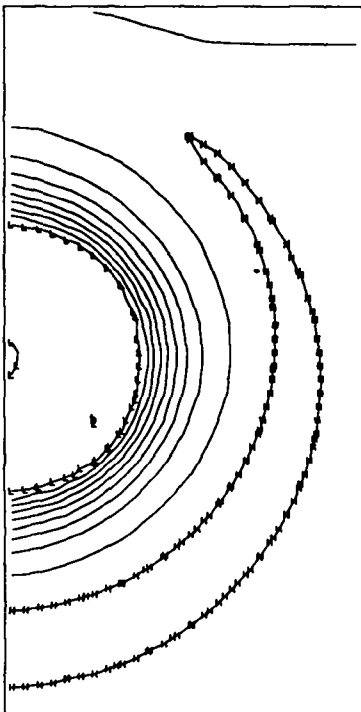
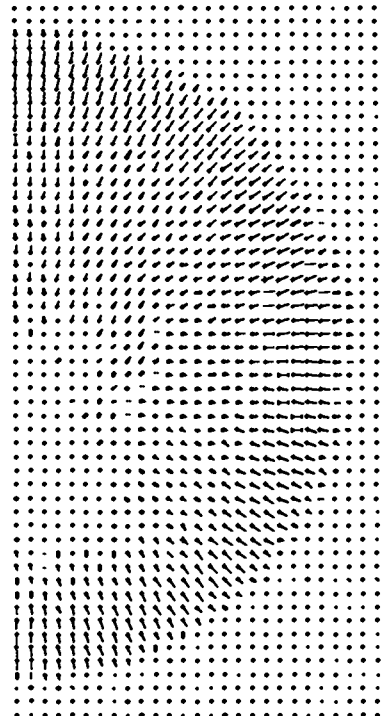
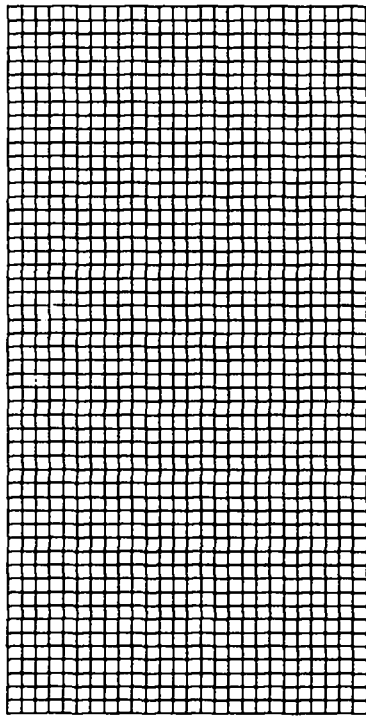
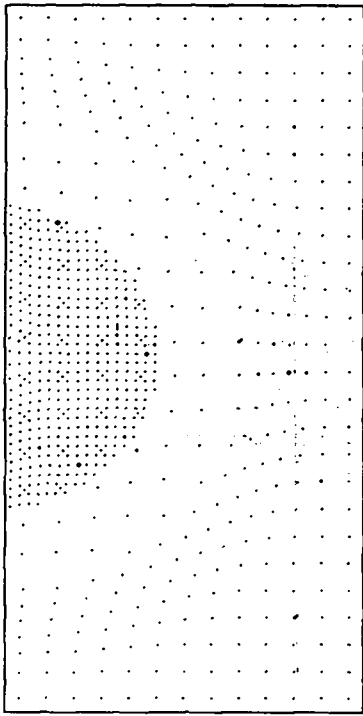

Fig. 21. An Eulerian calculation at $t = 1$ sec of the problem setup of Fig. 18.

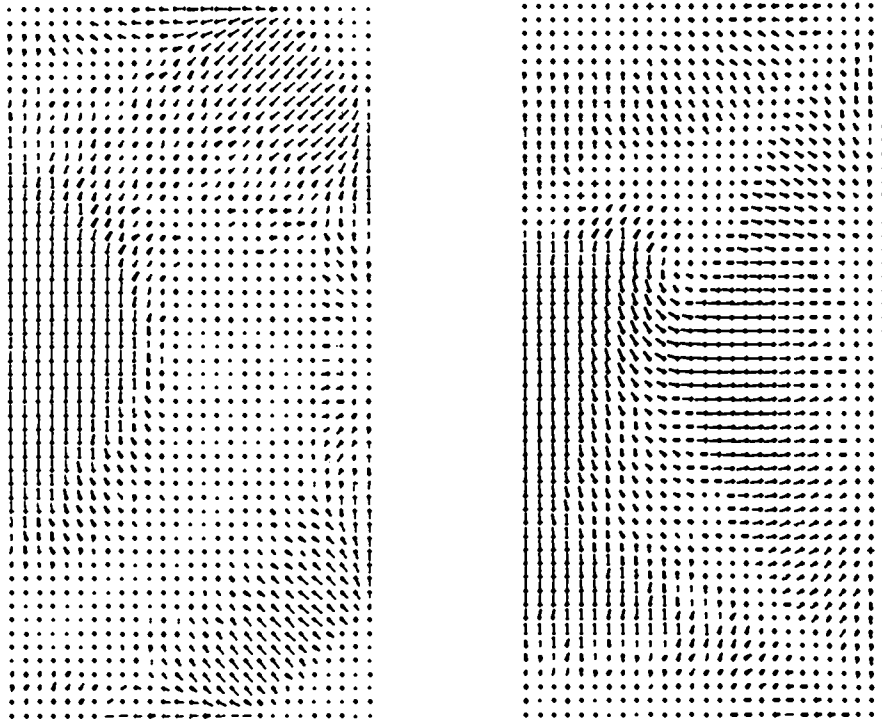

Fig. 22. Velocity-vector plots at $t = 2$ sec and $t = 3$ sec of the problem shown in Fig. 21, showing shock reflection from the boundaries.

problem. Subsequent pages show the initial particle and zone plot configurations at time 0, along with a sample frame abstracted from the cell print. This includes a row across the mesh halfway up, cutting through the initial position of the sphere of particles. This same frame of print output is included for cycle 1, to show the initial changes in the fluid variables.

For $t = 1.0$ (cycle 7), we present six frames. These include plots of the particles, and for the fluid, the velocity vectors and contours of density, specific internal energy, and vorticity, followed by the sample listing. The normal velocities on the symmetry axis are, of course, nonphysical. They result from the momentum carried by the particles and distributed to the cell vertices. After each cycle, these velocities are reset to zero, so no buildup can occur. This will, however, act as a

sink for momentum, which would be easy to correct if it became a problem.

Finally, we present the same six frames at $t = 9.0$ (cycle 232). Note in the listing that the circulation pattern is quite evident in the wake of the particles. The u velocities at this height on the axis are now zero, as the particles are no longer present here to contribute momentum changes.

The CDC-7600 CP time for this calculation was 305 sec for 265 calculational cycles (to time $t = 9.54181$). After the first 100 cycles, the number of iterations required for convergence in each cycle stabilized at 4, for which the grinds (CP time per cell per cycle) averaged about 0.637 msec. Comparison with the grinds for the low-altitude explosion calculation (0.56 msec) indicates that slightly more time is required for the momentum-exchange option.

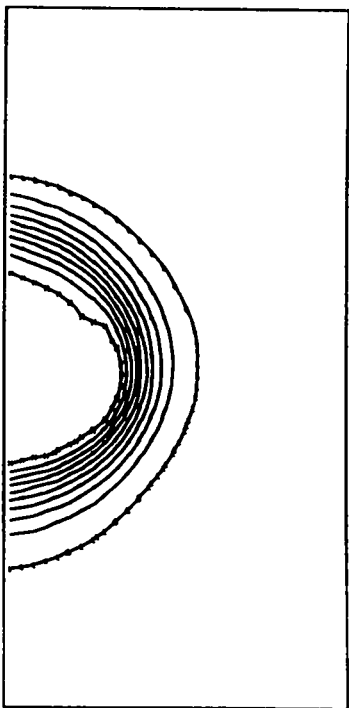
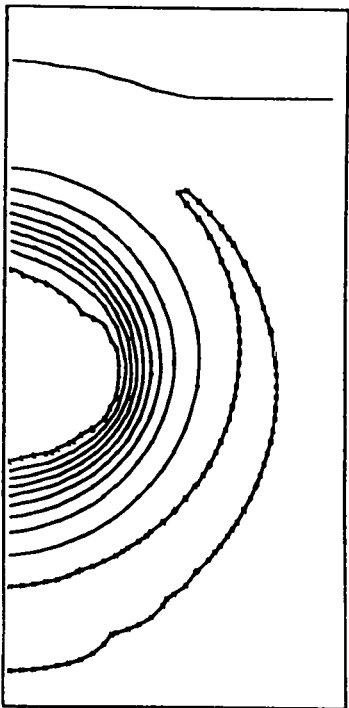
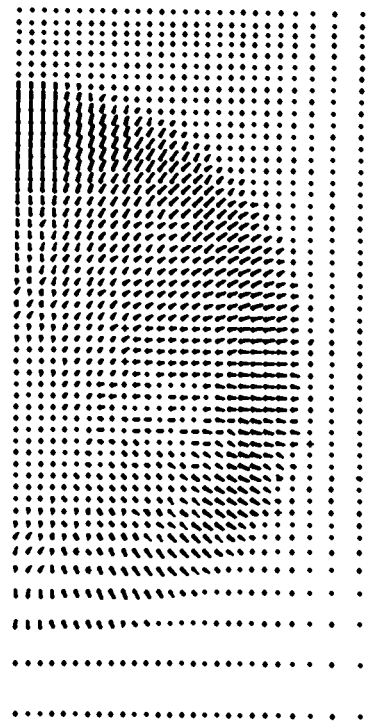
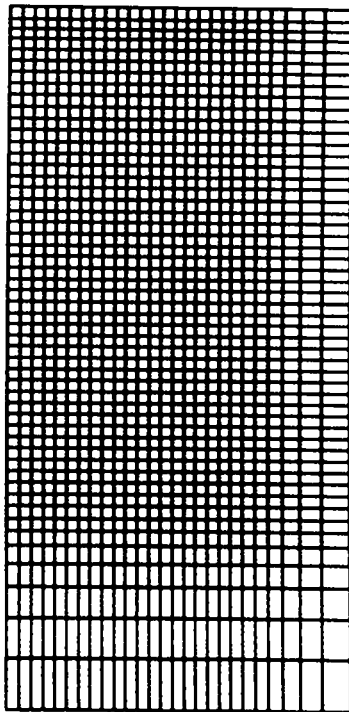
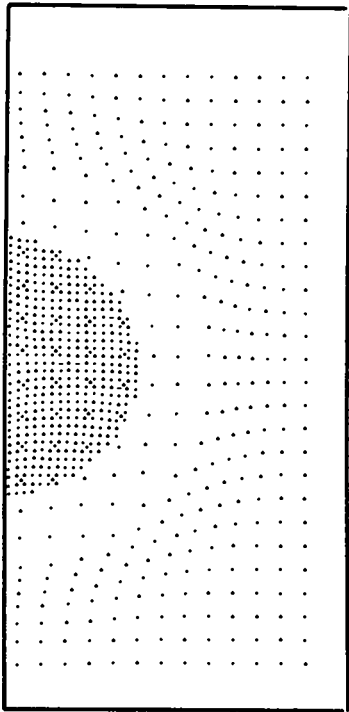

Fig. 23. A REZONE calculation at $t = 1$ sec of the problem setup of Fig. 18.

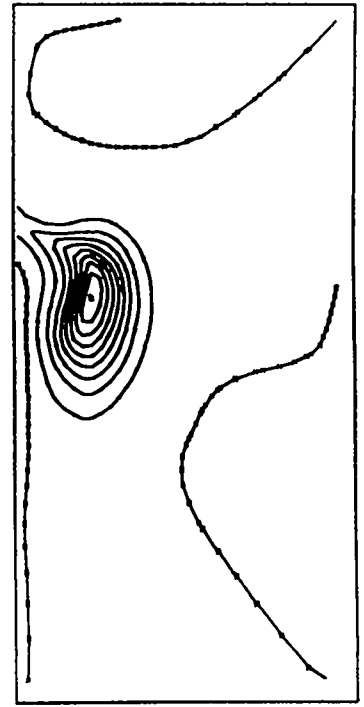
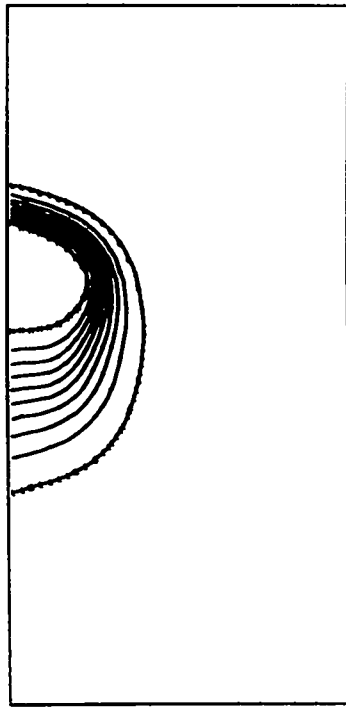
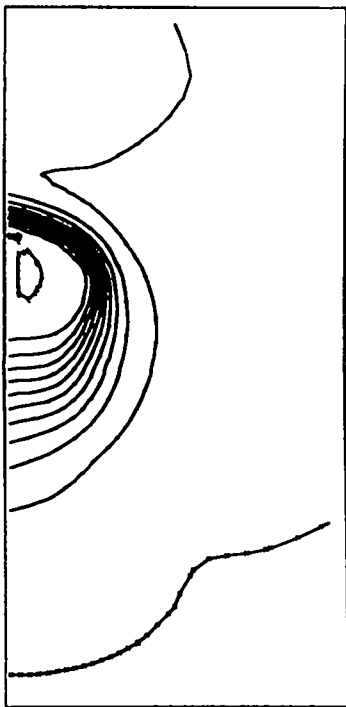
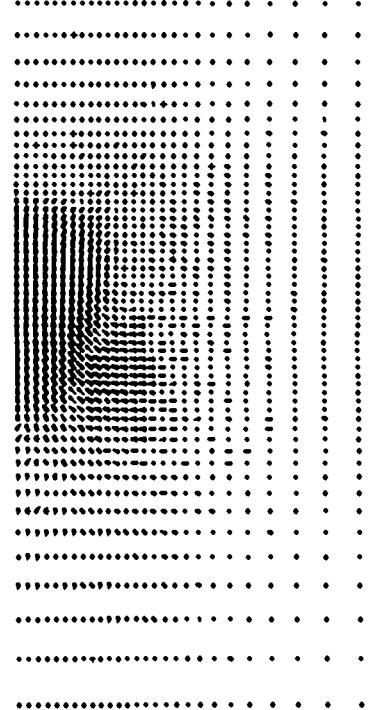
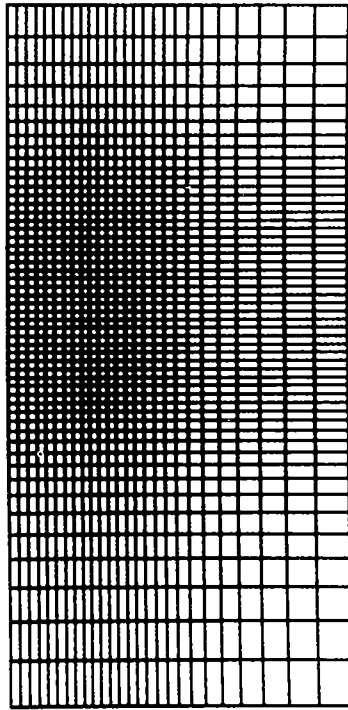
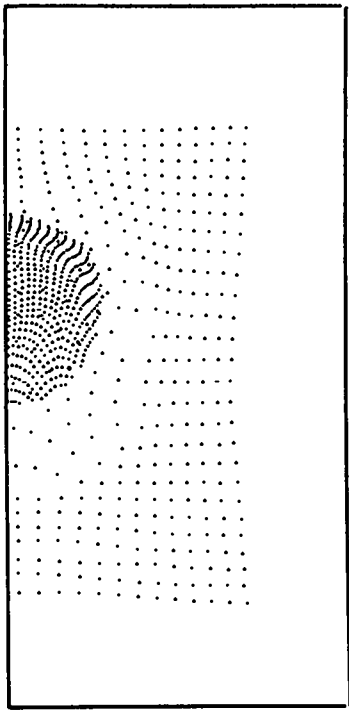

Fig. 24. The REZØNE calculation of the problem of Figs. 18 and 23 at $t = 5$ sec.

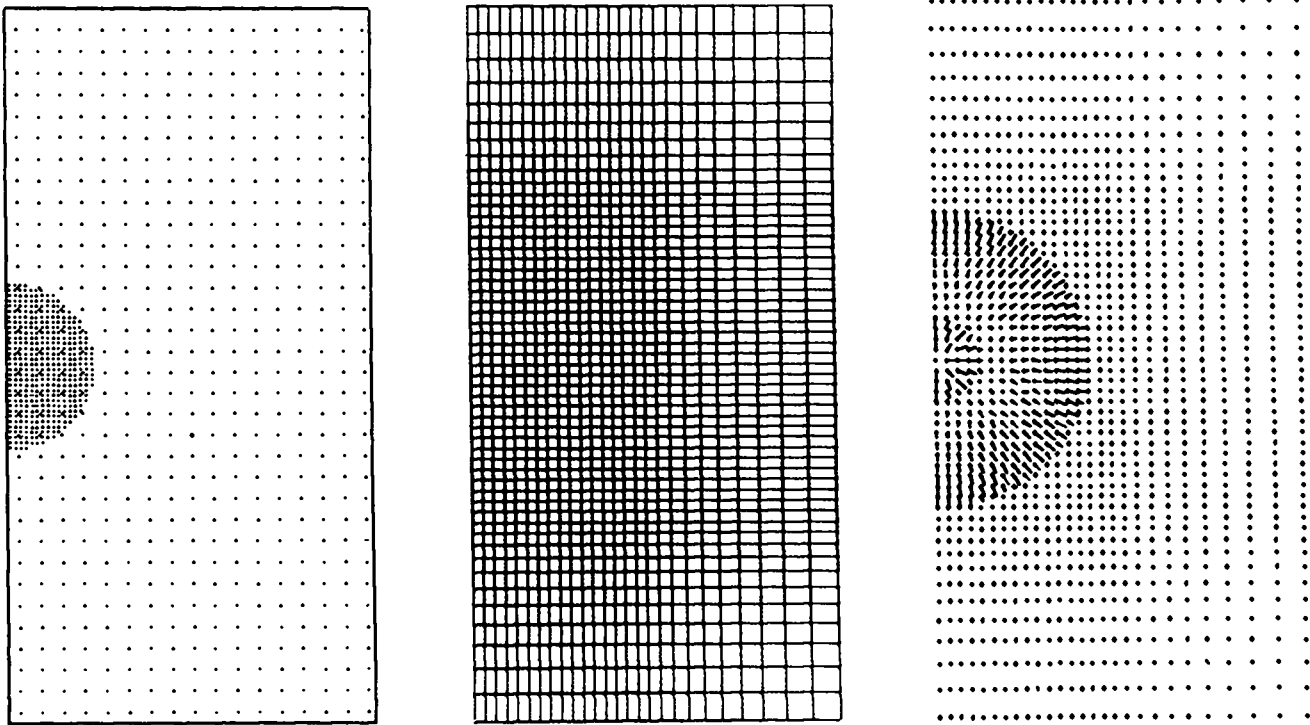

Fig. 25. A YAQUI setup with initial variable zoning for the problem shown in Fig. 18.

V. REFERENCES

1. F. H. Harlow and A. A. Amsden, "A Numerical Fluid Dynamics Calculation Method for All Flow Speeds," *J. Comp. Phys.* **8**, 197 (1971).
2. C. W. Hirt and A. A. Amsden, "An Arbitrary Lagrangian-Eulerian Computing Method for All Flow Speeds," submitted to *J. Comp. Phys.*
3. F. H. Harlow and A. A. Amsden, "Fluid Dynamics: A LASL Monograph," Los Alamos Scientific Laboratory report No. LA-4700 (1971).
4. R. S. Hotchkiss and C. W. Hirt, "Particulate Transport in Highly Distorted Three-Dimensional Flow Fields," Vol. II, Proceedings of the 1972 Summer Computer Simulation Conference, San Diego, California, June 14-16, 1972.
5. A. A. Amsden and C. W. Hirt, "A Simple Scheme for Generating General Curvilinear Grids," *J. Comp. Phys.*, accepted for publication.

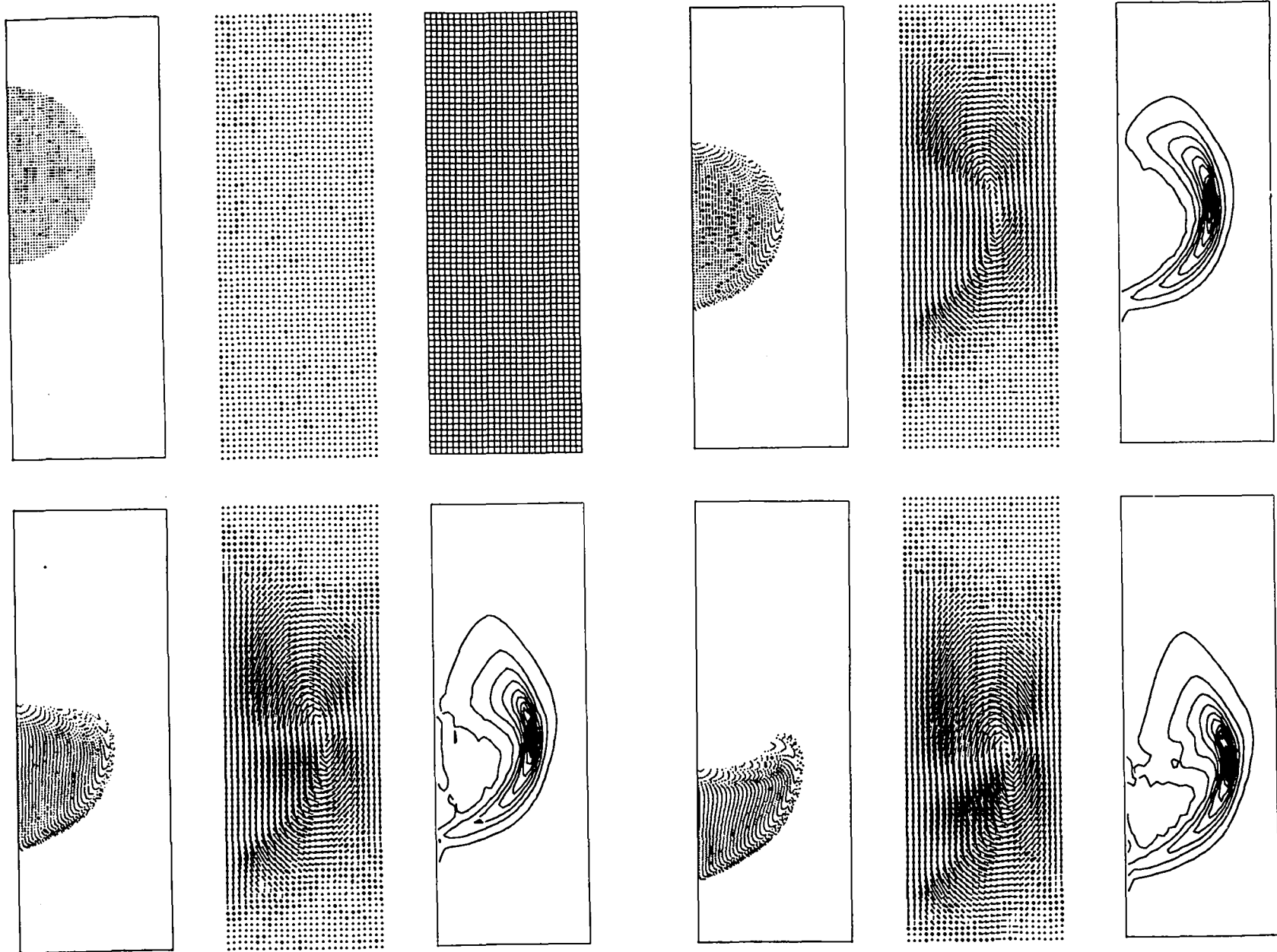

Fig. 26. YAQUI particle-fluid momentum-exchange calculation.

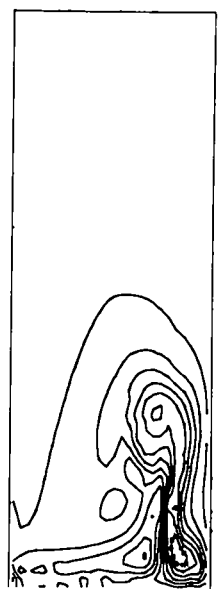
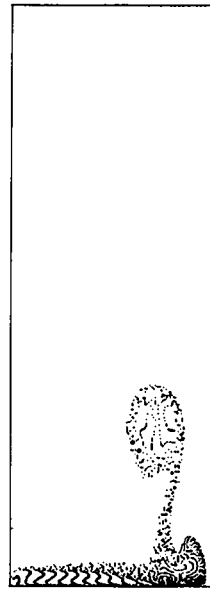
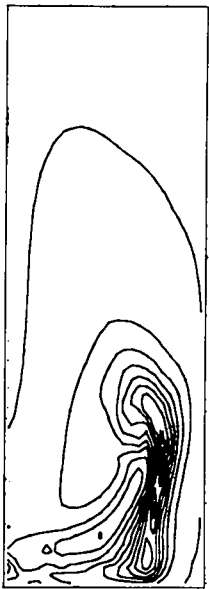
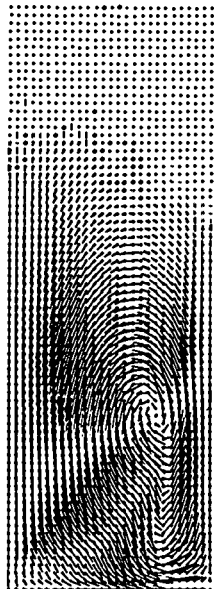
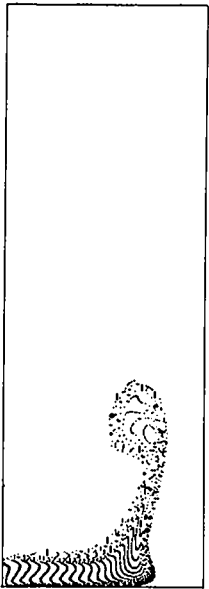
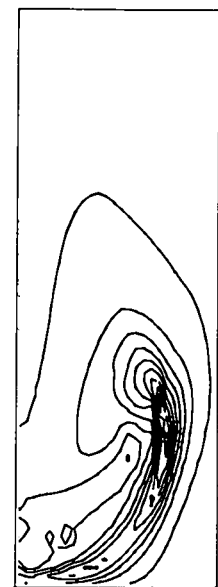
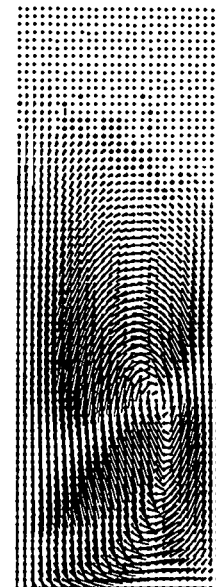
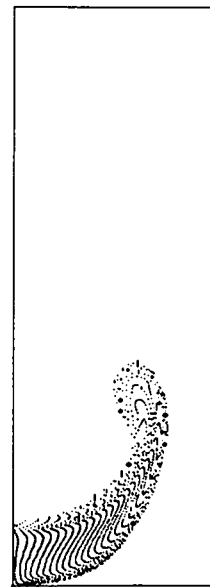
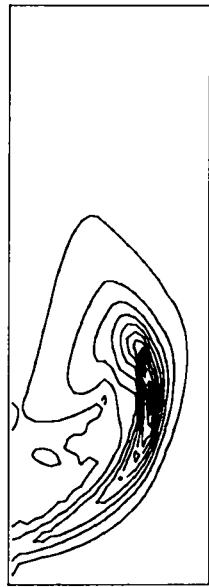
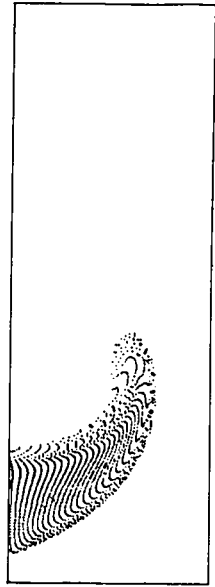
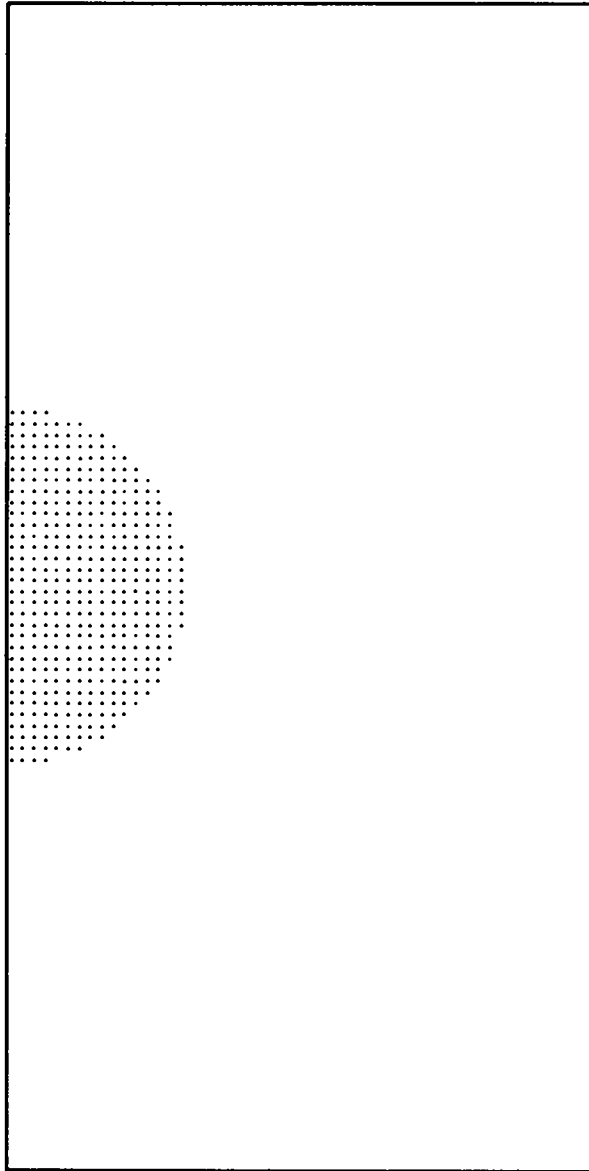

Fig. 26 (Contd)

YAQUI PARTICLE-FLUID MOMENTUM EXCHANGE TEST. (T3AAA1GB 032272-3)

110872-1

IBAR= 26
JBAR= 52
IUNF= 26
JUNF= 52
JCEN= 26
DR= 1.00000E+00
DZ= 1.00000E+00
CYL= 1.00000E+00
GRDVEL= 0.
AD= 7.50000E-01
ADM= 7.50000E-01
BD= 0.
KXI= -1
MU= 1.00000E+00
LAM= 1.00000E+01
OM= 1.00000E+00
EPS= 1.00000E-04
GR= 0.
GZ= 0.
ASQ= 1.00000E+02
RON= 1.00000E+00
GM1= 0.
FREZ= 1.00000E+00
YB= 0.
REZY0= 0.
REZUE= 0.
REZVE= 0.
REZVT= 0.
REZRON= 0.
REZSIE= 0.
IBP= 26
JBP= 52
PDR= 1.00000E+00
PDZ= 1.00000E+00
PYB= 0.
GZP=-1.00000E+00
IMOMX= 1
T= 0.
DT= 1.00000E-01
T2OMO= 0.
TLIMO= 0.
TWFIN= 1.00000E+01
LPR= 1
ICOLOR= 0
DT0(I-10)= 1.00000E+00 -0. -0. -0. -0.
-0. -0. -0. -0. -0.
DT0C(I-10)= 1.00000E+02 -0. -0. -0. -0.
-0. -0. -0. -0. -0.
DRPAR= 5.00000E-01 DZPAR= 5.00000E-01 XC= 0. YC= 2.60000E+01 XD= 8.00000E+00
YD= 0. UPAR= 0. VPAR= 0. MTE= 2.50000E-01 DRAG= 1.00000E+00
408 PARTICLES GENERATED, WITH TOTAL MASS= 3.46375E+02
NB= 0 NR= 26 NT= 52 NL= 0 UI= 0. V1= 0. R01= 1.00000E+00 SIEI= 1.00000E+00



PARTICLES

PDR= 1.00000E+00 PDZ= 1.00000E+00 PXR= 2.60000E+01 PYB= 0. PYT= 5.20000E+01
T3AAA 18A YAQUI PARTICLE-FLUID MOMENTUM EXCHANGE TEST. (T3AAA108 032272-3) 110872-1 T= 0. CYCLE= 0

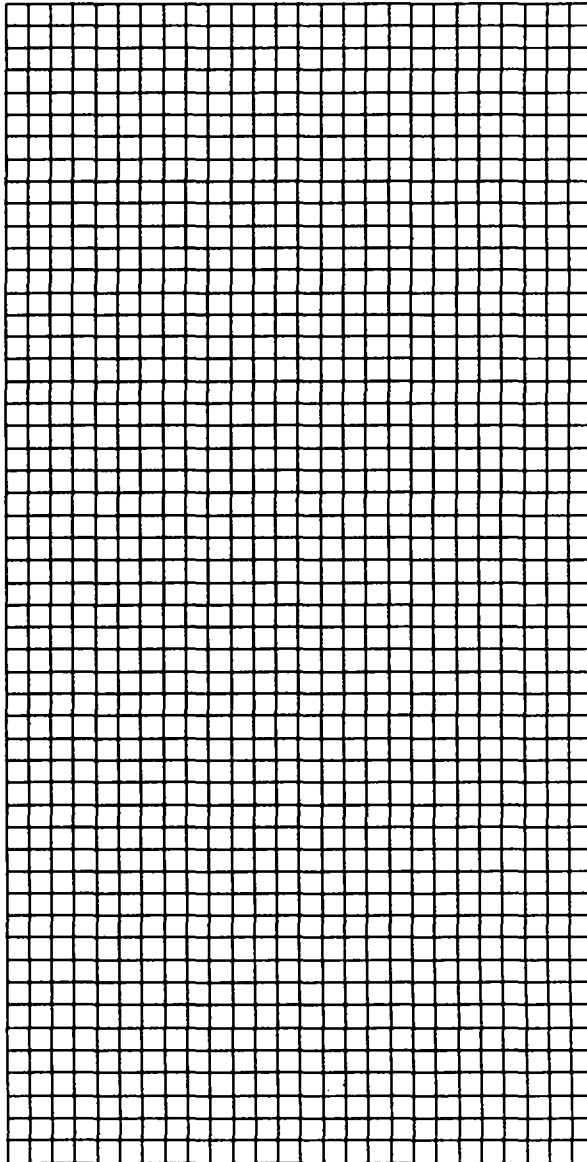

ZDNES

DRMIN= 1.00000E+00 DRMAX= 1.00000E+00 DZMIN= 1.00000E+00 DZMAX= 1.00000E+00 XR= 2.60000E+00 YB= 0.
T3AAA 1BA YAQUI PARTICLE-FLUID MOMENTUM EXCHANGE TEST. (T3AAA1GB 032272-3, 110872-1 T= 0.

YT= 5.20000E+01
CYCLE= 0

T3AAA		18A YAQUI			PARTICLE-FLUID			MOMENTUM EXCHANGE TEST. (T3AAA1GB 032272-3)			110872-1		T= 1.00000E-02 CYCLE=		1
I	J	X	Y	U	V	SIC	RHO	VOL	D	M	P				
0.	26	7.0000E+00	2.4000E+01	0.	-9.2157E-05	1.0000E+00	1.0000E+00	7.5000E+00	-1.2410E-05	7.0000E+00	0.				
9.	26	8.0000E+00	2.4000E+01	0.	-2.9200E-05	1.0000E+00	1.0000E+00	8.5000E+00	-8.9920E-06	8.0000E+00	0.				
10.	26	9.0000E+00	2.4000E+01	0.	0.	1.0000E+00	1.0000E+00	9.5000E+00	0.	9.0000E+00	0.				
11.	26	1.0000E+01	2.4000E+01	0.	0.	1.0000E+00	1.0000E+00	1.0500E+01	0.	1.0000E+01	0.				
12.	26	1.1000E+01	2.4000E+01	0.	0.	1.0000E+00	1.0000E+00	1.1500E+01	0.	1.1000E+01	0.				
13.	26	1.2000E+01	2.4000E+01	0.	0.	1.0000E+00	1.0000E+00	1.2500E+01	0.	1.2000E+01	0.				
14.	26	1.3000E+01	2.4000E+01	0.	0.	1.0000E+00	1.0000E+00	1.3500E+01	0.	1.3000E+01	0.				
15.	26	1.4000E+01	2.4000E+01	0.	0.	1.0000E+00	1.0000E+00	1.4500E+01	0.	1.4000E+01	0.				
16.	26	1.5000E+01	2.4000E+01	0.	0.	1.0000E+00	1.0000E+00	1.5500E+01	0.	1.5000E+01	0.				
17.	26	1.6000E+01	2.4000E+01	0.	0.	1.0000E+00	1.0000E+00	1.6500E+01	0.	1.6000E+01	0.				
18.	26	1.7000E+01	2.4000E+01	0.	0.	1.0000E+00	1.0000E+00	1.7500E+01	0.	1.7000E+01	0.				
19.	26	1.8000E+01	2.4000E+01	0.	0.	1.0000E+00	1.0000E+00	1.8500E+01	0.	1.8000E+01	0.				
20.	26	1.9000E+01	2.4000E+01	0.	0.	1.0000E+00	1.0000E+00	1.9500E+01	0.	1.9000E+01	0.				
21.	26	2.0000E+01	2.4000E+01	0.	0.	1.0000E+00	1.0000E+00	2.0500E+01	0.	2.0000E+01	-7.1054E-13				
22.	26	2.1000E+01	2.4000E+01	0.	0.	1.0000E+00	1.0000E+00	2.1500E+01	0.	2.1000E+01	0.				
23.	26	2.2000E+01	2.4000E+01	0.	0.	1.0000E+00	1.0000E+00	2.2500E+01	0.	2.2000E+01	0.				
24.	26	2.3000E+01	2.4000E+01	0.	0.	1.0000E+00	1.0000E+00	2.3500E+01	0.	2.3000E+01	-7.1054E-13				
25.	26	2.4000E+01	2.4000E+01	0.	0.	1.0000E+00	1.0000E+00	2.4500E+01	0.	2.4000E+01	-7.1054E-13				
26.	26	2.5000E+01	2.4000E+01	0.	0.	1.0000E+00	1.0000E+00	2.5500E+01	0.	2.5000E+01	0.				
27.	26	2.6000E+01	2.4000E+01	0.	0.	0.	0.	0.	0.	1.2750E+01	7.8431E-02				
1.	27	0.	2.5000E+01	0.	-7.4257E-05	1.0000E+00	1.0000E+00	5.0000E-01	0.	2.5000E-01	0.				
2.	27	1.0000E+00	2.5000E+01	0.	-9.9008E-05	1.0000E+00	1.0000E+00	1.5000E+00	0.	1.0000E+00	0.				
3.	27	2.0000E+00	2.5000E+01	0.	-9.9008E-05	1.0000E+00	1.0000E+00	2.5000E+00	0.	2.0000E+00	0.				
4.	27	3.0000E+00	2.5000E+01	0.	-9.9007E-05	1.0000E+00	1.0000E+00	3.5000E+00	0.	3.0000E+00	0.				
5.	27	4.0000E+00	2.5000E+01	0.	-9.9008E-05	1.0000E+00	1.0000E+00	4.5000E+00	0.	4.0000E+00	0.				
6.	27	5.0000E+00	2.5000E+01	0.	-9.9008E-05	1.0000E+00	1.0000E+00	5.5000E+00	0.	5.0000E+00	0.				
7.	27	6.0000E+00	2.5000E+01	0.	-9.9008E-05	1.0000E+00	1.0000E+00	6.5000E+00	0.	6.0000E+00	0.				
8.	27	7.0000E+00	2.5000E+01	0.	-9.9008E-05	1.0000E+00	1.0000E+00	7.5000E+00	0.	7.0000E+00	0.				
9.	27	8.0000E+00	2.5000E+01	0.	-4.7184E-05	1.0000E+00	1.0000E+00	8.5000E+00	0.	8.0000E+00	0.				
10.	27	9.0000E+00	2.5000E+01	0.	0.	1.0000E+00	1.0000E+00	9.5000E+00	0.	9.0000E+00	0.				
11.	27	1.0000E+01	2.5000E+01	0.	0.	1.0000E+00	1.0000E+00	1.0500E+01	0.	1.0000E+01	0.				
12.	27	1.1000E+01	2.5000E+01	0.	0.	1.0000E+00	1.0000E+00	1.1500E+01	0.	1.1000E+01	0.				
13.	27	1.2000E+01	2.5000E+01	0.	0.	1.0000E+00	1.0000E+00	1.2500E+01	0.	1.2000E+01	0.				
14.	27	1.3000E+01	2.5000E+01	0.	0.	1.0000E+00	1.0000E+00	1.3500E+01	0.	1.3000E+01	0.				
15.	27	1.4000E+01	2.5000E+01	0.	0.	1.0000E+00	1.0000E+00	1.4500E+01	0.	1.4000E+01	0.				
16.	27	1.5000E+01	2.5000E+01	0.	0.	1.0000E+00	1.0000E+00	1.5500E+01	0.	1.5000E+01	0.				
17.	27	1.6000E+01	2.5000E+01	0.	0.	1.0000E+00	1.0000E+00	1.6500E+01	0.	1.6000E+01	0.				
18.	27	1.7000E+01	2.5000E+01	0.	0.	1.0000E+00	1.0000E+00	1.7500E+01	0.	1.7000E+01	0.				
19.	27	1.8000E+01	2.5000E+01	0.	0.	1.0000E+00	1.0000E+00	1.8500E+01	0.	1.8000E+01	0.				
20.	27	1.9000E+01	2.5000E+01	0.	0.	1.0000E+00	1.0000E+00	1.9500E+01	0.	1.9000E+01	0.				
21.	27	2.0000E+01	2.5000E+01	0.	0.	1.0000E+00	1.0000E+00	2.0500E+01	0.	2.0000E+01	-7.1054E-13				
22.	27	2.1000E+01	2.5000E+01	0.	0.	1.0000E+00	1.0000E+00	2.1500E+01	0.	2.1000E+01	0.				
23.	27	2.2000E+01	2.5000E+01	0.	0.	1.0000E+00	1.0000E+00	2.2500E+01	0.	2.2000E+01	0.				
24.	27	2.3000E+01	2.5000E+01	0.	0.	1.0000E+00	1.0000E+00	2.3500E+01	0.	2.3000E+01	-7.1054E-13				
25.	27	2.4000E+01	2.5000E+01	0.	0.	1.0000E+00	1.0000E+00	2.4500E+01	0.	2.4000E+01	-7.1054E-13				
26.	27	2.5000E+01	2.5000E+01	0.	0.	1.0000E+00	1.0000E+00	2.5500E+01	0.	2.5000E+01	0.				
27.	27	2.6000E+01	2.5000E+01	0.	0.	0.	0.	0.	0.	1.2750E+01	7.8431E-02				
1.	28	0.	2.6000E+01	0.	-7.4257E-05	1.0000E+00	1.0000E+00	5.0000E-01	0.	2.5000E-01	0.				
2.	28	1.0000E+00	2.6000E+01	0.	-9.9008E-05	1.0000E+00	1.0000E+00	1.5000E+00	0.	1.0000E+00	0.				
3.	28	2.0000E+00	2.6000E+01	0.	-9.9008E-05	1.0000E+00	1.0000E+00	2.5000E+00	0.	2.0000E+00	0.				
4.	28	3.0000E+00	2.6000E+01	0.	-9.9007E-05	1.0000E+00	1.0000E+00	3.5000E+00	0.	3.0000E+00	0.				
5.	28	4.0000E+00	2.6000E+01	0.	-9.9008E-05	1.0000E+00	1.0000E+00	4.5000E+00	0.	4.0000E+00	0.				
6.	28	5.0000E+00	2.6000E+01	0.	-9.9008E-05	1.0000E+00	1.0000E+00	5.5000E+00	0.	5.0000E+00	0.				
7.	28	6.0000E+00	2.6000E+01	0.	-9.9008E-05	1.0000E+00	1.0000E+00	6.5000E+00	0.	6.0000E+00	0.				
8.	28	7.0000E+00	2.6000E+01	0.	-9.9008E-05	1.0000E+00	1.0000E+00	7.5000E+00	0.	7.0000E+00	0.				
9.	28	8.0000E+00	2.6000E+01	0.	-4.7184E-05	1.0000E+00	1.0000E+00	8.5000E+00	0.	8.0000E+00	0.				
10.	28	9.0000E+00	2.6000E+01	0.	0.	1.0000E+00	1.0000E+00	9.5000E+00	0.	9.0000E+00	0.				
11.	28	1.0000E+01	2.6000E+01	0.	0.	1.0000E+00	1.0000E+00	1.0500E+01	0.	1.0000E+01	0.				
12.	28	1.1000E+01	2.6000E+01	0.	0.	1.0000E+00	1.0000E+00	1.1500E+01	0.	1.1000E+01	0.				
13.	28	1.2000E+01	2.6000E+01	0.	0.	1.0000E+00	1.0000E+00	1.2500E+01	0.	1.2000E+01	0.				
14.	28	1.3000E+01	2.6000E+01	0.	0.	1.0000E+00	1.0000E+00	1.3500E+01	0.	1.3000E+01	0.				
15.	28	1.4000E+01	2.6000E+01	0.	0.	1.0000E+00	1.0000E+00	1.4500E+01	0.	1.4000E+01	0.				

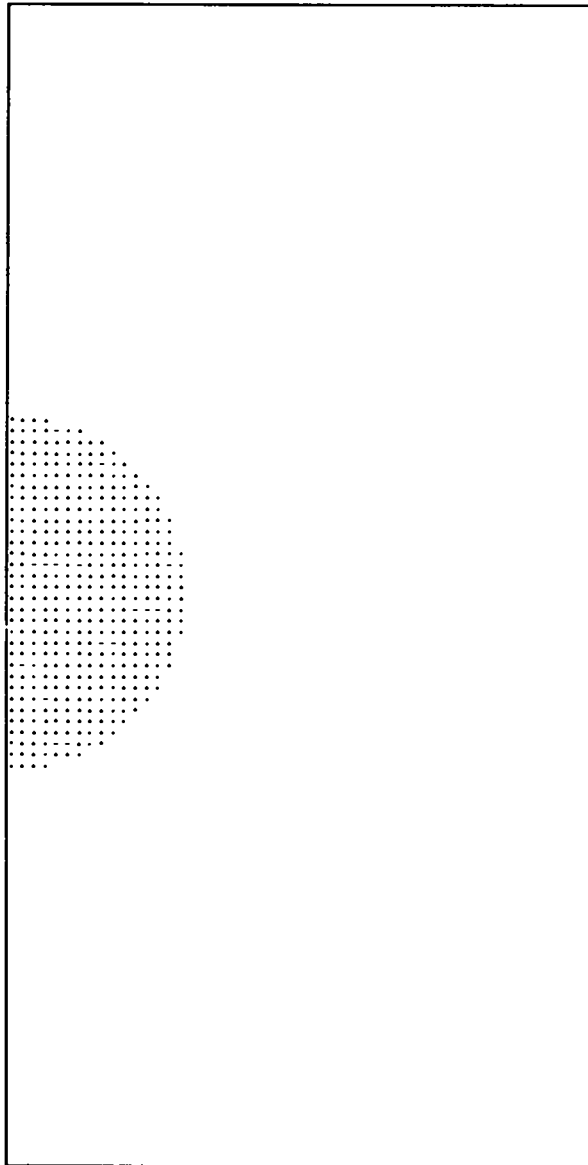

PARTICLES

PDR= 1.00000E+00 PDZ= 1.00000E+00 PXR= 2.60000E+01 PYB= 0. PYT= 5.20000E+01
T3AAA 1BA YAQUI PARTICLE-FLUID MOMENTUM EXCHANGE TEST. (T3AAA1GB 032272-3) 110872-1 T= 1.00000E+00 CYCLE= 7

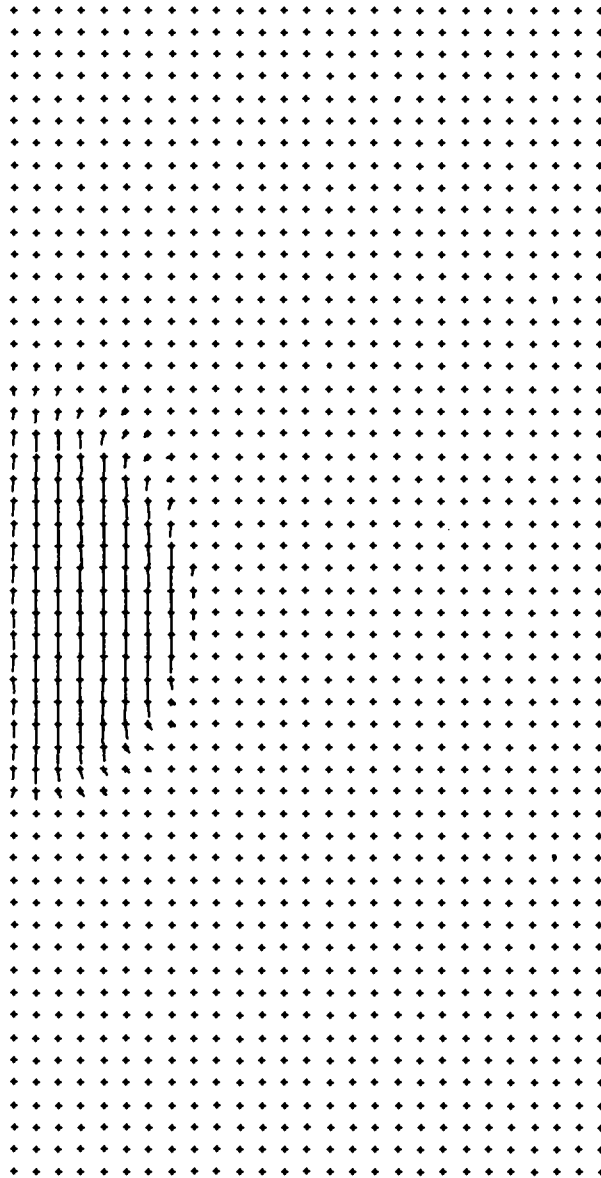

VELOCITY VECTORS

VMAX= 2.96442E-01

T3AAA 1BA YAQJ1 PARTICLE-FLUID MOMENTUM EXCHANGE TEST. (T3AAA1GB 032272-3)

110872-1

T= 1.00000E+00 CYCLE=

7

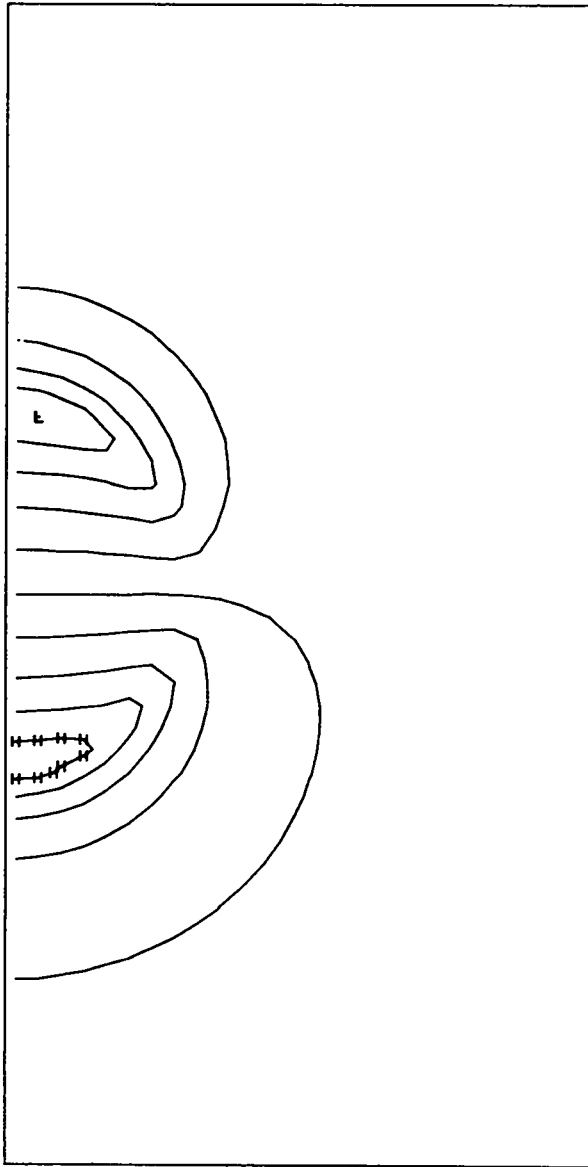

ISOPYCNTCS

MIN= 9.90697E-01 MAX= 1.00900E+00 L= 9.90697E-01 H= 1.00807E+00 DQ= 1.93073E-03
 T3AAA 18A YAQUI PARTICLE-FLUID MOMENTUM EXCHANGE TEST. (T3AAA168 032272-3) 110872-1 T= 1.00000E+00 CYCLE= 7

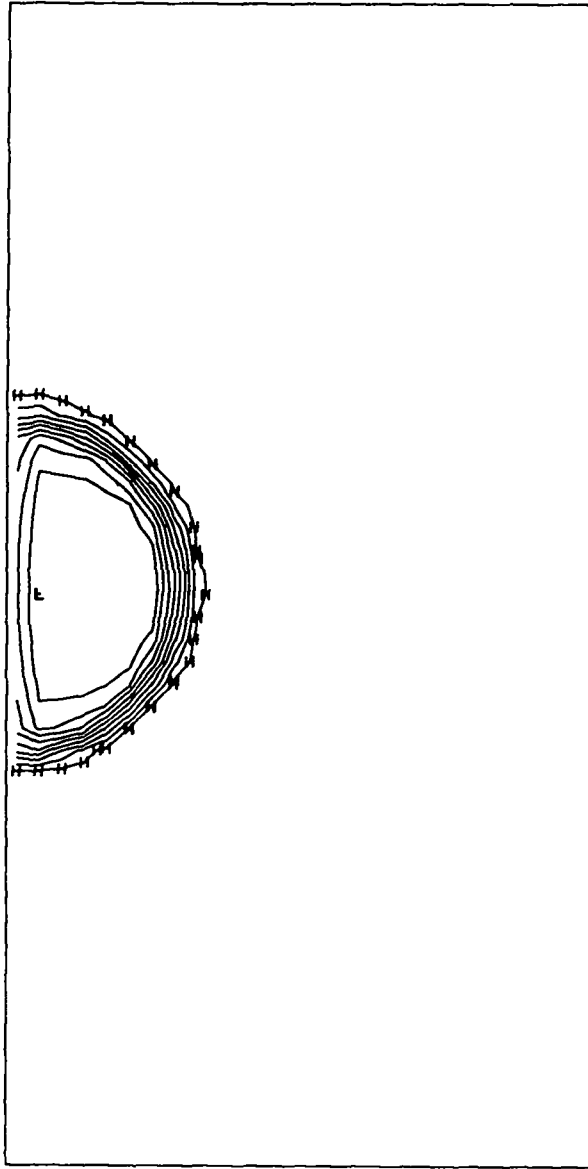

ISOTHERMS

MIN= 9.72363E-01 MAX= 1.00004E+00 L= 9.72363E-01 H= 9.98169E-01 DQ= 2.86729E-03
T3AAA 18A YAGUI PARTICLE-FLUID MOMENTUM EXCHANGE TEST. (T3AAA)GB 032272-3) 110872-1 T= 1.00000E+00 CYCLE= 7

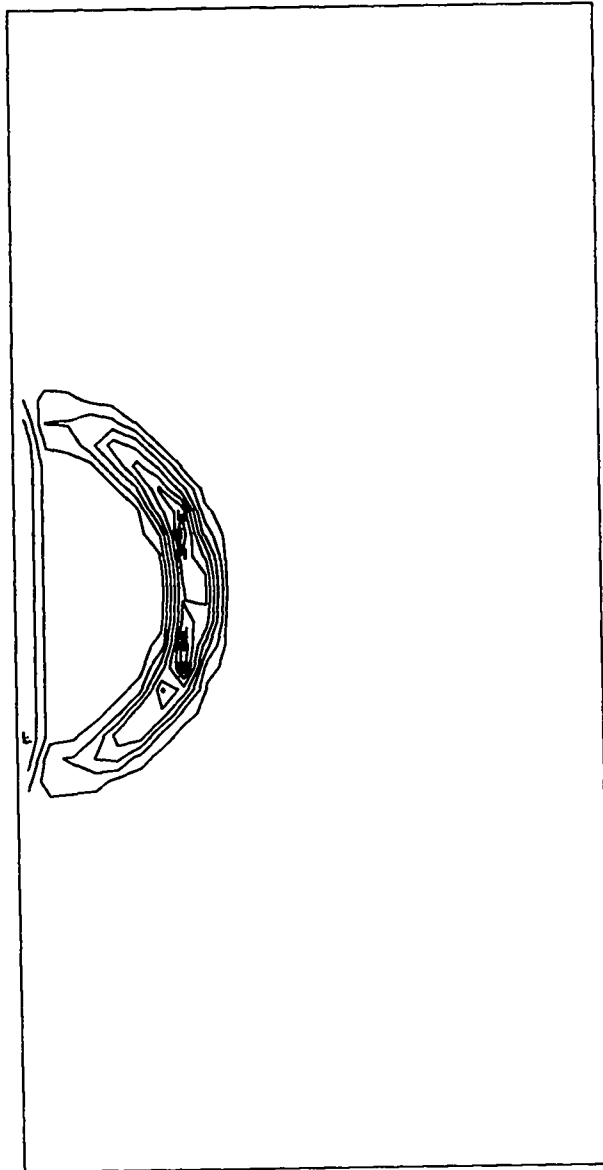

VORTICITY

MIN=-7.34092E-02 MAX= 2.2235E-01 L=-7.34092E-02 H= 1.93570E-01 DQ= 2.96644E-02
T3AAA 1BA YAQUI PARTICLE-FLUID MOMENTUM EXCHANGE TEST. (T3AAA1GB 032272-3) 110872-1 T= 1.00000E+00 CYCLE= 7

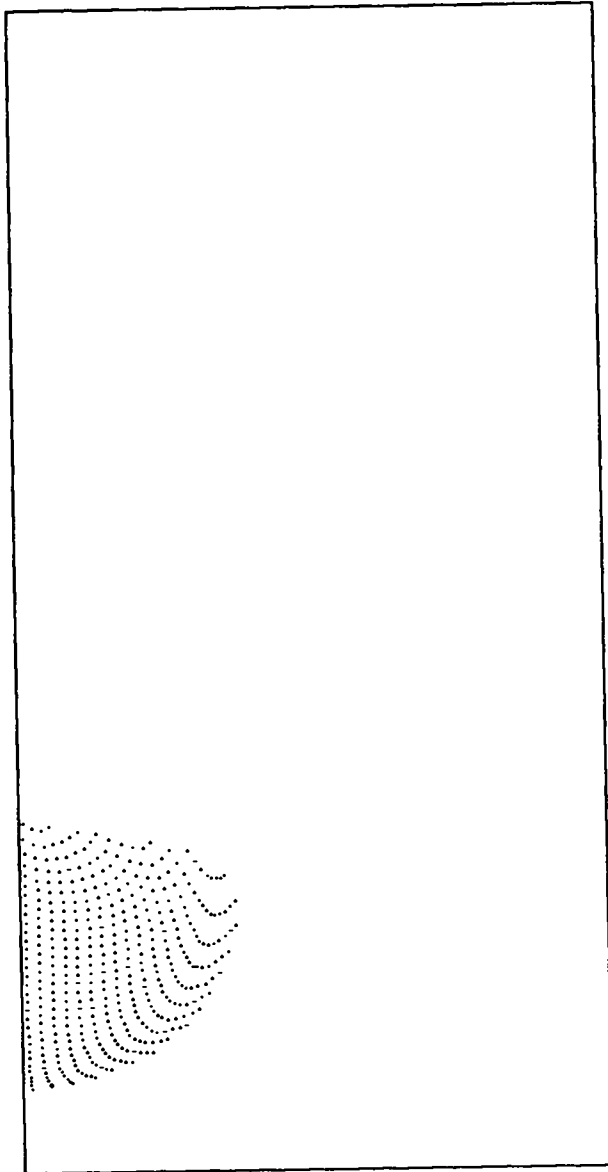

PARTICLES

PDR= 1.00000E+00 PDZ= 1.00000E+00 PXR= 2.60000E+01 PYB= 0. PYT= 5.20000E+01
T3AAA 18A YAGUI PARTICLE-FLUID MOMENTUM EXCHANGE TEST. IT3AAA1GB 032272-31 110872-1 T= 9.00000E+00 C\CLE= 232

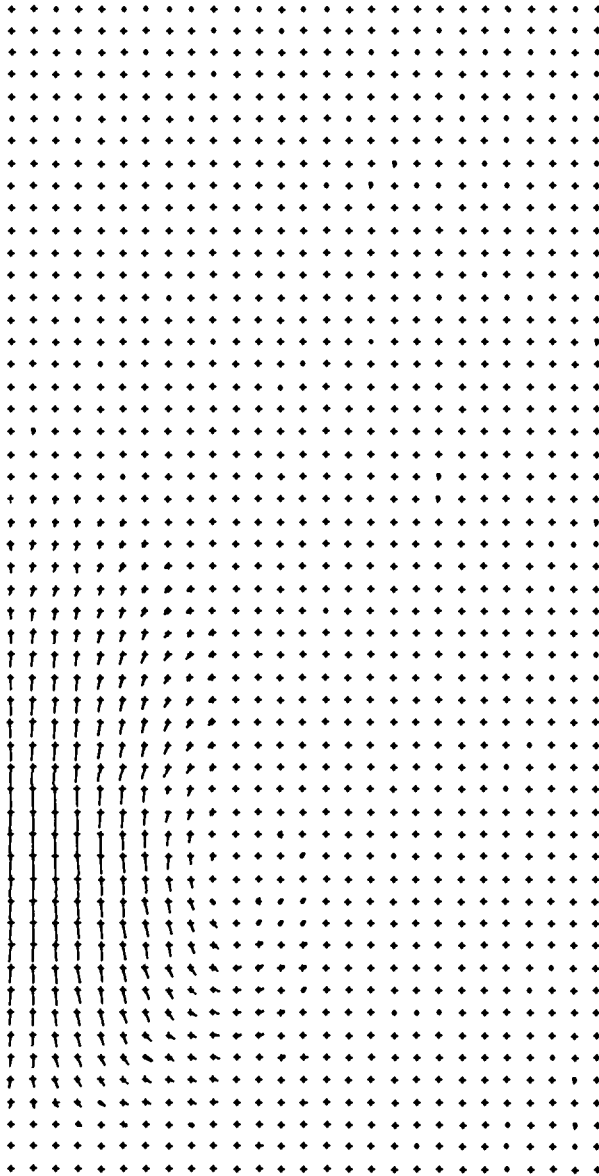

VELOCITY VECTORS

VMAX= 2.93061E+00

T3AAA 1BA YAGUI PARTICLE-FLUID MOMENTUM EXCHANGE TEST. (T3AAA1GB 02272-3)

110872-)

T= 9.00000E+00 CYCLE 232

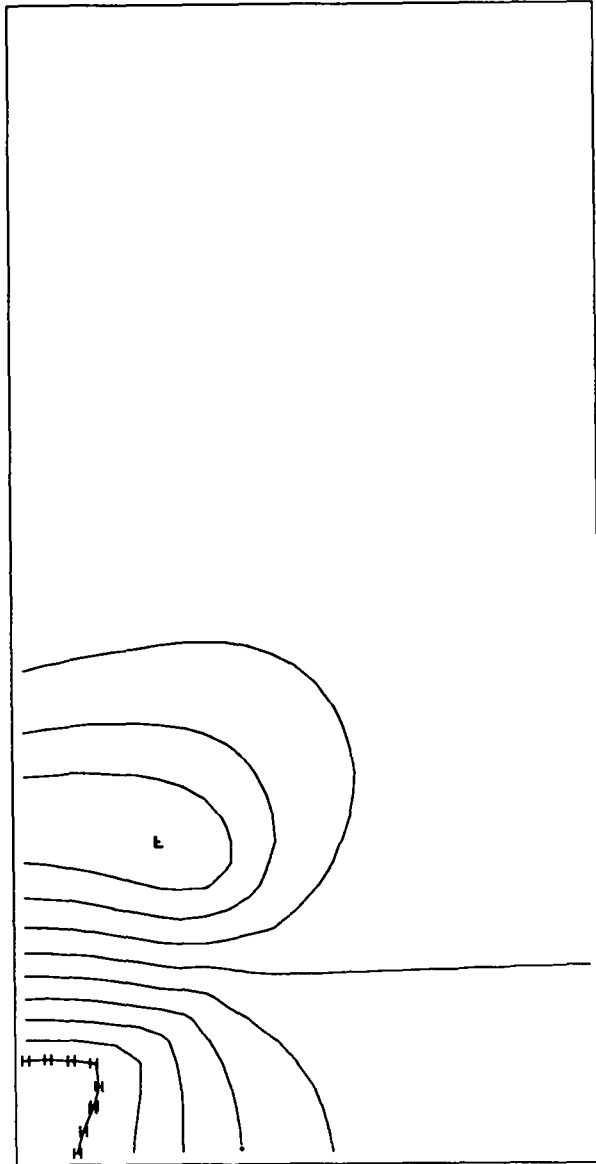

15OPYCNICS

MIN= 9.72275E-01 MAX= 1.04901E+00 L= 9.72275E-01 H= 1.04223E+00 DQ= 7.77298E-03
T3AAA 18A YAQUI PART)CLE-FLUID MOMENTUM EXCHANGE TEST. (T3AAA1GB 032272-3) 110872-1 T= 9.00000E+00 CYCLE= 232

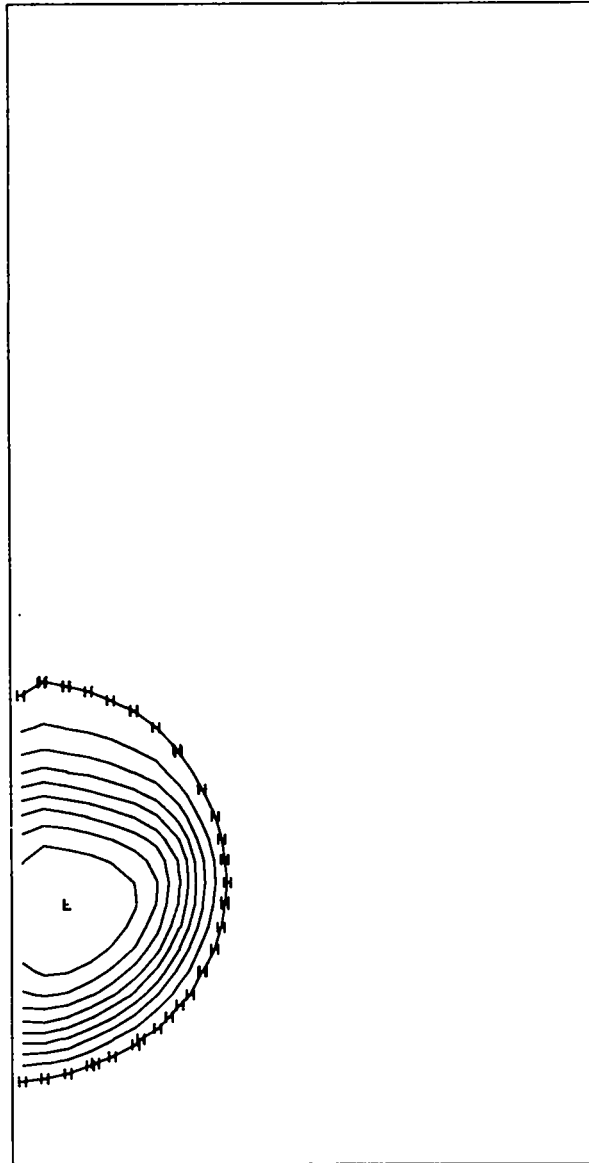

ISOTHERMS

MIN=-7.32911E+00 MAX= 1.22158E+00 L=-7.32911E+00 H= 3.67413E-01 DQ= 8.55170E-01
T3AAA 18A YAQUI PARTICLE-FLUID MOMENTUM EXCHANGE TEST. (T3AAA1GB 032272-3) 110872-1 T= 9.00000E+00 CYCLE= 232

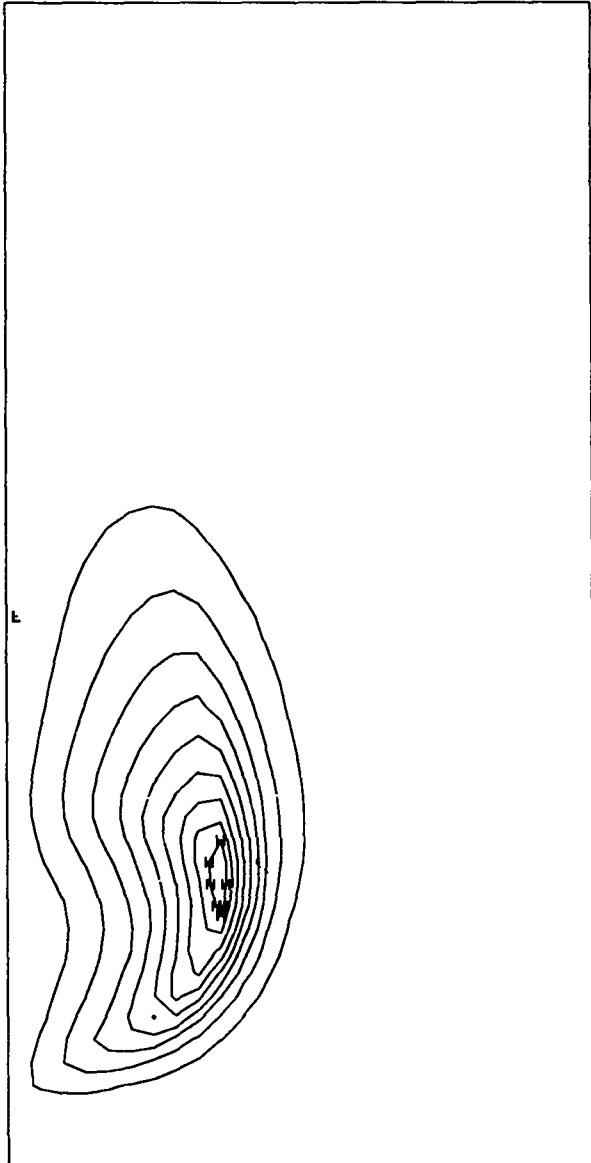

VORTICITY

MIN=-2.39303E-02 MAX= 9.72045E-01 L=-2.39303E-02 H= 8.73348E-01 DQ= 9.96976E-02
T3AAA 18A YAQUI PARTICLE-FLUID MOMENTUM EXCHANGE TEST. (T3AAA)GB D32272-31 1:0872-1 T= 9.00000E+00 CYCLE= 232

T3AAA 18A YAQUI PARTICLE-FLUID MOMENTUM EXCHANGE TEST. (T3AAAIG8 032272-31										110872-1		T= 9.0000E+00		CYCLE= 232	
T	J	X	Y	U	V	SIE	RHO	VOL	D	M	P				
8.	26	7.0000E+00	2.4000E+01	-5.1537E-01	-7.8591E-01	1.0532E+00	9.9707E-01	7.5000E+00	-2.6219E-03	6.9759E+00	-2.9254E-01				
9.	26	8.0000E+00	2.4000E+01	-5.3391E-01	-5.2959E-01	1.0449E+00	9.9689E-01	8.5000E+00	-2.5925E-03	7.9711E+00	-3.1083E-01				
10.	26	9.0000E+00	2.4000E+01	-5.2592E-01	-2.8341E-01	1.0249E+00	9.9680E-01	9.5000E+00	-2.3834E-03	8.9668E+00	-3.1973E-01				
11.	26	1.0000E+01	2.4000E+01	-4.9208E-01	-9.2084E-02	1.0145E+00	9.9680E-01	1.0500E+01	-2.1566E-03	9.9633E+00	-3.2023E-01				
12.	26	1.1000E+01	2.4000E+01	-4.4172E-01	4.0406E-02	1.0114E+00	9.9688E-01	1.1500E+01	-1.8838E-03	1.0961E+01	-3.1241E-01				
13.	26	1.2000E+01	2.4000E+01	-3.8481E-01	1.2368E-01	1.0081E+00	9.9700E-01	1.2500E+01	-1.6101E-03	1.1959E+01	-3.0029E-01				
14.	26	1.3000E+01	2.4000E+01	-3.2845E-01	1.7186E-01	1.0057E+00	9.9717E-01	1.3500E+01	-1.3199E-03	1.2959E+01	-2.8300E-01				
15.	26	1.4000E+01	2.4000E+01	-2.7653E-01	1.9782E-01	1.0040E+00	9.9735E-01	1.4500E+01	-1.0566E-03	1.3959E+01	-2.6499E-01				
16.	26	1.5000E+01	2.4000E+01	-2.3053E-01	2.1089E-01	1.0028E+00	9.9755E-01	1.5500E+01	-8.1772E-04	1.4960E+01	-2.4477E-01				
17.	26	1.6000E+01	2.4000E+01	-1.9098E-01	2.1669E-01	1.0019E+00	9.9774E-01	1.6500E+01	-6.0852E-04	1.5961E+01	-2.2555E-01				
18.	26	1.7000E+01	2.4000E+01	-1.5721E-01	2.1866E-01	1.0014E+00	9.9794E-01	1.7500E+01	-4.6446E-04	1.6962E+01	-2.0650E-01				
19.	26	1.8000E+01	2.4000E+01	-1.2864E-01	2.1852E-01	1.0010E+00	9.9810E-01	1.8500E+01	-2.9468E-04	1.7964E+01	-1.8744E-01				
20.	26	1.9000E+01	2.4000E+01	-1.0426E-01	2.1746E-01	1.0008E+00	9.9826E-01	1.9500E+01	-1.9709E-04	1.8965E+01	-1.7440E-01				
21.	26	2.0000E+01	2.4000E+01	-8.3362E-02	2.1595E-01	1.0006E+00	9.9838E-01	2.0500E+01	-6.9868E-05	1.9967E+01	-1.6159E-01				
22.	26	2.1000E+01	2.4000E+01	-6.5270E-02	2.1434E-01	1.0005E+00	9.9848E-01	2.1500E+01	-2.2380E-05	2.0968E+01	-1.5157E-01				
23.	26	2.2000E+01	2.4000E+01	-4.9414E-02	2.1286E-01	1.0004E+00	9.9857E-01	2.2500E+01	-3.5902E-05	2.1969E+01	-1.4326E-01				
24.	26	2.3000E+01	2.4000E+01	-3.5348E-02	2.1155E-01	1.0004E+00	9.9862E-01	2.3500E+01	-6.2106E-05	2.2969E+01	-1.3776E-01				
25.	26	2.4000E+01	2.4000E+01	-2.2633E-02	2.1054E-01	1.0004E+00	9.9866E-01	2.4500E+01	-7.6929E-05	2.3969E+01	-1.3387E-01				
26.	26	2.5000E+01	2.4000E+01	-1.0954E-02	2.0980E-01	1.0003E+00	9.9868E-01	2.5500E+01	-8.7703E-05	2.4968E+01	-1.3237E-01				
27.	26	2.6000E+01	2.4000E+01	0.	2.0939E-01	0.	-1.8170E-07	0.	0.	1.2734E+01	7.8530E-02				
1.	27	0.	2.5000E+01	0.	-1.4403E+00	1.1846E+00	1.0006E-01	5.0000E-01	-3.4404E-03	2.5002E+01	5.9747E-02				
2.	27	1.0000E+00	2.5000E+01	-8.993E-02	-1.4618E+00	1.0378E+00	1.0001E+00	1.5000E+00	-1.6890E-03	9.9972E-01	1.2199E-02				
3.	27	2.0000E+00	2.5000E+01	-1.7724E-01	-1.4288E+00	1.0479E+00	9.9975E-01	2.5000E+00	-1.7619E-03	1.9987E+00	-2.5003E-02				
4.	27	3.0000E+00	2.5000E+01	-2.6015E-01	-1.3528E+00	1.0401E+00	9.9940E-01	3.5000E+00	-1.8811E-03	2.9970E+00	-6.0391E-02				
5.	27	4.0000E+00	2.5000E+01	-3.3588E-01	-1.2374E+00	1.0375E+00	9.9904E-01	4.5000E+00	-2.0103E-03	3.9946E+00	-9.6021E-02				
6.	27	5.0000E+00	2.5000E+01	-4.0168E-01	-1.0853E+00	1.0399E+00	9.9869E-01	5.5000E+00	-2.1383E-03	4.9915E+00	-1.3140E-01				
7.	27	6.0000E+00	2.5000E+01	-4.5440E-01	-9.0021E-01	1.0452E+00	9.9835E-01	6.5000E+00	-2.2377E-03	5.9879E+00	-1.6497E-01				
8.	27	7.0000E+00	2.5000E+01	-4.9029E-01	-6.8854E-01	1.0466E+00	9.9804E-01	7.5000E+00	-2.3078E-03	6.9838E+00	-1.9560E-01				
9.	27	8.0000E+00	2.5000E+01	-5.0544E-01	-4.6219E-01	1.0434E+00	9.9779E-01	8.5000E+00	-2.2432E-03	7.9796E+00	-2.2078E-01				
10.	27	9.0000E+00	2.5000E+01	-4.9601E-01	-2.5217E-01	1.0189E+00	9.9761E-01	9.5000E+00	-2.1057E-03	8.9754E+00	-2.3895E-01				
11.	27	1.0000E+01	2.5000E+01	-4.6399E-01	-8.9856E-02	1.0131E+00	9.9751E-01	1.0500E+01	-1.9039E-03	9.9718E+00	-2.4882E-01				
12.	27	1.1000E+01	2.5000E+01	-4.1811E-01	-2.4101E-02	1.0100E+00	9.9747E-01	1.1500E+01	-1.6979E-03	1.0969E+01	-2.5274E-01				
13.	27	1.2000E+01	2.5000E+01	-3.6842E-01	9.7761E-02	1.0070E+00	9.9751E-01	1.2500E+01	-1.4725E-03	1.1967E+01	-2.4987E-01				
14.	27	1.3000E+01	2.5000E+01	-3.1508E-01	1.4255E-01	1.0050E+00	9.9756E-01	1.3500E+01	-1.2443E-03	1.2965E+01	-2.4377E-01				
15.	27	1.4000E+01	2.5000E+01	-2.6731E-01	1.6877E-01	1.0035E+00	9.9766E-01	1.4500E+01	-1.0447E-03	1.3964E+01	-2.3362E-01				
16.	27	1.5000E+01	2.5000E+01	-2.2482E-01	1.8379E-01	1.0024E+00	9.9777E-01	1.5500E+01	-8.3634E-04	1.4964E+01	-2.2262E-01				
17.	27	1.6000E+01	2.5000E+01	-1.8767E-01	1.9236E-01	1.0017E+00	9.9790E-01	1.6500E+01	-6.9411E-04	1.5964E+01	-2.0992E-01				
18.	27	1.7000E+01	2.5000E+01	-1.5574E-01	1.9704E-01	1.0012E+00	9.9803E-01	1.7500E+01	-5.3876E-04	1.6964E+01	-1.9740E-01				
19.	27	1.8000E+01	2.5000E+01	-1.2828E-01	1.9945E-01	1.0009E+00	9.9814E-01	1.8500E+01	-4.4414E-04	1.7965E+01	-1.8562E-01				
20.	27	1.9000E+01	2.5000E+01	-1.0464E-01	2.0050E-01	1.0007E+00	9.9825E-01	1.9500E+01	-3.2336E-04	1.8966E+01	-1.7473E-01				
21.	27	2.0000E+01	2.5000E+01	-8.4140E-02	2.0077E-01	1.0006E+00	9.9835E-01	2.0500E+01	-2.4078E-04	1.9966E+01	-1.6526E-01				
22.	27	2.1000E+01	2.5000E+01	-6.6169E-02	2.0061E-01	1.0005E+00	9.9842E-01	2.1500E+01	-1.7353E-04	2.0967E+01	-1.5751E-01				
23.	27	2.2000E+01	2.5000E+01	-5.0313E-02	2.0021E-01	1.0004E+00	9.9848E-01	2.2500E+01	-1.2993E-04	2.1967E+01	-1.5175E-01				
24.	27	2.3000E+01	2.5000E+01	-3.6075E-02	1.9977E-01	1.0004E+00	9.9853E-01	2.3500E+01	-1.0232E-04	2.2967E+01	-1.4723E-01				
25.	27	2.4000E+01	2.5000E+01	-2.3158E-02	1.9932E-01	1.0004E+00	9.9855E-01	2.4500E+01	-8.9065E-05	2.3966E+01	-1.4468E-01				
26.	27	2.5000E+01	2.5000E+01	-1.1214E-02	1.9895E-01	1.0003E+00	9.9857E-01	2.5500E+01	-8.6277E-05	2.4965E+01	-1.4348E-01				
27.	27	2.6000E+01	2.5000E+01	0.	1.9868E-01	0.	-1.0315E-07	0.	0.	1.2732E+01	7.8548E-02				
1.	28	0.	2.6000E+01	0.	-1.2696E+00	1.2148E+00	1.0013E+00	5.0000E-01	-2.8902E-03	2.5024E-01	1.2918E-01				
2.	28	1.0000E+00	2.6000E+01	-8.5059E-02	-1.2895E+00	1.0890E+00	1.0009E+00	1.5000E+00	-1.4587E-03	1.0006E+00	8.7659E-02				
3.	28	2.0000E+00	2.6000E+01	-1.6812E-01	-1.2607E+00	1.0877E+00	1.0005E+00	2.5000E+00	-1.5278E-03	2.0006E+00	5.3658E-02				
4.	28	3.0000E+00	2.6000E+01	-2.4683E-01	-1.1924E+00	1.0699E+00	1.0002E+00	3.5000E+00	-1.6280E-03	2.9998E+00	1.9792E-02				
5.	28	4.0000E+00	2.6000E+01	-3.1839E-01	-1.0883E+00	1.0563E+00	9.9984E-01	4.5000E+00	-1.7367E-03	3.9984E+00	-1.5583E-02				
6.	28	5.0000E+00	2.6000E+01	-3.8003E-01	-9.5134E-01	1.0478E+00	9.9948E-01	5.5000E+00	-1.8330E-03	4.9962E+00	-5.1701E-02				
7.	28	6.0000E+00	2.6000E+01	-4.2866E-01	-7.8571E-01	1.0430E+00	9.9913E-01	6.5000E+00	-1.9022E-03	5.9934E+00	-8.7385E-02				
8.	28	7.0000E+00	2.6000E+01	-4.6076E-01	-5.9844E-01	1.0374E+00	9.9880E-01	7.5000E+00	-1.9755E-03	6.9900E+00	-1.2048E-01				
9.	28	8.0000E+00	2.6000E+01	-4.7278E-01	-4.0111E-01	1.0259E+00	9.9849E-01	8.5000E+00	-1.8973E-03	7.9862E+00	-1.5130E-01				
10.	28	9.0000E+00	2.6000E+01	-4.6220E-01	-2.2384E-01	1.0152E+00	9.9825E-01	9.5000E+00	-1.8032E-03	8.9823E+00	-1.7478E-01				
11.	28	1.0000E+01	2.6000E+01	-4.3233E-01	-8.6694E-02	1.0118E+00	9.9808E-01	1.0500E+01	-1.6512E-03	9.9786E+00	-1.9242E-01				
12.	28	1.1000E+01	2.6000E+01	-3.9067E-01	1.0791E-02	1.0086E+00	9.9797E-01	1.1500E+01	-1.5047E-03	1.0975E+01	-2.0309E-01				
13.	28	1.2000E+01	2.6000E+01	-3.4426E-01	7.5636E-02	1.0060E+00	9.9791E-01	1.2500E+01	-1.3296E-03	1.1973E+01	-2.0893E-01				
14.	28	1.3000E+01	2.6000E+01	-2.9790E-01	1.1699E-01	1.0042E+00	9.9790E-01	1.3500E+01	-1.1759E-03	1.2970E+01	-2.0960E-01				
15.	28	1.4000E+01	2.6000E+01	-2.5471E-01	1.4292E-01	1.0029E+00	9.9793E-01	1.4500E+01	-1.0056E-03	1.3969E+01	-2.0747E-01				

APPENDIX A
FLOW DIAGRAM FOR THE YAQUI PROGRAM

PROGRAM
YAQUI

JOB STARTS HERE

0,0 OVERLAY

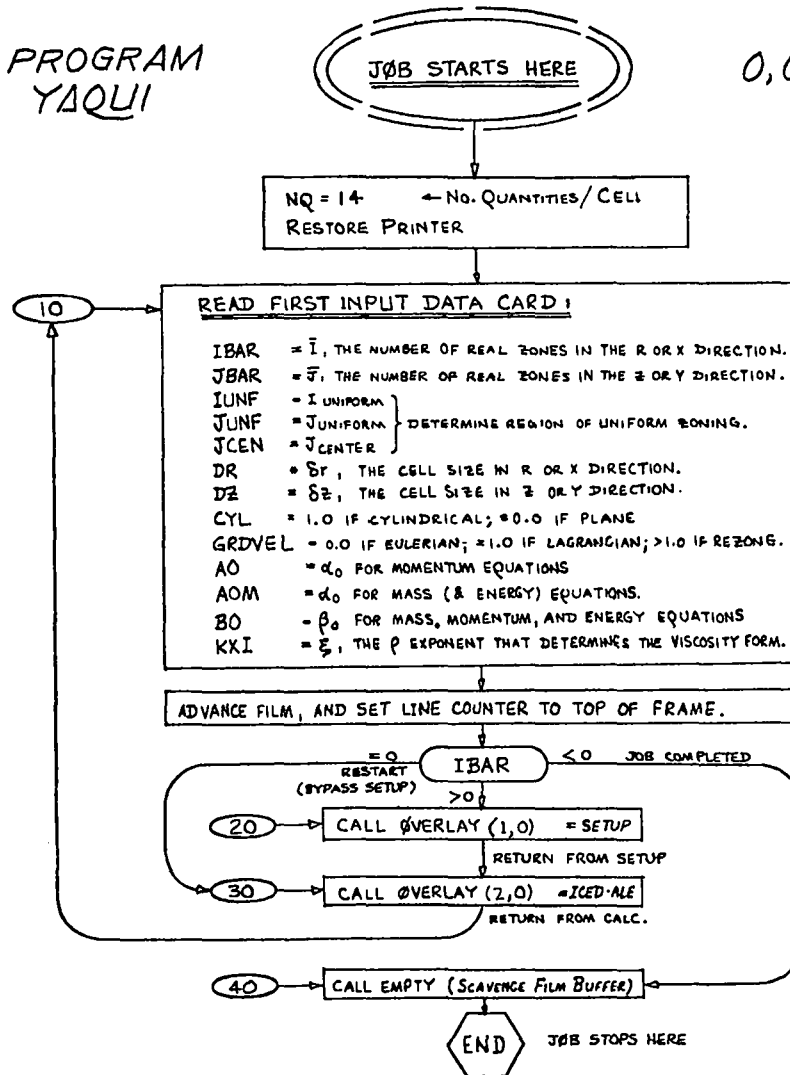
AMSDEN
72

0,0 SUBROUTINES - SCM/LCM 3-ROW BUFFERING:

2

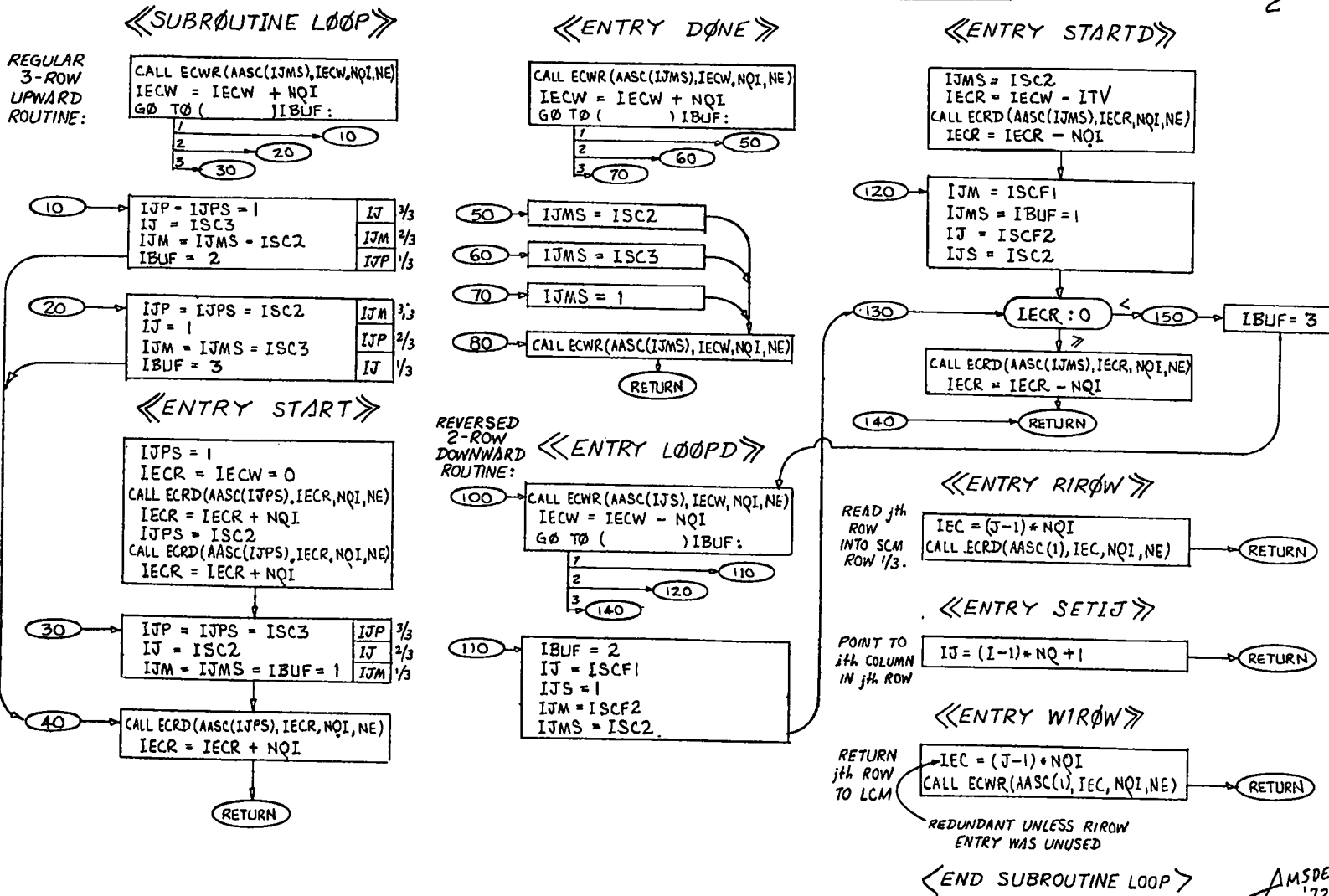

AMSDEN '72

0,0 SUBROUTINES - SETUP PLOTS & PARTICLE GRID:

3

《SUBROUTINE FILMCØ》

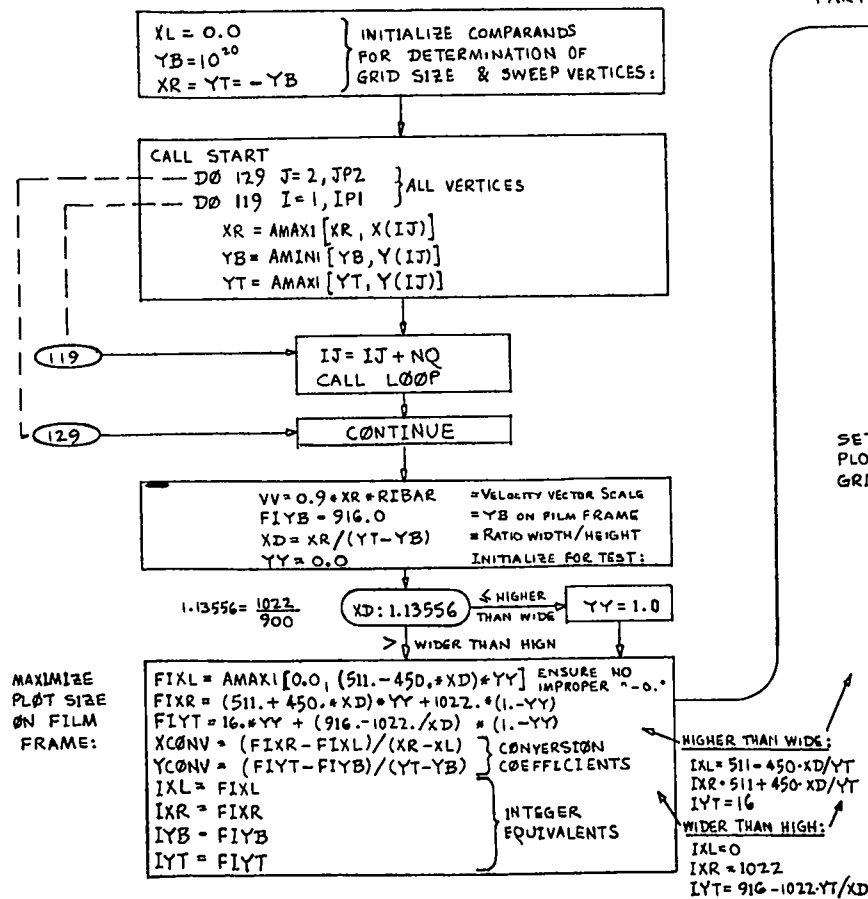

PARTICLE GRID & PARTICLE PLOT SETUP:

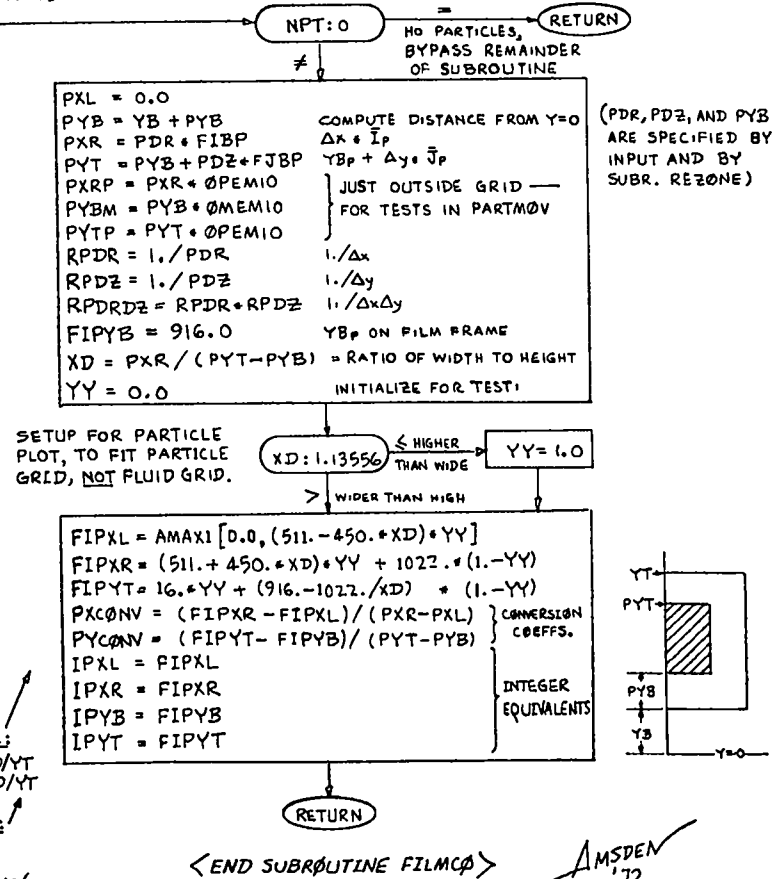

1,0 OVERLAY - THE PROBLEM SETUP:

4

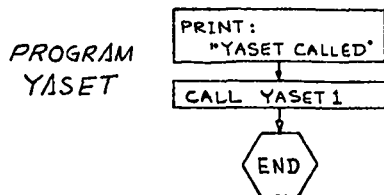

«SUBROUTINE YASET1»

READ IDENTIFICATION CARD
READ NEXT 6 INPUT-DATA CARDS:

MU	μ	} VISCOSITY COEFFICIENTS
LAM	λ	
OM	ω	} RELAXATION PARAMETER
EPS	ϵ	
GR	g_x	} GRAVITY COMPONENTS
GZ	g_z	
ASQ		} COEFFICIENTS FOR STIFFENED GAS EQUATION OF STATE
RON		
GMI		
FREZ		VARIABLE ZONING COEFF.
YB	Y_b	Y OF $j=2$
REZY0	Y_0	Y OF BUBBLE CENTER
REZUE	u_0	} GRID EXPANSION & TRANSLATION VELS.
REZVE	v_0	
REZVT	v_T	FOR REZONE
REZR0N	p_0	p AT Y_0
REZSIE	I	AMBIENT
IBP	I_p	} PARTICLE GRID PARAMETERS
JBP	J_p	
PDR	Δx	
PDZ	Δy	
PYB	Y_{Bp}	
GZP	g_{Zp}	
IMOMX		MOMENTUM EXCHANGE
T	t_0	
DT	δt	
TZ0MD	$I=20$	CP TAPE DUMP
TLIMD	I	TIME LIMIT DUMP
TWFIN		TIME WHEN TO FINISH
LPR		PRINT CONTROL
ICOLOR	I	COLOR PLOT
5 DT0(1-10)		} CONTROLS OUTPUT INTERVALS
6 DT0C(1-10)		

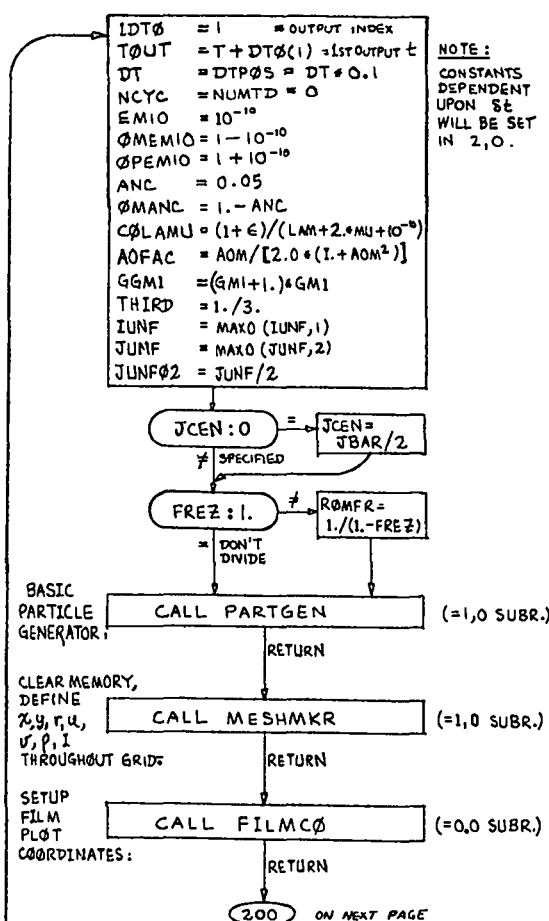
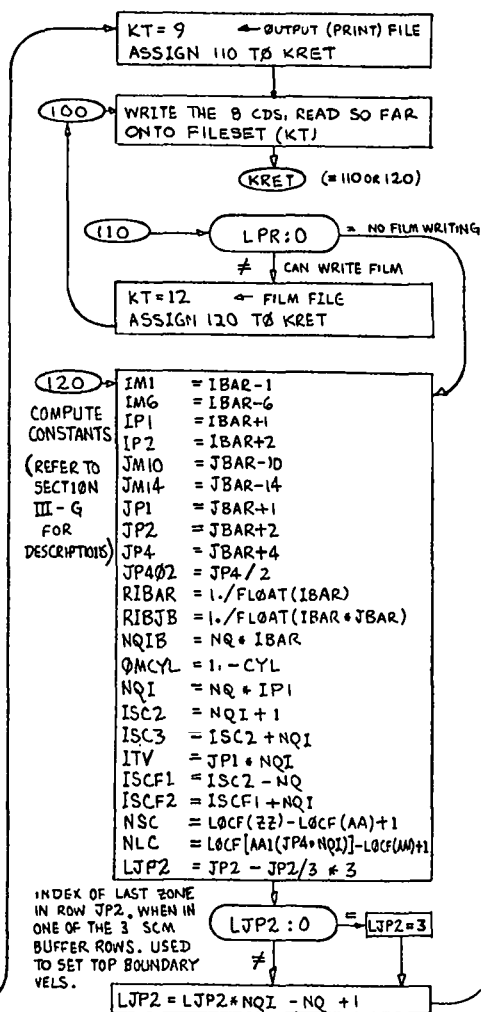

AMSDEN '72

1.0 SUBROUTINES - THE PROBLEM SETUP:

«SUBROUTINE YASET1» CONTINUED:

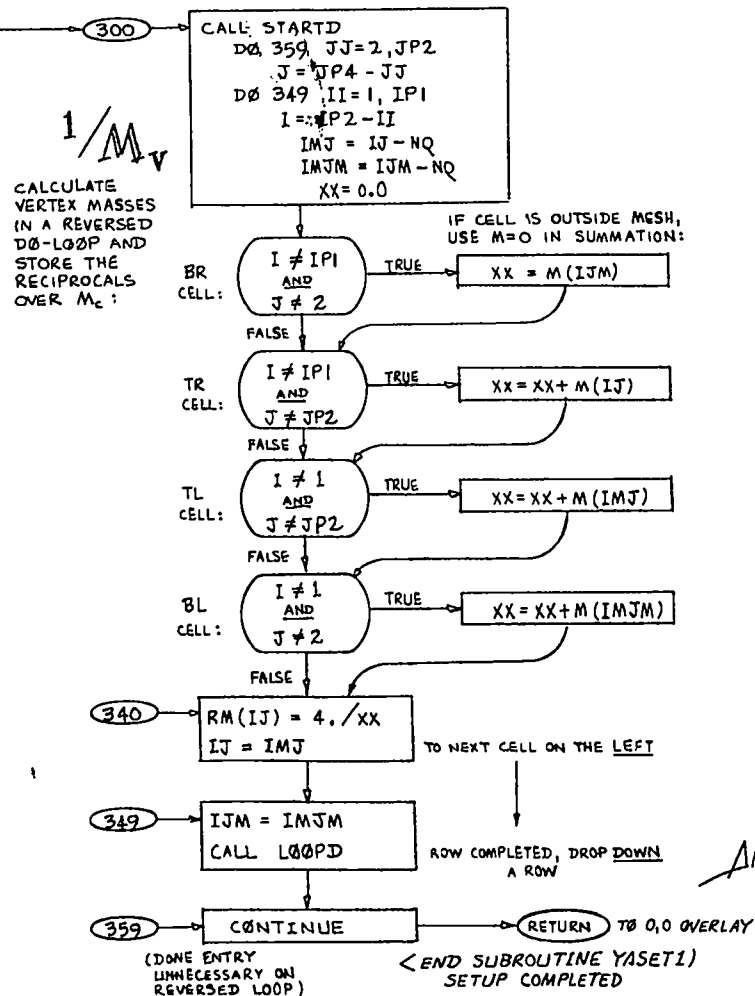
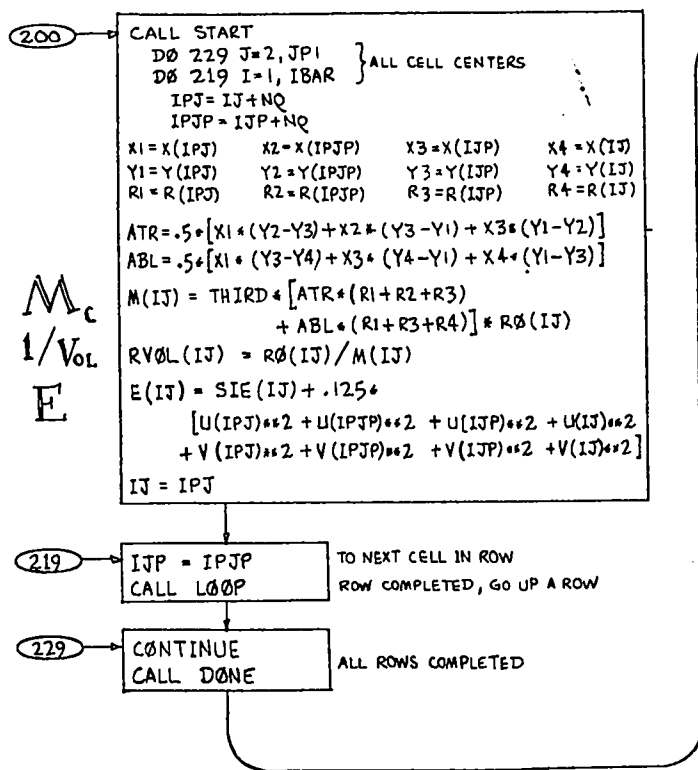

1.0 SUBROUTINES - PARTICLE GENERATOR:

6

«SUBROUTINE PARTGEN»

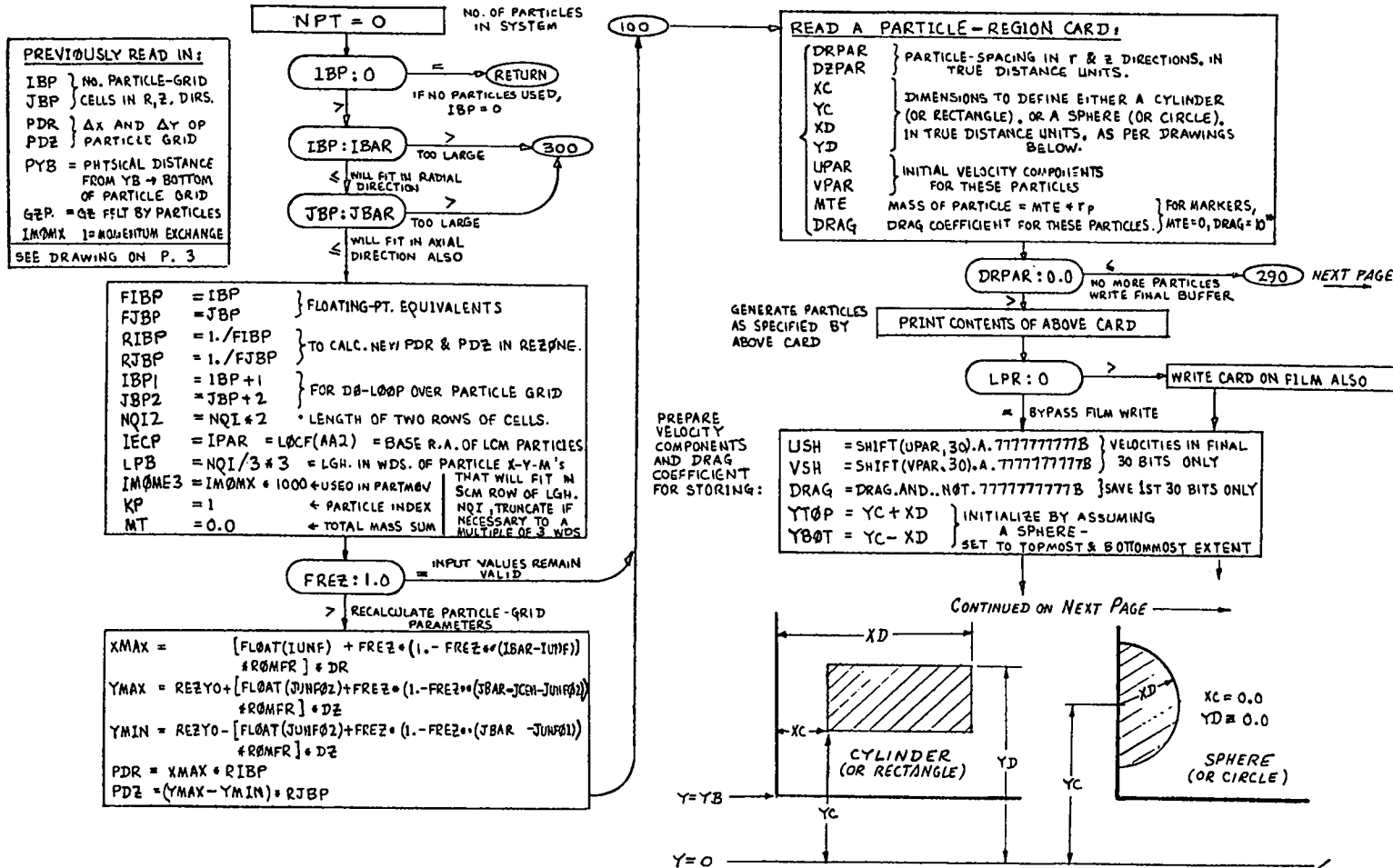

1,0 SUBROUTINES - PARTICLE GENERATOR (CONT'D):

7

《《SUBROUTINE PARTGEN》》 CONTINUED:

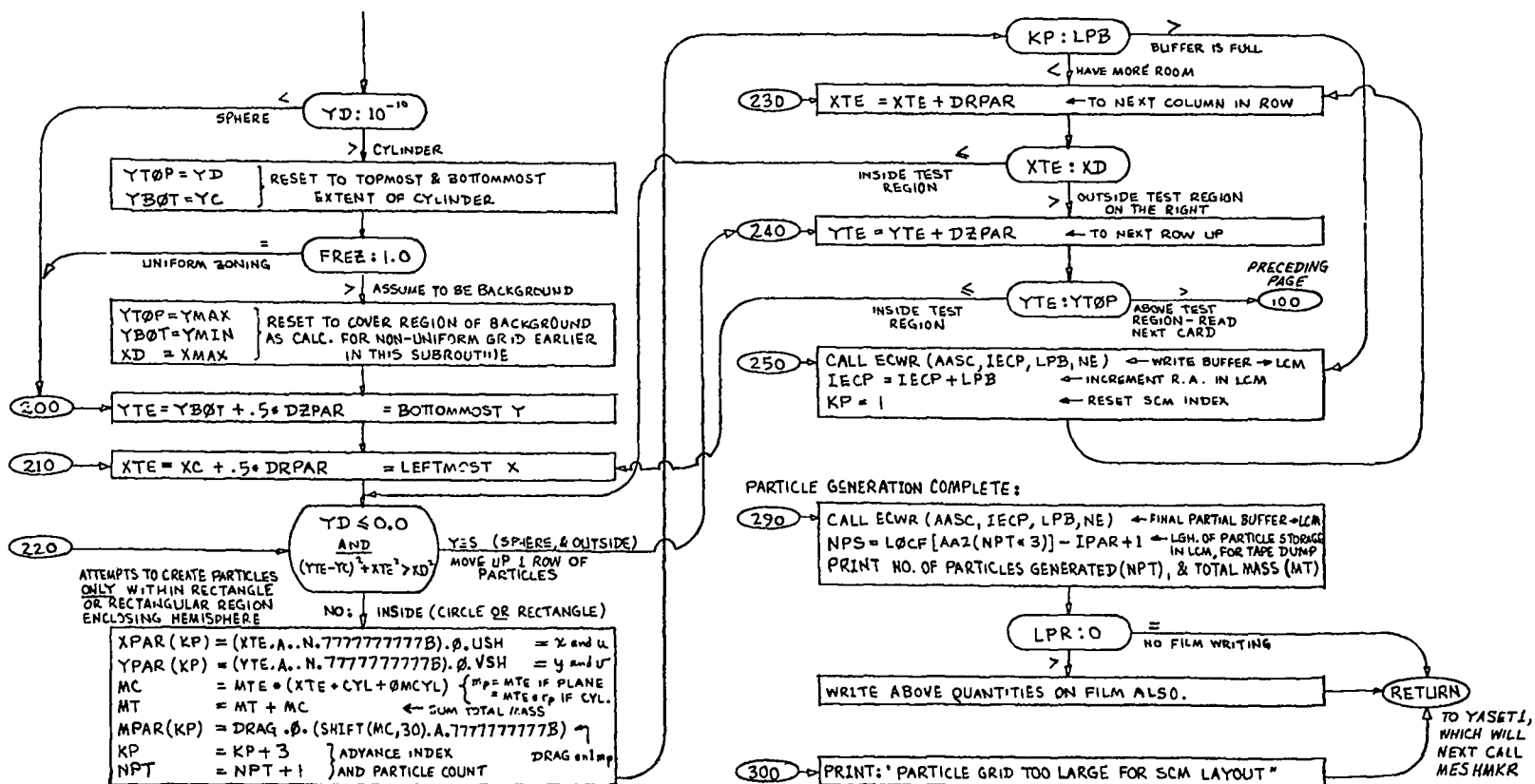

《《END SUBROUTINE PARTGEN》》

AMSDEN
72

1.0 SUBROUTINES - MESH & FLUID GENERATOR:

«SUBROUTINE MESHMKR»

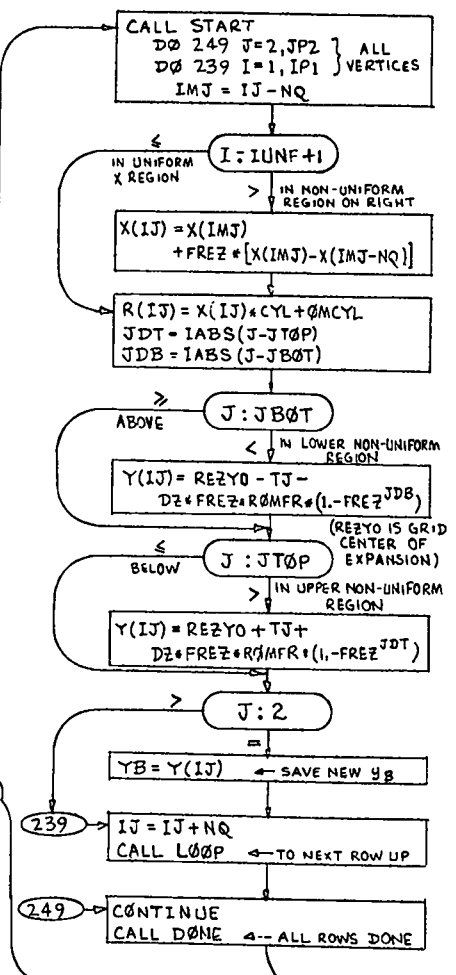
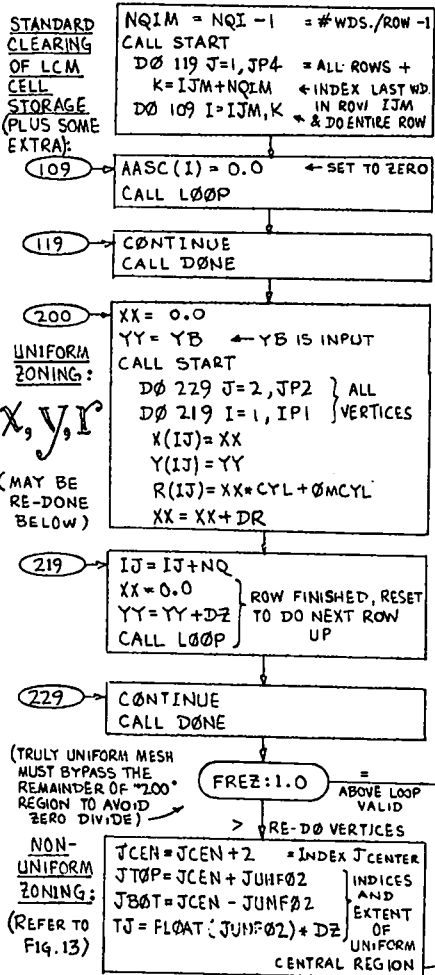

BASIC FLUID GENERATOR:

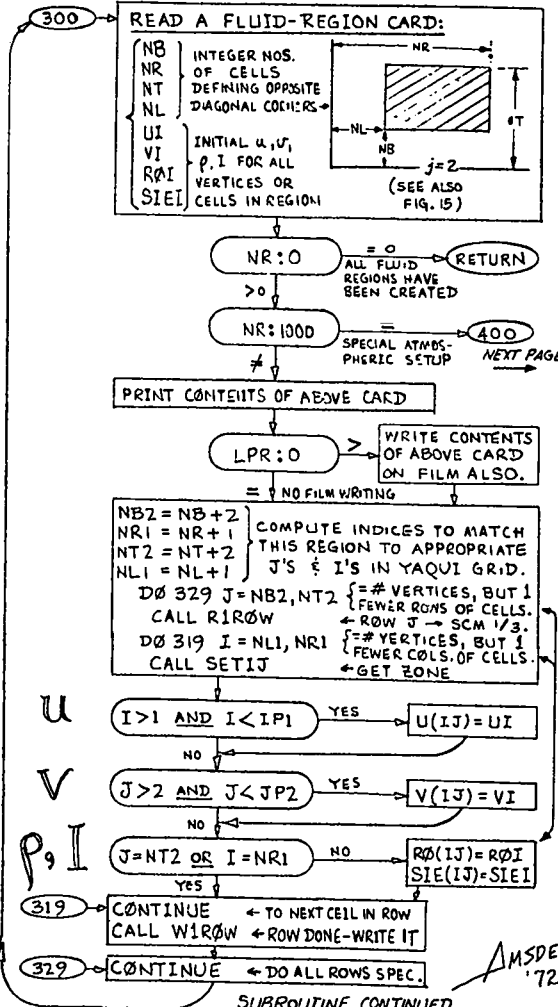

1,0 SUBROUTINES - MESH & FLUID GENERATOR (CONT'D):

9

«SUBROUTINE MESHMKR» CONTINUED:

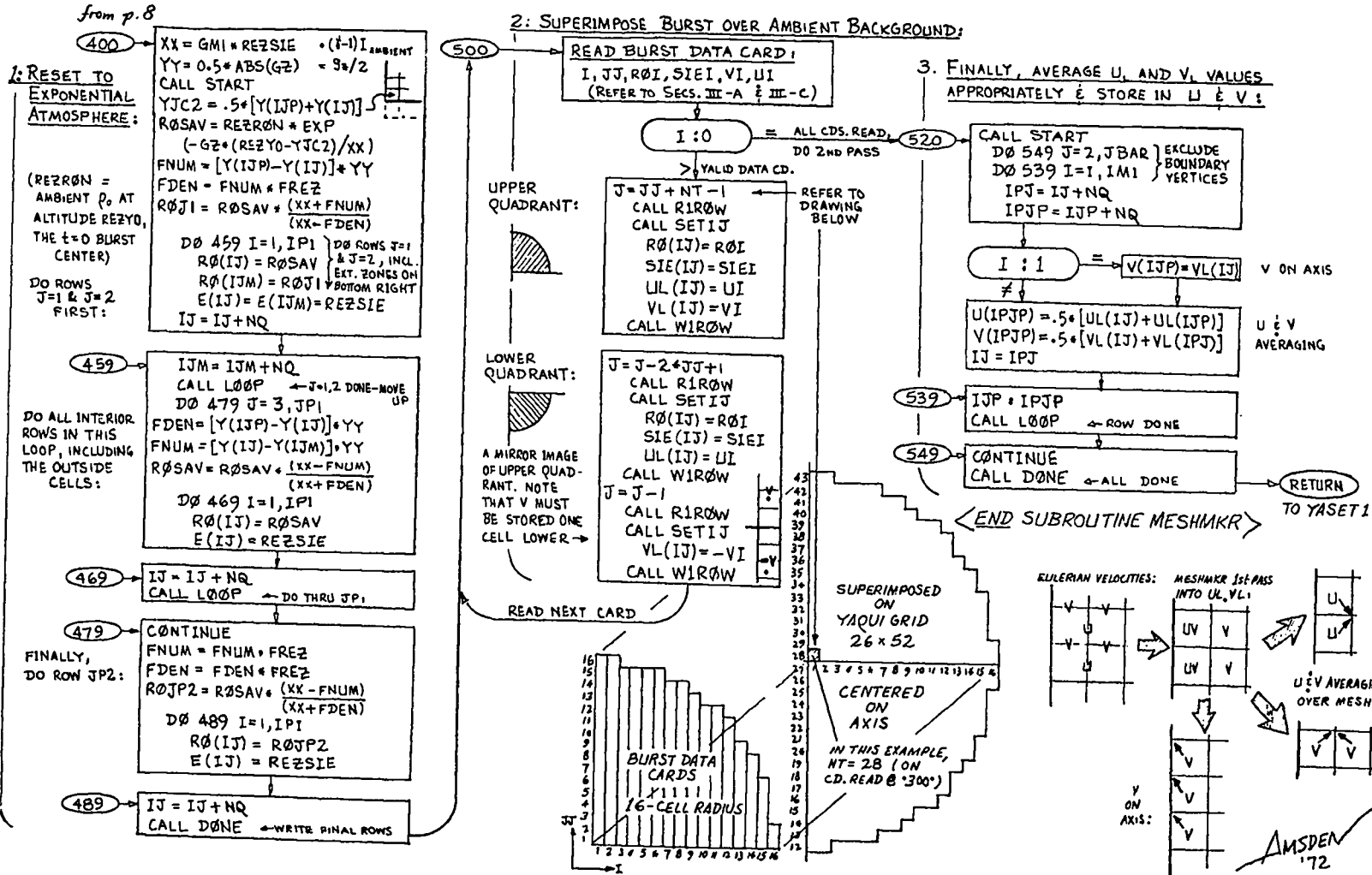

2,0 OVERLAY - 3-PHASE ICED-ALE:

10

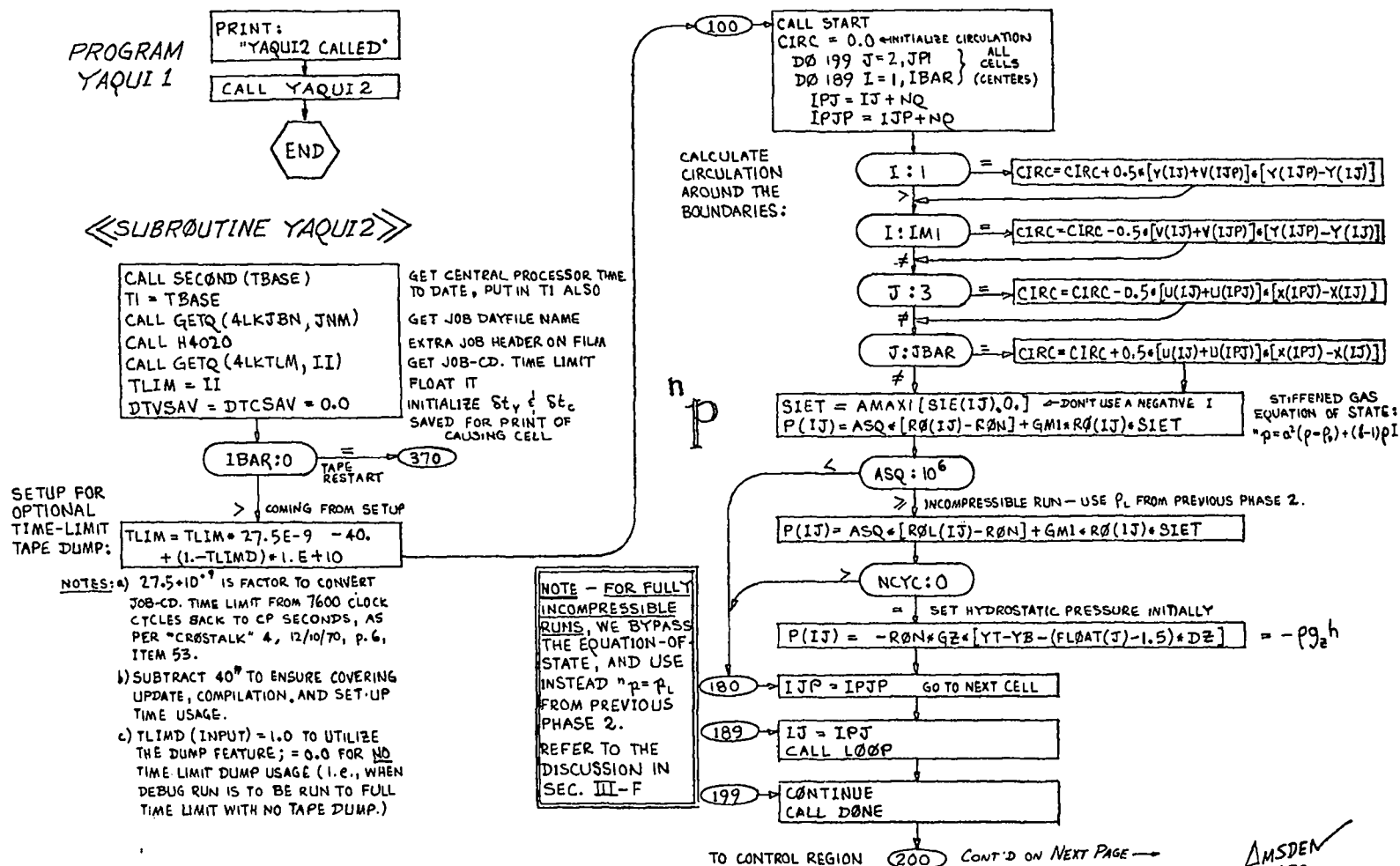

2,0 SUBROUTINES - 3-PHASE ICED-ALE (CONT'D):

11

《SUBROUTINE YAQUI2》 CONTINUED:

CONTROL REGION

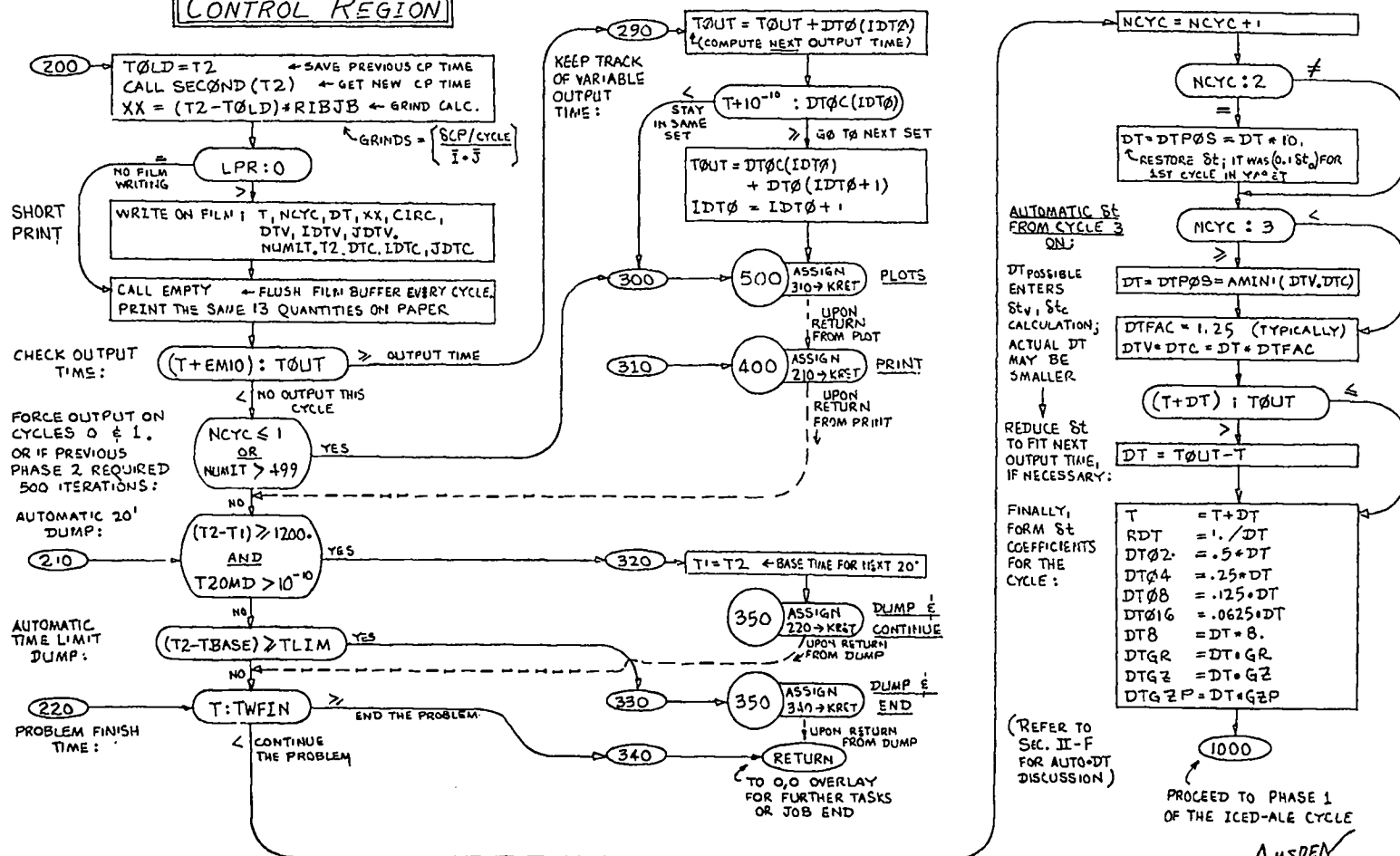
AMSDEN
172

2,0 SUBROUTINES - 3-PHASE ICED-ALE (CONT'D):

12

《SUBROUTINE YAQLI2》 CONTINUED:

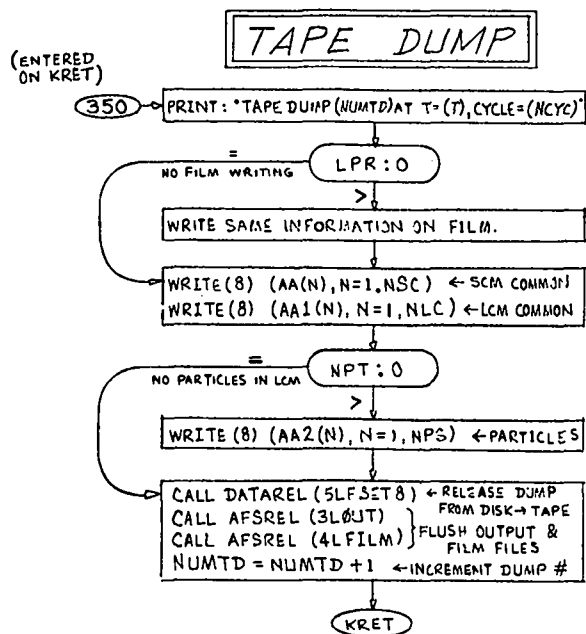

NOTES:

$NSC = \text{LENGTH OF SCM COMMON} = YSC2 = L0CF(221) - L0CF(AA) + 1$
 $NLC = \text{LENGTH OF LCM CELL STORAGE} = L0CF(AA1(JP4 + NQI)) - L0CF(AA) + 1$
 $NPS = \text{LENGTH OF LCM PARTICLE STORAGE} = L0CF(AA2(NPT + 3)) - IPAR + 1$

$LWA = FWA + 1$
 THESE 3 PARAMETERS ARE STORED IN THE SCM COMMON YSC2.
 NSC & NLC ARE CALCULATED IN YASET 1 IN STATEMENT #120
 NPS IS CALCULATED AT THE END OF PARTGEN IN STATEMENT #290.
 USE OF JP4 IN NLC ENSURES THAT CAREFULLY-CLEARED LCM WILL BE USED, TO AVOID TROUBLE ON RESTART.
 NPT IS THE TOTAL NO. OF PARTICLES IN THE SYSTEM.

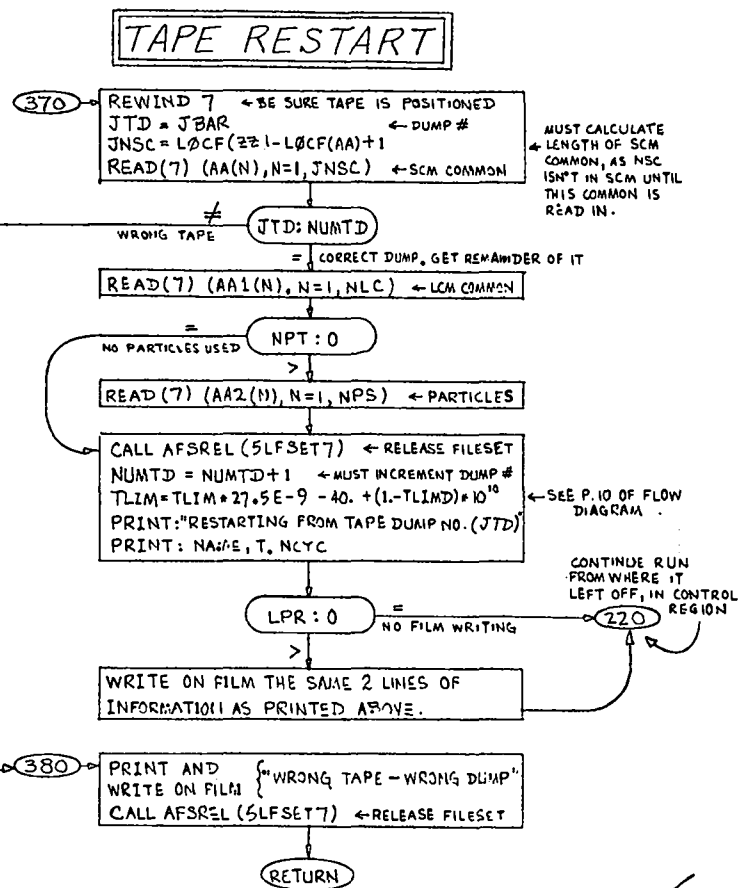

MUST CALCULATE LENGTH OF SCM COMMON, AS NSC ISN'T IN SCM UNTIL THIS COMMON IS READ IN.

SEE P.10 OF FLOW DIAGRAM

CONTINUE RUN FROM WHERE IT LEFT OFF, IN CONTROL REGION

AMSDEN '72

2.0 SUBROUTINES - 3-PHASE ICED-ALE (CONT'D):

13

《SUBROUTINE YAQUI2》 CONTINUED:

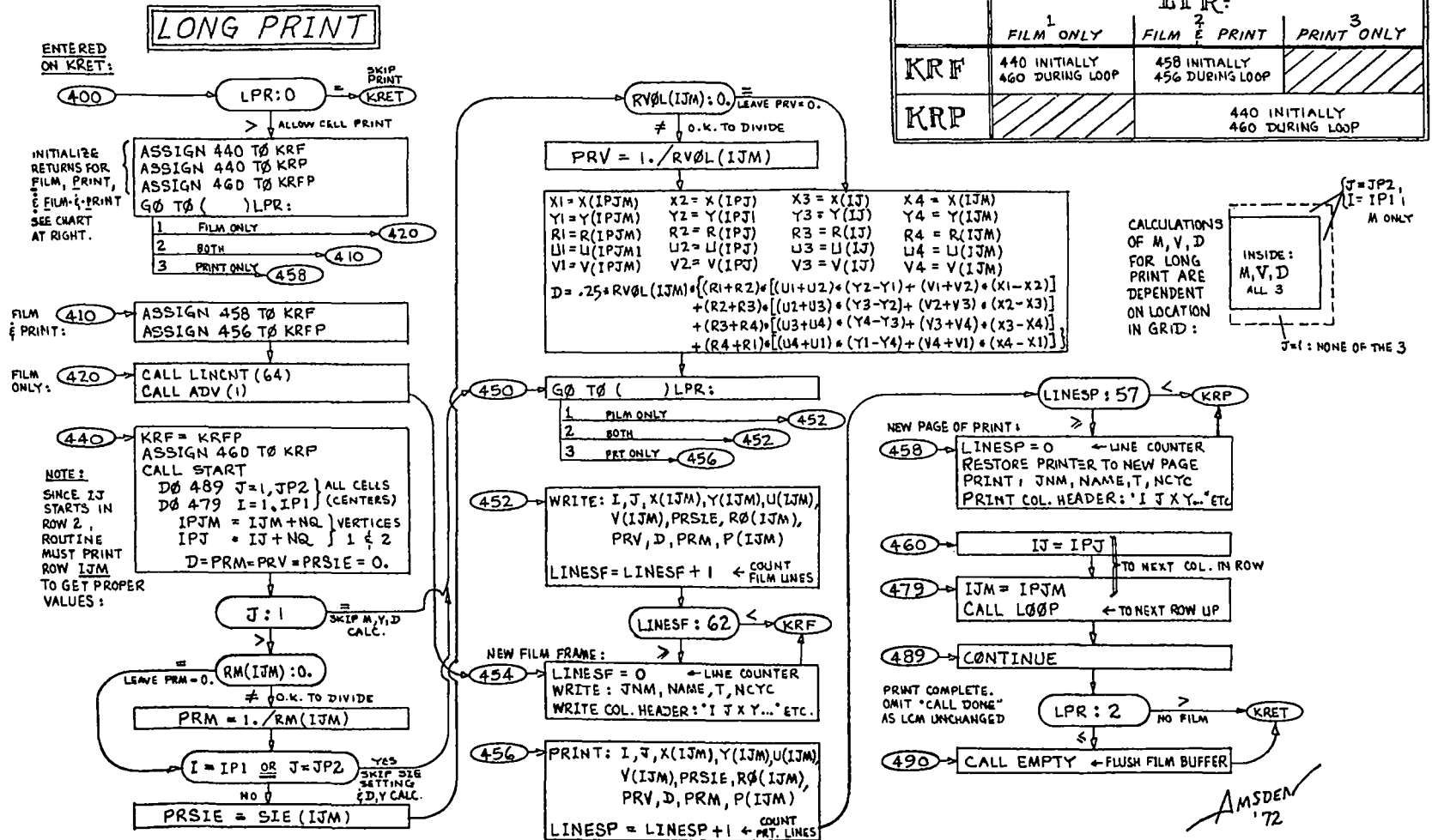

《SUBROUTINE YAQUI2》 CONTINUED:

ZONE PLOT

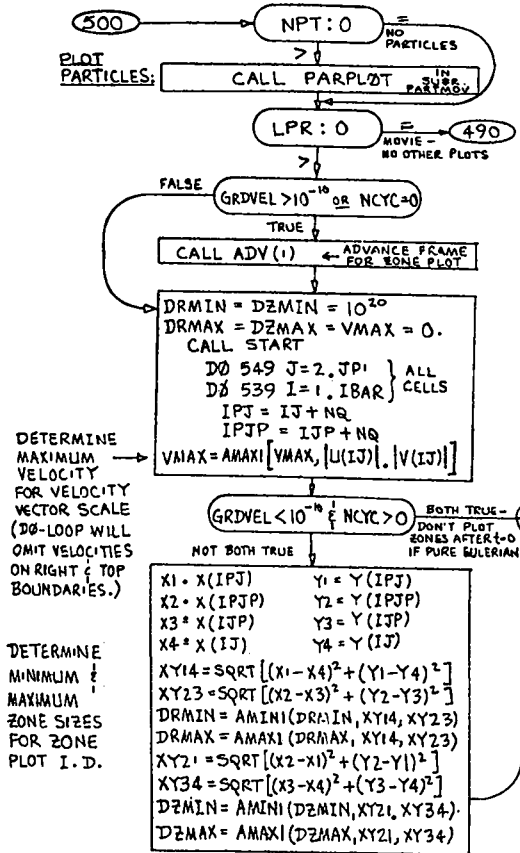

VELOCITY VECTOR PLOT

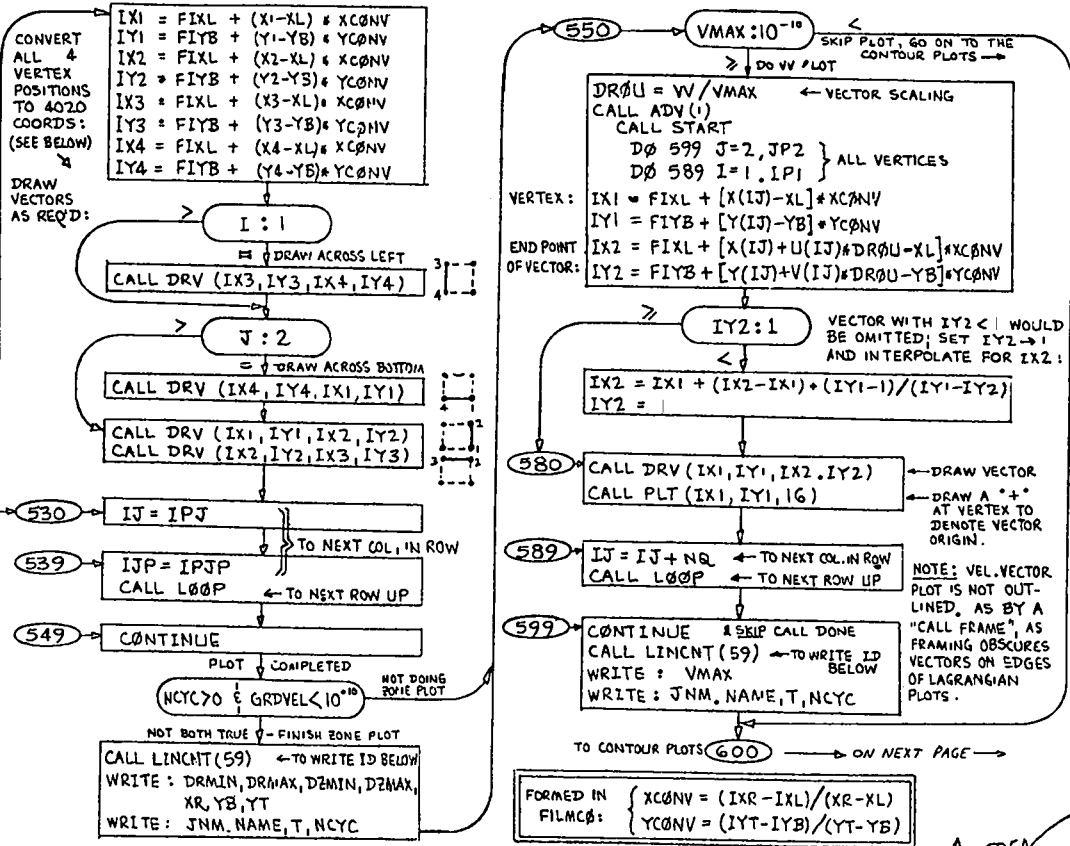

AMSDEN '72

2,0 SUBROUTINES - 3-PHASE ICED-ALE (CONT'D):

15

《SUBROUTINE YAQUI2》 CONTINUED:

CONTOUR PLOTS - PAGE 1

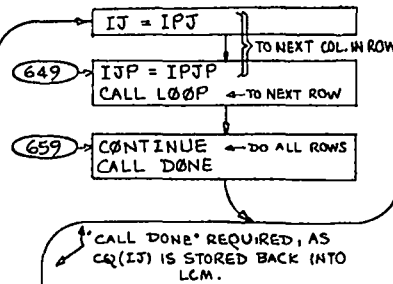
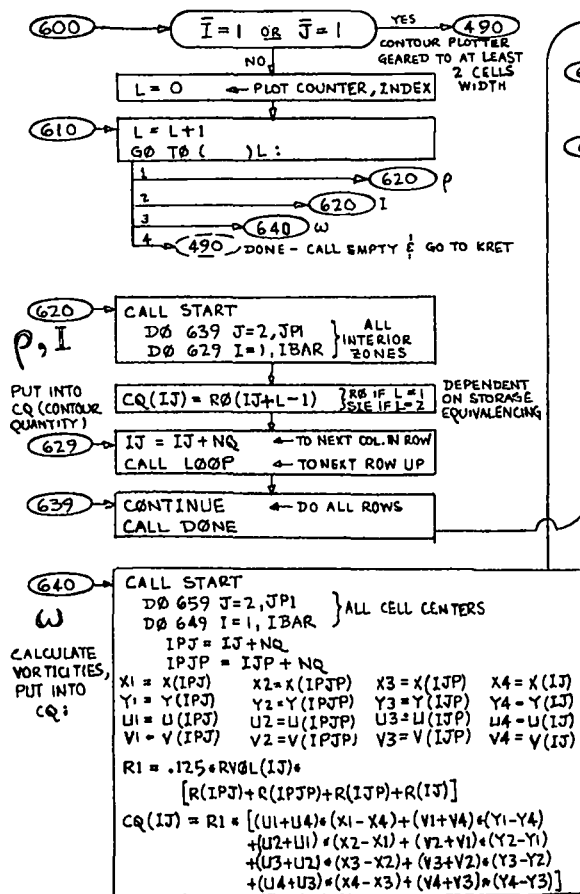

INITIALIZE LIMITS & SEARCH FOR MINIMUM & MAXIMUM FIELD VALUES:

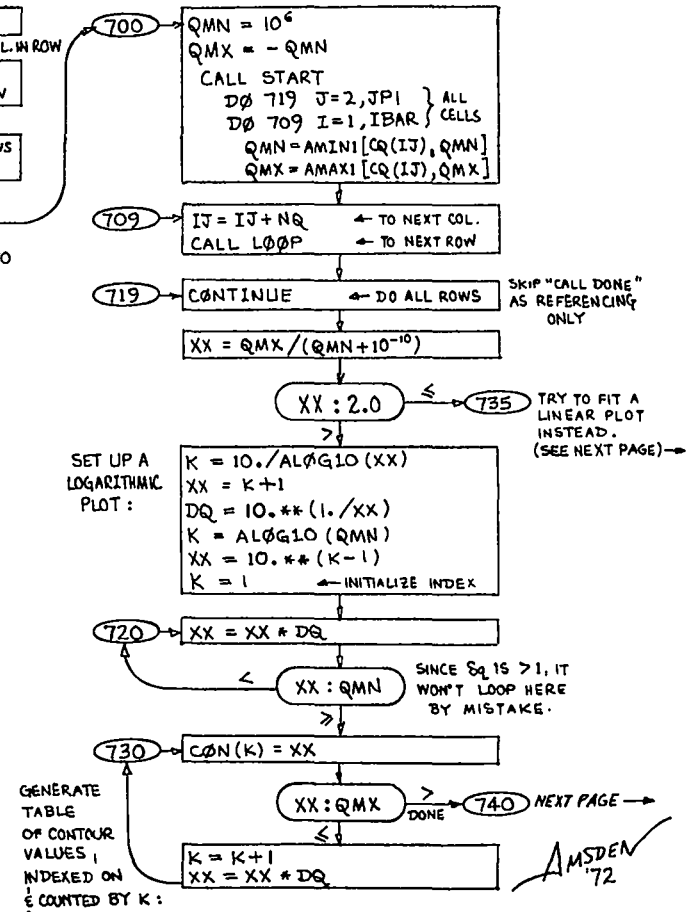

«SUBROUTINE YAQUI2» CONTINUED:

CONTOUR PLOTS - PAGE 2

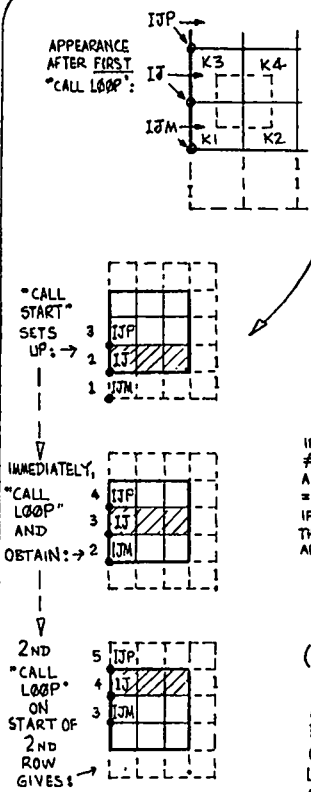
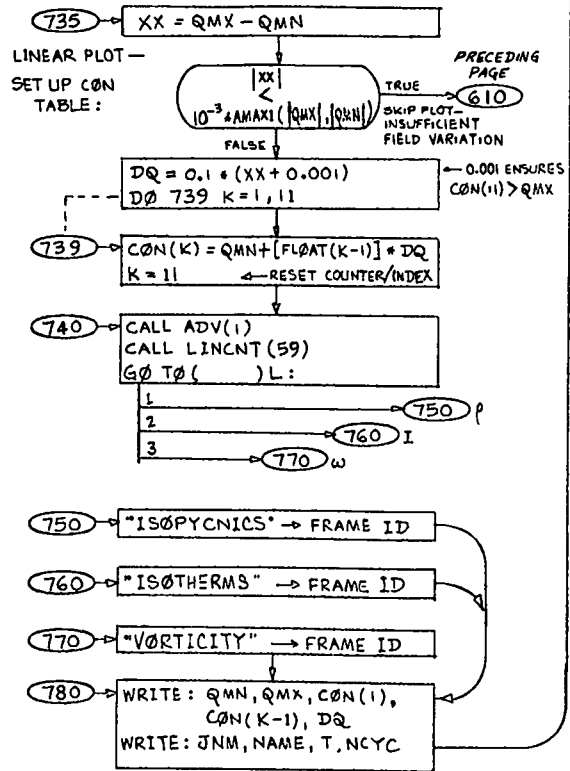

```

CALL START
D0 899 J=2, JBAR
CALL L00P
D0 889 I=1, IM1
IPJ = IJ + NQ
IPJM = IJM + NQ
N = 0
D0 879 KK=1, K
K1 = K2 = K3 = K4 = 0
    
```

← J=1 ROWS, ACTUALLY SO PROPER 3 ROWS OF X-Y COORDS WILL BE IN SCM FOR COORD. INTERPOLATION
 ← I-1 COLUMNS, ACTUALLY INDICATES CELL CENTER COORDS. NOT YET CALCULATED
 INDEX K HAS COUNT OF NO. OF VALUES IN "CON" TABLE

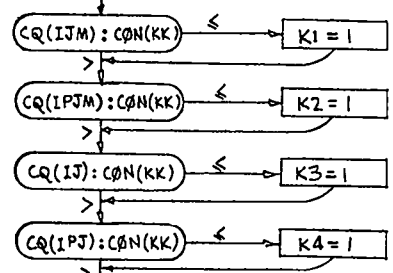

IF PRODUCT ≠ 0, THEN ALL 4 ARE = 1.
 OR
 IF SUM = 0, THEN ALL 4 ARE = 0.
 YES → 879 CONTOUR DOES NOT PASS THROUGH, TRY NEXT CONTOUR VALUE
 NO → 800

```

N = 0
COORDS ALREADY CALCULATED FOR A PREVIOUS CON VALUE
= CALC. COORDS OF 4 CELL CENTERS
IJB = IJM
IJA = IJ
D0 799 JJ=1, 2 } COORDS OF ALL 4 CELL CENTERS IN QUADRANT
D0 789 II=1, 2 }
IPJB = IJB + NQ
IPJA = IJA + NQ
N = N + 1
XC0(N) = .25 * [X(IPJB) + X(IPJA) + X(IJA) + X(IJB)]
YC0(N) = .25 * [Y(IPJB) + Y(IPJA) + Y(IJA) + Y(IJB)]
IJA = IPJA
    
```

```

789 IJB = IPJB
IJB = IJ
799 IJA = IJP
    
```

AMSDEN '72

2.0 SUBROUTINES - 3-PHASE ICED-ALE (CONT'D):

17

《SUBROUTINE YAQUI2》 CONTINUED:

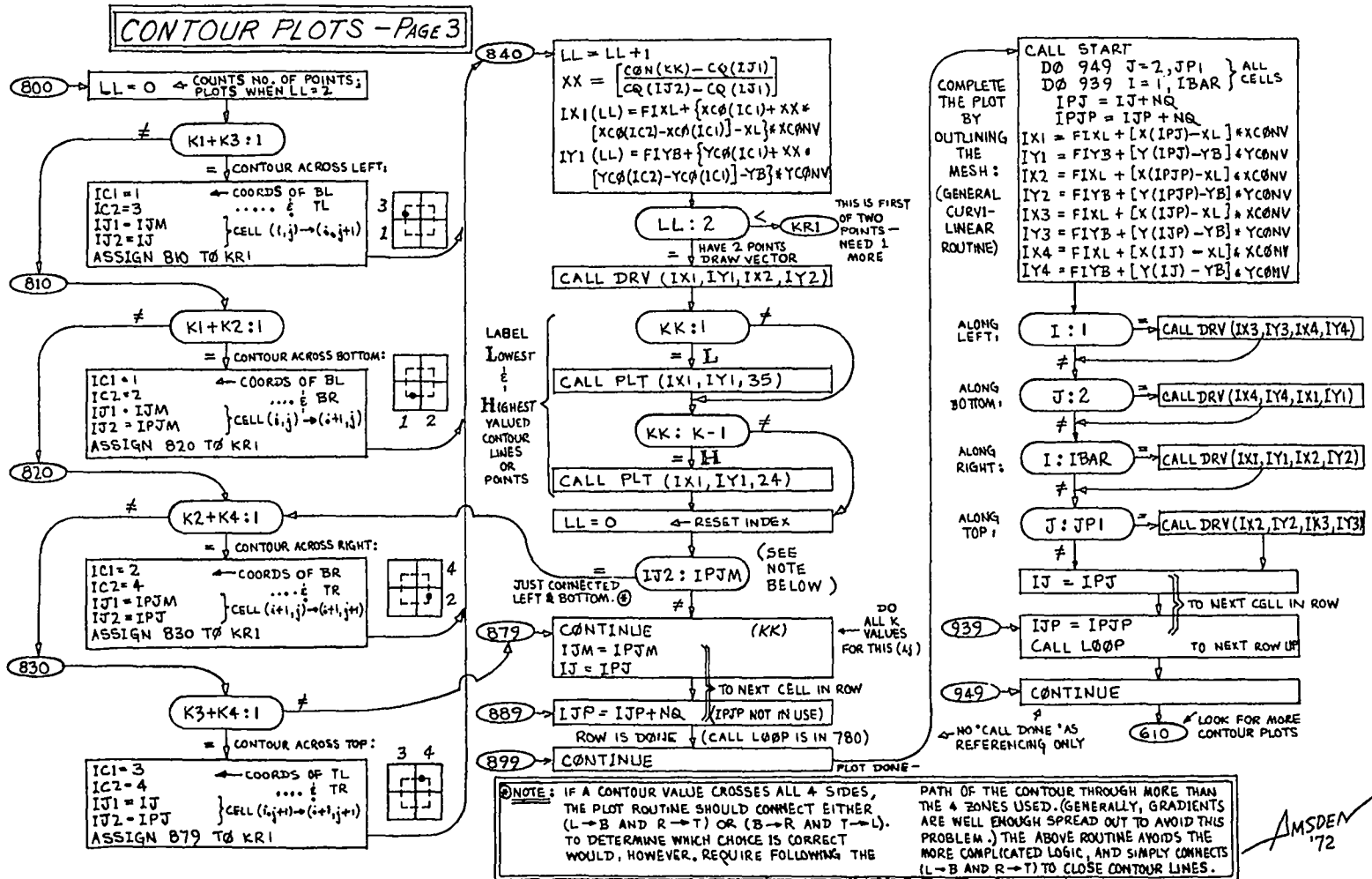

《SUBROUTINE YAQUI2》 CONTINUED:

PHASE-1 CALCULATION - PAGE 1

INITIALIZE VERTEX VALUES OF \tilde{u}, \tilde{v}, Q :

Couple Alternate Nodes:

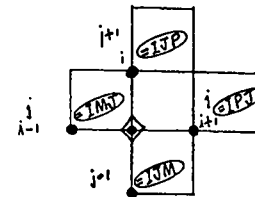
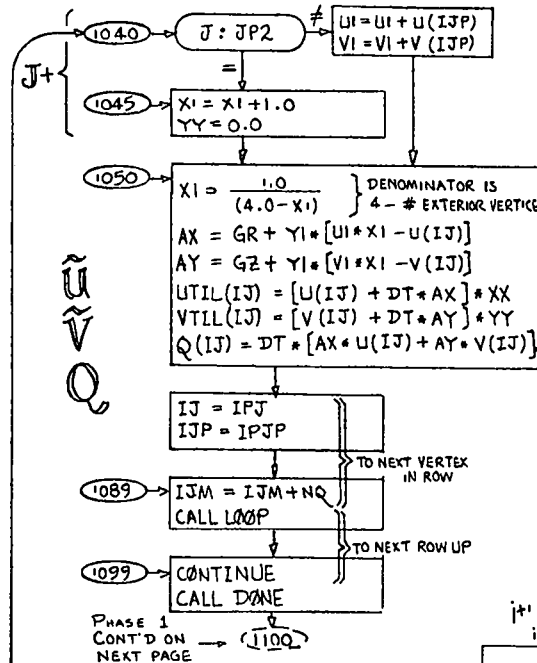
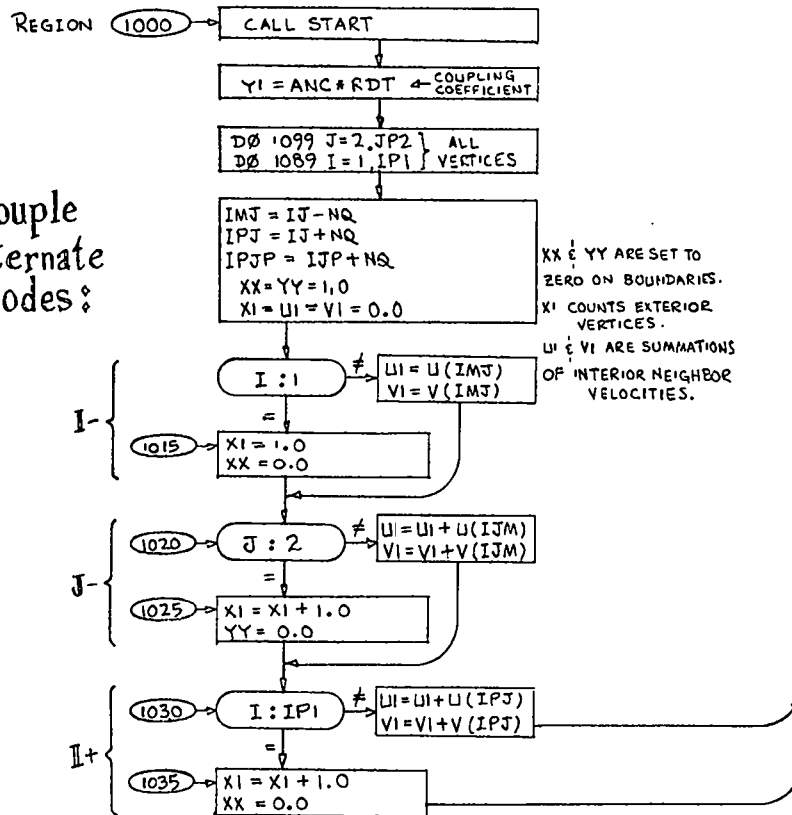

AMSDEN
72

2,0 SUBROUTINES - 3-PHASE ICED-ALE (CONT'D):

19

《SUBROUTINE YAQUI2》 CONTINUED:

PHASE-1 CALCULATION - PAGE 2

THIS 2ND LOOP SWEEPS CELL CENTERS &
 UPDATES THE 4 VERTICES OF EACH CELL

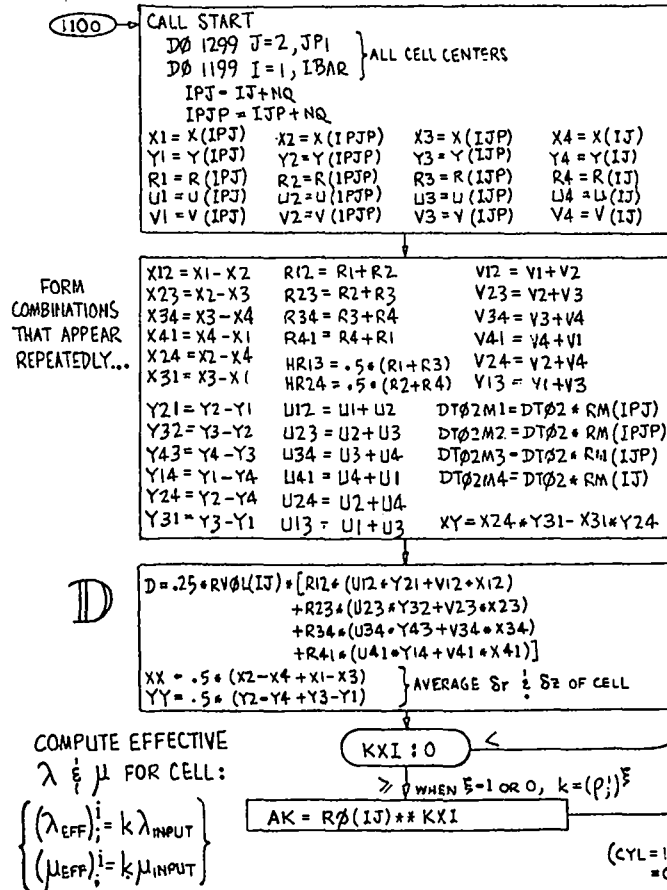

WHEN E = -1, BASE K UPON THE NUMERICAL STABILITY REQUIREMENTS.

1130 VELIJ = U4**2 + V4**2
 VELMX = 0.7 * AMAX1(|U4*XX|, |V4*YY|)
 AK = RØ(IJ) * CØLAMU * (DTØ2 * VELIJ + VELMX)

1140 LAMD = AMINI(D, 0.) * AK * LAM
 MUØ2 = .5 * AK * MU
 MUØ4 = .5 * MUØ2
 XX = XX * XX
 YY = YY * YY

KXI < 0
 AND
 DT < DTPO5

YES → SET WAS REDUCED TO FIT AN OUTPUT TIME. USE THE SET THAT WAS POSSIBLE TO CALCULATE K:
 AK = RØ(IJ) * CØLAMU * (.5 * DTFØS * VELIJ + VELMX)

NO → DQ = $\frac{RØ(IJ) * ØMANC * XX * YY}{2 * AK * (LAM + 2 * MU) * (XX + YY) + EMIO}$
 DTV = AMINI(DTV, .5 * DQ)

DTVSAV = DTV ≠ → IDTV = I
 JDTV = J

SAVE INDICES OF LIMITING CELL FOR NEXT SHORT PRINT, ... ALONG WITH THE MINIMUM S_v.

II_{xx} PIXX = MUØ2 * RVØL(IJ) * [R12 * U12 * Y21 + R23 * U23 * Y32 + R34 * U34 * Y43 + R41 * U41 * Y14 - .5 * CYL * (U12 + U34) * XY] + LAMD

II_{yy} PIYY = MUØ2 * RVØL(IJ) * [R12 * V12 * X12 + R23 * V23 * X23 + R34 * V34 * X34 + R41 * V41 * X41] + LAMD

II_{xy} PIXY = MUØ4 * RVØL(IJ) * [R12 * (U12 * X12 + V12 * Y21) + R23 * (U23 * X23 + V23 * Y32) + R34 * (U34 * X34 + V34 * Y43) + R41 * (U41 * X41 + V41 * Y14) - .5 * CYL * (V12 + V34) * XY]

II_Ø PITH = .25 * XY * CYL * {MUØ4 * RVØL(IJ) * [(U12 + U34) * XY] + LAMD}

(CYL = 1.0 IF CYLINDRICAL, = 0.0 IF PLANE COORDS.)

CONTINUED ON NEXT PAGE →

AMSDEN
 '72

《SUBROUTINE YAQUI2》 CONTINUED:

PHASE-1 CALCULATION - PAGE 3

UPDATING THE VERTICES:

```

XX = HR24 * (PIXY * X24 - PIXX * Y24)
YY = Y24 * P(IJ)
UTIL(IPJ) = UTIL(IPJ) + DT02M1 * (XX + R1 * YY - P1TH)
UTIL(IJP) = UTIL(IJP) - DT02M3 * (XX + R3 * YY + P1TH)
XX = HR13 * (PIXY * X31 - PIXX * Y31)
YY = Y31 * P(IJ)
UTIL(IPJP) = UTIL(IPJP) + DT02M2 * (XX + R2 * YY - P1TH)
UTIL(IJ) = UTIL(IJ) - DT02M4 * (XX + R4 * YY + P1TH)
PYYMP = PIYY - P(IJ)
XX = HR24 * (PYYMP * X24 - PIXY * Y24)
VTIL(IPJ) = VTIL(IPJ) + DT02M1 * XX
VTIL(IJP) = VTIL(IJP) - DT02M3 * XX
XX = HR13 * (PYYMP * X31 - PIXY * Y31)
VTIL(IPJP) = VTIL(IPJP) + DT02M2 * XX
VTIL(IJ) = VTIL(IJ) - DT02M4 * XX
XX = .5 * HR24 * [U24 * (X24 * PIXY - Y24 * PIXX)
                - V24 * (Y24 * PIXY - X24 * PIYY)]
Q(IPJ) = Q(IPJ) + DT02M1 * XX
Q(IJP) = Q(IJP) - DT02M3 * XX
XX = .5 * HR13 * [U13 * (X31 * PIXY - Y31 * PIXX)
                - V13 * (Y31 * PIXY - X31 * PIYY)]
Q(IPJP) = Q(IPJP) + DT02M2 * XX
Q(IJ) = Q(IJ) - DT02M4 * XX
IJ = IPJ
    
```

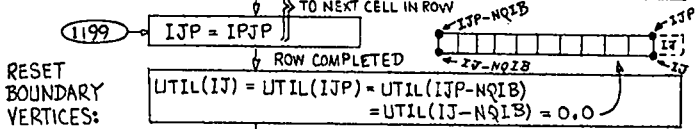

```

J: 2 >
= RESET V's ON BOTTOM:
D0 I210 IJ = ISC2, ISCF2, NQ
VTIL(IJ) = 0.0
    
```

NOTE: SINCE SUCCESSIVE CELLS WITHIN A ROW DO NOT REQUIRE THEIR NEIGHBORS' NEW TILDE VELOCITIES, IT IS REASONABLE TO RESET BOUNDARIES WHEN A ROW IS COMPLETED.

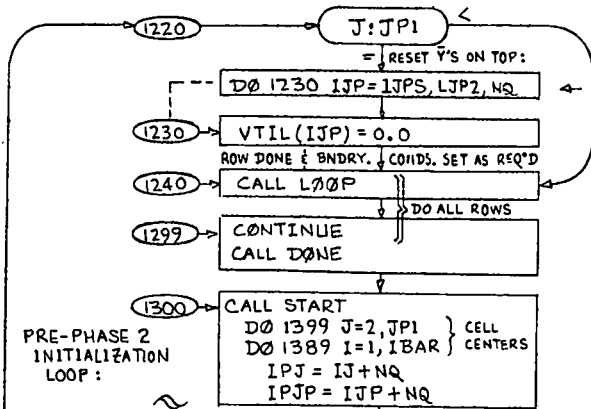

LJP2, FORMED IN SETUP, TELLS WHICH OF THE 3 SCM ROWS THE JP2TH ROW WILL BE IN.

ALSO, IJPS (= IJP_{SAVE}), WHICH IS THE PROPERTY OF SUBR. LOOP, IS PUT IN YSC2 FOR USE HERE. IT CAN BE USED HERE AS LONG AS IT ISN'T ALTERED.

```

E
PL
1/c^2
2St(1/delta r^2 + 1/delta z^2)
ETIL(IJ) = E(IJ) + .25 * [Q(IPJ) + Q(IPJP) + Q(IJP) + Q(IJ)]
R0L(IJ) = R0(IJ)
RCSQ(IJ) = 1. / {ASQ + GGM1 * AMAX1[SIE(IJ), 0.0]}
XX = [X(IPJP) - X(IJ) + X(IPJ) - X(IJP)] ** 2
YY = [Y(IPJP) - Y(IJ) + Y(IJP) - Y(IPJ)] ** 2
DELSM(IJ) = DT8 * [XX + YY]
IJ = IPJ
    
```

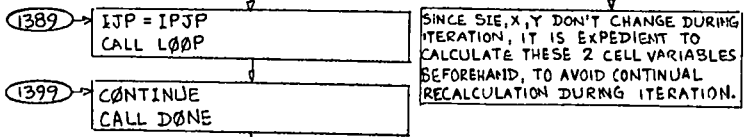

TO E CALCULATION -> (1500) NEXT PAGE ->

AMSDEN '72

2.0 SUBROUTINES - 3-PHASE ICED-ALE (CONT'D):

《SUBROUTINE YAQUI2》 CONTINUED:

PHASE-1 CALCULATION - PAGE 4

CALCULATE \tilde{E} FROM $\langle \tilde{E} \rangle$

```

1500 CALL START
    DØ 1599 J=2, JPI } ALL CELL
    DØ 1589 I=1, IBAR } :ENTERG
    IMJ = IJ-NQ
    IPJ = IJ+NQ
    IPJP = IJP+IQ
    
```

```

X1 = X(IPJ)  X2 = X(IPJP)  X3 = X(IJP)  X4 = X(IJ)
Y1 = Y(IPJ)  Y2 = Y(IPJP)  Y3 = Y(IJP)  Y4 = Y(IJ)
R1 = R(IPJ)  R2 = R(IPJP)  R3 = R(IJP)  R4 = R(IJ)

X12 = X1 - X2      Y21 = Y2 - Y1      R12 = R1 + R2
X23 = X2 - X3      Y32 = Y3 - Y2      R23 = R2 + R3
X34 = X3 - X4      Y43 = Y4 - Y3      R34 = R3 + R4
X41 = X4 - X1      Y14 = Y1 - Y4      R41 = R4 + R1

U1 = UTIL(IPJ)     V1 = VTIL(IPJ)
U2 = UTIL(IPJP)    V2 = VTIL(IPJP)
U3 = UTIL(IJP)     V3 = VTIL(IJP)
U4 = UTIL(IJ)      V4 = VTIL(IJ)

U12 = U1 + U2      V12 = V1 + V2
U23 = U2 + U3      V23 = V2 + V3
U34 = U3 + U4      V34 = V3 + V4
U41 = U4 + U1      V41 = V4 + V1
    
```

COLLECT M_L
& P_L VALUES
ON 4 SIDES:

```

MR = ML = MT = MB = MC = RØ(IJ) / RVØL(IJ) } INITIALIZE NEIGHBOR
PR = PLE = PT = PB = PC = P(IJ)             } VALUES = Ij VALUES...
                                              }  $M_L \cdot P / \frac{1}{VOL} = PV$ 
I: IBAR < MR = RØ(IPJ) / RVØL(IPJ)
              PR = P(IPJ)
I: 1 > ML = RØ(IMJ) / RVØL(IMJ)
              PLE = P(IMJ)
J: JPI < MT = RØ(IJP) / RVØL(IJP)
              PT = P(IJP)
J: 2 > MB = RØ(IJM) / RVØL(IJM)
              PB = P(IJM)
    
```

... BUT RESET NEIGHBOR TERMS IF THE NEIGHBOR CELL EXISTS

```

1540 P12 = (MR * PC + MC * PR) / (MR + MC)
      P23 = (MT * PC + MC * PT) / (MT + MC)
      P34 = (ML * PC + MC * PLE) / (ML + MC)
      P41 = (MB * PC + MC * PB) / (MB + MC)
      ETIL(IJ) = ETIL(IJ) - DTØ4 / MC *
      { R12 * P12 * (U12 * Y21 + V12 * X12)
        + R23 * P23 * (U23 * Y32 + V23 * X23)
        + R34 * P34 * (U34 * Y43 + V34 * X34)
        + R41 * P41 * (U41 * Y14 + V41 * X41)
      }
    
```

```

IJ = IPJ
IJP = IPJP
1589 IJM = IJM + NQ
      CALL LOOP
1599 CONTINUE
      CALL DONE
    
```

(2000) TO PHASE 2, NEXT PAGE ->

1) NOTE "PLE"; THE NAME "PL" IS A MESH VARIABLE.
2) MR, ML, MT, MB & MC ARE DECLARED REAL.

IN '1300', $P_L = p$ WAS INITIALIZED, PRESERVING "p". ALSO REQUIRED FOR PHASE 2 ARE:
 $U_L = \tilde{u}$
 $V_L = \tilde{v}$
 $P_L = p$
 BUT - THESE ARE IN SAME STORAGE WORDS, THUS NO STORAGE TRANSFER IS REQUIRED.
 $U_L = UTIL$
 $V_L = VTIL$
 $P_L = P$
 THEREFORE, WE HAVE INITIALIZED U_L, V_L, P_L, P_L (SAVING "p"). (THE NAMES \tilde{u}, \tilde{v}, Q ARE NO LONGER NEEDED.)
 AMSDEN '72

《SUBROUTINE YAQUI2》 CONTINUED:

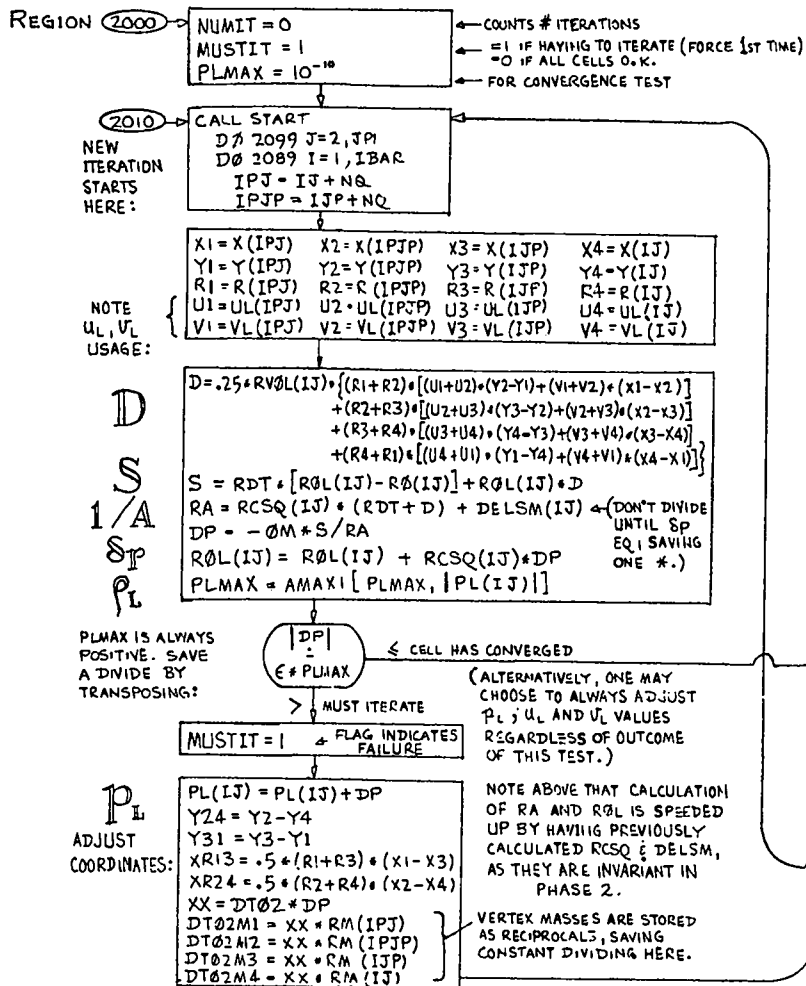

PHASE 2: ITERATION

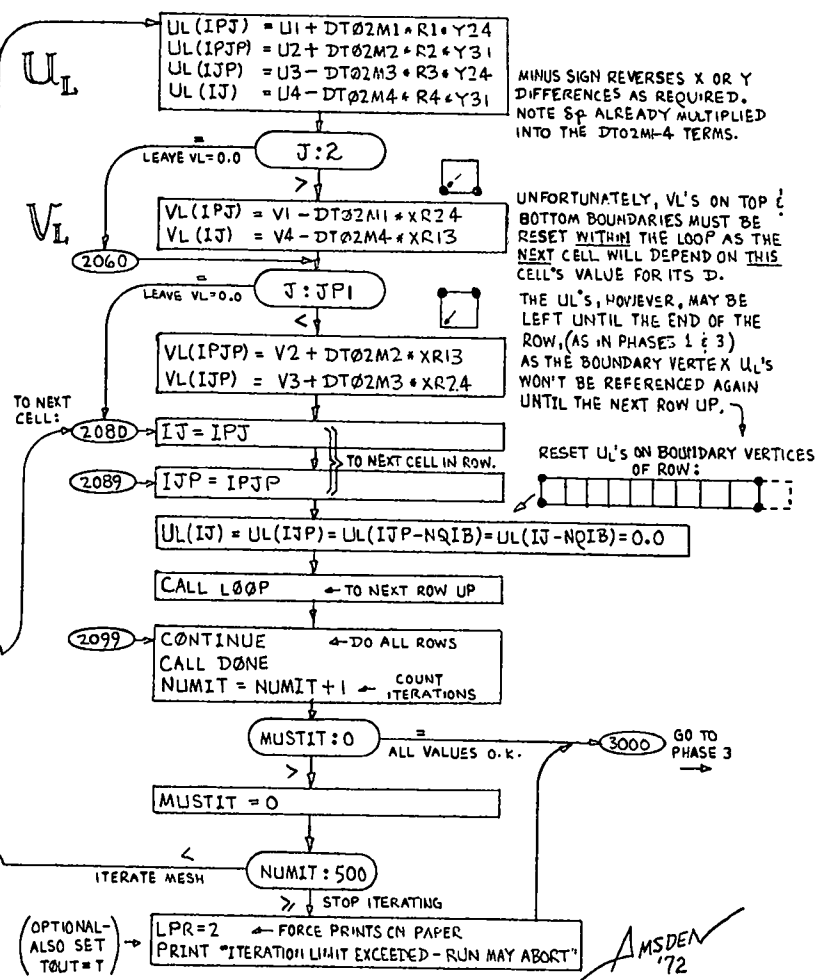

2.0 SUBROUTINES - 3-PHASE ICED-ALE (CONT'D):

«SUBROUTINE YAQUI2» CONTINUED:

PHASE-3 CALCULATION - PAGE 1

CALCULATE "n+1" VALUES OF $x, y, r, M_c, E, \frac{1}{V}, \rho$

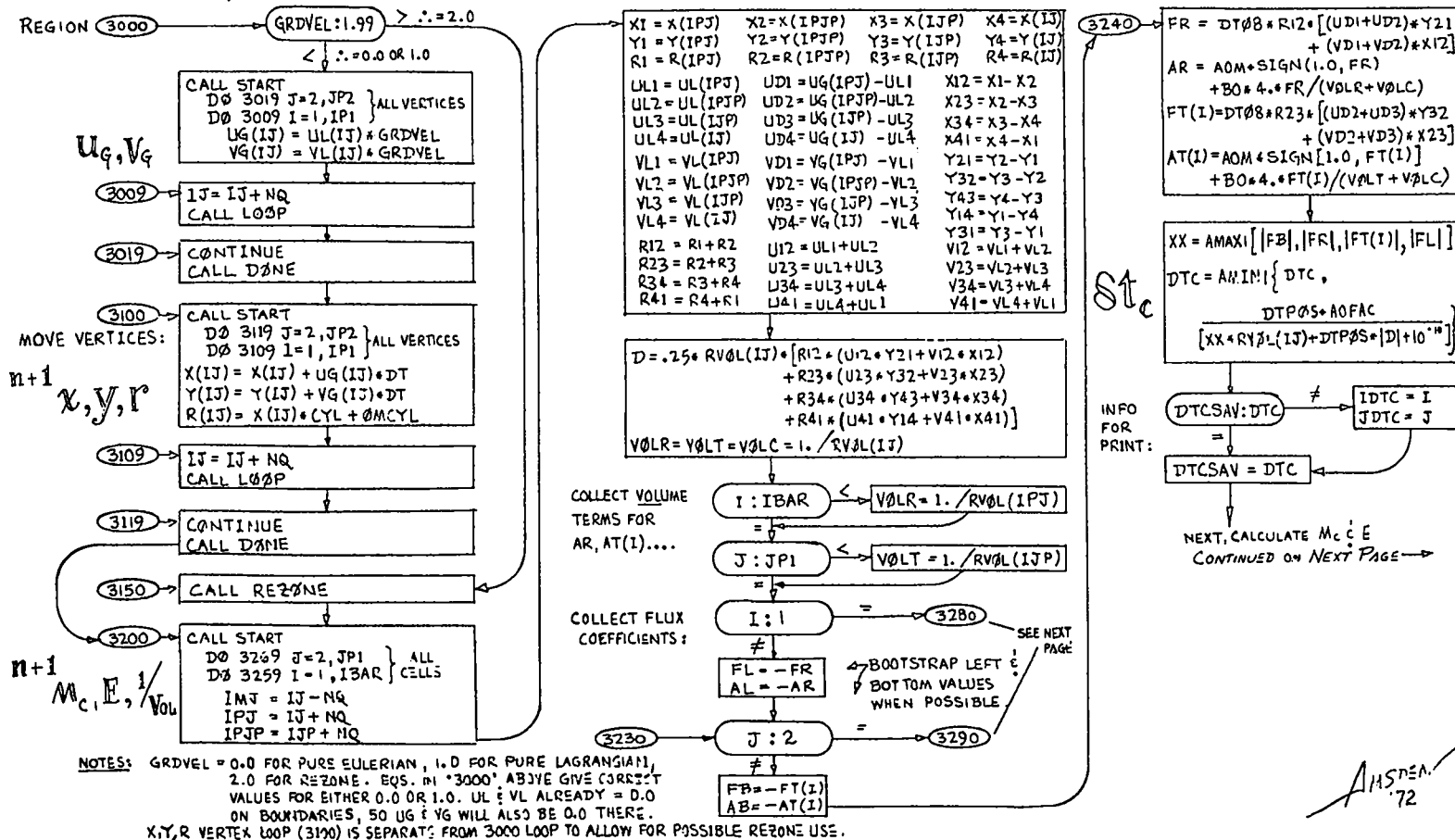

AHS:ENA
72

《SUBROUTINE YAQUI2》 CONTINUED:

PHASE-3 CALCULATION - PAGE 2

$$M_c, E, \frac{1}{V}, \rho, \dots$$

$$\begin{aligned}
 & n+1 M_c \\
 & n+1 E \\
 & n+1 \frac{1}{Vol}
 \end{aligned}$$

$$\begin{aligned}
 MP(IJ) &= R\theta(IJ) * V\theta LC \\
 &+ FR * [(1.-AR) * R\theta L(IJ) + (1.+AR) * R\theta L(IPJ)] \\
 &+ FT(I) * [(1.-AT(I)) * R\theta L(IJ) + (1.+AT(I)) * R\theta L(IJP)] \\
 &+ FL * [(1.-AL) * R\theta L(IJ) + (1.+AL) * R\theta L(IMJ)] \\
 &+ FB * [(1.-AB) * R\theta L(IJ) + (1.+AB) * R\theta L(IJM)] \\
 R\theta E &= R\theta(IJ) * ETIL(IJ) \\
 EP(IJ) &= 1./MP(IJ) * \{ R\theta E + V\theta LC \\
 &+ FR * [(1.-AR) * R\theta E + (1.+AR) * R\theta(IPJ) * ETIL(IPJ)] \\
 &+ FT(I) * [(1.-AT(I)) * R\theta E + (1.+AT(I)) * R\theta(IJP) * ETIL(IJP)] \\
 &+ FL * [(1.-AL) * R\theta E + (1.+AL) * R\theta(IMJ) * ETIL(IMJ)] \\
 &+ FB * [(1.-AB) * R\theta E + (1.+AB) * R\theta(IJM) * ETIL(IJM)] \}
 \end{aligned}$$

$$\begin{aligned}
 ATR &= .5 * (X2 * Y31 - X1 * Y32 - X3 * Y21) \\
 ABL &= -.5 * (X1 * Y43 + X3 * Y14 + X4 * Y31) \\
 RV\theta L(IJ) &= \frac{3.0}{ATR * (R1+R2+R3) + ABL * (R1+R3+R4)}
 \end{aligned}$$

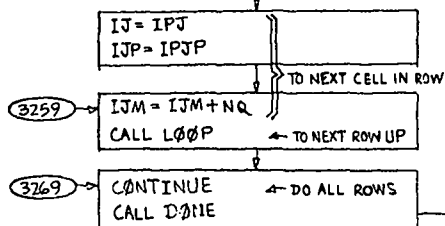

$$\begin{aligned}
 & 3280 \quad I=1: \quad FL = DT\theta B * R34 * [(UD3+UD4) * Y43 + (VD3+VD4) * X34] \\
 & \quad \quad AL = AOM * SIGN(1.0, FL) + B0 * 2. * FL * RV\theta L(IJ) \quad \rightarrow 3230 \\
 & 3290 \quad J=2: \quad FB = DT\theta B * R41 * [(UD4+UD1) * Y14 + (VD4+VD1) * X41] \\
 & \quad \quad AB = AOM * SIGN(1.0, FB) + B0 * 2. * FB * RV\theta L(IJ) \quad \rightarrow 3240
 \end{aligned}$$

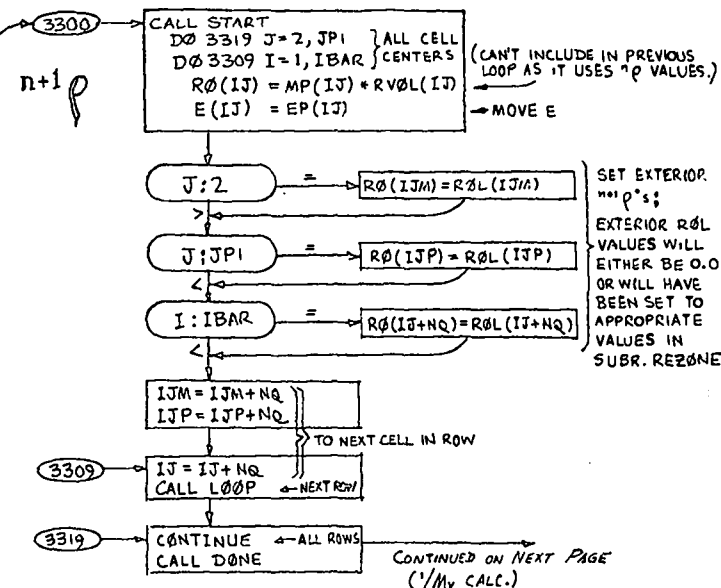

IMPORTANT NOTE ON FLUX TERMS:

WITH THIS RIGID-WALL VERSION OF YAQUI, FL, FB, AL, & AB WILL AUTOMATICALLY BE CALCULATED AS 0 (INDEED: FT, FR, AT, & AR WILL ALSO BE 0 ON RIGID BOUNDARIES). ALTHOUGH FL, AL, FB, & AB COULD SIMPLY HAVE BEEN SET DIRECTLY TO 0.0 IN "3280" & "3290", THE FULL GENERAL EXPRESSIONS ARE INCLUDED HERE FOR POSSIBLE USE BY FUTURE VERSIONS OF YAQUI THAT HAVE BEEN SUITABLY MODIFIED TO ALLOW FOR BOUNDARY FLUXES. NOTE IN PARTICULAR THAT WITH NO FICTITIOUS CELLS ON THE LEFT, THE USE OF ANY NON-ZERO AL WILL RESULT IN ERRONEOUSLY REFERENCING ρ AND E VALUES FROM THE RIGHT SIDE OF THE MESH.

THE FINAL TERM IN AB (& AL) IS OF THE FORM:

$$\frac{4FB}{V_s + V_c} \text{ (NO BOUNDARY GRADIENT)} \rightarrow \frac{4FB}{2V_c} \rightarrow 2FB * RV\theta L_c$$

AMSDEN
172

2.0 SUBROUTINES - 3-PHASE ICED-ALE (CONT'D):

《SUBROUTINE YAQUI2》 CONTINUED:

PHASE-3 CALCULATION - PAGE 3

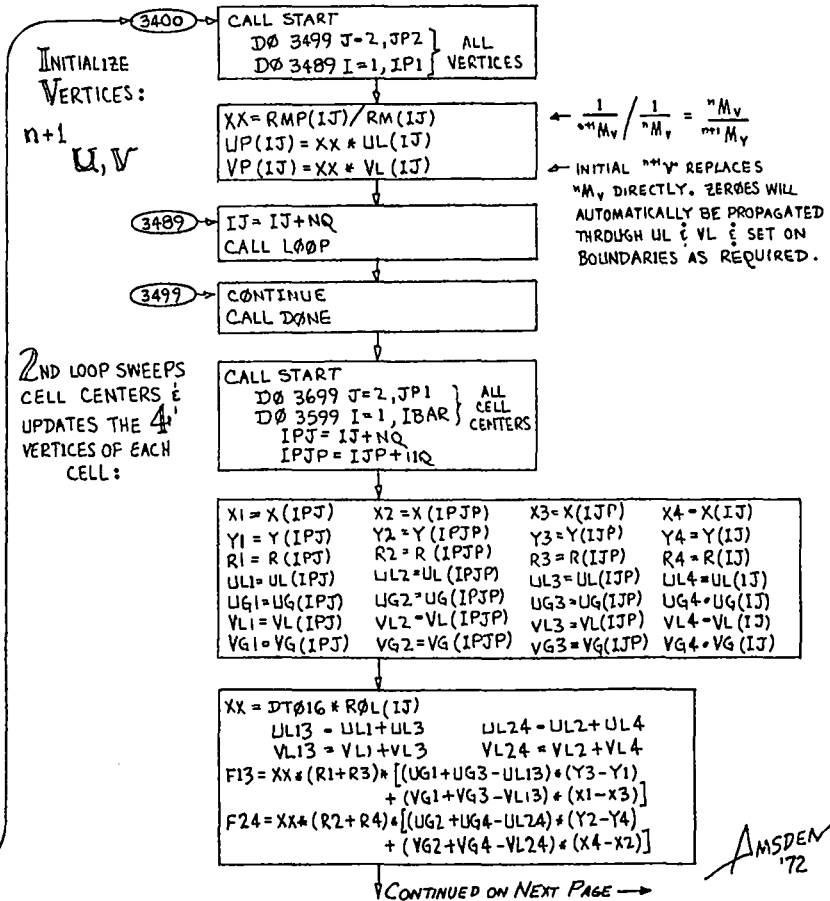
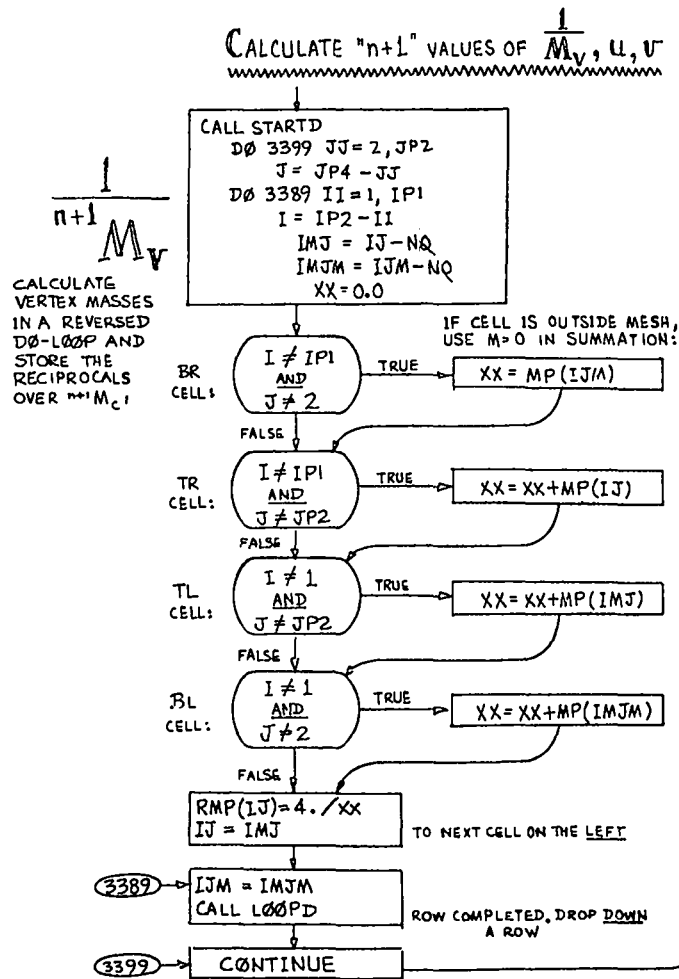

«SUBROUTINE YAQUI2» CONTINUED:

PHASE-3 CALCULATION - PAGE 4

COMPLETE CALCULATION OF $n+1$ U, V, CALCULATE $n+1$ I:

```

FM1 = F24 * RMP(IPJ)
FM2 = F13 * RMP(IPJP)
FM3 = F24 * RMP(IJP)
FM4 = F13 * RMP(IJ)
XX = B0 * 4. * RVPL(IJ) / RPL(IJ)
AL13 = A0 * SIGN(1., F13) + XX * F13
AL24 = A0 * SIGN(1., F24) + XX * F24
OPAL13 = 1. + AL13
OMAL13 = 1. - AL13
OPAL24 = 1. + AL24
OMAL24 = 1. - AL24
XX = UL3 * OMAL24 + UL1 * OPAL24
UP(IPJ) = UP(IPJ) - FM1 * XX
UP(IJP) = UP(IJP) + FM3 * XX
XX = UL4 * OMAL13 + UL2 * OPAL13
UP(IPJP) = UP(IPJP) - FM2 * XX
UP(IJ) = UP(IJ) + FM4 * XX
XX = VL3 * OMAL24 + VL1 * OPAL24
VP(IPJ) = VP(IPJ) - FM1 * XX
VP(IJP) = VP(IJP) + FM3 * XX
XX = VL4 * OMAL13 + VL2 * OPAL13
VP(IPJP) = VP(IPJP) - FM2 * XX
VP(IJ) = VP(IJ) + FM4 * XX
IJ = IPJ
    
```

$n+1$ U
 $n+1$ V

RESET BOUNDARY VERTICES:

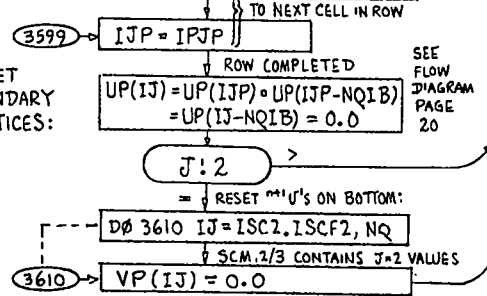

NOTE: AS IN PHASE 1, SUCCESSIVE CELLS WITHIN A ROW DO NOT REQUIRE THEIR NEIGHBORS' NEW VELOCITIES; HENCE, BOUNDARIES ARE NOT RESET UNTIL ROW COMPLETION.

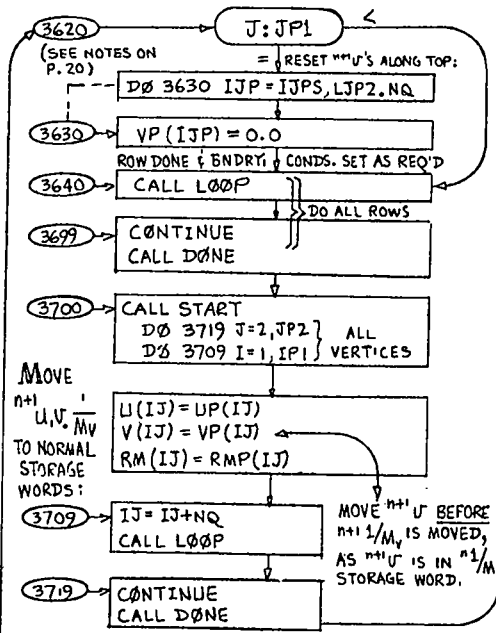

MOVE $n+1$ U, V, M_v TO NORMAL STORAGE WORDS:

MOVE $n+1$ U BEFORE $n+1$ M_v IS MOVED, AS $n+1$ U IS IN $n+1$ M STORAGE WORD.
NOW THAT $n+1$ U/M_v HAS BEEN MOVED, I STORAGE IS FREE, SO CALCULATE $n+1$ I

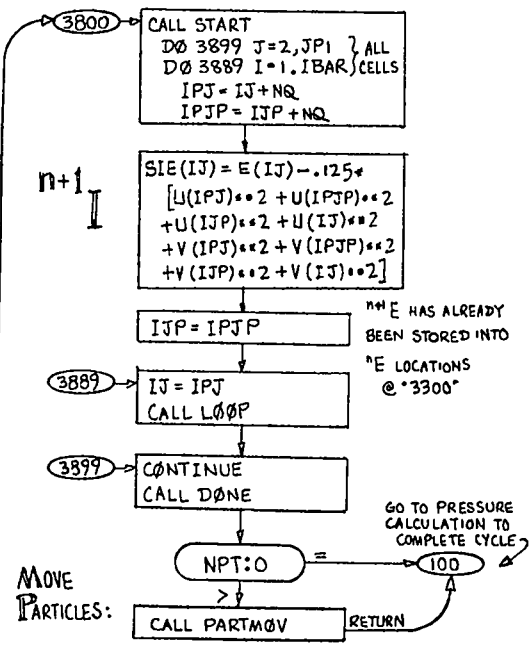

MOVE PARTICLES:

«END SUBROUTINE YAQUI2»

AMSDEN '72

2.0 SUBROUTINES — PARTICLE MOVER

27

《SUBROUTINE PARTMOV》

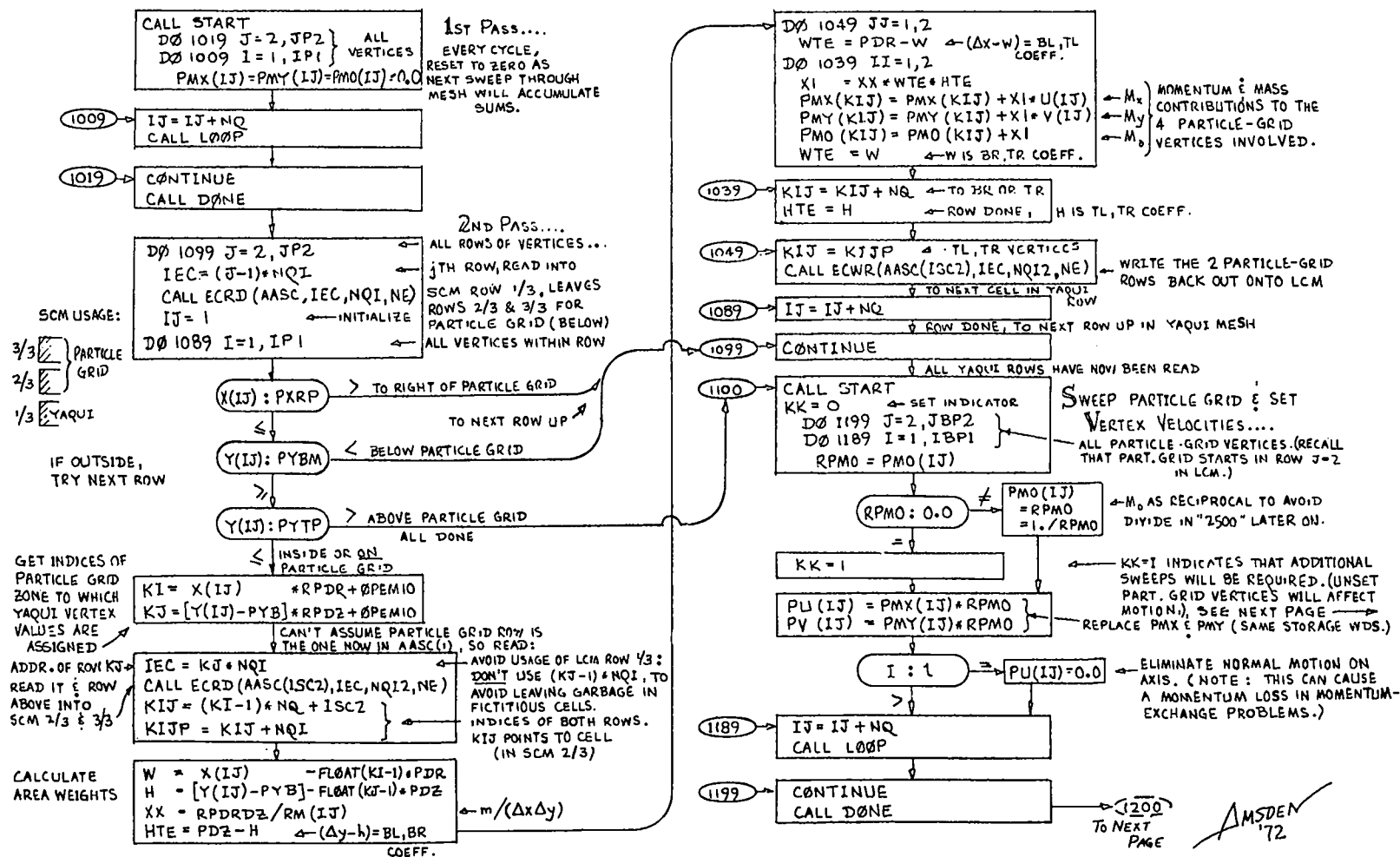

《SUBROUTINE PARTMOV》-Page 2

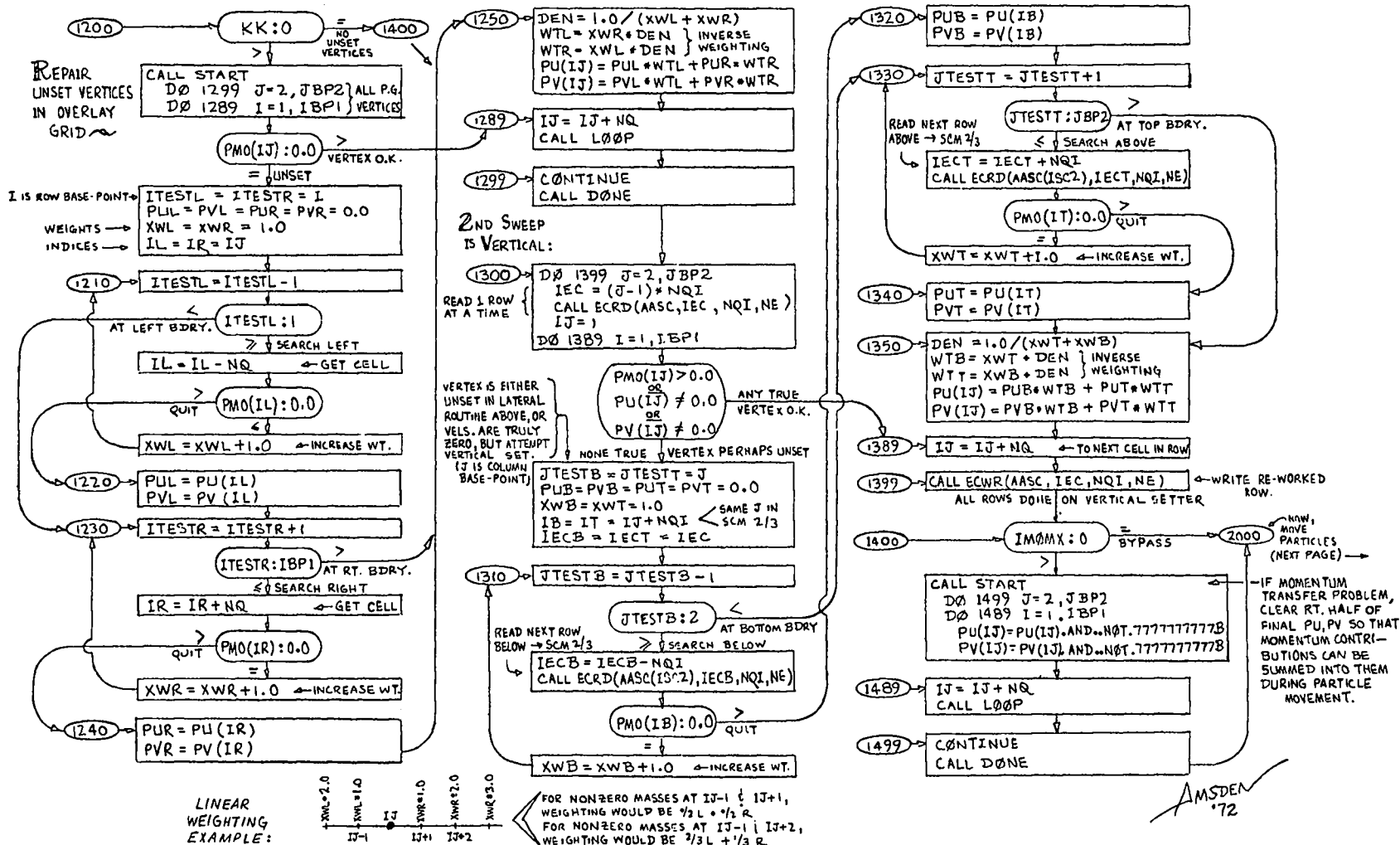

2,0 SUBROUTINES - PARTICLE MOVER (CONT'D):

《SUBROUTINE PARTMOV》 - PAGE 3

MOVE PARTICLES IN RELATION TO OVERLAY GRID

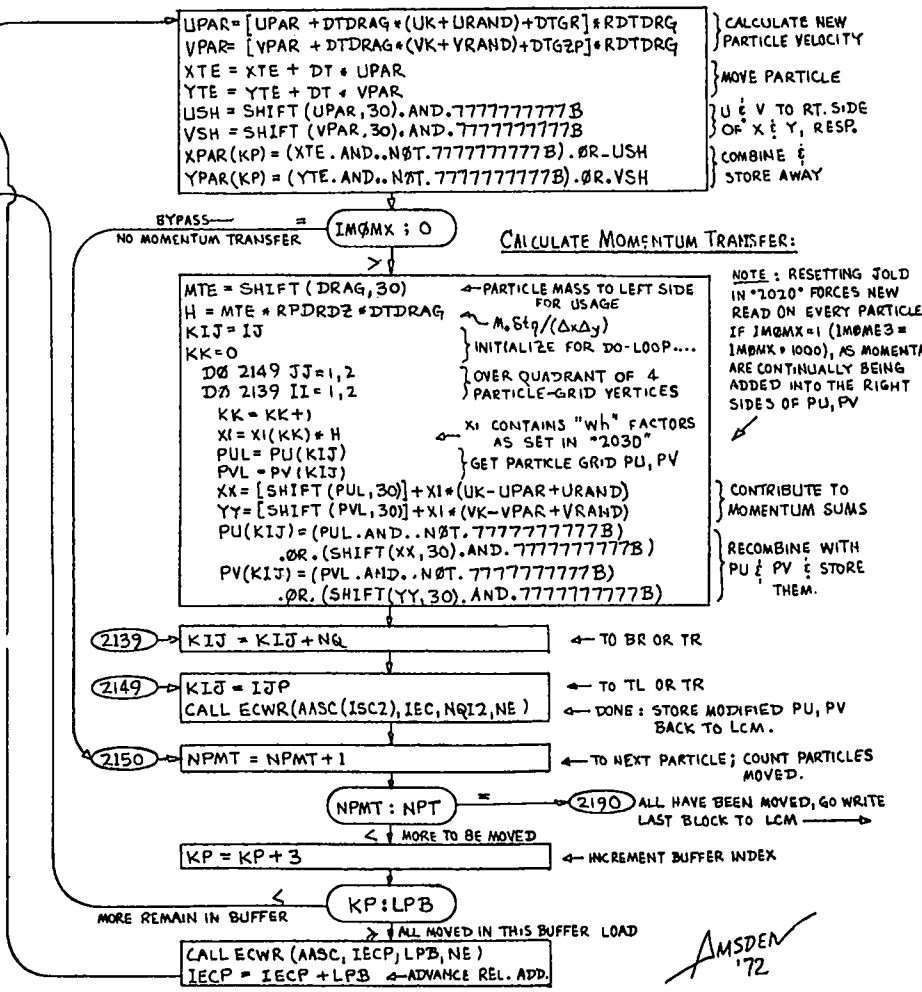
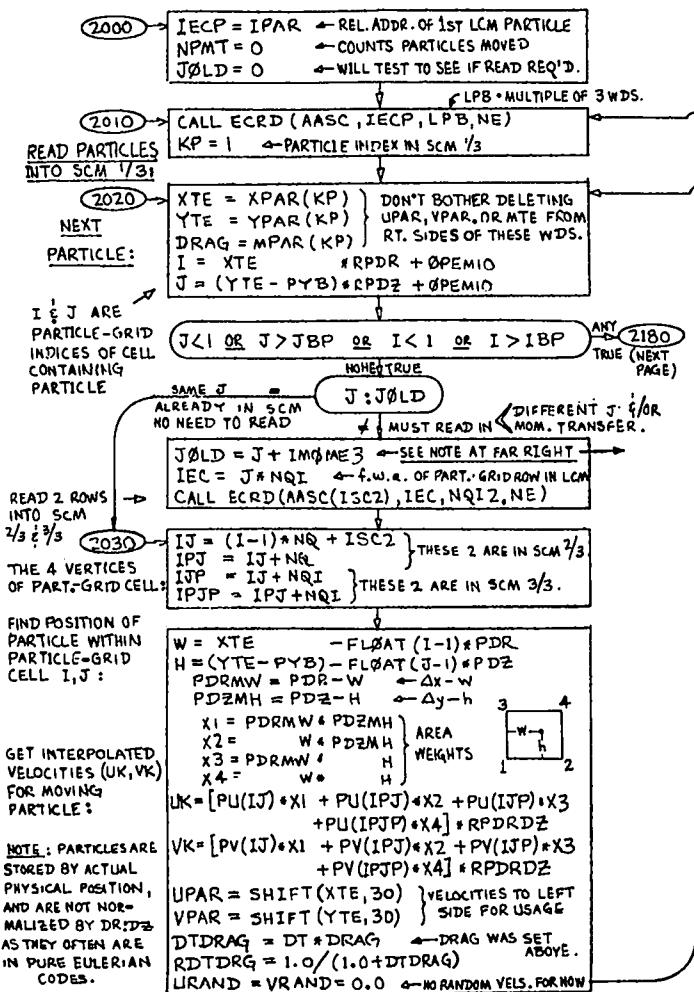

《SUBROUTINE PARTMOV》 - PAGE 4

2180 → XPAR(KP) = -10³ ← SET X_p TO AN UNREALISTIC VALUE TO INDICATE PARTICLE IS OUTSIDE; MAINLY MEANT FOR THE PARTICLE PLOT. → 2150

COMPLETE PARTICLE MOVEMENT BY WRITING FINAL BLOCK (MAY BE PARTIALLY FULL) BACK ONTO LCM:

2190 → CALL ECWR(AASC, IECP, LPB, NE)

MOMENTUM TRANSFER BACK ONTO YAQUI GRID:

2500 → IMOMX: 0 → RETURN NO MOMENTUM TRANSFER

READ JTH ROW INTO SCM 1/3, LEAVING 2/3 & 3/3 FOR PART. GRID

DØ 2599 J=2, JP2 ← ALL ROWS OF VERTICES
IEC = (J-1) * NQI
CALL ECRD(AASC, IEC, NQI, NE)
IJ = 1 ← INITIALIZE
DØ 2589 I=1, IP1 ← ALL VERTICES IN ROW

IF OUTSIDE, TRY NEXT ROW:

X(IJ) > PXR OR Y(IJ) < PYB
NEITHER TRUE
Y(IJ) > PYT → YES → RETURN ALL DONE
NO → INSIDE OR ON PART. GRID

KI & KJ ARE INDICES OF PART. GRID CELL TO WHICH YAQUI VERTEX VALUES ARE ASSIGNED

KI = X(IJ) * RPDR + ØPEMIO
KJ = [Y(IJ) - PYB] * RPDB + ØPEMIO
IECP = KJ * NQI
CALL ECRD(AASC, IEC, NQI, NE)
KIJ = (KI-1) * NQ + ISC2
KIJP = KIJ + NQI

READ PART. GRID INTO SCM 2/3 & 3/3. KZJ IS INDEX OF CELL; KIJP IS ROW ABOVE (IN 3/3).

NOTE ON PMO USAGE (SEE ABOVE, RIGHT):

PMO=0 IF VERTEX WAS NEVER SET IN "1000" LOOP, EVEN IF PU, PY WERE SET FROM NEIGHBORS IN "1200" & "1300." MOMENTUM TRANSFER CALCULATION CAN BE IMPERFECT, THEREFORE, IF THERE IS MUCH DISPARITY IN SIZE BETWEEN YAQUI GRID & PARTICLE GRID. HOWEVER, REZONING IS NOT SO COMMONLY USED IN MOMENTUM TRANSFER PROBLEMS AS IT IS IN PROBLEMS IN WHICH THE PARTICLES ARE EMPLOYED SOLELY AS MARKERS.

W = X(IJ) - FLOAT(KI-1) * PDR
H = [Y(IJ) - PYB] - FLOAT(KJ-1) * PDZ
HTE = PDZ - H ← BL, BR (Δy-h)
DØ 2549 JJ=1, 2
WTE = PDR - W ← BL, TL (Δx-w)
DØ 2539 II=1, 2
XX = RPDRD * WTE + HTE * PMO(KIJ)
U(IJ) = U(IJ) - XX * [SHIFT(PU(KIJ), 30)]
V(IJ) = V(IJ) - XX * [SHIFT(PV(KIJ), 30)]
WTE = W ← BR, TR (w)

2539 → KIJ = KIJ + NQ ← TO BR OR TR CELL IN QUADRANT
HTE = H ← TL, TR (h)

2549 → KIJ = KIJP ← TO TL, TR QUADRANT DONE

2589 → IJ = IJ + NQ ← TO NEXT CELL IN YAQUI ROW

2599 → CALL ECWR(AASC, IEC, NQI, NE)
ALL ROWS DONE IN YAQUI GRID.
RETURN

《ENTRY PARPLOT》

PARTICLE PLOTTER:
~~~~~

CALL ADV(1) ← NEW FILM FRAME  
CALL FRAME TWICE: OUTLINE REGION SURROUNDING (IPXL, IPXR, IPYT, IPYB)

LPR: 0  
NO WRITING

CALL LINCNT(59) ← 59 LINES DOWN  
WRITE: PDR, PDZ, PXR, PYB, PYT, JNM, NAME, T, NCYC

3000 → IECP = IPAR ← REL. ADDR. 1ST LCM PARTICLE

BLACK & WHITE OR COLOR?  
ICOLOR: 0 → SET TO PLOT IN RED

NPPT = 0 ← COUNTS PARTICLES PLOTTED

3010 → CALL ECRD(AASC, IECP, LPB, NE)  
KP = 1

3020 → XPAR(KP): 0.0

CONVERT PARTICLE TO 4020 COORDS. & PLOT:

IXI = FIPXL + [XPAR(KP) - PXL] \* PXCØNV  
IYI = FIPYB + [YPAR(KP) - PYB] \* PYCØNV  
CALL PLT(IXI, IYI, 42)

3050 → NPPT = NPPT + 1

ALL ARE PLOTTED NPPT: NPPT  
← MORE TO BE PLOTTED

KP = KP + 3

MORE IN BUFFER < KP: LPB

IECP = IECP + LPB  
ALL PLOTTED IN BUFFER. ADVANCE REL. LCM READ ADDR.

3060 → ICOLOR: 0 → TURN RED OFF. → RETURN

《END SUBROUTINE PARTMOV》



## 2.0 SUBROUTINES - REZONE

31

## 《SUBROUTINE REZONE》

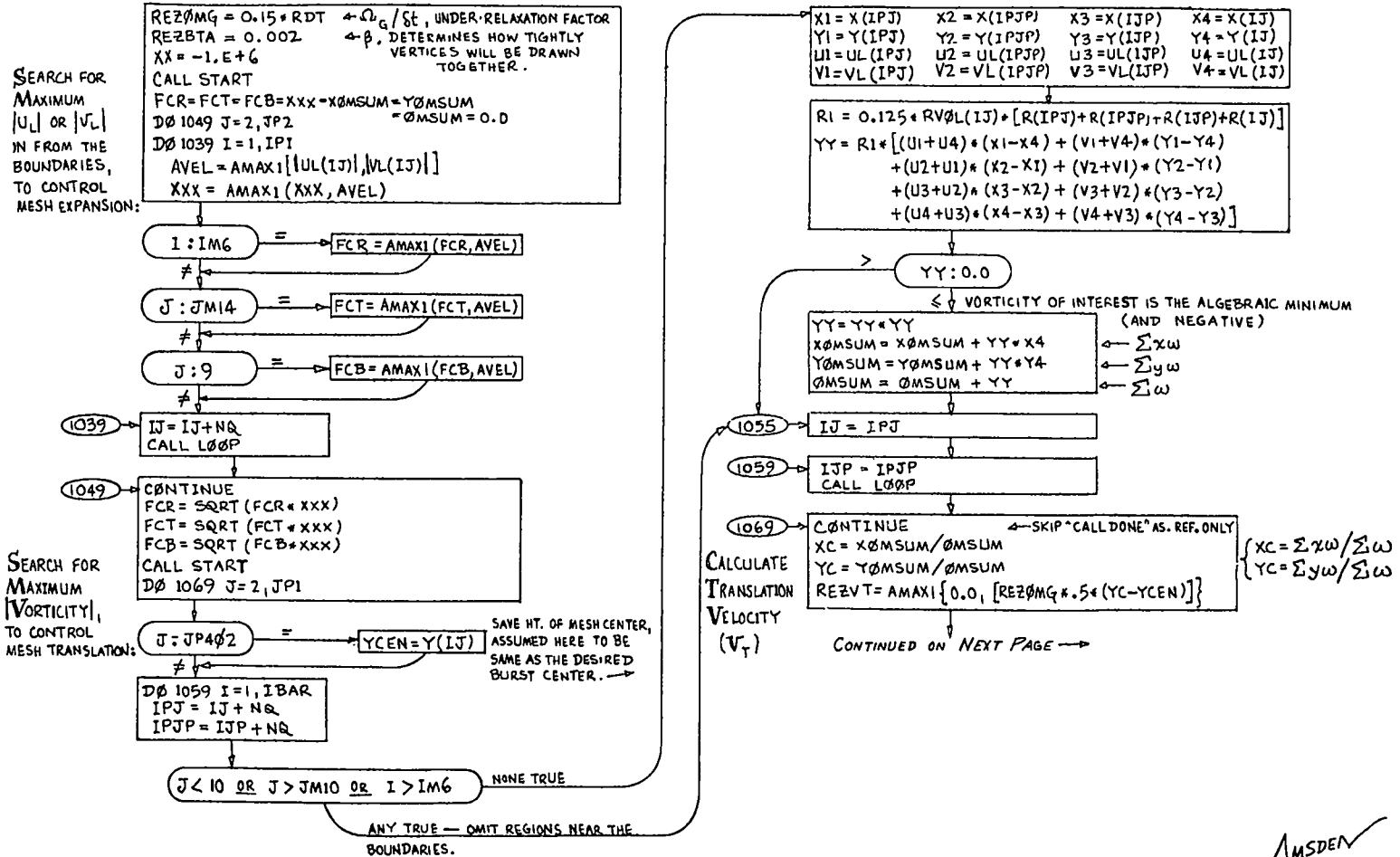

《SUBROUTINE REZONE》 - PAGE 2

$U_g, V_g$   
~~~~~

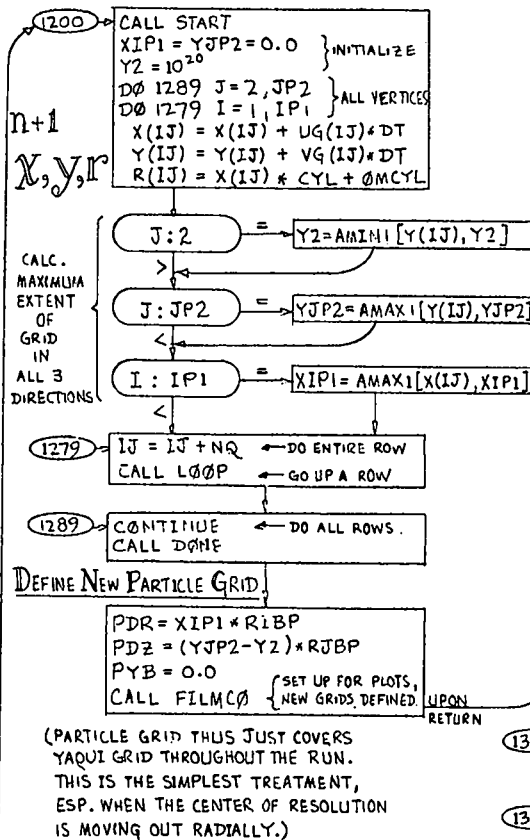
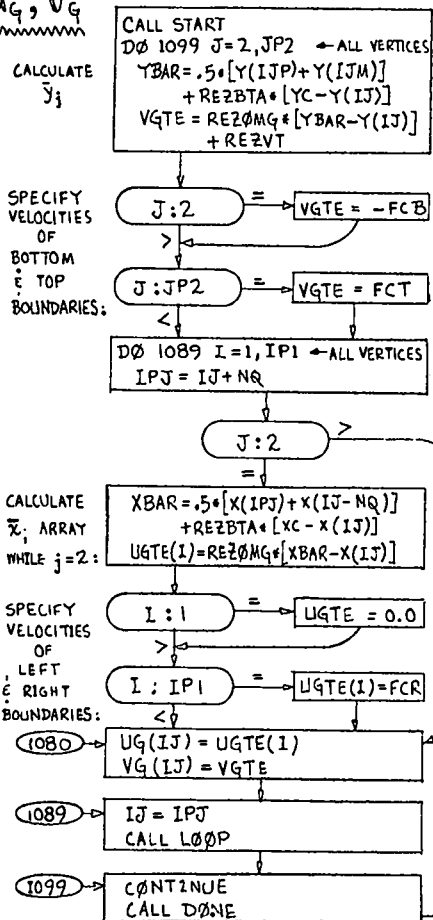

SET ρ_L IN EXTERIOR ZONES (USING THE
NEW COORDINATES):
~~~~~

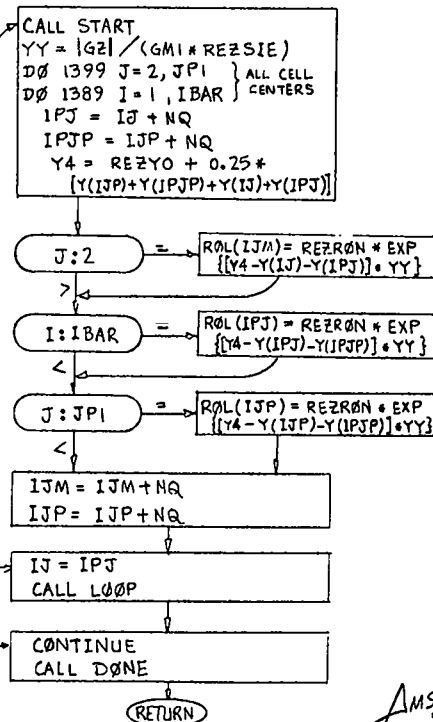

《END SUBROUTINE REZONE》

AMSDEN  
'72

APPENDIX B  
FORTRAN IV INDEX LISTING OF THE YAQUI PROGRAM

INDEX 01/12/73  
1

OVERLAY(YAQUFIL,0,0)  
1

PAGE 1  
YAQUI 00002

|       |          |                                                                                                                                                                                                                                                                                                                                                                                                                                                                                                                                                                                                                                                                                                                                                                                                                                                                      |                                                                                                                                                                                                                                                             |
|-------|----------|----------------------------------------------------------------------------------------------------------------------------------------------------------------------------------------------------------------------------------------------------------------------------------------------------------------------------------------------------------------------------------------------------------------------------------------------------------------------------------------------------------------------------------------------------------------------------------------------------------------------------------------------------------------------------------------------------------------------------------------------------------------------------------------------------------------------------------------------------------------------|-------------------------------------------------------------------------------------------------------------------------------------------------------------------------------------------------------------------------------------------------------------|
| INDEX | 01/12/73 | PROGRAM YAQUI(INP,OUT,FILM,FSET9=OUT,FSET12=FILM,FSET7,FSET8)                                                                                                                                                                                                                                                                                                                                                                                                                                                                                                                                                                                                                                                                                                                                                                                                        | PAGE 2                                                                                                                                                                                                                                                      |
| 1     |          | PROGRAM YAQUI(INP,OUT,FILM,FSET9=OUT,FSET12=FILM,FSET7,FSET8)                                                                                                                                                                                                                                                                                                                                                                                                                                                                                                                                                                                                                                                                                                                                                                                                        | YAQUI 00003                                                                                                                                                                                                                                                 |
| 2     |          | LCM/YLC1/ AA1(131000) /YLC2/ AA2(131000)                                                                                                                                                                                                                                                                                                                                                                                                                                                                                                                                                                                                                                                                                                                                                                                                                             | YAQUI 00004                                                                                                                                                                                                                                                 |
| 3     |          | COMMON /YSC1/ AASC(4242)                                                                                                                                                                                                                                                                                                                                                                                                                                                                                                                                                                                                                                                                                                                                                                                                                                             | COMMON2 00002                                                                                                                                                                                                                                               |
| 4     |          | COMMON /YSC2/ AA(1),ANC,ASQ,A0,A0FAC,A0M,B0,C0LAMU,CYL,<br>1 DR,DT,OTC,DTFAC,DTGR,DTGZ,DTGZP,DT0(10),DT0C(10),<br>2 DT016,DT02,DT04,DT08,DT0PS,DTV,DT8,DZ,EM10,EPS,FI8P,<br>3 FIPXL,FIPXR,FIPY8,FIPYT,FXL,FXR,FIY8,FIYT,FJ8P,<br>4 FREZ,GGM1,GM1,GR,GRDVEL,GZ,GZP,I,IRAR,:BP,IBP1,ICOLOR,<br>5 IDTO,TJ,IJM,IJP,IJPS,IMOME3,IMOMX,IM1,M6,<br>6 IPAR,IPXL,IPXR,IPY8,IPYT,IP1,IP2,ISCF1,ISCF2,ISCF3,<br>7 ITV,IUNF,IXL,IXR,IY8,IYT,J,JBAR,JRP,JB8P2,JCEN,JM10,<br>8 JM14,JP1,JP2,JP4,JP402,JUNF,JUNF02,KXI,LAM,LJP2,LP8,<br>9 LPR,MU,NAME(10),NCYC,NLC,NPS,NPT,NQ,NQI,NQIR,NQT2,NSC,<br>1 NUMIT,NUMT0,OM,OMANC,OMCYL,OMEM10,OPEM:0,PDR,PDZ,PXCONV,<br>2 PXL,PXR,PXRP,PY8,PY8M,PYCONV,PYT,PYTP,ROD,REZRDN,REZSIE,<br>3 REZUE,REZVE,REZVT,REZY0,RIRAR,RIBJR,RIRP,RJ8P,ROMFR,<br>4 RON,RPDR,RPDR0Z,RPDZ,T,THIRD,TLIND,TOUT,TWFIN,T20MD,<br>5 VV,XCONV,XL,XR,Y8,YCONV,YT,ZZ | COMMON2 00003<br>COMMON2 00004<br>COMMON2 00005<br>COMMON2 00006<br>COMMON2 00007<br>COMMON2 00008<br>COMMON2 00009<br>COMMON2 00010<br>COMMON2 00011<br>COMMON2 00012<br>COMMON2 00013<br>COMMON2 00014<br>COMMON2 00015<br>COMMON2 00016<br>COMMON2 00017 |
| 5     |          | EQUIVALENC (AASC(1),X,XPAR),(AASC(2),R,YPAR),(AASC(3),Y,MPAR),<br>1 (AASC(4),U,UG,0ELSM),(AASC(5),V,VG),(AASC(6),RD),<br>2 (AASC(7),SIE,MP,RMP,RCSQ),(AASC(8),E,ETIL),<br>3 (AASC(9),RVOL),(AASC(10),M,RM,VP),(AASC(11),P,PL,EP,<br>4 UP,PM0),(AASC(12),UTIL,UL,CQ,PMX,PU),(AASC(13),VTIL,<br>5 VL,PHY,PV),(AASC(14),Q,R0L)                                                                                                                                                                                                                                                                                                                                                                                                                                                                                                                                          | EQVREAL 00002<br>EQVREAL 00003<br>EQVREAL 00004<br>EQVREAL 00005<br>EQVREAL 00006<br>EQVREAL 00007<br>EQVREAL 00008                                                                                                                                         |
| 6     |          | REAL LAM,LAMD,M,MB,MC,ML,MP,MPAR,MR,MT,MTE,MU,MU02,MUD4                                                                                                                                                                                                                                                                                                                                                                                                                                                                                                                                                                                                                                                                                                                                                                                                              | EQVREAL 00009                                                                                                                                                                                                                                               |
| 7     |          | NQ = 14                                                                                                                                                                                                                                                                                                                                                                                                                                                                                                                                                                                                                                                                                                                                                                                                                                                              | YAQUI 00007                                                                                                                                                                                                                                                 |
| 8     |          | PRINT 100                                                                                                                                                                                                                                                                                                                                                                                                                                                                                                                                                                                                                                                                                                                                                                                                                                                            | YAQUI 00008                                                                                                                                                                                                                                                 |
| 9     | 10       | READ 110, IBAR,JBAR,IUNF,JUNF,JCEN,DR,DZ,CYL,SRDVEL,A0,A0M,B0,KXI                                                                                                                                                                                                                                                                                                                                                                                                                                                                                                                                                                                                                                                                                                                                                                                                    | YAQUI 00009                                                                                                                                                                                                                                                 |
| 10    |          | CALL ADV(3)                                                                                                                                                                                                                                                                                                                                                                                                                                                                                                                                                                                                                                                                                                                                                                                                                                                          | YAQUI 00010                                                                                                                                                                                                                                                 |
| 11    |          | CALL LINCNT(64)                                                                                                                                                                                                                                                                                                                                                                                                                                                                                                                                                                                                                                                                                                                                                                                                                                                      | YAQUI 00011                                                                                                                                                                                                                                                 |
| 12    |          | IF (IRAR) 40,30,20                                                                                                                                                                                                                                                                                                                                                                                                                                                                                                                                                                                                                                                                                                                                                                                                                                                   | YAQUI 00012                                                                                                                                                                                                                                                 |
| 13    | 20       | CALL OVERLAY (7LYAQUFIL,1,0,0)                                                                                                                                                                                                                                                                                                                                                                                                                                                                                                                                                                                                                                                                                                                                                                                                                                       | YAQUI 00013                                                                                                                                                                                                                                                 |
| 14    | 30       | CALL OVERLAY (7LYAQUFIL,2,0,0)                                                                                                                                                                                                                                                                                                                                                                                                                                                                                                                                                                                                                                                                                                                                                                                                                                       | YAQUI 00014                                                                                                                                                                                                                                                 |
| 15    |          | GO TO 10                                                                                                                                                                                                                                                                                                                                                                                                                                                                                                                                                                                                                                                                                                                                                                                                                                                             | YAQUI 00015                                                                                                                                                                                                                                                 |
| 16    | 40       | CALL EMPTY                                                                                                                                                                                                                                                                                                                                                                                                                                                                                                                                                                                                                                                                                                                                                                                                                                                           | YAQUI 00016                                                                                                                                                                                                                                                 |
|       | C        |                                                                                                                                                                                                                                                                                                                                                                                                                                                                                                                                                                                                                                                                                                                                                                                                                                                                      | YAQUI 00017                                                                                                                                                                                                                                                 |
| 17    | 100      | FORMAT (1H1)                                                                                                                                                                                                                                                                                                                                                                                                                                                                                                                                                                                                                                                                                                                                                                                                                                                         | YAQUI 00018                                                                                                                                                                                                                                                 |
| 18    | 110      | FORMAT (5I4,7F8.3,I4)                                                                                                                                                                                                                                                                                                                                                                                                                                                                                                                                                                                                                                                                                                                                                                                                                                                | YAQUI 00019                                                                                                                                                                                                                                                 |
| 19    |          | END                                                                                                                                                                                                                                                                                                                                                                                                                                                                                                                                                                                                                                                                                                                                                                                                                                                                  | YAQUI 00020                                                                                                                                                                                                                                                 |

| INDEX                       | 01/12/73 | PROGRAM | YAQUI   | (INP,OUT,FILM,FSET9=OUT,FSET12=FILM,FSET7,FSET8) | PAGE   | 3                                                           |
|-----------------------------|----------|---------|---------|--------------------------------------------------|--------|-------------------------------------------------------------|
| SINGLY REFERENCED VARIABLES |          |         |         |                                                  |        |                                                             |
| AA                          | ()R      | 4C0     | EPS     | -R 4C0                                           | IJM    | -I 4C0 JP1 -I 4C0 NUMTD -I 4C0 READ - 9F U -R 5EQ           |
| AA1                         | ()R      | 2LC     | EQUIVAL | - 5F                                             | IJP    | -I 4C0 JP2 -I 4C0 0M -R 4C0 REAL - 6F UG -R 5EQ             |
| AA2                         | ()R      | 2LC     | ETTL    | -R 5EQ                                           | IJPS   | -I 4C0 JP4 -I 4C0 0MANC -R 4C0 REZRON -R 4C0 UL -R 5EQ      |
| ADV                         | -        | 10SU    | FIRP    | -R 4C0                                           | IMOME3 | -I 4C0 JP402 -I 4C0 0MAYL -R 4C0 REZSIE -R 4C0 UP -R 5EQ    |
| ANC                         | -R       | 4C0     | FIPXL   | -R 4C0                                           | IMOMX  | -I 4C0 JUNF02 -I 4C0 0MEM10 -R 4C0 REZUE -R 4C0 UTIL -R 5EQ |
| ASQ                         | -R       | 4C0     | FIPXR   | -R 4C0                                           | IM1    | -I 4C0 LAM0 -R 6RL 0PEM10 -R 4C0 REZVE -R 4C0 V -R 5EQ      |
| AOFAC                       | -R       | 4C0     | FIPYB   | -R 4C0                                           | IM6    | -I 4C0 LCM - 2F P -R 5EQ REZVT -R 4C0 VG -R 5EQ             |
| COLAMU                      | -R       | 4C0     | FIPYT   | -R 4C0                                           | INP    | -I 1AG LINCNT - 11SU PDR -R 4C0 RFZY0 -R 4C0 VL -R 5EQ      |
| CQ                          | -R       | 5EQ     | FTXL    | -R 4C0                                           | IPAR   | -I 4C0 LJP2 -I 4C0 PDZ -R 4C0 RIBAR -R 4C0 VP -R 5EQ        |
| DELISH                      | -R       | 5EQ     | FTXR    | -R 4C0                                           | IPXL   | -I 4C0 LP8 -I 4C0 PL -R 5EQ RIBJ8 -R 4C0 VTIL -R 5EQ        |
| DT                          | -R       | 4C0     | FTYR    | -R 4C0                                           | IPXR   | -I 4C0 LPR -I 4C0 PMX -R 5EQ RIRP -R 4C0 VV -R 4C0          |
| DTC                         | -R       | 4C0     | F1YT    | -R 4C0                                           | IPYB   | -I 4C0 MB -R 6RL PMY -R 5EQ RJAP -R 4C0 X -R 5EQ            |
| DTFAC                       | -R       | 4C0     | FJBP    | -R 4C0                                           | TPYT   | -I 4C0 MC -R 6RL PM0 -R 5EQ RM -R 5EQ XCONV -R 4C0          |
| DTGR                        | -R       | 4C0     | FREZ    | -R 4C0                                           | IP1    | -I 4C0 ML -R 6RL PRINT - 8F RMP -R 5EQ XL -R 4C0            |
| DTGZ                        | -R       | 4C0     | FSET12  | -R 1AG                                           | IP2    | -I 4C0 MR -R 6RL PU -R 5EQ RO -R 5EQ XPAR -R 5EQ            |
| DTGZP                       | -R       | 4C0     | FSET7   | -R 1AG                                           | ISCF1  | -I 4C0 MT -R 6RL PV -R 5EQ R0L -R 5EQ XR -R 4C0             |
| DTO                         | ()R      | 4C0     | FSET8   | -R 1AG                                           | ISCF2  | -I 4C0 NTE -R 6RL PXC0NV -R 4C0 ROMFR -R 4C0 Y -R 5EQ       |
| DTOC                        | ()R      | 4C0     | FSET9   | -R 1AG                                           | TSC2   | -I 4C0 MU02 -R 6RL PXL -R 4C0 RON -R 4C0 YAQUI - 1SU        |
| DT016                       | -R       | 4C0     | GGM1    | -R 4C0                                           | TSC3   | -I 4C0 MU04 -R 6RL PXR -R 4C0 RPDR -R 4C0 Y8 -R 4C0         |
| DT02                        | -R       | 4C0     | GM1     | -R 4C0                                           | ITV    | -I 4C0 NAME (I)I 4C0 PXR -R 4C0 RP0RDZ -R 4C0 YCONV -R 4C0  |
| DT04                        | -R       | 4C0     | GR      | -R 4C0                                           | IXL    | -I 4C0 NCYC -I 4C0 PY8 -R 4C0 RP0Z -R 4C0 YLC1 -R 2CN       |
| DT0A                        | -R       | 4C0     | GZ      | -R 4C0                                           | IXR    | -I 4C0 NLC -I 4C0 PYRM -R 4C0 RVOL -R 5EQ YLC2 -R 2CN       |
| DTPOS                       | -R       | 4C0     | GZP     | -R 4C0                                           | IYB    | -I 4C0 NPS -I 4C0 PYCONV -R 4C0 SIE -R 5EQ YPAR -R 5EQ      |
| DTV                         | -R       | 4C0     | I       | -I 4C0                                           | TYT    | -I 4C0 NPT -I 4C0 PYT -R 4C0 T -R 4C0 YSC1 -R 3CN           |
| DTB                         | -R       | 4C0     | IRP     | -I 4C0                                           | J      | -I 4C0 NQT -I 4C0 PYTP -R 4C0 TH1RD -R 4C0 YSC2 -R 4CN      |
| E                           | -R       | 5EQ     | IRP1    | -I 4C0                                           | JBP    | -I 4C0 NQIA -I 4C0 Q -R 5EQ TLIND -R 4C0 YT -R 4C0          |
| EMPTY                       | -        | 16SU    | ICOLOR  | -I 4C0                                           | JBP2   | -I 4C0 NQI2 -I 4C0 R -R 5EQ TOUT -R 4C0 ZZ -R 4C0           |
| FM10                        | -R       | 4C0     | INT0    | -I 4C0                                           | JM10   | -I 4C0 NSC -I 4C0 RCSQ -R 5EQ TWFIN -R 4C0                  |
| FP                          | -R       | 5EQ     | IJ      | -I 4C0                                           | JM14   | -I 4C0 NUMIT -I 4C0 RDT -R 4C0 T20ND -R 4C0                 |

## MULTIPLY-REFERENCED VARIABLES

|        |     |     |     |     |     |     |     |     |     |     |     |     |     |     |     |     |
|--------|-----|-----|-----|-----|-----|-----|-----|-----|-----|-----|-----|-----|-----|-----|-----|-----|
| 10     | -   | 9*  | 15  |     |     |     |     |     |     |     |     |     |     |     |     |     |
| 20     | *   | 12  | 13* |     |     |     |     |     |     |     |     |     |     |     |     |     |
| 30     | -   | 12  | 14* |     |     |     |     |     |     |     |     |     |     |     |     |     |
| 40     | -   | 12  | 16* |     |     |     |     |     |     |     |     |     |     |     |     |     |
| 100    | -   | RPR | 17* |     |     |     |     |     |     |     |     |     |     |     |     |     |
| 110    | -   | 9RD | 18* |     |     |     |     |     |     |     |     |     |     |     |     |     |
| AASC   | ()R | 3C0 | 5EQ | 5EQ | 5EQ | 5EQ | 5EQ | 5EQ | 5EQ | 5EQ | 5EQ | 5EQ | 5EQ | 5EQ | 5EQ | 5EQ |
| A0     | -R  | 4C0 | 9RD |     |     |     |     |     |     |     |     |     |     |     |     |     |
| A0M    | -R  | 4C0 | 9RD |     |     |     |     |     |     |     |     |     |     |     |     |     |
| R0     | -R  | 4C0 | 9RD |     |     |     |     |     |     |     |     |     |     |     |     |     |
| COMMON | -   | 3F  | 4F  |     |     |     |     |     |     |     |     |     |     |     |     |     |
| CYL    | -R  | 4C0 | 9RD |     |     |     |     |     |     |     |     |     |     |     |     |     |
| OR     | -R  | 4C0 | 9RD |     |     |     |     |     |     |     |     |     |     |     |     |     |
| OZ     | -R  | 4C0 | 9RD |     |     |     |     |     |     |     |     |     |     |     |     |     |
| FILM   | -R  | 1AG | 1AG |     |     |     |     |     |     |     |     |     |     |     |     |     |
| GROVEL | -R  | 4C0 | 9RD |     |     |     |     |     |     |     |     |     |     |     |     |     |
| IBAR   | -I  | 4C0 | 9RD | 12  |     |     |     |     |     |     |     |     |     |     |     |     |
| TUNF   | -I  | 4C0 | 9RD |     |     |     |     |     |     |     |     |     |     |     |     |     |
| JBAR   | -I  | 4C0 | 9RD |     |     |     |     |     |     |     |     |     |     |     |     |     |
| JCFN   | -I  | 4C0 | 9RD |     |     |     |     |     |     |     |     |     |     |     |     |     |
| JUNF   | -I  | 4C0 | 9RD |     |     |     |     |     |     |     |     |     |     |     |     |     |
| KXI    | -I  | 4C0 | 9RD |     |     |     |     |     |     |     |     |     |     |     |     |     |
| LAM    | -R  | 4C0 | 6RL |     |     |     |     |     |     |     |     |     |     |     |     |     |
| M      | -R  | 5EQ | 6RL |     |     |     |     |     |     |     |     |     |     |     |     |     |
| MP     | -R  | 5EQ | 6RL |     |     |     |     |     |     |     |     |     |     |     |     |     |
| MPAR   | -R  | 5EQ | 6RL |     |     |     |     |     |     |     |     |     |     |     |     |     |

| INDEX   | 01/12/73 | PROGRAM | YAQUI | (INP,OUT,FILM,FSET9=OUT,FSET12=FILM,FSET7,FSET8) | PAGE | 4 |
|---------|----------|---------|-------|--------------------------------------------------|------|---|
| MU      | -R       | 4C0     | 6RL   |                                                  |      |   |
| NQ      | -I       | 4C0     | 7*    |                                                  |      |   |
| OUT     | -R       | 1AG     | 1AG   |                                                  |      |   |
| OVERLAY | -        | 13SU    | 14SU  |                                                  |      |   |

| INDEX | 01/12/73 | SUBROUTINE LOOP                                          | SUBROUTINE LOOP | PAGE | 5 |
|-------|----------|----------------------------------------------------------|-----------------|------|---|
|       | 1        | COMMON /YSC1/ AASC(4242)                                 | YAQUI 00021     |      |   |
|       | 2        |                                                          | COMMON2 00002   |      |   |
|       | 3        | COMMON /YSC2/ AA(1),ANC,ASQ,A0,A0FAC,A0M,R0,COLAMU,CYL,  | COMMON2 00003   |      |   |
|       | 1        | DR,DT,OTC,DTFAC,DTGR,DTGZ,DTGZP,DT0(10),DT0C(10),        | COMMON2 00004   |      |   |
|       | 2        | DT016,DT02,DT04,DT0R,DT0PS,DTV,DTR,DZ,EM10,EPS,FI8P,     | COMMON2 00005   |      |   |
|       | 3        | FIPXL,FIPXR,FIPYR,FIPYT,FIKL,FIKR,FIY8,FTYT,FJ8P,        | COMMON2 00006   |      |   |
|       | 4        | FRZ,GGM1,GH1,GR,GROVEL,GZ,GZP,I,IHAR,IRP,IHP1,ICOLOR,    | COMMON2 00007   |      |   |
|       | 5        | IDTO,IJ,IJM,IJP,IJPS,IMOME3,IMDMX,IM),TM6,               | COMMON2 00008   |      |   |
|       | 6        | IPAR,IPXL,IPXR,IPYR,IPYT,IP1,IP2,ISCF1,ISCF2,ISC2,ISC3,  | COMMON2 00009   |      |   |
|       | 7        | ITV,IUNF,IXL,IXR,IYR,IYT,J,JBAR,JBP,JBP2,JCEN,JM10,      | COMMON2 00010   |      |   |
|       | 8        | JM14,JP1,JP2,JP4,JP402,JUNF,JUNF02,KXI,LAM,LJP2,LPR,     | COMMON2 00011   |      |   |
|       | 9        | LPR,MU,NAMF(10),NCYC,NLC,NPS,NPT,NU,NQ1,NQ18,NQ1Z,NSC,   | COMMON2 00012   |      |   |
|       | 1        | NUMIT,NUMTD,OM,OMANC,OMCYL,OMEM10,OPEM10,PDR,P0Z,PXCONV, | COMMON2 00013   |      |   |
|       | 2        | PXL,PXR,PXRP,PY8,PY8M,PYCONV,PYT,PYTP,ROT,REZRON,RFZSIE, | COMMON2 00014   |      |   |
|       | 3        | RFZIE,REZVE,REZVT,REZY0,RI8AR,RI8JR,RI8P,RJRP,ROMFR,     | COMMON2 00015   |      |   |
|       | 4        | RON,RPDR,RPDRDZ,RPDZ,T,THIRD,TLIMD,TOUT,TWFIN,TZ0M0,     | COMMON2 00016   |      |   |
|       | 5        | VV,XCONV,XL,XR,Y8,YCONV,YT,ZZ                            | COMMON2 00017   |      |   |
|       | 4        | CALL ECWR (AASC(IJMS),IECW,NQI,NE)                       | YAQUI 00023     |      |   |
|       | 5        | IECW = IECW + NQI                                        | YAQUI 00024     |      |   |
|       | 6        | GO TO (10,20,30) I8UF                                    | YAQUI 00025     |      |   |
|       | 7        | 10 IJP = IJPS = 1                                        | YAQUI 00026     |      |   |
|       | 8        | IJ = ISC3                                                | YAQUI 00027     |      |   |
|       | 9        | IJM = IJMS = ISC2                                        | YAQUI 00028     |      |   |
|       | 10       | I8UF = 2                                                 | YAQUI 00029     |      |   |
|       | 11       | GO TO 40                                                 | YAQUI 00030     |      |   |
|       | 12       | 20 IJP = IJPS = ISC2                                     | YAQUI 00031     |      |   |
|       | 13       | IJ = 1                                                   | YAQUI 00032     |      |   |
|       | 14       | IJM = IJMS = ISC3                                        | YAQUI 00033     |      |   |
|       | 15       | I8UF = 3                                                 | YAQUI 00034     |      |   |
|       | 16       | GO TO 40                                                 | YAQUI 00035     |      |   |
|       | 17       | ENTRY START                                              | YAQUI 00036     |      |   |
|       | 18       | IJPS = 1                                                 | YAQUI 00037     |      |   |
|       | 19       | IECR = IECW = 0                                          | YAQUI 00038     |      |   |
|       | 20       | CALL ECRD (AASC(IJPS),IECR,NQI,NE)                       | YAQUI 00039     |      |   |
|       | 21       | IECR = IECR + NQI                                        | YAQUI 00040     |      |   |
|       | 22       | IJPS = ISC2                                              | YAQUI 00041     |      |   |
|       | 23       | CALL ECRD (AASC(IJPS),IECR,NQI,NE)                       | YAQUI 00042     |      |   |
|       | 24       | IECR = IECR + NQI                                        | YAQUI 00043     |      |   |
|       | 25       | 30 IJP = IJPS = ISC3                                     | YAQUI 00044     |      |   |
|       | 26       | IJ = ISC2                                                | YAQUI 00045     |      |   |
|       | 27       | IJM = IJMS = I8UF = 1                                    | YAQUI 00046     |      |   |
|       | 28       | 40 CALL ECRD (AASC(IJPS),IECR,NQI,NE)                    | YAQUI 00047     |      |   |
|       | 29       | IECR = IECR + NQI                                        | YAQUI 00048     |      |   |
|       | 30       | RETURN                                                   | YAQUI 00049     |      |   |
|       | 31       | ENTRY DONE                                               | YAQUI 00050     |      |   |
|       | 32       | CALL ECWR (AASC(IJMS),IECW,NQI,NE)                       | YAQUI 00051     |      |   |
|       | 33       | IECW = IECW + NQI                                        | YAQUI 00052     |      |   |
|       | 34       | GO TO (50,60,70) I8UF                                    | YAQUI 00053     |      |   |
|       | 35       | 50 IJMS = ISC2                                           | YAQUI 00054     |      |   |
|       | 36       | GO TO 80                                                 | YAQUI 00055     |      |   |
|       | 37       | 60 IJMS = ISC3                                           | YAQUI 00056     |      |   |
|       | 38       | GO TO 80                                                 | YAQUI 00057     |      |   |
|       | 39       | 70 IJMS = 1                                              | YAQUI 00058     |      |   |
|       | 40       | 80 CALL FCWR (AASC(IJMS),IECW,NQI,NE)                    | YAQUI 00059     |      |   |
|       | 41       | RETURN                                                   | YAQUI 00060     |      |   |
|       | 42       | ENTRY LOOPD                                              | YAQUI 00061     |      |   |
|       | 43       | 100 CALL FCWR (AASC(IJS),IECW,NQI,NE)                    | YAQUI 00062     |      |   |
|       | 44       | IECW = IECW + NQI                                        | YAQUI 00063     |      |   |

| INDEX | 01/12/73 | SUBROUTINE LOOP                    | PAGE  | 6     |
|-------|----------|------------------------------------|-------|-------|
| 45    |          | GO TO (110,120,140) IBUF           | YAQUI | 00064 |
| 46    | 110      | IBUF = 2                           | YAQUI | 00065 |
| 47    |          | IJ = ISCF1                         | YAQUI | 00066 |
| 48    |          | IJS = 1                            | YAQUI | 00067 |
| 49    |          | IJM = ISCF2                        | YAQUI | 00068 |
| 50    |          | IJMS = ISCF2                       | YAQUI | 00069 |
| 51    |          | GO TO 130                          | YAQUI | 00070 |
| 52    |          | ENTRY STARTD                       | YAQUI | 00071 |
| 53    |          | TJMS = ISCF2                       | YAQUI | 00072 |
| 54    |          | IECR = IECW = ITV                  | YAQUI | 00073 |
| 55    |          | CALL ECRD (AASC(IJMS),IECR,NQI,NE) | YAQUI | 00074 |
| 56    |          | IECR = IECR - NQI                  | YAQUI | 00075 |
| 57    | 120      | IJM = ISCF1                        | YAQUI | 00076 |
| 58    |          | IJMS = IRUF = 1                    | YAQUI | 00077 |
| 59    |          | IJ = ISCF2                         | YAQUI | 00078 |
| 60    |          | IJS = ISCF2                        | YAQUI | 00079 |
| 61    | 130      | IF (IECR.LT.0) GO TO 150           | YAQUI | 00080 |
| 62    |          | CALL ECRD (AASC(IJMS),IECR,NQI,NE) | YAQUI | 00081 |
| 63    |          | IECR = IECR - NQI                  | YAQUI | 00082 |
| 64    | 140      | RETURN                             | YAQUI | 00083 |
| 65    | 150      | IBUF = 3                           | YAQUI | 00084 |
| 66    |          | GO TO 100                          | YAQUI | 00085 |
| 67    |          | ENTRY R1ROW                        | YAQUI | 00086 |
| 68    |          | IEC = (J-1) * NQI                  | YAQUI | 00087 |
| 69    |          | CALL ECRD (AASC(I),IEC,NQI,NE)     | YAQUI | 00088 |
| 70    |          | RETURN                             | YAQUI | 00089 |
| 71    |          | ENTRY SETIJ                        | YAQUI | 00090 |
| 72    |          | IJ = (I-1) * NQ + 1                | YAQUI | 00091 |
| 73    |          | RETURN                             | YAQUI | 00092 |
| 74    |          | ENTRY W1ROW                        | YAQUI | 00093 |
| 75    |          | IEC = (J-1)*NQI                    | YAQUI | 00094 |
| 76    |          | CALL ECWR (AASC(I),IEC,NQI,NE)     | YAQUI | 00095 |
| 77    |          | RETURN                             | YAQUI | 00096 |
| 78    |          | END                                | YAQUI | 00097 |

| INDEX 01/12/73              |     |      | SUBROUTINE LOOP |    |     |        |    |     |        |     |      |        | PAGE 7 |     |        |    |      |        |    |      |
|-----------------------------|-----|------|-----------------|----|-----|--------|----|-----|--------|-----|------|--------|--------|-----|--------|----|------|--------|----|------|
| SINGLY REFERENCED VARIABLES |     |      |                 |    |     |        |    |     |        |     |      |        |        |     |        |    |      |        |    |      |
| AA                          | ()R | 3C0  | DTOR            | -R | 3C0 | GZ     | -R | 3C0 | IYT    | -I  | 3C0  | NCYC   | -I     | 3C0 | PYCONV | -R | 3C0  | STARTD | -  | 52SU |
| ANC                         | -R  | 3C0  | DTPOS           | -R | 3C0 | GZP    | -R | 3C0 | JBAR   | -I  | 3C0  | NLC    | -I     | 3C0 | PYT    | -R | 3C0  | T      | -R | 3C0  |
| ASQ                         | -R  | 3C0  | DYV             | -R | 3C0 | IBAR   | -I | 3C0 | JRP    | -I  | 3C0  | NPS    | -I     | 3C0 | PYTP   | -R | 3C0  | THIRD  | -R | 3C0  |
| A0                          | -R  | 3C0  | DTB             | -R | 3C0 | IBP    | -I | 3C0 | JRP2   | -I  | 3C0  | NPT    | -I     | 3C0 | RDT    | -R | 3C0  | TLMD   | -R | 3C0  |
| AOFAC                       | -R  | 3C0  | DZ              | -R | 3C0 | IBPI   | -I | 3C0 | JCEN   | -I  | 3C0  | NQIB   | -I     | 3C0 | REZRON | -R | 3C0  | TOUT   | -R | 3C0  |
| AOM                         | -R  | 3C0  | EM10            | -R | 3C0 | ICOLOR | -I | 3C0 | JM10   | -I  | 3C0  | NQI2   | -I     | 3C0 | REZSIE | -R | 3C0  | TWFIN  | -R | 3C0  |
| B0                          | -R  | 3C0  | EPS             | -R | 3C0 | IDT0   | -I | 3C0 | JM14   | -I  | 3C0  | NSC    | -I     | 3C0 | REZUE  | -R | 3C0  | TZ0MD  | -R | 3C0  |
| COLAMU                      | -R  | 3C0  | FIBP            | -R | 3C0 | IMOME3 | -I | 3C0 | JP1    | -I  | 3C0  | NIIMIT | -I     | 3C0 | REZVE  | -R | 3C0  | VV     | -R | 3C0  |
| CYL                         | -R  | 3C0  | FIPXL           | -R | 3C0 | IMOMX  | -I | 3C0 | JP2    | -I  | 3C0  | NUMTD  | -I     | 3C0 | RFZVT  | -R | 3C0  | WROW   | -  | 74SU |
| NONE                        | -   | 31SU | FIPXR           | -R | 3C0 | IMI    | -I | 3C0 | JP4    | -I  | 3C0  | OM     | -R     | 3C0 | REZY0  | -R | 3C0  | XCONV  | -R | 3C0  |
| DR                          | -R  | 3C0  | FIPYB           | -R | 3C0 | IM6    | -I | 3C0 | JP402  | -I  | 3C0  | OMANC  | -R     | 3C0 | RIBAR  | -R | 3C0  | XL     | -R | 3C0  |
| DT                          | -R  | 3C0  | FIPYT           | -R | 3C0 | IPAR   | -I | 3C0 | JUNF   | -I  | 3C0  | OMCYL  | -R     | 3C0 | RIBJ8  | -R | 3C0  | XR     | -R | 3C0  |
| OTC                         | -R  | 3C0  | FTXL            | -R | 3C0 | IPXL   | -I | 3C0 | JUNF02 | -I  | 3C0  | OMEM10 | -R     | 3C0 | RIBP   | -R | 3C0  | YB     | -R | 3C0  |
| OTFAC                       | -R  | 3C0  | FIXR            | -R | 3C0 | IPXR   | -I | 3C0 | KXI    | -I  | 3C0  | OPEM10 | -R     | 3C0 | RJ8P   | -R | 3C0  | YCONV  | -R | 3C0  |
| DTGR                        | -R  | 3C0  | FLYB            | -R | 3C0 | IPYB   | -I | 3C0 | LAM    | -I  | 3C0  | PDR    | -R     | 3C0 | ROMFR  | -R | 3C0  | YSC1   | -  | 2CN  |
| DTGZ                        | -R  | 3C0  | F1YT            | -R | 3C0 | IPYT   | -I | 3C0 | LJP2   | -I  | 3C0  | PDZ    | -R     | 3C0 | RON    | -R | 3C0  | YSC2   | -  | 3CN  |
| DTGZP                       | -R  | 3C0  | FJBP            | -R | 3C0 | IP1    | -I | 3C0 | L00P   | -   | 1SU  | PXCONV | -R     | 3C0 | RPDR   | -R | 3C0  | YT     | -R | 3C0  |
| DT0                         | ()R | 3C0  | FREZ            | -R | 3C0 | IP2    | -I | 3C0 | L00PD  | -   | 42SU | PXL    | -R     | 3C0 | RPDRDZ | -R | 3C0  | ZZ     | -R | 3C0  |
| DT0G                        | ()R | 3C0  | GM1             | -R | 3C0 | IUNF   | -I | 3C0 | LPB    | -I  | 3C0  | PXR    | -R     | 3C0 | RPDZ   | -R | 3C0  |        |    |      |
| DT016                       | -R  | 3C0  | GM1             | -R | 3C0 | IXL    | -I | 3C0 | LPR    | -I  | 3C0  | PXRP   | -R     | 3C0 | R1ROW  | -  | 67SU |        |    |      |
| DT02                        | -R  | 3C0  | GR              | -R | 3C0 | IXR    | -I | 3C0 | MU     | -I  | 3C0  | PYB    | -R     | 3C0 | SETIJ  | -  | 71SU |        |    |      |
| DT04                        | -R  | 3C0  | GROVEL          | -R | 3C0 | IYB    | -I | 3C0 | NAME   | ()I | 3C0  | PYBM   | -R     | 3C0 | START  | -  | 17SU |        |    |      |

MULTIPLY-REFERENCED VARIABLES

|        |     |      |      |      |      |      |      |      |      |      |      |      |      |     |      |    |      |     |  |  |  |
|--------|-----|------|------|------|------|------|------|------|------|------|------|------|------|-----|------|----|------|-----|--|--|--|
| 10     | -   | 6    | 7*   |      |      |      |      |      |      |      |      |      |      |     |      |    |      |     |  |  |  |
| 20     | -   | 6    | 12*  |      |      |      |      |      |      |      |      |      |      |     |      |    |      |     |  |  |  |
| 30     | -   | 6    | 25*  |      |      |      |      |      |      |      |      |      |      |     |      |    |      |     |  |  |  |
| 40     | -   | 11   | 16   | 28*  |      |      |      |      |      |      |      |      |      |     |      |    |      |     |  |  |  |
| 50     | -   | 34   | 35*  |      |      |      |      |      |      |      |      |      |      |     |      |    |      |     |  |  |  |
| 60     | -   | 34   | 37*  |      |      |      |      |      |      |      |      |      |      |     |      |    |      |     |  |  |  |
| 70     | -   | 34   | 39*  |      |      |      |      |      |      |      |      |      |      |     |      |    |      |     |  |  |  |
| 80     | -   | 36   | 38   | 40*  |      |      |      |      |      |      |      |      |      |     |      |    |      |     |  |  |  |
| 100    | -   | 43*  | 66   |      |      |      |      |      |      |      |      |      |      |     |      |    |      |     |  |  |  |
| 110    | -   | 45   | 46*  |      |      |      |      |      |      |      |      |      |      |     |      |    |      |     |  |  |  |
| 120    | -   | 45   | 57*  |      |      |      |      |      |      |      |      |      |      |     |      |    |      |     |  |  |  |
| 130    | -   | 51   | 61*  |      |      |      |      |      |      |      |      |      |      |     |      |    |      |     |  |  |  |
| 140    | -   | 45   | 64*  |      |      |      |      |      |      |      |      |      |      |     |      |    |      |     |  |  |  |
| 150    | -   | 61   | 65*  |      |      |      |      |      |      |      |      |      |      |     |      |    |      |     |  |  |  |
| AASC   | ()R | 2C0  | 4AG  | 20AG | 23AG | 28AG | 32AG | 40AG | 43AG | 55AG | 62AG | 69AG | 76AG |     |      |    |      |     |  |  |  |
| COMMON | -   | 2F   | 3F   |      |      |      |      |      |      |      |      |      |      |     |      |    |      |     |  |  |  |
| ECRD   | -   | 20SU | 23SU | 28SU | 55SU | 62SU | 69SU |      |      |      |      |      |      |     |      |    |      |     |  |  |  |
| ECWR   | -   | 4SU  | 32SU | 40SU | 43SU | 76SU |      |      |      |      |      |      |      |     |      |    |      |     |  |  |  |
| FNTRY  | -   | 17F  | 31F  | 42F  | 52F  | 67F  | 71F  | 74F  |      |      |      |      |      |     |      |    |      |     |  |  |  |
| I      | -I  | 3C0  | 72   |      |      |      |      |      |      |      |      |      |      |     |      |    |      |     |  |  |  |
| IBUF   | -I  | 6    | 10=  | 15=  | 27=  | 34   | 45   | 46=  | 58=  | 65=  |      |      |      |     |      |    |      |     |  |  |  |
| IEC    | -I  | 68=  | 69AG | 75=  | 76AG |      |      |      |      |      |      |      |      |     |      |    |      |     |  |  |  |
| TECR   | -I  | 19=  | 20AG | 21=  | 21   | 23AG | 24=  | 24   | 28AG | 29=  | 29   | 54=  | 55AG | 56= | 56   | 61 | 62AG | 63= |  |  |  |
|        |     | 63   |      |      |      |      |      |      |      |      |      |      |      |     |      |    |      |     |  |  |  |
| IECW   | -I  | 4AG  | 5=   | 5    | 19=  | 32AG | 33=  | 33   | 40AG | 43AG | 44=  | 44   | 54=  |     |      |    |      |     |  |  |  |
| TJ     | -I  | 3C0  | 8=   | 13=  | 26=  | 47=  | 59=  | 72=  |      |      |      |      |      |     |      |    |      |     |  |  |  |
| TJM    | -I  | 3C0  | 9=   | 14=  | 27=  | 49=  | 57=  |      |      |      |      |      |      |     |      |    |      |     |  |  |  |
| IJMS   | -I  | 4AG  | 9=   | 14=  | 27=  | 32AG | 35=  | 37=  | 39=  | 40AG | 50=  | 53=  | 55AG | 58= | 62AG |    |      |     |  |  |  |
| TJP    | -I  | 3C0  | 7=   | 12=  | 25=  |      |      |      |      |      |      |      |      |     |      |    |      |     |  |  |  |
| IJPS   | -I  | 3C0  | 7=   | 12=  | 18=  | 20AG | 22=  | 23AG | 25=  | 28AG |      |      |      |     |      |    |      |     |  |  |  |
| IJS    | -I  | 43AG | 48=  | 60=  |      |      |      |      |      |      |      |      |      |     |      |    |      |     |  |  |  |
| TSCF1  | -I  | 3C0  | 47   | 57   |      |      |      |      |      |      |      |      |      |     |      |    |      |     |  |  |  |
| ISCF2  | -I  | 3C0  | 49   | 59   |      |      |      |      |      |      |      |      |      |     |      |    |      |     |  |  |  |

| INDEX 01/12/73 |    |     | SUBROUTINE LOOP |      |      |      |      |      |      |      |      |      | PAGE 8 |      |    |      |    |      |  |  |  |
|----------------|----|-----|-----------------|------|------|------|------|------|------|------|------|------|--------|------|----|------|----|------|--|--|--|
| ISC2           | -I | 3C0 | 9               | 12   | 22   | 26   | 35   | 50   | 53   | 60   |      |      |        |      |    |      |    |      |  |  |  |
| ISC3           | -I | 3C0 | 8               | 14   | 25   | 37   |      |      |      |      |      |      |        |      |    |      |    |      |  |  |  |
| TTV            | -I | 3C0 | 54              |      |      |      |      |      |      |      |      |      |        |      |    |      |    |      |  |  |  |
| J              | -I | 3C0 | 68              | 75   |      |      |      |      |      |      |      |      |        |      |    |      |    |      |  |  |  |
| NE             | -I | 4AG | 20AG            | 23AG | 28AG | 32AG | 40AG | 43AG | 55AG | 62AG | 69AG | 76AG |        |      |    |      |    |      |  |  |  |
| NG             | -I | 3C0 | 72              |      |      |      |      |      |      |      |      |      |        |      |    |      |    |      |  |  |  |
| NOI            | -I | 3C0 | 4AG             | 5    | 20AG | 27   | 23AG | 24   | 28AG | 29   | 32AG | 33   | 40AG   | 43AG | 44 | 55AG | 56 | 62AG |  |  |  |
|                |    | 63  | 68              | 69AG | 75   | 76AG |      |      |      |      |      |      |        |      |    |      |    |      |  |  |  |
| RETURN         | -  | 30F | 41F             | 64F  | 70F  | 73F  | 77F  |      |      |      |      |      |        |      |    |      |    |      |  |  |  |



INDEX 01/12/73

|    | SUBROUTINE FILMCO                                               | SUBROUTINE FILMCO | PAGE          |
|----|-----------------------------------------------------------------|-------------------|---------------|
| 1  | COMMON /YSC1/ AASC(4242)                                        |                   | 9             |
| 2  | COMMON /YSC2/ AA(1),ANC,ASQ,A0,A0FAC,A0M,RC,COLAMU,CYL,         |                   | 00098         |
| 3  | DR,DT,DTC,DTFAC,DTGR,DTGZ,DTGZP,DT0(10),DTC(10),                |                   | COMMON2 00002 |
| 4  | DT016,DT02,DT04,DT08,DTPOS,DTV,DTR,DZ,EM10,EPS,FI8P,            |                   | COMMON2 00003 |
| 5  | FIPXL,FTPXR,FIPY8,FIPT,FXL,FXR,FIY8,FIYT,FJ8P,                  |                   | COMMON2 00004 |
| 6  | FREZ,GGM1,GMI,GR,GROVEL,GZ,GZP,I,IRAR,IRP,IBP1,ICOLOR,          |                   | COMMON2 00005 |
| 7  | IDT0,IJ,IJM,IJP,IJPS,IM0E3,IM0MX,IP1,IM6,                       |                   | COMMON2 00006 |
| 8  | IPAR,IPXL,IPXR,IPY8,IPYT,IP1,IP2,ISCF1,ISCF2,ISC2,ISC3,         |                   | COMMON2 00007 |
| 9  | ITV,IUNF,IXL,IXR,IYR,IYT,J,JBAR,JBP,JBP2,JCEN,JM10,             |                   | COMMON2 00008 |
| 10 | JM14,JP1,JP2,JP4,JP402,JUNF,JUNF02,KXI,LAM,LJP2,LPR,            |                   | COMMON2 00009 |
| 11 | LPR,MU,NAME(10),NCYC,NLC,NPS,NPT,NI,NQT,NQ18,NQ12,NSC,          |                   | COMMON2 00010 |
| 12 | NUMIT,NUMTD,OM,OMANC,OMCYL,OMEM10,OPEM10,PDR,PDZ,PXCONV,        |                   | COMMON2 00011 |
| 13 | PXL,PXR,PXRP,PY8,PYRM,PYCONV,PYT,PYTP,ROT,REZRON,REZSIE,        |                   | COMMON2 00012 |
| 14 | REZIE,REZVE,REZVT,REZY0,RIBAR,RIRJA,RIRP,RJRP,ROMFR,            |                   | COMMON2 00013 |
| 15 | RON,RPDR,RPDR0Z,RPDZ,T,THIRO,TLTMD,TOUT,TWFIN,T20MD,            |                   | COMMON2 00014 |
| 16 | VV,XCONV,XL,XR,Y8,YCONV,YT,ZZ                                   |                   | COMMON2 00015 |
| 17 | EQUIVALENCE (AASC(1),X,XPAR),(AASC(2),R,YPAR),(AASC(3),Y,MPAR), |                   | COMMON2 00016 |
| 18 | (AASC(4),U,UG,DELSM),(AASC(5),V,VG),(AASC(6),RO),               |                   | COMMON2 00017 |
| 19 | (AASC(7),STE,MP,RMP,RCSQ),(AASC(8),E,ETIL),                     |                   | COMMON2 00018 |
| 20 | (AASC(9),RVOL),(AASC(10),M,RM,VP),(AASC(11),P,PL,EP,            |                   | COMMON2 00019 |
| 21 | JP,PM0),(AASC(12),UTIL,UL,CQ,PMX,PU),(AASC(13),VTIL,            |                   | COMMON2 00020 |
| 22 | VL,PMY,PV),(AASC(14),Q,ROL)                                     |                   | COMMON2 00021 |
| 23 | REAL LAM,LAMD,M,MR,MC,ML,MP,MPAR,MR,MT,MTE,MU,MU02,MU04         |                   | COMMON2 00022 |
| 24 | DIMENSION X(1),XPAR(1),R(1),YPAR(1),Y(1),MPAR(1),U(1),UG(1),    |                   | COMMON2 00023 |
| 25 | DELSM(1),V(1),VG(1),RO(1),SIE(1),MP(1),RMP(1),RCSQ(1),          |                   | COMMON2 00024 |
| 26 | E(1),ETIL(1),RVOL(1),M(1),RM(1),VP(1),P(1),PL(1),EP(1),         |                   | COMMON2 00025 |
| 27 | UP(1),UTIL(1),UL(1),CQ(1),PMX(1),PU(1),VTIL(1),VL(1),           |                   | COMMON2 00026 |
| 28 | PMY(1),PV(1),Q(1),ROL(1),PM0(1)                                 |                   | COMMON2 00027 |
| 29 | XL = 0.0                                                        |                   | COMMON2 00028 |
| 30 | Y8 = 1.E+20                                                     |                   | COMMON2 00029 |
| 31 | XR = YT = -Y8                                                   |                   | COMMON2 00030 |
| 32 | CALL START                                                      |                   | COMMON2 00031 |
| 33 | DO 129 J=2,JP2                                                  |                   | COMMON2 00032 |
| 34 | DO 119 I=1,IP1                                                  |                   | COMMON2 00033 |
| 35 | XR = AMAX1(XR,X(IJ))                                            |                   | COMMON2 00034 |
| 36 | Y8 = AMIN1(Y8,Y(IJ))                                            |                   | COMMON2 00035 |
| 37 | YT = AMAX1(YT,Y(IJ))                                            |                   | COMMON2 00036 |
| 38 | 119 IJ = IJ + NQ                                                |                   | COMMON2 00037 |
| 39 | CALL LOOP                                                       |                   | COMMON2 00038 |
| 40 | 129 CONTINUE                                                    |                   | COMMON2 00039 |
| 41 | VV = 0.9*XR*RIBAR                                               |                   | COMMON2 00040 |
| 42 | FIY8 = 916.0                                                    |                   | COMMON2 00041 |
| 43 | X0 = XR/(YT-Y8)                                                 |                   | COMMON2 00042 |
| 44 | YY = 0.0                                                        |                   | COMMON2 00043 |
| 45 | IF (XD.LE.1.13556) YY=1.                                        |                   | COMMON2 00044 |
| 46 | FIXL = AMAX1(0.,(511.-450.*XD)*YY)                              |                   | COMMON2 00045 |
| 47 | FIXR = (511.+450.*XD)*YY + 1022.*(1.-YY)                        |                   | COMMON2 00046 |
| 48 | FIYT = 16.*YY + (916.-1022./XD)*(1.-YY)                         |                   | COMMON2 00047 |
| 49 | XCONV = (FIXR-FIXL)/(XR-XL)                                     |                   | COMMON2 00048 |
| 50 | YCONV = (FIYT-FIY8)/(YT-Y8)                                     |                   | COMMON2 00049 |
| 51 | IXL = FIXL                                                      |                   | COMMON2 00050 |
| 52 | IXR = FIXR                                                      |                   | COMMON2 00051 |
| 53 | IY8 = FIY8                                                      |                   | COMMON2 00052 |
| 54 | IYT = FIYT                                                      |                   | COMMON2 00053 |
| 55 | IF (NPT.EQ.0) RETURN                                            |                   | COMMON2 00054 |
| 56 | PXL = 0.0                                                       |                   | COMMON2 00055 |
| 57 | PY8 = Y8 + PY8                                                  |                   | COMMON2 00056 |

INDEX 01/12/73

```
36 PXR = PDR*FIBP SUBROUTINE FILMCO
37 PYT = PYB + PDZ*FJBP
38 PXR = PXR*OPEM10
39 PYB = PYB*OPEM10
40 PYT = PYT*OPEM10
41 RPDZ = 1./PDR
42 RPDZ = 1./PDZ
43 RPDZ = RPDZ*RPDZ
44 FIPYB = 916.0
45 XD = PXR/(PYT-PYB)
46 YY = 0.0
47 IF (XD.LE.1.135561 YY=1.
48 FIPXL = AMAX1(0.,(511.-450.*XD)*YY)
49 FIPXR = (511.+450.*XD)*YY + 1022.*(1.-YY)
50 FIPYT = 16.*YY + (916.-1022./XD) *(1.-YY)
51 PXCONV = (FIPXR-FIPXL)/(PXR-PXL)
52 PYCONV = (FIPYT-FIPYB)/(PYT-PYB)
53 IPXL = FIPXL
54 IPXR = FIPXR
55 IPYB = FIPYB
56 IPYT = FIPYT
57 RETURN
58 END
```

```
PAGE 10
YAQUI 00131
YAQUI 00132
YAQUI 00133
YAQUI 00134
YAQUI 00135
YAQUI 00136
YAQUI 00137
YAQUI 00138
YAQUI 00139
YAQUI 00140
YAQUI 00141
YAQUI 00142
YAQUI 00143
YAQUI 00144
YAQUI 00145
YAQUI 00146
YAQUI 00147
YAQUI 00148
YAQUI 00149
YAQUI 00150
YAQUI 00151
YAQUI 00152
YAQUI 00153
```



| INDEX  | 01/12/73 | SRL | SUBROUTINE FILMCO |     |     |    |     |    |    |    |    |
|--------|----------|-----|-------------------|-----|-----|----|-----|----|----|----|----|
| MU     | -R       | 3C0 | 5RL               |     |     |    |     |    |    |    |    |
| NPT    | -I       | 3C0 | 33                |     |     |    |     |    |    |    |    |
| NQ     | -I       | 3C0 | 16                |     |     |    |     |    |    |    |    |
| OMEMIO | -R       | 3C0 | 39                |     |     |    |     |    |    |    |    |
| OPEMIO | -R       | 3C0 | 38                | 40  |     |    |     |    |    |    |    |
| P      | ()R      | 4EQ | 60I               |     |     |    |     |    |    |    |    |
| PDR    | -R       | 3C0 | 36                | 41  |     |    |     |    |    |    |    |
| POZ    | -R       | 3C0 | 37                | 42  |     |    |     |    |    |    |    |
| PL     | ()R      | 4EQ | 60I               |     |     |    |     |    |    |    |    |
| PMX    | ()R      | 4EQ | 60I               |     |     |    |     |    |    |    |    |
| PMY    | ()R      | 4EQ | 60I               |     |     |    |     |    |    |    |    |
| PMO    | ()R      | 4EQ | 60I               |     |     |    |     |    |    |    |    |
| PU     | ()R      | 4EQ | 60I               |     |     |    |     |    |    |    |    |
| PV     | ()R      | 4EQ | 60I               |     |     |    |     |    |    |    |    |
| PXCONV | -R       | 3C0 | 51=               |     |     |    |     |    |    |    |    |
| PXL    | -R       | 3C0 | 34=               | 51  |     |    |     |    |    |    |    |
| PXR    | -R       | 3C0 | 36=               | 38  | 45  | 51 |     |    |    |    |    |
| PXRP   | -R       | 3C0 | 38=               |     |     |    |     |    |    |    |    |
| PYB    | -R       | 3C0 | 35=               | 35  | 37  | 39 | 45  | 52 |    |    |    |
| PYRM   | -R       | 3C0 | 39=               |     |     |    |     |    |    |    |    |
| PYCONV | -R       | 3C0 | 52=               |     |     |    |     |    |    |    |    |
| PYT    | -R       | 3C0 | 37=               | 40  | 45  | 52 |     |    |    |    |    |
| PYTP   | -R       | 3C0 | 40=               |     |     |    |     |    |    |    |    |
| Q      | ()R      | 4EQ | 60I               |     |     |    |     |    |    |    |    |
| R      | ()R      | 4EQ | 60I               |     |     |    |     |    |    |    |    |
| RCSQ   | ()R      | 4EQ | 60I               |     |     |    |     |    |    |    |    |
| RETURN | -        | 33F | 57F               |     |     |    |     |    |    |    |    |
| RIBAR  | -R       | 3C0 | 19                |     |     |    |     |    |    |    |    |
| RM     | ()R      | 4EQ | 60I               |     |     |    |     |    |    |    |    |
| RMP    | ()R      | 4EQ | 60I               |     |     |    |     |    |    |    |    |
| RO     | ()R      | 4EQ | 60I               |     |     |    |     |    |    |    |    |
| ROL    | ()R      | 4EQ | 60I               |     |     |    |     |    |    |    |    |
| RPRP   | -R       | 3C0 | 41=               | 43  |     |    |     |    |    |    |    |
| RPORDZ | -R       | 3C0 | 43=               |     |     |    |     |    |    |    |    |
| RPDZ   | -R       | 3C0 | 42=               | 43  |     |    |     |    |    |    |    |
| RVOL   | ()R      | 4EQ | 60I               |     |     |    |     |    |    |    |    |
| SIF    | ()R      | 4EQ | 60I               |     |     |    |     |    |    |    |    |
| U      | ()R      | 4EQ | 60I               |     |     |    |     |    |    |    |    |
| UG     | ()R      | 4EQ | 60I               |     |     |    |     |    |    |    |    |
| UL     | ()R      | 4EQ | 60I               |     |     |    |     |    |    |    |    |
| UP     | ()R      | 4EQ | 60I               |     |     |    |     |    |    |    |    |
| UTIL   | ()R      | 4EQ | 60I               |     |     |    |     |    |    |    |    |
| V      | ()R      | 4EQ | 60I               |     |     |    |     |    |    |    |    |
| VG     | ()R      | 4EQ | 60I               |     |     |    |     |    |    |    |    |
| VL     | ()R      | 4EQ | 60I               |     |     |    |     |    |    |    |    |
| VP     | ()R      | 4EQ | 60I               |     |     |    |     |    |    |    |    |
| VTEL   | ()R      | 4EQ | 60I               |     |     |    |     |    |    |    |    |
| VV     | -R       | 3C0 | 19=               |     |     |    |     |    |    |    |    |
| X      | ()R      | 4EQ | 60I               | 13  |     |    |     |    |    |    |    |
| XCONV  | -R       | 3C0 | 27=               |     |     |    |     |    |    |    |    |
| XD     | -R       | 21= | 23                | 24  | 25  | 26 | 45= | 47 | 48 | 49 | 50 |
| XL     | -R       | 3C0 | 7=                | 27  |     |    |     |    |    |    |    |
| XPAR   | ()R      | 4EQ | 60I               |     |     |    |     |    |    |    |    |
| XR     | -R       | 3C0 | 9=                | 13= | 13  | 19 | 21  | 27 |    |    |    |
| Y      | ()R      | 4EQ | 60I               | 14  | 15  |    |     |    |    |    |    |
| YB     | -R       | 3C0 | 8=                | 9   | 14= | 14 | 21  | 28 | 35 |    |    |
| YCONV  | -R       | 3C0 | 28=               |     |     |    |     |    |    |    |    |
| YPAR   | ()R      | 4EQ | 60I               |     |     |    |     |    |    |    |    |

```

INDEX 01/12/73          SUBROUTINE FILMC0          PAGE 13
YT -R 3C0 9= 15= 15 21 28
YY -R 22= 23= 24 25 26 26 46= 47= 48 49 49 50 50
-----

```

```

INDEX 01/12/73          OVERLAY(YAQUFIL,1,0)          PAGE 14
1                                YASET 00002

```

```

INDEX 01/12/73          PROGRAM YASET          PROGRAM YASET          PAGE 15
1                                YASET 00003
2                                YASET 00004
3                                YASET 00005
4 10                          FORMAT(* YASET CALLED*) YASET 00006
5                                YASET 00007

```

```

INDEX 01/12/73          PROGRAM YASET          PAGE 16
SINGLY REFERENCED VARIABLES
PRINT - 2F YASET - 1SU YASET1 - 3SU
-----
MULTIPLY-REFERENCED VARIABLES
10 - 2PR 4*
-----

```

| INDEX | 01/12/73 | SUBROUTINE YASET1                                                                                                                                                                                                                                                                                                                                                                                                                                                                                                                                                                                                                                                                                                                                                                                                                                                                                                                                                                                                                                                                                                                                                                                                                                                                                                                                                                                                                                                                                                                                                                                                                                                                                                                                                                                                                                                                                                                                                                                                                                                                                                                                                                                                                                                                                                                                                                                                                                                                                                                                                    | PAGE 17       |
|-------|----------|----------------------------------------------------------------------------------------------------------------------------------------------------------------------------------------------------------------------------------------------------------------------------------------------------------------------------------------------------------------------------------------------------------------------------------------------------------------------------------------------------------------------------------------------------------------------------------------------------------------------------------------------------------------------------------------------------------------------------------------------------------------------------------------------------------------------------------------------------------------------------------------------------------------------------------------------------------------------------------------------------------------------------------------------------------------------------------------------------------------------------------------------------------------------------------------------------------------------------------------------------------------------------------------------------------------------------------------------------------------------------------------------------------------------------------------------------------------------------------------------------------------------------------------------------------------------------------------------------------------------------------------------------------------------------------------------------------------------------------------------------------------------------------------------------------------------------------------------------------------------------------------------------------------------------------------------------------------------------------------------------------------------------------------------------------------------------------------------------------------------------------------------------------------------------------------------------------------------------------------------------------------------------------------------------------------------------------------------------------------------------------------------------------------------------------------------------------------------------------------------------------------------------------------------------------------------|---------------|
|       | 1        | SUBROUTINE YASET1                                                                                                                                                                                                                                                                                                                                                                                                                                                                                                                                                                                                                                                                                                                                                                                                                                                                                                                                                                                                                                                                                                                                                                                                                                                                                                                                                                                                                                                                                                                                                                                                                                                                                                                                                                                                                                                                                                                                                                                                                                                                                                                                                                                                                                                                                                                                                                                                                                                                                                                                                    | YASET 00008   |
|       | 2        | LCM /YLC1/ AA1(131000) /YLC2/ AA2(131000)                                                                                                                                                                                                                                                                                                                                                                                                                                                                                                                                                                                                                                                                                                                                                                                                                                                                                                                                                                                                                                                                                                                                                                                                                                                                                                                                                                                                                                                                                                                                                                                                                                                                                                                                                                                                                                                                                                                                                                                                                                                                                                                                                                                                                                                                                                                                                                                                                                                                                                                            | YASET 00009   |
|       | 3        | COMMON /YSC1/ AASC(4242)                                                                                                                                                                                                                                                                                                                                                                                                                                                                                                                                                                                                                                                                                                                                                                                                                                                                                                                                                                                                                                                                                                                                                                                                                                                                                                                                                                                                                                                                                                                                                                                                                                                                                                                                                                                                                                                                                                                                                                                                                                                                                                                                                                                                                                                                                                                                                                                                                                                                                                                                             | COMMON2 00002 |
|       | 4        | COMMON /YSC2/ AA(1),ANC,ASQ,A0,AOFAC,AOM,RO,COLAMU,CYL,<br>1 DR,DT,DTC,DTFAC,DTGR,DTGZ,DTGZP,DTN(10),DTNC(10),<br>2 DT016,DT02,DT04,DT08,DTPOS,DTV,DTB,DZ,EM10,EP5,FIBP,<br>3 FIPXL,FIPXR,FIPY8,FIPYT,FIXL,FXR,FIY8,FIYT,FJ8P,<br>4 FREZ,GGM1,GMI,GR,GRDVEL,GZ,GZP,I,IBAR,IRP,IBP1,ICOLOR,<br>5 IDTO,IJ,IJM,IJP,IJPS,IMOME3,IMOMX,IM1,IM6,<br>6 IPAR,IPXL,IPXR,IPYR,IPYT,IP1,IP2,ISCF1,ISCF2,ISC2,ISC3,<br>7 ITV,IUNF,IXL,IXR,IY8,IYT,J,JBAR,JBP,JBP2,JCEN,JM10,<br>8 JM4,JP1,JP2,JP4,JPAQ2,JUNF,JUNF02,KXI,LAM,LJP2,LPR,<br>9 LPR,MU,NAME(10),NCYC,NLC,NPS,NPT,NQ,NQ1,NQTR,NQI2,NSC,<br>1 NUMIT,NUMTD,OM,OMANC,OMCYL,OMEM10,OPEM10,PDR,PDZ,PXCNDV,<br>2 PXL,PXR,PXRP,PY8,PY8M,PYCONV,PYT,PYTP,ROD,REZRON,REZSIE,<br>3 REZUE,REZVE,REZVT,REZY0,RIBAR,RIRJA,RIBP,RJRP,ROMFR,<br>4 RON,RPOR,RPRDZ,RPOZ,T,THIRD,TLIMD,TOUT,TWFIN,TZ0MD,<br>5 VV,XCONV,XL,XR,Y8,YCONV,YT,ZZ<br>5 EQUIVALENCE (AASC(1),X,XPBAR),(AASC(2),R,YPAR),(AASC(3),Y,MPAR),<br>1 (AASC(4),U,UG,DELSM),(AASC(5),V,VO),(AASC(6),RO),<br>2 (AASC(7),SIE,MP,RMP,RCSQ),(AASC(8),E,ETIL),<br>3 (AASC(9),RVOL),(AASC(10),M,RM,VP),(AASC(11),P,PL,EP,<br>4 UP,PM0),(AASC(12),UTIL,UL,CQ,PHX,PU),(AASC(13),VTIL,<br>5 VL,PHY,PV),(AASC(14),Q,ROL)<br>6 REAL LAM,LAND,M,NR,NC,ML,MP,MPAR,MR,MT,MTE,MU,MUO2,MUO4<br>7 DIMENSION X(1),XPBAR(1),R(1),YPAR(1),Y(I),MPAR(I),U(1),UG(I),<br>1 DELSM(1),V(1),VG(1),RO(1),SIE(1),MP(1),RMP(1),RCSQ(1),<br>2 E(1),ETTL(1),RVOL(1),M(1),RM(1),VP(1),P(1),PL(1),EP(1),<br>3 UP(1),UTIL(1),UL(1),CQ(1),PMX(1),PU(1),VTIL(1),VL(1),<br>4 PMY(1),PV(1),Q(1),ROL(1),PM0(1)<br>8 READ 500, NAME<br>9 READ 510, MU,LAM,OM,EP5,GR,GZ,ASQ,RON,GMI<br>10 READ 515, FREZ,Y8,REZY0,REZUE,REZVE,REZVT,REZRON,REZSIE<br>11 READ 520, IBP,JBP,PDR,PDZ,PY8,GZP,IMOMX<br>12 READ 530, T,DT,TZ0MD,TLIMD,TWFIN,LPR,ICOLOR<br>13 READ 540, (DTN(N),N=1,10)<br>14 READ 540, (DTNC(N),N=1,10)<br>15 KT = 9<br>16 ASSTGN 110 TO KRET<br>17 WRITE(KT,500) NAME<br>18 WRITE(KT,550) IBAR,JBAR,IUNF,JUNF,JCEN,DR,DZ,CYL,GRDVEL,<br>1 A0,AOM,RO,KXI<br>19 WRITE(KT,560) MU,LAM,OM,EP5,GR,GZ,ASQ,RON,GMI<br>20 WRITE(KT,565) FREZ,Y8,REZY0,REZUE,REZVE,REZVT,REZRON,REZSIE<br>21 WRITE(KT,570) IBP,JBP,PDR,PDZ,PY8,GZP,IMOMX<br>22 WRITE(KT,580) T,DT,TZ0MD,TLIMD,TWFIN,LPR,ICOLOR<br>23 WRITE(KT,590) (DTN(N),N=1,10)<br>24 WRITE(KT,600) (DTNC(N),N=1,10)<br>25 GO TO KRET<br>26 110 IF (LPR,FQ,0) GOTO 120<br>27 KT = 12<br>28 ASSTGN 120 TO KRET<br>29 GO TO 100<br>30 120 IM1 = IRAR - 1<br>31 IM6 = IRAR - 6<br>32 IP1 = IRAR + 1<br>33 IP2 = IRAR + 2<br>34 JM10 = JRAR - 10<br>YASET 00040 |               |

| INOEX | 01/12/73 | SUBROUTINE YASET1                        | PAGE  | 18    |
|-------|----------|------------------------------------------|-------|-------|
| 35    |          | JM14 = JRAR - 14                         | YASET | 00041 |
| 36    |          | JP1 = JRAR + 1                           | YASET | 00042 |
| 37    |          | JP2 = JRAR + 2                           | YASET | 00043 |
| 38    |          | JP4 = JRAR + 4                           | YASET | 00044 |
| 39    |          | JP402 = JP4 / 2                          | YASET | 00045 |
| 40    |          | RIBAR = 1./FLOAT(IBAR)                   | YASET | 00046 |
| 41    |          | RIBJ8 = 1./FLOAT(IBAR*JBAR)              | YASET | 00047 |
| 42    |          | NQIR = NQ * IBAR                         | YASET | 00048 |
| 43    |          | OMCYL = 1.-CYL                           | YASET | 00049 |
| 44    |          | NQI = NQ * IP1                           | YASET | 00050 |
| 45    |          | ISC2 = NQI + 1                           | YASET | 00051 |
| 46    |          | ISC3 = ISC2 + NQI                        | YASET | 00052 |
| 47    |          | ITV = JP1 * NQI                          | YASET | 00053 |
| 48    |          | ISCF1 = ISC2 - NQ                        | YASET | 00054 |
| 49    |          | ISCF2 = ISCF1 + NQI                      | YASET | 00055 |
| 50    |          | NSC = LOCF(ZZ) - LOCF(AA) * I            | YASET | 00056 |
| 51    |          | NLC = LOCF(AA1(JP4*NQI)) - LOCF(AA1) * I | YASET | 00057 |
| 52    |          | LJP2 = JP2 - JP2/3 * 3                   | YASET | 00058 |
| 53    |          | IF (LJP2.FQ.0) LJP2 = 3                  | YASET | 00059 |
| 54    |          | LJP2 = LJP2*NQI - NQ + 1                 | YASET | 00060 |
| 55    |          | IOTO = 1                                 | YASET | 00061 |
| 56    |          | TOUT = T + DT0(I)                        | YASET | 00062 |
| 57    |          | DT = DTPOS = DT*0.1                      | YASET | 00063 |
| 58    |          | NCYC = NUMTD = 0                         | YASET | 00064 |
| 59    |          | EM10 = 1.E-10                            | YASET | 00065 |
| 60    |          | OMEM10 = 1.-EM10                         | YASET | 00066 |
| 61    |          | OPEN10 = 1.*EM10                         | YASET | 00067 |
| 62    |          | ANC = 0.05                               | YASET | 00068 |
| 63    |          | OMANC = 1.-ANC                           | YASET | 00069 |
| 64    |          | COLAMU = (1.0+1.67)/(LAM*MU+MU*FM10)     | YASET | 00070 |
| 65    |          | A0FAC = A0M/(2.0*(1.+A0M**2))            | YASET | 00071 |
| 66    |          | G0M1 = (GM1*1.)*GM1                      | YASET | 00072 |
| 67    |          | THIRO = 1./3.                            | YASET | 00073 |
| 68    |          | IUNF = MAX0(IUNF,I)                      | YASET | 00074 |
| 69    |          | JUNF = MAX0(JUNF,2)                      | YASET | 00075 |
| 70    |          | JUNF02 = JUNF/2                          | YASET | 00076 |
| 71    |          | IF (JCEN.FQ.0) JCEN = JBAR/2             | YASET | 00077 |
| 72    |          | IF (FREQ.NE.1.) ROMFR = 1./(1.-FREQ)     | YASET | 00078 |
| 73    |          | CALL PARTGEN                             | YASET | 00079 |
| 74    |          | CALL MESHMKR                             | YASET | 00080 |
| 75    |          | CALL FILMCD                              | YASET | 00081 |
| 76    | 200      | CALL START                               | YASET | 00082 |
| 77    |          | DO 229 J=2,JP1                           | YASET | 00083 |
| 78    |          | DO 219 I=1,IBAR                          | YASET | 00084 |
| 79    |          | IPJ = IJ * NQ                            | YASET | 00085 |
| 80    |          | IPJP = IJP * NQ                          | YASET | 00086 |
| 81    |          | X1 = X(IPJ)                              | YASET | 00087 |
| 82    |          | Y1 = Y(IPJ)                              | YASET | 00088 |
| 83    |          | R1 = R(IPJ)                              | YASET | 00089 |
| 84    |          | X2 = X(IPJP)                             | YASET | 00090 |
| 85    |          | Y2 = Y(IPJP)                             | YASET | 00091 |
| 86    |          | R2 = R(IPJP)                             | YASET | 00092 |
| 87    |          | X3 = X(IJP)                              | YASET | 00093 |
| 88    |          | Y3 = Y(IJP)                              | YASET | 00094 |
| 89    |          | R3 = R(IJP)                              | YASET | 00095 |
| 90    |          | X4 = X(IJ1)                              | YASET | 00096 |
| 91    |          | Y4 = Y(IJ1)                              | YASET | 00097 |
| 92    |          | R4 = R(IJ1)                              | YASET | 00098 |

| INDEX | 01/12/73 | SUBROUTINE YASET1                                                       | PAGE  | 19    |
|-------|----------|-------------------------------------------------------------------------|-------|-------|
| 93    |          | ATR = .5*(X1*(Y2-Y3)+X2*(Y3-Y1)+X3*(Y1-Y2))                             | YASET | 00099 |
| 94    |          | ABL = .5*(X1*(Y3-Y4)+X3*(Y4-Y1)+X4*(Y1-Y3))                             | YASET | 00100 |
| 95    |          | M(IJ) = THIRD*(ATR*(R1+R2+R3)+ABL*(R1+R3+R4))*RO(IJ)                    | YASET | 00101 |
| 96    |          | RVOL(IJ) = RO(IJ)/M(IJ)                                                 | YASET | 00102 |
| 97    |          | E(IJ) = STE(IJ)+.125*(U(I*PJ)**2+U(I*PJ)*U(I*JP)**2+U(I*JP)**2+U(IJ)**2 | YASET | 00103 |
|       |          | 1 +V(I*PJ)**2+V(I*JP)**2+V(I*JP)**2+V(IJ)**2)                           | YASET | 00104 |
| 98    |          | IJ = TPJ                                                                | YASET | 00105 |
| 99    | 219      | IJP = IPJP                                                              | YASET | 00106 |
| 100   |          | CALL LOOP                                                               | YASET | 00107 |
| 101   | 229      | CONTINUE                                                                | YASET | 00108 |
| 102   |          | CALL NONE                                                               | YASET | 00109 |
| 103   | 300      | CALL STARTD                                                             | YASET | 00110 |
| 104   |          | DO 359 JJ=2,JP2                                                         | YASET | 00111 |
| 105   |          | J = JP4 - JJ                                                            | YASET | 00112 |
| 106   |          | DO 349 II=1,IP1                                                         | YASET | 00113 |
| 107   |          | I = IP2 - II                                                            | YASET | 00114 |
| 108   |          | IMJ = IJ - NJ                                                           | YASET | 00115 |
| 109   |          | IMJM = IJM -NQ                                                          | YASET | 00116 |
| 110   |          | XX = 0.0                                                                | YASET | 00117 |
| 111   |          | IF (I.NE.IP1 .AND. J.NE.JP2 ) XX = M(IJM)                               | YASET | 00118 |
| 112   |          | IF II.NE.IP1 .AND. J.NE.JP2) XX = XX+M(IJ)                              | YASET | 00119 |
| 113   |          | IF (I.NE.I .AND. J.NE.JP2) XX = XX+M(IMJ)                               | YASET | 00120 |
| 114   |          | IF (I.NE.I .AND. J.NE.JP2 ) XX = XX+M(IMJM)                             | YASET | 00121 |
| 115   | 340      | RM(IJ) = 4./XX                                                          | YASET | 00122 |
| 116   |          | IJ = IMJ                                                                | YASET | 00123 |
| 117   | 349      | IJM = IMJM                                                              | YASET | 00124 |
| 118   |          | CALL LOOPD                                                              | YASET | 00125 |
| 119   | 359      | CONTINUE                                                                | YASET | 00126 |
| 120   |          | RETURN                                                                  | YASET | 00127 |
|       |          | C                                                                       | YASET | 00128 |
| 121   | 500      | FORMAT(10A8)                                                            | YASET | 00129 |
| 122   | 510      | FORMAT(9F8.3)                                                           | YASET | 00130 |
| 123   | 515      | FORMAT(8F8.3)                                                           | YASET | 00131 |
| 124   | 520      | FORMAT(214,4F8.3,I4)                                                    | YASET | 00132 |
| 125   | 530      | FORMAT(5F8.3,2I4)                                                       | YASET | 00133 |
| 126   | 540      | FORMAT(10F8.3)                                                          | YASET | 00134 |
| 127   | 550      | FORMAT(3X*IBAR=*I4/3X*JBAR=*I4/3X*IUNF=*I4/3X*JUNF=*I4/3X*JCEB=*I4      | YASET | 00135 |
|       |          | 1/5X*DR=*IPE12.5/5X*DZ=*E12.5/4X*CYL=*E12.5,* GROVEL=*E12.5/5X*A0=*E    | YASET | 00136 |
|       |          | 2E)2.5/4X*A0M=*E12.5/5X*RO=*E12.5/4X*KX=*T.)                            | YASET | 00137 |
| 128   | 560      | FORMAT(5X*OU=*IPE12.5/4X*LAM=*E12.5/5X*OM=*E12.5/4X*EPS=*E12.5/5X*      | YASET | 00138 |
|       |          | IGP=*E12.5/5X*G7=*F12.5/4X*ASQ=*E12.5/4X*RON=*F12.5/4X*GM1=*E12.5)      | YASET | 00139 |
| 129   | 565      | FORMAT(3X*FEZ=*IPE12.5/5X*YB=*F12.5/* REZY0=*E12.5/* RFZUE=*E           | YASET | 00140 |
|       |          | 1 F12.5/* REZVE=*E12.5/* REZVT=*E12.5/* REZRON=*E12.5/* REZSTE=*E       | YASET | 00141 |
|       |          | 2 E12.5)                                                                | YASET | 00142 |
| 130   | 570      | FORMAT(4X*IBP=*I4/4X*JRP=*I4/4X*PNR=*IPE12.5/4X*PNZ=*E12.5/4X*PYB=*E    | YASET | 00143 |
|       |          | 1*E12.5/4X*GZP=*E12.5/2X*IMOMX=*I2)                                     | YASET | 00144 |
| 131   | 580      | FORMAT(6X*OT=*IPE12.5/5X*DT=*E12.5/* T20M0=*E12.5/* T1LIM0=*E12.5/      | YASET | 00145 |
|       |          | 1* TWFIN=*F12.5/4X*IPR=*I2/* ICOLOR=*T2)                                | YASET | 00146 |
| 132   | 590      | FORMAT(10 DT0(1-10)=*5(IPE12.5,2X)/12X,5(E12.5,2X))                     | YASET | 00147 |
| 133   | 600      | FORMAT(10 DT0C(1-10)=*5(IPE12.5,2X)/12X,5(E12.5,2X))                    | YASET | 00148 |
| 134   |          | END                                                                     | YASET | 00149 |





| INDEX  | 01/12/73 | SUBROUTINE YASET1 |      |      |       |       |      |      |      |      |      | PAGE 21 |    |    |    |    |    |    |    |    |
|--------|----------|-------------------|------|------|-------|-------|------|------|------|------|------|---------|----|----|----|----|----|----|----|----|
| 0Z     | -R       | 4CO               | 1AWR |      |       |       |      |      |      |      |      |         |    |    |    |    |    |    |    |    |
| E      | ()R      | 5EQ               | 70I  | 97=  |       |       |      |      |      |      |      |         |    |    |    |    |    |    |    |    |
| FM10   | -R       | 4CO               | 59=  | 60   | 61    | 64    |      |      |      |      |      |         |    |    |    |    |    |    |    |    |
| EP     | ()R      | 5EQ               | 70I  |      |       |       |      |      |      |      |      |         |    |    |    |    |    |    |    |    |
| EPS    | -R       | 4CO               | 9RD  | 19WR |       |       |      |      |      |      |      |         |    |    |    |    |    |    |    |    |
| FTIL   | ()R      | 5EQ               | 70I  |      |       |       |      |      |      |      |      |         |    |    |    |    |    |    |    |    |
| FLDAT  | -        | 40SU              | 41SU |      |       |       |      |      |      |      |      |         |    |    |    |    |    |    |    |    |
| FRFZ   | -R       | 4CO               | 10RD | 20WR | 72    | 72    |      |      |      |      |      |         |    |    |    |    |    |    |    |    |
| GGM1   | -R       | 4CO               | 66=  |      |       |       |      |      |      |      |      |         |    |    |    |    |    |    |    |    |
| GM1    | -R       | 4CO               | 9RD  | 19WR | 66    | 66    |      |      |      |      |      |         |    |    |    |    |    |    |    |    |
| GR     | -R       | 4CO               | 9RD  | 19WR |       |       |      |      |      |      |      |         |    |    |    |    |    |    |    |    |
| GROVEL | -R       | 4CO               | 1AWR |      |       |       |      |      |      |      |      |         |    |    |    |    |    |    |    |    |
| GZ     | -R       | 4CO               | 9RD  | 19WR |       |       |      |      |      |      |      |         |    |    |    |    |    |    |    |    |
| GZP    | -R       | 4CO               | 11RD | 21WR |       |       |      |      |      |      |      |         |    |    |    |    |    |    |    |    |
| I      | -I       | 4CO               | 7800 | 107= | 111   | 112   | 113  | 114  |      |      |      |         |    |    |    |    |    |    |    |    |
| IBAR   | -I       | 4CO               | 18WR | 30   | 31    | 32    | 33   | 40   | 41   | 42   | 7800 |         |    |    |    |    |    |    |    |    |
| IBP    | -I       | 4CO               | 11RD | 21WR |       |       |      |      |      |      |      |         |    |    |    |    |    |    |    |    |
| ICOLOR | -I       | 4CO               | 12RD | 22WR |       |       |      |      |      |      |      |         |    |    |    |    |    |    |    |    |
| IDTD   | -I       | 4CO               | 55=  |      |       |       |      |      |      |      |      |         |    |    |    |    |    |    |    |    |
| II     | -I       | 10600             | 107  |      |       |       |      |      |      |      |      |         |    |    |    |    |    |    |    |    |
| IJ     | -I       | 4CO               | 79   | 90   | 91    | 92    | 95   | 95   | 96   | 96   | 96   | 97      | 97 | 97 | 97 | 97 | 97 | 97 | 97 | 97 |
|        |          | 115               | 116= |      |       |       |      |      |      |      |      |         |    |    |    |    |    |    |    |    |
| IJM    | -I       | 4CO               | 109  | 111  | 117=  |       |      |      |      |      |      |         |    |    |    |    |    |    |    |    |
| IJP    | -I       | 4CO               | 80   | 87   | 88    | 89    | 97   | 97   | 99=  |      |      |         |    |    |    |    |    |    |    |    |
| IMJ    | -I       | 10R=              | 113  | 116  |       |       |      |      |      |      |      |         |    |    |    |    |    |    |    |    |
| TMJM   | -I       | 109=              | 114  | 117  |       |       |      |      |      |      |      |         |    |    |    |    |    |    |    |    |
| TMOMX  | -I       | 4CO               | 11RD | 21WR |       |       |      |      |      |      |      |         |    |    |    |    |    |    |    |    |
| TM1    | -I       | 4CO               | 30=  |      |       |       |      |      |      |      |      |         |    |    |    |    |    |    |    |    |
| TM6    | -I       | 4CO               | 31=  |      |       |       |      |      |      |      |      |         |    |    |    |    |    |    |    |    |
| TPJ    | -I       | 79=               | 81   | 82   | 83    | 97    | 97   | 98   |      |      |      |         |    |    |    |    |    |    |    |    |
| TPJP   | -I       | 80=               | 84   | 85   | 86    | 97    | 97   | 99   |      |      |      |         |    |    |    |    |    |    |    |    |
| TP1    | -I       | 4CO               | 32=  | 44   | 10600 | 111   | 112  |      |      |      |      |         |    |    |    |    |    |    |    |    |
| IP2    | -I       | 4CO               | 33=  | 107  |       |       |      |      |      |      |      |         |    |    |    |    |    |    |    |    |
| ISCF1  | -I       | 4CO               | 48=  | 49   |       |       |      |      |      |      |      |         |    |    |    |    |    |    |    |    |
| ISCF2  | -I       | 4CO               | 49=  |      |       |       |      |      |      |      |      |         |    |    |    |    |    |    |    |    |
| ISCF?  | -I       | 4CO               | 45=  | 46   | 48    |       |      |      |      |      |      |         |    |    |    |    |    |    |    |    |
| ISC3   | -I       | 4CO               | 46=  |      |       |       |      |      |      |      |      |         |    |    |    |    |    |    |    |    |
| ITV    | -I       | 4CO               | 47=  |      |       |       |      |      |      |      |      |         |    |    |    |    |    |    |    |    |
| TUNF   | -I       | 4CO               | 18WR | 68=  | 68    |       |      |      |      |      |      |         |    |    |    |    |    |    |    |    |
| J      | -I       | 4CO               | 7700 | 105= | 111   | 112   | 113  | 114  |      |      |      |         |    |    |    |    |    |    |    |    |
| JBAR   | -I       | 4CO               | 18WR | 34   | 35    | 36    | 37   | 38   | 41   | 71   |      |         |    |    |    |    |    |    |    |    |
| JBP    | -I       | 4CO               | 11RD | 21WR |       |       |      |      |      |      |      |         |    |    |    |    |    |    |    |    |
| JCEN   | -I       | 4CO               | 1AWR | 71   | 71=   |       |      |      |      |      |      |         |    |    |    |    |    |    |    |    |
| JJ     | -I       | 10400             | 105  |      |       |       |      |      |      |      |      |         |    |    |    |    |    |    |    |    |
| JM10   | -I       | 4CO               | 34=  |      |       |       |      |      |      |      |      |         |    |    |    |    |    |    |    |    |
| JM14   | -I       | 4CO               | 35=  |      |       |       |      |      |      |      |      |         |    |    |    |    |    |    |    |    |
| JP1    | -I       | 4CO               | 36=  | 47   | 7700  |       |      |      |      |      |      |         |    |    |    |    |    |    |    |    |
| JP2    | -I       | 4CO               | 37=  | 52   | 52    | 10400 | 112  | 113  |      |      |      |         |    |    |    |    |    |    |    |    |
| JP4    | -I       | 4CO               | 38=  | 39   | 51    | 105   |      |      |      |      |      |         |    |    |    |    |    |    |    |    |
| JP402  | -T       | 4CO               | 39=  |      |       |       |      |      |      |      |      |         |    |    |    |    |    |    |    |    |
| JUNF   | -I       | 4CO               | 18WR | 69=  | 69    | 70    |      |      |      |      |      |         |    |    |    |    |    |    |    |    |
| JUNF02 | -I       | 4CO               | 70=  |      |       |       |      |      |      |      |      |         |    |    |    |    |    |    |    |    |
| KRFT   | -I       | 16AS              | 25   | 28AS |       |       |      |      |      |      |      |         |    |    |    |    |    |    |    |    |
| KT     | -I       | 15=               | 17WR | 18WR | 19WR  | 20WR  | 21WR | 22WR | 23WR | 24WR | 27=  |         |    |    |    |    |    |    |    |    |
| KXI    | -I       | 4CO               | 1AWR |      |       |       |      |      |      |      |      |         |    |    |    |    |    |    |    |    |
| LAM    | -R       | 4CO               | 6RL  | 9RD  | 19WR  | 64    |      |      |      |      |      |         |    |    |    |    |    |    |    |    |
| LJP2   | -I       | 4CO               | 52=  | 53   | 53=   | 54=   | 54   |      |      |      |      |         |    |    |    |    |    |    |    |    |
| L0CF   | -        | 50SU              | 50SU | 51SU | 51SU  |       |      |      |      |      |      |         |    |    |    |    |    |    |    |    |

| INDEX  |     | 01/12/73 |      | SUBROUTINE YASET1 |      |      |      |      |      |     |
|--------|-----|----------|------|-------------------|------|------|------|------|------|-----|
| LPR    | -I  | 4C0      | 12RD | 22WR              | 26   |      |      |      |      |     |
| M      | ()R | 5FQ      | 6RL  | 7D1               | 95=  | 96   | 111  | 112  | 113  | 114 |
| MAX0   | -   | 6RSU     | 69SU |                   |      |      |      |      |      |     |
| MP     | ()R | 5EQ      | 6RL  | 70I               |      |      |      |      |      |     |
| MPAR   | ()R | 5EQ      | 6RL  | 70I               |      |      |      |      |      |     |
| MU     | -R  | 4C0      | 6RL  | 9RD               | 19WR | 64   | 64   |      |      |     |
| N      | -I  | 13RD     | 13RD | 14RD              | 14RD | 23WR | 23WR | 24WR | 24WR |     |
| NAME   | ()I | 4C0      | 8RD  | 17WR              |      |      |      |      |      |     |
| NCYC   | -I  | 4C0      | 58=  |                   |      |      |      |      |      |     |
| NLC    | -I  | 4C0      | 51=  |                   |      |      |      |      |      |     |
| NQ     | -I  | 4C0      | 42   | 44                | 44   | 54   | 79   | 80   | 10R  | 109 |
| NQI    | -I  | 4C0      | 44=  | 45                | 46   | 47   | 49   | 51   | 54   |     |
| NQTR   | -I  | 4C0      | 42=  |                   |      |      |      |      |      |     |
| NSC    | -I  | 4C0      | 50=  |                   |      |      |      |      |      |     |
| NUMTD  | -I  | 4C0      | 5R=  |                   |      |      |      |      |      |     |
| OM     | *R  | 4C0      | 9RD  | 19WR              |      |      |      |      |      |     |
| OMANC  | -R  | 4C0      | 63=  |                   |      |      |      |      |      |     |
| OMCYL  | -R  | 4C0      | 43=  |                   |      |      |      |      |      |     |
| OMEM10 | -R  | 4C0      | 60=  |                   |      |      |      |      |      |     |
| OMEM10 | -R  | 4C0      | 61=  |                   |      |      |      |      |      |     |
| P      | ()R | 5EQ      | 70I  |                   |      |      |      |      |      |     |
| PDR    | -R  | 4C0      | 11RD | 21WR              |      |      |      |      |      |     |
| PD7    | -R  | 4C0      | 11RD | 21WR              |      |      |      |      |      |     |
| PL     | ()R | 5EQ      | 70I  |                   |      |      |      |      |      |     |
| PMX    | ()R | 5EQ      | 70I  |                   |      |      |      |      |      |     |
| PMY    | ()R | 5EQ      | 70I  |                   |      |      |      |      |      |     |
| PM0    | ()R | 5EQ      | 70I  |                   |      |      |      |      |      |     |
| PU     | ()R | 5EQ      | 70I  |                   |      |      |      |      |      |     |
| PV     | ()R | 5EQ      | 70I  |                   |      |      |      |      |      |     |
| PYR    | -R  | 4C0      | 11RD | 21WR              |      |      |      |      |      |     |
| Q      | ()R | 5EQ      | 70I  |                   |      |      |      |      |      |     |
| R      | ()R | 5FQ      | 70I  | 83                | 86   | 89   | 92   |      |      |     |
| RCS0   | ()R | 5EQ      | 70I  |                   |      |      |      |      |      |     |
| READ   | -   | 8F       | 9F   | 10F               | 11F  | 12F  | 13F  | 14F  |      |     |
| REZRON | -R  | 4C0      | 10RD | 20WR              |      |      |      |      |      |     |
| REZSIE | -R  | 4C0      | 10RD | 20WR              |      |      |      |      |      |     |
| REZHF  | -R  | 4C0      | 10RD | 20WR              |      |      |      |      |      |     |
| REZVF  | -R  | 4C0      | 10RD | 20WR              |      |      |      |      |      |     |
| REZVT  | -R  | 4C0      | 10RD | 20WR              |      |      |      |      |      |     |
| REZV0  | -R  | 4C0      | 10RD | 20WR              |      |      |      |      |      |     |
| RIRAR  | -R  | 4C0      | 40=  |                   |      |      |      |      |      |     |
| RIRJR  | -R  | 4C0      | 41=  |                   |      |      |      |      |      |     |
| RM     | ()R | 5EQ      | 70I  | 115=              |      |      |      |      |      |     |
| RMP    | ()R | 5EQ      | 70I  |                   |      |      |      |      |      |     |
| RO     | ()R | 5EQ      | 70I  | 95                | 96   |      |      |      |      |     |
| ROL    | ()R | 5EQ      | 70I  |                   |      |      |      |      |      |     |
| ROMFR  | -R  | 4C0      | 72=  |                   |      |      |      |      |      |     |
| RON    | -R  | 4C0      | 9RD  | 19WR              |      |      |      |      |      |     |
| RVOL   | ()R | 5EQ      | 70I  | 96=               |      |      |      |      |      |     |
| R1     | -R  | 83=      | 95   | 95                |      |      |      |      |      |     |
| R2     | -R  | 86=      | 95   |                   |      |      |      |      |      |     |
| R3     | -R  | 89=      | 95   | 95                |      |      |      |      |      |     |
| R4     | -R  | 92=      | 95   |                   |      |      |      |      |      |     |
| SIE    | ()R | 5EQ      | 70I  | 97                |      |      |      |      |      |     |
| T      | -R  | 4C0      | 12RD | 22WR              | 56   |      |      |      |      |     |
| THIRD  | -R  | 4C0      | 67=  | 95                |      |      |      |      |      |     |
| TLTMO  | -R  | 4C0      | 12RD | 22WR              |      |      |      |      |      |     |
| TOUT   | -R  | 4C0      | 56=  |                   |      |      |      |      |      |     |

|       | INDEX | 01/12/73 | SUBROUTINE YASET1 |      |     |      |     |      |         |
|-------|-------|----------|-------------------|------|-----|------|-----|------|---------|
| TWFIN | -R    | 4CO      | 12RD              | 22WR |     |      |     |      |         |
| TZOMD | -R    | 4CO      | 12RD              | 22WR |     |      |     |      |         |
| U     | ()R   | 5EQ      | 7DI               | 97   | 97  | 97   | 97  |      |         |
| UG    | ()R   | 5EQ      | 7DI               |      |     |      |     |      |         |
| UL    | ()R   | 5EQ      | 7DI               |      |     |      |     |      |         |
| UP    | ()R   | 5EQ      | 7DI               |      |     |      |     |      |         |
| UTIL  | ()R   | 5EQ      | 7DI               |      |     |      |     |      |         |
| V     | ()R   | 5EQ      | 7DI               | 97   | 97  | 97   | 97  |      |         |
| VG    | ()R   | 5EQ      | 7DI               |      |     |      |     |      |         |
| VL    | ()R   | 5EQ      | 7DI               |      |     |      |     |      |         |
| VP    | ()R   | 5EQ      | 7DI               |      |     |      |     |      |         |
| VTIL  | ()R   | 5EQ      | 7DI               |      |     |      |     |      |         |
| WRITE | -     | 17F      | 18F               | 19F  | 20F | 21F  | 22F | 23F  | 24F     |
| X     | ()R   | 5EQ      | 7DI               | 81   | 84  | 87   | 90  |      |         |
| XPAR  | ()R   | 5EQ      | 7DI               |      |     |      |     |      |         |
| XX    | -R    | 110=     | 111=              | 112= | 112 | 113= | 113 | 114= | 114 115 |
| X1    | -R    | 81=      | 93                | 94   |     |      |     |      |         |
| X2    | -R    | 84=      | 93                |      |     |      |     |      |         |
| X3    | -R    | 87=      | 93                | 94   |     |      |     |      |         |
| X4    | -R    | 90=      | 94                |      |     |      |     |      |         |
| Y     | ()R   | 5EQ      | 7DI               | 82   | 85  | 88   | 91  |      |         |
| YB    | -R    | 4CO      | 10RD              | 20WR |     |      |     |      |         |
| YPAR  | ()R   | 5EQ      | 7DI               |      |     |      |     |      |         |
| Y1    | -R    | 82=      | 93                | 93   | 94  | 94   |     |      |         |
| Y2    | -R    | 85=      | 93                | 93   |     |      |     |      |         |
| Y3    | -R    | 88=      | 93                | 93   | 94  | 94   |     |      |         |
| Y4    | -R    | 91=      | 94                | 94   |     |      |     |      |         |
| 7Z    | -R    | 4CO      | 50                |      |     |      |     |      |         |

| TNOEX | 01/12/73 | SUBROUTINE PARTGEN                                                | PAGE    | 24    |
|-------|----------|-------------------------------------------------------------------|---------|-------|
| 1     |          | SUBROUTINE PARTGEN                                                | YASET   | 00150 |
| 2     |          | LCM /YLC1/ AA1(131000) /YLC2/ AA2(131000)                         | YASET   | 00151 |
| 3     |          | COMMON /YSC1/ AASC(4242)                                          | COMMON2 | 00002 |
| 4     |          | COMMON /YSC2/ AA(1),ANC,ASQ,A0,AOFAC,AOM,R0,COLAMU,CYL,           | COMMON2 | 00003 |
|       | 1        | DR,NT,OTC,OTFAC,DTGR,DTGZ,DTGZP,OTD(10),DTOC(10),                 | COMMON2 | 00004 |
|       | 2        | OTO16,OTO2,OTO4,OT08,DTPOS,DTV,DTR,0Z,EM10,EP5,FIBP,              | COMMON2 | 00005 |
|       | 3        | FIPXL,FIPXR,FIPYB,FIPYT,FIXL,FXR,F'YB,FIYT,FJBP,                  | COMMON2 | 00006 |
|       | 4        | FRFZ,GGM1,GM1,GR,GR0VEL,GZ,GZP,I,IRAR,IRP,IRP1,ICOLOR,            | COMMON2 | 00007 |
|       | 5        | IDT0,IJ,IJM,IJP,TJPS,IMOME3,IMOMX,IM1,IM6,                        | COMMON2 | 00008 |
|       | 6        | IPAR,IPXL,IPXR,IPYB,IPYT,IP1,IP2,ISCF1,TSCF2,ISC2,ISC3,           | COMMON2 | 00009 |
|       | 7        | ITV,IUNF,IXL,IXR,IYA,IYT,J,JBAR,JBP,JBP2,JCEN,JM10,               | COMMON2 | 00010 |
|       | 8        | JM14,JP1,JP2,JP4,JP402,JUNF,JUNF02,XI,LAM,LJP2,LPB,               | COMMON2 | 00011 |
|       | 9        | LPR,MU,NAME(10),NCYC,NLC,NPS,NPT,NQ,NQ1,NQI2,NSC,                 | COMMON2 | 00012 |
|       | 1        | NUMIT,NUHT0,OM,OMANC,OMCYL,OMEM10,OPEM10,PDR,PDZ,PXCONV,          | COMMON2 | 00013 |
|       | 2        | PXL,PXR,PXRP,PYB,PYBM,PYCONV,PYT,PYTP,ROT,REZRON,REZSIE,          | COMMON2 | 00014 |
|       | 3        | REZUE,REZVF,REZVT,REZY0,RIAR,RIARJ,RIAP,RJHP,ROMFR,               | COMMON2 | 00015 |
|       | 4        | R0N,RPDR,RPDR0Z,RP0Z,T,THIRD,TLIMD,OUT,TWF1N,TZOM0,               | COMMON2 | 00016 |
|       | 5        | VV,XCONV,XL,XR,YB,YCONV,YT,ZZ                                     | COMMON2 | 00017 |
| 5     |          | EQUIVALENCE (AASC(1),X,XPAN),(AASC(2),R,YPAR),(AASC(3),Y,MPAR),   | EQVREAL | 00002 |
|       | 1        | (AASC(4),I,UG,DEL5M),(AASC(5),V,VG),(AASC(6),R0),                 | EQVREAL | 00003 |
|       | 2        | (AASC(7),STE,MP,RMP,RCSO),(AASC(8),E,ETIL),                       | EQVREAL | 00004 |
|       | 3        | (AASC(9),RVOL),(AASC(10),M,RM,VP),(AASC(11),P,PL,EP,              | EQVREAL | 00005 |
|       | 4        | UP,PM0),(AASC(12),UTIL,UL,CQ,PMX,PU),(AASC(13),VTIL,              | EQVREAL | 00006 |
|       | 5        | VL,PMY,PV),(AASC(14),Q,ROL)                                       | EQVREAL | 00007 |
| 6     |          | REAL LAM,LAMD,M,MR,MC,ML,MP,MPAR,MR,MT,MTE,MU,MUO2,MUO4           | EQVREAL | 00008 |
| 7     |          | DIMENSION X(1),XPAN(1),R(1),YPAN(1),Y(1),MPAR(1),U(1),UG(1),      | DIMEN   | 00002 |
|       | 1        | DEL5M(1),V(1),VG(1),R0(1),STE(1),MP(1),RMP(1),RCSQ(1),            | DIMEN   | 00003 |
|       | 2        | E(1),ETIL(1),RVOL(1),M(1),RM(1),VP(1),P(1),PL(1),EP(1),           | DIMEN   | 00004 |
|       | 3        | UP(1),UTIL(1),UL(1),CQ(1),PMX(1),PU(1),VTIL(1),VL(1),             | DIMEN   | 00005 |
|       | 4        | PMY(1),PV(1),Q(1),ROL(1),PM0(1)                                   | DIMEN   | 00006 |
| 8     |          | NPT = 0                                                           | YASET   | 00155 |
| 9     |          | IF (IRP.EQ.0) RETURN                                              | YASET   | 00156 |
| 10    |          | IF (IRP.GT.1BAR .OR. JBP.GT.JBAR) GO TO 300                       | YASET   | 00157 |
| 11    |          | FIBP = IBP                                                        | YASET   | 00158 |
| 12    |          | FJBP = JBP                                                        | YASFT   | 00159 |
| 13    |          | RIAP = 1./FIBP                                                    | YASET   | 00160 |
| 14    |          | RJBP = 1./FJBP                                                    | YASET   | 00161 |
| 15    |          | IRP1 = IRP+1                                                      | YASET   | 00162 |
| 16    |          | JRP2 = JRP+2                                                      | YASET   | 00163 |
| 17    |          | NQI2 = NQT*2                                                      | YASET   | 00164 |
| 18    |          | IFCP = IPAR = LOCF(AA2)                                           | YASET   | 00165 |
| 19    |          | LPB = NQI/3 *3                                                    | YASET   | 00166 |
| 20    |          | IMOME3 = IMOMX*1000                                               | YASET   | 00167 |
| 21    |          | KP = 1                                                            | YASET   | 00168 |
| 22    |          | MT = 0.                                                           | YASET   | 00169 |
| 23    |          | IF (FREZ.EQ.1.0) GO TO 100                                        | YASET   | 00170 |
| 24    |          | XMAX = (FLOAT(IUNF) + FREZ*(1.-FREZ**I BAR -IUNF ))               | YASET   | 00171 |
|       | 1        | *ROMFR)*DR                                                        | YASET   | 00172 |
| 25    |          | YMAX = REZY0 + (FLOAT(JUNF02) + FREZ*(1.-FREZ**JBAR-JCEN-JUNF02)) | YASET   | 00173 |
|       | 1        | *ROMFR)*DZ                                                        | YASET   | 00174 |
| 26    |          | YMTN = REZY0 - (FLOAT(JUNF02) + FREZ*(1.-FREZ**JCEN -JUNF02))     | YASET   | 00175 |
|       | 1        | *ROMFR)*DZ                                                        | YASET   | 00176 |
| 27    |          | PDR = XMAX*RIAP                                                   | YASET   | 00177 |
| 28    |          | POZ = (YMAX-YMIN)*RJBP                                            | YASET   | 00178 |
| 29    | 100      | READ 900, DRPAR,DZPAR,XC,YC,XD,YD,UPAR,VPA?,MTE,DRAG              | YASET   | 00179 |
| 30    |          | IF (DRPAR.LE.0.) GO TO 290                                        | YASET   | 00180 |
| 31    |          | PRINT 910, DRPAR,DZPAR,XC,YC,XD,YD,UPAR,VPAR,MTE,DRAG             | YASET   | 00181 |
| 32    |          | IF (LPR.GT.0) WRITE(12,910) DRPAR,DZPAR,XC,YC,XD,YD,UPAR,VPAR,    | YASET   | 00182 |

INDEX 01/12/73

|    |     | SUBROUTINE PARTGEN                                             | PAGE  | 25    |
|----|-----|----------------------------------------------------------------|-------|-------|
|    | 1   | MTE,DRAG                                                       | YASET | 00183 |
| 33 |     | USH = SHIFT(UPAR,30).AND.7777777778                            | YASET | 00184 |
| 34 |     | VSH = SHIFT(VPAR,30).AND.7777777778                            | YASET | 00185 |
| 35 |     | DRAG = DRAG.AND,.NOT.7777777778                                | YASET | 00186 |
| 36 |     | YTOP = YC*XD                                                   | YASET | 00187 |
| 37 |     | YBOT = YC-XD                                                   | YASET | 00188 |
| 38 |     | IF (YD,LT,EM10) GO TO 200                                      | YASET | 00189 |
| 39 |     | YTOP = YD                                                      | YASET | 00190 |
| 40 |     | YBOT = YC                                                      | YASET | 00191 |
| 41 |     | IF (FREQ,EQ,1.0) GO TO 200                                     | YASET | 00192 |
| 42 |     | YTOP = YMAX                                                    | YASET | 00193 |
| 43 |     | YBOT = YMIN                                                    | YASET | 00194 |
| 44 |     | XD = XMAX                                                      | YASET | 00195 |
| 45 | 200 | YTE = YBOT+.5*DZPAR                                            | YASET | 00196 |
| 46 | 210 | XTE = XC+.5*ORPAR                                              | YASET | 00197 |
| 47 | 220 | IF (YD,LE,0. .AND. (YTE-YC)**2+XTE**2,GT,XD**2) GO TO 240      | YASET | 00198 |
| 48 |     | XPAR(KP) = (XTE.AND. .NOT. 7777777778) .OR, USH                | YASET | 00199 |
| 49 |     | YPAR(KP) = (YTE.AND. .NOT. 7777777778) .OR, VSH                | YASET | 00200 |
| 50 |     | MC = MTE*(XTE*CYL+DMCYL)                                       | YASET | 00201 |
| 51 |     | MT = MT + MC                                                   | YASET | 00202 |
| 52 |     | MPAR(KP) = DRAG .OR. (SHIFT(MC,30).AND.7777777778)             | YASET | 00203 |
| 53 |     | KP = KP+3                                                      | YASET | 00204 |
| 54 |     | NPT = NPT+1                                                    | YASET | 00205 |
| 55 |     | IF (KP,GT,LP8) GO TO 250                                       | YASET | 00206 |
| 56 | 230 | XTE = XTE+ORPAR                                                | YASET | 00207 |
| 57 |     | IF (XTE,LE,XD) GO TO 220                                       | YASET | 00208 |
| 58 | 240 | YTE = YTE+DZPAR                                                | YASET | 00209 |
| 59 |     | IF (YTE,LE,YTOP) GO TO 210                                     | YASET | 00210 |
| 60 |     | GO TO 100                                                      | YASET | 00211 |
| 61 | 250 | CALL ECWR(AASC,IECP,LP8,NE)                                    | YASET | 00212 |
| 62 |     | IECP = IECP+LP8                                                | YASET | 00213 |
| 63 |     | KP = 1                                                         | YASET | 00214 |
| 64 |     | GO TO 230                                                      | YASET | 00215 |
| 65 | 290 | CALL ECWR(AASC,IECP,LP8,NE)                                    | YASET | 00216 |
| 66 |     | NPS = LOCF(AA2(NPT*3)) - IPAR + 1                              | YASET | 00217 |
| 67 |     | PRTNT 920, NPT,MT                                              | YASET | 00218 |
| 68 |     | IF (LPR,GT,0) WRITE(12,920) NPT,MT                             | YASET | 00219 |
| 69 |     | RETURN                                                         | YASET | 00220 |
| 70 | 300 | PRINT 990                                                      | YASET | 00221 |
| 71 |     | RETURN                                                         | YASET | 00222 |
|    |     | C                                                              | YASET | 00223 |
| 72 | 900 | FORMAT(10F8.3)                                                 | YASET | 00224 |
| 73 | 910 | FORMAT(* ORPAR=*1PE12.5* DZPAR=*E12.5* XC=*E12.5* YC=*E12.5    | YASET | 00225 |
|    |     | 1* XD=*E12.5/* YD=*E12.5* UPAR=*E12.5* VPAR=*E12.5* MTE=*E12.5 | YASET | 00226 |
|    |     | 2* DRAG=*E12.5)                                                | YASET | 00227 |
| 74 | 920 | FORMAT(4X16* PARTICLES GENERATED, WITH TOTAL MASS=*1PE12.5)    | YASET | 00228 |
| 75 | 990 | FORMAT(* PARTICLE GRID TOO LARGE FOR SCM LAYOUT.*)             | YASET | 00229 |
| 76 |     | END                                                            | YASET | 00230 |



| INDEX  | 01/12/73 | SUBROUTINE PARTGEN |      |      |      |      |      |      |
|--------|----------|--------------------|------|------|------|------|------|------|
| I8P1   | -I       | 4C0                | 15=  |      |      |      |      |      |
| I8CP   | -I       | 18=                | 61AG | 62=  | 62   | 65AG |      |      |
| INOME3 | -I       | 4C0                | 20=  |      |      |      |      |      |
| TNOMX  | -I       | 4C0                | 20   |      |      |      |      |      |
| IPAR   | -I       | 4C0                | 18=  | 66   |      |      |      |      |
| IUNF   | -I       | 4C0                | 24   | 24   |      |      |      |      |
| JBAR   | -I       | 4C0                | 10   | 25   |      |      |      |      |
| JBP    | -I       | 4C0                | 10   | 12   | 16   |      |      |      |
| JBP2   | -I       | 4C0                | 16=  |      |      |      |      |      |
| JCFN   | -I       | 4C0                | 25   | 26   |      |      |      |      |
| JUNF02 | -I       | 4C0                | 25   | 25   | 26   | 26   | 53   | 55   |
| KP     | -I       | 21=                | 48   | 49   | 52   | 53=  | 53   | 55   |
| LAM    | -R       | 4C0                | 6RL  |      |      |      |      | 63=  |
| LOCF   | -        | 18SU               | 66SU |      |      |      |      |      |
| LPR    | -I       | 4C0                | 19=  | 55   | 61AG | 62   | 65AG |      |
| LPR    | -I       | 4C0                | 32   | 68   |      |      |      |      |
| M      | (IR      | 5EQ                | 6RL  | 70I  |      |      |      |      |
| MC     | -R       | 6RL                | 50=  | 51   | 52   |      |      |      |
| MP     | (R       | 5EQ                | 6RL  | 70I  |      |      |      |      |
| MPAR   | (R       | 5EQ                | 6RL  | 70I  | 52=  |      |      |      |
| MT     | -R       | 6RL                | 22=  | 51=  | 51   | 67PR | 68WR |      |
| MTE    | -R       | 6RL                | 29RD | 31PR | 32WR | 50   |      |      |
| MU     | -R       | 4C0                | 6RL  |      |      |      |      |      |
| NE     | -I       | 61AG               | 65AG |      |      |      |      |      |
| NPS    | -I       | 4C0                | 66=  |      |      |      |      |      |
| NPT    | -I       | 4C0                | 8=   | 54=  | 54   | 66   | 67PR | 68WR |
| NQT    | -I       | 4C0                | 17   | 19   |      |      |      |      |
| NQT2   | -I       | 4C0                | 17=  |      |      |      |      |      |
| OMCYL  | -R       | 4C0                | 50   |      |      |      |      |      |
| P      | (R       | 5EQ                | 70I  |      |      |      |      |      |
| PDR    | -R       | 4C0                | 27=  |      |      |      |      |      |
| POZ    | -R       | 4C0                | 28=  |      |      |      |      |      |
| PL     | (R       | 5EQ                | 70I  |      |      |      |      |      |
| PMX    | (R       | 5EQ                | 70I  |      |      |      |      |      |
| PMY    | (R       | 5EQ                | 70I  |      |      |      |      |      |
| PH0    | (R       | 5EQ                | 70I  |      |      |      |      |      |
| PRINT  | -        | 31F                | 67F  | 70F  |      |      |      |      |
| PU     | (R       | 5EQ                | 70I  |      |      |      |      |      |
| PV     | (R       | 5EQ                | 70I  |      |      |      |      |      |
| Q      | (R       | 5EQ                | 70I  |      |      |      |      |      |
| R      | (R       | 5EQ                | 70I  |      |      |      |      |      |
| RC5Q   | (R       | 5EQ                | 70I  |      |      |      |      |      |
| RETURN | -        | 9F                 | 69F  | 71F  |      |      |      |      |
| REZY0  | -R       | 4C0                | 25   | 26   |      |      |      |      |
| RIRP   | -R       | 4C0                | 13=  | 27   |      |      |      |      |
| RJRP   | -R       | 4C0                | 14=  | 28   |      |      |      |      |
| RM     | (R       | 5EQ                | 70I  |      |      |      |      |      |
| RMP    | (R       | 5EQ                | 70I  |      |      |      |      |      |
| RO     | (R       | 5EQ                | 70I  |      |      |      |      |      |
| ROL    | (R       | 5EQ                | 70I  |      |      |      |      |      |
| ROMFR  | -R       | 4C0                | 24   | 25   | 26   |      |      |      |
| RVOL   | (R       | 5EQ                | 70I  |      |      |      |      |      |
| SHIFT  | -        | 33SU               | 34SU | 52SU |      |      |      |      |
| SIF    | (R       | 5EQ                | 70I  |      |      |      |      |      |
| U      | (R       | 5EQ                | 70I  |      |      |      |      |      |
| UG     | (R       | 5EQ                | 70I  |      |      |      |      |      |
| UL     | (R       | 5EQ                | 70I  |      |      |      |      |      |
| UP     | (R       | 5EQ                | 70I  |      |      |      |      |      |



|       | INDEX | 01/12/73 | SUBROUTINE PARTGEN |      |     |     |     |    |    | PAGE 28 |
|-------|-------|----------|--------------------|------|-----|-----|-----|----|----|---------|
| UPAR  | -R    | 29RD     | 31PR               | 32WR | 33  |     |     |    |    |         |
| USH   | -R    | 33=      | 48                 |      |     |     |     |    |    |         |
| UTIL  | ()R   | 5FQ      | 7DI                |      |     |     |     |    |    |         |
| V     | ()R   | 5EQ      | 7DI                |      |     |     |     |    |    |         |
| VG    | ()R   | 5EQ      | 7DI                |      |     |     |     |    |    |         |
| VL    | ()R   | 5EQ      | 7DI                |      |     |     |     |    |    |         |
| VP    | ()R   | 5EQ      | 7DI                |      |     |     |     |    |    |         |
| VPAR  | -R    | 29RD     | 31PR               | 32WR | 34  |     |     |    |    |         |
| VSH   | -R    | 34=      | 49                 |      |     |     |     |    |    |         |
| VTIL  | ()R   | 5EQ      | 7DI                |      |     |     |     |    |    |         |
| WRITF | -     | 32F      | 68F                |      |     |     |     |    |    |         |
| X     | ()R   | 5EQ      | 7DI                |      |     |     |     |    |    |         |
| XC    | -R    | 29RD     | 31PR               | 32WR | 46  |     |     |    |    |         |
| XD    | -R    | 29RD     | 31PR               | 32WR | 36  | 37  | 44= | 47 | 57 |         |
| XMAX  | -R    | 24=      | 27                 | 44   |     |     |     |    |    |         |
| XPAR  | ()R   | 5FQ      | 7DI                | 48=  |     |     |     |    |    |         |
| XTE   | -R    | 46=      | 47                 | 48   | 50  | 56= | 56  | 57 |    |         |
| Y     | ()R   | 5EQ      | 7DI                |      |     |     |     |    |    |         |
| YROT  | -R    | 37=      | 40=                | 43=  | 45  |     |     |    |    |         |
| YC    | -R    | 29RD     | 31PR               | 32WR | 36  | 37  | 40  | 47 |    |         |
| YD    | -R    | 29RD     | 31PR               | 32WR | 38  | 39  | 47  |    |    |         |
| YMAX  | -R    | 25=      | 28                 | 42   |     |     |     |    |    |         |
| YMTN  | -R    | 26=      | 28                 | 43   |     |     |     |    |    |         |
| YPAR  | ()R   | 5EQ      | 7DI                | 49=  |     |     |     |    |    |         |
| YTF   | -R    | 45=      | 47                 | 49   | 58= | 5R  | 59  |    |    |         |
| YTOP  | -R    | 36=      | 39=                | 42=  | 59  |     |     |    |    |         |

.....

INDEX 01/12/73

|    | SUBROUTINE MESHMKR                                               | PAGE 29       |
|----|------------------------------------------------------------------|---------------|
| 1  | SUBROUTINE MESHMKR                                               | YASET 00231   |
| 2  | COMMON /YSC1/ AASC(4242)                                         | COMMON2 00002 |
| 3  | COMMON /YSC2/ AA(1),ANC,ASQ,A0,A0FAC,A0M,80,COLAMU,CYL,          | COMMON2 00003 |
| 1  | OR,DT,DTC,DTFAC,DTGR,DTGZ,DTGZP,DTN(10),DTOC(10),                | COMMON2 00004 |
| 2  | DTD16,DT02,DT04,DT08,DT0S,DTV,DTB,DZ,EM10,EPS,FIAP,              | COMMON2 00005 |
| 3  | FIPXL,FIPXR,FIPYB,FIPYT,FXL,FXR,FTYB,FIYT,FJBP,                  | COMMON2 00006 |
| 4  | FREZ,GM1,GM1,GR,GRDEL,GZ,GZP,I,IRAR,IRP,IRP1,ICOLOR,             | COMMON2 00007 |
| 5  | INT0,IJ,IJM,JP,IJPS,IMOM3,IMOMX,IM1,IM6,                         | COMMON2 00008 |
| 6  | IPAR,IPXL,IPXR,IPYR,IPYT,IP1,IP2,ISCF1,ISCF2,ISC2,ISC3,          | COMMON2 00009 |
| 7  | ITV,IUNF,IXL,IXR,IYR,IYT,J,JBAR,JBP,JBP2,JCEN,JM10,              | COMMON2 00010 |
| 8  | JM14,JP1,JP2,JP4,JP402,JUNF,JUNF02,KXI,LAM,LJP2,LPR,             | COMMON2 00011 |
| 9  | LPR,MU,NAME(10),NCYC,NLC,NPS,NPT,NQ,NQ1,NQ1B,NQ12,NSC,           | COMMON2 00012 |
| 1  | NUMIT,NUMT0,NM,OMANC,OMCYL,OMEM10,OPEM10,OPR,PDZ,PXC0NV,         | COMMON2 00013 |
| 2  | PXL,PXR,PXRP,PYR,PYRM,PYCONV,PYT,PY/P,ROT,REZRON,REZSIE,         | COMMON2 00014 |
| 3  | REZUE,REZVE,REZVT,REZY0,RIRAR,RIBJR,RIRP,RJBP,ROMFR,             | COMMON2 00015 |
| 4  | RON,RPDR,RPDRDZ,RPOZ,T,THIRD,TLIMD,TOUT,TWFIN,TZ0MD,             | COMMON2 00016 |
| 5  | VV,XCONV,XL,XR,YB,YCONV,YT,ZZ                                    | COMMON2 00017 |
| 4  | EQUIVALENCE (AASC(1),X,XPARG),(AASC(2),R,YPAR),(AASC(3),Y,MPAR), | EQVREAL 00002 |
| 1  | (AASC(4),I),UG,DELSM),(AASC(5),V,VG),(AASC(6),RO),               | EQVREAL 00003 |
| 2  | (AASC(7),SIE,MP,RMP,RCSQ),(AASC(8),E,ETIL),                      | EQVREAL 00004 |
| 3  | (AASC(9),RVOL),(AASC(10),M,RM,VP),(AASC(11),P,PL,EP,             | EQVREAL 00005 |
| 4  | UP,PM0),(AASC(12),UTIL,UL,CQ,PMX,PU),(AASC(13),VTIL,             | EQVREAL 00006 |
| 5  | VL,PMY,PV),(AASC(14),Q,ROL)                                      | EQVREAL 00007 |
| 5  | REAL LAM,LAMD,M,NR,MC,ML,MP,MPAR,MR,MT,MTE,MU,MU02,MU04          | EQVREAL 00008 |
| 6  | DIMENSION X(1),XPAR(1),R(1),YPAR(1),Y(1),MPAR(1),U(1),UG(1),     | DIMEN 00002   |
| 1  | DELSM(1),V(1),VG(1),RO(1),SIE(1),MP(1),RMP(1),RCSQ(1),           | DIMEN 00003   |
| 2  | E(1),ETIL(1),RVOL(1),M(1),RM(1),VP(1),P(1),PL(1),EP(1),          | DIMEN 00004   |
| 3  | UP(1),UTIL(1),UL(1),CQ(1),PMX(1),PU(1),VTIL(1),VL(1),            | DIMEN 00005   |
| 4  | PMY(1),PV(1),Q(1),ROL(1),PM0(1)                                  | DIMEN 00006   |
| 7  | NGIM = NQ1-1                                                     | YASET 00235   |
| 8  | CALL START                                                       | YASET 00236   |
| 9  | DO 119 J=1,JP4                                                   | YASET 00237   |
| 10 | K = IJM + NGIM                                                   | YASET 00238   |
| 11 | DO 109 I=1,JM,K                                                  | YASET 00239   |
| 12 | 109 AASC(I) = 0.                                                 | YASET 00240   |
| 13 | CALL LOOP                                                        | YASET 00241   |
| 14 | 119 CONTINUE                                                     | YASET 00242   |
| 15 | CALL DONE                                                        | YASET 00243   |
| 16 | 200 XX = 0.0                                                     | YASET 00244   |
| 17 | YY = YB                                                          | YASET 00245   |
| 18 | CALL START                                                       | YASET 00246   |
| 19 | DO 229 J=2,JP2                                                   | YASET 00247   |
| 20 | DO 219 I=1,IP1                                                   | YASET 00248   |
| 21 | X(IJ) = XX                                                       | YASET 00249   |
| 22 | Y(IJ) = YY                                                       | YASET 00250   |
| 23 | R(IJ) = XX*CYL+OMCYL                                             | YASET 00251   |
| 24 | XX = XX + DR                                                     | YASET 00252   |
| 25 | 219 IJ = IJ + NQ                                                 | YASET 00253   |
| 26 | XX = 0.                                                          | YASET 00254   |
| 27 | YY = YY + DZ                                                     | YASET 00255   |
| 28 | CALL LOOP                                                        | YASET 00256   |
| 29 | 229 CONTINUE                                                     | YASET 00257   |
| 30 | CALL DONE                                                        | YASET 00258   |
| 31 | IF (FREZ.EQ.1.0) GO TO 300                                       | YASET 00259   |
| 32 | JCEN = JCEN + 2                                                  | YASET 00260   |
| 33 | JTOP = JCEN + JUNF02                                             | YASET 00261   |
| 34 | JROT = JCEN - JUNF02                                             | YASET 00262   |
| 35 | TJ = FLOAT(JUNF02) * DZ                                          | YASET 00263   |

| INDEX | 01/12/73 | SUBROUTINE MESHMKR                                               | PAGE  | 30    |
|-------|----------|------------------------------------------------------------------|-------|-------|
| 36    |          | CALL START                                                       | YASET | 00264 |
| 37    |          | DO 249 J=2,JP2                                                   | YASET | 00265 |
| 38    |          | DO 239 I=1,IP1                                                   | YASET | 00266 |
| 39    |          | IMJ = IJ - NQ                                                    | YASET | 00267 |
| 40    |          | IF (I.GT.IUNF+1) X(IJ) = X(IMJ) + FREZ*(X(IMJ)-X(IMJ-NQ))        | YASET | 00268 |
| 41    |          | R(IJ) = X(IJ)*CYL + 0MCYL                                        | YASET | 00269 |
| 42    |          | JOT = IARS(IJ-JTOP)                                              | YASET | 00270 |
| 43    |          | JNB = IARS(IJ-JROT)                                              | YASET | 00271 |
| 44    |          | IF (J.LT.JROT) Y(IJ) = REZY0 - TJ - DZ*FREZ*(1.-FREZ**JOB)*RDMFR | YASET | 00272 |
| 45    |          | IF (J.GT.JTOP) Y(IJ) = REZY0 + TJ + DZ*FREZ*(1.-FREZ**JDT)*RDMFR | YASET | 00273 |
| 46    |          | IF (J.EQ.?) YR = Y(IJ)                                           | YASET | 00274 |
| 47    | 239      | IJ = IJ + NQ                                                     | YASET | 00275 |
| 48    |          | CALL LOOP                                                        | YASET | 00276 |
| 49    | 249      | CONTINUE                                                         | YASET | 00277 |
| 50    |          | CALL DONE                                                        | YASET | 00278 |
| 51    | 300      | RFA0 1000. NR, NR, NT, NL, UI, VI, ROI, SIEI                     | YASET | 00279 |
| 52    |          | IF (NR.EQ.0) RETURN                                              | YASET | 00280 |
| 53    |          | IF (NR.EQ.1000) GO TO 400                                        | YASET | 00281 |
| 54    |          | PRINT 1010, NR, NR, NT, NL, UI, VI, ROI, SIEI                    | YASET | 00282 |
| 55    |          | TF (LPR.GT.0) WRITE(12,1010) NR, NR, NT, NL, UI, VI, ROI, SIEI   | YASET | 00283 |
| 56    |          | NR2 = NR + 2                                                     | YASET | 00284 |
| 57    |          | NR1 = NR + 1                                                     | YASET | 00285 |
| 58    |          | NT2 = NT + 2                                                     | YASET | 00286 |
| 59    |          | NL1 = NL + 1                                                     | YASET | 00287 |
| 60    |          | DO 329 J=N02,NT2                                                 | YASET | 00288 |
| 61    |          | CALL RIROW                                                       | YASET | 00289 |
| 62    |          | DO 319 I=NL1,NR1                                                 | YASET | 00290 |
| 63    |          | CALL SETIJ                                                       | YASET | 00291 |
| 64    |          | IF (I.GT.1 .AND. I.LT.IP1) U(IJ)=UI                              | YASET | 00292 |
| 65    |          | IF (J.GT.2 .AND. J.LT.JP2) V(IJ)=VI                              | YASET | 00293 |
| 66    |          | IF (J.EQ.NT2 .OR. I.EQ.NR1) GO TO 319                            | YASET | 00294 |
| 67    |          | RO(IJ) = ROI                                                     | YASET | 00295 |
| 68    |          | SIE(IJ) = SIEI                                                   | YASET | 00296 |
| 69    | 319      | CONTINUE                                                         | YASET | 00297 |
| 70    |          | CALL WIROW                                                       | YASET | 00298 |
| 71    | 329      | CONTINUE                                                         | YASET | 00299 |
| 72    |          | GO TO 300                                                        | YASET | 00300 |
| 73    | 400      | XX = GM1*REZSIE                                                  | YASET | 00301 |
| 74    |          | YY = .5*ARS(GZ)                                                  | YASET | 00302 |
| 75    |          | CALL START                                                       | YASET | 00303 |
| 76    |          | YJC2 = .5*(Y(IJP)+Y(IJ))                                         | YASET | 00304 |
| 77    |          | RNSAV = REZRON*EXP(-GZ*(REZY0-YJC2)/XX)                          | YASET | 00305 |
| 78    |          | FNUM = (Y(IJP)-Y(IJ))*YY                                         | YASET | 00306 |
| 79    |          | FDEN = FNUM*FREZ                                                 | YASET | 00307 |
| 80    |          | ROJ1 = RNSAV*(XX+FNUM)/(XX+FDEN)                                 | YASET | 00308 |
| 81    |          | DO 459 I=1,IP1                                                   | YASET | 00309 |
| 82    |          | RO(IJ) = ROSAV                                                   | YASET | 00310 |
| 83    |          | RO(IJM) = ROJ1                                                   | YASET | 00311 |
| 84    |          | E(IJ) = E(IJM) = REZSIE                                          | YASET | 00312 |
| 85    |          | IJ = IJ + NQ                                                     | YASET | 00313 |
| 86    | 459      | IJM = IJM + NQ                                                   | YASET | 00314 |
| 87    |          | CALL LOOP                                                        | YASET | 00315 |
| 88    |          | DO 479 J=3,JP1                                                   | YASET | 00316 |
| 89    |          | FDEN = (Y(IJP)-Y(IJ))*YY                                         | YASET | 00317 |
| 90    |          | FNUM = (Y(IJ)-Y(IJM))*YY                                         | YASET | 00318 |
| 91    |          | RNSAV = ROSAV*(XX-FNUM)/(XX+FDEN)                                | YASET | 00319 |
| 92    |          | DO 469 I=1,IP1                                                   | YASET | 00320 |
| 93    |          | RO(IJ) = ROSAV                                                   | YASET | 00321 |

| INDEX | 01/12/73 | SUBROUTINE MESHMKR                                                                            | PAGE  | 31    |
|-------|----------|-----------------------------------------------------------------------------------------------|-------|-------|
| 94    |          | E(IJ) = REZSIE                                                                                | YASET | 00322 |
| 95    | 469      | IJ = IJ + NQ                                                                                  | YASET | 00323 |
| 96    |          | CALL LOOP                                                                                     | YASET | 00324 |
| 97    | 479      | CONTINUE                                                                                      | YASET | 00325 |
| 98    |          | FNUM = FNUM*FREZ                                                                              | YASET | 00326 |
| 99    |          | FDEN = FDEN*FREZ                                                                              | YASET | 00327 |
| 100   |          | ROJ2 = ROSAV*(XX-FNUM)/(XX+FDEN)                                                              | YASET | 00328 |
| 101   |          | DO 489 I=I,IP1                                                                                | YASET | 00329 |
| 102   |          | RO(IJ) = ROJ2                                                                                 | YASET | 00330 |
| 103   |          | E(IJ) = REZSIE                                                                                | YASET | 00331 |
| 104   | 489      | IJ = TJ + NQ                                                                                  | YASET | 00332 |
| 105   |          | CALL DONE                                                                                     | YASET | 00333 |
| 106   | 500      | READ 1020, I, JJ, ROI, STEI, VI, UI                                                           | YASET | 00334 |
| 107   |          | IF (I.EQ.0) GO TO 520                                                                         | YASET | 00335 |
| 108   |          | J = JJ + NT-1                                                                                 | YASET | 00336 |
| 109   |          | CALL RIROW                                                                                    | YASET | 00337 |
| 110   |          | CALL SETIJ                                                                                    | YASET | 00338 |
| 111   |          | RO(IJ) = ROI                                                                                  | YASET | 00339 |
| 112   |          | STE(IJ) = STEI                                                                                | YASET | 00340 |
| 113   |          | UL(IJ) = UI                                                                                   | YASET | 00341 |
| 114   |          | VL(TJ) = VI                                                                                   | YASET | 00342 |
| 115   |          | CALL WIROW                                                                                    | YASET | 00343 |
| 116   |          | J = J-2+JJ+1                                                                                  | YASET | 00344 |
| 117   |          | CALL RIROW                                                                                    | YASET | 00345 |
| 118   |          | CALL SETIJ                                                                                    | YASET | 00346 |
| 119   |          | RO(IJ) = ROI                                                                                  | YASET | 00347 |
| 120   |          | STE(IJ) = STEI                                                                                | YASET | 00348 |
| 121   |          | UL(IJ) = UI                                                                                   | YASET | 00349 |
| 122   |          | CALL WIROW                                                                                    | YASET | 00350 |
| 123   |          | J = J-1                                                                                       | YASET | 00351 |
| 124   |          | CALL RIROW                                                                                    | YASET | 00352 |
| 125   |          | CALL SETIJ                                                                                    | YASET | 00353 |
| 126   |          | VL(IJ) = -VI                                                                                  | YASET | 00354 |
| 127   |          | CALL WIROW                                                                                    | YASET | 00355 |
| 128   |          | GO TO 500                                                                                     | YASET | 00356 |
| 129   | 520      | CALL START                                                                                    | YASET | 00357 |
| 130   |          | DO 549 J=2, JBAR                                                                              | YASET | 00358 |
| 131   |          | DO 539 I=1, IM1                                                                               | YASET | 00359 |
| 132   |          | IPJ = IJ+NQ                                                                                   | YASET | 00360 |
| 133   |          | IPJP = TJP+NQ                                                                                 | YASET | 00361 |
| 134   |          | IF (I.EQ.1) V(IPJ) = VL(IJ)                                                                   | YASET | 00362 |
| 135   |          | U(IPJP) = .5*(UL(IJ)+UL(IPJ))                                                                 | YASET | 00363 |
| 136   |          | V(IPJP) = .5*(VL(IJ)+VL(IPJ))                                                                 | YASET | 00364 |
| 137   |          | IJ = IPJ                                                                                      | YASET | 00365 |
| 138   | 539      | IJP = IPJP                                                                                    | YASET | 00366 |
| 139   |          | CALL LOOP                                                                                     | YASET | 00367 |
| 140   | 549      | CONTINUE                                                                                      | YASET | 00368 |
| 141   |          | CALL DONE                                                                                     | YASET | 00369 |
| 142   |          | RETURN                                                                                        | YASET | 00370 |
|       |          | C                                                                                             | YASET | 00371 |
| 143   | 1000     | FORMAT(4I4,4F8.3)                                                                             | YASET | 00372 |
| 144   | 1010     | FORMAT(* NB=*I3* NH=*I3* NT=*I3* NL=*I3* UI=*IPE12.5* VI=*<br>I12.5* ROI=*E12.5* SIEI=*E12.5) | YASET | 00373 |
| 145   | 1020     | FORMAT(2I5,4(4X,E11.5))                                                                       | YASET | 00374 |
| 146   |          | END                                                                                           | YASF  | 00375 |



| INDEX  | 01/12/73 | SUBROUTINE MESHMKR |       |       |      |      |       |       |      |     |      | PAGE 33 |      |       |       |      |       |      |  |  |
|--------|----------|--------------------|-------|-------|------|------|-------|-------|------|-----|------|---------|------|-------|-------|------|-------|------|--|--|
| FRFZ   | -R       | 3C0                | 31    | 40    | 44   | 44   | 45    | 45    | 79   | 98  | 99   |         |      |       |       |      |       |      |  |  |
| GMI    | -R       | 3C0                | 73    |       |      |      |       |       |      |     |      |         |      |       |       |      |       |      |  |  |
| GZ     | -R       | 3C0                | 74    | 77    |      |      |       |       |      |     |      |         |      |       |       |      |       |      |  |  |
| T      | -I       | 3C0                | 1100  | 12    | 2000 | 3800 | 40    | 6200  | 64   | 64  | 66   | 8100    | 9200 | 10100 | 10600 | 107  | 13100 | 134  |  |  |
| IARS   | -        | 42SU               | 43SU  |       |      |      |       |       |      |     |      |         |      |       |       |      |       |      |  |  |
| IJ     | -I       | 3C0                | 21    | 22    | 23   | 25=  | 25    | 39    | 40   | 41  | 41   | 44      | 45   | 46    | 47=   | 47   | 64    | 65   |  |  |
|        |          | 67                 | 68    | 76    | 78   | 82   | 84    | 85=   | 85   | 89  | 90   | 93      | 94   | 95=   | 95    | 102  | 103   | 104= |  |  |
|        |          | 104                | 111   | 112   | 113  | 114  | 119   | 120   | 121  | 126 | 132  | 134     | 135  | 136   | 137=  |      |       |      |  |  |
| IJM    | -I       | 3C0                | 10    | 1100  | 83   | 84   | 86=   | 86    | 90   |     |      |         |      |       |       |      |       |      |  |  |
| IJP    | -I       | 3C0                | 76    | 78    | 89   | 133  | 134   | 135   | 138= |     |      |         |      |       |       |      |       |      |  |  |
| IMJ    | -I       | 39=                | 40    | 40    | 40   |      |       |       |      |     |      |         |      |       |       |      |       |      |  |  |
| IMI    | -I       | 3C0                | 13100 |       |      |      |       |       |      |     |      |         |      |       |       |      |       |      |  |  |
| IPJ    | -I       | 132=               | 136   | 137   |      |      |       |       |      |     |      |         |      |       |       |      |       |      |  |  |
| IPJP   | -I       | 133=               | 135   | 136   | 138  |      |       |       |      |     |      |         |      |       |       |      |       |      |  |  |
| IP1    | -I       | 3C0                | 2000  | 3800  | 64   | 8100 | 9200  | 10100 |      |     |      |         |      |       |       |      |       |      |  |  |
| IUNF   | -I       | 3C0                | 40    |       |      |      |       |       |      |     |      |         |      |       |       |      |       |      |  |  |
| J      | -I       | 3C0                | 900   | 1900  | 3700 | 42   | 43    | 44    | 45   | 46  | 6000 | 65      | 65   | 66    | 8800  | 108= | 116=  | 116  |  |  |
|        |          | 123=               | 123   | 13000 |      |      |       |       |      |     |      |         |      |       |       |      |       |      |  |  |
| JRAR   | -I       | 3C0                | 13000 |       |      |      |       |       |      |     |      |         |      |       |       |      |       |      |  |  |
| JBNT   | -I       | 34=                | 43    | 44    |      |      |       |       |      |     |      |         |      |       |       |      |       |      |  |  |
| JCEN   | -I       | 3C0                | 32=   | 32    | 33   | 34   |       |       |      |     |      |         |      |       |       |      |       |      |  |  |
| JDR    | -I       | 43=                | 44    |       |      |      |       |       |      |     |      |         |      |       |       |      |       |      |  |  |
| JDT    | -I       | 42=                | 45    |       |      |      |       |       |      |     |      |         |      |       |       |      |       |      |  |  |
| JJ     | -I       | 106RD              | 108   | 116   |      |      |       |       |      |     |      |         |      |       |       |      |       |      |  |  |
| JPT    | -I       | 3C0                | 8800  |       |      |      |       |       |      |     |      |         |      |       |       |      |       |      |  |  |
| JP2    | -I       | 3C0                | 1900  | 3700  | 65   |      |       |       |      |     |      |         |      |       |       |      |       |      |  |  |
| JP4    | -I       | 3C0                | 900   |       |      |      |       |       |      |     |      |         |      |       |       |      |       |      |  |  |
| JTOP   | -I       | 33=                | 42    | 45    |      |      |       |       |      |     |      |         |      |       |       |      |       |      |  |  |
| JUNF02 | -I       | 3C0                | 33    | 34    | 35   |      |       |       |      |     |      |         |      |       |       |      |       |      |  |  |
| K      | -I       | 10=                | 1100  |       |      |      |       |       |      |     |      |         |      |       |       |      |       |      |  |  |
| LAM    | -R       | 3C0                | 5RL   |       |      |      |       |       |      |     |      |         |      |       |       |      |       |      |  |  |
| LOOP   | -        | 13SU               | 28SU  | 48SU  | 87SU | 96SU | 139SU |       |      |     |      |         |      |       |       |      |       |      |  |  |
| LPR    | -I       | 3C0                | 55    |       |      |      |       |       |      |     |      |         |      |       |       |      |       |      |  |  |
| M      | ()R      | 4EQ                | 5RL   | 60I   |      |      |       |       |      |     |      |         |      |       |       |      |       |      |  |  |
| MP     | ()R      | 4EQ                | 5RL   | 60I   |      |      |       |       |      |     |      |         |      |       |       |      |       |      |  |  |
| MPAR   | ()R      | 4EQ                | 5RL   | 60I   |      |      |       |       |      |     |      |         |      |       |       |      |       |      |  |  |
| MU     | -R       | 3C0                | 5RL   |       |      |      |       |       |      |     |      |         |      |       |       |      |       |      |  |  |
| NR     | -I       | 51RD               | 54PR  | 55WR  | 56   |      |       |       |      |     |      |         |      |       |       |      |       |      |  |  |
| NR2    | .I       | 56=                | 6000  |       |      |      |       |       |      |     |      |         |      |       |       |      |       |      |  |  |
| NL     | -I       | 51RD               | 54PR  | 55WR  | 59   |      |       |       |      |     |      |         |      |       |       |      |       |      |  |  |
| NL1    | -I       | 59=                | 6200  |       |      |      |       |       |      |     |      |         |      |       |       |      |       |      |  |  |
| NQ     | .I       | 3C0                | 25    | 39    | 40   | 47   | 85    | 86    | 95   | 104 | 132  | 133     |      |       |       |      |       |      |  |  |
| NQ1    | -I       | 3C0                | 7     |       |      |      |       |       |      |     |      |         |      |       |       |      |       |      |  |  |
| NQIM   | .I       | 7=                 | 10    |       |      |      |       |       |      |     |      |         |      |       |       |      |       |      |  |  |
| NR     | -I       | 51RD               | 52    | 53    | 54PR | 55WR | 57    |       |      |     |      |         |      |       |       |      |       |      |  |  |
| NR1    | -I       | 57=                | 6200  | 66    |      |      |       |       |      |     |      |         |      |       |       |      |       |      |  |  |
| NT     | -I       | 51RD               | 54PR  | 55WR  | 58   | 108  |       |       |      |     |      |         |      |       |       |      |       |      |  |  |
| NT2    | .I       | 58=                | 6000  | 66    |      |      |       |       |      |     |      |         |      |       |       |      |       |      |  |  |
| OMCYL  | -R       | 3C0                | 23    | 41    |      |      |       |       |      |     |      |         |      |       |       |      |       |      |  |  |
| P      | ()R      | 4EQ                | 60I   |       |      |      |       |       |      |     |      |         |      |       |       |      |       |      |  |  |
| PL     | ()R      | 4EQ                | 60I   |       |      |      |       |       |      |     |      |         |      |       |       |      |       |      |  |  |
| PMX    | ()R      | 4EQ                | 60I   |       |      |      |       |       |      |     |      |         |      |       |       |      |       |      |  |  |
| PHY    | ()R      | 4EQ                | 60I   |       |      |      |       |       |      |     |      |         |      |       |       |      |       |      |  |  |
| PH0    | ()R      | 4EQ                | 60I   |       |      |      |       |       |      |     |      |         |      |       |       |      |       |      |  |  |
| PU     | ()R      | 4EQ                | 60I   |       |      |      |       |       |      |     |      |         |      |       |       |      |       |      |  |  |
| PV     | ()R      | 4EQ                | 60I   |       |      |      |       |       |      |     |      |         |      |       |       |      |       |      |  |  |
| Q      | ()R      | 4EQ                | 60I   |       |      |      |       |       |      |     |      |         |      |       |       |      |       |      |  |  |
| R      | ()R      | 4EQ                | 60I   | 23=   | 41=  |      |       |       |      |     |      |         |      |       |       |      |       |      |  |  |



INDEX 01/12/73  
1

OVERLAY(YAQUFIL,2,0)  
OVERLAY(YAQUFIL,2,0)

PAGE 35  
YAQUI1 00002

INDEX 01/12/73  
1  
2  
3  
4 10  
5

PROGRAM YAQUI1 PROGRAM YAQUI1  
PRINT 10  
CALL YAQUI2  
FORMAT(\* YAQUI2 CALLED\*)  
END

PAGE 36  
YAQUI1 00003  
YAQUI1 00004  
YAQUI1 00005  
YAQUI1 00006  
YAQUI1 00007

INDEX 01/12/73 PROGRAM YAQUI1  
SINGLY REFERENCED VARIABLES  
PRINT - 2F YAQUI1 - 1SU YAQUI2 - 3SU  
-----  
MULTIPLY-REFERENCED VARIABLES  
10 - 2PR 4\*

PAGE 37



| INDEX | 01/12/73 | SUBROUTINE YAQUIZ                                                  | PAGE 38       |
|-------|----------|--------------------------------------------------------------------|---------------|
| 1     |          | SUBROUTINE YAQUIZ                                                  | YAQUI1 00008  |
| 2     |          | LCM /YLC1/ AA1(131000) /YLC2/ AA2(131000)                          | YAQUI1 00009  |
| 3     |          | COMMON /YSC1/ AASC(4242)                                           | COMMON2 00002 |
| 4     |          | COMMON /YSC2/ AA(1),ANC,ASQ,A0,A0FAC,A0M,R0,COLAMU,CYL,            | COMMON2 00003 |
|       | 1        | DR,DT,DTC,DTFAC,DTGR,DTG7,DTGZP,DTN(10),DTOC(10),                  | COMMON2 00004 |
|       | 2        | DTD16,DT02,DT04,DT08,DTP05,DTV,DT8,DZ,EM10,EPS,FIBP,               | COMMON2 00005 |
|       | 3        | FIPXL,FIPXR,FIPY8,FIPYT,FI XL,FI XR,FI Y8,FI YT,FJBP,              | COMMON2 00006 |
|       | 4        | FREZ,GM1,GM1,GR,GRVEL,GZ,GZP,I,IRAR,IRP,IHP1,ICOLOR,               | COMMON2 00007 |
|       | 5        | IDT0,IJ,IJM,IJP,IJS,IMOME3,IMOMX,IM1,IM6,                          | COMMON2 00008 |
|       | 6        | IPAR,IPXL,IPXR,IPY8,IPYT,IP1,IP2,ISC1,ISC2,ISC3,                   | COMMON2 00009 |
|       | 7        | ITV,IUNF,IXL,IXR,IYR,IYT,J,JBAR,JBP,JRP2,JCEN,JM10,                | COMMON2 00010 |
|       | 8        | JMT4,JP1,JP2,JP4,JP402,JUNF,JUNF02,KXI,LAM,LJP2,LPR,               | COMMON2 00011 |
|       | 9        | LPR,MU,NAME(10),NCYC,NLC,NPS,NPT,NQ,NQ1,NQTH,NQI2,NSC,             | COMMON2 00012 |
|       | 1        | NUMIT,NUMTD,ON,OMANC,OMCYL,OMEM10,OPEM10,PDR,PDZ,PXCONV,           | COMMON2 00013 |
|       | 2        | PXL,PXR,PXRP,PY8,PY8M,PYCONV,PYT,PYT,ROD,REZRON,REZSIE,            | COMMON2 00014 |
|       | 3        | REZUE,REZVF,REZVT,REZY0,RIAR,RIAR,RIAP,RJBP,ROMFR,                 | COMMON2 00015 |
|       | 4        | RON,RPDR,RPDR0Z,RPOZ,T,THIRD,TLIND,TOUT,TWFIN,TZ0M0,               | COMMON2 00016 |
|       | 5        | VV,XCONV,XL,XR,Y8,YCONV,YT,ZZ                                      | COMMON2 00017 |
|       | 5        | EQUIVALENCE (AASC(1),X,XPAR),(AASC(2),R,YPAR),(AASC(3),Y,MPAR),    | EQVREAL 00002 |
|       | 1        | (AASC(4),U,UG,DEL SM),(AASC(5),V,VG),(AASC(6),RO),                 | EQVREAL 00003 |
|       | 2        | (AASC(7),STE,MP,RMP,RCSQ),(AASC(8),E,ETIL),                        | EQVREAL 00004 |
|       | 3        | (AASC(9),RVOL),(AASC(10),M,RM,V?),(AASC(11),P,PL,EP,               | EQVREAL 00005 |
|       | 4        | UP,PM0),(AASC(12),UTIL,UL,CQ,PMX,PU),(AASC(13),VTIL,               | EQVREAL 00006 |
|       | 5        | VL,PMY,PV),(AASC(14),Q,R0L)                                        | EQVREAL 00007 |
|       | 6        | REAL LAM,LAMD,M,MR,MC,ML,MP,MPAR,MR,MT,MTE,MU,MU02,MU04            | EQVREAL 00008 |
|       | 7        | DIMENSION X(1),XPAR(1),R(1),YPAR(1),Y(1),MPAR(1),U(1),UG(1),       | DIMEN 00002   |
|       | 1        | DEL SM(1),V(1),VG(1),RO(1),STE(1),MP(1),RMP(1),RCSQ(1),            | DIMEN 00003   |
|       | 2        | E(1),ETIL(1),RVOL(1),M(1),RM(1),V?(1),P(1),PL(1),EP(1),            | DIMEN 00004   |
|       | 3        | UP(1),UTIL(1),UL(1),CQ(1),PMX(1),PU(1),VTIL(1),VL(1),              | DIMEN 00005   |
|       | 4        | PMY(1),PV(1),Q(1),R0L(1),PM0(1)                                    | DIMEN 00006   |
|       | 8        | DIMENSION AT(100),FT(100),IX1(1),IX2(1),IY1(1),IY2(1),XC0(4),YC0(4 | YAQUI1 00013  |
|       | 1        | ),CON(100)                                                         | YAQUI1 00014  |
|       | 9        | EQUIVALENCE (AT,IX1),(AT(2),IX2),(AT(3),IY1),(AT(4),IY2),(AT(5),   | YAQUI1 00015  |
|       | 1        | XC0),(AT(9),YC0),(FT,CON)                                          | YAQUI1 00016  |
|       | 10       | COMMON /YSC3/ JNM                                                  | YAQUI1 00017  |
|       | 11       | CALL SECON0 (TBASE)                                                | YAQUI1 00018  |
|       | 12       | T1 = TBASE                                                         | YAQUI1 00019  |
|       | 13       | CALL GET0 (4LKJRN,JNM)                                             | YAQUI1 00020  |
|       | 14       | CALL H4020                                                         | YAQUI1 00021  |
|       | 15       | CALL GETQ (4LKTLM,I)                                               | YAQUI1 00022  |
|       | 16       | TLIM = II                                                          | YAQUI1 00023  |
|       | 17       | DTVSAV = DTCSAV = 0.0                                              | YAQUI1 00024  |
|       | 18       | IF (IRAR,EQ,0) GO TO 370                                           | YAQUI1 00025  |
|       | 19       | TLIM = TLIM*27.5E-9 - 40. + (I.-TLIMD)*1.E+10                      | YAQUI1 00026  |
|       | 20       | CALL START                                                         | YAQUI1 00027  |
|       | 21       | CIRC = 0.                                                          | YAQUI1 00028  |
|       | 22       | DO 199 J=2,JP1                                                     | YAQUI1 00029  |
|       | 23       | DO 189 I=1,IRAR                                                    | YAQUI1 00030  |
|       | 24       | IPJ = IJ + NQ                                                      | YAQUI1 00031  |
|       | 25       | IPJP = IJP + NQ                                                    | YAQUI1 00032  |
|       | 26       | IF (I,EQ,1) CIRC = CIRC + 0.5*(V(IJ)+V(IJP))*(Y(IJP)-Y(IJ))        | YAQUI1 00033  |
|       | 27       | IF (I,EQ,IM1) CIRC = CIRC - 0.5*(V(IJ)+V(IJP))*(Y(IJP)-Y(IJ))      | YAQUI1 00034  |
|       | 28       | IF (J,EQ,3) CIRC = CIRC - 0.5*(U(IJ)+U(IPJ))*IX(IPJ)-X(IJ)         | YAQUI1 00035  |
|       | 29       | IF (J,EQ,JBAR) CIRC = CIRC + 0.5*(U(IJ)+U(IPJ))*X(IPJ)-X(IJ)       | YAQUI1 00036  |
|       | 30       | SIET = AMAX1(SIE(IJ),0.)                                           | YAQUI1 00037  |
|       | 31       | P(IJ) = ASQ*(RO(IJ)-RON) + GM1*RO(IJ)*SIET                         | YAQUI1 00038  |
|       | 32       | IF (ASQ,LT,1.E+6) GO TO 180                                        | YAQUI1 00039  |
|       | 33       | P(IJ) = ASQ*(RO(IJ)-RON) + GM1*RO(IJ)*SIET                         | YAQUI1 00040  |

| INDEX | 01/12/73 | SUBROUTINE YAQUI2                                                                         | PAGE 39                      |
|-------|----------|-------------------------------------------------------------------------------------------|------------------------------|
| 34    |          | IF (NCYC, EQ. 0) P(IJ) = -RON*GZ*(YT-Y8-(FLOAT(J)-1.5)*DZ)                                | YAQUI1 00041                 |
| 35    | 180      | IJP = IPJP                                                                                | YAQUI1 00042                 |
| 36    | 189      | IJ = IPJ                                                                                  | YAQUI1 00043                 |
| 37    |          | CALL LOOP                                                                                 | YAQUI1 00044                 |
| 38    | 199      | CONTINUE                                                                                  | YAQUI1 00045                 |
| 39    |          | CALL DONE                                                                                 | YAQUI1 00046                 |
| 40    | 200      | TOLD = T2                                                                                 | YAQUI1 00047                 |
| 41    |          | CALL SECOND (T2)                                                                          | YAQUI1 00048                 |
| 42    |          | XX = (T2-TOLD)*RIRJB                                                                      | YAQUI1 00049                 |
| 43    |          | IF (LPR.GT.0) WRITE(12,4000) T,NCYC,DT,XX,CIRC,DTV,IDTV,JDTV,<br>1 NUMIT,T2,DTC,IDTC,JDTC | YAQUI1 00050<br>YAQUI1 00051 |
| 44    |          | CALL EMPTY                                                                                | YAQUI1 00052                 |
| 45    |          | PRINT 4000, T,NCYC,DT,XX,CIRC,DTV,IDTV,JDTV,<br>1 NUMIT,T2,DTC,IDTC,JDTC                  | YAQUI1 00053<br>YAQUI1 00054 |
| 46    |          | IF (T+ EM10 .GE. TOUT) GO TO 290                                                          | YAQUI1 00055                 |
| 47    |          | IF (NCYC.LE.1 .OR. NUMIT.GT.499) GO TO 300                                                | YAQUI1 00056                 |
| 48    | 210      | IF (T2-T1.GE.1200. .AND. T2MD.GT.EM10) GO TO 320                                          | YAQUI1 00057                 |
| 49    |          | IF (T2-TBASE.GE.TLIM) GO TO 330                                                           | YAQUI1 00058                 |
| 50    | 220      | IF (T.GE.TWFIN) GO TO 340                                                                 | YAQUI1 00059                 |
| 51    |          | NCYC = NCYC + 1                                                                           | YAQUI1 00060                 |
| 52    |          | IF (NCYC, EQ. 2) DT = DTPOS = DT*10.                                                      | YAQUI1 00061                 |
| 53    |          | IF (NCYC, GE. 3) DT = DTPOS = AMINI(DTV, DTC)                                             | YAQUI1 00062                 |
| 54    |          | DTFAC = 1.25                                                                              | YAQUI1 00063                 |
| 55    |          | DTV = DTC = DT*DTFAC                                                                      | YAQUI1 00064                 |
| 56    |          | IF (T+DT.GT.TOUT) DT = TOUT-T                                                             | YAQUI1 00065                 |
| 57    |          | T = T + DT                                                                                | YAQUI1 00066                 |
| 58    |          | RNT = 1./DT                                                                               | YAQUI1 00067                 |
| 59    |          | DT02 = .5*DT                                                                              | YAQUI1 00068                 |
| 60    |          | DT04 = .25*DT                                                                             | YAQUI1 00069                 |
| 61    |          | DT08 = .125*DT                                                                            | YAQUI1 00070                 |
| 62    |          | DT016 = .0625*DT                                                                          | YAQUI1 00071                 |
| 63    |          | DTR = DT*R.                                                                               | YAQUI1 00072                 |
| 64    |          | DTGR = DT*GR                                                                              | YAQUI1 00073                 |
| 65    |          | DTGZ = DT*GZ                                                                              | YAQUI1 00074                 |
| 66    |          | DTGZP = DT*GZP                                                                            | YAQUI1 00075                 |
| 67    |          | GO TO 1000                                                                                | YAQUI1 00076                 |
| 68    | 290      | TOUT = TOUT + DT0(IDT0)                                                                   | YAQUI1 00077                 |
| 69    |          | IF (T+ EM10 .LT. DT0C(IDT0)) GO TO 300                                                    | YAQUI1 00078                 |
| 70    |          | TOUT = DT0C(IDT0) + DT0(IDT0+1)                                                           | YAQUI1 00079                 |
| 71    |          | IDT0 = IDT0 + 1                                                                           | YAQUI1 00080                 |
| 72    | 300      | ASSIGN 310 TO KRET                                                                        | YAQUI1 00081                 |
| 73    |          | GO TO 500                                                                                 | YAQUI1 00082                 |
| 74    | 310      | ASSTGN 210 TO KRET                                                                        | YAQUI1 00083                 |
| 75    |          | GO TO 400                                                                                 | YAQUI1 00084                 |
| 76    | 320      | T1 = T2                                                                                   | YAQUI1 00085                 |
| 77    |          | ASSTGN 220 TO KRET                                                                        | YAQUI1 00086                 |
| 78    |          | GO TO 350                                                                                 | YAQUI1 00087                 |
| 79    | 330      | ASSIGN 340 TO KRET                                                                        | YAQUI1 00088                 |
| 80    |          | GO TO 350                                                                                 | YAQUI1 00089                 |
| 81    | 340      | RETURN                                                                                    | YAQUI1 00090                 |
| 82    | 350      | PRINT 4010, NUMTD, T, NCYC                                                                | YAQUI1 00091                 |
| 83    |          | IF (LPR.GT.0) WRITE(12,4010) NUMTD, T, NCYC                                               | YAQUI1 00092                 |
| 84    |          | WRITE(R) (AA(N), N=1, NSC)                                                                | YAQUI1 00093                 |
| 85    |          | WRITE(R) (AA1(N), N=1, NLC)                                                               | YAQUI1 00094                 |
| 86    |          | IF (NPT.GT.0) WRITE(R) (AA2(N), N=1, NPS)                                                 | YAQUI1 00095                 |
| 87    |          | CALL DATAREL (3L5ETR)                                                                     | YAQUI1 00096                 |
| 88    |          | CALL AFSREL (3LOUT)                                                                       | YAQUI1 00097                 |
| 89    |          | CALL AFSREL (4LFLM)                                                                       | YAQUI1 00098                 |

| INDEX | 01/12/73 | SUBROUTINE YAQUIZ                             | PAGE   | 40    |
|-------|----------|-----------------------------------------------|--------|-------|
| 90    |          | NUMTD = NUMTD + 1                             | YAQUI1 | 00099 |
| 91    |          | GO TO KRET                                    | YAQUI1 | 00100 |
| 92    | 370      | REWIND 7                                      | YAQUI1 | 00101 |
| 93    |          | JTD = JRAR                                    | YAQUI1 | 00102 |
| 94    |          | JNSC = LOCF(ZZ) - LOCF(AA) + 1                | YAQUI1 | 00103 |
| 95    |          | READ(7) (AA(N),N=1,JNSC)                      | YAQUI1 | 00104 |
| 96    |          | IF (JTD,NF,NUMTD) GO TO 380                   | YAQUI1 | 00105 |
| 97    |          | READ(7) (AA1(N),N=1,NLC)                      | YAQUI1 | 00106 |
| 98    |          | IF (NPT.GT.0) READ(7) (AA2(N),N=1,NPS)        | YAQUI1 | 00107 |
| 99    |          | CALL AFSRFL (5LFSF7)                          | YAQUI1 | 00108 |
| 100   |          | NUMTD = NUMTD + 1                             | YAQUI1 | 00109 |
| 101   |          | TLIM = TLIM*27.5E-9 - 40. + (1.-TLIMD)*1.E+10 | YAQUI1 | 00110 |
| 102   |          | PRINT 4020, JTD                               | YAQUI1 | 00111 |
| 103   |          | PRINT 4030, NAME,T,NCYC                       | YAQUI1 | 00112 |
| 104   |          | IF (LPR,EQ.0) GO TO 220                       | YAQUI1 | 00113 |
| 105   |          | WRITE(12,4020) JTD                            | YAQUI1 | 00114 |
| 106   |          | WRITE(12,4030) NAME,T,NCYC                    | YAQUI1 | 00115 |
| 107   |          | GO TO 220                                     | YAQUI1 | 00116 |
| 108   | 380      | PRINT 4040                                    | YAQUI1 | 00117 |
| 109   |          | WRITE(12,4040)                                | YAQUI1 | 00118 |
| 110   |          | CALL AFSREL (5LFSF7)                          | YAQUI1 | 00119 |
| 111   |          | RETURN                                        | YAQUI1 | 00120 |
| 112   | 400      | IF (LPR,EQ.0) GO TO KRET                      | YAQUI1 | 00121 |
| 113   |          | ASSIGN 440 TO KRF                             | YAQUI1 | 00122 |
| 114   |          | ASSIGN 440 TO KRP                             | YAQUI1 | 00123 |
| 115   |          | ASSIGN 460 TO KRFP                            | YAQUI1 | 00124 |
| 116   |          | GO TO (420,410,458) LPR                       | YAQUI1 | 00125 |
| 117   | 410      | ASSTGN 458 TO KRF                             | YAQUI1 | 00126 |
| 118   |          | ASSIGN 456 TO KRFP                            | YAQUI1 | 00127 |
| 119   | 420      | CALL LINCNT (64)                              | YAQUI1 | 00128 |
| 120   |          | CALL ADV (1)                                  | YAQUI1 | 00129 |
| 121   |          | GO TO 454                                     | YAQUI1 | 00130 |
| 122   | 440      | KRF = KRFP                                    | YAQUI1 | 00131 |
| 123   |          | ASSIGN 460 TO KRP                             | YAQUI1 | 00132 |
| 124   |          | CALL START                                    | YAQUI1 | 00133 |
| 125   |          | DO 479 J=1,JP2                                | YAQUI1 | 00134 |
| 126   |          | DO 479 I=1,IP1                                | YAQUI1 | 00135 |
| 127   |          | IPJM = IJM + NQ                               | YAQUI1 | 00136 |
| 128   |          | IPJ = IJ + NQ                                 | YAQUI1 | 00137 |
| 129   |          | D = PRM = PRV = PRSIE = 0.                    | YAQUI1 | 00138 |
| 130   |          | IF (J,EQ.1) GO TO 450                         | YAQUI1 | 00139 |
| 131   |          | IF (RM(IJM).NE.0.) PRM=1./RM(IJM)             | YAQUI1 | 00140 |
| 132   |          | IF (I,EQ.IP1 .OR. J,EQ.JP2) GO TO 450         | YAQUI1 | 00141 |
| 133   |          | PRSIE = SIF(IJM)                              | YAQUI1 | 00142 |
| 134   |          | IF (RVOL(IJM).NE.0.) PRV=1./RVOL(IJM)         | YAQUI1 | 00143 |
| 135   |          | X1 = X(IPJM)                                  | YAQUI1 | 00144 |
| 136   |          | Y1 = Y(IPJM)                                  | YAQUI1 | 00145 |
| 137   |          | R1 = R(IPJM)                                  | YAQUI1 | 00146 |
| 138   |          | U1 = U(IPJM)                                  | YAQUI1 | 00147 |
| 139   |          | V1 = V(IPJM)                                  | YAQUI1 | 00148 |
| 140   |          | X2 = X(IPJ)                                   | YAQUI1 | 00149 |
| 141   |          | Y2 = Y(IPJ)                                   | YAQUI1 | 00150 |
| 142   |          | R2 = R(IPJ)                                   | YAQUI1 | 00151 |
| 143   |          | U2 = U(IPJ)                                   | YAQUI1 | 00152 |
| 144   |          | V2 = V(IPJ)                                   | YAQUI1 | 00153 |
| 145   |          | X3 = X(IJ)                                    | YAQUI1 | 00154 |
| 146   |          | Y3 = Y(IJ)                                    | YAQUI1 | 00155 |
| 147   |          | R3 = R(IJ)                                    | YAQUI1 | 00156 |

| IN0EX | 01/12/73 | SUBROUTINE YAQUIZ                                                  | PAGE   | 41    |
|-------|----------|--------------------------------------------------------------------|--------|-------|
| 148   |          | U3 = U(IJ)                                                         | YAQUI1 | 00157 |
| 149   |          | V3 = V(IJ)                                                         | YAQUI1 | 00158 |
| 150   |          | X4 = X(IJM)                                                        | YAQUI1 | 00159 |
| 151   |          | Y4 = Y(IJM)                                                        | YAQUI1 | 00160 |
| 152   |          | R4 = R(IJM)                                                        | YAQUI1 | 00161 |
| 153   |          | U4 = U(IJM)                                                        | YAQUI1 | 00162 |
| 154   |          | V4 = V(IJM)                                                        | YAQUI1 | 00163 |
| 155   |          | D = .25*RVOL(IJM)*((R1+R2)*((U1+U2)*(Y2-Y1)+(V1+V2)*(X1-X2))       | YAQUI1 | 00164 |
|       |          | 1 + (R2+R3)*((U2+U3)*(Y3-Y2)+(V2+V3)*(X2-X3))                      | YAQUI1 | 00165 |
|       |          | 2 + (R3+R4)*((U3+U4)*(Y4-Y3)+(V3+V4)*(X3-X4))                      | YAQUI1 | 00166 |
|       |          | 3 + (R4+R1)*((U4+U1)*(Y1-Y4)+(V4+V1)*(X4-X1))                      | YAQUI1 | 00167 |
| 156   | 450      | GO TO (452,452,456) LPR                                            | YAQUI1 | 00168 |
| 157   | 452      | WRITE(12,4070) I,J,X(IJM),Y(IJM),U(IJM),V(IJM),PR\$IE,RO(IJM),PRV, | YAQUI1 | 00169 |
|       |          | 1 D,PRM,P(IJM)                                                     | YAQUI1 | 00170 |
| 158   |          | LTNESF = LINESF + 1                                                | YAQUI1 | 00171 |
| 159   |          | IF (LINESF.LT.62) GO TO KRF                                        | YAQUI1 | 00172 |
| 160   | 454      | LINESF = 0                                                         | YAQUI1 | 00173 |
| 161   |          | WRITE(12,4080) JNM,NAME,T,NCYC                                     | YAQUI1 | 00174 |
| 162   |          | WRITE(12,4060)                                                     | YAQUI1 | 00175 |
| 163   |          | GO TO KRF                                                          | YAQUI1 | 00176 |
| 164   | 456      | PRINT 4070, I,J,X(IJM),Y(IJM),U(IJM),V(IJM),PR\$IE,RO(IJM),PRV,    | YAQUI1 | 00177 |
|       |          | 1 D,PRM,P(IJM)                                                     | YAQUI1 | 00178 |
| 165   |          | LINESP = LINESP + 1                                                | YAQUI1 | 00179 |
| 166   |          | IF (LINESP.LT.57) GO TO KRP                                        | YAQUI1 | 00180 |
| 167   | 458      | LINESP = 0                                                         | YAQUI1 | 00181 |
| 168   |          | PRNT 4050                                                          | YAQUI1 | 00182 |
| 169   |          | PRINT 4080, JNM,NAME,T,NCYC                                        | YAQUI1 | 00183 |
| 170   |          | PRINT 4060                                                         | YAQUI1 | 00184 |
| 171   |          | GO TO KRP                                                          | YAQUI1 | 00185 |
| 172   | 460      | IJ = TPJ                                                           | YAQUI1 | 00186 |
| 173   | 479      | IJM = IPJM                                                         | YAQUI1 | 00187 |
| 174   |          | CALL LOOP                                                          | YAQUI1 | 00188 |
| 175   | 489      | CONTINUE                                                           | YAQUI1 | 00189 |
| 176   |          | IF (LPR.GT.2) GO TO KRET                                           | YAQUI1 | 00190 |
| 177   | 490      | CALL EMPTY                                                         | YAQUI1 | 00191 |
| 178   |          | GO TO KRET                                                         | YAQUI1 | 00192 |
| 179   | 500      | IF (NPT.GT.0) CALL PARPLOT                                         | YAQUI1 | 00193 |
| 180   |          | IF (LPR.EQ.0) GO TO 490                                            | YAQUI1 | 00194 |
| 181   |          | IF (GROVEL.GT,EM10 .OR. NCYC.EQ.0) CALL ADV(1)                     | YAQUI1 | 00195 |
| 182   |          | DRMIN = DZMIN = 1.E+20                                             | YAQUI1 | 00196 |
| 183   |          | DRMAX = DZMAX = VMAX = 0.                                          | YAQUI1 | 00197 |
| 184   |          | CALL START                                                         | YAQUI1 | 00198 |
| 185   |          | DO 549 J=2,JP1                                                     | YAQUI1 | 00199 |
| 186   |          | DO 539 I=1,IRAR                                                    | YAQUI1 | 00200 |
| 187   |          | IPJ = IJ + NQ                                                      | YAQUI1 | 00201 |
| 188   |          | IPJP = IJP + NQ                                                    | YAQUI1 | 00202 |
| 189   |          | VMAX = AMAX1 (VMAX,ARS(U(IJ)),ARS(V(IJ)))                          | YAQUI1 | 00203 |
| 190   |          | IF (NCYC.GT.0 .AND. GROVEL.LT,EM10) GO TO 530                      | YAQUI1 | 00204 |
| 191   |          | X1 = X(IPJ)                                                        | YAQUI1 | 00205 |
| 192   |          | X2 = X(IPJP)                                                       | YAQUI1 | 00206 |
| 193   |          | X3 = X(IJPI)                                                       | YAQUI1 | 00207 |
| 194   |          | X4 = X(IJ)                                                         | YAQUI1 | 00208 |
| 195   |          | Y1 = Y(IPJ)                                                        | YAQUI1 | 00209 |
| 196   |          | Y2 = Y(IPJP)                                                       | YAQUI1 | 00210 |
| 197   |          | Y3 = Y(IJPI)                                                       | YAQUI1 | 00211 |
| 198   |          | Y4 = Y(IJ)                                                         | YAQUI1 | 00212 |
| 199   |          | XY14 = SQRT((X1-X4)**2 + (Y1-Y4)**2)                               | YAQUI1 | 00213 |
| 200   |          | XY23 = SQRT((X2-X3)**2 + (Y2-Y3)**2)                               | YAQUI1 | 00214 |

| INDEX | 01/12/73 | SUBROUTINE YAQUI2                               | PAGE 42      |
|-------|----------|-------------------------------------------------|--------------|
| 201   |          | DRMIN = AMIN1(DRMIN,XY14,XY23)                  | YAQUI1 00215 |
| 202   |          | DRMAX = AMAX1(DRMAX,XY14,XY23)                  | YAQUI1 00216 |
| 203   |          | XY21 = SQRT((X2-X1)**2 + (Y2-Y1)**2)            | YAQUI1 00217 |
| 204   |          | XY34 = SQRT((X3-X4)**2 + (Y3-Y4)**2)            | YAQUI1 00218 |
| 205   |          | DZMIN = AMIN1(DZMIN,XY21,XY34)                  | YAQUI1 00219 |
| 206   |          | DZMAX = AMAX1(DZMAX,XY21,XY34)                  | YAQUI1 00220 |
| 207   |          | IX1 = FIXL * (X1-XL)*XCONV                      | YAQUI1 00221 |
| 208   |          | IY1 = FIYR * (Y1-YB)*YCONV                      | YAQUI1 00222 |
| 209   |          | IX2 = FIXL * (X2-XL)*XCONV                      | YAQUI1 00223 |
| 210   |          | IY2 = FIYR * (Y2-YB)*YCONV                      | YAQUI1 00224 |
| 211   |          | IX3 = FIXL * (X3-XL)*XCONV                      | YAQUI1 00225 |
| 212   |          | IY3 = FIYR * (Y3-YB)*YCONV                      | YAQUI1 00226 |
| 213   |          | IX4 = FIXL * (X4-XL)*XCONV                      | YAQUI1 00227 |
| 214   |          | IY4 = FIYR * (Y4-YB)*YCONV                      | YAQUI1 00228 |
| 215   |          | IF (I.EQ.1) CALL DRV (IX3,IY3,IX4,IY4)          | YAQUI1 00229 |
| 216   |          | IF (J.EQ.2) CALL DRV (IX4,IY4,IX1,IY1)          | YAQUI1 00230 |
| 217   |          | CALL DRV (IX1,IY1,IX2,IY2)                      | YAQUI1 00231 |
| 218   |          | CALL DRV (IX2,IY2,IX3,IY3)                      | YAQUI1 00232 |
| 219   | 530      | IJ = IPJ                                        | YAQUI1 00233 |
| 220   | 539      | IJP = IPJP                                      | YAQUI1 00234 |
| 221   |          | CALL LOOP                                       | YAQUI1 00235 |
| 222   | 549      | CONTINUE                                        | YAQUI1 00236 |
| 223   |          | IF (NCYC.GT.0 .AND. GROVEL.LT.EM10) GO TO 550   | YAQUI1 00237 |
| 224   |          | CALL LINCNT(59)                                 | YAQUI1 00238 |
| 225   |          | WRITE(12,4140) DRMIN,DRMAX,DZMIN,DZMAX,XR,YR,YT | YAQUI1 00239 |
| 226   |          | WRITE(12,4080) JNM,NAME,T,NCYC                  | YAQUI1 00240 |
| 227   | 550      | IF (VMAX.LT.EM10) GO TO 600                     | YAQUI1 00241 |
| 228   |          | OROU = VV/VMAX                                  | YAQUI1 00242 |
| 229   |          | CALL ADV(1)                                     | YAQUI1 00243 |
| 230   |          | CALL START                                      | YAQUI1 00244 |
| 231   |          | DD 599 J=2,JP2                                  | YAQUI1 00245 |
| 232   |          | DD 589 I=1,IP1                                  | YAQUI1 00246 |
| 233   |          | IX1 = FIXL * (X(IJ)-XL)*XCONV                   | YAQUI1 00247 |
| 234   |          | IY1 = FIYR * (Y(IJ)-YB)*YCONV                   | YAQUI1 00248 |
| 235   |          | IX2 = FIXL * (X(IJ)+U(IJ)*OROU-XL)*XCONV        | YAQUI1 00249 |
| 236   |          | IY2 = FIYR * (Y(IJ)+V(IJ)*OROU-YB)*YCONV        | YAQUI1 00250 |
| 237   |          | IF (IY2.GE.1) GO TO 580                         | YAQUI1 00251 |
| 238   |          | IX2 = IX1 * (IX2-IX1)*(IY1-1)/(IY1-IY2)         | YAQUI1 00252 |
| 239   |          | IY2 = 1                                         | YAQUI1 00253 |
| 240   | 580      | CALL DRV (IX1,IY1,IX2,IY2)                      | YAQUI1 00254 |
| 241   |          | CALL PLY (IX1,IY1,16)                           | YAQUI1 00255 |
| 242   | 589      | IJ = IJ + NQ                                    | YAQUI1 00256 |
| 243   |          | CALL LOOP                                       | YAQUI1 00257 |
| 244   | 599      | CONTINUE                                        | YAQUI1 00258 |
| 245   |          | CALL LINCNT(59)                                 | YAQUI1 00259 |
| 246   |          | WRITE(12,4150) VMAX                             | YAQUI1 00260 |
| 247   |          | WRITE(12,4080) JNM,NAME,T,NCYC                  | YAQUI1 00261 |
| 248   | 600      | IF (IRAR.EQ.1 .OR. J8AR.EQ.1) GO TO 490         | YAQUI1 00262 |
| 249   |          | L = 0                                           | YAQUI1 00263 |
| 250   | 610      | L = L+1                                         | YAQUI1 00264 |
| 251   |          | GO TO (620,620,640,490)L                        | YAQUI1 00265 |
| 252   | 620      | CALL START                                      | YAQUI1 00266 |
| 253   |          | DD 639 J=7,JP1                                  | YAQUI1 00267 |
| 254   |          | DD 629 I=1,IRAR                                 | YAQUI1 00268 |
| 255   |          | CQ(IJ) = R0(IJ+L-1)                             | YAQUI1 00269 |
| 256   | 629      | IJ = IJ + NQ                                    | YAQUI1 00270 |
| 257   |          | CALL LOOP                                       | YAQUI1 00271 |
| 258   | 639      | CONTINUE                                        | YAQUI1 00272 |

| INDEX | 01/12/73 | SUBROUTINE YAQUI2                              | PAGE 43      |
|-------|----------|------------------------------------------------|--------------|
| 259   |          | CALL DONE                                      | YAQUI1 00273 |
| 260   |          | GO TO 700                                      | YAQUI1 00274 |
| 261   | 640      | CALL START                                     | YAQUI1 00275 |
| 262   |          | DO 659 J=2,JP1                                 | YAQUI1 00276 |
| 263   |          | DO 649 I=1,IBAR                                | YAQUI1 00277 |
| 264   |          | IPJ = IJ + NQ                                  | YAQUI1 00278 |
| 265   |          | IPJP = IJP + NQ                                | YAQUI1 00279 |
| 266   |          | X1 = X(IPJ)                                    | YAQUI1 00280 |
| 267   |          | Y1 = Y(IPJ)                                    | YAQUI1 00281 |
| 268   |          | U1 = U(IPJ)                                    | YAQUI1 00282 |
| 269   |          | V1 = V(IPJ)                                    | YAQUI1 00283 |
| 270   |          | X2 = X(IPJP)                                   | YAQUI1 00284 |
| 271   |          | Y2 = Y(IPJP)                                   | YAQUI1 00285 |
| 272   |          | U2 = U(IPJP)                                   | YAQUI1 00286 |
| 273   |          | V2 = V(IPJP)                                   | YAQUI1 00287 |
| 274   |          | X3 = X(IJP)                                    | YAQUI1 00288 |
| 275   |          | Y3 = Y(IJP)                                    | YAQUI1 00289 |
| 276   |          | U3 = U(IJP)                                    | YAQUI1 00290 |
| 277   |          | V3 = V(IJP)                                    | YAQUI1 00291 |
| 278   |          | X4 = X(IJ)                                     | YAQUI1 00292 |
| 279   |          | Y4 = Y(IJ)                                     | YAQUI1 00293 |
| 280   |          | U4 = U(IJ)                                     | YAQUI1 00294 |
| 281   |          | V4 = V(IJ)                                     | YAQUI1 00295 |
| 282   |          | R1 = .125*RVOL(IJ)*R(IPJ)+R(IPJP)+R(IJP)+R(IJ) | YAQUI1 00296 |
| 283   |          | CQ(IJ) = R1*((U1+U4)*(X1-X4)+(V1+V4)*(Y1-Y4)   | YAQUI1 00297 |
|       |          | 2 + (U2+U1)*(X2-X1)+(V2+V1)*(Y2-Y1)            | YAQUI1 00298 |
|       |          | 3 + (U3+U2)*(X3-X2)+(V3+V2)*(Y3-Y2)            | YAQUI1 00299 |
|       |          | 4 + (U4+U3)*(X4-X3)+(V4+V3)*(Y4-Y3)            | YAQUI1 00300 |
| 284   |          | IJ = IPJ                                       | YAQUI1 00301 |
| 285   | 649      | IJP = IPJP                                     | YAQUI1 00302 |
| 286   |          | CALL LOOP                                      | YAQUI1 00303 |
| 287   | 659      | CONTINUE                                       | YAQUI1 00304 |
| 288   |          | CALL DONE                                      | YAQUI1 00305 |
| 289   | 700      | QMN = 1.E+6                                    | YAQUI1 00306 |
| 290   |          | QMX = -QMN                                     | YAQUI1 00307 |
| 291   |          | CALL START                                     | YAQUI1 00308 |
| 292   |          | DO 719 J=2,JP1                                 | YAQUI1 00309 |
| 293   |          | DO 709 I=1,IBAR                                | YAQUI1 00310 |
| 294   |          | QMN = AMIN1(CQ(IJ),QMN)                        | YAQUI1 00311 |
| 295   |          | QMX = AMAX1(CQ(IJ),QMX)                        | YAQUI1 00312 |
| 296   | 709      | IJ = IJ + NQ                                   | YAQUI1 00313 |
| 297   |          | CALL LOOP                                      | YAQUI1 00314 |
| 298   | 719      | CONTINUE                                       | YAQUI1 00315 |
| 299   |          | XX = QMX/(QMN*EM10)                            | YAQUI1 00316 |
| 300   |          | IF (XX.LE.2.0) GO TO 735                       | YAQUI1 00317 |
| 301   |          | K = 10./ALOG10(XX)                             | YAQUI1 00318 |
| 302   |          | XX = K+1                                       | YAQUI1 00319 |
| 303   |          | D11 = I0.**+(1./XX)                            | YAQUI1 00320 |
| 304   |          | K = ALOG10(QMN)                                | YAQUI1 00321 |
| 305   |          | XX = 10.**+(K-1)                               | YAQUI1 00322 |
| 306   |          | K = 1                                          | YAQUI1 00323 |
| 307   | 720      | XX = XX*DQ                                     | YAQUI1 00324 |
| 308   |          | IF (XX.LT.QMN) GO TO 720                       | YAQUI1 00325 |
| 309   | 730      | CON(K) = XX                                    | YAQUI1 00326 |
| 310   |          | IF (XX.GT.QMX) GO TO 740                       | YAQUI1 00327 |
| 311   |          | K = K+1                                        | YAQUI1 00328 |
| 312   |          | XX = XX*DQ                                     | YAQUI1 00329 |
| 313   |          | GO TO 730                                      | YAQUI1 00330 |

| INDEX | 01/12/73 | SUBROUTINE YAQUI2                                         | PAGE   | 44    |
|-------|----------|-----------------------------------------------------------|--------|-------|
| 314   | 735      | XX = QMX-QMN                                              | YAQUI1 | 00331 |
| 315   |          | IF (ARS(XX).LT.1.E-3*AMAX1(ABS(QMX),ARS(QMN))) GO TO 610  | YAQUI1 | 00332 |
| 316   |          | QQ = .1*(XX+.001)                                         | YAQUI1 | 00333 |
| 317   |          | DO 739 K=1,11                                             | YAQUI1 | 00334 |
| 318   | 739      | CON(K) = QMN+(FLOAT(K-1))*QQ                              | YAQUI1 | 00335 |
| 319   |          | K = 11                                                    | YAQUI1 | 00336 |
| 320   | 740      | CALL ADV()                                                | YAQUI1 | 00337 |
| 321   |          | CALL LINCNT (59)                                          | YAQUI1 | 00338 |
| 322   |          | GO TO (750,760,770)L                                      | YAQUI1 | 00339 |
| 323   | 750      | WRITE(12,4090)                                            | YAQUI1 | 00340 |
| 324   |          | GO TO 780                                                 | YAQUI1 | 00341 |
| 325   | 760      | WRITE(12,4100)                                            | YAQUI1 | 00342 |
| 326   |          | GO TO 7A0                                                 | YAQUI1 | 00343 |
| 327   | 770      | WRITE(12,4110)                                            | YAQUI1 | 00344 |
| 328   | 7A0      | WRITE(12,4120) QMN,QMX,CON(1),CON(K-1),QQ                 | YAQUI1 | 00345 |
| 329   |          | WRITE(12,4080) JNM,NAME,T,NCYC                            | YAQUI1 | 00346 |
| 330   |          | CALL START                                                | YAQUI1 | 00347 |
| 331   |          | DO 899 J=2,JBAR                                           | YAQUI1 | 00348 |
| 332   |          | CALL LOOP                                                 | YAQUI1 | 00349 |
| 333   |          | DO 889 I=1,IM1                                            | YAQUI1 | 00350 |
| 334   |          | IPJ = IJ + NQ                                             | YAQUI1 | 00351 |
| 335   |          | IPJM = IJM + NQ                                           | YAQUI1 | 00352 |
| 336   |          | N = 0                                                     | YAQUI1 | 00353 |
| 337   |          | DO 879 KK=1,K                                             | YAQUI1 | 00354 |
| 338   |          | K1 = K2 = K3 = K4 = 0                                     | YAQUI1 | 00355 |
| 339   |          | IF (CO(IJM) .LE. CON(KK)) K1=1                            | YAQUI1 | 00356 |
| 340   |          | IF (CO(IPJM) .LE. CON(KK)) K2=1                           | YAQUI1 | 00357 |
| 341   |          | IF (CO(IJ) .LE. CON(KK)) K3=1                             | YAQUI1 | 00358 |
| 342   |          | IF (CO(IPJ) .LE. CON(KK)) K4=1                            | YAQUI1 | 00359 |
| 343   |          | IF (K1*K2*K3*K4 .NE. 0 .OR. KI*K2*K3*K4 .EQ. 0) GO TO 879 | YAQUI1 | 00360 |
| 344   |          | IF (N.GT.0) GO TO 800                                     | YAQUI1 | 00361 |
| 345   |          | IJR = IJM                                                 | YAQUI1 | 00362 |
| 346   |          | IJA = IJ                                                  | YAQUI1 | 00363 |
| 347   |          | DO 799 JJ=1,2                                             | YAQUI1 | 00364 |
| 348   |          | DO 789 II=1,2                                             | YAQUI1 | 00365 |
| 349   |          | IPJR = IJR+NQ                                             | YAQUI1 | 00366 |
| 350   |          | IPJA = IJA+NQ                                             | YAQUI1 | 00367 |
| 351   |          | N = N+1                                                   | YAQUI1 | 00368 |
| 352   |          | XCO(N) = .75*(X(IPJR)+X(IPJA)+X(IJA)+X(IJR))              | YAQUI1 | 00369 |
| 353   |          | YCO(N) = .25*(Y(IPJR)+Y(IPJA)+Y(IJA)+Y(IJR))              | YAQUI1 | 00370 |
| 354   |          | IJA = IPJA                                                | YAQUI1 | 00371 |
| 355   | 789      | IJR = IPJR                                                | YAQUI1 | 00372 |
| 356   |          | IJB = IJ                                                  | YAQUI1 | 00373 |
| 357   | 799      | IJA = IJP                                                 | YAQUI1 | 00374 |
| 358   | 800      | LL = 0                                                    | YAQUI1 | 00375 |
| 359   |          | IF (K1+K3.NE.1) GO TO 810                                 | YAQUI1 | 00376 |
| 360   |          | IC1 = 1                                                   | YAQUI1 | 00377 |
| 361   |          | IC2 = 3                                                   | YAQUI1 | 00378 |
| 362   |          | IJ1 = IJM                                                 | YAQUI1 | 00379 |
| 363   |          | IJ2 = IJ                                                  | YAQUI1 | 00380 |
| 364   |          | ASSIGN A10 TO KR1                                         | YAQUI1 | 00381 |
| 365   |          | GO TO A40                                                 | YAQUI1 | 00382 |
| 366   | 810      | IF (K1+K2.NE.1) GO TO 820                                 | YAQUI1 | 00383 |
| 367   |          | IC1 = 1                                                   | YAQUI1 | 00384 |
| 368   |          | IC2 = 2                                                   | YAQUI1 | 00385 |
| 369   |          | IJ1 = IJM                                                 | YAQUI1 | 00386 |
| 370   |          | IJ2 = IPJM                                                | YAQUI1 | 00387 |
| 371   |          | ASSIGN 820 TO KR1                                         | YAQUI1 | 00388 |

| INCEX | 01/12/73 | SUBROUTINE YAQUI2                                           | PAGE 45      |
|-------|----------|-------------------------------------------------------------|--------------|
| 372   |          | GO TO 840                                                   | YAQUI1 00389 |
| 373   | 820      | IF (K2+K4,NE.1) GO TO 830                                   | YAQUI1 00390 |
| 374   |          | IC1 = 2                                                     | YAQUI1 00391 |
| 375   |          | IC2 = 4                                                     | YAQUI1 00392 |
| 376   |          | IJ1 = IPJM                                                  | YAQUI1 00393 |
| 377   |          | IJ2 = TPJ                                                   | YAQUI1 00394 |
| 378   |          | ASSTGN 830 TO KRI                                           | YAQUI1 00395 |
| 379   |          | GO TO 840                                                   | YAQUI1 00396 |
| 380   | 830      | IF (K3+K4,NE.1) GO TO 879                                   | YAQUI1 00397 |
| 381   |          | IC1 = 3                                                     | YAQUI1 00398 |
| 382   |          | IC2 = 4                                                     | YAQUI1 00399 |
| 383   |          | IJ1 = IJ                                                    | YAQUI1 00400 |
| 384   |          | IJ2 = IPJ                                                   | YAQUI1 00401 |
| 385   |          | ASSTGN 879 TO KRI                                           | YAQUI1 00402 |
| 386   | 840      | LL = LL.1                                                   | YAQUI1 00403 |
| 387   |          | XX = (CON(KK)-CQ(IJ1))/(CQ(IJ2)-CQ(IJ1))                    | YAQUI1 00404 |
| 388   |          | IX1(LL) = FIXL + (XC0(IC1)+XX*(XC0(IC2)-XC0(IC1))-XL)*XCONV | YAQUI1 00405 |
| 389   |          | IY1(LL) = FIY8 + (YCO(IC1)+XX*(YCO(IC2)-YCO(IC1))-Y8)*YCONV | YAQUI1 00406 |
| 390   |          | IF (LL-LT.2) GO TO KRI                                      | YAQUI1 00407 |
| 391   |          | CALL DRV (IX1,IY1,IX2,IY2)                                  | YAQUI1 00408 |
| 392   |          | IF (KK,EQ.1) CALL PLT (IX1,IY1,35)                          | YAQUI1 00409 |
| 393   |          | IF (KK,EQ.K-1) CALL PLT (IX1,IY1,24)                        | YAQUI1 00410 |
| 394   |          | LL = 0                                                      | YAQUI1 00411 |
| 395   |          | IF (IJ2,EQ.IPJM) GO TO 820                                  | YAQUI1 00412 |
| 396   | 879      | CONTINUE                                                    | YAQUI1 00413 |
| 397   |          | IJM = IPJM                                                  | YAQUI1 00414 |
| 398   |          | IJ = TPJ                                                    | YAQUI1 00415 |
| 399   | 889      | IJP = IJP+NQ                                                | YAQUI1 00416 |
| 400   | 899      | CONTINUE                                                    | YAQUI1 00417 |
| 401   |          | CALL START                                                  | YAQUI1 00418 |
| 402   |          | DO 949 J=2,JP1                                              | YAQUI1 00419 |
| 403   |          | DO 939 I=1,IRAR                                             | YAQUI1 00420 |
| 404   |          | IPJ = IJ + NQ                                               | YAQUI1 00421 |
| 405   |          | IPJP = IJP + NQ                                             | YAQUI1 00422 |
| 406   |          | IX1 = FIXL + (X(IPJ) -XL)*XCONV                             | YAQUI1 00423 |
| 407   |          | IY1 = FIYR + (Y(IPJ) -Y8)*YCONV                             | YAQUI1 00424 |
| 408   |          | IX2 = FIXL + (X(IPJP)-XL)*XCONV                             | YAQUI1 00425 |
| 409   |          | IY2 = FIYR + (Y(IPJP)-Y8)*YCONV                             | YAQUI1 00426 |
| 410   |          | IX3 = FIXL + (X(IJP) -XL)*XCONV                             | YAQUI1 00427 |
| 411   |          | IY3 = FIY8 + (Y(IJP) -Y8)*YCONV                             | YAQUI1 00428 |
| 412   |          | IX4 = FIXL + (X(IJ) -XL)*XCONV                              | YAQUI1 00429 |
| 413   |          | IY4 = FIY8 + (Y(IJ) -Y8)*YCONV                              | YAQUI1 00430 |
| 414   |          | IF (I,EQ.1) CALL DRV (IX3,IY3,IX4,IY4)                      | YAQUI1 00431 |
| 415   |          | IF (J,EQ.2) CALL DRV (IX4,IY4,IX1,IY1)                      | YAQUI1 00432 |
| 416   |          | IF (I,EQ.1RAR) CALL DRV (IX1,IY1,IX2,IY2)                   | YAQUI1 00433 |
| 417   |          | IF (J,EQ.JP1) CALL DRV (IX2,IY2,IX3,IY3)                    | YAQUI1 00434 |
| 418   |          | IJ = IPJ                                                    | YAQUI1 00435 |
| 419   | 939      | IJP = IPJP                                                  | YAQUI1 00436 |
| 420   |          | CALL LOOP                                                   | YAQUI1 00437 |
| 421   | 949      | CONTINUE                                                    | YAQUI1 00438 |
| 422   |          | GO TO 610                                                   | YAQUI1 00439 |
| 423   | 1000     | CALL START                                                  | YAQUI1 00440 |
| 424   |          | Y1 = ANC*RT                                                 | YAQUI1 00441 |
| 425   |          | DO 1099 J=2,JP2                                             | YAQUI1 00442 |
| 426   |          | DO 1089 I=1,IP1                                             | YAQUI1 00443 |
| 427   |          | IMJ = IJ+NQ                                                 | YAQUI1 00444 |
| 428   |          | IPJ = IJ+NQ                                                 | YAQUI1 00445 |
| 429   |          | IPJP = IJP+NQ                                               | YAQUI1 00446 |



| INDEX | 01/12/73 | SUBROUTINE YAQUI2              | PAGE 46      |
|-------|----------|--------------------------------|--------------|
| 430   |          | XX = YY = 1.                   | YAQUI1 00447 |
| 431   |          | X1 = U1 = V1 = 0.              | YAQUI1 00448 |
| 432   |          | IF (I.EQ.1 ) GO TO 1015        | YAQUI1 00449 |
| 433   |          | U1 = U(IMJ)                    | YAQUI1 00450 |
| 434   |          | V1 = V(IMJ)                    | YAQUI1 00451 |
| 435   |          | GO TO 1020                     | YAQUI1 00452 |
| 436   | 1015     | X1 = 1.0                       | YAQUI1 00453 |
| 437   |          | XX = 0.0                       | YAQUI1 00454 |
| 438   | 1020     | IF (J.EQ.2 ) GO TO 1025        | YAQUI1 00455 |
| 439   |          | U1 = U1+U(IJM)                 | YAQUI1 00456 |
| 440   |          | V1 = V1+V(IJM)                 | YAQUI1 00457 |
| 441   |          | GO TO 1030                     | YAQUI1 00458 |
| 442   | 1025     | X1 = X1+1.0                    | YAQUI1 00459 |
| 443   |          | YY = 0.0                       | YAQUI1 00460 |
| 444   | 1030     | IF (I.EQ.IP1) GO TO 1035       | YAQUI1 00461 |
| 445   |          | UT = U1+U(IPJ)                 | YAQUI1 00462 |
| 446   |          | V1 = V1+V(IPJ)                 | YAQUI1 00463 |
| 447   |          | GO TO 1040                     | YAQUI1 00464 |
| 448   | 1035     | X1 = X1 + 1.0                  | YAQUI1 00465 |
| 449   |          | XX = 0.0                       | YAQUI1 00466 |
| 450   | 1040     | IF (J.EQ.JP2) GO TO 1045       | YAQUI1 00467 |
| 451   |          | U1 = U1+U(IJP)                 | YAQUI1 00468 |
| 452   |          | V1 = V1+V(IJP)                 | YAQUI1 00469 |
| 453   |          | GO TO 1050                     | YAQUI1 00470 |
| 454   | 1045     | X1 = X1+1.0                    | YAQUI1 00471 |
| 455   |          | YY = 0.0                       | YAQUI1 00472 |
| 456   | 1050     | X1 = 1./(4.-X1)                | YAQUI1 00473 |
| 457   |          | AX = GR *Y1*(U1*X1-U(IJ))      | YAQUI1 00474 |
| 458   |          | AY = GZ *Y1*(V1*X1-V(IJ))      | YAQUI1 00475 |
| 459   |          | UTIL(IJ) = (U(IJ)+DT*AX)*XX    | YAQUI1 00476 |
| 460   |          | VTIL(IJ) = (V(IJ)+DT*AY)*YY    | YAQUI1 00477 |
| 461   |          | Q(IJ) = DT*(AX*U(IJ)+AY*V(IJ)) | YAQUI1 00478 |
| 462   |          | IJ = IPJ                       | YAQUI1 00479 |
| 463   |          | IJP = IPJP                     | YAQUI1 00480 |
| 464   | 1089     | TJM = IJM+NQ                   | YAQUI1 00481 |
| 465   |          | CALL LOOP                      | YAQUI1 00482 |
| 466   | 1099     | CONTINUE                       | YAQUI1 00483 |
| 467   |          | CALL DONE                      | YAQUI1 00484 |
| 468   | 1100     | CALL START                     | YAQUI1 00485 |
| 469   |          | DO 1299 J=2,JP1                | YAQUI1 00486 |
| 470   |          | DO 1199 I=1,IRAR               | YAQUI1 00487 |
| 471   |          | IPJ = IJ + NQ                  | YAQUI1 00488 |
| 472   |          | IPJP = IJP + NQ                | YAQUI1 00489 |
| 473   |          | X1 = X(IPJ)                    | YAQUI1 00490 |
| 474   |          | Y1 = Y(IPJ)                    | YAQUI1 00491 |
| 475   |          | R1 = R(IPJ)                    | YAQUI1 00492 |
| 476   |          | U1 = U(IPJ)                    | YAQUI1 00493 |
| 477   |          | V1 = V(IPJ)                    | YAQUI1 00494 |
| 478   |          | X2 = X(IPJP)                   | YAQUI1 00495 |
| 479   |          | Y2 = Y(IPJP)                   | YAQUI1 00496 |
| 480   |          | R2 = R(IPJP)                   | YAQUI1 00497 |
| 481   |          | U2 = U(IPJP)                   | YAQUI1 00498 |
| 482   |          | V2 = V(IPJP)                   | YAQUI1 00499 |
| 483   |          | X3 = X(IJP)                    | YAQUI1 00500 |
| 484   |          | Y3 = Y(IJP)                    | YAQUI1 00501 |
| 485   |          | R3 = R(IJP)                    | YAQUI1 00502 |
| 486   |          | U3 = U(IJP)                    | YAQUI1 00503 |
| 487   |          | V3 = V(IJP)                    | YAQUI1 00504 |

| INDEX | 01/12/73 | SUBROUTINE YAQUI2                                                                                              | PAGE 47                                      |
|-------|----------|----------------------------------------------------------------------------------------------------------------|----------------------------------------------|
| 488   |          | X4 = X(IJ)                                                                                                     | YAQUI1 00505                                 |
| 489   |          | Y4 = Y(IJ)                                                                                                     | YAQUI1 00506                                 |
| 490   |          | R4 = R(IJ)                                                                                                     | YAQUI1 00507                                 |
| 491   |          | U4 = U(IJ)                                                                                                     | YAQUI1 00508                                 |
| 492   |          | V4 = V(IJ)                                                                                                     | YAQUI1 00509                                 |
| 493   |          | X12 = X1-X2                                                                                                    | YAQUI1 00510                                 |
| 494   |          | X23 = X2-X3                                                                                                    | YAQUI1 00511                                 |
| 495   |          | X34 = X3-X4                                                                                                    | YAQUI1 00512                                 |
| 496   |          | X41 = X4-X1                                                                                                    | YAQUI1 00513                                 |
| 497   |          | X24 = X2-X4                                                                                                    | YAQUI1 00514                                 |
| 498   |          | X31 = X3-X1                                                                                                    | YAQUI1 00515                                 |
| 499   |          | Y21 = Y2-Y1                                                                                                    | YAQUI1 00516                                 |
| 500   |          | Y32 = Y3-Y2                                                                                                    | YAQUI1 00517                                 |
| 501   |          | Y43 = Y4-Y3                                                                                                    | YAQUI1 00518                                 |
| 502   |          | Y14 = Y1-Y4                                                                                                    | YAQUI1 00519                                 |
| 503   |          | Y24 = Y2-Y4                                                                                                    | YAQUI1 00520                                 |
| 504   |          | Y31 = Y3-Y1                                                                                                    | YAQUI1 00521                                 |
| 505   |          | R12 = R1+R2                                                                                                    | YAQUI1 00522                                 |
| 506   |          | R23 = R2+R3                                                                                                    | YAQUI1 00523                                 |
| 507   |          | R34 = R3+R4                                                                                                    | YAQUI1 00524                                 |
| 508   |          | R41 = R4+R1                                                                                                    | YAQUI1 00525                                 |
| 509   |          | HR13 = .5*(R1+R3)                                                                                              | YAQUI1 00526                                 |
| 510   |          | HR24 = .5*(R2+R4)                                                                                              | YAQUI1 00527                                 |
| 511   |          | U12 = U1+U2                                                                                                    | YAQUI1 00528                                 |
| 512   |          | U23 = U2+U3                                                                                                    | YAQUI1 00529                                 |
| 513   |          | U34 = U3+U4                                                                                                    | YAQUI1 00530                                 |
| 514   |          | U41 = U4+U1                                                                                                    | YAQUI1 00531                                 |
| 515   |          | U24 = U2+U4                                                                                                    | YAQUI1 00532                                 |
| 516   |          | U13 = U1+U3                                                                                                    | YAQUI1 00533                                 |
| 517   |          | V12 = V1+V2                                                                                                    | YAQUI1 00534                                 |
| 518   |          | V23 = V2+V3                                                                                                    | YAQUI1 00535                                 |
| 519   |          | V34 = V3+V4                                                                                                    | YAQUI1 00536                                 |
| 520   |          | V41 = V4+V1                                                                                                    | YAQUI1 00537                                 |
| 521   |          | V24 = V2+V4                                                                                                    | YAQUI1 00538                                 |
| 522   |          | V13 = V1+V3                                                                                                    | YAQUI1 00539                                 |
| 523   |          | DT02M1 = DT02*RM(I PJ)                                                                                         | YAQUI1 00540                                 |
| 524   |          | DT02M2 = DT02*RM(I PJP)                                                                                        | YAQUI1 00541                                 |
| 525   |          | DT02M3 = DT02*RM(I PJP)                                                                                        | YAQUI1 00542                                 |
| 526   |          | DT02M4 = DT02*RM(I J)                                                                                          | YAQUI1 00543                                 |
| 527   |          | XY = X24+Y31+X31*Y24                                                                                           | YAQUI1 00544                                 |
| 528   |          | D = .25*RVOL(IJ)*(R12*(U12*Y21+V12*X12)+R23*(U23*Y32+V23*X23)<br>+R34*(U34*Y43+V34*X34)+R41*(U41*Y14+V41*X41)) | YAQUI1 00545                                 |
| 529   |          | 1<br>XX = .5*(X2-X4+X1-X3)                                                                                     | YAQUI1 00546                                 |
| 530   |          | YY = .5*(Y2-Y4+Y3-Y1)                                                                                          | YAQUI1 00547                                 |
| 531   |          | IF (KXI.LT.0) GO TO 1130                                                                                       | YAQUI1 00548                                 |
| 532   |          | AK = R0(IJ)*KXI                                                                                                | YAQUI1 00549                                 |
| 533   |          | GO TO 1140                                                                                                     | YAQUI1 00550                                 |
| 534   | 1130     | VELIJ = U4**2 + V4**2                                                                                          | YAQUI1 00551                                 |
| 535   |          | VELMX = 0.7 * AMAX1(ABS(U4*XX),ABS(V4*YY))                                                                     | YAQUI1 00552                                 |
| 536   |          | AK = R0(IJ)*COLAMU*(DT02*VELIJ + VELMX)                                                                        | YAQUI1 00553                                 |
| 537   | 1140     | LAM0 = AMIN1(0,0.) *AK*LAM                                                                                     | YAQUI1 00554                                 |
| 538   |          | M102 = .5*AK*MU                                                                                                | YAQUI1 00555                                 |
| 539   |          | M104 = .5*MU02                                                                                                 | YAQUI1 00556                                 |
| 540   |          | XX = XX*XX                                                                                                     | YAQUI1 00557                                 |
| 541   |          | YY = YY*YY                                                                                                     | YAQUI1 00558                                 |
| 542   |          | IF (KXI.LT.0 .AND. DT.LT.DTPOS)                                                                                | YAQUI1 00559                                 |
| 543   |          | 1<br>AK = R0(IJ)*COLAMU*(.5*DTPOS*VELIJ + VELMX)<br>D0 = R0(IJ)*OMANC*XX*YY/(2.* AK*(LAM+2.*MU) *(XX+YY)+EM10) | YAQUI1 00560<br>YAQUI1 00561<br>YAQUI1 00562 |

| INDEX | 01/12/73 | SUBROUTINE YAQUI2                                              | PAGE   | 48    |
|-------|----------|----------------------------------------------------------------|--------|-------|
| 544   |          | DTV = AMINI(DTV,.5*00)                                         | YAQUI1 | 00563 |
| 545   |          | IF (DTVSAV.NE.DTV) JDTV = I                                    | YAQUI1 | 00564 |
| 546   |          | IF (DTVSAV.NE.DTV) JDTV = J                                    | YAQUI1 | 00565 |
| 547   |          | DTVSAV = DTV                                                   | YAQUI1 | 00566 |
| 548   |          | PIXX = MU02*RVOL(IJ)*(R12*U12*V21+R23*U23*V32                  | YAQUI1 | 00567 |
|       |          | +R34*U34*V43+R41*U41*V14-.5*CYL*(U12+U34)*XY) + LAMD           | YAQUI1 | 00568 |
| 549   |          | PIYY = MU02*RVOL(IJ)*(R12*V12*X12+R23*V23*X23                  | YAQUI1 | 00569 |
|       |          | +R34*V34*X34+R41*V41*X41) + LAMD                               | YAQUI1 | 00570 |
| 550   |          | PIXY = MU04*RVOL(IJ)*(R12*(U12*V12*Y21)+R23*(U23*V23*Y32)      | YAQUI1 | 00571 |
|       |          | +R34*(U34*V34*Y43)+R41*(U41*V41*Y14)                           | YAQUI1 | 00572 |
|       |          | -.5*CYL*(V12+V34)*XY)                                          | YAQUI1 | 00573 |
| 551   |          | PTTH = .25*XY*CYL*(MU04*RVOL(IJ)*(U12+U34)*XY) + LAMD)         | YAQUI1 | 00574 |
| 552   |          | XX = HR24*(PIXY*X24-PIXX*Y24)                                  | YAQUI1 | 00575 |
| 553   |          | YY = Y24*P(IJ)                                                 | YAQUI1 | 00576 |
| 554   |          | UTTL(IPJ) = UTIL(IPJ) +DT02M1*(XX+R1*YY-PTTH)                  | YAQUI1 | 00577 |
| 555   |          | UTIL(IJP) = UTIL(IJP) -DT02M3*(XX+R3*YY+PTTH)                  | YAQUI1 | 00578 |
| 556   |          | XX = HR13*(PIXY*X31-PIXX*Y31)                                  | YAQUI1 | 00579 |
| 557   |          | YY = Y31*P(IJ)                                                 | YAQUI1 | 00580 |
| 558   |          | UTIL(IPJP) = UTIL(IPJP)+DT02M2*(XX+R2*YY-PTTH)                 | YAQUI1 | 00581 |
| 559   |          | UTIL(IJ) = UTIL(IJ) -DT02M4*(XX+R4*YY+PTTH)                    | YAQUI1 | 00582 |
| 560   |          | PYYMP = PIYY-P(IJ)                                             | YAQUI1 | 00583 |
| 561   |          | XX = HR24*(PYYMP*X24-PIXY*Y24)                                 | YAQUI1 | 00584 |
| 562   |          | VTIL(IPJ) = VTIL(IPJ) +DT02M1*XX                               | YAQUI1 | 00585 |
| 563   |          | VTIL(IJP) = VTIL(IJP) -DT02M3*XX                               | YAQUI1 | 00586 |
| 564   |          | XX = HR13*(PYYMP*X31-PIXY*Y31)                                 | YAQUI1 | 00587 |
| 565   |          | VTIL(IPJP) = VTIL(IPJP)+DT02M2*XX                              | YAQUI1 | 00588 |
| 566   |          | VTIL(IJ) = VTIL(IJ) -DT02M4*XX                                 | YAQUI1 | 00589 |
| 567   |          | XX = .5*HR24*(U24*(X24*PIXY-Y24*PIXX)-V24*(Y24*PIXY-X24*PIYY)) | YAQUI1 | 00590 |
| 568   |          | Q(IPJ) = Q(IPJ) +DT02M1*XX                                     | YAQUI1 | 00591 |
| 569   |          | Q(IJP) = Q(IJP) -DT02M3*XX                                     | YAQUI1 | 00592 |
| 570   |          | XX = .5*HR13*(U13*(X31*PIXY-Y31*PIXX)-V13*(Y31*PIXY-X31*PIYY)) | YAQUI1 | 00593 |
| 571   |          | Q(IPJP) = Q(IPJP)+DT02M2*XX                                    | YAQUI1 | 00594 |
| 572   |          | Q(IJ) = Q(IJ) -DT02M4*XX                                       | YAQUI1 | 00595 |
| 573   |          | IJ = TPJ                                                       | YAQUI1 | 00596 |
| 574   | 1199     | IJP = IPJP                                                     | YAQUI1 | 00597 |
| 575   |          | UTIL(IJ) = UTIL(IJP) = UTIL(IJP-NQIR) = UTIL(IJ-NQIB) = 0,     | YAQUI1 | 00598 |
| 576   |          | IF (J.NE.2) GO TO 1220                                         | YAQUI1 | 00599 |
| 577   |          | DO 1210 IJ=ISC2,ISC2,NQ                                        | YAQUI1 | 00600 |
| 578   | 1210     | VTIL(IJ) = 0.                                                  | YAQUI1 | 00601 |
| 579   | 1220     | IF (J.NE.JP1) GO TO 1240                                       | YAQUI1 | 00602 |
| 580   |          | DO 1230 IJP=IJP5,LJP2,NQ                                       | YAQUI1 | 00603 |
| 581   | 1230     | VTIL(IJP) = 0.                                                 | YAQUI1 | 00604 |
| 582   | 1240     | CALL LOOP                                                      | YAQUI1 | 00605 |
| 583   | 1299     | CONTINUE                                                       | YAQUI1 | 00606 |
| 584   |          | CALL DONE                                                      | YAQUI1 | 00607 |
| 585   | 1300     | CALL START                                                     | YAQUI1 | 00608 |
| 586   |          | DO 1399 J=2,JP1                                                | YAQUI1 | 00609 |
| 587   |          | DO 1389 I=1,IBAR                                               | YAQUI1 | 00610 |
| 588   |          | IPJ = IJ + NQ                                                  | YAQUI1 | 00611 |
| 589   |          | IPJP = IJP + NQ                                                | YAQUI1 | 00612 |
| 590   |          | ETIL(IJ) = E(IJ)+.25*(Q(IPJ)+Q(IPJP)+Q(IJP)+Q(IJ))             | YAQUI1 | 00613 |
| 591   |          | ROL(IJ) = R0(IJ)                                               | YAQUI1 | 00614 |
| 592   |          | RCSQ(IJ) = 1./(ASQ+GGM1*AMAX1(SIE(IJ),0.))                     | YAQUI1 | 00615 |
| 593   |          | XX = (X(IPJP)-X(IJ)+X(IPJ)-X(IJP))*2                           | YAQUI1 | 00616 |
| 594   |          | YY = (Y(IPJP)-Y(IJ)+Y(IJP)-Y(IPJ))*2                           | YAQUI1 | 00617 |
| 595   |          | DELSM(IJ) = DTR*(XX+YY)/(XX*YY)                                | YAQUI1 | 00618 |
| 596   |          | IJ = IPJ                                                       | YAQUI1 | 00619 |
| 597   | 1389     | IJP = IPJP                                                     | YAQUI1 | 00620 |

| INDEX | 01/12/73 | SUBROUTINE YAQUI2                        | PAGE 49      |
|-------|----------|------------------------------------------|--------------|
| 598   |          | CALL LOOP                                | YAQUII 00621 |
| 599   | 1399     | CONTINUE                                 | YAQUII 00622 |
| 600   |          | CALL DONE                                | YAQUII 00623 |
| 601   | 1500     | CALL START                               | YAQUII 00624 |
| 602   |          | DO 1599 J=2,JP1                          | YAQUII 00625 |
| 603   |          | DO 15A9 I=1,IRAR                         | YAQUII 00626 |
| 604   |          | IMJ = IJ+NQ                              | YAQUII 00627 |
| 605   |          | IPJ = IJ+NQ                              | YAQUII 00628 |
| 606   |          | IPJP = IJP+NQ                            | YAQUII 00629 |
| 607   |          | X1 = X(IPJ)                              | YAQUII 00630 |
| 608   |          | Y1 = Y(IPJ)                              | YAQUII 00631 |
| 609   |          | R1 = R(IPJ)                              | YAQUII 00632 |
| 610   |          | X2 = X(IPJP)                             | YAQUII 00633 |
| 611   |          | Y2 = Y(IPJP)                             | YAQUII 00634 |
| 612   |          | R2 = R(IPJP)                             | YAQUII 00635 |
| 613   |          | X3 = X(IJP)                              | YAQUII 00636 |
| 614   |          | Y3 = Y(IJP)                              | YAQUII 00637 |
| 615   |          | R3 = R(IJP)                              | YAQUII 00638 |
| 616   |          | X4 = X(IJ)                               | YAQUII 00639 |
| 617   |          | Y4 = Y(IJ)                               | YAQUII 00640 |
| 618   |          | R4 = R(IJ)                               | YAQUII 00641 |
| 619   |          | X12 = X1-X2                              | YAQUII 00642 |
| 620   |          | X23 = X2-X3                              | YAQUII 00643 |
| 621   |          | X34 = X3-X4                              | YAQUII 00644 |
| 622   |          | X41 = X4-X1                              | YAQUII 00645 |
| 623   |          | Y21 = Y2-Y1                              | YAQUII 00646 |
| 624   |          | Y32 = Y3-Y2                              | YAQUII 00647 |
| 625   |          | Y43 = Y4-Y3                              | YAQUII 00648 |
| 626   |          | Y14 = Y1-Y4                              | YAQUII 00649 |
| 627   |          | R12 = R1-R2                              | YAQUII 00650 |
| 628   |          | R23 = R2-R3                              | YAQUII 00651 |
| 629   |          | R34 = R3-R4                              | YAQUII 00652 |
| 630   |          | R41 = R4-R1                              | YAQUII 00653 |
| 631   |          | U1 = UTIL(IPJ)                           | YAQUII 00654 |
| 632   |          | U2 = UTIL(IPJP)                          | YAQUII 00655 |
| 633   |          | U3 = UTIL(IJP)                           | YAQUII 00656 |
| 634   |          | U4 = UTIL(IJ)                            | YAQUII 00657 |
| 635   |          | V1 = VTIL(IPJ)                           | YAQUII 00658 |
| 636   |          | V2 = VTIL(IPJP)                          | YAQUII 00659 |
| 637   |          | V3 = VTIL(IJP)                           | YAQUII 00660 |
| 638   |          | V4 = VTIL(IJ)                            | YAQUII 00661 |
| 639   |          | U12 = U1-U2                              | YAQUII 00662 |
| 640   |          | U23 = U2-U3                              | YAQUII 00663 |
| 641   |          | U34 = U3-U4                              | YAQUII 00664 |
| 642   |          | U41 = U4-U1                              | YAQUII 00665 |
| 643   |          | V12 = V1-V2                              | YAQUII 00666 |
| 644   |          | V23 = V2-V3                              | YAQUII 00667 |
| 645   |          | V34 = V3-V4                              | YAQUII 00668 |
| 646   |          | V41 = V4-V1                              | YAQUII 00669 |
| 647   |          | MR = ML = MT = MB = MC = RO(IJ)/RVOL(IJ) | YAQUII 00670 |
| 648   |          | PR = PLE = PT = PB = PC = P(IJ)          | YAQUII 00671 |
| 649   |          | IF (I.EQ.IBAR) GO TO 1510                | YAQUII 00672 |
| 650   |          | MR = RO(IPJ)/RVOL(IPJ)                   | YAQUII 00673 |
| 651   |          | PP = P(IPJ)                              | YAQUII 00674 |
| 652   | 1510     | IF (I.FQ.1 ) GO TO 1520                  | YAQUII 00675 |
| 653   |          | ML = RO(IMJ)/RVOL(IMJ)                   | YAQUII 00676 |
| 654   |          | PLE = P(IMJ)                             | YAQUII 00677 |
| 655   | 1520     | IF (J.FQ.JP1 ) GO TO 1530                | YAQUII 00678 |

| INDEX | 01/12/73 | SUBROUTINE YAQUI2                                           | PAGE 50      |
|-------|----------|-------------------------------------------------------------|--------------|
| 656   |          | MT = R0(IJP)/RVOL(IJP)                                      | YAQUI1 00679 |
| 657   |          | PT = P(IJP)                                                 | YAQUI1 00680 |
| 658   | 1530     | IF (J, EQ, 2 ) GO TO 1540                                   | YAQUI1 00681 |
| 659   |          | MR = R0(IJM)/RVOL(IJM)                                      | YAQUI1 00682 |
| 660   |          | PR = P(IJM)                                                 | YAQUI1 00683 |
| 661   | 1540     | P12 = (MR*PC+MC*PR)/(MR+MC)                                 | YAQUI1 00684 |
| 662   |          | P23 = (MT*PC+MC*PT)/(MT+MC)                                 | YAQUI1 00685 |
| 663   |          | P34 = (ML*PC+MC*PL)/(ML+MC)                                 | YAQUI1 00686 |
| 664   |          | P41 = (MB*PC+MC*PR)/(MB+MC)                                 | YAQUI1 00687 |
| 665   |          | ETIL(IJ) = ETIL(IJ)-DT04/MC*(R12*P12*(U12*Y21+V12*X12)      | YAQUI1 00688 |
|       | 1        | +R23*P23*(U23*Y32+V23*X23)                                  | YAQUI1 00689 |
|       | 2        | +R34*P34*(U34*Y43+V34*X34)                                  | YAQUI1 00690 |
|       | 3        | +R41*P41*(U41*Y14+V41*X41))                                 | YAQUI1 00691 |
| 666   |          | IJ = IPJ                                                    | YAQUI1 00692 |
| 667   |          | IJP = IPJP                                                  | YAQUI1 00693 |
| 668   | 1589     | IJM = IJM+NQ                                                | YAQUI1 00694 |
| 669   |          | CALL LOOP                                                   | YAQUI1 00695 |
| 670   | 1599     | CONTINUE                                                    | YAQUI1 00696 |
| 671   |          | CALL NONE                                                   | YAQUI1 00697 |
| 672   | 2000     | MUSTIT = 0                                                  | YAQUI1 00698 |
| 673   |          | MUSTIT = 1                                                  | YAQUI1 00699 |
| 674   |          | PTMAX = EM10                                                | YAQUI1 00700 |
| 675   | 2010     | CALL START                                                  | YAQUI1 00701 |
| 676   |          | DO 2099 J=2,JP1                                             | YAQUI1 00702 |
| 677   |          | DO 20R9 I=1,IBAR                                            | YAQUI1 00703 |
| 678   |          | IPJ = IJ + NQ                                               | YAQUI1 00704 |
| 679   |          | IPJP = IJP + NQ                                             | YAQUI1 00705 |
| 680   |          | X1 = X(IPJ)                                                 | YAQUI1 00706 |
| 681   |          | Y1 = Y(IPJ)                                                 | YAQUI1 00707 |
| 682   |          | R1 = R(IPJ)                                                 | YAQUI1 00708 |
| 683   |          | U1 = U(IPJ)                                                 | YAQUI1 00709 |
| 684   |          | V1 = V(IPJ)                                                 | YAQUI1 00710 |
| 685   |          | X2 = X(IPJP)                                                | YAQUI1 00711 |
| 686   |          | Y2 = Y(IPJP)                                                | YAQUI1 00712 |
| 687   |          | R2 = R(IPJP)                                                | YAQUI1 00713 |
| 688   |          | U2 = U(IPJP)                                                | YAQUI1 00714 |
| 689   |          | V2 = V(IPJP)                                                | YAQUI1 00715 |
| 690   |          | X3 = X(IJP)                                                 | YAQUI1 00716 |
| 691   |          | Y3 = Y(IJP)                                                 | YAQUI1 00717 |
| 692   |          | R3 = R(IJP)                                                 | YAQUI1 00718 |
| 693   |          | U3 = U(IJP)                                                 | YAQUI1 00719 |
| 694   |          | V3 = V(IJP)                                                 | YAQUI1 00720 |
| 695   |          | X4 = X(IJ)                                                  | YAQUI1 00721 |
| 696   |          | Y4 = Y(IJ)                                                  | YAQUI1 00722 |
| 697   |          | R4 = R(IJ)                                                  | YAQUI1 00723 |
| 698   |          | U4 = U(IJ)                                                  | YAQUI1 00724 |
| 699   |          | V4 = V(IJ)                                                  | YAQUI1 00725 |
| 700   |          | D = .25*RVOL(IJ)*((R1+R2)*((U1+U2)*(Y2-Y1)+(V1+V2)*(X1-X2)) | YAQUI1 00726 |
|       | 1        | + (R2+R3)*((U2+U3)*(Y3-Y2)-(V2+V3)*(X2-X3))                 | YAQUI1 00727 |
|       | 2        | + (R3+R4)*((U3+U4)*(Y4-Y3)-(V3+V4)*(X3-X4))                 | YAQUI1 00728 |
|       | 3        | + (R4+R1)*((U4+U1)*(Y1-Y4)+(V4+V1)*(X4-X1)))                | YAQUI1 00729 |
| 701   |          | S = ROT*(ROL(IJ)-R0(IJ))*ROL(IJ)*D                          | YAQUI1 00730 |
| 702   |          | RA = RCSQ(IJ)*(ROT*D)+DELSM(IJ)                             | YAQUI1 00731 |
| 703   |          | DP = -0M*S/RA                                               | YAQUI1 00732 |
| 704   |          | ROL(IJ) = ROL(IJ) + RCSQ(IJ)*DP                             | YAQUI1 00733 |
| 705   |          | PLMAX = AMAX1(PLMAX, ABS(PL(IJ)))                           | YAQUI1 00734 |
| 706   |          | IF (ABS(DP).LE.EPS*PLMAX) GO TO 2080                        | YAQUI1 00735 |
| 707   |          | MUSTIT = 1                                                  | YAQUI1 00736 |

| INØEX | 01/12/73 | SUBROUTINE YAQUI2                                  | PAGE   | 51    |
|-------|----------|----------------------------------------------------|--------|-------|
| 708   |          | PL(IJ) = PL(IJ)+DP                                 | YAQUI1 | 00737 |
| 709   |          | Y24 = Y2-Y4                                        | YAQUI1 | 00738 |
| 710   |          | Y31 = Y3-Y1                                        | YAQUI1 | 00739 |
| 711   |          | XR13 = .5*(R1+R3)*(X1-X3)                          | YAQUI1 | 00740 |
| 712   |          | XR24 = .5*(R2+R4)*(X2-X4)                          | YAQUI1 | 00741 |
| 713   |          | XX = DT02*DP                                       | YAQUI1 | 00742 |
| 714   |          | DT02M1 = XX*RM(IPJ)                                | YAQUI1 | 00743 |
| 715   |          | DT02M2 = XX*RM(IPJP)                               | YAQUI1 | 00744 |
| 716   |          | DT02M3 = XX*RM(IJJP)                               | YAQUI1 | 00745 |
| 717   |          | DT02M4 = XX*RM(IJ)                                 | YAQUI1 | 00746 |
| 718   |          | UL(IPJ) = U1+DT02M1*R1+Y24                         | YAQUI1 | 00747 |
| 719   |          | UL(IPJP) = U2+DT02M2*R2+Y31                        | YAQUI1 | 00748 |
| 720   |          | UL(IJJP) = U3+DT02M3*R3+Y24                        | YAQUI1 | 00749 |
| 721   |          | UL(IJ) = U4+DT02M4*R4+Y31                          | YAQUI1 | 00750 |
| 722   |          | IF (J.EQ.2) GO TO 2060                             | YAQUI1 | 00751 |
| 723   |          | VL(IPJ) = V1-DT02M1*XR24                           | YAQUI1 | 00752 |
| 724   |          | VL(IJ) = V4-DT02M4*XR13                            | YAQUI1 | 00753 |
| 725   | 2060     | IF (J.EQ.JP1) GO TO 2080                           | YAQUI1 | 00754 |
| 726   |          | VL(IPJP) = V2+DT02M2*XR13                          | YAQUI1 | 00755 |
| 727   |          | VL(IJJP) = V3+DT02M3*XR24                          | YAQUI1 | 00756 |
| 728   | 2080     | IJ = IPJ                                           | YAQUI1 | 00757 |
| 729   | 2089     | IJP = IPJP                                         | YAQUI1 | 00758 |
| 730   |          | UL(IJ) = UL(IJP) = UL(IJP-NQIR) = UL(IJ-NQTB) = 0, | YAQUI1 | 00759 |
| 731   |          | CALL LOOP                                          | YAQUI1 | 00760 |
| 732   | 2099     | CONTINUE                                           | YAQUI1 | 00761 |
| 733   |          | CALL NONE                                          | YAQUI1 | 00762 |
| 734   |          | NUMIT = NUMIT+1                                    | YAQUI1 | 00763 |
| 735   |          | IF (MUSTIT.EQ.0) GO TO 3000                        | YAQUI1 | 00764 |
| 736   |          | MUSTIT = 0                                         | YAQUI1 | 00765 |
| 737   |          | IF (NUMIT.LT.500) GO TO 2010                       | YAQUI1 | 00766 |
| 738   |          | LPR = 2                                            | YAQUI1 | 00767 |
| 739   |          | PRINT 4130                                         | YAQUI1 | 00768 |
| 740   | 3000     | IF (GRDVEL.GT.1.99) GO TO 3150                     | YAQUI1 | 00769 |
| 741   |          | CALL START                                         | YAQUI1 | 00770 |
| 742   |          | DN 3019 J=2,JP2                                    | YAQUI1 | 00771 |
| 743   |          | DN 3009 I=1,IP1                                    | YAQUI1 | 00772 |
| 744   |          | UG(IJ) = UL(IJ)*GRDVEL                             | YAQUI1 | 00773 |
| 745   |          | VG(IJ) = VL(IJ)*GRDVEL                             | YAQUI1 | 00774 |
| 746   | 3009     | IJ = IJ + NQ                                       | YAQUI1 | 00775 |
| 747   |          | CALL LOOP                                          | YAQUI1 | 00776 |
| 748   | 3019     | CONTINUE                                           | YAQUI1 | 00777 |
| 749   |          | CALL NONE                                          | YAQUI1 | 00778 |
| 750   | 3100     | CALL START                                         | YAQUI1 | 00779 |
| 751   |          | DN 3119 J=2,JP2                                    | YAQUI1 | 00780 |
| 752   |          | DN 3109 I=1,IP1                                    | YAQUI1 | 00781 |
| 753   |          | X(IJ) = X(IJ)+UG(IJ)*DT                            | YAQUI1 | 00782 |
| 754   |          | Y(IJ) = Y(IJ)+VG(IJ)*DT                            | YAQUI1 | 00783 |
| 755   |          | R(IJ) = X(IJ)*CYL+DMCYL                            | YAQUI1 | 00784 |
| 756   | 3109     | IJ = IJ + NQ                                       | YAQUI1 | 00785 |
| 757   |          | CALL LOOP                                          | YAQUI1 | 00786 |
| 758   | 3119     | CONTINUE                                           | YAQUI1 | 00787 |
| 759   |          | CALL NONE                                          | YAQUI1 | 00788 |
| 760   |          | GO TO 3200                                         | YAQUI1 | 00789 |
| 761   | 3150     | CALL REZONE                                        | YAQUI1 | 00790 |
| 762   | 3200     | CALL START                                         | YAQUI1 | 00791 |
| 763   |          | DN 3269 J=2,JP1                                    | YAQUI1 | 00792 |
| 764   |          | DN 3259 I=1,IBAR                                   | YAQUI1 | 00793 |
| 765   |          | TMJ = IJ-NQ                                        | YAQUI1 | 00794 |

| INDEX | 01/12/73 | SUBROUTINE YAQUI2                                                                                              | PAGE   | 52    |
|-------|----------|----------------------------------------------------------------------------------------------------------------|--------|-------|
| 766   |          | IPJ = IJ+NQ                                                                                                    | YAQUI1 | 00795 |
| 767   |          | IPJP = IJP+NQ                                                                                                  | YAQUI1 | 00796 |
| 768   |          | X1 = X(IPJ)                                                                                                    | YAQUI1 | 00797 |
| 769   |          | Y1 = Y(IPJ)                                                                                                    | YAQUI1 | 00798 |
| 770   |          | R1 = R(IPJ)                                                                                                    | YAQUI1 | 00799 |
| 771   |          | X2 = X(IPJP)                                                                                                   | YAQUI1 | 00800 |
| 772   |          | Y2 = Y(IPJP)                                                                                                   | YAQUI1 | 00801 |
| 773   |          | R2 = R(IPJP)                                                                                                   | YAQUI1 | 00802 |
| 774   |          | X3 = X(IJP)                                                                                                    | YAQUI1 | 00803 |
| 775   |          | Y3 = Y(IJP)                                                                                                    | YAQUI1 | 00804 |
| 776   |          | R3 = R(IJP)                                                                                                    | YAQUI1 | 00805 |
| 777   |          | X4 = X(IJ)                                                                                                     | YAQUI1 | 00806 |
| 778   |          | Y4 = Y(IJ)                                                                                                     | YAQUI1 | 00807 |
| 779   |          | R4 = R(IJ)                                                                                                     | YAQUI1 | 00808 |
| 780   |          | UL1 = UL(IPJ)                                                                                                  | YAQUI1 | 00809 |
| 781   |          | VL1 = VL(IPJ)                                                                                                  | YAQUI1 | 00810 |
| 782   |          | UL2 = UL(IPJP)                                                                                                 | YAQUI1 | 00811 |
| 783   |          | VL2 = VL(IPJP)                                                                                                 | YAQUI1 | 00812 |
| 784   |          | UL3 = UL(IJP)                                                                                                  | YAQUI1 | 00813 |
| 785   |          | VL3 = VL(IJP)                                                                                                  | YAQUI1 | 00814 |
| 786   |          | UL4 = UL(IJ)                                                                                                   | YAQUI1 | 00815 |
| 787   |          | VL4 = VL(IJ)                                                                                                   | YAQUI1 | 00816 |
| 788   |          | UN1 = UG(IPJ) - UL1                                                                                            | YAQUI1 | 00817 |
| 789   |          | VN1 = VG(IPJ) - VL1                                                                                            | YAQUI1 | 00818 |
| 790   |          | UN2 = UG(IPJP) - UL2                                                                                           | YAQUI1 | 00819 |
| 791   |          | VN2 = VG(IPJP) - VL2                                                                                           | YAQUI1 | 00820 |
| 792   |          | UN3 = UG(IJP) - UL3                                                                                            | YAQUI1 | 00821 |
| 793   |          | VN3 = VG(IJP) - VL3                                                                                            | YAQUI1 | 00822 |
| 794   |          | UN4 = UG(IJ) - UL4                                                                                             | YAQUI1 | 00823 |
| 795   |          | VN4 = VG(IJ) - VL4                                                                                             | YAQUI1 | 00824 |
| 796   |          | X12 = X1-X2                                                                                                    | YAQUI1 | 00825 |
| 797   |          | X23 = X2-X3                                                                                                    | YAQUI1 | 00826 |
| 798   |          | X34 = X3-X4                                                                                                    | YAQUI1 | 00827 |
| 799   |          | X41 = X4-X1                                                                                                    | YAQUI1 | 00828 |
| 800   |          | Y21 = Y2-Y1                                                                                                    | YAQUI1 | 00829 |
| 801   |          | Y32 = Y3-Y2                                                                                                    | YAQUI1 | 00830 |
| 802   |          | Y43 = Y4-Y3                                                                                                    | YAQUI1 | 00831 |
| 803   |          | Y14 = Y1-Y4                                                                                                    | YAQUI1 | 00832 |
| 804   |          | Y31 = Y3-Y1                                                                                                    | YAQUI1 | 00833 |
| 805   |          | R12 = R1-R2                                                                                                    | YAQUI1 | 00834 |
| 806   |          | R23 = R2-R3                                                                                                    | YAQUI1 | 00835 |
| 807   |          | R34 = R3-R4                                                                                                    | YAQUI1 | 00836 |
| 808   |          | R41 = R4-R1                                                                                                    | YAQUI1 | 00837 |
| 809   |          | U12 = UL1-UL2                                                                                                  | YAQUI1 | 00838 |
| 810   |          | U23 = UL2-UL3                                                                                                  | YAQUI1 | 00839 |
| 811   |          | U14 = UL3-UL4                                                                                                  | YAQUI1 | 00840 |
| 812   |          | U41 = UL4-UL1                                                                                                  | YAQUI1 | 00841 |
| 813   |          | V12 = VL1-VL2                                                                                                  | YAQUI1 | 00842 |
| 814   |          | V23 = VL2-VL3                                                                                                  | YAQUI1 | 00843 |
| 815   |          | V34 = VL3-VL4                                                                                                  | YAQUI1 | 00844 |
| 816   |          | V41 = VL4-VL1                                                                                                  | YAQUI1 | 00845 |
| 817   |          | D = .25*RVOL(IJ)*(R12*(U12*Y21+V12*X12)+R23*(U23*Y32+V23*X23)<br>+R34*(U34*Y43+V34*X34)+R41*(U41*Y14+V41*X41)) | YAQUI1 | 00846 |
| 818   |          | VOLR = VOLT = VOLC = 1./RVOL(IJ)                                                                               | YAQUI1 | 00847 |
| 819   |          | IF (I.NE.IBAR) VOLR = 1./RVOL(IPJ)                                                                             | YAQUI1 | 00848 |
| 820   |          | IF (J.NE.JP1) VOLR = 1./RVOL(IJP)                                                                              | YAQUI1 | 00849 |
| 821   |          | IF (I.EQ.1) GO TO 3280                                                                                         | YAQUI1 | 00850 |
| 822   |          | FL = -FR                                                                                                       | YAQUI1 | 00851 |

| INDEX | 01/12/73 | SUBROUTINE YAQUIZ                                            | PAGE   | 53    |
|-------|----------|--------------------------------------------------------------|--------|-------|
| 823   |          | AL = -AR                                                     | YAQUI1 | 00853 |
| 824   | 3230     | IF (J.EQ.2) GO TO 3290                                       | YAQUI1 | 00854 |
| 825   |          | FB = -FT(I)                                                  | YAQUI1 | 00855 |
| 826   |          | AR = -AT(I)                                                  | YAQUI1 | 00856 |
| 827   | 3240     | FR = DT08*R12*(UD1+UD2)*Y21+(VD1+VD2)*X12)                   | YAQUI1 | 00857 |
| 828   |          | AR = A0M*SIGN(1.,FR) +R0*4,*FR / (V0LR+VOLC)                 | YAQUI1 | 00858 |
| 829   |          | FT(I) = DT08*R23*(UD2+UD3)*Y32+(VD2+VD3)*X23)                | YAQUI1 | 00859 |
| 830   |          | AT(I) = A0M*STGN(1.,FT(I))+R0*4,*FT(I)/(V0LT+VOLC1           | YAQUI1 | 00860 |
| 831   |          | XX = AMAX1(ABS(FB),ABS(FR),ABS(FT(I)),ABS(FL))               | YAQUI1 | 00861 |
| 832   |          | DTC = AMIN1(DTC,DTP0S*A0FAC/(XX*RVOL(IJ))+DTP0S*ABS(D)+EM10) | YAQUI1 | 00862 |
| 833   |          | IF (DTC SAV,NE,DTC) DTC = I                                  | YAQUI1 | 00863 |
| 834   |          | IF (DTC SAV,NE,DTC) DTC = J                                  | YAQUI1 | 00864 |
| 835   |          | DTC SAV = DTC                                                | YAQUI1 | 00865 |
| 836   |          | MP(IJ) = RO(IJ)*V0LC                                         | YAQUI1 | 00866 |
|       |          | 1 *FR *({1.-AR) *ROL(TJ)*(1.+AR) *ROL(IPJ))                  | YAQUI1 | 00867 |
|       |          | 2 *FT(I)*({1.-AT(I)) *ROL(IJ)*(1.+AT(I)) *ROL(IJP))          | YAQUI1 | 00868 |
|       |          | 3 *FL *({1.-AL) *ROL(IJ)*(1.+AL) *ROL(IMJ))                  | YAQUI1 | 00869 |
|       |          | 4 *FR *({1.-AR) *ROL(TJ)*(1.+AB) *ROL(IJM))                  | YAQUI1 | 00870 |
| 837   |          | ROE = RO(IJ)*ETIL(IJ)                                        | YAQUI1 | 00871 |
| 838   |          | EP(IJ) = 1./MP(IJ)*ROE*VOLC                                  | YAQUI1 | 00872 |
|       |          | 1 *FR *({1.-AR) *ROE+(1.+AR) *RO(IPJ)*ETTL(IPJ))             | YAQUI1 | 00873 |
|       |          | 2 *FT(I)*({1.-AT(I)) *ROE+(1.+AT(I)) *RO(IJP)*ETIL(IJP))     | YAQUI1 | 00874 |
|       |          | 3 *FL *({1.-AL) *ROE+(1.+AL) *RO(IMJ)*ETIL(IMJ))             | YAQUI1 | 00875 |
|       |          | 4 *FR *({1.-AB) *ROE+(1.+AB) *RO(IJM)*ETIL(IJM))             | YAQUI1 | 00876 |
| R39   |          | ATR = .5*(X2*Y31-X1*Y32-X3*Y21)                              | YAQUI1 | 00877 |
| 840   |          | ARL = -.5*(X1*Y43+X3*Y14+X4*Y31)                             | YAQUI1 | 00878 |
| 841   |          | RVOL(IJ) = 3./(ATR*(R1+R2+R3)+ARL*(R1+R3+R4))                | YAQUI1 | 00879 |
| 842   |          | IJ = TPJ                                                     | YAQUI1 | 00880 |
| 843   |          | IJP = IPJP                                                   | YAQUI1 | 00881 |
| 844   | 3259     | IJM = IJM + NQ                                               | YAQUI1 | 00882 |
| 845   |          | CALL LDON                                                    | YAQUI1 | 00883 |
| 846   | 3269     | CONTINUE                                                     | YAQUI1 | 00884 |
| 847   |          | CALL DONE                                                    | YAQUI1 | 00885 |
| 848   |          | GO TO 3300                                                   | YAQUI1 | 00886 |
| 849   | 3280     | FL = DT08*R34*(UD3+UD4)*Y43+(VD3+VD4)*X34)                   | YAQUI1 | 00887 |
| 850   |          | AL = A0M*SIGN(1.,FL)+R0*2.*FL*RVOL(IJ)                       | YAQUI1 | 00888 |
| 851   |          | GO TO 3230                                                   | YAQUI1 | 00889 |
| 852   | 3290     | FR = DT08*R41*(UD4+UD1)*Y14+(VD4+VD1)*Y411                   | YAQUI1 | 00890 |
| 853   |          | AB = A0M*SIGN(1.,FR)+R0*2.*FR*RVOL(IJ)                       | YAQUI1 | 00891 |
| 854   |          | GO TO 3240                                                   | YAQUI1 | 00892 |
| 855   | 3300     | CALL START                                                   | YAQUI1 | 00893 |
| 856   |          | DO 3319 J=2,JP1                                              | YAQUI1 | 00894 |
| 857   |          | DO 3309 I=1,IBAR                                             | YAQUI1 | 00895 |
| 858   |          | RO(IJ) = MP(IJ)*RVOL(IJ)                                     | YAQUI1 | 00896 |
| 859   |          | E(IJ) = EP(IJ)                                               | YAQUI1 | 00897 |
| 860   |          | IF (J.EQ.2) RO(IJM) = ROL(IJM)                               | YAQUI1 | 00898 |
| 861   |          | IF (J.EQ.JP1) RO(IJP) = ROL(IJP)                             | YAQUI1 | 00899 |
| 862   |          | IF (I.EQ.IBAR) RO(IJ+NQ) = ROL(IJ+NQ)                        | YAQUI1 | 00900 |
| 863   |          | IJM = IJM+NQ                                                 | YAQUI1 | 00901 |
| 864   |          | IJP = IJP+NQ                                                 | YAQUI1 | 00902 |
| 865   | 3309     | IJ = IJ + NQ                                                 | YAQUI1 | 00903 |
| 866   |          | CALL LOOP                                                    | YAQUI1 | 00904 |
| 867   | 3319     | CONTINUE                                                     | YAQUI1 | 00905 |
| 868   |          | CALL DONE                                                    | YAQUI1 | 00906 |
| 869   |          | CALL STARTD                                                  | YAQUI1 | 00907 |
| 870   |          | DO 3309 JJ=2,JP2                                             | YAQUI1 | 00908 |
| 871   |          | J = JP4-JJ                                                   | YAQUI1 | 00909 |
| 872   |          | DO 3309 II=1,IP1                                             | YAQUI1 | 00910 |



| INDEX | 01/12/73 | SUBROUTINE YAQUI2                           | PAGE   | 54    |
|-------|----------|---------------------------------------------|--------|-------|
| 873   |          | I = IP2-II                                  | YAQUI1 | 00911 |
| 874   |          | IMJ = IJ-NQ                                 | YAQUI1 | 00912 |
| 875   |          | IMJM = IJM-NQ                               | YAQUI1 | 00913 |
| 876   |          | XX = 0.                                     | YAQUI1 | 00914 |
| 877   |          | IF !I.NE.IP1 .AND. J.NE.2 I XX = MPIIJM1    | YAQUI1 | 00915 |
| 878   |          | IF !I.NE.IP1 .AND. J.NE.JP21 XX = XX+MPIIJ1 | YAQUI1 | 00916 |
| 879   |          | IF !I.NE.1 .AND. J.NE.JP21 XX = XX+MPIIMJ1  | YAQUI1 | 00917 |
| 880   |          | IF !I.NE.1 .AND. J.NE.2 I XX = XX+MPIIMJM1  | YAQUI1 | 00918 |
| 881   |          | RMPIIJ1 = 4./XX                             | YAQUI1 | 00919 |
| 882   |          | IJ = IMJ                                    | YAQUI1 | 00920 |
| 883   | 3389     | IJM = IMJM                                  | YAQUI1 | 00921 |
| 884   |          | CALL LOOPO                                  | YAQUI1 | 00922 |
| 885   | 3399     | CONTINUE                                    | YAQUI1 | 00923 |
| 886   | 3400     | CALL START                                  | YAQUI1 | 00924 |
| 887   |          | DO 3499 J=2,JP2                             | YAQUI1 | 00925 |
| 888   |          | DO 3489 I=1,IP1                             | YAQUI1 | 00926 |
| 889   |          | XX = RMP1IJ1/RM1IJ1                         | YAQUI1 | 00927 |
| 890   |          | UP1IJ1 = XX*UL1IJ1                          | YAQUI1 | 00928 |
| 891   |          | VP1IJ1 = XX*VL1IJ1                          | YAQUI1 | 00929 |
| 892   | 3489     | IJ = IJ + NQ                                | YAQUI1 | 00930 |
| 893   |          | CALL LOOP                                   | YAQUI1 | 00931 |
| 894   | 3499     | CONTINUE                                    | YAQUI1 | 00932 |
| 895   |          | CALL NONE                                   | YAQUI1 | 00933 |
| 896   |          | CALL START                                  | YAQUI1 | 00934 |
| 897   |          | DO 3699 J=2,JP1                             | YAQUI1 | 00935 |
| 898   |          | DO 3599 I=1,IPAR                            | YAQUI1 | 00936 |
| 899   |          | IPJ = IJ+NQ                                 | YAQUI1 | 00937 |
| 900   |          | IPJP = IPJ+NQ                               | YAQUI1 | 00938 |
| 901   |          | X1 = X1IPJ1                                 | YAQUI1 | 00939 |
| 902   |          | Y1 = Y1IPJ1                                 | YAQUI1 | 00940 |
| 903   |          | R1 = R1IPJ1                                 | YAQUI1 | 00941 |
| 904   |          | UL1 = UL1IPJ1                               | YAQUI1 | 00942 |
| 905   |          | UG1 = UG1IPJ1                               | YAQUI1 | 00943 |
| 906   |          | VL1 = VL1IPJ1                               | YAQUI1 | 00944 |
| 907   |          | VG1 = VG1IPJ1                               | YAQUI1 | 00945 |
| 908   |          | X2 = X1IPJP1                                | YAQUI1 | 00946 |
| 909   |          | Y2 = Y1IPJP1                                | YAQUI1 | 00947 |
| 910   |          | R2 = R1IPJP1                                | YAQUI1 | 00948 |
| 911   |          | UL2 = UL1IPJP1                              | YAQUI1 | 00949 |
| 912   |          | UG2 = UG1IPJP1                              | YAQUI1 | 00950 |
| 913   |          | VL2 = VL1IPJP1                              | YAQUI1 | 00951 |
| 914   |          | VG2 = VG1IPJP1                              | YAQUI1 | 00952 |
| 915   |          | X3 = X1IJP1                                 | YAQUI1 | 00953 |
| 916   |          | Y3 = Y1IJP1                                 | YAQUI1 | 00954 |
| 917   |          | R3 = R1IJP1                                 | YAQUI1 | 00955 |
| 918   |          | UL3 = UL1IJP1                               | YAQUI1 | 00956 |
| 919   |          | UG3 = UG1IJP1                               | YAQUI1 | 00957 |
| 920   |          | VL3 = VL1IJP1                               | YAQUI1 | 00958 |
| 921   |          | VG3 = VG1IJP1                               | YAQUI1 | 00959 |
| 922   |          | X4 = X1IJ1                                  | YAQUI1 | 00960 |
| 923   |          | Y4 = Y1IJ1                                  | YAQUI1 | 00961 |
| 924   |          | R4 = R1IJ1                                  | YAQUI1 | 00962 |
| 925   |          | UL4 = UL1IJ1                                | YAQUI1 | 00963 |
| 926   |          | UG4 = UG1IJ1                                | YAQUI1 | 00964 |
| 927   |          | VL4 = VL1IJ1                                | YAQUI1 | 00965 |
| 928   |          | VG4 = VG1IJ1                                | YAQUI1 | 00966 |
| 929   |          | XX = NTO16*ROL1IJ1                          | YAQUI1 | 00967 |
| 930   |          | U113 = UL1+UL3                              | YAQUI1 | 00968 |

| INDEX | 01/12/73 | SUBROUTINE YAQUI2                                                                                          | PAGE   | 55    |
|-------|----------|------------------------------------------------------------------------------------------------------------|--------|-------|
| 931   |          | VL13 = VL1+VL3                                                                                             | YAQUI1 | 00969 |
| 932   |          | UL24 = UL2+UL4                                                                                             | YAQUI1 | 00970 |
| 933   |          | VL24 = VL2+VL4                                                                                             | YAQUI1 | 00971 |
| 934   |          | F13 = XX*(R1+R3)*{(UG1+UG3-UL13)*(Y3-r1)+(VG1+VG3-VL13)*(X1-X3)}                                           | YAQUI1 | 00972 |
| 935   |          | F24 = XX*(R2+R4)*{(UG2+UG4-UL24)*(Y2-Y4)+(VG2+VG4-VL24)*(X4-X2)}                                           | YAQUI1 | 00973 |
| 936   |          | FM1 = F24*RMP(IPJ)                                                                                         | YAQUI1 | 00974 |
| 937   |          | FM2 = F13*RMP(IPJP)                                                                                        | YAQUI1 | 00975 |
| 938   |          | FM3 = F24*RMP(IJ)                                                                                          | YAQUI1 | 00976 |
| 939   |          | FM4 = F13*RMP(IJ)                                                                                          | YAQUI1 | 00977 |
| 940   |          | XX = R0*4.*RVOL(IJ)/RQL(IJ)                                                                                | YAQUI1 | 00978 |
| 941   |          | AL13 = A0*SIGN(1.,F13)+XX*F13                                                                              | YAQUI1 | 00979 |
| 942   |          | AL24 = A0*SIGN(1.,F24)+XX*F24                                                                              | YAQUI1 | 00980 |
| 943   |          | OPAL13 = 1.+AL13                                                                                           | YAQUI1 | 00981 |
| 944   |          | OPAL24 = 1.+AL24                                                                                           | YAQUI1 | 00982 |
| 945   |          | OMAL13 = 1.-AL13                                                                                           | YAQUI1 | 00983 |
| 946   |          | OMAL24 = 1.-AL24                                                                                           | YAQUI1 | 00984 |
| 947   |          | XX = UL3*OMAL24+UL1*OPAL24                                                                                 | YAQUI1 | 00985 |
| 948   |          | UP(IPJ) = UP(IPJ) - FM1*XX                                                                                 | YAQUI1 | 00986 |
| 949   |          | UP(IJP) = UP(IJP) + FM3*XX                                                                                 | YAQUI1 | 00987 |
| 950   |          | XX = VL4*OMAL13+VL2*OPAL13                                                                                 | YAQUI1 | 00988 |
| 951   |          | UP(IPJP) = UP(IPJP) - FM2*XX                                                                               | YAQUI1 | 00989 |
| 952   |          | UP(IJ) = UP(IJ) + FM4*XX                                                                                   | YAQUI1 | 00990 |
| 953   |          | XX = VL3*OMAL24+VL1*OPAL24                                                                                 | YAQUI1 | 00991 |
| 954   |          | VP(IPJ) = VP(IPJ) - FM1*XX                                                                                 | YAQUI1 | 00992 |
| 955   |          | VP(IJP) = VP(IJP) + FM3*XX                                                                                 | YAQUI1 | 00993 |
| 956   |          | XX = VL4*OMAL13+VL2*OPAL13                                                                                 | YAQUI1 | 00994 |
| 957   |          | VP(IPJP) = VP(IPJP) - FM2*XX                                                                               | YAQUI1 | 00995 |
| 958   |          | VP(IJ) = VP(IJ) + FM4*XX                                                                                   | YAQUI1 | 00996 |
| 959   |          | IJ = IPJ                                                                                                   | YAQUI1 | 00997 |
| 960   | 3599     | IJP = IPJP                                                                                                 | YAQUI1 | 00998 |
| 961   |          | UP(IJ) = UP(IJP) = UP(IJP-NQIB) = UP(IJ-NQIB) = 0.                                                         | YAQUI1 | 00999 |
| 962   |          | IF (J.NE.2) GO TO 3620                                                                                     | YAQUI1 | 01000 |
| 963   |          | DO 3610 IJ=ISC2,ISCF2,NQ                                                                                   | YAQUI1 | 01001 |
| 964   | 3610     | VP(IJ) = 0.                                                                                                | YAQUI1 | 01002 |
| 965   | 3620     | IF (J.NE.JP1) GO TO 3640                                                                                   | YAQUI1 | 01003 |
| 966   |          | DO 3630 IJP=JPS,LJP2,NQ                                                                                    | YAQUI1 | 01004 |
| 967   | 3630     | VP(IJP) = 0.                                                                                               | YAQUI1 | 01005 |
| 968   | 3640     | CALL LOOP                                                                                                  | YAQUI1 | 01006 |
| 969   | 3699     | CONTINUE                                                                                                   | YAQUI1 | 01007 |
| 970   |          | CALL NONE                                                                                                  | YAQUI1 | 01008 |
| 971   | 3700     | CALL START                                                                                                 | YAQUI1 | 01009 |
| 972   |          | DO 3719 J=2,JP2                                                                                            | YAQUI1 | 01010 |
| 973   |          | DO 3709 I=1,IP1                                                                                            | YAQUI1 | 01011 |
| 974   |          | U(IJ) = UP(IJ)                                                                                             | YAQUI1 | 01012 |
| 975   |          | V(IJ) = VP(IJ)                                                                                             | YAQUI1 | 01013 |
| 976   |          | RM(IJ) = RMP(IJ)                                                                                           | YAQUI1 | 01014 |
| 977   | 3709     | IJ = IJ + NQ                                                                                               | YAQUI1 | 01015 |
| 978   |          | CALL LOOP                                                                                                  | YAQUI1 | 01016 |
| 979   | 3719     | CONTINUE                                                                                                   | YAQUI1 | 01017 |
| 980   |          | CALL NONE                                                                                                  | YAQUI1 | 01018 |
| 981   | 3800     | CALL START                                                                                                 | YAQUI1 | 01019 |
| 982   |          | DO 3899 J=2,JP1                                                                                            | YAQUI1 | 01020 |
| 983   |          | DO 3889 I=1,IBAR                                                                                           | YAQUI1 | 01021 |
| 984   |          | IPJ = IJ+NQ                                                                                                | YAQUI1 | 01022 |
| 985   |          | IPJP = IJP+NQ                                                                                              | YAQUI1 | 01023 |
| 986   |          | SIE(IJ) = E(IJ)-.I25*(U(IPJ)**2+U(IPJP)**2+U(IJP)**2+U(IJ)**2<br>+V(IPJ)**2+V(IPJP)**2+V(IJP)**2+V(IJ)**2) | YAQUI1 | 01024 |
| 987   |          | IJP = IPJP                                                                                                 | YAQUI1 | 01025 |
|       |          |                                                                                                            | YAQUI1 | 01026 |

| INDEX | 01/12/73 | SUBROUTINE YAQUI2                                                                                                                                                         | PAGE   | 56    |
|-------|----------|---------------------------------------------------------------------------------------------------------------------------------------------------------------------------|--------|-------|
| 988   | 3889     | IJ = IPJ                                                                                                                                                                  | YAQUI1 | 01027 |
| 989   |          | CALL LOOP                                                                                                                                                                 | YAQUI1 | 01028 |
| 990   | 3899     | CONTINUE                                                                                                                                                                  | YAQUI1 | 01029 |
| 991   |          | CALL DONE                                                                                                                                                                 | YAQUI1 | 01030 |
| 992   |          | IF (NPT.GT.0) CALL PARTMOV                                                                                                                                                | YAQUI1 | 01031 |
| 993   |          | GO TO I00                                                                                                                                                                 | YAQUI1 | 01032 |
|       |          | C                                                                                                                                                                         | YAQUI1 | 01033 |
| 994   | 4000     | FORMAT(* T=*1PE12.5* CYC=*I5* DT=*E12.5* GRINDS=*E12.5* CIRC=*<br>1 E12.5* OTV=*E12.5* IDTV,JDTV=*I3*,*I3/54X*ITERS=*I4* CP=*<br>1 E12.5* DTC=*E12.5* IDTC,JDTC=*I3*,*I3) | YAQUI1 | 01034 |
| 995   | 4010     | FORMAT(*0 TAPE DUMP*I3* AT T=*1PE12.5* CYCLE*I5)                                                                                                                          | YAQUI1 | 01035 |
| 996   | 4020     | FORMAT(*0 RESTARTING FROM TD*I3)                                                                                                                                          | YAQUI1 | 01036 |
| 997   | 4030     | FORMAT(3X,10A8* T=*1PE12.5* CYCLE=*I5)                                                                                                                                    | YAQUI1 | 01037 |
| 998   | 4040     | FORMAT(*0 WRDNG TAPE = WRONG DUMP,*)                                                                                                                                      | YAQUI1 | 01038 |
| 999   | 4050     | FORMAT(1H1)                                                                                                                                                               | YAQUI1 | 01039 |
| 1000  | 4060     | FORMAT(* I J*7X*X*11X*Y*11X*U*11X*V*10X*SIE*9X*RH0*9X*VOL*10X<br>1 *D*11X*M*11X*P*)                                                                                       | YAQUI1 | 01040 |
| 1001  | 4070     | FORMAT(1X,I3*,*I3,10(1X,1PE11.4))                                                                                                                                         | YAQUI1 | 01041 |
| 1002  | 4080     | FORMAT(5X,A10,10A8* T=*1PE12.5* CYCLE=*I5)                                                                                                                                | YAQUI1 | 01042 |
| 1003  | 4090     | FORMAT(* ISOPYCNICS*)                                                                                                                                                     | YAQUI1 | 01043 |
| 1004  | 4100     | FORMAT(* ISOTHERMS*)                                                                                                                                                      | YAQUI1 | 01044 |
| 1005  | 4110     | FORMAT(* VORTICITY*)                                                                                                                                                      | YAQUI1 | 01045 |
| 1006  | 4120     | FORMAT(12X* MIN=*1PE12.5* MAX=*E12.5* L=*E12.5* H=*E12.5* DQ=*<br>1 F12.5)                                                                                                | YAQUI1 | 01046 |
| 1007  | 4130     | FORMAT(*0 ITERATION LIMIT EXCEEDED - RUN MAY ABORT.*)                                                                                                                     | YAQUI1 | 01047 |
| 1008  | 4140     | FORMAT(* ZONES*/* ORMIN=*1PE12.5* ORMAX=*E12.5* DZMIN=*E12.5<br>1 * OZMAX=*E12.5* XR=*E12.5* YR=*E12.5* YT=*E12.5)                                                        | YAQUI1 | 01048 |
| 1009  | 4150     | FORMAT(* VELOCITY VECTORS*/18X*VMAX=*1PE12.5)                                                                                                                             | YAQUI1 | 01049 |
| 1010  |          | END                                                                                                                                                                       | YAQUI1 | 01050 |

INDEX 01/12/73  
SINGLY REFERENCED VARIABLES

SUBROUTINE YAQUI2

PAGE 57

|             |       |        |      |       |      |     |        |        |       |         |        |       |        |       |       |        |    |       |
|-------------|-------|--------|------|-------|------|-----|--------|--------|-------|---------|--------|-------|--------|-------|-------|--------|----|-------|
| 200 - 40*   | FIPYB | -R     | 4C0  | IPXL  | -I   | 4C0 | JCEN   | -I     | 4C0   | PARPLOT | -      | 179SU | REWIND | -     | 92F   | RPDZ   | -R | 4C0   |
| 1100 - 468* | FIPYT | -R     | 4C0  | IPXR  | -I   | 4C0 | JM10   | -I     | 4C0   | PARTMOV | -      | 992SU | REZONE | -     | 761SU | STARTD | -  | 869SU |
| 1300 - 585* | FIXR  | -R     | 4C0  | IPY8  | -I   | 4C0 | JM14   | -I     | 4C0   | PDR     | -R     | 4C0   | REZRON | -R    | 4C0   | THIRD  | -R | 4C0   |
| 1500 - 601* | FIYT  | -R     | 4C0  | IPYT  | -I   | 4C0 | JPA02  | -I     | 4C0   | PDZ     | -R     | 4C0   | REZSIE | -R    | 4C0   | YAQUI2 | -  | 1SU   |
| 2000 - 672* | FJBP  | -R     | 4C0  | ISCFI | -I   | 4C0 | JUNF   | -I     | 4C0   | PXCONV  | -R     | 4C0   | REZUE  | -R    | 4C0   | YLC1   | -  | 2CN   |
| 3100 - 750* | FREZ  | -R     | 4C0  | ISC3  | -I   | 4C0 | JUNF02 | -I     | 4C0   | PXL     | -R     | 4C0   | REZVE  | -R    | 4C0   | YLC2   | -  | 2CN   |
| 3400 - 886* | H4020 | -      | 14SU | ITV   | -I   | 4C0 | LCM    | -      | 2F    | PXR     | -R     | 4C0   | REZVT  | -R    | 4C0   | YSC1   | -  | 3CN   |
| 3700 - 971* | IRP   | -I     | 4C0  | IUNF  | -I   | 4C0 | LOOPD  | -      | 884SU | PXRP    | -R     | 4C0   | REZY0  | -R    | 4C0   | YSC2   | -  | 4CN   |
| 3800 - 981* | IRP1  | -I     | 4C0  | IXL   | -I   | 4C0 | LP8    | -1     | 4C0   | PYR     | -R     | 4C0   | RIBAR  | -R    | 4C0   | YSC3   | -  | 10CN  |
| DATAREL -   | 87SU  | ICOLOR | -I   | 4C0   | IXR  | -I  | 4C0    | MTE    | -3    | 6RL     | PYRM   | -R    | 4C0    | RIBP  | -R    | 4C0    |    |       |
| DR -R       | 4C0   | TMOME3 | -I   | 4C0   | IYR  | -I  | 4C0    | NQI    | -I    | 4C0     | PYCONV | -R    | 4C0    | RJBP  | -R    | 4C0    |    |       |
| FIRP -R     | 4C0   | IMOMX  | -I   | 4C0   | IYT  | -I  | 4C0    | NQI2   | -I    | 4C0     | PYT    | -R    | 4C0    | ROMFR | -R    | 4C0    |    |       |
| FIPXL -R    | 4C0   | IM6    | -I   | 4C0   | JBP  | -I  | 4C0    | OHEM10 | -R    | 4C0     | PYTP   | -R    | 4C0    | RPDR  | -R    | 4C0    |    |       |
| FIPXR -R    | 4C0   | IPAR   | -I   | 4C0   | JBP2 | -I  | 4C0    | OPEM10 | -R    | 4C0     | REAL   | -     | 6F     | RPDRZ | -R    | 4C0    |    |       |

MULTIPLY-REFERENCED VARIABLES

|       |       |       |     |      |
|-------|-------|-------|-----|------|
| 100 - | 20*   | 993   |     |      |
| 180 - | 32    | 35*   |     |      |
| 189 - | 2300  | 36*   |     |      |
| 199 - | 2200  | 38*   |     |      |
| 210 - | 48*   | 74AS  |     |      |
| 220 - | 50*   | 77AS  | 104 | 107  |
| 290 - | 46    | 68*   |     |      |
| 300 - | 47    | 69    |     | 72*  |
| 310 - | 72AS  | 74*   |     |      |
| 320 - | 48    | 76*   |     |      |
| 330 - | 49    | 79*   |     |      |
| 340 - | 50    | 79AS  |     | 81*  |
| 350 - | 78    | 80    |     | 82*  |
| 370 - | 18    | 92*   |     |      |
| 380 - | 96    | 108*  |     |      |
| 400 - | 75    | 112SU |     |      |
| 410 - | 116   | 117*  |     |      |
| 420 - | 116   | 119*  |     |      |
| 440 - | 113AS | 114AS |     | 122* |
| 450 - | 130   | 132   |     | 156* |
| 452 - | 156   | 156   |     | 157* |
| 454 - | 121   | 160*  |     |      |
| 456 - | 118AS | 156   |     | 164* |
| 458 - | 116   | 117AS |     | 167* |
| 460 - | 115AS | 123AS |     | 172* |
| 479 - | 12600 | 173*  |     |      |
| 489 - | 12500 | 175*  |     |      |
| 490 - | 177*  | 180   |     | 248  |
| 500 - | 73    | 179*  |     | 251  |
| 530 - | 190   | 219*  |     |      |
| 539 - | 18600 | 220*  |     |      |
| 549 - | 18500 | 222*  |     |      |
| 550 - | 223   | 227*  |     |      |
| 580 - | 237   | 240*  |     |      |
| 589 - | 23200 | 242*  |     |      |
| 599 - | 23100 | 244*  |     |      |
| 600 - | 227   | 248*  |     |      |
| 610 - | 250*  | 315   |     | 427  |
| 620 - | 251   | 251   |     | 252* |
| 629 - | 25400 | 256*  |     |      |
| 639 - | 25300 | 258*  |     |      |

|       |          |       |       |                |
|-------|----------|-------|-------|----------------|
| INDEX | 01/12/73 |       |       |                |
| 640   | -        | 251   | 261*  |                |
| 649   | -        | 26300 | 285*  |                |
| 659   | -        | 26200 | 287*  |                |
| 700   | -        | 260   | 289*  |                |
| 709   | -        | 29300 | 296*  |                |
| 719   | -        | 29200 | 298*  |                |
| 720   | -        | 307*  | 308   |                |
| 730   | -        | 309*  | 313   |                |
| 735   | -        | 300   | 314*  |                |
| 739   | -        | 31700 | 318*  |                |
| 740   | -        | 310   | 320*  |                |
| 750   | -        | 322   | 323*  |                |
| 760   | -        | 322   | 325*  |                |
| 770   | -        | 322   | 327*  |                |
| 780   | -        | 324   | 326   | 328*           |
| 789   | -        | 34800 | 355*  |                |
| 799   | -        | 34700 | 357*  |                |
| 800   | -        | 344   | 358*  |                |
| 810   | -        | 359   | 364AS | 366*           |
| 820   | -        | 366   | 371AS | 373* 395       |
| 830   | -        | 373   | 378AS | 380*           |
| 840   | -        | 365   | 372   | 379 386*       |
| 879   | -        | 33700 | 343   | 380 385AS 396* |
| 889   | -        | 33300 | 399*  |                |
| 894   | -        | 33100 | 400*  |                |
| 939   | -        | 40300 | 419*  |                |
| 949   | -        | 40200 | 421*  |                |
| 1000  | -        | 67    | 423*  |                |
| 1015  | -        | 432   | 436*  |                |
| 1020  | -        | 435   | 438*  |                |
| 1025  | -        | 438   | 442*  |                |
| 1030  | -        | 441   | 444*  |                |
| 1035  | -        | 444   | 448*  |                |
| 1040  | -        | 447   | 450*  |                |
| 1045  | -        | 450   | 454*  |                |
| 1050  | -        | 453   | 456*  |                |
| 1089  | -        | 42600 | 464*  |                |
| 1094  | -        | 42500 | 466*  |                |
| 1130  | -        | 531   | 534*  |                |
| 1140  | -        | 533   | 537*  |                |
| 1199  | -        | 47000 | 574*  |                |
| 1210  | -        | 57700 | 578*  |                |
| 1220  | -        | 576   | 579*  |                |
| 1230  | -        | 58000 | 581*  |                |
| 1240  | -        | 579   | 582*  |                |
| 1299  | -        | 46900 | 583*  |                |
| 1389  | -        | 58700 | 597*  |                |
| 1399  | -        | 58600 | 599*  |                |
| 1510  | -        | 649   | 652*  |                |
| 1520  | -        | 652   | 655*  |                |
| 1530  | -        | 655   | 658*  |                |
| 1540  | -        | 658   | 661*  |                |
| 1589  | -        | 60300 | 668*  |                |
| 1599  | -        | 60200 | 670*  |                |
| 2010  | -        | 675*  | 737   |                |
| 2060  | -        | 722   | 725*  |                |
| 2080  | -        | 706   | 725   | 728*           |
| 2089  | -        | 67700 | 729*  |                |

SUBROUTINE YAQUI2

PAGE 58

| INDEX  | 01/12/73 | SUBROUTINE YAQUI2                                                                   | PAGE 59 |
|--------|----------|-------------------------------------------------------------------------------------|---------|
| 2099   | - 67600  | 732*                                                                                |         |
| 3000   | - 735    | 740*                                                                                |         |
| 3009   | - 74300  | 746*                                                                                |         |
| 3019   | - 74200  | 748*                                                                                |         |
| 3109   | - 75200  | 756*                                                                                |         |
| 3119   | - 75100  | 758*                                                                                |         |
| 3150   | - 740    | 761*                                                                                |         |
| 3200   | - 760    | 762*                                                                                |         |
| 3230   | - R24*   | 851                                                                                 |         |
| 3240   | - 827*   | 854                                                                                 |         |
| 3259   | - 76400  | 844*                                                                                |         |
| 3269   | - 76300  | 846*                                                                                |         |
| 3280   | - 821    | 849*                                                                                |         |
| 3290   | - R24    | 852*                                                                                |         |
| 3300   | - R48    | 855*                                                                                |         |
| 3309   | - R5700  | 865*                                                                                |         |
| 3319   | - 85600  | 867*                                                                                |         |
| 3389   | - 87200  | 883*                                                                                |         |
| 3399   | - 87000  | 885*                                                                                |         |
| 3489   | - 88800  | 892*                                                                                |         |
| 3499   | - 88700  | 894*                                                                                |         |
| 3599   | - 89800  | 960*                                                                                |         |
| 3610   | - 96300  | 964*                                                                                |         |
| 3620   | - 962    | 965*                                                                                |         |
| 3630   | - 96600  | 967*                                                                                |         |
| 3640   | - 965    | 968*                                                                                |         |
| 3699   | - 89700  | 969*                                                                                |         |
| 3709   | - 97300  | 977*                                                                                |         |
| 3719   | - 97200  | 979*                                                                                |         |
| 3889   | - 98300  | 988*                                                                                |         |
| 3899   | - 98200  | 990*                                                                                |         |
| 4000   | - 43WR   | 45PR 994*                                                                           |         |
| 4010   | - 82PR   | 83WR 995*                                                                           |         |
| 4020   | - 102PR  | 105WR 996*                                                                          |         |
| 4030   | - 103PR  | 106WR 997*                                                                          |         |
| 4040   | - 108PR  | 109WR 998*                                                                          |         |
| 4050   | - 168PR  | 999*                                                                                |         |
| 4060   | - 162WR  | 170PR 1000*                                                                         |         |
| 4070   | - 157WR  | 164PR 1001*                                                                         |         |
| 4080   | - 161WR  | 169PR 226WR 247WR 329WR 1002*                                                       |         |
| 4090   | - 323WR  | 1003*                                                                               |         |
| 4100   | - 325WR  | 1004*                                                                               |         |
| 4110   | - 327WR  | 1005*                                                                               |         |
| 4120   | - 328WR  | 1006*                                                                               |         |
| 4130   | - 739PR  | 1007*                                                                               |         |
| 4140   | - 225WR  | 1008*                                                                               |         |
| 4150   | - 246WR  | 1009*                                                                               |         |
| AA     | ()R      | 4C0 84WR 94 95RD                                                                    |         |
| AAASC  | ()R      | 3C0 5EQ 5EQ 5EQ 5EQ 5EQ 5EQ 5EQ 5EQ 5EQ                                             |         |
| AA1    | ()R      | 2LC 85WR 97RD                                                                       |         |
| AA2    | ()R      | 2LC 86WR 98RD                                                                       |         |
| AB     | -R       | 826= 836 836 838 838 853=                                                           |         |
| ABL    | -R       | 840= 841                                                                            |         |
| ABS    | -        | 189SU 189SU 315SU 315SU 315SU 535SU 535SU 705SU 706SU 831SU 831SU 831SU 831SU 832SU |         |
| ADV    | -        | 120SU 181SU 229SU 320SU                                                             |         |
| AFSREL | -        | 88SU 89SU 99SU 110SU                                                                |         |
| AK     | -R       | 532= 536= 537 538 542= 543                                                          |         |
| AL     | -R       | 823= 836 836 838 838 850=                                                           |         |













|        | INDEX | 01/12/73          | SUBROUTINE YAQUT2 |       |       |       |       |       |       |       |       |       | PAGE 65 |       |       |       |       |
|--------|-------|-------------------|-------------------|-------|-------|-------|-------|-------|-------|-------|-------|-------|---------|-------|-------|-------|-------|
| R3     | -R    | 147= 155          | 155               | 485=  | 506   | 507   | 509   | 555   | 615=  | 628   | 629   | 692=  | 700     | 711   | 720   | 776=  |       |
|        |       | 806 807           | 841               | 841   | 917=  | 934   |       |       |       |       |       |       |         |       |       |       |       |
| R34    | +R    | 507= 528          | 548               | 548   | 550   | 629=  | 665   | 807=  | 817   | 849   |       |       |         |       |       |       |       |
| R4     | -R    | 152= 155          | 155               | 490=  | 507   | 508   | 510   | 559   | 618=  | 629   | 630   | 697=  | 700     | 700   | 712   | 779=  |       |
|        |       | 807 808           | 841               | 924=  | 935   |       |       |       |       |       |       |       |         |       |       |       |       |
| R4I    | -R    | 508= 528          | 548               | 549   | 550   | 630=  | 665   | 808=  | 817   | 852   |       |       |         |       |       |       |       |
| S      | -R    | 701= 703          |                   |       |       |       |       |       |       |       |       |       |         |       |       |       |       |
| SECONP | -     | 11SU 41SU         |                   |       |       |       |       |       |       |       |       |       |         |       |       |       |       |
| SIE    | ()R   | 5EQ 7DI           | 30                | 133   | 592   | 986=  |       |       |       |       |       |       |         |       |       |       |       |
| SIFT   | -R    | 30= 31            | 33                |       |       |       |       |       |       |       |       |       |         |       |       |       |       |
| SIGN   | -     | R2RSU R30SU R50SU | 853SU             | 941SU | 942SU |       |       |       |       |       |       |       |         |       |       |       |       |
| SQRT   | -     | 199SU 200SU 203SU | 204SU             |       |       |       |       |       |       |       |       |       |         |       |       |       |       |
| START  | -     | 20SU 174SU 184SU  | 230SU             | 252SU | 261SU | 291SU | 330SU | 401SU | 423SU | 468SU | 585SU | 601SU | 675SU   | 741SU | 750SU | 762SU |       |
|        |       | R55SU R86SU R96SU | 971SU             | 981SU |       |       |       |       |       |       |       |       |         |       |       |       |       |
| T      | -R    | 4C0 43WR          | 45PR              | 46    | 50    | 56    | 56    | 57=   | 57    | 69    | 82PR  | 83WR  | 103PR   | 106WR | 161WR | 169PR | 226WR |
|        |       | 247WR 329WR       |                   |       |       |       |       |       |       |       |       |       |         |       |       |       |       |
| TRASE  | -R    | 1)AG 12           | 49                |       |       |       |       |       |       |       |       |       |         |       |       |       |       |
| TLIM   | -R    | 16= 19=           | 19                | 49    | 101=  | 101   |       |       |       |       |       |       |         |       |       |       |       |
| TLTMO  | -R    | 4C0 19            | 101               |       |       |       |       |       |       |       |       |       |         |       |       |       |       |
| TOLD   | -R    | 40= 42            |                   |       |       |       |       |       |       |       |       |       |         |       |       |       |       |
| TOUJ   | -R    | 4C0 46            | 56                | 56    | 68=   | 68    | 70=   |       |       |       |       |       |         |       |       |       |       |
| TWFIN  | -R    | 4C0 50            |                   |       |       |       |       |       |       |       |       |       |         |       |       |       |       |
| T1     | -R    | 12= 48            | 76=               |       |       |       |       |       |       |       |       |       |         |       |       |       |       |
| T2     | -R    | 40 41AG           | 42                | 43WR  | 45PR  | 48    | 49    | 76    |       |       |       |       |         |       |       |       |       |
| T2OMD  | -R    | 4C0 48            |                   |       |       |       |       |       |       |       |       |       |         |       |       |       |       |
| U      | ()R   | 5EQ 7DI           | 28                | 28    | 29    | 29    | 138   | 143   | 148   | 153   | 157WR | 164PR | 189     | 235   | 268   | 272   | 276   |
|        |       | 280 433           | 439               | 445   | 451   | 457   | 459   | 461   | 476   | 481   | 486   | 491   | 574=    | 986   | 986   | 986   | 986   |
| UD1    | -R    | 788= 827          | 852               |       |       |       |       |       |       |       |       |       |         |       |       |       |       |
| UD2    | -R    | 790= 827          | 829               |       |       |       |       |       |       |       |       |       |         |       |       |       |       |
| UD3    | -R    | 792= 829          | 849               |       |       |       |       |       |       |       |       |       |         |       |       |       |       |
| UD4    | -R    | 794= 849          | 852               |       |       |       |       |       |       |       |       |       |         |       |       |       |       |
| UG     | ()R   | 5EQ 7DI           | 744=              | 753   | 788   | 790   | 792   | 794   | 905   | 912   | 919   | 926   |         |       |       |       |       |
| UG1    | -R    | 905= 934          |                   |       |       |       |       |       |       |       |       |       |         |       |       |       |       |
| UG2    | -R    | 912= 935          |                   |       |       |       |       |       |       |       |       |       |         |       |       |       |       |
| UG3    | -R    | 919= 934          |                   |       |       |       |       |       |       |       |       |       |         |       |       |       |       |
| UG4    | -R    | 926= 935          |                   |       |       |       |       |       |       |       |       |       |         |       |       |       |       |
| UL     | ()R   | 5EQ 7DI           | 683               | 688   | 693   | 698   | 718=  | 719=  | 720=  | 721=  | 730=  | 730=  | 730=    | 730=  | 744   | 780   | 782   |
|        |       | 784 786           | 890               | 904   | 911   | 918   | 925   |       |       |       |       |       |         |       |       |       |       |
| UL1    | -R    | 780= 788          | 809               | 812   | 904=  | 930   | 947   |       |       |       |       |       |         |       |       |       |       |
| UL13   | -R    | 930= 934          |                   |       |       |       |       |       |       |       |       |       |         |       |       |       |       |
| UL2    | -R    | 782= 790          | 809               | 810   | 911=  | 932   | 950   |       |       |       |       |       |         |       |       |       |       |
| UL24   | -R    | 932= 935          |                   |       |       |       |       |       |       |       |       |       |         |       |       |       |       |
| UL3    | -R    | 784= 792          | 810               | 811   | 918=  | 930   | 947   |       |       |       |       |       |         |       |       |       |       |
| UL4    | -R    | 786= 794          | 811               | 812   | 925=  | 932   | 950   |       |       |       |       |       |         |       |       |       |       |
| UP     | ()R   | 5EQ 7DI           | 890=              | 948=  | 948   | 949=  | 949   | 951=  | 951   | 952=  | 952   | 961=  | 961=    | 961=  | 961=  | 974   |       |
| UTL    | ()R   | 5EQ 7DI           | 459=              | 554=  | 554   | 555=  | 555   | 558=  | 558   | 559=  | 559   | 575=  | 575=    | 575=  | 575=  | 631   | 632   |
|        |       | 633 634           |                   |       |       |       |       |       |       |       |       |       |         |       |       |       |       |
| U1     | -R    | 138= 155          | 155               | 268=  | 281   | 283   | 431=  | 433=  | 439=  | 439   | 445=  | 445   | 451=    | 451   | 457   | 476=  | 511   |
|        |       | 514 516           | 631=              | 639   | 642   | 683=  | 700   | 700   | 718   |       |       |       |         |       |       |       |       |
| U12    | -R    | 511= 528          | 548               | 548   | 550   | 551   | 639=  | 665   | 809=  | 817   |       |       |         |       |       |       |       |
| U13    | -R    | 516= 570          |                   |       |       |       |       |       |       |       |       |       |         |       |       |       |       |
| U2     | -R    | 143= 155          | 155               | 272=  | 283   | 283   | 481=  | 511   | 512   | 515   | 632=  | 639   | 640     | 688=  | 700   | 700   | 719   |
| U23    | -R    | 512= 528          | 548               | 550   | 640=  | 665   | 810=  | 817   |       |       |       |       |         |       |       |       |       |
| U24    | -R    | 515= 567          |                   |       |       |       |       |       |       |       |       |       |         |       |       |       |       |
| U3     | -R    | 148= 155          | 155               | 276=  | 283   | 283   | 486=  | 512   | 513   | 516   | 633=  | 640   | 641     | 693=  | 700   | 700   | 720   |
| U34    | -R    | 513= 528          | 548               | 548   | 550   | 551   | 641=  | 665   | 811=  | 817   |       |       |         |       |       |       |       |
| U4     | -R    | 153= 155          | 155               | 280=  | 283   | 283   | 491=  | 513   | 514   | 515   | 534   | 535   | 634=    | 641   | 642   | 698=  | 700   |
|        |       | 700 721           |                   |       |       |       |       |       |       |       |       |       |         |       |       |       |       |



|       | INDEX | 01/12/73 |      |       | SUBROUTINE |      |      |       | YAQUIZ |      |      |       | PAGE 67 |      |      |      |      |      |  |
|-------|-------|----------|------|-------|------------|------|------|-------|--------|------|------|-------|---------|------|------|------|------|------|--|
| XX    | -R    | 42=      | 43WR | 45PR  | 299=       | 300  | 301  | 302=  | 303    | 305= | 307= | 307   | 308     | 309  | 310  | 312= | 312  | 314= |  |
|       |       | 315      | 316  | 387=  | 388        | 389  | 430= | 437=  | 449=   | 459  | 529= | 535   | 540=    | 540  | 540  | 543  | 543  | 552= |  |
|       |       | 554      | 555  | 556=  | 55A        | 559  | 561= | 562   | 563    | 564= | 565  | 566   | 567=    | 568  | 569  | 570= | 571  | 572  |  |
|       |       | 593=     | 595  | 595   | 713=       | 714  | 715  | 716   | 717    | 831= | 832  | A76=  | 877=    | 878= | 878  | 879= | 879  | 880= |  |
|       |       | 880      | 881  | 889=  | 890        | 891  | 929= | 934   | 935    | 940= | 941  | 942   | 947=    | 948  | 949  | 950= | 951  | 952  |  |
|       |       | 953=     | 954  | 955   | 956=       | 957  | 958  |       |        |      |      |       |         |      |      |      |      |      |  |
| XY    | -R    | 527=     | 548  | 550   | 551        | 551  |      |       |        |      |      |       |         |      |      |      |      |      |  |
| XY14  | -R    | 199=     | 201  | 202   |            |      |      |       |        |      |      |       |         |      |      |      |      |      |  |
| XY21  | -R    | 203=     | 205  | 206   |            |      |      |       |        |      |      |       |         |      |      |      |      |      |  |
| XY23  | -R    | 200=     | 201  | 202   |            |      |      |       |        |      |      |       |         |      |      |      |      |      |  |
| XY34  | -R    | 204=     | 205  | 206   |            |      |      |       |        |      |      |       |         |      |      |      |      |      |  |
| X1    | -R    | 135=     | 155  | 155   | 191=       | 199  | 203  | 207   | 266=   | 283  | 283  | 431=  | 436=    | 442= | 442  | 448= | 448  | 454= |  |
|       |       | 454      | 456= | 456   | 457        | 458  | 473= | 493   | 496    | 498  | 529  | 607=  | 619     | 622  | 680= | 700  | 700  | 711  |  |
|       |       | 768=     | 796  | 799   | 839        | 840  | 901= | 934   |        |      |      |       |         |      |      |      |      |      |  |
| X12   | -R    | 493=     | 528  | 549   | 550        | 619= | 665  | 796=  | 817    | 827  |      |       |         |      |      |      |      |      |  |
| X2    | -R    | 140=     | 155  | 155   | 192=       | 200  | 203  | 209   | 270=   | 283  | 283  | 478=  | 493     | 494  | 497  | 529  | 610= | 619  |  |
|       |       | 620      | 685= | 700   | 700        | 712  | 771= | 796   | 797    | 839  | 908= | 935   |         |      |      |      |      |      |  |
| X23   | -R    | 494=     | 528  | 549   | 550        | 620= | 665  | 797=  | 817    | 829  |      |       |         |      |      |      |      |      |  |
| X24   | -R    | 497=     | 527  | 552   | 561        | 567  | 567  |       |        |      |      |       |         |      |      |      |      |      |  |
| X3    | -R    | 145=     | 155  | 155   | 193=       | 200  | 204  | 211   | 274=   | 283  | 283  | 483=  | 494     | 495  | 498  | 529  | 613= | 620  |  |
|       |       | 621      | 690= | 700   | 700        | 711  | 774= | 797   | 798    | 839  | 840  | 915=  | 934     |      |      |      |      |      |  |
| X31   | -R    | 498=     | 527  | 556   | 564        | 570  | 570  |       |        |      |      |       |         |      |      |      |      |      |  |
| X34   | -R    | 495=     | 528  | 549   | 550        | 621= | 665  | 798=  | 817    | 849  |      |       |         |      |      |      |      |      |  |
| X4    | -R    | 150=     | 155  | 155   | 194=       | 199  | 204  | 213   | 278=   | 283  | 283  | 488=  | 495     | 496  | 497  | 529  | 616= | 621  |  |
|       |       | 622      | 695= | 700   | 700        | 712  | 777= | 798   | 799    | 840  | 922= | 935   |         |      |      |      |      |      |  |
| X41   | -R    | 496=     | 528  | 549   | 550        | 622= | 665  | 799=  | 817    | 852  |      |       |         |      |      |      |      |      |  |
| Y     | ()R   | 5EQ      | 7DI  | 26    | 26         | 27   | 27   | 136   | 141    | 146  | 151  | 157WR | 164PR   | 195  | 196  | 197  | 198  | 234  |  |
|       |       | 236      | 267  | 271   | 275        | 279  | 353  | 353   | 353    | 353  | 407  | 409   | 411     | 413  | 474  | 479  | 484  | 489  |  |
|       |       | 594      | 594  | 594   | 594        | 608  | 611  | 614   | 617    | 681  | 686  | 691   | 696     | 754= | 754  | 769  | 772  | 775  |  |
|       |       | 778      | 902  | 909   | 916        | 923  |      |       |        |      |      |       |         |      |      |      |      |      |  |
| Y8    | -R    | 4C0      | 34   | 208   | 210        | 212  | 214  | 225WR | 234    | 236  | 389  | 407   | 409     | 411  | 413  |      |      |      |  |
| YCO   | ()R   | ADI      | 9EQ  | 353=  | 389        | 389  | 389  |       |        |      |      |       |         |      |      |      |      |      |  |
| YCONV | -R    | 4C0      | 208  | 210   | 212        | 214  | 234  | 236   | 389    | 407  | 409  | 411   | 413     |      |      |      |      |      |  |
| YPAR  | ()R   | 5EQ      | 7DI  |       |            |      |      |       |        |      |      |       |         |      |      |      |      |      |  |
| YT    | -R    | 4C0      | 34   | 225WR |            |      |      |       |        |      |      |       |         |      |      |      |      |      |  |
| YY    | -R    | 430=     | 443= | 455=  | 460        | 530= | 535  | 541=  | 541    | 541  | 543  | 543   | 553=    | 554  | 555  | 557= | 558  | 559  |  |
|       |       | 594=     | 595  | 595   |            |      |      |       |        |      |      |       |         |      |      |      |      |      |  |
| Y1    | -R    | 136=     | 155  | 155   | 195=       | 199  | 203  | 208   | 267=   | 283  | 283  | 424=  | 457     | 458  | 474= | 499  | 502  | 504  |  |
|       |       | 530      | 608= | 623   | 626        | 681= | 700  | 700   | 710    | 769= | 800  | 803   | 804     | 902= | 934  |      |      |      |  |
| Y14   | -R    | 502=     | 528  | 548   | 550        | 626= | 665  | 803=  | 817    | 840  | 852  |       |         |      |      |      |      |      |  |
| Y2    | -R    | 141=     | 155  | 155   | 196=       | 200  | 203  | 210   | 271=   | 283  | 283  | 479=  | 499     | 500  | 503  | 530  | 611= | 623  |  |
|       |       | 624      | 686= | 700   | 700        | 709  | 772= | 800   | 801    | 909= | 935  |       |         |      |      |      |      |      |  |
| Y21   | -R    | 499=     | 528  | 548   | 550        | 623= | 665  | 800=  | 817    | 827  | 839  |       |         |      |      |      |      |      |  |
| Y24   | -R    | 503=     | 527  | 552   | 553        | 561  | 567  | 567   | 709=   | 718  | 720  |       |         |      |      |      |      |      |  |
| Y3    | -R    | 146=     | 155  | 155   | 197=       | 200  | 204  | 212   | 275=   | 283  | 283  | 484=  | 500     | 501  | 504  | 530  | 614= | 624  |  |
|       |       | 625      | 691= | 700   | 700        | 710  | 775= | 801   | 802    | 804  | 916= | 934   |         |      |      |      |      |      |  |
| Y31   | -R    | 504=     | 527  | 556   | 557        | 564  | 570  | 570   | 710=   | 719  | 721  | 804=  | 839     | 840  |      |      |      |      |  |
| Y32   | -R    | 500=     | 528  | 548   | 550        | 624= | 665  | 801=  | 817    | 829  | 839  |       |         |      |      |      |      |      |  |
| Y4    | -R    | 151=     | 155  | 155   | 198=       | 199  | 204  | 214   | 279=   | 283  | 283  | 489=  | 501     | 502  | 503  | 530  | 617= | 625  |  |
|       |       | 626      | 696= | 700   | 700        | 709  | 778= | 802   | 803    | 923= | 935  |       |         |      |      |      |      |      |  |
| Y43   | -R    | 501=     | 528  | 548   | 550        | 625= | 665  | 802=  | 817    | 840  | 849  |       |         |      |      |      |      |      |  |
| ZZ    | -R    | 4C0      | 94   |       |            |      |      |       |        |      |      |       |         |      |      |      |      |      |  |

| INDEX | 01/12/73 | SUBROUTINE PARTMOV                                                                                                                                                                                                                                                                                                                                                                                                                                                                                                                                                                                                                                                                                                                                                                                                                           | PAGE 68                                                                                                                                                                                                                                                     |
|-------|----------|----------------------------------------------------------------------------------------------------------------------------------------------------------------------------------------------------------------------------------------------------------------------------------------------------------------------------------------------------------------------------------------------------------------------------------------------------------------------------------------------------------------------------------------------------------------------------------------------------------------------------------------------------------------------------------------------------------------------------------------------------------------------------------------------------------------------------------------------|-------------------------------------------------------------------------------------------------------------------------------------------------------------------------------------------------------------------------------------------------------------|
| 1     |          | SUBROUTINE PARTMOV                                                                                                                                                                                                                                                                                                                                                                                                                                                                                                                                                                                                                                                                                                                                                                                                                           | YAQUI1 01056                                                                                                                                                                                                                                                |
| 2     |          | COMMON /YSC1/ AASC(4242)                                                                                                                                                                                                                                                                                                                                                                                                                                                                                                                                                                                                                                                                                                                                                                                                                     | COMMON2 00002                                                                                                                                                                                                                                               |
| 3     |          | COMMON /YSC2/ AA(1),ANC,ASQ,A0,A0FAC,A0M,R1,COLAMU,CYL,<br>DR,DT,DTFC,DTFAC,DTGR,DTGZ,DTGZP,DTO(10),DTOC(10),<br>DT016,DT02,DT04,DT08,DTPOS,DTV,DTB,DZ,EM10,EPS,FIBP,<br>FIPXL,FIPXR,FIPYB,FIPYT,FIXL,FXR,F1YB,FIYT,FJBP,<br>FREZ,GGM1,GMI,GR,GROVEL,GZ,G7P,I,IRAR,IRP,IRP1,ICOLOR,<br>IDTO,IJ,IJM,IJP,IJPS,IMOME3,IMDMX,I11,IM6,<br>IPAR,IPXL,IPXR,IPYR,IPYT,TPI,IP2,ISCF1,ISCF2,ISCF3,<br>ITV,TUNF,IXL,IXR,IYB,IYT,J,JBAR,JRP,JRP2,JCEN,JM10,<br>JM14,JP1,JP2,JP4,JP4D2,JINF,JUNF02,KXI,LAM,LJP2,LPR,<br>LPR,MU,NAME(10),NCYC,NLC,NPS,NPT,NO,NOI,NQIB,NQI2,NSC,<br>NUMIT,NUMTO,OM,OMANC,OMCYL,OMEM10,OPMEM10,OPR,PDZ,PXCONV,<br>PXL,PRX,PRRP,PYB,PYBM,PYCONV,PYT,PY: P,ROT,REZRON,REZSIE,<br>REZJE,REZVF,REZVT,REZY0,RIBAR,RIRJA,RIAP,RJRP,ROMFR,<br>RON,RPOR,RPOR0Z,RPOZ,T,THIRD,TLIM0,TOUT,TWFIN,TZOM0,<br>VV,XCONV,XL,XR,YB,YCONV,YT,ZZ | COMMON2 00003<br>COMMON2 00004<br>COMMON2 00005<br>COMMON2 00006<br>COMMON2 00007<br>COMMON2 00008<br>COMMON2 00009<br>COMMON2 00010<br>COMMON2 00011<br>COMMON2 00012<br>COMMON2 00013<br>COMMON2 00014<br>COMMON2 00015<br>COMMON2 00016<br>COMMON2 00017 |
| 4     |          | EQUIVALENCE (AASC(1),X,XPARG),(AASC(2),R,YPAR),(AASC(3),Y,MPAR),<br>(AASC(4),U,UG,DELSM),(AASC(5),V,VG),(AASC(6),RO),<br>(AASC(7),STE,MP,RMP,RCS0),(AASC(8),E,ETIL),<br>(AASC(9),RVOL),(AASC(10),M,RM,VP),(AASC(11),P,PL,EP,<br>UP,PM0),(AASC(12),UTIL,UL,CQ,PMX,PU),(AASC(13),VTIL,<br>VL,PMY,PV),(AASC(14),Q,R0L)                                                                                                                                                                                                                                                                                                                                                                                                                                                                                                                          | EQVREAL 00002<br>EQVREAL 00003<br>EQVREAL 00004<br>EQVREAL 00005<br>EQVREAL 00006<br>EQVREAL 00007                                                                                                                                                          |
| 5     |          | REAL LAM,LAM0,M,MR,MC,ML,MP,MPAR,MR,MT,MTE,MU,MU02,MU04                                                                                                                                                                                                                                                                                                                                                                                                                                                                                                                                                                                                                                                                                                                                                                                      | EQVREAL 00008                                                                                                                                                                                                                                               |
| 6     |          | DIMENSION X(1),XPARG(1),R(1),YPARG(1),Y(1),MPARG(1),U(1),UG(1),<br>DELSM(1),V(1),VG(1),RO(1),SIE(1),MP(1),RMP(1),RCS0(1),<br>E(1),ETIL(1),RVOL(1),M(1),RM(1),VP(1),P(1),PL(1),EP(1),<br>UP(1),UTIL(1),UL(1),CQ(1),PMX(1),PU(1),VTIL(1),VL(1),<br>PMY(1),PV(1),Q(1),R0L(1),PM0(1)                                                                                                                                                                                                                                                                                                                                                                                                                                                                                                                                                             | DIMEN 00002<br>DIMEN 00003<br>DIMEN 00004<br>DIMEN 00005<br>DIMEN 00006                                                                                                                                                                                     |
| 7     |          | DIMENSION X1(4)                                                                                                                                                                                                                                                                                                                                                                                                                                                                                                                                                                                                                                                                                                                                                                                                                              | YAQUI1 01060                                                                                                                                                                                                                                                |
| 8     |          | EQUIVALENCE (X1(2),X2),(X1(3),X3),(X1(4),X4)                                                                                                                                                                                                                                                                                                                                                                                                                                                                                                                                                                                                                                                                                                                                                                                                 | YAQUI1 01061                                                                                                                                                                                                                                                |
| 9     |          | COMMON /YSC3/ JNM                                                                                                                                                                                                                                                                                                                                                                                                                                                                                                                                                                                                                                                                                                                                                                                                                            | YAQUI1 01062                                                                                                                                                                                                                                                |
| 10    |          | CALL START                                                                                                                                                                                                                                                                                                                                                                                                                                                                                                                                                                                                                                                                                                                                                                                                                                   | YAQUI1 01063                                                                                                                                                                                                                                                |
| 11    |          | ON 1019 J=2,JP2                                                                                                                                                                                                                                                                                                                                                                                                                                                                                                                                                                                                                                                                                                                                                                                                                              | YAQUI1 01064                                                                                                                                                                                                                                                |
| 12    |          | ON 1009 I=1,TP1                                                                                                                                                                                                                                                                                                                                                                                                                                                                                                                                                                                                                                                                                                                                                                                                                              | YAQUI1 01065                                                                                                                                                                                                                                                |
| 13    |          | PMX(IJ) = PMY(IJ) = PM0(IJ) = 0,0                                                                                                                                                                                                                                                                                                                                                                                                                                                                                                                                                                                                                                                                                                                                                                                                            | YAQUI1 01066                                                                                                                                                                                                                                                |
| 14    | 1009     | IJ = IJ+NQ                                                                                                                                                                                                                                                                                                                                                                                                                                                                                                                                                                                                                                                                                                                                                                                                                                   | YAQUI1 01067                                                                                                                                                                                                                                                |
| 15    |          | CALL LOOP                                                                                                                                                                                                                                                                                                                                                                                                                                                                                                                                                                                                                                                                                                                                                                                                                                    | YAQUI1 01068                                                                                                                                                                                                                                                |
| 16    | 1019     | CONTINUE                                                                                                                                                                                                                                                                                                                                                                                                                                                                                                                                                                                                                                                                                                                                                                                                                                     | YAQUI1 01069                                                                                                                                                                                                                                                |
| 17    |          | CALL DONE                                                                                                                                                                                                                                                                                                                                                                                                                                                                                                                                                                                                                                                                                                                                                                                                                                    | YAQUI1 01070                                                                                                                                                                                                                                                |
| 18    |          | ON 1009 J=2,JP2                                                                                                                                                                                                                                                                                                                                                                                                                                                                                                                                                                                                                                                                                                                                                                                                                              | YAQUI1 01071                                                                                                                                                                                                                                                |
| 19    |          | IEC = (J-1)*NQI                                                                                                                                                                                                                                                                                                                                                                                                                                                                                                                                                                                                                                                                                                                                                                                                                              | YAQUI1 01072                                                                                                                                                                                                                                                |
| 20    |          | CALL ECRD (AASC,IEC,NQ1,NE)                                                                                                                                                                                                                                                                                                                                                                                                                                                                                                                                                                                                                                                                                                                                                                                                                  | YAQUI1 01073                                                                                                                                                                                                                                                |
| 21    |          | IJ = 1                                                                                                                                                                                                                                                                                                                                                                                                                                                                                                                                                                                                                                                                                                                                                                                                                                       | YAQUI1 01074                                                                                                                                                                                                                                                |
| 22    |          | ON 1009 I=1,TP1                                                                                                                                                                                                                                                                                                                                                                                                                                                                                                                                                                                                                                                                                                                                                                                                                              | YAQUI1 01075                                                                                                                                                                                                                                                |
| 23    |          | IF (X(IJ).GT.PXRP .OR. Y(IJ).LT.PYBM) GO TO 1099                                                                                                                                                                                                                                                                                                                                                                                                                                                                                                                                                                                                                                                                                                                                                                                             | YAQUI1 01076                                                                                                                                                                                                                                                |
| 24    |          | TF (Y(IJ).GT.PYTP) GO TO 1100                                                                                                                                                                                                                                                                                                                                                                                                                                                                                                                                                                                                                                                                                                                                                                                                                | YAQUI1 01077                                                                                                                                                                                                                                                |
| 25    |          | KI = X(IJ) *RPNR + OPEM10                                                                                                                                                                                                                                                                                                                                                                                                                                                                                                                                                                                                                                                                                                                                                                                                                    | YAQUI1 01078                                                                                                                                                                                                                                                |
| 26    |          | KJ = (Y(IJ)-PYR)*RPNZ + OPEM10                                                                                                                                                                                                                                                                                                                                                                                                                                                                                                                                                                                                                                                                                                                                                                                                               | YAQUI1 01079                                                                                                                                                                                                                                                |
| 27    |          | IFC = KJ*NQI                                                                                                                                                                                                                                                                                                                                                                                                                                                                                                                                                                                                                                                                                                                                                                                                                                 | YAQUI1 01080                                                                                                                                                                                                                                                |
| 28    |          | CALL ECRD (AASC(ISC2),IEC,NQI2,NE)                                                                                                                                                                                                                                                                                                                                                                                                                                                                                                                                                                                                                                                                                                                                                                                                           | YAQUI1 01081                                                                                                                                                                                                                                                |
| 29    |          | KIJ = (KI-1)*NQ*ISC2                                                                                                                                                                                                                                                                                                                                                                                                                                                                                                                                                                                                                                                                                                                                                                                                                         | YAQUI1 01082                                                                                                                                                                                                                                                |
| 30    |          | KIJP = KIJ+NQI                                                                                                                                                                                                                                                                                                                                                                                                                                                                                                                                                                                                                                                                                                                                                                                                                               | YAQUI1 01083                                                                                                                                                                                                                                                |
| 31    |          | W = X1(IJ) -FLOAT(KI-1)*POR                                                                                                                                                                                                                                                                                                                                                                                                                                                                                                                                                                                                                                                                                                                                                                                                                  | YAQUI1 01084                                                                                                                                                                                                                                                |
| 32    |          | H = (Y(IJ)-PYR)-FLOAT(KJ-1)*POZ                                                                                                                                                                                                                                                                                                                                                                                                                                                                                                                                                                                                                                                                                                                                                                                                              | YAQUI1 01085                                                                                                                                                                                                                                                |
| 33    |          | XX = RPNR0Z/RM(IJ)                                                                                                                                                                                                                                                                                                                                                                                                                                                                                                                                                                                                                                                                                                                                                                                                                           | YAQUI1 01086                                                                                                                                                                                                                                                |
| 34    |          | MTE = POZ-H                                                                                                                                                                                                                                                                                                                                                                                                                                                                                                                                                                                                                                                                                                                                                                                                                                  | YAQUI1 01087                                                                                                                                                                                                                                                |
| 35    |          | ON 1009 JJ=1,2                                                                                                                                                                                                                                                                                                                                                                                                                                                                                                                                                                                                                                                                                                                                                                                                                               | YAQUI1 01088                                                                                                                                                                                                                                                |

| INDEX | 01/12/73 | SUBROUTINE PARTMOV                       | PAGE   | 69    |
|-------|----------|------------------------------------------|--------|-------|
| 36    |          | WTE = PDR-W                              | YAQUI1 | 01089 |
| 37    |          | DO 1039 I1=1,2                           | YAQUI1 | 01090 |
| 38    |          | X1 = XX*WTE*HTE                          | YAQUI1 | 01091 |
| 39    |          | PMX(KIJ) = PMX(KIJ) +X1*U(IJ)            | YAQUI1 | 01092 |
| 40    |          | PMY(KIJ) = PMY(KIJ) +X1*V(IJ)            | YAQUI1 | 01093 |
| 41    |          | PMO(KIJ) = PMO(KIJ) +X1                  | YAQUI1 | 01094 |
| 42    |          | WTE = W                                  | YAQUI1 | 01095 |
| 43    | 1039     | KIJ = KIJ+NQ                             | YAQUI1 | 01096 |
| 44    |          | HTE = H                                  | YAQUI1 | 01097 |
| 45    | 1049     | KIJ = KIJP                               | YAQUI1 | 01098 |
| 46    |          | CALL ECWR (AASC(ISC2),IEC,NQI2,NE)       | YAQUI1 | 01099 |
| 47    | 1089     | IJ = IJ+NQ                               | YAQUI1 | 01100 |
| 48    | 1099     | CONTINUE                                 | YAQUI1 | 01101 |
| 49    | 1100     | CALL START                               | YAQUI1 | 01102 |
| 50    |          | KK = 0                                   | YAQUI1 | 01103 |
| 51    |          | DO 1199 J=2,JBP2                         | YAQUI1 | 01104 |
| 52    |          | DO 1189 I=1,I8P1                         | YAQUI1 | 01105 |
| 53    |          | RPMO = PMO(IJ)                           | YAQUI1 | 01106 |
| 54    |          | IF (RPMO,NE,0.) PMO(IJ) = RPMO = 1./RPMO | YAQUI1 | 01107 |
| 55    |          | IF (RPMO,EQ,0.) KK = 1                   | YAQUI1 | 01108 |
| 56    |          | PU(IJ) = PMX(IJ)*RPMO                    | YAQUI1 | 01109 |
| 57    |          | PV(IJ) = PMY(IJ)*RPMO                    | YAQUI1 | 01110 |
| 58    |          | IF (I,EQ,1) PU(IJ) = 0.                  | YAQUI1 | 01111 |
| 59    | 1189     | IJ = IJ + NQ                             | YAQUI1 | 01112 |
| 60    |          | CALL LOOP                                | YAQUI1 | 01113 |
| 61    | 1199     | CONTINUE                                 | YAQUI1 | 01114 |
| 62    |          | CALL DONE                                | YAQUI1 | 01115 |
| 63    | 1200     | IF (KK,EQ,0) GO TO I400                  | YAQUI1 | 01116 |
| 64    |          | CALL START                               | YAQUI1 | 01117 |
| 65    |          | DO 1299 J=2,JBP2                         | YAQUI1 | 01118 |
| 66    |          | DO 1289 I=1,I8P1                         | YAQUI1 | 01119 |
| 67    |          | IF (PMO(IJ),GT,0.) GO TO 1289            | YAQUI1 | 01120 |
| 68    |          | ITESTL = ITESTR = 1                      | YAQUI1 | 01121 |
| 69    |          | PUL = PVL = PUR = PVR = 0.               | YAQUI1 | 01122 |
| 70    |          | XWL = XWR = 1.                           | YAQUI1 | 01123 |
| 71    |          | IL = IR = IJ                             | YAQUI1 | 01124 |
| 72    | 1210     | ITESTL = ITESTL-1                        | YAQUI1 | 01125 |
| 73    |          | IF (ITESTL,LT,1) GO TO 1230              | YAQUI1 | 01126 |
| 74    |          | IL = IL-NQ                               | YAQUI1 | 01127 |
| 75    |          | IF (PMO(IL),GT,0.) GO TO 1220            | YAQUI1 | 01128 |
| 76    |          | XWL = XWL + 1.                           | YAQUI1 | 01129 |
| 77    |          | GO TO 1210                               | YAQUI1 | 01130 |
| 78    | 1220     | PUL = PU(IL)                             | YAQUI1 | 01131 |
| 79    |          | PVL = PV(IL)                             | YAQUI1 | 01132 |
| 80    | 1230     | ITESTR = ITESTR+1                        | YAQUI1 | 01133 |
| 81    |          | IF (ITESTR,GT,I8P1) GO TO 1250           | YAQUI1 | 01134 |
| 82    |          | IR = IR+NQ                               | YAQUI1 | 01135 |
| 83    |          | IF (PMO(IR),GT,0.) GO TO 1240            | YAQUI1 | 01136 |
| 84    |          | XWR = XWR + 1.                           | YAQUI1 | 01137 |
| 85    |          | GO TO 1230                               | YAQUI1 | 01138 |
| 86    | 1240     | PUR = PU(IR)                             | YAQUI1 | 01139 |
| 87    |          | PVR = PV(IR)                             | YAQUI1 | 01140 |
| 88    | 1250     | DEN = 1./{XWL*XWR}                       | YAQUI1 | 01141 |
| 89    |          | WTL = XWR*DEN                            | YAQUI1 | 01142 |
| 90    |          | WTR = XWL*DEN                            | YAQUI1 | 01143 |
| 91    |          | PU(IJ) = PUL*WTL + PUR*WTR               | YAQUI1 | 01144 |
| 92    |          | PV(IJ) = PVL*WTL + PVR*WTR               | YAQUI1 | 01145 |
| 93    | 1289     | IJ = IJ+NQ                               | YAQUI1 | 01146 |



| INDEX | 01/12/73 | SUBROUTINE PARTMOV                                                 | PAGE   | 70    |
|-------|----------|--------------------------------------------------------------------|--------|-------|
| 94    |          | CALL LOOP                                                          | YAQUI1 | 01147 |
| 95    | 1299     | CONTINUE                                                           | YAQUI1 | 01148 |
| 96    |          | CALL DONE                                                          | YAQUI1 | 01149 |
| 97    | 1300     | DO 1399 J=2,JBP2                                                   | YAQUI1 | 01150 |
| 98    |          | IEC = IJ-1*NOI                                                     | YAQUI1 | 01151 |
| 99    |          | CALL ECRD IAASC,IEC,NOI,NEI                                        | YAQUI1 | 01152 |
| 100   |          | IJ = 1                                                             | YAQUI1 | 01153 |
| 101   |          | DO 1389 I=1,IBP1                                                   | YAQUI1 | 01154 |
| 102   |          | IF IPMOI IJ,GT,0. .OR. PUIIJI,NE,0. .OR. PVI IJI,NE,0.1 GO TO 1389 | YAQUI1 | 01155 |
| 103   |          | JTESTR = JTESTT * J                                                | YAQUI1 | 01156 |
| 104   |          | PUB = PVB = PUT = PVT = 0.                                         | YAQUI1 | 01157 |
| 105   |          | XWR = XWT = 1.                                                     | YAQUI1 | 01158 |
| 106   |          | II = IT = IJ+NOI                                                   | YAQUI1 | 01159 |
| 107   |          | IECB = IECT = IEC                                                  | YAQUI1 | 01160 |
| 108   | 1310     | JTESTR = JTESTR - 1                                                | YAQUI1 | 01161 |
| 109   |          | IF IJTESTR,LT,21 GO TO 1330                                        | YAQUI1 | 01162 |
| 110   |          | IECR = IECA - NOI                                                  | YAQUI1 | 01163 |
| 111   |          | CALL ECRD IAASCIISC21,IECR,NOI,NEI                                 | YAQUI1 | 01164 |
| 112   |          | IF IPMOI IBI,GT,0.1 GO TO 1320                                     | YAQUI1 | 01165 |
| 113   |          | XWR = XWR + 1.                                                     | YAQUI1 | 01166 |
| 114   |          | GO TO 1310                                                         | YAQUI1 | 01167 |
| 115   | 1320     | PUIB = PUIIB1                                                      | YAQUI1 | 01168 |
| 116   |          | PVB = PVIIB1                                                       | YAQUI1 | 01169 |
| 117   | 1330     | JTESTT = JTESTT + 1                                                | YAQUI1 | 01170 |
| 118   |          | IF IJTESTT,GT,JBP21 GO TO 1350                                     | YAQUI1 | 01171 |
| 119   |          | IECT = IECT + NOI                                                  | YAQUI1 | 01172 |
| 120   |          | CALL ECRD IAASCIISC21,IECT,NOI,NEI                                 | YAQUI1 | 01173 |
| 121   |          | IF IPMOI ITI,GT,0.1 GO TO 1340                                     | YAQUI1 | 01174 |
| 122   |          | XWT = XWT + 1.                                                     | YAQUI1 | 01175 |
| 123   |          | GO TO 1330                                                         | YAQUI1 | 01176 |
| 124   | 1340     | PUII = PUIIT1                                                      | YAQUI1 | 01177 |
| 125   |          | PVT = PVIIT1                                                       | YAQUI1 | 01178 |
| 126   | 1350     | DEFN = 1./(XWT+XWB1                                                | YAQUI1 | 01179 |
| 127   |          | WTB = XWT*DEFN                                                     | YAQUI1 | 01180 |
| 128   |          | WTT = XWR*DEFN                                                     | YAQUI1 | 01181 |
| 129   |          | PUIIJI = PUB*WTB + PUT*WTT                                         | YAQUI1 | 01182 |
| 130   |          | PVI IJI = PVB*WTB + PVT*WTT                                        | YAQUI1 | 01183 |
| 131   | 1389     | IJ = IJ + NO                                                       | YAQUI1 | 01184 |
| 132   | 1399     | CALL ECRD IAASC,IEC,NOI,NEI                                        | YAQUI1 | 01185 |
| 133   | 1400     | IF IIMOMX,EG,01 GO TO 2000                                         | YAQUI1 | 01186 |
| 134   |          | CALL START                                                         | YAQUI1 | 01187 |
| 135   |          | DO 1499 J=2,JBP2                                                   | YAQUI1 | 01188 |
| 136   |          | DO 1489 I=1,IBP1                                                   | YAQUI1 | 01189 |
| 137   |          | PUIIJI = PUIIJI.AND,.NOT,777777777777                              | YAQUI1 | 01190 |
| 138   |          | PVI IJI = PVI IJI.AND,.NOT,777777777777                            | YAQUI1 | 01191 |
| 139   | 1489     | IJ = IJ + NO                                                       | YAQUI1 | 01192 |
| 140   |          | CALL LOOP                                                          | YAQUI1 | 01193 |
| 141   | 1499     | CONTINUE                                                           | YAQUI1 | 01194 |
| 142   |          | CALL DONE                                                          | YAQUI1 | 01195 |
| 143   | 2000     | IFCP = IPAR                                                        | YAQUI1 | 01196 |
| 144   |          | NPMT = JOLD * 0                                                    | YAQUI1 | 01197 |
| 145   | 2010     | CALL ECRD IAASC,IECP,LPB,NEI                                       | YAQUI1 | 01198 |
| 146   |          | KP = 1                                                             | YAQUI1 | 01199 |
| 147   | 2020     | XTE = XPARIKP1                                                     | YAQUI1 | 01200 |
| 148   |          | YTE = YPARIKP1                                                     | YAQUI1 | 01201 |
| 149   |          | DRAG = MPARIKP1                                                    | YAQUI1 | 01202 |
| 150   |          | I = XTE *RPDR + OPEM10                                             | YAQUI1 | 01203 |
| 151   |          | J = IYTE-PYBI*RPDZ + OPEM10                                        | YAQUI1 | 01204 |

| INDEX | 01/12/73 | SUBROUTINE PARTMOV                                                        | PAGE   | 71    |
|-------|----------|---------------------------------------------------------------------------|--------|-------|
| 152   |          | IF (J,LT,1 .OR. J,GT,JRP .OR. I,LT,1 .OR. I,GT,I8P) GO TO 2180            | YAQUI1 | 01205 |
| 153   |          | IF (J,EQ,JOLD) GO TO 2030                                                 | YAQUI1 | 01206 |
| 154   |          | JOLD = J + IM0ME3                                                         | YAQUI1 | 01207 |
| 155   |          | IEC = J*NQI                                                               | YAQUI1 | 01208 |
| 156   |          | CALL ECRO (AASC(ISC2),IEC,NQI2,NE)                                        | YAQUI1 | 01209 |
| 157   | 2030     | IJ = (I-1)*NQ+ISC2                                                        | YAQUI1 | 01210 |
| 158   |          | IPJ = IJ*NQ                                                               | YAQUI1 | 01211 |
| 159   |          | IJP = IJ*NQI                                                              | YAQUI1 | 01212 |
| 160   |          | TPJP = IPJ * NQI                                                          | YAQUI1 | 01213 |
| 161   |          | W = XTE - FLOAT(I-1)*PDR                                                  | YAQUI1 | 01214 |
| 162   |          | H = (YTE-PY81 - FLOAT(J-1)*PDZ                                            | YAQUI1 | 01215 |
| 163   |          | PDRMW = PDR-W                                                             | YAQUI1 | 01216 |
| 164   |          | P0ZMH = P0Z-H                                                             | YAQUI1 | 01217 |
| 165   |          | X1 = PDRMW*P0ZMH                                                          | YAQUI1 | 01218 |
| 166   |          | X2 = W*P0ZMH                                                              | YAQUI1 | 01219 |
| 167   |          | X3 = PDRMW* H                                                             | YAQUI1 | 01220 |
| 168   |          | X4 = W* H                                                                 | YAQUI1 | 01221 |
| 169   |          | UK = (PU(IJ)*X1 + PU(IPJ)*X2 + PU(IJP)*X3 + PU(IPJP)*X4) * RPDRDZ         | YAQUI1 | 01222 |
| 170   |          | VK = (PV(IJ)*X1 + PV(IPJ)*X2 + PV(IJP)*X3 + PV(IPJP)*X4) * RPDRDZ         | YAQUI1 | 01223 |
| 171   |          | UPAR = SHIFT(XTE,30)                                                      | YAQUI1 | 01224 |
| 172   |          | VPAR = SHIFT(YTE,30)                                                      | YAQUI1 | 01225 |
| 173   |          | DTDRAG = DT*DRAG                                                          | YAQUI1 | 01226 |
| 174   |          | RDTDRG = 1./(1.+0TDRAG)                                                   | YAQUI1 | 01227 |
| 175   |          | URAND = VRAND = 0.0                                                       | YAQUI1 | 01228 |
| 176   |          | UPAR = (UPAR + DTDRAG*(UK+URAND) + DTGR) * RDTDRG                         | YAQUI1 | 01229 |
| 177   |          | VPAR = (VPAR + DTDRAG*(VK+VRAND) + DTGZP) * RDTDRG                        | YAQUI1 | 01230 |
| 178   |          | XTE = XTE + DT*UPAR                                                       | YAQUI1 | 01231 |
| 179   |          | YTE = YTE + DT*VPAR                                                       | YAQUI1 | 01232 |
| 180   |          | USH = SHIFT(UPAR,30).AND,7777777778                                       | YAQUI1 | 01233 |
| 181   |          | VSH = SHIFT(VPAR,30).AND,7777777778                                       | YAQUI1 | 01234 |
| 182   |          | XPAR(KP) = (XTE.AND,.NOT,7777777778) .OR. USH                             | YAQUI1 | 01235 |
| 183   |          | YPAR(KP) = (YTE.AND,.NOT,7777777778) .OR. VSH                             | YAQUI1 | 01236 |
| 184   |          | IF (TM0MX.EQ,0) GO TO 2150                                                | YAQUI1 | 01237 |
| 185   |          | MTE = SHIFT(DRAG,30)                                                      | YAQUI1 | 01238 |
| 186   |          | H = MTE*RPDRDZ*DTDRAG                                                     | YAQUI1 | 01239 |
| 187   |          | KIJ = IJ                                                                  | YAQUI1 | 01240 |
| 188   |          | KK = 0                                                                    | YAQUI1 | 01241 |
| 189   |          | DO 2149 JJ=1,2                                                            | YAQUI1 | 01242 |
| 190   |          | OO 2139 II=1,2                                                            | YAQUI1 | 01243 |
| 191   |          | KK = KK+1                                                                 | YAQUI1 | 01244 |
| 192   |          | XI = X1(KK)*H                                                             | YAQUI1 | 01245 |
| 193   |          | PUL = PU(KIJ)                                                             | YAQUI1 | 01246 |
| 194   |          | PVL = PV(KIJ)                                                             | YAQUI1 | 01247 |
| 195   |          | XX = (SHIFT(PUL,30))*X1*(UK-UPAR+URAND)                                   | YAQUI1 | 01248 |
| 196   |          | YY = (SHIFT(PVL,30))*X1*(VK-VPAR+VRAND)                                   | YAQUI1 | 01249 |
| 197   |          | PU(KIJ) = (PUL.AND,.NOT,7777777778) .OR.<br>(SHIFT(XX,30).AND,7777777778) | YAQUI1 | 01250 |
| 198   |          | PV(KIJ) = (PVL.AND,.NOT,7777777778) .OR.<br>(SHIFT(YY,30).AND,7777777778) | YAQUI1 | 01251 |
| 199   | 2139     | KIJ = KIJ,NQ                                                              | YAQUI1 | 01252 |
| 200   | 2149     | KIJ = IJP                                                                 | YAQUI1 | 01253 |
| 201   |          | CALL ECWR (AASC(ISC2),IEC,NQI2,NE)                                        | YAQUI1 | 01254 |
| 202   | 2150     | NPMT = NPMT+1                                                             | YAQUI1 | 01255 |
| 203   |          | IF (NPMT.EQ,NPT) GO TO 2190                                               | YAQUI1 | 01258 |
| 204   |          | KP = KP+3                                                                 | YAQUI1 | 01259 |
| 205   |          | IF (KP,LT,LPR) GO TO 2020                                                 | YAQUI1 | 01260 |
| 206   |          | CALL ECWR (AASC,IECP,LPR,NE)                                              | YAQUI1 | 01261 |
| 207   |          | IECP = IECP-LPR                                                           | YAQUI1 | 01262 |

| INDEX | 01/12/73 | SUBROUTINE PARTMOV                               | PAGE   | 72    |
|-------|----------|--------------------------------------------------|--------|-------|
| 208   |          | GO TO 2010                                       | YAQUI1 | 01263 |
| 209   | 2180     | XPAR(KP) = -1.E+3                                | YAQUI1 | 01264 |
| 210   |          | GO TO 2150                                       | YAQUI1 | 01265 |
| 211   | 2190     | CALL ECWR (AASC,IECP,LP8,NE)                     | YAQUI1 | 01266 |
| 212   | 2500     | IF (I40MX.EQ.0) RETURN                           | YAQUI1 | 01267 |
| 213   |          | ON 2599 J=2,JP2                                  | YAQUI1 | 01268 |
| 214   |          | IEC = (J-1)*NQI                                  | YAQUI1 | 01269 |
| 215   |          | CALL ECRD (AASC,IEC,NQI,NE)                      | YAQUI1 | 01270 |
| 216   |          | IJ = 1                                           | YAQUI1 | 01271 |
| 217   |          | ON 2589 I=1,IP1                                  | YAQUI1 | 01272 |
| 218   |          | IF (X(IJ).GT.PXRP .OR. Y(IJ).LT.PY8M) GO TO 2599 | YAQUI1 | 01273 |
| 219   |          | IF (Y(IJ).GT.PYTP) RETURN                        | YAQUI1 | 01274 |
| 220   |          | KI = X(IJ) *RPDR + OPEM10                        | YAQUI1 | 01275 |
| 221   |          | KJ = (Y(IJ)-PYR)*RPDZ + OPEM10                   | YAQUI1 | 01276 |
| 222   |          | IECP = KJ*NQI                                    | YAQUI1 | 01277 |
| 223   |          | CALL FCRD (AASC(ISC2),IECP,NQI2,NE)              | YAQUI1 | 01278 |
| 224   |          | KIJ = (KI-1)*NQ+ISC2                             | YAQUI1 | 01279 |
| 225   |          | KIJP = KIJ*NQI                                   | YAQUI1 | 01280 |
| 226   |          | W = X(IJ) - FLOAT(KI-1)*PDR                      | YAQUI1 | 01281 |
| 227   |          | H = (Y(IJ)-PY8) - FLOAT(KJ-1)*PDZ                | YAQUI1 | 01282 |
| 228   |          | HTE = PDZ-H                                      | YAQUI1 | 01283 |
| 229   |          | ON 2549 JJ=1,2                                   | YAQUI1 | 01284 |
| 230   |          | WTE = PDR-W                                      | YAQUI1 | 01285 |
| 231   |          | ON 2539 II=1,2                                   | YAQUI1 | 01286 |
| 232   |          | XX = RPDRDZ*WTE*HTE*PH0(KIJ)                     | YAQUI1 | 01287 |
| 233   |          | U(IJ) = U(IJ) -XX*(SHIFT(PU(KTJ),30))            | YAQUI1 | 01288 |
| 234   |          | V(IJ) = V(IJ) -XX*(SHIFT(PV(KIJ),30))            | YAQUI1 | 01289 |
| 235   |          | WTE = W                                          | YAQUI1 | 01290 |
| 236   | 2539     | KTJ = KIJ*NQ                                     | YAQUI1 | 01291 |
| 237   |          | HTE = H                                          | YAQUI1 | 01292 |
| 238   | 2549     | KTJ = KIJP                                       | YAQUI1 | 01293 |
| 239   | 2589     | IJ = TJ*NQ                                       | YAQUI1 | 01294 |
| 240   | 2599     | CALL ECWR (AASC,IEC,NQI,NE)                      | YAQUI1 | 01295 |
| 241   |          | RETURN                                           | YAQUI1 | 01296 |
| 242   |          | ENTRY PARPLOT                                    | YAQUI1 | 01297 |
| 243   |          | CALL ADV(1)                                      | YAQUI1 | 01298 |
| 244   |          | CALL FRAME (IPXL,IPXR,IPYT,IPY8)                 | YAQUI1 | 01299 |
| 245   |          | CALL FRAME (IPXL,IPXR,IPYT,IPY8)                 | YAQUI1 | 01300 |
| 246   |          | IF (LPR.EQ.0) GO TO 3000                         | YAQUI1 | 01301 |
| 247   |          | CALL LINCNT(59)                                  | YAQUI1 | 01302 |
| 248   |          | WRITE (12,3090) PDR,PDZ,PXR,PYR,PYT              | YAQUI1 | 01303 |
| 249   |          | WRITE (12,3095) JNM,NAME,T,NCYC                  | YAQUI1 | 01304 |
| 250   | 3000     | IECP = IPAR                                      | YAQUI1 | 01305 |
| 251   |          | IF (ICOLOR.GT.0) CALL COLOR(1)                   | YAQUI1 | 01306 |
| 252   |          | IF (ICOLOR.GT.0) CALL COLOR(1)                   | YAQUI1 | 01307 |
| 253   |          | NPPT = 0                                         | YAQUI1 | 01308 |
| 254   | 3010     | CALL ECRD (AASC,IECP,LP8,NE)                     | YAQUI1 | 01309 |
| 255   |          | KP = 1                                           | YAQUI1 | 01310 |
| 256   | 3020     | IF (XPAR(KP).LT.0.1) GO TO 3050                  | YAQUI1 | 01311 |
| 257   |          | IX1 = FIPXL + (XPAR(KP)-PXL)*PXCONV              | YAQUI1 | 01312 |
| 258   |          | IY1 = FIPY8 + (YPAR(KP)-PYR)*PYCONV              | YAQUI1 | 01313 |
| 259   |          | CALL PLT (IX1,IY1,42)                            | YAQUI1 | 01314 |
| 260   | 3050     | NPPT = NPPT + 1                                  | YAQUI1 | 01315 |
| 261   |          | IF (NPPT.FQ.NPT) GO TO 3060                      | YAQUI1 | 01316 |
| 262   |          | KP = KP+3                                        | YAQUI1 | 01317 |
| 263   |          | IF (KP.LT.LP8) GO TO 3020                        | YAQUI1 | 01318 |
| 264   |          | IECP = IECP+LP8                                  | YAQUI1 | 01319 |
| 265   |          | GO TO 3010                                       | YAQUI1 | 01320 |

| INDEX | 01/12/73 | SUBROUTINE PARTMOV                                           | PAGE   | 73    |
|-------|----------|--------------------------------------------------------------|--------|-------|
| 266   | 3060     | IF (ICOLOR.GT.0) CALL COLOR(0)                               | YAQUI1 | 01321 |
| 267   |          | RETURN                                                       | YAQUI1 | 01322 |
|       |          | C                                                            | YAQUI1 | 01323 |
| 268   | 3090     | FORMAT(4 PARTICLES*/11X*PDR=*IPE12.5* PDZ=*E12.5* PXR=*E12.5 | YAQUI1 | 01324 |
|       |          | 1 * PYR=*E12.5* PYT=*E12.5)                                  | YAQUI1 | 01325 |
| 269   | 3095     | FORMAT(5X,A10,10AR* T=*IPE12.5* CYCLE=*T5)                   | YAQUI1 | 01326 |
| 270   |          | END                                                          | YAQUI1 | 01327 |

INDEX 01/12/73  
SINGLY REFERENCED VARIABLES

SUBROUTINE PARTMOV

PAGE 74

|             |       |       |       |      |      |        |      |     |        |        |     |       |         |     |        |       |       |       |    |     |
|-------------|-------|-------|-------|------|------|--------|------|-----|--------|--------|-----|-------|---------|-----|--------|-------|-------|-------|----|-----|
| 1200 - 63*  | DT0C  | ()R   | 3C0   | FIYT | -R   | 3C0    | ISC3 | -I  | 3C0    | LINCNT | =   | 247SU | OMEM10  | -R  | 3C0    | THIR0 | -R    | 3C0   |    |     |
| 1300 - 97*  | DT016 | -R    | 3C0   | FJRP | -R   | 3C0    | ITV  | -I  | 3C0    | LJP2   | -I  | 3C0   | PARPLOT | =   | 242SU  | TLIMD | -R    | 3C0   |    |     |
| 2500 - 212* | DT02  | -R    | 3C0   | FREZ | -R   | 3C0    | IUNF | -I  | 3C0    | MR     | -R  | 5RL   | PARTMOV | =   | 1SU    | TOUT  | -R    | 3C0   |    |     |
| AA          | ()R   | 3C0   | DT04  | -R   | 3C0  | GGM1   | -R   | 3C0 | IXL    | -I     | 3C0 | MC    | -R      | 5RL | PLT    | =     | 259SU | TWFIN | -R | 3C0 |
| ADV         | =     | 243SU | DT08  | -R   | 3C0  | GMI    | -R   | 3C0 | IXR    | +I     | 3C0 | ML    | -R      | 5RL | RDT    | -R    | 3C0   | TZ0MD | -R | 3C0 |
| ANC         | -R    | 3C0   | DTPOS | -R   | 3C0  | GR     | -R   | 3C0 | IYR    | -I     | 3C0 | MR    | -R      | 5RL | REAL   | =     | 5F    | VV    | -R | 3C0 |
| ASQ         | -R    | 3C0   | DTV   | -R   | 3C0  | GR0VEL | -R   | 3C0 | IYT    | -I     | 3C0 | MY    | -R      | 5RL | REZRON | +R    | 3C0   | XCONV | -R | 3C0 |
| A0          | -R    | 3C0   | DT8   | -R   | 3C0  | GZ     | -R   | 3C0 | JRAR   | -I     | 3C0 | MU02  | -R      | 5RL | REZSIE | -R    | 3C0   | XL    | -R | 3C0 |
| A0FAC       | -R    | 3C0   | D7    | -R   | 3C0  | GZP    | -R   | 3C0 | JCEN   | -I     | 3C0 | MU04  | -R      | 5RL | REZUE  | -R    | 3C0   | XR    | -R | 3C0 |
| A0M         | -R    | 3C0   | EM10  | -R   | 3C0  | IRAR   | -I   | 3C0 | JM10   | -I     | 3C0 | NLC   | -I      | 3C0 | REZVE  | -R    | 3C0   | Y8    | -R | 3C0 |
| RD          | -R    | 3C0   | ENTRY | =    | 247F | IDT0   | -T   | 3C0 | JM14   | +I     | 3C0 | NPS   | -I      | 3C0 | REZVT  | -R    | 3C0   | YCONV | -R | 3C0 |
| COLAMU      | -R    | 3C0   | EPS   | -R   | 3C0  | IJM    | -T   | 3C0 | JP1    | -I     | 3C0 | NOIB  | -I      | 3C0 | REZY0  | -R    | 3C0   | YSC1  | =  | 2CN |
| CYL         | -R    | 3C0   | FIBP  | -R   | 3C0  | IJPS   | -I   | 3C0 | JP4    | -I     | 3C0 | NSC   | -I      | 3C0 | RIRAR  | -R    | 3C0   | YSC2  | =  | 3CN |
| DR          | -R    | 3C0   | FIPXR | -R   | 3C0  | TM1    | -T   | 3C0 | JP402  | -I     | 3C0 | NUMIT | -I      | 3C0 | RIRJB  | -R    | 3C0   | YSC3  | =  | 4CN |
| DTC         | -R    | 3C0   | FIPYT | -R   | 3C0  | IM6    | -I   | 3C0 | JUNF   | -I     | 3C0 | NUMTD | -I      | 3C0 | RIRP   | -R    | 3C0   | YT    | -R | 3C0 |
| DTFAC       | -R    | 3C0   | FIXL  | -R   | 3C0  | IP2    | -I   | 3C0 | JUNF02 | -I     | 3C0 | OM    | -R      | 3C0 | RJBP   | -R    | 3C0   | ZZ    | -R | 3C0 |
| DTGZ        | -R    | 3C0   | FIXR  | -R   | 3C0  | TSCF1  | -I   | 3C0 | KX1    | -I     | 3C0 | OMANC | -R      | 3C0 | ROMFR  | -R    | 3C0   |       |    |     |
| DT0         | ()R   | 3C0   | FIYA  | -R   | 3C0  | TSCF2  | -I   | 3C0 | LAMD   | -R     | 5RL | OMCYL | -R      | 3C0 | RON    | -R    | 3C0   |       |    |     |

MULTIPLY-REFERENCED VARIABLES

|        |       |      |      |
|--------|-------|------|------|
| 1009 - | 1200  | 14*  |      |
| 1019 - | 1100  | 16*  |      |
| 1039 - | 3700  | 43*  |      |
| 1049 - | 3500  | 45*  |      |
| 1089 - | 2200  | 47*  |      |
| 1099 - | 1800  | 23   | 48*  |
| 1100 - | 24    | 49*  |      |
| 1189 - | 5700  | 59*  |      |
| 1199 - | 5100  | 61*  |      |
| 1210 - | 72*   | 77   |      |
| 1220 - | 75    | 78*  |      |
| 1230 - | 73    | 80*  | 85   |
| 1240 - | 83    | 86*  |      |
| 1250 - | 81    | 88*  |      |
| 1289 - | 6600  | 67   | 93*  |
| 1299 - | 6500  | 95*  |      |
| 1310 - | 108*  | 114  |      |
| 1320 - | 112   | 115* |      |
| 1330 - | 109   | 117* | 123  |
| 1340 - | 121   | 124* |      |
| 1350 - | 118   | 126* |      |
| 1389 - | 10100 | 102  | 131* |
| 1399 - | 9700  | 132* |      |
| 1400 - | 63    | 133* |      |
| 1489 - | 13600 | 139* |      |
| 1499 - | 13500 | 141* |      |
| 2000 - | 131   | 143* |      |
| 2010 - | 145*  | 208  |      |
| 2020 - | 147*  | 205  |      |
| 2030 - | 153   | 157* |      |
| 2139 - | 19000 | 199* |      |
| 2149 - | 18900 | 200* |      |
| 2150 - | 184   | 202* | 210  |
| 2180 - | 152   | 209* |      |
| 2190 - | 203   | 211* |      |
| 2539 - | 23100 | 236* |      |
| 2549 - | 22900 | 238* |      |





| PU     | INDEX | 01/12/73 | 60I   | 56=   | 58=   | SUBROUTINE | PARTMOV | 102   | 115   | 124   | 129=  | 137=  | PAGE 77 | 137 | 169 | 169 | 169 | 169 |
|--------|-------|----------|-------|-------|-------|------------|---------|-------|-------|-------|-------|-------|---------|-----|-----|-----|-----|-----|
|        | ()R   | 4EQ      | 60I   | 56=   | 58=   | 7R         | 86      | 91=   | 102   | 115   | 124   | 129=  | 137=    | 137 | 169 | 169 | 169 | 169 |
| PUR    | -R    | 193      | 197=  | 233   |       |            |         |       |       |       |       |       |         |     |     |     |     |     |
| PUL    | -R    | 104=     | 115=  | 129   |       |            |         |       |       |       |       |       |         |     |     |     |     |     |
| PUR    | -R    | 69=      | 78=   | 91    | 193=  | 195        | 197     |       |       |       |       |       |         |     |     |     |     |     |
| PUR    | -R    | 69=      | 86=   | 91    |       |            |         |       |       |       |       |       |         |     |     |     |     |     |
| PUR    | -R    | 104=     | 124=  | 129   |       |            |         |       |       |       |       |       |         |     |     |     |     |     |
| PVT    | ()R   | 4EQ      | 60I   | 57=   | 79    | 87         | 92=     | 102   | 116   | 125   | 130=  | 138=  | 138     | 170 | 170 | 170 | 170 | 194 |
| PVR    | -R    | 198=     | 234   |       |       |            |         |       |       |       |       |       |         |     |     |     |     |     |
| PVL    | -R    | 104=     | 116=  | 130   |       |            |         |       |       |       |       |       |         |     |     |     |     |     |
| PVL    | -R    | 69=      | 79=   | 92    | 194=  | 196        | 198     |       |       |       |       |       |         |     |     |     |     |     |
| PVR    | -R    | 69=      | 87=   | 92    |       |            |         |       |       |       |       |       |         |     |     |     |     |     |
| PVT    | -R    | 104=     | 125=  | 130   |       |            |         |       |       |       |       |       |         |     |     |     |     |     |
| PXCONV | -R    | 3C0      | 257   |       |       |            |         |       |       |       |       |       |         |     |     |     |     |     |
| PXL    | -R    | 3C0      | 257   |       |       |            |         |       |       |       |       |       |         |     |     |     |     |     |
| PXR    | -R    | 3C0      | 248WR |       |       |            |         |       |       |       |       |       |         |     |     |     |     |     |
| PXRP   | -R    | 3C0      | 23    | 218   |       |            |         |       |       |       |       |       |         |     |     |     |     |     |
| PYA    | -R    | 3C0      | 76    | 32    | 151   | 162        | 221     | 227   | 248WR | 25R   |       |       |         |     |     |     |     |     |
| PYAM   | -R    | 3C0      | 23    | 218   |       |            |         |       |       |       |       |       |         |     |     |     |     |     |
| PYCONV | -R    | 3C0      | 25R   |       |       |            |         |       |       |       |       |       |         |     |     |     |     |     |
| PYT    | -R    | 3C0      | 248WR |       |       |            |         |       |       |       |       |       |         |     |     |     |     |     |
| PYTP   | -R    | 3C0      | 24    | 219   |       |            |         |       |       |       |       |       |         |     |     |     |     |     |
| Q      | ()R   | 4EQ      | 60I   |       |       |            |         |       |       |       |       |       |         |     |     |     |     |     |
| R      | ()R   | 4EQ      | 60I   |       |       |            |         |       |       |       |       |       |         |     |     |     |     |     |
| RCSQ   | ()R   | 4EQ      | 60I   |       |       |            |         |       |       |       |       |       |         |     |     |     |     |     |
| RTDRG  | -R    | 174=     | 176   | 177   |       |            |         |       |       |       |       |       |         |     |     |     |     |     |
| RETURN | -     | 212F     | 219F  | 241F  | 267F  |            |         |       |       |       |       |       |         |     |     |     |     |     |
| RM     | ()R   | 4EQ      | 60I   | 33    |       |            |         |       |       |       |       |       |         |     |     |     |     |     |
| RMP    | ()R   | 4EQ      | 60I   |       |       |            |         |       |       |       |       |       |         |     |     |     |     |     |
| RO     | ()R   | 4EQ      | 60I   |       |       |            |         |       |       |       |       |       |         |     |     |     |     |     |
| ROL    | ()R   | 4EQ      | 60I   |       |       |            |         |       |       |       |       |       |         |     |     |     |     |     |
| RPRR   | -R    | 3C0      | 25    | 150   | 220   |            |         |       |       |       |       |       |         |     |     |     |     |     |
| RPRRZ  | -R    | 3C0      | 33    | 169   | 170   | 186        | 232     |       |       |       |       |       |         |     |     |     |     |     |
| RPOZ   | -R    | 3C0      | 26    | 151   | 221   |            |         |       |       |       |       |       |         |     |     |     |     |     |
| RPMO   | -R    | 53=      | 54    | 54=   | 54    | 55         | 56      | 57    |       |       |       |       |         |     |     |     |     |     |
| RVOL   | ()R   | 4EQ      | 60I   |       |       |            |         |       |       |       |       |       |         |     |     |     |     |     |
| SHIFT  | -     | 171SU    | 172SU | 180SU | 181SU | 185SU      | 195SU   | 196SU | 197SU | 198SU | 233SU | 234SU |         |     |     |     |     |     |
| SIE    | ()R   | 4EQ      | 60I   |       |       |            |         |       |       |       |       |       |         |     |     |     |     |     |
| START  | -     | 10SU     | 49SU  | 64SU  | 134SU |            |         |       |       |       |       |       |         |     |     |     |     |     |
| T      | -R    | 3C0      | 249WR |       |       |            |         |       |       |       |       |       |         |     |     |     |     |     |
| U      | ()R   | 4EQ      | 60I   | 39    | 233=  | 233        |         |       |       |       |       |       |         |     |     |     |     |     |
| UG     | ()R   | 4EQ      | 60I   |       |       |            |         |       |       |       |       |       |         |     |     |     |     |     |
| UK     | -R    | 169=     | 176   | 195   |       |            |         |       |       |       |       |       |         |     |     |     |     |     |
| UL     | ()R   | 4EQ      | 60I   |       |       |            |         |       |       |       |       |       |         |     |     |     |     |     |
| UP     | ()R   | 4EQ      | 60I   |       |       |            |         |       |       |       |       |       |         |     |     |     |     |     |
| UPAR   | -R    | 171=     | 176=  | 176   | 178   | 180        | 195     |       |       |       |       |       |         |     |     |     |     |     |
| VRAND  | -R    | 175=     | 176   | 195   |       |            |         |       |       |       |       |       |         |     |     |     |     |     |
| USH    | -R    | 180=     | 182   |       |       |            |         |       |       |       |       |       |         |     |     |     |     |     |
| VITIL  | ()R   | 4EQ      | 60I   |       |       |            |         |       |       |       |       |       |         |     |     |     |     |     |
| V      | ()R   | 4EQ      | 60I   | 40    | 234=  | 234        |         |       |       |       |       |       |         |     |     |     |     |     |
| VG     | ()R   | 4EQ      | 60T   |       |       |            |         |       |       |       |       |       |         |     |     |     |     |     |
| VK     | -R    | 170=     | 177   | 196   |       |            |         |       |       |       |       |       |         |     |     |     |     |     |
| VL     | ()R   | 4EQ      | 60I   |       |       |            |         |       |       |       |       |       |         |     |     |     |     |     |
| VP     | ()R   | 4EQ      | 60I   |       |       |            |         |       |       |       |       |       |         |     |     |     |     |     |
| VPAR   | -R    | 172=     | 177=  | 177   | 179   | 181        | 196     |       |       |       |       |       |         |     |     |     |     |     |
| VRAND  | -R    | 175=     | 177   | 196   |       |            |         |       |       |       |       |       |         |     |     |     |     |     |
| VSH    | -R    | 181=     | 183   |       |       |            |         |       |       |       |       |       |         |     |     |     |     |     |
| VITIL  | ()R   | 4EQ      | 60I   |       |       |            |         |       |       |       |       |       |         |     |     |     |     |     |
| W      | -R    | 31=      | 36    | 42    | 161=  | 163        | 166     | 168   | 226=  | 230   | 235   |       |         |     |     |     |     |     |

|       | INDEX | 01/12/73 | SUBROUTINE PARTNOV |      |      |      |      |     |     |      |     |     | PAGE 78 |     |     |     |
|-------|-------|----------|--------------------|------|------|------|------|-----|-----|------|-----|-----|---------|-----|-----|-----|
|       |       | 248F     | 249F               |      |      |      |      |     |     |      |     |     |         |     |     |     |
| WRITE | =     |          |                    |      |      |      |      |     |     |      |     |     |         |     |     |     |
| WTR   | -R    | 127=     | 129                | 130  |      |      |      |     |     |      |     |     |         |     |     |     |
| WTE   | -R    | 36=      | 38                 | 42=  | 230= | 232  | 235= |     |     |      |     |     |         |     |     |     |
| WTL   | -R    | 89=      | 91                 | 92   |      |      |      |     |     |      |     |     |         |     |     |     |
| WTR   | -R    | 90=      | 91                 | 92   |      |      |      |     |     |      |     |     |         |     |     |     |
| WTT   | -R    | 12R=     | 129                | 130  |      |      |      |     |     |      |     |     |         |     |     |     |
| X     | ()R   | 4EQ      | 60I                | 23   | 25   | 3i   | 218  | 220 | 226 |      |     |     |         |     |     |     |
| XPAR  | ()R   | 4EQ      | 60I                | 147  | 1A2= | 209= | 256  | 257 |     |      |     |     |         |     |     |     |
| XTE   | -R    | 147=     | 150                | 161  | 171  | 17A= | 178  | 1A2 |     |      |     |     |         |     |     |     |
| XWA   | -R    | 105=     | 113=               | 113  | 126  | 12A  |      |     |     |      |     |     |         |     |     |     |
| XWL   | -R    | 70=      | 76=                | 76   | 8A   | 90   |      |     |     |      |     |     |         |     |     |     |
| XWR   | -R    | 70=      | 84=                | 84   | 8B   | 80   |      |     |     |      |     |     |         |     |     |     |
| XWT   | -R    | 105=     | 122=               | 122  | 176  | 127  |      |     |     |      |     |     |         |     |     |     |
| XX    | -R    | 33=      | 3A                 | 195= | 197  | 232= | 233  | 234 |     |      |     |     |         |     |     |     |
| X1    | ()R   | 7DI      | 8EQ                | 8EQ  | 8EQ  | 3A=  | 39   | 40  | 41  | 165= | 169 | 170 | 192=    | 192 | 195 | 196 |
| X2    | -R    | 8EQ      | 166=               | 169  | 170  |      |      |     |     |      |     |     |         |     |     |     |
| X3    | -R    | 8EQ      | 167=               | 169  | 170  |      |      |     |     |      |     |     |         |     |     |     |
| X4    | -R    | 8EQ      | 16A=               | 169  | 170  |      |      |     |     |      |     |     |         |     |     |     |
| Y     | ()R   | 4EQ      | 60I                | 23   | 24   | 32   | 218  | 219 | 221 | 227  |     |     |         |     |     |     |
| YPAR  | ()R   | 4EQ      | 60I                | 148  | 1A3= | 25A  |      |     |     |      |     |     |         |     |     |     |
| YTE   | -R    | 14R=     | 151                | 162  | 172  | 179= | 179  | 183 |     |      |     |     |         |     |     |     |
| YY    | -R    | 196=     | 19A                |      |      |      |      |     |     |      |     |     |         |     |     |     |



| INDEX | 01/12/73 | SUBROUTINE REZONE                                               | PAGE 79       |
|-------|----------|-----------------------------------------------------------------|---------------|
| 1     |          | SUBROUTINE REZONE                                               | YAQUII 01328  |
| 2     |          | COMMON /YSC1/ AASC(4242)                                        | COMMON2 00002 |
| 3     |          | COMMON /YSC2/ AA(1),ANC,ASQ,A0,A0FAC,A0M,R0,COLAMU,CYL,         | COMMON2 00003 |
| 1     |          | DR,DT,DTC,DTFAC,DTGR,DTGZ,DTGZP,DT0(10),DT0C(10),               | COMMON2 00004 |
| 2     |          | DT016,DT02,DT04,DT08,DTPOS,DTV,DTA,ZZ,EM10,EPS,F1BP,            | COMMON2 00005 |
| 3     |          | FIPXL,FIPXR,FIPYB,FIPYT,FXL,FXR,FIYB,FIYT,FJRP,                 | COMMON2 00006 |
| 4     |          | FREZ,GGM1,GM1,GR,GROVEL,GZ,GZP,I,IRAR,IBP,IBP1,ICOLOR,          | COMMON2 00007 |
| 5     |          | IDT0,IJ,IJM,IJP,IJPS,IMOME3,IMOMX,TM1,IM6,                      | COMMON2 00008 |
| 6     |          | IPAR,IPXL,IPXR,IPYR,IPYT,IP1,IP2,ISCF1,ISCF2,ISCF3,             | COMMON2 00009 |
| 7     |          | ITV,IUNF,IXL,IXR,IYB,IYT,J,JRAR,JRP,JBP2,JCEN,JM10,             | COMMON2 00010 |
| 8     |          | JM14,JP1,JP2,JP4,JP402,JUNF,JUNFN2,XXI,LAM,LJP2,LPR,            | COMMON2 00011 |
| 9     |          | LPR,MU,NAME(10),NCYC,NLC,NPS,NPT,NO,NQ1,NQTR,NQI2,NSC,          | COMMON2 00012 |
| 1     |          | NUMTT,NUMTD,OM,OMANC,OMCYL,OMEM10,OPEM10,POR,P0Z,PXCONV,        | COMMON2 00013 |
| 2     |          | PXL,PXR,PXRP,PYB,PYB,M,PYCONV,PYT,PYTP,ROZ,REZRON,REZSIE,       | COMMON2 00014 |
| 3     |          | REZUE,REZVE,REZVT,REZY0,RIBAR,RIBJH,RIRP,RJRP,ROMFR,            | COMMON2 00015 |
| 4     |          | RON,RPOR,RpDRDZ,RPOZ,T,THIRD,TLIMD,FOUT,TWFIN,TZ0MD,            | COMMON2 00016 |
| 5     |          | VV,XCONV,XL,XR,YB,YCONV,YT,ZZ                                   | COMMON2 00017 |
| 4     |          | EQUIVALENCE (AASC(1),X,XPAR),(AASC(2),R,YPAR),(AASC(3),Y,MPAR), | EQVREAL 00002 |
| 1     |          | (AASC(4),U,UG,DELSM),(AASC(5),V,VG1),(AASC(6),R0),              | EQVREAL 00003 |
| 2     |          | (AASC(7),SIE,MP,RMP,RCSQ),(AASC(8),E,ETIL),                     | EQVREAL 00004 |
| 3     |          | (AASC(9),RVOL),(AASC(10),M,RM,VP),(AASC(11),P,PL,EP,            | EQVREAL 00005 |
| 4     |          | UP,PM0),(AASC(12),UTIL,UL,CQ,PHX,PU),(AASC(13),VTIL,            | EQVREAL 00006 |
| 5     |          | VL,PMY,PV),(AASC(14),Q,ROL)                                     | EQVREAL 00007 |
| 5     |          | REAL LAM,LAMD,M,MR,MC,ML,MP,MPAR,MR,MT,MTE,MU,MUO2,MUD4         | EQVREAL 00008 |
| 6     |          | DIMENSION X(I),XPAR(1),R(1),YPAR(1),Y(1),MPAR(1),U(1),UG(1),    | DIMEN 00002   |
| 1     |          | DELSM(1),V(1),VG(1),ROI(1),SIE(1),MP(1),RMP(1),RCSQ(1),         | DIMEN 00003   |
| 2     |          | E(1),ETIL(1),RVOL(1),M(1),RM(1),VP(1),P(1),PL(1),EP(1),         | DIMEN 00004   |
| 3     |          | UP(1),UTIL(1),UL(1),CQ(1),PMX(1),PU(1),VTIL(1),VL(1),           | DIMEN 00005   |
| 4     |          | PMY(1),PV(1),Q(1),ROL(1),PM0(1)                                 | DIMEN 00006   |
| 7     |          | DIMENSION UGTE(100)                                             | YAQUII 01332  |
| 8     |          | REZ0MG = 0.15*ROZ                                               | YAQUII 01333  |
| 9     |          | REZBTA = 0.002                                                  | YAQUII 01334  |
| 10    |          | XX = -1.E+6                                                     | YAQUII 01335  |
| 11    |          | CALL START                                                      | YAQUII 01336  |
| 12    |          | FCR = FCT = FCB = XXX = XMSUM = YMSUM = 0.                      | YAQUII 01337  |
| 13    |          | DO 1049 J=2,JP2                                                 | YAQUII 01338  |
| 14    |          | DO I039 I=1,TP1                                                 | YAQUII 01339  |
| 15    |          | AVEL = AMAX1(ABS(UL(IJ)),ABS(VL(IJ)))                           | YAQUII 01340  |
| 16    |          | XXX = AMAX1(XXX,AVEL)                                           | YAQUII 01341  |
| 17    |          | IF (I.EQ.IM6) FCR = AMAX1(FCR,AVEL)                             | YAQUII 01342  |
| 18    |          | IF (J.EQ.JM14) FCT = AMAX1(FCT,AVEL)                            | YAQUII 01343  |
| 19    |          | IF (J.EQ.9) FCB = AMAX1(FCB,AVEL)                               | YAQUII 01344  |
| 20    | I039     | IJ = TJ + NQ                                                    | YAQUII 01345  |
| 21    |          | CALL LOOP                                                       | YAQUII 01346  |
| 22    | 1049     | CONTINUE                                                        | YAQUII 01347  |
| 23    |          | FCR = SQRT(FCR*XXX)                                             | YAQUII 01348  |
| 24    |          | FCT = SQRT(FCT*XXX)                                             | YAQUII 01349  |
| 25    |          | FCB = SQRT(FCB*XXX)                                             | YAQUII 01350  |
| 26    |          | CALL START                                                      | YAQUII 01351  |
| 27    |          | DO 1069 J=2,JP1                                                 | YAQUII 01352  |
| 28    |          | IF (J.EQ.JP402) YCEN = Y(IJ)                                    | YAQUII 01353  |
| 29    |          | DO 1059 I=1,IBAR                                                | YAQUII 01354  |
| 30    |          | IPJ = IJ+NQ                                                     | YAQUII 01355  |
| 31    |          | IPJP = IJP+NQ                                                   | YAQUII 01356  |
| 32    |          | IF (J.LT.10.OR.J.GT.JM10.OR.I.GT.IM6) GO TO 1055                | YAQUII 01357  |
| 33    |          | X1 = X(IPJ)                                                     | YAQUII 01358  |
| 34    |          | Y1 = Y(IPJ)                                                     | YAQUII 01359  |
| 35    |          | U1 = U(IPJ)                                                     | YAQUII 01360  |

INOEK 01/2/73

SUBROUTINE REZONE

PAGE 80

|    |                                                |              |
|----|------------------------------------------------|--------------|
| 36 | V1 = VL(IPJ)                                   | YAQUI1 01361 |
| 37 | X2 = X(IPJP)                                   | YAQUI1 01362 |
| 38 | Y2 = Y(IPJP)                                   | YAQUI1 01363 |
| 39 | U2 = UL(IPJP)                                  | YAQUI1 01364 |
| 40 | V2 = VL(IPJP)                                  | YAQUI1 01365 |
| 41 | X3 = X(IJP)                                    | YAQUI1 01366 |
| 42 | Y3 = Y(IJP)                                    | YAQUI1 01367 |
| 43 | U3 = UL(IJP)                                   | YAQUI1 01368 |
| 44 | V3 = VL(IJP)                                   | YAQUI1 01369 |
| 45 | X4 = X(IJ)                                     | YAQUI1 01370 |
| 46 | Y4 = Y(IJ)                                     | YAQUI1 01371 |
| 47 | U4 = UL(IJ)                                    | YAQUI1 01372 |
| 48 | V4 = VL(IJ)                                    | YAQUI1 01373 |
| 49 | R1 = .125*RVOL(IJ)*R(IPJ)*R(IPJP)*R(IJP)*R(IJ) | YAQUI1 01374 |
| 50 | YY = R1*((U1+U4)*(X1-X4)+(V1+V4)*(Y1-Y4)       | YAQUI1 01375 |
|    | 1 * (U2+U1)*(X2-X1)+(V2+V1)*(Y2-Y1)            | YAQUI1 01376 |
|    | 2 * (U3+U2)*(X3-X2)+(V3+V2)*(Y3-Y2)            | YAQUI1 01377 |
|    | 3 * (U4+U3)*(X4-X3)+(V4+V3)*(Y4-Y3)            | YAQUI1 01378 |
| 51 | IF (YY.GT.0.) GO TO 1055                       | YAQUI1 01379 |
| 52 | YY = YY*YY                                     | YAQUI1 01380 |
| 53 | XOMSUM = XOMSUM + YY*X4                        | YAQUI1 01381 |
| 54 | YOMSUM = YOMSUM + YY*Y4                        | YAQUI1 01382 |
| 55 | OMSUM = OMSUM + YY                             | YAQUI1 01383 |
| 56 | 1055 IJ = IPJ                                  | YAQUI1 01384 |
| 57 | 1059 IJP = IPJP                                | YAQUI1 01385 |
| 58 | CALL LOOP                                      | YAQUI1 01386 |
| 59 | 1069 CONTINUE                                  | YAQUI1 01387 |
| 60 | XC = XOMSUM/OMSUM                              | YAQUI1 01388 |
| 61 | YC = YOMSUM/OMSUM                              | YAQUI1 01389 |
| 62 | REZVT = AMAX1(0.,(REZOMG*.5*(YC-YCEN)))        | YAQUI1 01390 |
| 63 | CALL START                                     | YAQUI1 01391 |
| 64 | DD 1099 J=2,JP2                                | YAQUI1 01392 |
| 65 | YBAR = .5*(Y(IJP)+Y(IJM))+REZHTA*(YC-Y(IJ))    | YAQUI1 01393 |
| 66 | VGTE = REZOMG*(YBAR-Y(IJ))+REZVT               | YAQUI1 01394 |
| 67 | IF (J.EQ.2) VGTE = -FCB                        | YAQUI1 01395 |
| 68 | IF (J.EQ.JP2) VGTE = FCT                       | YAQUI1 01396 |
| 69 | DD 1089 I=1,IP1                                | YAQUI1 01397 |
| 70 | IPJ = IJ+NQ                                    | YAQUI1 01398 |
| 71 | IF (J.GT.2) GO TO 1080                         | YAQUI1 01399 |
| 72 | XBAR = .5*(X(IPJ)+X(IJ-NQ))+REZHTA*(XC-X(IJ))  | YAQUI1 01400 |
| 73 | UGTE(I) = REZOMG*(XBAR-X(IJ))                  | YAQUI1 01401 |
| 74 | IF (I.EQ.1) UGTE = 0.0                         | YAQUI1 01402 |
| 75 | IF (I.EQ.IP1) UGTE(I) = FCR                    | YAQUI1 01403 |
| 76 | 1080 UG(IJ) = UGTE(I)                          | YAQUI1 01404 |
| 77 | VG(IJ) = VGTE                                  | YAQUI1 01405 |
| 78 | 1089 IJ = IPJ                                  | YAQUI1 01406 |
| 79 | CALL LOOP                                      | YAQUI1 01407 |
| 80 | 1099 CONTINUE                                  | YAQUI1 01408 |
| 81 | CALL DONE                                      | YAQUI1 01409 |
| 82 | 1200 CALL START                                | YAQUI1 01410 |
| 83 | XIP1 = YJP2 = 0.                               | YAQUI1 01411 |
| 84 | Y2 = .E*20                                     | YAQUI1 01412 |
| 85 | DD 1289 J=2,JP2                                | YAQUI1 01413 |
| 86 | DD 1279 I=1,IP1                                | YAQUI1 01414 |
| 87 | X(IJ) = X(IJ)+UG(IJ)*DT                        | YAQUI1 01415 |
| 88 | Y(IJ) = Y(IJ)+VG(IJ)*DT                        | YAQUI1 01416 |
| 89 | R(IJ) = X(IJ)*CYL+OMCYL                        | YAQUI1 01417 |
| 90 | IF (J.EQ.2) Y2 = AMIN1(Y(IJ)+Y2)               | YAQUI1 01418 |

| INDEX | 01/12/73 | SUBROUTINE REZONE                                            | PAGE   | 81    |
|-------|----------|--------------------------------------------------------------|--------|-------|
| 91    |          | IF (J.EQ.JP2) YJP2 = AMAX1(Y(IJ),YJP2)                       | YAQUI1 | 01419 |
| 92    |          | IF (I.EQ.IP1) XIP1 = AMAX1(X(IJ),XIP1)                       | YAQUI1 | 01420 |
| 93    | 1279     | IJ = IJ+NQ                                                   | YAQUI1 | 01421 |
| 94    |          | CALL LOOP                                                    | YAQUI1 | 01422 |
| 95    | 1289     | CONTINUE                                                     | YAQUI1 | 01423 |
| 96    |          | CALL DONE                                                    | YAQUI1 | 01424 |
| 97    |          | PQR = XIP1+RIBP                                              | YAQUI1 | 01425 |
| 98    |          | PDZ = (YJP2-Y2)*RJ8P                                         | YAQUI1 | 01426 |
| 99    |          | PY8 = 0.0                                                    | YAQUI1 | 01427 |
| 100   |          | CALL FILMCO                                                  | YAQUI1 | 01428 |
| 101   |          | CALL START                                                   | YAQUI1 | 01429 |
| 102   |          | YY = ARS(GZ)/(GM1+REZSIE)                                    | YAQUI1 | 01430 |
| 103   |          | DO 1399 J=2,JP1                                              | YAQUI1 | 01431 |
| 104   |          | DO 1389 I=1,IRAR                                             | YAQUI1 | 01432 |
| 105   |          | IPJ = IJ + NQ                                                | YAQUI1 | 01433 |
| 106   |          | IPJP = IJP + NQ                                              | YAQUI1 | 01434 |
| 107   |          | Y4 = REZY0 + 0.25*(Y(IJP)+Y(IPJP)+Y(IJ)+Y(IPJ))              | YAQUI1 | 01435 |
| 108   |          | IF (J.EQ.? ) ROL(IJM) = REZRON*EXP((Y4-Y(IJ) -Y(IPJ) )*YY)   | YAQUI1 | 01436 |
| 109   |          | IF (I.EQ.IRAR) ROL(IPJ) = REZRON*EXP((Y4-Y(IPJ)-Y(IPJP))*YY) | YAQUI1 | 01437 |
| 110   |          | IF (J.EQ.JP1 ) ROL(IJP) = REZRON*EXP((Y4-Y(IJP)+Y(IPJP))*YY) | YAQUI1 | 01438 |
| 111   |          | IJM = IJM + NQ                                               | YAQUI1 | 01439 |
| 112   |          | IJP = IJP + NQ                                               | YAQUI1 | 01440 |
| 113   | 1389     | IJ = TPJ                                                     | YAQUI1 | 01441 |
| 114   |          | CALL LOOP                                                    | YAQUI1 | 01442 |
| 115   | 1399     | CONTINUE                                                     | YAQUI1 | 01443 |
| 116   |          | CALL DONE                                                    | YAQUI1 | 01444 |
| 117   |          | RETURN                                                       | YAQUI1 | 01445 |
| 118   |          | END                                                          | YAQUI1 | 01446 |

INDEX 01/12/73  
 SINGLE REFERENCED VARIABLES

1200 - B2\* DT08 -R 3C0 GR -R 3C0 ITV -I 3C0 MR -R 5RL PXL -R 3C0 TLMD -R 3C0  
 AA (R) 3C0 DTP08 -R 3C0 GRDVEL -R 3C0 IUNF -I 3C0 MT -R 5RL PXR -R 3C0 TOUT -R 3C0  
 AMINI - 90SU 0TV -R 3C0 GZP -R 3C0 IXL -I 3C0 MTE -R 5RL PXR -R 3C0 TWFIN -R 3C0  
 ANC -R 3C0 0T8 -R 3C0 I8P -I 3C0 IXR -I 3C0 MU02 -R 5RL PYAM -R 3C0 T20MD -R 3C0  
 ASD -R 3C0 0Z -R 3C0 I8PI -I 3C0 IY8 -I 3C0 MU04 -R 5RL PYCONV -R 3C0 VV -R 3C0  
 A0 -R 3C0 EM10 -R 3C0 ICOLOR -I 3C0 TYT -I 3C0 NAME (I) 3C0 PYT -R 3C0 XCONV -R 3C0  
 AOFAC -R 3C0 EPS -R 3C0 IDT0 -I 3C0 JRAR -I 3C0 NCYC -I 3C0 PYTP -R 3C0 XL -R 3C0  
 AOM -R 3C0 EQUIVAL - 4F IJPS -I 3C0 JAP -I 3C0 NLC -I 3C0 REAL - 5F XR -R 3C0  
 B0 -R 3C0 FIBP -R 3C0 INOME3 -I 3C0 JAP2 -I 3C0 NPS -I 3C0 RETURN - 117F XX -R 10=  
 COLAMU -R 3C0 FILMCO - 100SU IMOMX -I 3C0 JCEN -I 3C0 NPT -I 3C0 REZONE - 1SU Y8 -R 3C0  
 DR -R 3C0 FIPXL -R 3C0 IM1 -I 3C0 JP4 -I 3C0 NQ1 -I 3C0 REZUE -R 3C0 YCONV -R 3C0  
 DTC -R 3C0 FIPXR -R 3C0 IPAR -I 3C0 JUNF -I 3C0 NQ18 -I 3C0 REZVE -R 3C0 YSC1 - 2CN  
 OTFAC -R 3C0 FIPY8 -R 3C0 IPXL -I 3C0 JUNF02 -I 3C0 NQ12 -I 3C0 RTBAR -R 3C0 YSC2 - 3CN  
 DTGR -R 3C0 FIPYT -R 3C0 IPXR -I 3C0 KXI -I 3C0 NSC -I 3C0 RIRJB -R 3C0 YT -R 3C0  
 DTGZ -R 3C0 FIXL -R 3C0 IPYB -I 3C0 LAM0 -R 5RL NUMIT -I 3C0 RDMFR -R 3C0 ZZ -R 3C0  
 DTGZP -R 3C0 FIXR -R 3C0 IPYT -I 3C0 LJP2 -I 3C0 NUMT0 -I 3C0 RON -R 3C0  
 DT0 (R) 3C0 FIY8 -R 3C0 IP2 -I 3C0 LP8 -I 3C0 OM -R 3C0 RPDR -R 3C0  
 DT0C (R) 3C0 FIYT -R 3C0 ISCF1 -I 3C0 LPR -I 3C0 OMANC -R 3C0 RPDR0Z -R 3C0  
 DT0I6 -R 3C0 FJRP -R 3C0 ISCF2 -I 3C0 MR -H 5RL DMEM10 -R 3C0 RPDR -R 3C0  
 DT0P -R 3C0 FREZ -R 3C0 ISC2 -I 3C0 MC -R 5RL OPEM10 -R 3C0 T -R 3C0  
 DT04 -R 3C0 GGM1 -R 3C0 ISC3 -I 3C0 ML -R 5RL PXCONV -R 3C0 THIRD -R 3C0

MULTIPLY-REFERENCED VARIABLES

1039 - 1400 20\*  
 1049 - 1300 22\*  
 1055 - 32 51 56\*  
 1059 - 2900 57\*  
 1069 - 2700 59\*  
 1080 - 71 76\*  
 1089 - 6900 78\*  
 1099 - 6400 80\*  
 1279 - 8600 93\*  
 1289 - 8500 95\*  
 1389 - 10400 113\*  
 1399 - 10300 115\*

AASC (R) 2C0 4EQ 4EQ 4EQ 4EQ 4EQ 4EQ 4EQ 4EQ 4EQ 4EQ 4EQ 4EQ 4EQ 4EQ  
 ABS - 15SU 15SU 102SU  
 AMAXI - 15SU 16SU 17SU 18SU 19SU 62SU 91SU 92SU  
 AVFL -R 15= 16 17 18 19  
 COMMON - 2F 3F  
 CQ (R) 4EQ 60I  
 CYL -R 3C0 89  
 DELSM (R) 4EQ 60I  
 DIMENST - 6F 7F  
 NONE - 81SU 96SU 116SU  
 DT -R 3C0 87 88  
 E (R) 4EQ 60I  
 FP (R) 4EQ 60I  
 FTIL (R) 4EQ 60I  
 FXP - 10RSU 109SU 110SU  
 FCR -R 12= 19= 19 25= 25 67  
 FCR -R 12= 17= 17 23= 23 75  
 FCT -R 12= 18= 18 24= 24 68  
 GM) -R 3C0 102  
 GZ -R 3C0 102  
 I -I 3C0 1400 17 2900 32 6900 73 14 75 75 76 8600 92 10400 109  
 IBAR -I 3C0 2900 10400 109



|        | INDEX | 01/12/73 |     |     |     | SUBROUTINE | REZONE |     |     |      |     |     |     |    |    |    |     |     |
|--------|-------|----------|-----|-----|-----|------------|--------|-----|-----|------|-----|-----|-----|----|----|----|-----|-----|
| UGTE   | ()R   | 7DI      | 73= | 74= | 75= | 76         |        |     |     |      |     |     |     |    |    |    |     |     |
| UL     | ()R   | 4EQ      | 6DI | 15  | 35  | 39         | 43     | 47  |     |      |     |     |     |    |    |    |     |     |
| UP     | ()R   | 4EQ      | 6DI |     |     |            |        |     |     |      |     |     |     |    |    |    |     |     |
| UTIL   | ()R   | 4EQ      | 6DI |     |     |            |        |     |     |      |     |     |     |    |    |    |     |     |
| U1     | -R    | 35=      | 50  | 50  |     |            |        |     |     |      |     |     |     |    |    |    |     |     |
| U2     | -R    | 39=      | 50  | 50  |     |            |        |     |     |      |     |     |     |    |    |    |     |     |
| U3     | -R    | 43=      | 50  | 50  |     |            |        |     |     |      |     |     |     |    |    |    |     |     |
| U4     | -R    | 47=      | 50  | 50  |     |            |        |     |     |      |     |     |     |    |    |    |     |     |
| V      | ()R   | 4EQ      | 6DI |     |     |            |        |     |     |      |     |     |     |    |    |    |     |     |
| VG     | ()R   | 4EQ      | 6DI | 77= | 88  |            |        |     |     |      |     |     |     |    |    |    |     |     |
| VGTE   | -R    | 66=      | 67= | 68= | 77  |            |        |     |     |      |     |     |     |    |    |    |     |     |
| VL     | ()R   | 4EQ      | 6DI | 15  | 36  | 40         | 44     | 48  |     |      |     |     |     |    |    |    |     |     |
| VP     | ()R   | 4EQ      | 6DI |     |     |            |        |     |     |      |     |     |     |    |    |    |     |     |
| VTIL   | ()R   | 4EQ      | 6DI |     |     |            |        |     |     |      |     |     |     |    |    |    |     |     |
| V1     | -R    | 36=      | 50  | 50  |     |            |        |     |     |      |     |     |     |    |    |    |     |     |
| V2     | -R    | 40=      | 50  | 50  |     |            |        |     |     |      |     |     |     |    |    |    |     |     |
| V3     | -R    | 44=      | 50  | 50  |     |            |        |     |     |      |     |     |     |    |    |    |     |     |
| V4     | -R    | 48=      | 50  | 50  |     |            |        |     |     |      |     |     |     |    |    |    |     |     |
| X      | ()R   | 4EQ      | 6DI | 33  | 37  | 41         | 45     | 72  | 72  | 72   | 73  | 87= | 87  | 89 | 92 |    |     |     |
| XBAR   | -R    | 72=      | 73  |     |     |            |        |     |     |      |     |     |     |    |    |    |     |     |
| XC     | -R    | 60=      | 72  |     |     |            |        |     |     |      |     |     |     |    |    |    |     |     |
| XIP1   | -R    | 83=      | 92= | 92  | 97  |            |        |     |     |      |     |     |     |    |    |    |     |     |
| XOMSUM | -R    | 12=      | 53= | 53  | 60  |            |        |     |     |      |     |     |     |    |    |    |     |     |
| XPAR   | ()R   | 4EQ      | 6DI |     |     |            |        |     |     |      |     |     |     |    |    |    |     |     |
| XXX    | -R    | 12=      | 16= | 16  | 23  | 24         | 25     |     |     |      |     |     |     |    |    |    |     |     |
| X1     | -R    | 33=      | 50  | 50  |     |            |        |     |     |      |     |     |     |    |    |    |     |     |
| X2     | -R    | 37=      | 50  | 50  |     |            |        |     |     |      |     |     |     |    |    |    |     |     |
| X3     | -R    | 41=      | 50  | 50  |     |            |        |     |     |      |     |     |     |    |    |    |     |     |
| X4     | -R    | 45=      | 50  | 50  | 53  |            |        |     |     |      |     |     |     |    |    |    |     |     |
| Y      | ()R   | 4EQ      | 6DI | 28  | 34  | 38         | 42     | 46  | 65  | 65   | 65  | 66  | 88= | 88 | 90 | 91 | 107 | 107 |
| YBAR   | -R    | 107      | 107 | 108 | 108 | 109        | 109    | 110 | 110 |      |     |     |     |    |    |    |     |     |
| YC     | -R    | 65=      | 66  | 65  |     |            |        |     |     |      |     |     |     |    |    |    |     |     |
| YCEN   | -R    | 61=      | 62  |     |     |            |        |     |     |      |     |     |     |    |    |    |     |     |
| YJ2    | -R    | 28=      | 62  |     |     |            |        |     |     |      |     |     |     |    |    |    |     |     |
| YJP2   | -R    | 83=      | 91= | 91  | 98  |            |        |     |     |      |     |     |     |    |    |    |     |     |
| YOMSUM | -R    | 12=      | 54= | 54  | 61  |            |        |     |     |      |     |     |     |    |    |    |     |     |
| YPAR   | ()R   | 4EQ      | 6DI |     |     |            |        |     |     |      |     |     |     |    |    |    |     |     |
| YY     | -R    | 50=      | 51  | 52= | 52  | 52         | 53     | 54  | 55  | 102= | 108 | 109 | 110 |    |    |    |     |     |
| Y1     | -R    | 34=      | 50  | 50  |     |            |        |     |     |      |     |     |     |    |    |    |     |     |
| Y2     | -R    | 38=      | 50  | 50  | 84= | 90=        | 90     | 98  |     |      |     |     |     |    |    |    |     |     |
| Y3     | -R    | 42=      | 50  | 50  |     |            |        |     |     |      |     |     |     |    |    |    |     |     |
| Y4     | -R    | 46=      | 50  | 50  | 54  | 107=       | 108    | 109 | 110 |      |     |     |     |    |    |    |     |     |









| INDEX  | 01/12/73 | MASTER INDEX |         |    |        |    |         |    |         |    |         | PAGE 88 |        |     |         |     |        |     |
|--------|----------|--------------|---------|----|--------|----|---------|----|---------|----|---------|---------|--------|-----|---------|-----|--------|-----|
| IJ2    | YAQUI2   | 6            |         |    |        |    |         |    |         |    |         |         |        |     |         |     |        |     |
| IL     | PARTMOV  | 6            |         |    |        |    |         |    |         |    |         |         |        |     |         |     |        |     |
| IMJ    | YASET1   | 3            | MESHMKR | 4  | YAQUI2 | 14 |         |    |         |    |         |         |        |     |         |     |        |     |
| IMJM   | YASET1   | 3            | YAQUI2  | 3  |        |    |         |    |         |    |         |         |        |     |         |     |        |     |
| IMOME3 | YAQUI    | C            | LOOP    | C  | FILMCO | C  | YASET1  | C  | PARTGEN | 1C | MESHMKR | C       | YAQUI2 | C   | PARTMOV | 1C  | REZONE | C   |
| IMOMX  | YAQUI    | C            | LOOP    | C  | FILMCO | C  | YASET1  | 2C | PARTGEN | 1C | MESHMKR | C       | YAQUI2 | C   | PARTMOV | 3C  | REZONE | C   |
| IMI    | YAQUI    | C            | LOOP    | C  | FILMCO | C  | YASET1  | 1C | PARTGEN | C  | MESHMKR | 1C      | YAQUI2 | 2C  | PARTMOV | C   | REZONE | C   |
| IM6    | YAQUI    | C            | LOOP    | C  | FILMCO | C  | YASET1  | 1C | PARTGEN | C  | MESHMKR | C       | YAQUI2 | C   | PARTMOV | C   | REZONE | 2C  |
| INP    | YAQUI    | 1            |         |    |        |    |         |    |         |    |         |         |        |     |         |     |        |     |
| IPAR   | YAQUI    | C            | LOOP    | C  | FILMCO | C  | YASET1  | C  | PARTGEN | 2C | MESHMKR | C       | YAQUI2 | C   | PARTMOV | 2C  | REZONE | C   |
| IPJ    | YASET1   | 7            | MESHMKR | 3  | YAQUI2 | 99 | PARTMOV | 4  | REZONE  | 16 |         |         |        |     |         |     |        |     |
| IPJA   | YAQUI2   | 4            |         |    |        |    |         |    |         |    |         |         |        |     |         |     |        |     |
| IPJB   | YAQUI2   | 4            |         |    |        |    |         |    |         |    |         |         |        |     |         |     |        |     |
| IPJM   | YAQUI2   | 13           |         |    |        |    |         |    |         |    |         |         |        |     |         |     |        |     |
| IPJP   | YASET1   | 7            | MESHMKR | 4  | YAQUI2 | 82 | PARTMOV | 3  | REZONE  | 11 |         |         |        |     |         |     |        |     |
| IPXL   | YAQUI    | C            | LOOP    | C  | FILMCO | 1C | YASET1  | C  | PARTGEN | C  | MESHMKR | C       | YAQUI2 | C   | PARTMOV | 2C  | REZONE | C   |
| IPXR   | YAQUI    | C            | LOOP    | C  | FILMCO | 1C | YASET1  | C  | PARTGEN | C  | MESHMKR | C       | YAQUI2 | C   | PARTMOV | 2C  | REZONE | C   |
| IPYB   | YAQUI    | C            | LOOP    | C  | FILMCO | 1C | YASET1  | C  | PARTGEN | C  | MESHMKR | C       | YAQUI2 | C   | PARTMOV | 2C  | REZONE | C   |
| IPYT   | YAQUI    | C            | LOOP    | C  | FILMCO | 1C | YASET1  | C  | PARTGEN | C  | MESHMKR | C       | YAQUI2 | C   | PARTMOV | 2C  | REZONE | C   |
| IP1    | YAQUI    | C            | LOOP    | C  | FILMCO | 1C | YASET1  | 5C | PARTGEN | C  | MESHMKR | 6C      | YAQUI2 | 12C | PARTMOV | 3C  | REZONE | 5C  |
| TP2    | YAQUI    | C            | LOOP    | C  | FILMCO | C  | YASET1  | 2C | PARTGEN | C  | MESHMKR | C       | YAQUI2 | 1C  | PARTMOV | C   | REZONE | C   |
| IR     | PARTMOV  | 6            |         |    |        |    |         |    |         |    |         |         |        |     |         |     |        |     |
| ISCF1  | YAQUI    | C            | LOOP    | 2C | FILMCO | C  | YASET1  | 2C | PARTGEN | C  | MESHMKR | C       | YAQUI2 | C   | PARTMOV | C   | REZONE | C   |
| ISCF2  | YAQUI    | C            | LOOP    | 2C | FILMCO | C  | YASET1  | 1C | PARTGEN | C  | MESHMKR | C       | YAQUI2 | 2C  | PARTMOV | C   | REZONE | C   |
| ISC2   | YAQUI    | C            | LOOP    | 4C | FILMCO | C  | YASET1  | 3C | PARTGEN | C  | MESHMKR | C       | YAQUI2 | 2C  | PARTMOV | 10C | REZONE | C   |
| ISC3   | YAQUI    | C            | LOOP    | 4C | FILMCO | C  | YASET1  | 1C | PARTGEN | C  | MESHMKR | C       | YAQUI2 | C   | PARTMOV | C   | REZONE | C   |
| IT     | PARTMOV  | 4            |         |    |        |    |         |    |         |    |         |         |        |     |         |     |        |     |
| ITESTL | PARTMOV  | 4            |         |    |        |    |         |    |         |    |         |         |        |     |         |     |        |     |
| ITESTR | PARTMOV  | 4            |         |    |        |    |         |    |         |    |         |         |        |     |         |     |        |     |
| ITV    | YAQUI    | C            | LOOP    | 1C | FILMCO | C  | YASET1  | 1C | PARTGEN | C  | MESHMKR | C       | YAQUI2 | C   | PARTMOV | C   | REZONE | C   |
| IUNF   | YAQUI    | 1C           | LOOP    | C  | FILMCO | C  | YASET1  | 3C | PARTGEN | 2C | MESHMKR | 1C      | YAQUI2 | C   | PARTMOV | C   | REZONE | C   |
| IXL    | YAQUI    | C            | LOOP    | C  | FILMCO | 1C | YASET1  | C  | PARTGEN | C  | MESHMKR | C       | YAQUI2 | C   | PARTMOV | C   | REZONE | C   |
| IXR    | YAQUI    | C            | LOOP    | C  | FILMCO | 1C | YASET1  | C  | PARTGEN | C  | MESHMKR | C       | YAQUI2 | C   | PARTMOV | C   | REZONE | C   |
| IX1    | YAQUI2   | 15D          | PARTMOV | 2  |        |    |         |    |         |    |         |         |        |     |         |     |        |     |
| IX2    | YAQUI2   | 11D          |         |    |        |    |         |    |         |    |         |         |        |     |         |     |        |     |
| IX3    | YAQUI2   | 6            |         |    |        |    |         |    |         |    |         |         |        |     |         |     |        |     |
| IX4    | YAQUI2   | 6            |         |    |        |    |         |    |         |    |         |         |        |     |         |     |        |     |
| IYB    | YAQUI    | C            | LOOP    | C  | FILMCO | 1C | YASET1  | C  | PARTGEN | C  | MESHMKR | C       | YAQUI2 | C   | PARTMOV | C   | REZONE | C   |
| IYT    | YAQUI    | C            | LOOP    | C  | FILMCO | 1C | YASET1  | C  | PARTGEN | C  | MESHMKR | C       | YAQUI2 | C   | PARTMOV | C   | REZONE | C   |
| IY1    | YAQUI2   | 15D          | PARTMOV | 2  |        |    |         |    |         |    |         |         |        |     |         |     |        |     |
| IY2    | YAQUI2   | 12D          |         |    |        |    |         |    |         |    |         |         |        |     |         |     |        |     |
| IY3    | YAQUI2   | 6            |         |    |        |    |         |    |         |    |         |         |        |     |         |     |        |     |
| IY4    | YAQUI2   | 6            |         |    |        |    |         |    |         |    |         |         |        |     |         |     |        |     |
| J      | YAQUI    | C            | LOOP    | 2C | FILMCO | 1C | YASET1  | 6C | PARTGEN | C  | MESHMKR | 19C     | YAQUI2 | 53C | PARTMOV | 18C | REZONE | 17C |
| JBAR   | YAQUI    | 1C           | LOOP    | C  | FILMCO | C  | YASET1  | 8C | PARTGEN | 2C | MESHMKR | 1C      | YAQUI2 | 4C  | PARTMOV | C   | REZONE | C   |
| JBDT   | MESHMKR  | 3            |         |    |        |    |         |    |         |    |         |         |        |     |         |     |        |     |
| JRP    | YAQUI    | C            | LOOP    | C  | FILMCO | C  | YASET1  | 2C | PARTGEN | 3C | MESHMKR | C       | YAQUI2 | C   | PARTMOV | 1C  | REZONE | C   |
| JRP2   | YAQUI    | C            | LOOP    | C  | FILMCO | C  | YASET1  | C  | PARTGEN | 1C | MESHMKR | C       | YAQUI2 | C   | PARTMOV | 5C  | REZONE | C   |
| JCEN   | YAQUI    | 1C           | LOOP    | C  | FILMCO | C  | YASET1  | 3C | PARTGEN | 2C | MESHMKR | 4C      | YAQUI2 | C   | PARTMOV | C   | REZONE | C   |
| JDB    | MESHMKR  | 2            |         |    |        |    |         |    |         |    |         |         |        |     |         |     |        |     |
| JOT    | MESHMKR  | 2            |         |    |        |    |         |    |         |    |         |         |        |     |         |     |        |     |
| JDTC   | YAQUI2   | 3            |         |    |        |    |         |    |         |    |         |         |        |     |         |     |        |     |
| JDTV   | YAQUI2   | 3            |         |    |        |    |         |    |         |    |         |         |        |     |         |     |        |     |
| JJ     | YASET1   | 2            | MESHMKR | 3  | YAQUI2 | 3  | PARTMOV | 3  |         |    |         |         |        |     |         |     |        |     |
| JMI0   | YAQUI    | C            | LOOP    | C  | FILMCO | C  | YASET1  | 1C | PARTGEN | C  | MESHMKR | C       | YAQUI2 | C   | PARTMOV | C   | REZONE | 1C  |
| JMI4   | YAQUI    | C            | LOOP    | C  | FILMCO | C  | YASET1  | 1C | PARTGEN | C  | MESHMKR | C       | YAQUI2 | C   | PARTMOV | C   | REZONE | 1C  |
| JNM    | YAQUI2   | 6C           | PARTMOV | 1C |        |    |         |    |         |    |         |         |        |     |         |     |        |     |
| JNSC   | YAQUI2   | 2            |         |    |        |    |         |    |         |    |         |         |        |     |         |     |        |     |



| INDEX     | 01/12/73 | MASTER INDEX |         |     |         |    |         |    |         |    |         | PAGE 90 |         |     |         |     |        |     |  |  |
|-----------|----------|--------------|---------|-----|---------|----|---------|----|---------|----|---------|---------|---------|-----|---------|-----|--------|-----|--|--|
| N         | YASET1   | 8            | YAQUI2  | 18  |         |    |         |    |         |    |         |         |         |     |         |     |        |     |  |  |
| NAME      | YAQUI    | C            | LOOP    | C   | FILMCO  | C  | YASET1  | 2C | PARTGEN | C  | MESHMKR | C       | YAQUI2  | 7C  | PARTMOV | 1C  | REZONE | C   |  |  |
| N8        | MESHMKR  | 4            |         |     |         |    |         |    |         |    |         |         |         |     |         |     |        |     |  |  |
| NR2       | MESHMKR  | 2            |         |     |         |    |         |    |         |    |         |         |         |     |         |     |        |     |  |  |
| NCYC      | YAQUI    | C            | LOOP    | C   | FILMCO  | C  | YASET1  | 1C | PARTGEN | C  | MESHMKR | C       | YAQUI2  | 20C | PARTMOV | 1C  | REZONE | C   |  |  |
| NE        | LOOP     | 11           | PARTGEN | 2   | PARTMOV | 16 |         |    |         |    |         |         |         |     |         |     |        |     |  |  |
| NL        | MESHMKR  | 4            |         |     |         |    |         |    |         |    |         |         |         |     |         |     |        |     |  |  |
| NLC       | YAQUI    | C            | LOOP    | C   | FILMCO  | C  | YASET1  | 1C | PARTGEN | C  | MESHMKR | C       | YAQUI2  | 2C  | PARTMOV | C   | REZONE | C   |  |  |
| NLI       | MESHMKR  | 2            |         |     |         |    |         |    |         |    |         |         |         |     |         |     |        |     |  |  |
| NPM7      | PARTMOV  | 4            |         |     |         |    |         |    |         |    |         |         |         |     |         |     |        |     |  |  |
| NPPT      | PARTMOV  | 4            |         |     |         |    |         |    |         |    |         |         |         |     |         |     |        |     |  |  |
| NPS       | YAQUI    | C            | LOOP    | C   | FILMCO  | C  | YASET1  | C  | PARTGEN | 1C | MESHMKR | C       | YAQUI2  | 2C  | PARTMOV | C   | REZONE | C   |  |  |
| NPT       | YAQUI    | C            | LOOP    | C   | FILMCO  | 1C | YASET1  | C  | PARTGEN | 6C | MESHMKR | C       | YAQUI2  | 4C  | PARTMOV | 2C  | REZONE | C   |  |  |
| NQ        | YAQUI    | 1C           | LOOP    | 1C  | FILMCO  | 1C | YASET1  | 8C | PARTGEN | C  | MESHMKR | 10C     | YAQUI2  | 55C | PARTMOV | 16C | REZONE | 10C |  |  |
| NQI       | YAQUI    | C            | LOOP    | 21C | FILMCO  | C  | YASET1  | 7C | PARTGEN | 2C | MESHMKR | 1C      | YAQUI2  | C   | PARTMOV | 20C | REZONE | C   |  |  |
| NQI8      | YAQUI    | C            | LOOP    | C   | FILMCO  | C  | YASET1  | 1C | PARTGEN | C  | MESHMKR | C       | YAQUI2  | 6C  | PARTMOV | C   | REZONE | C   |  |  |
| NQI4      | MESHMKR  | 2            |         |     |         |    |         |    |         |    |         |         |         |     |         |     |        |     |  |  |
| NQI2      | YAQUI    | C            | LOOP    | C   | FILMCO  | C  | YASET1  | C  | PARTGEN | 1C | MESHMKR | C       | YAQUI2  | C   | PARTMOV | 5C  | REZONE | C   |  |  |
| NR        | MESHMKR  | 6            |         |     |         |    |         |    |         |    |         |         |         |     |         |     |        |     |  |  |
| NR1       | MESHMKR  | 3            |         |     |         |    |         |    |         |    |         |         |         |     |         |     |        |     |  |  |
| NSC       | YAQUI    | C            | LOOP    | C   | FILMCO  | C  | YASET1  | 1C | PARTGEN | C  | MESHMKR | C       | YAQUI2  | 1C  | PARTMOV | C   | REZONE | C   |  |  |
| NT        | MESHMKR  | 5            |         |     |         |    |         |    |         |    |         |         |         |     |         |     |        |     |  |  |
| NT2       | MESHMKR  | 3            |         |     |         |    |         |    |         |    |         |         |         |     |         |     |        |     |  |  |
| NUM17     | YAQUI    | C            | LOOP    | C   | FILMCO  | C  | YASET1  | C  | PARTGEN | C  | MESHMKR | C       | YAQUI2  | 7C  | PARTMOV | C   | REZONE | C   |  |  |
| NUM7D     | YAQUI    | C            | LOOP    | C   | FILMCO  | C  | YASET1  | 1C | PARTGEN | C  | MESHMKR | C       | YAQUI2  | 7C  | PARTMOV | C   | REZONE | C   |  |  |
| OM        | YAQUI    | C            | LOOP    | C   | FILMCO  | C  | YASET1  | 2C | PARTGEN | C  | MESHMKR | C       | YAQUI2  | 1C  | PARTMOV | C   | REZONE | C   |  |  |
| OMAL13    | YAQUI2   | 3            |         |     |         |    |         |    |         |    |         |         |         |     |         |     |        |     |  |  |
| OMAL24    | YAQUI2   | 3            |         |     |         |    |         |    |         |    |         |         |         |     |         |     |        |     |  |  |
| OMANC     | YAQUI    | C            | LOOP    | C   | FILMCO  | C  | YASET1  | 1C | PARTGEN | C  | MESHMKR | C       | YAQUI2  | 1C  | PARTMOV | C   | REZONE | C   |  |  |
| OMCYL     | YAQUI    | C            | LOOP    | C   | FILMCO  | C  | YASET1  | 1C | PARTGEN | 1C | MESHMKR | 2C      | YAQUI2  | 1C  | PARTMOV | C   | REZONE | 1C  |  |  |
| OMEM10    | YAQUI    | C            | LOOP    | C   | FILMCO  | 1C | YASET1  | 1C | PARTGEN | C  | MESHMKR | C       | YAQUI2  | C   | PARTMOV | C   | REZONE | C   |  |  |
| OMSUM     | REZONE   | 5            |         |     |         |    |         |    |         |    |         |         |         |     |         |     |        |     |  |  |
| OPAL13    | YAQUI2   | 3            |         |     |         |    |         |    |         |    |         |         |         |     |         |     |        |     |  |  |
| OPAL24    | YAQUI2   | 3            |         |     |         |    |         |    |         |    |         |         |         |     |         |     |        |     |  |  |
| OPFM10    | YAQUI    | C            | LOOP    | C   | FILMCO  | 2C | YASET1  | 1C | PARTGEN | C  | MESHMKR | C       | YAQUI2  | C   | PARTMOV | 6C  | REZONE | C   |  |  |
| OUT       | YAQUI    | 2            |         |     |         |    |         |    |         |    |         |         |         |     |         |     |        |     |  |  |
| S OVERLAY | YAQUI    | 2            |         |     |         |    |         |    |         |    |         |         |         |     |         |     |        |     |  |  |
| P         | YAQUI    | D            | FILMCO  | D   | YASET1  | D  | PARTGEN | D  | MESHMKR | D  | YAQUI2  | 13D     | PARTMOV | D   | REZONE  | D   |        |     |  |  |
| S PARPLOT | YAQUI2   | 1            | PARTMOV | 1   |         |    |         |    |         |    |         |         |         |     |         |     |        |     |  |  |
| S PARTGEN | YASET1   | 1            | PARTGEN | 1   |         |    |         |    |         |    |         |         |         |     |         |     |        |     |  |  |
| S PARTMOV | YAQUI2   | 1            | PARTMOV | 1   |         |    |         |    |         |    |         |         |         |     |         |     |        |     |  |  |
| P8        | YAQUI2   | 3            |         |     |         |    |         |    |         |    |         |         |         |     |         |     |        |     |  |  |
| PC        | YAQUI2   | 5            |         |     |         |    |         |    |         |    |         |         |         |     |         |     |        |     |  |  |
| PDR       | YAQUI    | C            | LOOP    | C   | FILMCO  | 2C | YASET1  | 2C | PARTGEN | 1C | MESHMKR | C       | YAQUI2  | C   | PARTMOV | 7C  | REZONE | 1C  |  |  |
| PDRMW     | PARTMOV  | 3            |         |     |         |    |         |    |         |    |         |         |         |     |         |     |        |     |  |  |
| PDZ       | YAQUI    | C            | LOOP    | C   | FILMCO  | 2C | YASET1  | 2C | PARTGEN | 1C | MESHMKR | C       | YAQUI2  | C   | PARTMOV | 7C  | REZONE | 1C  |  |  |
| PDZMH     | PARTMOV  | 3            |         |     |         |    |         |    |         |    |         |         |         |     |         |     |        |     |  |  |
| PITH      | YAQUI2   | 5            |         |     |         |    |         |    |         |    |         |         |         |     |         |     |        |     |  |  |
| PIXX      | YAQUI2   | 5            |         |     |         |    |         |    |         |    |         |         |         |     |         |     |        |     |  |  |
| PIXY      | YAQUI2   | 9            |         |     |         |    |         |    |         |    |         |         |         |     |         |     |        |     |  |  |
| PIYY      | YAQUI2   | 4            |         |     |         |    |         |    |         |    |         |         |         |     |         |     |        |     |  |  |
| PL        | YAQUI    | D            | FILMCO  | D   | YASET1  | D  | PARTGEN | D  | MESHMKR | D  | YAQUI2  | 3D      | PARTMOV | D   | REZONE  | D   |        |     |  |  |
| PLE       | YAQUI2   | 3            |         |     |         |    |         |    |         |    |         |         |         |     |         |     |        |     |  |  |
| PLMAX     | YAQUI2   | 4            |         |     |         |    |         |    |         |    |         |         |         |     |         |     |        |     |  |  |
| S PLT     | YAQUI2   | 3            | PARTMOV | 1   |         |    |         |    |         |    |         |         |         |     |         |     |        |     |  |  |
| PMX       | YAQUI    | D            | FILMCO  | D   | YASET1  | D  | PARTGEN | D  | MESHMKR | D  | YAQUI2  | D       | PARTMOV | 4D  | REZONE  | D   |        |     |  |  |
| PMY       | YAQUI    | D            | FILMCO  | D   | YASET1  | D  | PARTGEN | D  | MESHMKR | D  | YAQUI2  | D       | PARTMOV | 4D  | REZONE  | D   |        |     |  |  |
| PMO       | YAQUI    | D            | FILMCO  | D   | YASET1  | D  | PARTGEN | D  | MESHMKR | D  | YAQUI2  | D       | PARTMOV | 12D | REZONE  | D   |        |     |  |  |

| INDEX    |         | MASTER INDEX |         |   |         |    |         |    |         |    |         |     |         |      | PAGE 91 |    |        |    |
|----------|---------|--------------|---------|---|---------|----|---------|----|---------|----|---------|-----|---------|------|---------|----|--------|----|
| PR       | YAQUI2  | 3            |         |   |         |    |         |    |         |    |         |     |         |      |         |    |        |    |
| F PRINT  | YAQUI   | 1            | YASET   | I | PARTGEN | 3  | MESHMKR | 1  | YAQUI1  | 1  | YAQUI2  | 10  |         |      |         |    |        |    |
| PRM      | YAQUI2  | 4            |         |   |         |    |         |    |         |    |         |     |         |      |         |    |        |    |
| PRSI E   | YAQUI2  | 4            |         |   |         |    |         |    |         |    |         |     |         |      |         |    |        |    |
| PRV      | YAQUI2  | 4            |         |   |         |    |         |    |         |    |         |     |         |      |         |    |        |    |
| RT       | YAQUI2  | 3            |         |   |         |    |         |    |         |    |         |     |         |      |         |    |        |    |
| PU       | YAQUI   | D            | FILMCO  | D | YASET I | 0  | PARTGEN | D  | MESHMKR | D  | YAQUI2  | D   | PARTMOV | I 8D | REZONE  | D  |        |    |
| PUB      | PARTMOV | 3            |         |   |         |    |         |    |         |    |         |     |         |      |         |    |        |    |
| PUL      | PARTMOV | 6            |         |   |         |    |         |    |         |    |         |     |         |      |         |    |        |    |
| PUR      | PARTMOV | 3            |         |   |         |    |         |    |         |    |         |     |         |      |         |    |        |    |
| PUT      | PARTMOV | 3            |         |   |         |    |         |    |         |    |         |     |         |      |         |    |        |    |
| PV       | YAQUI   | D            | FILMCO  | D | YASET I | D  | PARTGEN | D  | MESHMKR | D  | YAQUI2  | D   | PARTMOV | I 7D | REZONE  | D  |        |    |
| PV8      | PARTMOV | 3            |         |   |         |    |         |    |         |    |         |     |         |      |         |    |        |    |
| PVL      | PARTMOV | 6            |         |   |         |    |         |    |         |    |         |     |         |      |         |    |        |    |
| PVR      | PARTMOV | 3            |         |   |         |    |         |    |         |    |         |     |         |      |         |    |        |    |
| PVT      | PARTMOV | 3            |         |   |         |    |         |    |         |    |         |     |         |      |         |    |        |    |
| PXCONV   | YAQUI   | C            | LOOP    | C | FILMCO  | 1C | YASET I | C  | PARTGEN | C  | MESHMKR | C   | YAQUI2  | C    | PARTMOV | 1C | REZONE | C  |
| PXL      | YAQUI   | C            | LOOP    | C | FILMCO  | 2C | YASET I | C  | PARTGEN | C  | MESHMKR | C   | YAQUI2  | C    | PARTMOV | 1C | REZONE | C  |
| PXR      | YAQUI   | C            | LOOP    | C | FILMCO  | 4C | YASET I | C  | PARTGEN | C  | MESHMKR | C   | YAQUI2  | C    | PARTMOV | 1C | REZONE | C  |
| PXRP     | YAQUI   | C            | LOOP    | C | FILMCO  | 1C | YASET I | C  | PARTGEN | C  | MESHMKR | C   | YAQUI2  | C    | PARTMOV | 2C | REZONE | C  |
| PY8      | YAQUI   | C            | LOOP    | C | FILMCO  | 6C | YASET I | 2C | PARTGEN | C  | MESHMKR | C   | YAQUI2  | C    | PARTMOV | 8C | REZONE | 1C |
| PYRM     | YAQUI   | C            | LOOP    | C | FILMCO  | 1C | YASET I | C  | PARTGEN | C  | MESHMKR | C   | YAQUI2  | C    | PARTMOV | 2C | REZONE | C  |
| PYCONV   | YAQUI   | C            | LOOP    | C | FILMCO  | 1C | YASET I | C  | PARTGEN | C  | MESHMKR | C   | YAQUI2  | C    | PARTMOV | 1C | REZONE | C  |
| PYT      | YAQUI   | C            | LOOP    | C | FILMCO  | 4C | YASET I | C  | PARTGEN | C  | MESHMKR | C   | YAQUI2  | C    | PARTMOV | 1C | REZONE | C  |
| PYTP     | YAQUI   | C            | LOOP    | C | FILMCO  | 1C | YASET I | C  | PARTGEN | C  | MESHMKR | C   | YAQUI2  | C    | PARTMOV | 2C | REZONE | C  |
| PYYMP    | YAQUI2  | 3            |         |   |         |    |         |    |         |    |         |     |         |      |         |    |        |    |
| P12      | YAQUI2  | 2            |         |   |         |    |         |    |         |    |         |     |         |      |         |    |        |    |
| P23      | YAQUI2  | 2            |         |   |         |    |         |    |         |    |         |     |         |      |         |    |        |    |
| P34      | YAQUI2  | 2            |         |   |         |    |         |    |         |    |         |     |         |      |         |    |        |    |
| P41      | YAQUI2  | 2            |         |   |         |    |         |    |         |    |         |     |         |      |         |    |        |    |
| Q        | YAQUI1  | D            | FILMCO  | D | YASET I | D  | PARTGEN | D  | MESHMKR | D  | YAQUI2  | 13D | PARTMOV | D    | REZONE  | D  |        |    |
| QMN      | YAQUI2  | 11           |         |   |         |    |         |    |         |    |         |     |         |      |         |    |        |    |
| QMX      | YAQUI2  | 8            |         |   |         |    |         |    |         |    |         |     |         |      |         |    |        |    |
| R        | YAQUI   | D            | FILMCO  | D | YASET I | 4D | PARTGEN | D  | MESHMKR | 2D | YAQUI2  | 29D | PARTMOV | D    | REZONE  | 5D |        |    |
| RA       | YAQUI2  | 2            |         |   |         |    |         |    |         |    |         |     |         |      |         |    |        |    |
| RCSQ     | YAQUI   | D            | FILMCO  | D | YASET I | D  | PARTGEN | D  | MESHMKR | D  | YAQUI2  | 3D  | PARTMOV | D    | REZONE  | D  |        |    |
| RDT      | YAQUI   | C            | LOOP    | C | FILMCO  | C  | YASET I | C  | PARTGEN | C  | MESHMKR | C   | YAQUI2  | 4C   | PARTMOV | C  | REZONE | 1C |
| RDTORG   | PARTMOV | 3            |         |   |         |    |         |    |         |    |         |     |         |      |         |    |        |    |
| F READ   | YAQUI   | 1            | YASET I | 7 | PARTGEN | I  | MESHMKR | 2  | YAQUI2  | 3  |         |     |         |      |         |    |        |    |
| F REAL   | YAQUI   | 1            | FILMCO  | 1 | YASET I | 1  | PARTGEN | 1  | MESHMKR | 1  | YAQUI2  | 1   | PARTMOV | 1    | REZONE  | 1  |        |    |
| F RETURN | LOOP    | 6            | FILMCO  | 2 | YASET I | 1  | PARTGEN | 3  | MESHMKR | 2  | YAQUI2  | 2   | PARTMOV | 4    | REZONE  | 1  |        |    |
| F REWIND | YAQUI2  | 1            |         |   |         |    |         |    |         |    |         |     |         |      |         |    |        |    |
| REZATA   | REZONE  | 3            |         |   |         |    |         |    |         |    |         |     |         |      |         |    |        |    |
| REZOMG   | REZONE  | 4            |         |   |         |    |         |    |         |    |         |     |         |      |         |    |        |    |
| S REZONE | YAQUI2  | 1            | REZONE  | 1 |         |    |         |    |         |    |         |     |         |      |         |    |        |    |
| REZRON   | YAQUI   | C            | LOOP    | C | FILMCO  | C  | YASET I | 2C | PARTGEN | C  | MESHMKR | 1C  | YAQUI2  | C    | PARTMOV | C  | REZONE | 3C |
| REZSIE   | YAQUI   | C            | LOOP    | C | FILMCO  | C  | YASET I | 2C | PARTGEN | C  | MESHMKR | 4C  | YAQUI2  | C    | PARTMOV | C  | REZONE | 1C |
| REZUE    | YAQUI   | C            | LOOP    | C | FILMCO  | C  | YASET I | 2C | PARTGEN | C  | MESHMKR | C   | YAQUI2  | C    | PARTMOV | C  | REZONE | C  |
| REZVE    | YAQUI   | C            | LOOP    | C | FILMCO  | C  | YASET I | 2C | PARTGEN | C  | MESHMKR | C   | YAQUI2  | C    | PARTMOV | C  | REZONE | C  |
| REZVT    | YAQUI   | C            | LOOP    | C | FILMCO  | C  | YASET I | 2C | PARTGEN | C  | MESHMKR | C   | YAQUI2  | C    | PARTMOV | C  | REZONE | 2C |
| REZVO    | YAQUI   | C            | LOOP    | C | FILMCO  | C  | YASET I | 2C | PARTGEN | 2C | MESHMKR | 3C  | YAQUI2  | C    | PARTMOV | C  | REZONE | 1C |
| RIBAR    | YAQUI   | C            | LOOP    | C | FILMCO  | 1C | YASET I | 1C | PARTGEN | C  | MESHMKR | C   | YAQUI2  | C    | PARTMOV | C  | REZONE | C  |
| RIBJR    | YAQUI   | C            | LOOP    | C | FILMCO  | C  | YASET I | 1C | PARTGEN | C  | MESHMKR | C   | YAQUI2  | 1C   | PARTMOV | C  | REZONE | C  |
| RIBP     | YAQUI   | C            | LOOP    | C | FILMCO  | C  | YASET I | C  | PARTGEN | 2C | MESHMKR | 8   | YAQUI2  | C    | PARTMOV | C  | REZONE | 1C |
| RJBP     | YAQUI   | C            | LOOP    | C | FILMCO  | C  | YASET I | C  | PARTGEN | 2C | MESHMKR | C   | YAQUI2  | C    | PARTMOV | C  | REZONE | 1C |
| RM       | YAQUI   | D            | FILMCO  | D | YASET I | 1D | PARTGEN | D  | MESHMKR | D  | YAQUI2  | 12D | PARTMOV | 1D   | REZONE  | D  |        |    |
| RMP      | YAQUI   | D            | FILMCO  | D | YASET I | D  | PARTGEN | D  | MESHMKR | D  | YAQUI2  | 7D  | PARTMOV | D    | REZONE  | D  |        |    |
| RO       | YAQUI   | D            | FILMCO  | D | YASET I | 2D | PARTGEN | D  | MESHMKR | 7D | YAQUI2  | 27D | PARTMOV | D    | REZONE  | D  |        |    |

| INDEX    | 01/12/73 | MASTER INDEX |         |    |        |    |         |    |         |    |         |     |         |     |         | PAGE 92 |        |   |  |
|----------|----------|--------------|---------|----|--------|----|---------|----|---------|----|---------|-----|---------|-----|---------|---------|--------|---|--|
| RQE      | YAQUI2   | 6            |         |    |        |    |         |    |         |    |         |     |         |     |         |         |        |   |  |
| ROI      | MESHMKR  | 7            |         |    |        |    |         |    |         |    |         |     |         |     |         |         |        |   |  |
| ROJP2    | MESHMKR  | 2            |         |    |        |    |         |    |         |    |         |     |         |     |         |         |        |   |  |
| ROJ1     | MESHMKR  | 2            |         |    |        |    |         |    |         |    |         |     |         |     |         |         |        |   |  |
| ROL      | YAQUI    | D            | FILMCO  | D  | YASET1 | D  | PARTGEN | D  | MESHMKR | D  | YAQUI2  | 19D | PARTMOV | D   | REZONE  | 30      |        |   |  |
| ROMFR    | YAQUI    | C            | LOOP    | C  | FILMCO | C  | YASET1  | 1C | PARTGEN | 3C | MESHMKR | 2C  | YAQUI2  | C   | PARTMOV | C       | REZONE | C |  |
| RON      | YAQUI    | C            | LOOP    | C  | FILMCO | C  | YASET1  | 2C | PARTGEN | C  | MESHMKR | C   | YAQUI2  | 3C  | PARTMOV | C       | REZONE | C |  |
| ROSAV    | MESHMKR  | 7            |         |    |        |    |         |    |         |    |         |     |         |     |         |         |        |   |  |
| RPDR     | YAQUI    | C            | LOOP    | C  | FILMCO | 2C | YASET1  | C  | PARTGEN | C  | MESHMKR | C   | YAQUI2  | C   | PARTMOV | 3C      | REZONE | C |  |
| RPDRDZ   | YAQUI    | C            | LOOP    | C  | FILMCO | 1C | YASET1  | C  | PARTGEN | C  | MESHMKR | C   | YAQUI2  | C   | PARTMOV | 5C      | REZONE | C |  |
| RPDZ     | YAQUI    | C            | LOOP    | C  | FILMCO | 2C | YASET1  | C  | PARTGEN | C  | MESHMKR | C   | YAQUI2  | C   | PARTMOV | 3C      | REZONE | C |  |
| RPM0     | PARTMOV  | 7            |         |    |        |    |         |    |         |    |         |     |         |     |         |         |        |   |  |
| RVOL     | YAQUI    | D            | FILMCO  | D  | YASET1 | 1D | PARTGEN | D  | MESHMKR | D  | YAQUI2  | 25D | PARTMOV | 0   | REZONE  | 1D      |        |   |  |
| R1       | YASET1   | 3            | YAQUI2  | 25 | REZONE | 2  |         |    |         |    |         |     |         |     |         |         |        |   |  |
| S R1ROW  | LOOP     | 1            | MESHMKR | 4  |        |    |         |    |         |    |         |     |         |     |         |         |        |   |  |
| R12      | YAQUI2   | 10           |         |    |        |    |         |    |         |    |         |     |         |     |         |         |        |   |  |
| R2       | YASET1   | 7            | YAQUI2  | 22 |        |    |         |    |         |    |         |     |         |     |         |         |        |   |  |
| R23      | YAQUI2   | 10           |         |    |        |    |         |    |         |    |         |     |         |     |         |         |        |   |  |
| R3       | YASET1   | 3            | YAQUI2  | 23 |        |    |         |    |         |    |         |     |         |     |         |         |        |   |  |
| R34      | YAQUI2   | 10           |         |    |        |    |         |    |         |    |         |     |         |     |         |         |        |   |  |
| R4       | YASET1   | 2            | YAQUI2  | 22 |        |    |         |    |         |    |         |     |         |     |         |         |        |   |  |
| R41      | YAQUI2   | 10           |         |    |        |    |         |    |         |    |         |     |         |     |         |         |        |   |  |
| S        | YAQUI2   | 2            |         |    |        |    |         |    |         |    |         |     |         |     |         |         |        |   |  |
| S SECOND | YAQUI2   | 2            |         |    |        |    |         |    |         |    |         |     |         |     |         |         |        |   |  |
| S SETIJ  | LOOP     | 1            | MESHMKR | 4  |        |    |         |    |         |    |         |     |         |     |         |         |        |   |  |
| S SHIFT  | PARTGEN  | 3            | PARTMOV | 11 |        |    |         |    |         |    |         |     |         |     |         |         |        |   |  |
| S IE     | YAQUI    | D            | FILMCO  | D  | YASET1 | 1D | PARTGEN | D  | MESHMKR | 3D | YAQUI2  | 4D  | PARTMOV | D   | REZONE  | D       |        |   |  |
| S IEJ    | MESHMKR  | 7            |         |    |        |    |         |    |         |    |         |     |         |     |         |         |        |   |  |
| S IET    | YAQUI2   | 3            |         |    |        |    |         |    |         |    |         |     |         |     |         |         |        |   |  |
| S SIGN   | YAQUI2   | 6            |         |    |        |    |         |    |         |    |         |     |         |     |         |         |        |   |  |
| S SORT   | YAQUI2   | 4            | REZONE  | 3  |        |    |         |    |         |    |         |     |         |     |         |         |        |   |  |
| S START  | LOOP     | 1            | FILMCO  | 1  | YASET1 | 1  | MESHMKR | 5  | YAQUI2  | 22 | PARTMOV | 4   | REZONE  | 5   |         |         |        |   |  |
| S STARTD | LOOP     | 1            | YASET1  | 1  | YAQUI2 | 1  |         |    |         |    |         |     |         |     |         |         |        |   |  |
| T        | YAQUI    | C            | LOOP    | C  | FILMCO | C  | YASET1  | 3C | PARTGEN | C  | MESHMKR | C   | YAQUI2  | 78C | PARTMOV | 1C      | REZONE | C |  |
| TBASE    | YAQUI2   | 3            |         |    |        |    |         |    |         |    |         |     |         |     |         |         |        |   |  |
| THIRD    | YAQUI    | C            | LOOP    | C  | FILMCO | C  | YASET1  | 2C | PARTGEN | C  | MESHMKR | C   | YAQUI2  | C   | PARTMOV | C       | REZONE | C |  |
| TJ       | MESHMKR  | 3            |         |    |        |    |         |    |         |    |         |     |         |     |         |         |        |   |  |
| TLTM     | YAQUI2   | 6            |         |    |        |    |         |    |         |    |         |     |         |     |         |         |        |   |  |
| TLMD     | YAQUI    | C            | LOOP    | C  | FILMCO | C  | YASET1  | 2C | PARTGEN | C  | MESHMKR | C   | YAQUI2  | 2C  | PARTMOV | C       | REZONE | C |  |
| TOLD     | YAQUI2   | 2            |         |    |        |    |         |    |         |    |         |     |         |     |         |         |        |   |  |
| TOUT     | YAQUI    | C            | LOOP    | C  | FILMCO | C  | YASET1  | 1C | PARTGEN | C  | MESHMKR | C   | YAQUI2  | 6C  | PARTMOV | C       | REZONE | C |  |
| TWFIN    | YAQUI    | C            | LOOP    | C  | FILMCO | C  | YASET1  | 2C | PARTGEN | C  | MESHMKR | C   | YAQUI2  | 1C  | PARTMOV | C       | REZONE | C |  |
| T1       | YAQUI2   | 3            |         |    |        |    |         |    |         |    |         |     |         |     |         |         |        |   |  |
| T2       | YAQUI2   | 8            |         |    |        |    |         |    |         |    |         |     |         |     |         |         |        |   |  |
| T20MD    | YAQUI    | C            | LOOP    | C  | FILMCO | C  | YASET1  | 2C | PARTGEN | C  | MESHMKR | C   | YAQUI2  | 1C  | PARTMOV | C       | REZONE | C |  |
| U        | YAQUI    | D            | FILMCO  | D  | YASET1 | 4D | PARTGEN | D  | MESHMKR | 2D | YAQUI2  | 32D | PARTMOV | 3D  | REZONE  | D       |        |   |  |
| UD1      | YAQUI2   | 3            |         |    |        |    |         |    |         |    |         |     |         |     |         |         |        |   |  |
| UD2      | YAQUI2   | 3            |         |    |        |    |         |    |         |    |         |     |         |     |         |         |        |   |  |
| UD3      | YAQUI2   | 3            |         |    |        |    |         |    |         |    |         |     |         |     |         |         |        |   |  |
| UD4      | YAQUI2   | 3            |         |    |        |    |         |    |         |    |         |     |         |     |         |         |        |   |  |
| UG       | YAQUI    | D            | FILMCO  | D  | YASET1 | D  | PARTGEN | D  | MESHMKR | D  | YAQUI2  | 10D | PARTMOV | D   | REZONE  | 2D      |        |   |  |
| UGTF     | REZONE   | 4D           |         |    |        |    |         |    |         |    |         |     |         |     |         |         |        |   |  |
| UG1      | YAQUI2   | 2            |         |    |        |    |         |    |         |    |         |     |         |     |         |         |        |   |  |
| UG2      | YAQUI2   | 2            |         |    |        |    |         |    |         |    |         |     |         |     |         |         |        |   |  |
| UG3      | YAQUI2   | 2            |         |    |        |    |         |    |         |    |         |     |         |     |         |         |        |   |  |
| UG4      | YAQUI2   | 2            |         |    |        |    |         |    |         |    |         |     |         |     |         |         |        |   |  |
| UI       | MESHMKR  | 7            |         |    |        |    |         |    |         |    |         |     |         |     |         |         |        |   |  |
| UK       | PARTMOV  | 3            |         |    |        |    |         |    |         |    |         |     |         |     |         |         |        |   |  |



| INDEX    | 01/12/73 | MASTER INDEX |         |    |         |     |         |    |         |     |         | PAGE 94 |         |     |         |     |        |   |  |  |
|----------|----------|--------------|---------|----|---------|-----|---------|----|---------|-----|---------|---------|---------|-----|---------|-----|--------|---|--|--|
| V23      | YAQUI2   | 8            |         |    |         |     |         |    |         |     |         |         |         |     |         |     |        |   |  |  |
| V24      | YAQUI2   | 2            |         |    |         |     |         |    |         |     |         |         |         |     |         |     |        |   |  |  |
| V3       | YAQUI2   | 17           | REZONE  | 3  |         |     |         |    |         |     |         |         |         |     |         |     |        |   |  |  |
| V34      | YAQUI2   | 9            |         |    |         |     |         |    |         |     |         |         |         |     |         |     |        |   |  |  |
| V4       | YAQUI2   | 19           | REZONE  | 3  |         |     |         |    |         |     |         |         |         |     |         |     |        |   |  |  |
| V41      | YAQUI2   | 8            |         |    |         |     |         |    |         |     |         |         |         |     |         |     |        |   |  |  |
| W        | PARTMOV  | 10           |         |    |         |     |         |    |         |     |         |         |         |     |         |     |        |   |  |  |
| F WRITE  | YASET1   | 8            | PARTGEN | 2  | MESHMKR | 1   | YAQUI2  | 20 | PARTMOV | 2   |         |         |         |     |         |     |        |   |  |  |
| WTR      | PARTMOV  | 3            |         |    |         |     |         |    |         |     |         |         |         |     |         |     |        |   |  |  |
| WTE      | PARTMOV  | 6            |         |    |         |     |         |    |         |     |         |         |         |     |         |     |        |   |  |  |
| WTL      | PARTMOV  | 3            |         |    |         |     |         |    |         |     |         |         |         |     |         |     |        |   |  |  |
| WTR      | PARTMOV  | 3            |         |    |         |     |         |    |         |     |         |         |         |     |         |     |        |   |  |  |
| WTT      | PARTMOV  | 3            |         |    |         |     |         |    |         |     |         |         |         |     |         |     |        |   |  |  |
| S WIROW  | LOOP     | 1            | MESHMKR | 4  |         |     |         |    |         |     |         |         |         |     |         |     |        |   |  |  |
| X        | YAQUI    | D            | FILMCO  | 10 | YASET1  | 40  | PARTGEN | D  | MESHMKR | 60  | YAQUI2  | 55D     | PARTMOV | 60  | REZONE  | 12D |        |   |  |  |
| XBAR     | REZONE   | 2            |         |    |         |     |         |    |         |     |         |         |         |     |         |     |        |   |  |  |
| XC       | PARTGEN  | 4            | REZONE  | 2  |         |     |         |    |         |     |         |         |         |     |         |     |        |   |  |  |
| XCD      | YAQUI2   | 40           |         |    |         |     |         |    |         |     |         |         |         |     |         |     |        |   |  |  |
| XCONV    | YAQUI    | C            | LOOP    | C  | FILMCO  | 1C  | YASET1  | C  | PARTGEN | C   | MESHMKR | C       | YAQUI2  | 11C | PARTMOV | C   | REZONE | C |  |  |
| X0       | FILMCO   | 10           | PARTGEN | 8  |         |     |         |    |         |     |         |         |         |     |         |     |        |   |  |  |
| XIP1     | REZONE   | 4            |         |    |         |     |         |    |         |     |         |         |         |     |         |     |        |   |  |  |
| XL       | YAQUI    | C            | LOOP    | C  | FILMCO  | 2C  | YASET1  | C  | PARTGEN | C   | MESHMKR | C       | YAQUI2  | 11C | PARTMOV | C   | REZONE | C |  |  |
| XMAX     | PARTGEN  | 3            |         |    |         |     |         |    |         |     |         |         |         |     |         |     |        |   |  |  |
| XOMSUM   | REZONE   | 4            |         |    |         |     |         |    |         |     |         |         |         |     |         |     |        |   |  |  |
| XPAR     | YAQUI    | D            | FILMCO  | D  | YASET1  | D   | PARTGEN | 1D | MESHMKR | D   | YAQUI2  | D       | PARTMOV | 5D  | REZONE  | D   |        |   |  |  |
| XR       | YAQUI    | C            | LOOP    | C  | FILMCO  | 6C  | YASET1  | C  | PARTGEN | C   | MESHMKR | C       | YAQUI2  | 1C  | PARTMOV | C   | REZONE | C |  |  |
| XR13     | YAQUI2   | 3            |         |    |         |     |         |    |         |     |         |         |         |     |         |     |        |   |  |  |
| XR24     | YAQUI2   | 3            |         |    |         |     |         |    |         |     |         |         |         |     |         |     |        |   |  |  |
| XTE      | PARTGEN  | 7            | PARTMOV | 7  |         |     |         |    |         |     |         |         |         |     |         |     |        |   |  |  |
| XW8      | PARTMOV  | 5            |         |    |         |     |         |    |         |     |         |         |         |     |         |     |        |   |  |  |
| XWL      | PARTMOV  | 5            |         |    |         |     |         |    |         |     |         |         |         |     |         |     |        |   |  |  |
| XWR      | PARTMOV  | 5            |         |    |         |     |         |    |         |     |         |         |         |     |         |     |        |   |  |  |
| XWT      | PARTMOV  | 5            |         |    |         |     |         |    |         |     |         |         |         |     |         |     |        |   |  |  |
| XX       | YASET1   | 9            | MESHMKR | 14 | YAQUI2  | 91  | PARTMOV | 7  | REZONE  | 1   |         |         |         |     |         |     |        |   |  |  |
| XXX      | REZONE   | 6            |         |    |         |     |         |    |         |     |         |         |         |     |         |     |        |   |  |  |
| XY       | YAQUI2   | 5            |         |    |         |     |         |    |         |     |         |         |         |     |         |     |        |   |  |  |
| XY14     | YAQUI2   | 3            |         |    |         |     |         |    |         |     |         |         |         |     |         |     |        |   |  |  |
| XY21     | YAQUI2   | 3            |         |    |         |     |         |    |         |     |         |         |         |     |         |     |        |   |  |  |
| XY23     | YAQUI2   | 3            |         |    |         |     |         |    |         |     |         |         |         |     |         |     |        |   |  |  |
| XY34     | YAQUI2   | 3            |         |    |         |     |         |    |         |     |         |         |         |     |         |     |        |   |  |  |
| X1       | YASET1   | 3            | YAQUI2  | 41 | PARTMOV | 110 | REZONE  | 3  |         |     |         |         |         |     |         |     |        |   |  |  |
| X12      | YAQUI2   | 9            |         |    |         |     |         |    |         |     |         |         |         |     |         |     |        |   |  |  |
| X2       | YASET1   | 2            | YAQUI2  | 28 | PARTMOV | 30  | REZONE  | 3  |         |     |         |         |         |     |         |     |        |   |  |  |
| X23      | YAQUI2   | 9            |         |    |         |     |         |    |         |     |         |         |         |     |         |     |        |   |  |  |
| X24      | YAQUI2   | 6            |         |    |         |     |         |    |         |     |         |         |         |     |         |     |        |   |  |  |
| X3       | YASET1   | 3            | YAQUI2  | 29 | PARTMOV | 30  | REZONE  | 3  |         |     |         |         |         |     |         |     |        |   |  |  |
| X31      | YAQUI2   | 6            |         |    |         |     |         |    |         |     |         |         |         |     |         |     |        |   |  |  |
| X34      | YAQUI2   | 9            |         |    |         |     |         |    |         |     |         |         |         |     |         |     |        |   |  |  |
| X4       | YASET1   | 2            | YAQUI2  | 28 | PARTMOV | 30  | REZONE  | 4  |         |     |         |         |         |     |         |     |        |   |  |  |
| X41      | YAQUI2   | 9            |         |    |         |     |         |    |         |     |         |         |         |     |         |     |        |   |  |  |
| Y        | YAQUI    | D            | FILMCO  | 20 | YASET1  | 40  | PARTGEN | D  | MESHMKR | 12D | YAQUI2  | 54D     | PARTMOV | 8D  | REZONE  | 23D |        |   |  |  |
| S YAQUI  | YAQUI    | 1            |         |    |         |     |         |    |         |     |         |         |         |     |         |     |        |   |  |  |
| S YAQUI1 | YAQUI1   | 1            |         |    |         |     |         |    |         |     |         |         |         |     |         |     |        |   |  |  |
| S YAQUI2 | YAQUI1   | 1            | YAQUI2  | 1  |         |     |         |    |         |     |         |         |         |     |         |     |        |   |  |  |
| S YASET  | YASET    | 1            |         |    |         |     |         |    |         |     |         |         |         |     |         |     |        |   |  |  |
| S YASET1 | YASET    | 1            | YASET1  | 1  |         |     |         |    |         |     |         |         |         |     |         |     |        |   |  |  |
| Y8       | YAQUI    | C            | LOOP    | C  | FILMCO  | 7C  | YASET1  | 2C | PARTGEN | C   | MESHMKR | 2C      | YAQUI2  | 13C | PARTMOV | C   | REZONE | C |  |  |
| Y8AR     | REZONE   | 2            |         |    |         |     |         |    |         |     |         |         |         |     |         |     |        |   |  |  |



\* U. S. GOVERNMENT PRINTING OFFICE: 1975 - 786-278/5

| INDEX  | 01/12/73  | MASTER INDEX |           |            |           |           |            |           |          |  |  | PAGE 95 |
|--------|-----------|--------------|-----------|------------|-----------|-----------|------------|-----------|----------|--|--|---------|
| Y80T   | PARTGEN 4 |              |           |            |           |           |            |           |          |  |  |         |
| YC     | PARTGEN 7 | REZONE 3     |           |            |           |           |            |           |          |  |  |         |
| YCEN   | REZONE 2  |              |           |            |           |           |            |           |          |  |  |         |
| YCD    | YAQUI2 4D |              |           |            |           |           |            |           |          |  |  |         |
| YCONV  | YAQUI C   | LOOP C       | FILMCO 1C | YASET1 C   | PARTGEN C | MESHMKR C | YAQUI2 11C | PARTMOV C | REZONE C |  |  |         |
| YD     | PARTGEN 6 |              |           |            |           |           |            |           |          |  |  |         |
| YJC2   | MESHMKR 2 |              |           |            |           |           |            |           |          |  |  |         |
| YJP2   | REZONE 4  |              |           |            |           |           |            |           |          |  |  |         |
| L YLC1 | YAQUI 1   | YASET1 1     | PARTGEN 1 | YAQUI2 1   |           |           |            |           |          |  |  |         |
| L YLC2 | YAQUI 1   | YASET1 1     | PARTGEN 1 | YAQUI2 1   |           |           |            |           |          |  |  |         |
| YMAX   | PARTGEN 3 |              |           |            |           |           |            |           |          |  |  |         |
| YMIN   | PARTGEN 3 |              |           |            |           |           |            |           |          |  |  |         |
| YOMSUM | REZONE 4  |              |           |            |           |           |            |           |          |  |  |         |
| YPAR   | YAQUI D   | FILMCO D     | YASET1 D  | PARTGEN 10 | MESHMKR D | YAQUI2 D  | PARTMOV 3D | REZONE D  |          |  |  |         |
| L YSC1 | YAQUI 1   | LOOP 1       | FILMCO 1  | YASET1 1   | PARTGEN 1 | MESHMKR 1 | YAQUI2 1   | PARTMOV 1 | REZONE 1 |  |  |         |
| L YSC2 | YAQUI 1   | LOOP 1       | FILMCO 1  | YASET1 1   | PARTGEN 1 | MESHMKR 1 | YAQUI2 1   | PARTMOV 1 | REZONE 1 |  |  |         |
| L YSC3 | YAQUI2 1  | PARTMOV 1    |           |            |           |           |            |           |          |  |  |         |
| YT     | YAQUI C   | LOOP C       | FILMCO 5C | YASET1 C   | PARTGEN C | MESHMKR C | YAQUI2 2C  | PARTMOV C | REZONE C |  |  |         |
| YTE    | PARTGEN 6 | PARTMOV 7    |           |            |           |           |            |           |          |  |  |         |
| YT0P   | PARTGEN 4 |              |           |            |           |           |            |           |          |  |  |         |
| YY     | FILMCO 14 | MESHMKR 8    | YAQUI2 20 | PARTMOV 2  | REZONE 12 |           |            |           |          |  |  |         |
| Y1     | YASET1 5  | YAQUI2 31    | REZONE 3  |            |           |           |            |           |          |  |  |         |
| Y14    | YAQUI2 10 |              |           |            |           |           |            |           |          |  |  |         |
| Y2     | YASET1 3  | YAQUI2 27    | REZONE 7  |            |           |           |            |           |          |  |  |         |
| Y21    | YAQUI2 10 |              |           |            |           |           |            |           |          |  |  |         |
| Y24    | YAQUI2 10 |              |           |            |           |           |            |           |          |  |  |         |
| Y3     | YASET1 5  | YAQUI2 28    | REZONE 3  |            |           |           |            |           |          |  |  |         |
| Y31    | YAQUI2 13 |              |           |            |           |           |            |           |          |  |  |         |
| Y32    | YAQUI2 10 |              |           |            |           |           |            |           |          |  |  |         |
| Y4     | YASET1 3  | YAQUI2 27    | REZONE 8  |            |           |           |            |           |          |  |  |         |
| Y43    | YAQUI2 10 |              |           |            |           |           |            |           |          |  |  |         |
| ZZ     | YAQUI C   | LOOP C       | FILMCO C  | YASET1 1C  | PARTGEN C | MESHMKR C | YAQUI2 1C  | PARTMOV C | REZONE C |  |  |         |

| INDEX            | 01/12/73     | MASTER INDEX |              |              |              |              |              |              |              |              |              | PAGE 96 |
|------------------|--------------|--------------|--------------|--------------|--------------|--------------|--------------|--------------|--------------|--------------|--------------|---------|
| ROUTINES INDEXED |              |              |              |              |              |              |              |              |              |              |              |         |
| ROUTINE PAGE     | ROUTINE PAGE | ROUTINE PAGE | ROUTINE PAGE | ROUTINE PAGE | ROUTINE PAGE | ROUTINE PAGE | ROUTINE PAGE | ROUTINE PAGE | ROUTINE PAGE | ROUTINE PAGE | ROUTINE PAGE |         |
| FILMCO 9         | MESHMKR 29   | PARTMOV 68   | YAQUI 2      | YAQUI2 38    | YASET1 17    |              |              |              |              |              |              |         |
| LOOP 5           | PARTGEN 24   | REZONE 79    | YAQUI1 36    | YASET 15     |              |              |              |              |              |              |              |         |
| MASTER INDEX     | 85           |              |              |              |              |              |              |              |              |              |              |         |

| INDEX                                   | 01/12/73 | MASTER INDEX |  |  |  |  |  |  |  |  |  | PAGE 97 |
|-----------------------------------------|----------|--------------|--|--|--|--|--|--|--|--|--|---------|
| *****END OF COMPUTATION*****            |          |              |  |  |  |  |  |  |  |  |  |         |
| 2183 CARDS PROCESSED                    |          |              |  |  |  |  |  |  |  |  |  |         |
| 2835 MAXIMUM BUFFER USED BY ANY ROUTINE |          |              |  |  |  |  |  |  |  |  |  |         |
| 2048 TOTAL ECS REQUIRED BY INDEX        |          |              |  |  |  |  |  |  |  |  |  |         |
| 7.454 SECONDS OF CP TIME USED           |          |              |  |  |  |  |  |  |  |  |  |         |
| *****                                   |          |              |  |  |  |  |  |  |  |  |  |         |

RECEIVED

MAY 27 '73

UNIVERSITY LIBRARIES