



Owner's Manual IPS LED MONITOR (LED MONITOR*)

*LG LED Monitors are LCD Monitors with LED Backlighting.

Please read this manual carefully before operating your set and retain it for future reference.

IPS LED MONITOR MODEL

20MP38A	20MP48A	22MP48A	23MP48D	24MP48HQ	27MP48HQ
20MP38H		22MP48D	23MP48HQ		
20MP38HQ		22MP48HQ			

CONTENTS

3 LICENSE

- 29 -Picture Mode
- 30 -Color Weakness

4 ASSEMBLING AND PREPARING

- 4 Unpacking
- 6 Parts and buttons
- 7 Parts and buttons
- 8 Parts and buttons
- 9 Moving and Lifting the Monitor
- 10 Setting up the Monitor set
- 10 - Attaching the Stand Base
- 11 - Mounting on a table
- 12 - Using the cable holder
- 15 - Mounting on a wall

16 USING THE MONITOR SET

- 16 Connecting to a PC
- 16 - D-SUB connection
- 16 - DVI-D connection
- 17 - HDMI connection
- 17 Connecting to AV Devices
- 17 - HDMI connection
- 18 Connecting to External Devices
- 18 - Peripheral device connection

19 CUSTOMIZING SETTINGS

- 21 Customizing Settings
- 21 - Menu Settings
- 23 -Picture
- 24 -Color
- 25 -Display
- 25 -Audio
- 26 -Others
- 27 READER Setting
- 28 FUNC. Setting
- 28 -SMART ENERGY SAVING

31 TROUBLESHOOTING

33 SPECIFICATIONS

- 43 Factory Support Mode
(Preset Mode, D-SUB/DVI/HDMI PC)
- 44 HDMI Timing(Video)
- 44 Indicator

20MP38H 20MP38HQ 22MP48HQ 23MP48HQ 24MP48HQ 27MP48HQ

LICENSE

Each model has different licenses. Visit www.lg.com for more information on the license.



The terms HDMI and HDMI High-Definition Multimedia Interface, and the HDMI logo are trademarks or registered trademarks of HDMI Licensing LLC in the United States and other countries.

The following content is only applied to the monitor which is sold in Europe market and which needs to meet the ErP Directive:











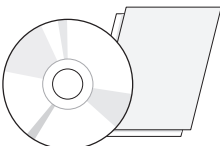
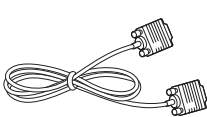
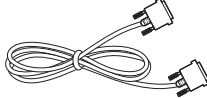











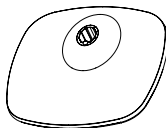

*This monitor is set to be turned off automatically in 4 hours after you turned on display if there is no adjustment to display.

*To make this setting be disabled, change the option to 'Off' in OSD menu of "Automatic Standby".

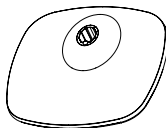
ASSEMBLING AND PREPARING

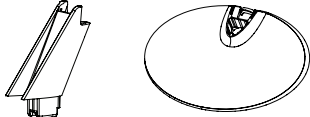
Unpacking

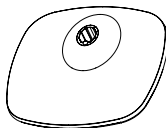
Check your product box for the following items. If there are any missing accessories, contact the local dealer where you purchased your product. The illustrations in this manual may differ from the actual product and accessories.

									
<p>CD(Owner's Manual) / Card</p>	<p>D-SUB Cable (This cable is not included in all countries.)</p>	<p>DVI-D Cable 22MP48D 23MP48D (This cable is not included in all countries.)</p>							
<table> <tr> <td data-bbox="178 753 370 859">  </td> <td data-bbox="480 753 768 859">  </td> </tr> <tr> <td colspan="2" data-bbox="205 859 740 898"> <p>Power Cord AC-DC Adapter</p> </td> </tr> <tr> <td colspan="2" data-bbox="301 908 603 937"> <p>(Depending on the country)</p> </td> </tr> </table>				<p>Power Cord AC-DC Adapter</p>		<p>(Depending on the country)</p>		<p>or</p>	
									
<p>Power Cord AC-DC Adapter</p>									
<p>(Depending on the country)</p>									
<table> <tr> <td data-bbox="260 1043 343 1168">  </td> <td data-bbox="466 1062 651 1149">  </td> </tr> <tr> <td colspan="2" data-bbox="219 1168 617 1207"> <p>Stand Body Stand Base</p> </td> </tr> </table>				<p>Stand Body Stand Base</p>					
									
<p>Stand Body Stand Base</p>									
<p> 20MP48A 22MP48A 23MP48D 24MP48HQ 22MP48D 23MP48HQ 22MP48HQ </p>		<p>HDMI Cable 20MP38H 23MP48HQ 20MP38HQ 24MP48HQ 22MP48HQ 27MP48HQ (This cable is not included in all countries.)</p>							
<table> <tr> <td data-bbox="219 1400 281 1526">  </td> <td data-bbox="404 1400 569 1526">  </td> <td data-bbox="665 1468 747 1516">  </td> </tr> <tr> <td colspan="3" data-bbox="171 1545 782 1574"> <p>Stand Body Stand Base Cable holder</p> </td> </tr> </table>						<p>Stand Body Stand Base Cable holder</p>			
									
<p>Stand Body Stand Base Cable holder</p>									
<p>27MP48HQ</p>			<p> 20MP38A 20MP38H 20MP38HQ </p>						

**CAUTION**

- Do not use any unapproved accessories to ensure the safety and product life span.
- Any damages or injuries by using unapproved accessories are not covered by the warranty.

**NOTE**

- The accessories supplied with your product may vary depending on the model.
- Product specifications or contents in this manual may be changed without prior notice due to upgrade of product functions.

Parts and buttons

- 22MP48A 23MP48D
- 22MP48D 23MP48HQ
- 22MP48HQ

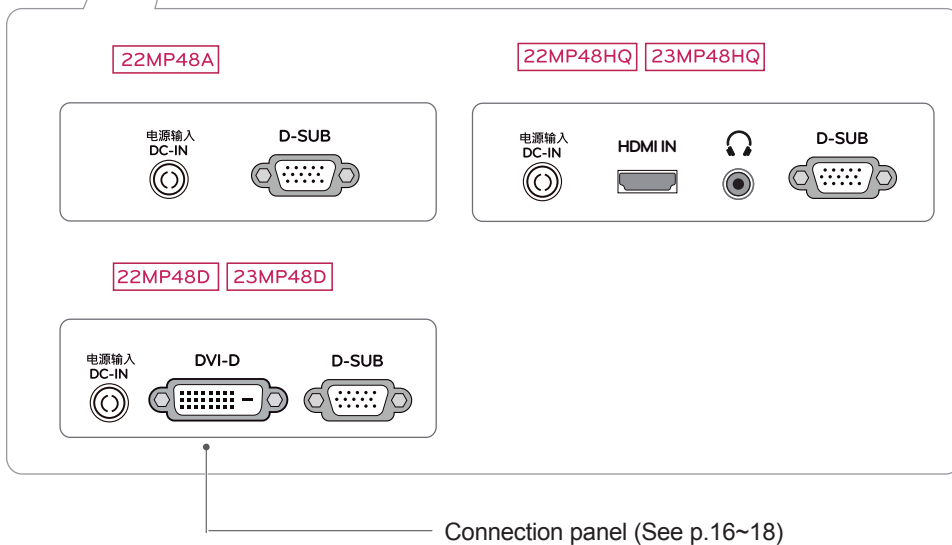
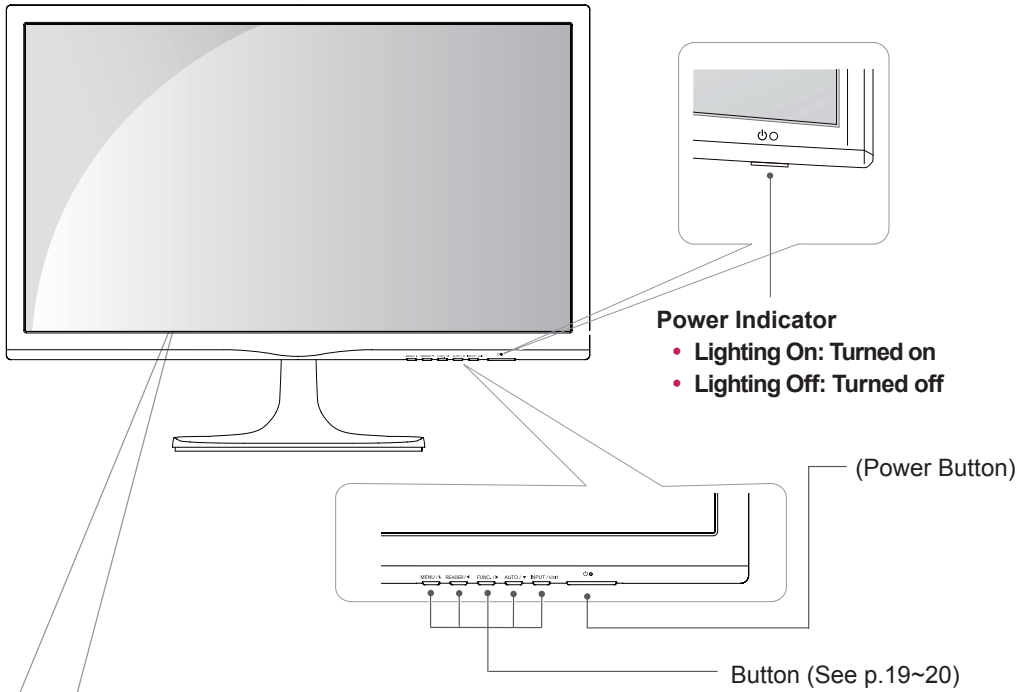

NOTE

- The button is located at the bottom of the monitor.

Parts and buttons

20MP48A 24MP48HQ 27MP48HQ

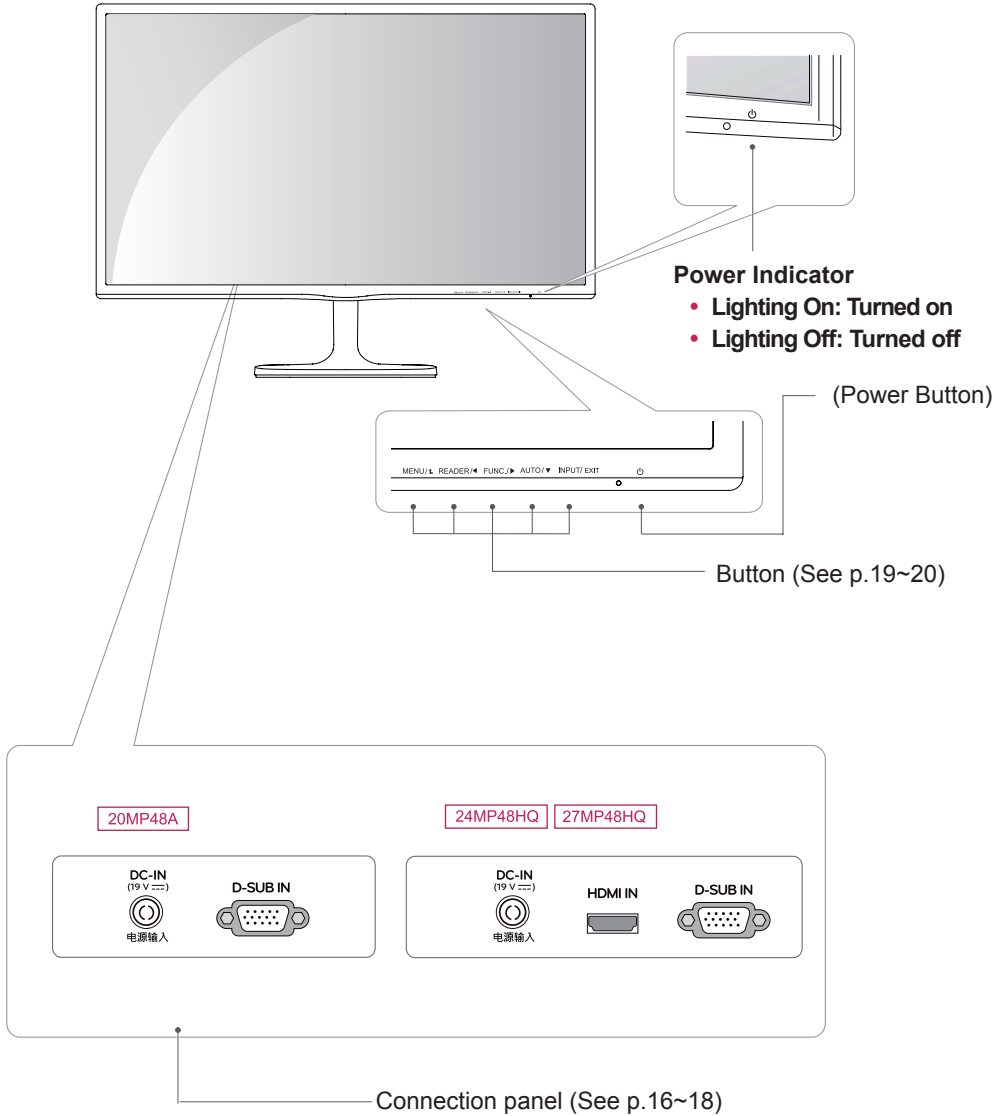

NOTE

- The button is located at the bottom of the monitor.

Parts and buttons

20MP38A 20MP38H 20MP38HQ

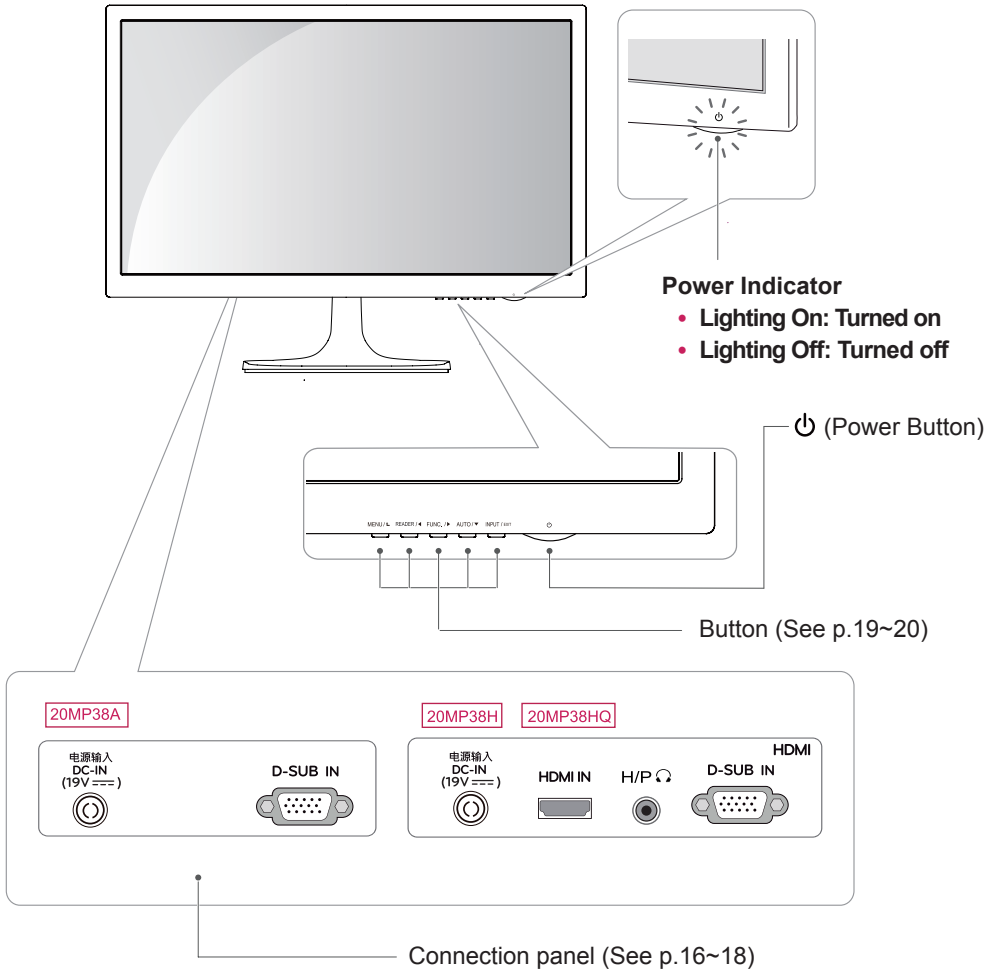

Moving and Lifting the Monitor

When moving or lifting the monitor, follow these instructions to prevent the monitor from being scratched or damaged and to ensure safe transportation regardless of its shape or size.

- It is advisable to place the monitor in the original box or packing material before attempting to move it.
- Before moving or lifting the monitor, disconnect the power cord and all cables.
- Hold the top and bottom of the monitor frame firmly. Do not hold the panel itself.

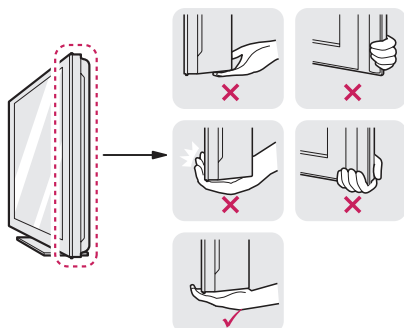

- When holding the monitor, the screen should face away from you to prevent it being scratched.



- When moving the monitor, avoid any strong shock or vibrations to the product.
- When moving the monitor, keep it upright, never turn the monitor on its side or tilt it sideways.



CAUTION

- As far as possible, avoid touching the monitor screen. This may result in damage to the screen or some of the pixels used to create images.

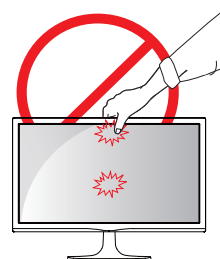

Setting up the Monitor set

Attaching the Stand Base

- 1 Place the Monitor set with the screen side down on a flat and cushioned surface.

CAUTION
Lay a foam mat or soft protective cloth on the surface to protect the screen from damage.

- 2 **1** Attach the **Stand Body** to the monitor set.
- 2 Attach the **Stand Base**.
- 3 Tighten the screw to the right with a coin.

- 22MP48A 23MP48D
- 22MP48D 23MP48HQ
- 22MP48HQ

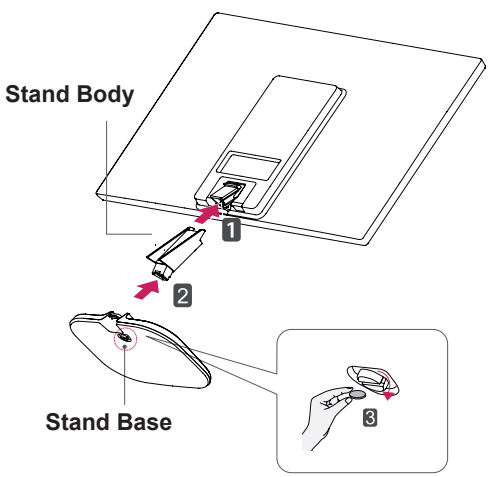

- 20MP38A 20MP38H 20MP38HQ

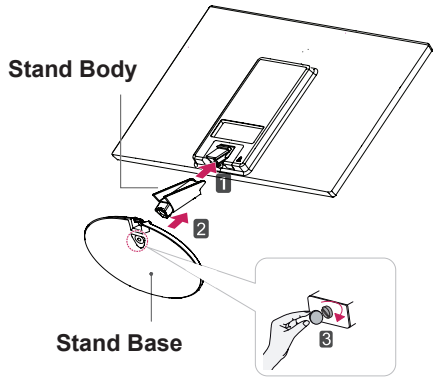

- 20MP48A 24MP48HQ

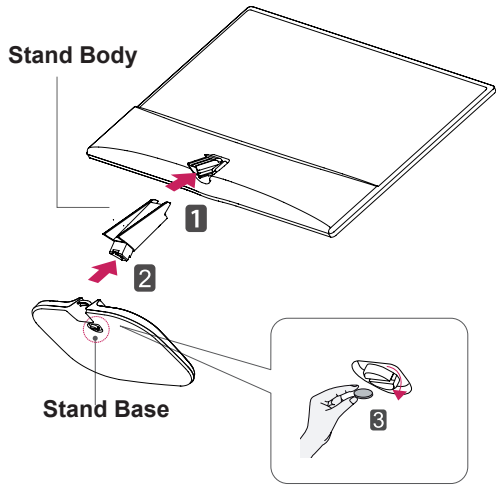

- 1 Insert the **Cable Holder**.
- 2 Attach the **Stand Body** to the monitor set.
- 3 Attach the **Stand Base** to **Stand Body**.
- 4 Tighten the screw to the right.

- 27MP48HQ

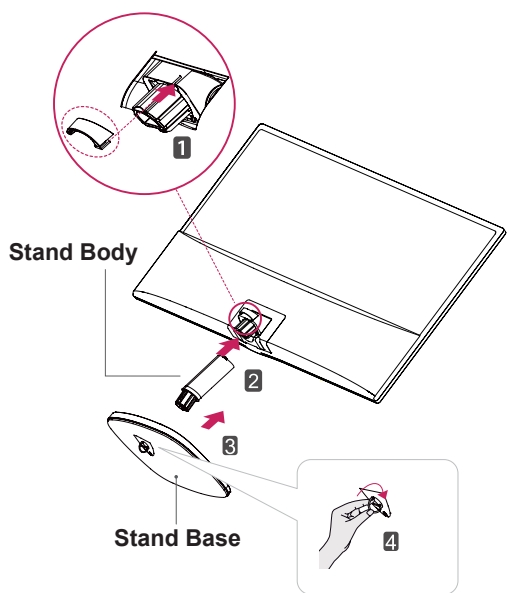

NOTE
• You can disassemble the stand in the reverse order of the assembly.

Mounting on a table

- Lift and tilt the Monitor set into its upright position on a table.
Leave a 100 mm (minimum) space from the wall for proper ventilation.

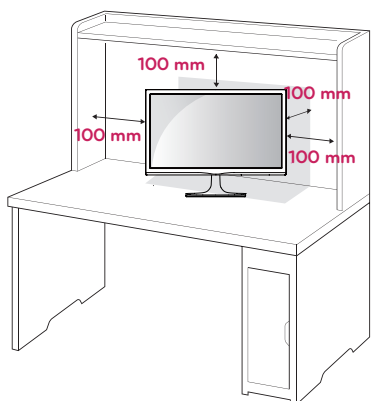

- Connect the AC-DC Adapter and Power Cord to a wall outlet.

22MP48A 23MP48D
22MP48D 23MP48HQ
22MP48HQ

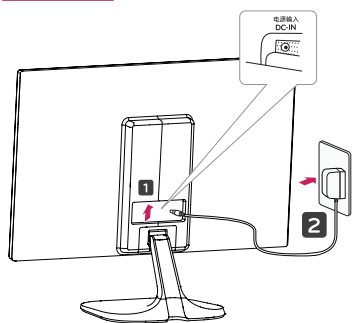

or

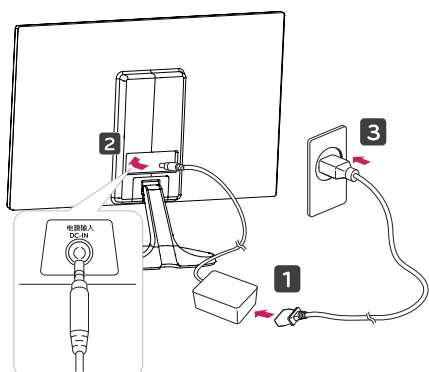

20MP48A

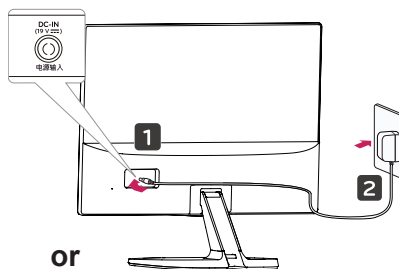

or

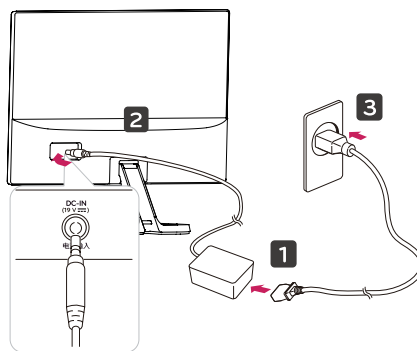

24MP48HQ 27MP48HQ

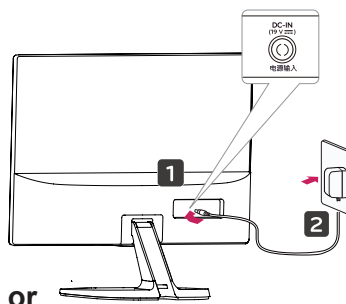

or

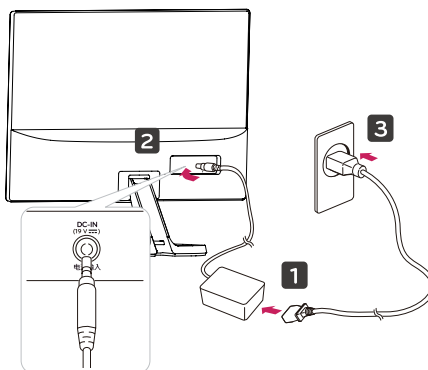

20MP38A 20MP38H 20MP38HQ

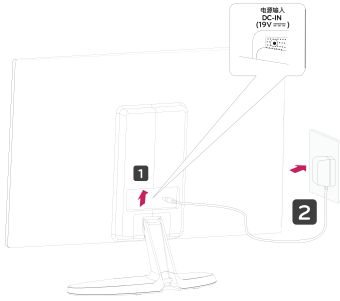

or

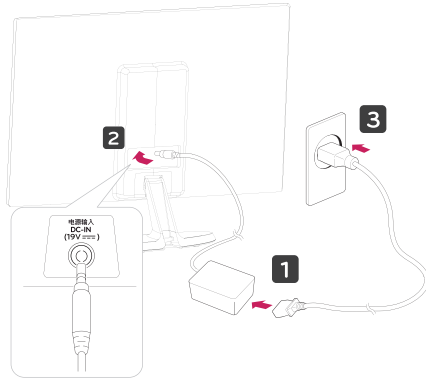

- 3 Press (Power) button on the bottom switch panel to turn the power on.



CAUTION

Unplug the power cord before moving the Monitor to another location. Otherwise electric shock may occur.

Using the cable holder

22MP48A 23MP48D
22MP48D 23MP48HQ
22MP48HQ

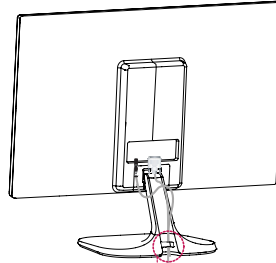

Cable holder

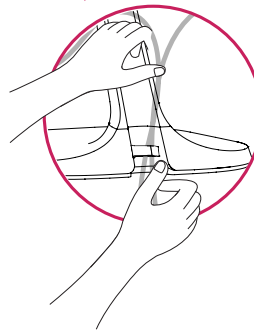

20MP38A 20MP38H 20MP38HQ

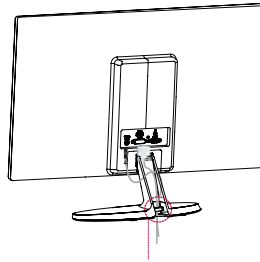

Cable holder

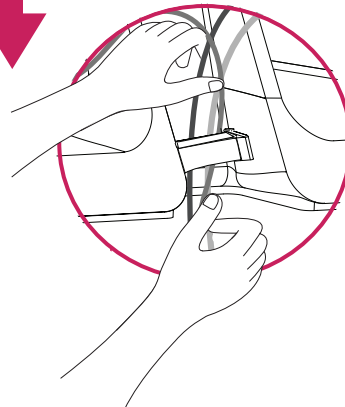

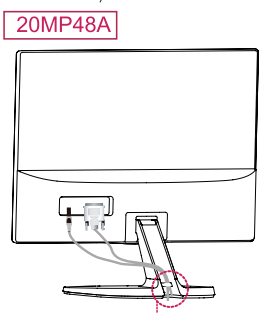

Cable holder

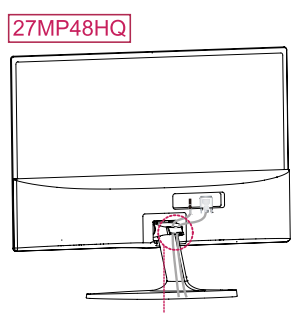
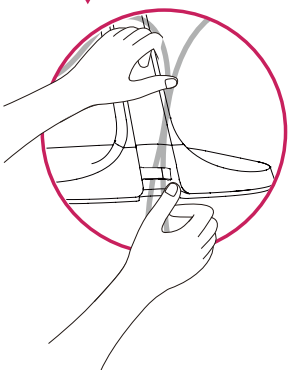

Cable holder

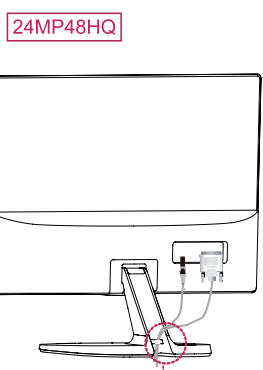
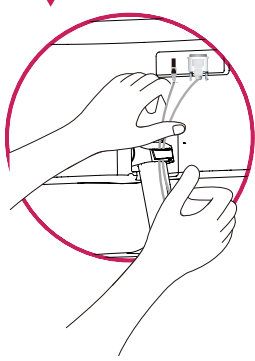

Cable holder

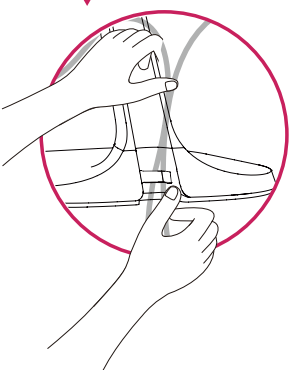

! WARNING

When you adjust the angle, do not hold the bottom of the Monitor set frame as shown on the following illustration, as may injure your fingers.

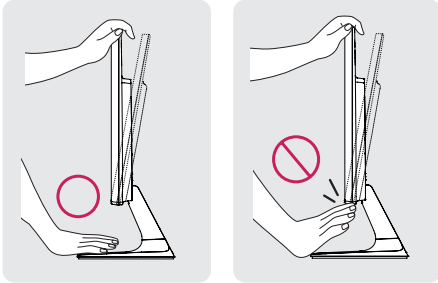

Do not touch or press the screen when adjusting the angle of the monitor.

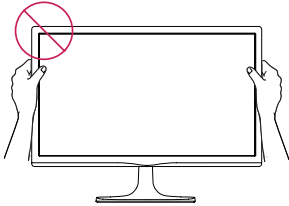

Do not hold this set like below picture. Monitor screen can detach from stand base and injure your body.

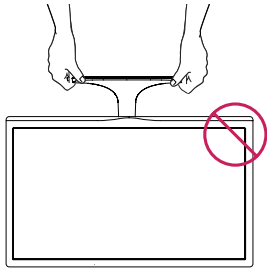

! NOTE

20MP38A	20MP48A	22MP48A	23MP48D
20MP38H		22MP48D	23MP48HQ
20MP38HQ		22MP48HQ	24MP48HQ

Tilt from +20 to -5 degrees up or down to adjust the angle of the Monitor set to suit your view.

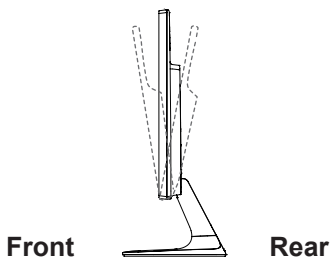

! NOTE

27MP48HQ

Tilt from +20 to -3 degrees up or down to adjust the angle of the Monitor set to suit your view.



Using the Kensington security system

The Kensington security system connector is located at the back of the Monitor set. For more information of installation and using, refer to the manual supplied with the Kensington security system or visit <http://www.kensington.com>.

Connect the Kensington security system cable between the Monitor set and a table.

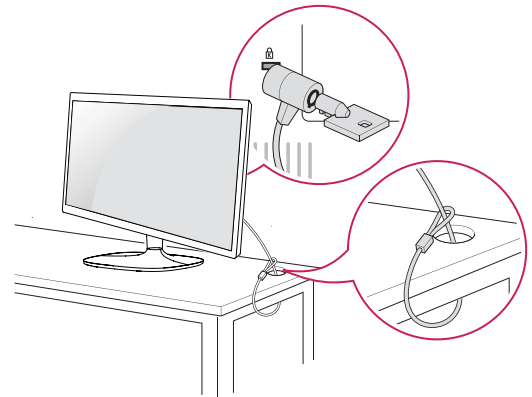

! NOTE

The Kensington security system is optional. You can obtain it from most electronics stores.

Mounting on a wall

For proper ventilation, allow a clearance of 100 mm on each side and from the wall. Detailed instructions are available from your dealer, see the optional Tilt Wall Mounting Bracket Installation and Setup Guide.

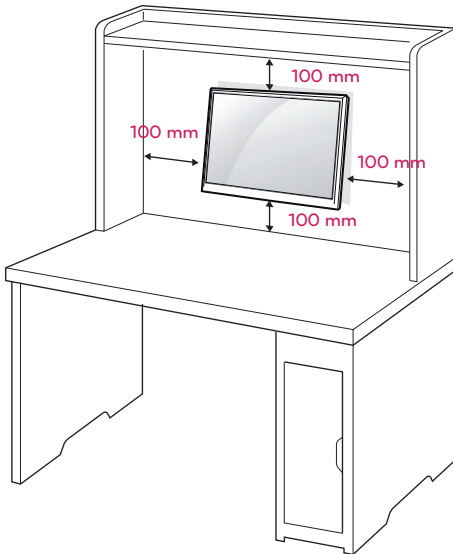

If you intend to mount the Monitor set to a wall, attach Wall mounting interface (optional parts) to the back of the set.

When you install the Monitor set using a wall mounting interface (optional parts), attach it carefully so it will not drop.

- 1 If you use screw longer than standard, the monitor might be damaged internally.
- 2 If you use improper screw, the product might be damaged and drop from mounted position. In this case, LG Electronics is not responsible for it.

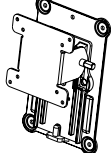
Model	22MP48A 22MP48D 22MP48HQ	23MP48D 23MP48HQ	20MP38A 20MP38H 20MP38HQ
Wall Mount (A x B)	75 x 75		100 x 100
Standard screw	M4 x L10		
Number of screws	4		
Wall Mount Plate (Optional)	RW120 		

- Wall Mount (A x B)

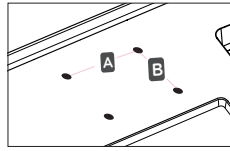

CAUTION

- Disconnect the power cord first, and then move or install the Monitor set. Otherwise electric shock may occur.
- If you install the Monitor set on a ceiling or slanted wall, it may fall and result in severe injury.
- Use only an authorized LG wall mount and contact the local dealer or qualified personnel.
- Do not over tighten the screws as this may cause damage to the Monitor set and void your warranty.
- Use only screws and wall mounts that meet the VESA standard. Any damages or injuries by misuse or using an improper accessory are not covered by the warranty.
- Screw length from outer surface of back cover should be under 8mm.

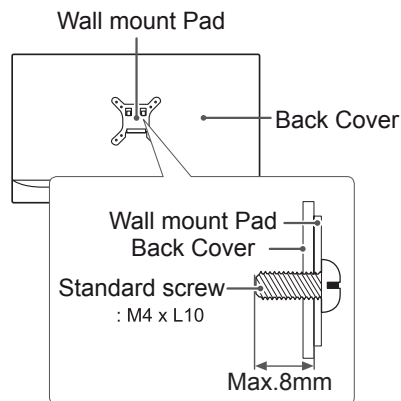

NOTE

- Use the screws that are listed on the VESA standard screw specifications.
- The wall mount kit will include an installation manual and necessary parts.
- The wall mount bracket is optional. You can obtain additional accessories from your local dealer.
- The length of screws may differ depending on the wall mount. Be sure to use the proper length.
- For more information, refer to the instructions supplied with the wall mount.

USING THE MONITOR SET

Connecting to a PC

- Your Monitor set supports Plug & Play*.
- *Plug & Play: A PC recognizes a connected device that users connect to a PC and turn on, without device configuration or user intervention.

D-SUB connection

Transmits analog video from your PC to the Monitor set. Connect the PC and the Monitor set with the supplied D-sub 15 pin signal cable as shown in the following illustrations.

22MP48A	23MP48D	20MP38A	20MP48A	24MP48HQ
22MP48D	23MP48HQ	20MP38H	27MP48HQ	
22MP48HQ		20MP38HQ		

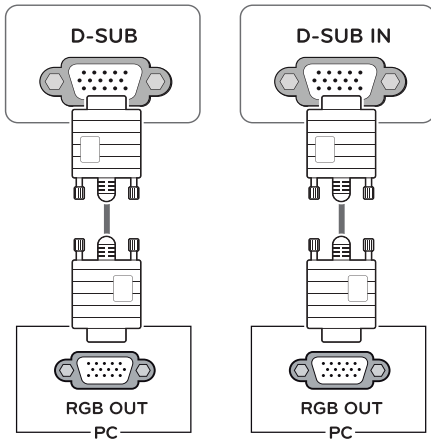

DVI-D connection

Transmits a digital video signal from your PC to the Monitor set. Connect the PC and the Monitor set with a DVI cable as shown in the following illustrations.

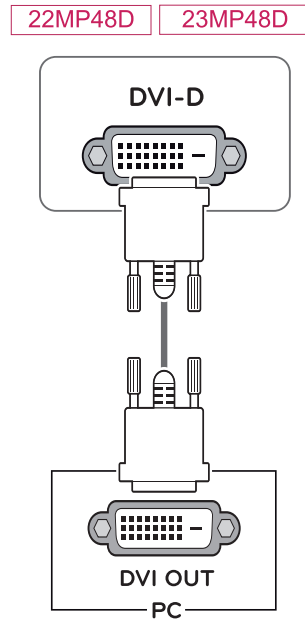

NOTE

- When using a D-Sub signal input cable connector for Macintosh

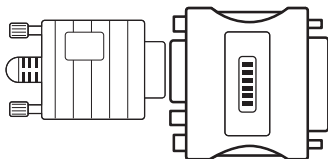

Mac adapter

For Apple Macintosh use, a separate plug adapter is needed to change the 15 pin high density (3 row) D-SUB VGA connector on the supplied cable to a 15 pin 2 row connector.

CAUTION

- Connect the signal input cable and tighten it by turning the screws clockwise.
- Do not press the screen with your finger for a long time as this may result in temporary distortion on the screen.
- Avoid displaying a fixed image on the screen for a long period of time to prevent image burn. Use a screensaver if possible.

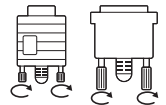

HDMI connection

Transmits the digital video and audio signals from your PC to the Monitor set. Connect the PC and the Monitor set with the HDMI cable as shown in the following illustrations.

20MP38H	22MP48HQ	24MP48HQ
20MP38HQ	23MP48HQ	27MP48HQ

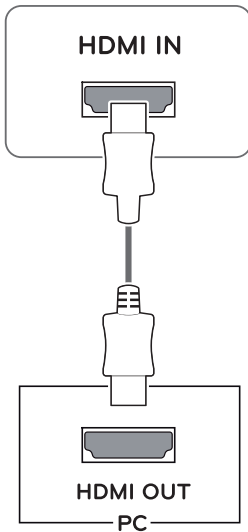

NOTE

- If you use HDMI PC, it can cause compatibility problem.
- Use a certified cable with the HDMI logo attached. If you do not use a certified HDMI cable, the screen may not display or a connection error may occur.
- Recommended HDMI cable types
 - High-Speed HDMI^{®/™} Cable
 - High-Speed HDMI^{®/™} Cable with Ethernet

NOTE

- When you want to use two PC in our Monitor, please connect the signal cable(D-SUB/ DVI-D/HDMI) respectively in Monitor set.
- If you turn the Monitor set on while it is cold, the screen may flicker. This is normal.
- Some red, green, or blue spots may appear on the screen. This is normal.

Connecting to AV Devices

HDMI connection

Transmits the digital video and audio signals from your AV devices to the monitor. Connect your AV device to the monitor with the HDMI cable as illustrated below.

20MP38H	22MP48HQ	24MP48HQ
20MP38HQ	23MP48HQ	27MP48HQ

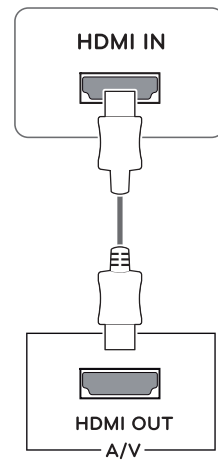

NOTE

- If you use HDMI PC, it can cause compatibility problem.
- Use a certified cable with the HDMI logo attached. If you do not use a certified HDMI cable, the screen may not display or a connection error may occur.
- Recommended HDMI cable types
 - High-Speed HDMI^{®/™} Cable
 - High-Speed HDMI^{®/™} Cable with Ethernet

Connecting to External Devices

Peripheral device connection

Connect peripheral devices to the monitor using headphone ports.

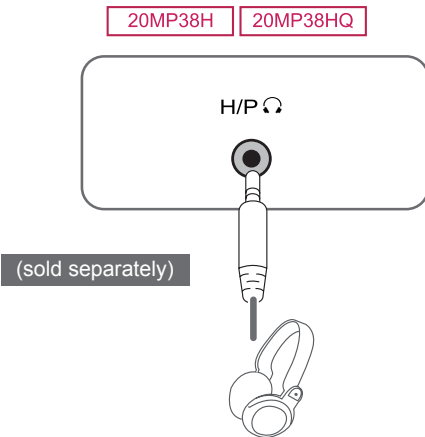
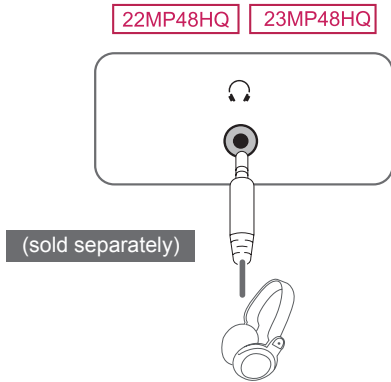

NOTE

- Peripheral devices are sold separately.
- Cables with angled plugs may have clearance issues, use straight plugs when possible.



Angle Type

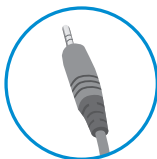

Straight Type

NOTE

- Headphones or speakers may not work normally, depending on the server PC settings.

Self Image Setting Function

Press the power button on the bottom panel to turn the power on. When monitor power is turned on, the "Self Image Setting" Function is executed automatically. (Only supported in Analog Mode)

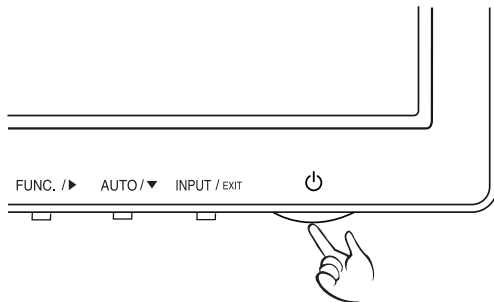
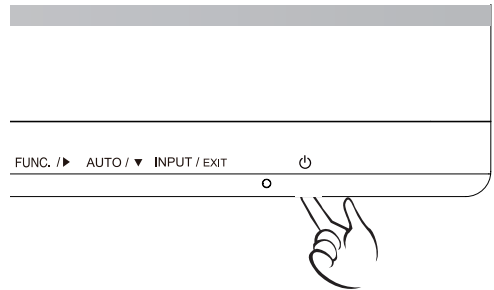
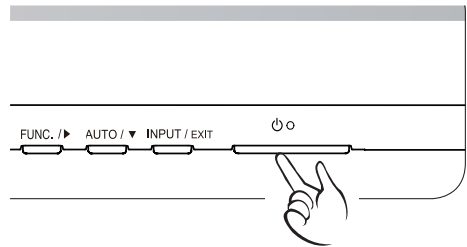

NOTE

- **"Self Image Setting" Function.**
This function provides the user with optimal display settings. When the user connects the monitor for the first time, this function automatically adjusts the display to optimal settings for individual input signals. (Only supported in Analog Mode)
- **'AUTO' Function.**
When you encounter problems such as blurry screen, blurred letters, screen flicker or tilted screen while using the device or after changing screen resolution, press the AUTO function button to improve resolution. (Only supported in Analog Mode)

CUSTOMIZING SETTINGS

- 1 Press the desired button on the bottom of the Monitor set.
- 2 Change the value of the menu item by pressing the buttons on the bottom of the Monitor set.
To return to the upper menu or set other menu items, use the up arrow (↑) button.
- 3 Select **EXIT** to leave the OSD menu.

22MP48A 23MP48D
22MP48D 23MP48HQ
22MP48HQ

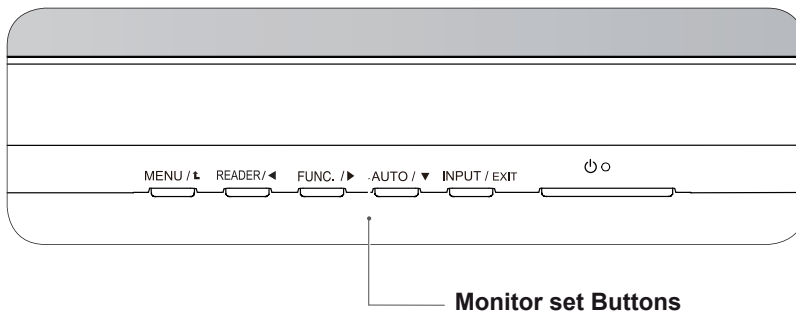

20MP48A 24MP48HQ 27MP48HQ

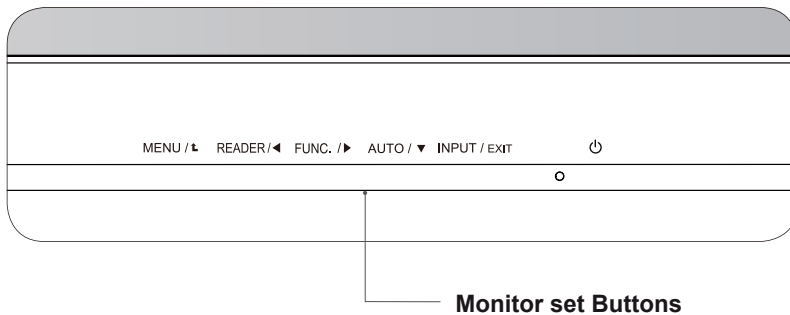



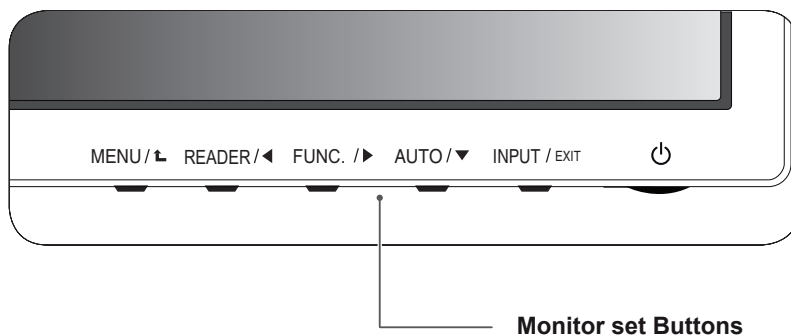



































20MP38A 20MP38H 20MP38HQ



! NOTE

- The button is located at the bottom of the monitor.

Button	Description																								
MENU / 	<p>Accesses the main menus.(See p.21)</p> <p>OSD Locked/OSD Unlocked This function allow you to lock the current control settings, so that they cannot be inadvertently changed. Press and hold the MENU button for several seconds. Then OSD of "OSD Lock" will appear. After that, user can select lock or unlock by pressing left/right button. If user selects the "Lock" icon by pressing the "OK" button, the message "OSD Locked" will appear. Otherwise, "OSD Unlocked" will appear. After selecting the "Lock", If you want to change to Unlock, you can push the "MENU" button for several seconds. The message "OSD Unlocked" will appear.</p>																								
READER / 	Use this button to enter Reader Mode menu. Its function works to display screen as paper-like picture for Eye comfort.If you want to more information(See p.27).																								
FUNC. / 	Use this button to enter SMART ENERGY SAVING , Picture Mode, Color Weakness menus.(See p.28~30)																								
AUTO / 	<p>When adjusting your display settings, always press the AUTO button on the MONITOR SETUP OSD. (Only supported in Analog Mode)</p> <p>The best display mode</p> <table border="1" data-bbox="631 672 1177 859"> <tr> <td></td> <td></td> <td></td> <td></td> </tr> <tr> <td colspan="4">1440 x 900 @ 60 Hz</td> </tr> <tr> <td></td> <td></td> <td></td> <td></td> </tr> <tr> <td></td> <td></td> <td colspan="2"></td> </tr> <tr> <td></td> <td colspan="3"></td> </tr> <tr> <td colspan="4">1920 x 1080 @ 60 Hz</td> </tr> </table>					1440 x 900 @ 60 Hz																1920 x 1080 @ 60 Hz			
																									
1440 x 900 @ 60 Hz																									
																									
																									
																									
1920 x 1080 @ 60 Hz																									
INPUT / EXIT	<p>You can choose the input signal.</p> <ul style="list-style-type: none"> • When two input signals are connected, you can select the input signal (D-SUB/DVI-D/ HDMI) you want. • When only one signal is connected, it is automatically detected. The default setting is D-SUB. <p>EXIT</p> <p>EXIT the OSD(On Screen Display).</p>																								
 (Power Button)	<p>Turns the power on or off.</p> <p>Power Indicator The power indicator stays white if the display is running properly (On Mode). If the display is in Sleep Mode, the power indicator blinks white.</p>																								

Customizing Settings

Menu Settings

- 1 Press **MENU** button on the bottom of the Monitor set to display the **Menu** OSD.
- 2 Set the options by pressing the ◀ or ▶ or ▼ buttons.
- 3 Select the "**Next Menu**" button to enter the more option settings.
- 4 Select **EXIT** to leave the OSD menu.
To return to the upper menu or set other menu items, use the up arrow (⬆) button.

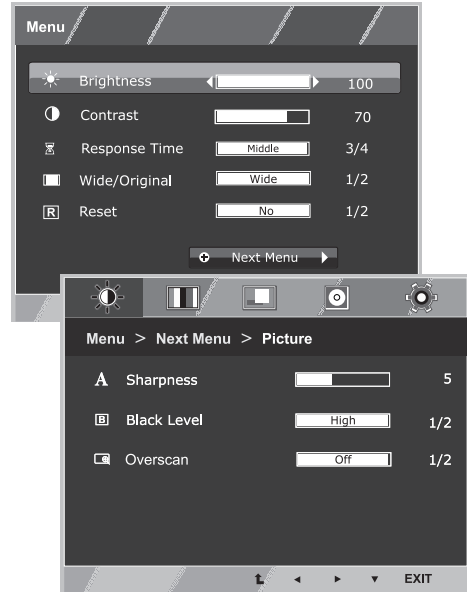

Each option is explained below.

Menu	Analog	Digital	HDMI	Description
Brightness	•	•	•	To adjust the brightness, contrast of the screen.
Contrast	•	•	•	
Response Time 22MP48HQ 24MP48HQ 23MP48HQ 27MP48HQ 20MP38HQ	•		•	You can set a response time for displayed pictures based on the speed of the screen. For a normal environment, it is recommended that you use 'Off'. For a fast-moving picture, it is recommended that you use 'High'.
Wide/Original	•	•	•	Wide
				Switch to full screen mode according to input image signal.
				Original
				Change the input image signal ratio to original. * This function works only if input resolution is lower than Monitor set ratio.
Reset	•	•	•	Restore all factory default settings. Press the ◀ , ▶ buttons to reset immediately.

Menu > Next Menu		Analog	Digital	HDMI	Description
Picture	Sharpness	•	•	•	To adjust the clearness of the screen
	Black Level 20MP38H 22MP48HQ 24MP48HQ 20MP38HQ 23MP48HQ 27MP48HQ			•	To set offset level
	Overscan 20MP38H 22MP48HQ 24MP48HQ 20MP38HQ 23MP48HQ 27MP48HQ			•	To improve the clarity and stability of the screen
Color	Gamma				To customize the color of the screen
	Color Temp	•	•	•	
	Six Color				
	Color Reset				
Display	Horizontal	•			To adjust the position of the screen
	Vertical				
	Clock	•			To improve the clarity and stability of the screen
	Phase				
Audio 20MP38H 22MP48HQ 20MP38HQ 23MP48HQ	Volume			•	To adjust the volume
Others	Language	•	•	•	To customize the screen status for a user's operating environment
	Power Indicator				
	Automatic Standby 20MP38H 22MP48HQ 24MP48HQ 20MP38HQ 23MP48HQ 27MP48HQ	•	•	•	
	Resolution	•			

- **Analog:** D-SUB(Analog signal) input.
- **Digital:** DVI-D(Digital signal) input.
- **HDMI:** HDMI(Digital signal) input.

Picture

- 1 Press **MENU** button on the bottom of the Monitor set to display the **Menu OSD**.
- 2 Select the "**Next Menu**" button to enter the more option settings.
- 3 Enter to **Picture** by pressing the **▼** button.
- 4 Set the options by pressing the **◀** or **▶** or **▼** buttons.
- 5 Select **EXIT** to leave the OSD menu.
To return to the upper menu or set other menu items, use the up arrow (**↑**) button.

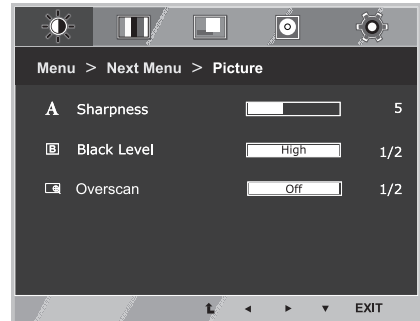

Each option is explained below.

Menu > Next Menu > Picture	Description
Sharpness	To adjust the clearness of the screen.
Black Level 20MP38H 22MP48HQ 24MP48HQ 20MP38HQ 23MP48HQ 27MP48HQ	Sets the offset level (for HDMI only). <ul style="list-style-type: none"> • Offset: as a reference for a video signal, this is the darkest color the monitor can display.
	High Keeps the current contrast ratio of the screen.
	Low Lowers the black levels and raises the white levels from the current contrast ratio of the screen.
Overscan 20MP38H 22MP48HQ 24MP48HQ 20MP38HQ 23MP48HQ 27MP48HQ	To select the range of output image for DTV timing in HDMI input.(only for HDMI input)Recommend overscan function to turn on when connect AV equipment.

Color

- 1 Press **MENU** button on the bottom of the Monitor set to display the **Menu OSD**.
- 2 Select the "**Next Menu**" button to enter the more option settings.
- 3 Select **Color** by pressing the **▶** button.
- 4 Enter to **Color** by pressing the **▼** button.
- 5 Set the options by pressing the **◀** or **▶** or **▼** buttons.
- 6 Select **EXIT** to leave the OSD menu.
To return to the upper menu or set other menu items, use the up arrow (**▲**) button.

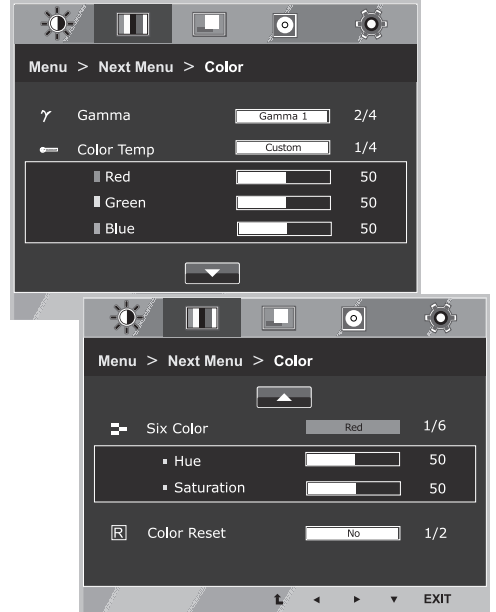

Each option is explained below.

Menu > Next Menu > Color	Description
Gamma	Set your own gamma value. : Gamma 0, Gamma 1, Gamma 2, Off on the monitor, high gamma values display blackish images and low gamma values display whitish images. If user don't want adjusted gamma, user can select Gamma off.
Color Temp	<p>Custom</p> <ul style="list-style-type: none"> • Red:Set your own red color levels. • Green: Set your own green color levels. • Blue:Set your own blue color levels. <p>Select the screen color. Warm: Set the screen to warm color temperature (more red). Medium: Set the screen to medium color temperature. Cool: Set the screen to cool color temperature (more blue).</p>
Six Color	Sets and stores the hue and saturation for six colors(Red/Green/Blue/Cyan/Magenta/Yellow) to satisfy the color requirements of a user.
Hue	Adjusts the screen hue.
Saturation	Adjusts the color sharpness on the screen. Lower values make the color sharpness weaker and colors lighter while higher values make the color sharpness stronger and colors dark.
Color Reset	Resets the color settings to the factory default settings for the current input device.

Display

- 1 Press **MENU** button on the bottom of the Monitor set to display the **Menu OSD**.
- 2 Select the "**Next Menu**" button to enter the more option settings.
- 3 Select **Display** by pressing the ► button.
- 4 Enter to **Display** by pressing the ▼ button.
- 5 Set the options by pressing the ◀ or ▶ or ▼ buttons.
- 6 Select **EXIT** to leave the OSD menu.
To return to the upper menu or set other menu items, use the up arrow (⬆) button.

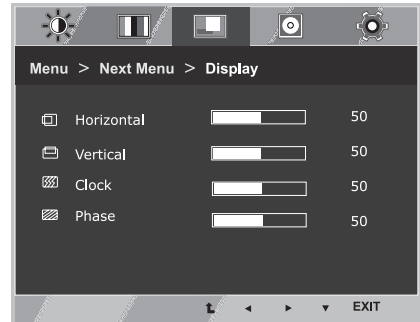

Each option is explained below.

Menu > Next Menu > Display	Description
Horizontal	To move image left and right.
Vertical	To move image up and down.
Clock	To minimize any vertical bars or stripes visible on the screen background. The horizontal screen size will also change.
Phase	To adjust the focus of the display. This item allows you to remove any horizontal noise and clear or sharpen the image of characters.

Audio

20MP38H 22MP48HQ
20MP38HQ 23MP48HQ

- 1 Press **MENU** button on the bottom of the Monitor set to display the **Menu OSD**.
- 2 Select the "**Next Menu**" button to enter the more option settings.
- 3 Select **Audio** by pressing the ► button.
- 4 Enter to **Volume** by pressing the ▼ button.
- 5 Set the options by pressing the ◀ or ▶ buttons.
- 6 Select **EXIT** to leave the OSD menu.
To return to the upper menu or set other menu items, use the up arrow (⬆) button.

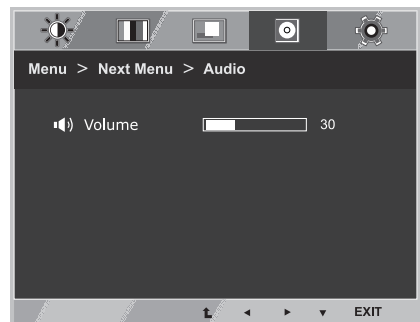

Each option is explained below.

Menu > Next Menu > Audio	Description
Volume	To adjust the volume of headphone/earphone. (Only for HDMI input)

Others

- 1 Press **MENU** button on the bottom of the Monitor set to display the **Menu** OSD.
- 2 Select the "**Next Menu**" button to enter the more option settings.
- 3 Select **Others** by pressing the ► button.
- 4 Enter to **Others** by pressing the ▼ button.
- 5 Set the options by pressing the ◀ or ▶ or ▼ buttons.
- 6 Select **EXIT** to leave the OSD menu.
To return to the upper menu or set other menu items, use the up arrow (⬆) button.

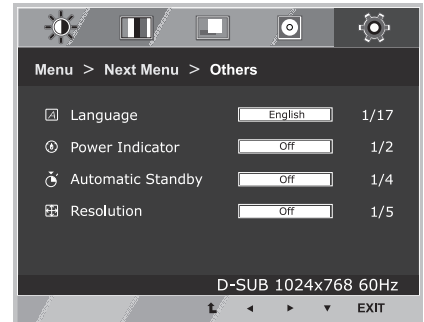

Each option is explained below.

Menu > Next Menu > Others	Description
Language	To choose the language in which the control names are displayed.
Power Indicator	Use this function to set the power indicator on the bottom side of the monitor to On or Off. If you set Off, it will go off. If you set On at any time, the power indicator will automatically be turned on.
Automatic Standby 20MP38H 22MP48HQ 24MP48HQ 20MP38HQ 23MP48HQ 27MP48HQ	The monitor will automatically switch to standby mode after a certain period.
Resolution	User can set the desired resolution. The function is enabled only when the screen resolution on your computer is set to the following, except that the PC output wrong resolution (D-SUB only). Off, 1024x768, 1280x768, 1360x768, 1366x768 Off, 1280x960, 1600x900 Off, 1440x900, 1600x900

READER Setting

- 1 Press **READER** button on the bottom of the Monitor set to display the **Reader Mode** OSD.
- 2 Set the options by pressing the ◀ or ▶ buttons.
- 3 Select **EXIT** to leave the OSD menu.

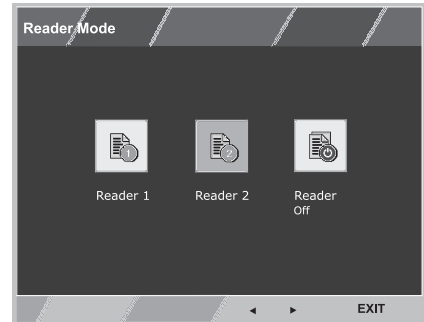

Each option is explained below.

Reader Mode	Description
Reader 1	It is a mode that the screen is adjusted to the best for the newspaper. If you want screen more bright, you can control brightness in Menu OSD.
Reader 2	It is a mode that the screen is adjusted to the best for the cartoon. If you want screen more bright, you can control brightness in Menu OSD.
Reader Off	It is a mode that reader mode is off.

! NOTE

If option of Reader Mode is Reader 1 or Reader 2, Picture Mode will automatically be Custom and SMART ENERGY SAVING and Color Weakness will automatically be Off.

FUNC. Setting

SMART ENERGY SAVING

- 1 Press **FUNC.** button on the bottom of the Monitor set to display the **FUNC.** OSD.
- 2 Enter to **SMART ENERGY SAVING** by pressing the ▼ button.
- 3 Set the options by pressing the ◀ or ▶ buttons.
- 4 Select **EXIT** to leave the OSD menu. To return to the upper menu or set other menu items, use the up arrow (↑) button.

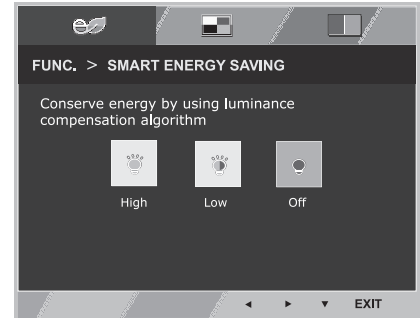

Each option is explained below.

SMART ENERGY SAVING	Description
High	Enables SMART ENERGY SAVING you can save energy with this energy- high efficient function.
Low	Enables SMART ENERGY SAVING you can save energy with this energy- low efficient function.
Off	Disables SMART ENERGY SAVING .

* **SMART ENERGY SAVING:** Conserve energy by using luminance compensation algorithm.

NOTE

- Saving Data depends on the Panel. So, those values should be different from each panel and panel vendor. If option of SMART ENERGY SAVING is High or Low, monitor luminance become higher or lower depend on source.
- If option of SMART ENERGY SAVING is High or Low, Picture Mode will automatically be Custom and Reader Mode and Color Weakness will automatically be Off.

Picture Mode

- 1 Press **FUNC.** button on the bottom of the Monitor set to display the **FUNC.** OSD.
- 2 Select **Picture Mode** by pressing the **▶** button.
- 3 Enter to **Picture Mode** by pressing the **▼** button.
- 4 Set the options by pressing the **◀** or **▶** buttons.
- 5 Select **EXIT** to leave the OSD menu. To return to the upper menu or set other menu items, use the up arrow(**↑**)button.

PC Mode

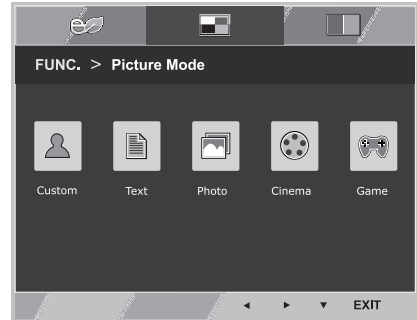

AV Mode

20MP38H | 22MP48HQ | 24MP48HQ
20MP38HQ | 23MP48HQ | 27MP48HQ

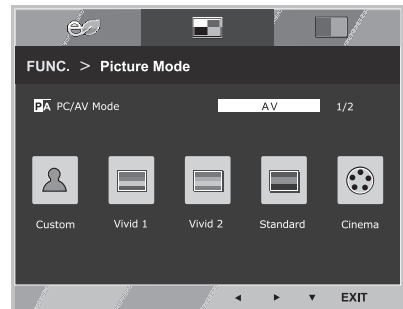

Each option is explained below.

Picture Mode	Description
Custom	It is a mode that the user can adjust each element. It can adjust the color mode of the Main Menu.
Text	It is a mode that the screen is adjusted to the best for the textworks.
Photo	It is a mode that the screen is adjusted to the best to view pictures.
Cinema	It is a mode that the screen is adjusted to the best to view the videos.
Game	It is a mode that the screen is adjusted to the best to play a game.

20MP38H | 20MP38HQ | 22MP48HQ | 23MP48HQ | 24MP48HQ | 27MP48HQ

Picture Mode	Description
Custom	It is a mode that the user can adjust each element. It can adjust the color mode of the Main Menu.
Vivid 1	Adjusts the video image for the retail environment by enhancing the contrast, brightness, Colour, and sharpness.
Vivid 2	
Standard	Adjusts the image for the normal environment.
Cinema	It is a mode that the screen is adjusted to the best to view the videos.

NOTE

If option of Picture Mode is non-Custom , Reader Mode, SMART ENERGY SAVING and Color Weakness will automatically be Off.

Color Weakness

- 1 Press **FUNC.** button on the bottom of the Monitor set to display the **FUNC.** OSD.
- 2 Select **Color Weakness** by pressing the ► button.
- 3 Enter to **Color Weakness** by pressing the ▼ button.
- 4 Set the options by pressing the ◀ or ▶ buttons.
- 5 Select **EXIT** to leave the OSD menu. To return to the upper menu or set other menu items, use the up arrow (↑) button.

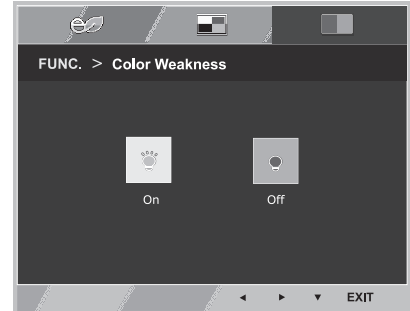

Each option is explained below.

Color Weakness	Description
Off	It is a mode that Color Weakness mode is off.
On	This mode is for users who cannot distinguish between red and green. It enables users with color weakness to easily distinguish between the two colors.

! NOTE

- This is subsidiary for color weakness user. Therefore if you feel uncomfortable with the screen, please turn off this function.
- This function can't distinguish some colors in some images.
- If option of Color Weakness is not Off, Reader Mode and SMART ENERGY SAVING will be Off and Picture Mode will automatically be Custom.

TROUBLESHOOTING

Check the following before calling for service.

No image appears	
Is the power cord of the display connected?	<ul style="list-style-type: none"> • Check and see if the power cord is connected properly to the power outlet.
Is the power indicator light on?	<ul style="list-style-type: none"> • Press the Power button.
Is the power indicator flickering?	<ul style="list-style-type: none"> • If the display is in power saving mode, try moving the mouse or pressing any key on the keyboard to bring up the screen. • Try to turn on the PC.
Do you see an "OUT OF RANGE" message on the screen?	<ul style="list-style-type: none"> • This message appears when the signal from the PC (video card) is out of horizontal or vertical frequency range of the display. See the 'Specifications' section of this manual and configure your display again.
Do you see a "NO SIGNAL" message on the screen?	<ul style="list-style-type: none"> • After the monitor is on "NO SIGNAL", the monitor goes to DPM mode. • This is displayed when the signal cable between the PC and the monitor is missing or disconnected. Check the cable and reconnect it.

Do you see a "OSD LOCKED" message on the screen?	
Do you see "OSD LOCKED" when you push MENU button?	<ul style="list-style-type: none"> • You can secure the current control settings, so that they cannot be inadvertently changed. You can unlock the OSD controls at any time by pushing the MENU button for several seconds: the message "OSD UNLOCKED" will appear.

Display image is incorrect	
Display Position is incorrect.	<ul style="list-style-type: none"> • Press the AUTO button to automatically adjust your display image to the ideal setting.
On the screen background, vertical bars or stripes are visible.	<ul style="list-style-type: none"> • Press the AUTO button to automatically adjust your display image to the ideal setting.
Any horizontal noise appearing in any image or characters are not clearly portrayed.	<ul style="list-style-type: none"> • Press the AUTO button to automatically adjust your display image to the ideal setting. • Check Control Panel ► Display ► Settings and adjust the display to the recommended resolution or adjust the display image to the ideal setting. Set the color setting higher than 24 bits (true color).

**CAUTION**

- Check **Control Panel ► Display ► Settings** and see if the frequency or the resolution were changed. If yes, readjust the video card to the recommend resolution.
- If the recommended resolution (optimal resolution) is not selected, letters may be blurred and the screen may be dimmed, truncated or biased. Make sure to select the recommend resolution.
- The setting method can differ by computer and O/S (Operation System), and resolution mentioned above may not be supported by the video card performance. In this case, please ask to the computer or the video card manufacturer.

Display image is incorrect	
The screen color is mono or abnormal.	<ul style="list-style-type: none"> • Check if the signal cable is properly connected and use a screwdriver to fasten if necessary. • Make sure the video card is properly inserted in the slot. • Set the color setting higher than 24 bits (true color) at Control Panel ► Settings.
The screen blinks.	<ul style="list-style-type: none"> • Check if the screen is set to interlace mode and if yes, change it to the recommend resolution.

Do you see an "Unrecognized monitor, Plug&Play (VESA DDC) monitor found" message?	
Have you installed the display driver?	<ul style="list-style-type: none"> • Be sure to install the display driver from the display driver CD (or diskette) that comes with your display. Or, you can also download the driver from our web site: http://www.lg.com. • Make sure to check if the video card supports Plug&Play function.

[20MP38H](#) [20MP38HQ](#) [22MP48HQ](#) [23MP48HQ](#) [24MP48HQ](#) [27MP48HQ](#)

The screen is flickering.	
Did you select the recommended resolution?	<ul style="list-style-type: none"> • If the selected resolution is HDMI 1080i 60/50 Hz, the screen may be flickering. Change the resolution to the recommended resolution 1080P.

SPECIFICATIONS

20MP38A 20MP38H 20MP38HQ 20MP48A

Display	Screen Type	Flat Panel Active matrix-TFT LCD Anti-Glare coating	
	Pixel Pitch	0.2907 mm x 0.2915 mm (Pixel Pitch)	
Resolution	Max	1440 x 900 @ 60 Hz	
	Recommend	VESA 1440 x 900 @ 60 Hz	
Power Consumption(Typ.)	On Mode : 18.7 W Typ.(Outgoing condition)* Sleep Mode ≤ 0.3 W Off Mode ≤ 0.3 W		
Power Input	19 V --- 0.8 A		
AC-DC Adapter 20MP48A	Type ADS-18SG-19-3 19016G, manufactured by SHENZHEN HONOR ELECTRONIC or Type ADS-18FSG-19 19016GPG-1, manufactured by SHENZHEN HONOR ELECTRONIC or Type LCAP42, manufactured by LIEN CHANG ELECTRONIC ENTERPRISE or Type LCAP43-E, manufactured by LIEN CHANG ELECTRONIC ENTERPRISE		
	OUTPUT: 19 V --- 0.84 A		
AC-DC Adapter 20MP38A 20MP38H 20MP38HQ	Type ADS-18SG-19-3 19016G, manufactured by SHENZHEN HONOR ELECTRONIC or Type ADS-18FSG-19 19016GPG-1, manufactured by SHENZHEN HONOR ELECTRONIC or Type LCAP42, manufactured by LIEN CHANG ELECTRONIC ENTERPRISE or Type LCAP43-E, manufactured by LIEN CHANG ELECTRONIC ENTERPRISE		
	OUTPUT: 19 V --- 0.84 A		
Dimensions (Width x Height x Depth)	With Stand	20MP48A	441.9 mm x 376.3 mm x 187.4 mm
		20MP38A 20MP38H 20MP38HQ	453.3 mm x 382.4 mm x 167.8 mm
	Without Stand	20MP48A	441.9 mm x 297.4 mm x 59.8 mm
		20MP38A 20MP38H 20MP38HQ	453.3 mm x 310.2 mm x 57.4 mm
Weight	20MP48A	2.1 kg	
	20MP38A 20MP38H 20MP38HQ	2.3 kg	
Tilt Range	-5° to 20°		
Environmental conditions	Operating Temperature	0°C to 40 °C	
	Operating Humidity	≤ 80%	
	Storage Temperature	-20°C to 60 °C	
	Storage Humidity	≤ 85%	

Product specifications shown above may be changed without prior notice due to upgrade of product functions.

* The power consumption level can be different by operating condition and monitor setting.

* The On mode power consumption is measured with LGE test standard(Full White pattern , Maximum resolution)

		20MP38A 20MP48A	20MP38H 20MP38HQ
Video Signal	Horizontal Frequency	30 kHz to 83 kHz (Automatic)	•
		30 kHz to 61 kHz (Automatic)	
	Vertical Frequency	D-SUB : 56 Hz to 75 Hz	•
		DVI-D : 56 Hz to 75 Hz	
		HDMI : 56 Hz to 75 Hz	•
	Synchronization	Separate Sync.	•
Digital		•	
Input Connector	15 pin D-SUB Connector	•	
	DVI-D Connector (Digital)		
	HDMI Connector	•	

SPECIFICATIONS

22MP48A 22MP48D 22MP48HQ

Display	Screen Type	Flat Panel Active matrix-TFT LCD Anti-Glare coating
	Pixel Pitch	0.248 mm x 0.248 mm (Pixel Pitch)
Resolution	Max	1920 x 1080 @ 60 Hz
	Recommend	VESA 1920 x 1080 @ 60 Hz
Power Consumption(Typ.)	On Mode : 25.3 W Typ.(Outgoing condition)* Sleep Mode ≤ 0.3 W Off Mode ≤ 0.3 W	
Power Input	19 V --- 1.2 A	
AC-DC Adapter	Type ADS-40SG-19-3 19025G, manufactured by SHENZHEN HONOR ELECTRONIC or Type ADS-40FSG-19 19025GPG-1, manufactured by SHENZHEN HONOR ELECTRONIC or Type ADS-40FSG-19 19025GPBR-1, manufactured by SHENZHEN HONOR ELECTRONIC or Type ADS-40FSG-19 19025GPI-1, manufactured by SHENZHEN HONOR ELECTRONIC or Type ADS-40FSG-19 19025GPCU-1, manufactured by SHENZHEN HONOR ELECTRONIC or Type ADS-40FSG-19 19025GPB-2, manufactured by SHENZHEN HONOR ELECTRONIC or Type ADS-25FSG-19 19025EPCU-1L, manufactured by SHENZHEN HONOR ELECTRONIC or Type LCAP21, manufactured by LIEN CHANG ELECTRONIC ENTERPRISE or Type LCAP26-A, manufactured by LIEN CHANG ELECTRONIC ENTERPRISE or Type LCAP26-E, manufactured by LIEN CHANG ELECTRONIC ENTERPRISE or Type LCAP26-I, manufactured by LIEN CHANG ELECTRONIC ENTERPRISE or Type LCAP26-B, manufactured by LIEN CHANG ELECTRONIC ENTERPRISE or Type LCAP51 , manufactured by LIEN CHANG ELECTRONIC ENTERPRISE or Type PA-1021-23,manufactured by Lite-On Technology Corporation.	
	OUTPUT: 19 V --- 1.3 A	
Dimensions (Width x Height x Depth)	With Stand	508.4 mm x 387.6 mm x 187.4 mm
	Without Stand	508.4 mm x 313.1 mm x 57.3 mm
Weight	2.7 kg	
Tilt Range	-5° to 20°	
Environmental conditions	Operating Temperature	0°C to 40 °C
	Operating Humidity	≤ 80%
	Storage Temperature	-20°C to 60 °C
	Storage Humidity	≤ 85%

Product specifications shown above may be changed without prior notice due to upgrade of product functions.

* The power consumption level can be different by operating condition and monitor setting.

* The On mode power consumption is measured with LGE test standard(Full White pattern , Maximum resolution)

			22MP48A	22MP48D	22MP48HQ
Video Signal	Horizontal Frequency	30 kHz to 83 kHz (Automatic)	•	•	•
		30 kHz to 61 kHz (Automatic)			
	Vertical Frequency	D-SUB : 56 Hz to 75 Hz	•	•	•
		DVI-D : 56 Hz to 75 Hz		•	
		HDMI : 56 Hz to 75 Hz			•
	Synchronization	Separate Sync.	•	•	•
Digital			•	•	
Input Connector	15 pin D-SUB Connector		•	•	•
	DVI-D Connector (Digital)			•	
	HDMI Connector				•

SPECIFICATIONS

23MP48D 23MP48HQ

Display	Screen Type	Flat Panel Active matrix-TFT LCD Anti-Glare coating
	Pixel Pitch	0.265 mm x 0.265 mm (Pixel Pitch)
Resolution	Max	1920 x 1080 @ 60 Hz
	Recommend	VESA 1920 x 1080 @ 60 Hz
Power Consumption(Typ.)	On Mode : 26.4 W Typ.(Outgoing condition)* Sleep Mode ≤ 0.3 W Off Mode ≤ 0.3 W	
Power Input	19 V --- 1.3 A	
AC-DC Adapter	Type ADS-40SG-19-3 19025G, manufactured by SHENZHEN HONOR ELECTRONIC or Type ADS-40FSG-19 19025GPG-1, manufactured by SHENZHEN HONOR ELECTRONIC or Type ADS-40FSG-19 19025GPBR-1, manufactured by SHENZHEN HONOR ELECTRONIC or Type ADS-40FSG-19 19025GPI-1, manufactured by SHENZHEN HONOR ELECTRONIC or Type ADS-40FSG-19 19025GPCU-1, manufactured by SHENZHEN HONOR ELECTRONIC or Type ADS-40FSG-19 19025GPB-2, manufactured by SHENZHEN HONOR ELECTRONIC or Type ADS-25FSG-19 19025EPCU-1L, manufactured by SHENZHEN HONOR ELECTRONIC or Type LCAP21, manufactured by LIEN CHANG ELECTRONIC ENTERPRISE or Type LCAP26-A, manufactured by LIEN CHANG ELECTRONIC ENTERPRISE or Type LCAP26-E, manufactured by LIEN CHANG ELECTRONIC ENTERPRISE or Type LCAP26-I, manufactured by LIEN CHANG ELECTRONIC ENTERPRISE or Type LCAP26-B, manufactured by LIEN CHANG ELECTRONIC ENTERPRISE or Type LCAP51, manufactured by LIEN CHANG ELECTRONIC ENTERPRISE or Type PA-1021-23,manufactured by Lite-On Technology Corporation.	
	OUTPUT: 19 V --- 1.3 A	
Dimensions (Width x Height x Depth)	With Stand	544.0 mm x 407.5 mm x 187.4 mm
	Without Stand	544.0 mm x 333.1 mm x 58.3 mm
Weight	3.0 kg	
Tilt Range	-5° to 20°	
Environmental conditions	Operating Temperature	0°C to 40 °C
	Operating Humidity	≤ 80%
	Storage Temperature	-20°C to 60 °C
	Storage Humidity	≤ 85%

Product specifications shown above may be changed without prior notice due to upgrade of product functions.

* The power consumption level can be different by operating condition and monitor setting.

* The On mode power consumption is measured with LGE test standard(Full White pattern , Maximum resolution)

			23MP48D	23MP48HQ
Video Signal	Horizontal Frequency	30 kHz to 83 kHz (Automatic)	•	•
		30 kHz to 61 kHz (Automatic)		
	Vertical Frequency	D-SUB : 56 Hz to 75 Hz	•	•
		DVI-D : 56 Hz to 75 Hz	•	
		HDMI : 56 Hz to 75 Hz		•
	Synchronization	Separate Sync.	•	•
Digital		•	•	
Input Connector	15 pin D-SUB Connector		•	•
	DVI-D Connector (Digital)		•	
	HDMI Connector			•

SPECIFICATIONS

24MP48HQ

Display	Screen Type	Flat Panel Active matrix-TFT LCD Anti-Glare coating
	Pixel Pitch	0.2745 mm x 0.2745 mm (Pixel Pitch)
Resolution	Max	1920 x 1080 @ 60 Hz
	Recommend	VESA 1920 x 1080 @ 60 Hz
Power Consumption(Typ.)	On Mode : 27.5 W Typ.(Outgoing condition)* Sleep Mode ≤ 0.3 W Off Mode ≤ 0.3 W	
Power Input	19 V --- 1.3 A	
AC-DC Adapter	Type ADS-40SG-19-3 19025G, manufactured by SHENZHEN HONOR ELECTRONIC or Type ADS-40FSG-19 19025GPG-1, manufactured by SHENZHEN HONOR ELECTRONIC or Type ADS-40FSG-19 19025GPBR-1, manufactured by SHENZHEN HONOR ELECTRONIC or Type ADS-40FSG-19 19025GPI-1, manufactured by SHENZHEN HONOR ELECTRONIC or Type ADS-40FSG-19 19025GPCU-1, manufactured by SHENZHEN HONOR ELECTRONIC or Type ADS-40FSG-19 19025GPB-2, manufactured by SHENZHEN HONOR ELECTRONIC or Type ADS-25FSG-19 19025EPCU-1L, manufactured by SHENZHEN HONOR ELECTRONIC or Type LCAP21, manufactured by LIEN CHANG ELECTRONIC ENTERPRISE or Type LCAP26-A, manufactured by LIEN CHANG ELECTRONIC ENTERPRISE or Type LCAP26-E, manufactured by LIEN CHANG ELECTRONIC ENTERPRISE or Type LCAP26-I, manufactured by LIEN CHANG ELECTRONIC ENTERPRISE or Type LCAP26-B, manufactured by LIEN CHANG ELECTRONIC ENTERPRISE or Type LCAP51, manufactured by LIEN CHANG ELECTRONIC ENTERPRISE or Type PA-1021-23,manufactured by Lite-On Technology Corporation	
	OUTPUT: 19 V --- 1.3 A	
Dimensions (Width x Height x Depth)	With Stand	549.9 mm x 409.0 mm x 187.4 mm
	Without Stand	549.9 mm x 330.4 mm x 62.5 mm
Weight	2.8 kg	
Tilt Range	-5° to 20°	
Environmental conditions	Operating Temperature	0°C to 40 °C
	Operating Humidity	≤ 80%
	Storage Temperature	-20°C to 60 °C
	Storage Humidity	≤ 85%

Product specifications shown above may be changed without prior notice due to upgrade of product functions.

* The power consumption level can be different by operating condition and monitor setting.

* The On mode power consumption is measured with LGE test standard(Full White pattern , Maximum resolution)

			24MP48HQ
Video Signal	Horizontal Frequency	30 kHz to 83 kHz (Automatic)	•
		30 kHz to 61 kHz (Automatic)	
	Vertical Frequency	D-SUB : 56 Hz to 75 Hz	•
		DVI-D : 56 Hz to 75 Hz	
		HDMI : 56 Hz to 75 Hz	•
	Synchronization	Separate Sync.	•
Digital		•	
Input Connector	15 pin D-SUB Connector	•	
	DVI-D Connector (Digital)		
	HDMI Connector	•	

SPECIFICATIONS

27MP48HQ

Display	Screen Type	Flat Panel Active matrix-TFT LCD Anti-Glare coating
	Pixel Pitch	0.3114 mm x 0.3114 mm (Pixel Pitch)
Resolution	Max	1920 x 1080 @ 60 Hz
	Recommend	VESA 1920 x 1080 @ 60 Hz
Power Consumption(Typ.)	On Mode : 30.8 W Typ.(Outgoing condition)* Sleep Mode ≤ 0.3 W Off Mode ≤ 0.3 W	
Power Input	19 V --- 1.6 A	
AC-DC Adapter	Type ADS-40SG-19-3 19032G, manufactured by SHENZHEN HONOR ELECTRONIC or Type ADS-40FSG-19 19032GPG-1, manufactured by SHENZHEN HONOR ELECTRONIC or Type ADS-40FSG-19 19032GPBR-1, manufactured by SHENZHEN HONOR ELECTRONIC or Type ADS-40FSG-19 19032GPI-1, manufactured by SHENZHEN HONOR ELECTRONIC or Type ADS-40FSG-19 19032GPCU-1, manufactured by SHENZHEN HONOR ELECTRONIC or Type ADS-32FSG-19 19032EPCU-1L, manufactured by SHENZHEN HONOR ELECTRONIC or Type LCAP21A, manufactured by LIEN CHANG ELECTRONIC ENTERPRISE or Type LCAP26A-A, manufactured by LIEN CHANG ELECTRONIC ENTERPRISE or Type LCAP26A-E, manufactured by LIEN CHANG ELECTRONIC ENTERPRISE or Type LCAP26A-I, manufactured by LIEN CHANG ELECTRONIC ENTERPRISE or Type LCAP26A-B, manufactured by LIEN CHANG ELECTRONIC ENTERPRISE or Type LCAP51A, manufactured by LIEN CHANG ELECTRONIC ENTERPRISE or Type PA-1031-23, manufactured by Lite-On Technology Corporation OUTPUT: 19 V --- 1.7 A	
Dimensions (Width x Height x Depth)	With Stand	634.0 mm X 479.7 mm X 211.9 mm
	Without Stand	634.0 mm X 381.0 mm X 71.3 mm
Weight	3.9 kg	
Tilt Range	-3° to 20°	
Environmental conditions	Operating Temperature	0°C to 40 °C
	Operating Humidity	≤ 80%
	Storage Temperature	-20°C to 60 °C
	Storage Humidity	≤ 85%

Product specifications shown above may be changed without prior notice due to upgrade of product functions.

* The power consumption level can be different by operating condition and monitor setting.

* The On mode power consumption is measured with LGE test standard(Full White pattern , Maximum resolution)

			27MP48HQ
Video Signal	Horizontal Frequency	30 kHz to 83 kHz (Automatic)	•
		30 kHz to 61 kHz (Automatic)	
	Vertical Frequency	D-SUB : 56 Hz to 75 Hz	•
		DVI-D : 56 Hz to 75 Hz	
		HDMI : 56 Hz to 75 Hz	•
	Synchronization	Separate Sync.	•
Digital		•	
Input Connector	15 pin D-SUB Connector	•	
	DVI-D Connector (Digital)		
	HDMI Connector	•	

Factory Support Mode (Preset Mode, D-SUB/DVI/HDMI PC)

20MP38A 20MP38H 20MP38HQ 20MP48A

Display Modes (Resolution)	Horizontal Frequency(kHz)	Vertical Frequency(Hz)	Polarity(H/V)	
720 X 400	31.468	70	-/+	
640 x 480	31.469	60	-/-	
640 x 480	37.5	75	-/-	
800 x 600	37.879	60	+/+	
800 x 600	46.875	75	+/+	
1024 x 768	48.363	60	-/-	
1024 x 768	60.023	75	+/+	
1152 x 864	67.5	75	+/+	
1280 x 1024	63.981	60	+/+	
1440 x 900	55.469	60	+/-	Recommend Mode

22MP48A 22MP48D 22MP48HQ 23MP48D 23MP48HQ
24MP48HQ 27MP48HQ

Display Modes (Resolution)	Horizontal Frequency(kHz)	Vertical Frequency(Hz)	Polarity(H/V)	
720 x 400	31.468	70	-/+	
640 x 480	31.469	60	-/-	
640 x 480	37.500	75	-/-	
800 x 600	37.879	60	+/+	
800 x 600	46.875	75	+/+	
1024 x 768	48.363	60	-/-	
1024 x 768	60.023	75	+/+	
1152 x 864	67.500	75	+/+	
1280 x 1024	63.981	60	+/+	
1280 x 1024	79.976	75	+/+	
1680 x 1050	65.290	60	-/+	
1920 x 1080	67.500	60	+/+	Recommend Mode

HDMI Timing(Video)

[20MP38H](#) [20MP38HQ](#)

Factory support mode (Preset Mode)	Horizontal Frequency(kHz)	Vertical Frequency(Hz)	HDMI
480P	31.50	60	○
576P	31.25	50	○
720P	37.50	50	○
720P	45.00	60	○ Recommend Mode

[22MP48HQ](#) [23MP48HQ](#) [24MP48HQ](#) [27MP48HQ](#)

Factory support mode (Preset Mode)	Horizontal Frequency(kHz)	Vertical Frequency(Hz)	HDMI
480P	31.50	60	○
576P	31.25	50	○
720P	37.50	50	○
720P	45.00	60	○
1080P	56.25	50	○
1080P	67.50	60	○ Recommend Mode

Indicator

Mode	LED Color
On Mode	White
Sleep Mode	Blinking White
Off Mode	Off



Declaration of Conformity

Trade Name: LG

Model : 20MP38A,20MP38H,20MP38HQ,20MP48A,
22MP48A, 22MP48D, 22MP48HQ, 23MP48D,
23MP48HQ , 24MP48HQ , 27MP48HQ

Responsible Party: LG Electronics Inc.

Address : 1000 Sylvan Ave. Englewood Cliffs
NJ 07632 U.S.A

TEL: 201-266-2534

*above information is only for USA FCC Regulatory

Make sure to read the Safety Precautions before using the product.

Keep the Owner's Manual (CD) in an accessible place for future reference.

The model and serial number of the SET is located on the back and one side of the SET. Record it below should you ever need service.

MODEL _____

SERIAL _____