

Financial Services and SIDM Range

KEEPING BUSINESS MOVING



EPSON[®]
EXCEED YOUR VISION

FINANCIAL SERVICES PRODUCT RANGE

Epson is the world's largest manufacturer of printers for banks and post offices with a product range that offers the ultimate in high speed, low cost, reliable and durable printing across all stationery types. Ideal for back office, cheque processing, and multi-part stationery, for which there is simply no alternative other than impact printing.

EPSON 9-PIN DOT MATRIX PRINTERS

Ideal for commercial, industrial and logistic applications, Epson's 9-pin dot matrix range offers excellent print quality for a competitive price. Combining high precision alignment and sophisticated paper handling, this comprehensive range of narrow and wide carriage printers can tackle even heavy duty print jobs.

EPSON 24-PIN DOT MATRIX PRINTERS

Offering all the features available across the 9-pin range, but with the advantage of scalable fonts and letter quality printing. Epson 24-pin printers are ideal for front desk applications in the retail and service industries, as well as invoice and order printing. The range also includes flatbed printers for use with a wider (and thicker) range of materials including receipts and labels.



WORLD LEADER
IMPACT DOT MATRIX PRINTER
SINCE 1996¹

Printer model	Printhead/Resolution	Duty	Field of application						Brochure page
			Point of sale	Instore	Accounting	Listing	Pass-book	Cheque handling	
Epson LX-350	9-pin	Light	●●●			●			8
Epson LX-1350		Medium	●●	●●●		●			8
Epson FX-890/890A		High	●	●●●	●●●	●●			9
Epson FX-2190/2190N		High		●●●	●●●	●●			9
Epson DFX-9000/9000N		Heavy		●●●	●●●	●●●			10
Epson LQ-50	24-pin	Light	●●●	●●●	●	●			10
Epson LQ-350		Light	●●●						11
Epson LQ-590		Medium	●●	●●●	●●●	●●			11
Epson LQ-630		Light	●●	●					12
Epson LQ-680Pro		Medium	●●	●●●					12
Epson LQ-690		Medium	●●	●●●					13
Epson LQ-2090		Medium		●●●	●●●	●●			13
Epson LQ-2190/2190N		High		●●●	●●●	●●●			14
Epson DLQ-3500		Heavy		●●●	●●	●●●			14
Epson PLQ-22/M		Medium	●	●			●●●	●	16
Epson PLQ-22CS/CSM		Medium	●	●			●●●	●	16
Epson PLQ-20/M		Medium	●	●			●●●	●	17
Epson PLQ-20D		Medium	●	●			●●●	●	17
Epson TM-S9000MJ	180×180	High	●●●	●●●				●●●	18
Epson TM-S2000MJ	-	High	●●	●●●				●●●	19
Epson TM-S1000	-	Medium	●●●	●●●				●●●	19
Epson TM-J7000 Series	180×180	Medium	●●●	●●●					20
Epson TM-L90	203×203	Medium	●●●	●●●					21
Epson TM-T88V	180×180	High	●●●	●●●					21

Key ● Low ●● Medium ●●● High

DOT MATRIX PRINTER ADVANTAGES

- Excellent TCO per page ratio (as low as €0.20/100 pages)
- Multi-part capability (up to 1 original + 9 copies)
- Long lasting print-outs (up to 100 years)
- Can work under harsh conditions (hot, cold, dry, humid or dusty environments)
- Low maintenance
- Handles continuous paper
- Can print on a wide range of media and of varying thickness (paper, multi-part forms, envelopes, card etc)
- Multiple paper paths to choose from to suit your working environment
- Handles cut sheet and continuous paper simultaneously

COMPATIBILITY – ESC/P2

ESC/P (Epson Standard Code for Printers) is the defacto standard dot matrix printer control language, worldwide. Adopted in the vast majority of popular software packages, ESC/P enables you to plug straight in – and print. The versatility and quality of Epson impact printing is further extended by ESC/P2 which enables Epson 24-pin printers to achieve scalable fonts and high-resolution graphics.

Fully compatible with existing software, ESC/P2 is designed for use with non Windows® operating systems, enabling you to achieve font manipulation without the need for costly on-board processors. If you are working within the Windows environment you will be able to achieve your printer's maximum speed by using printer resident fonts.

EPSON DOT MATRIX PRINTER SELECTOR

speed is more important than print quality – 9-pin

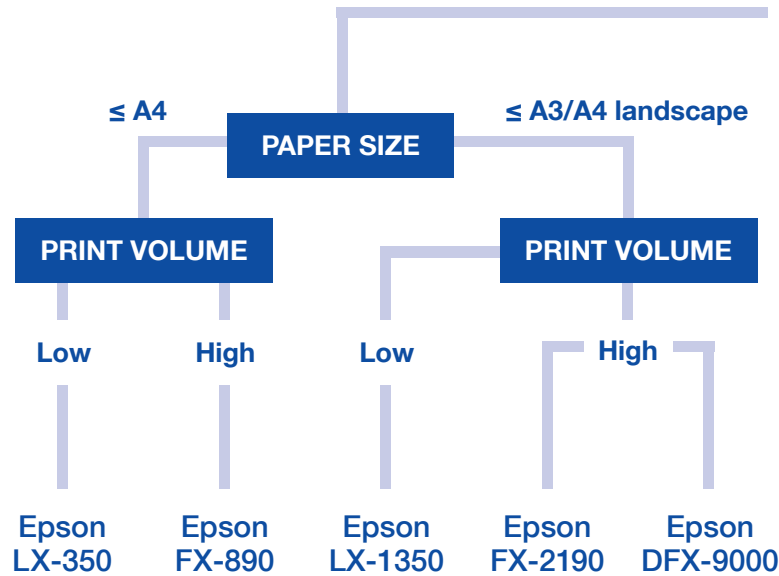

	Epson LX-350	Epson FX-890	Epson LX-1350	Epson FX-2190	Epson DFX-9000	Epson LQ-50
Speed	●○○○○○	●●●●●○	●○○○○○	●●●●●○	●●●●●●	●○○○○○
Print volumes/durability	●○○○○○	●●●●●○	●○○○○○	●●●●●○	●●●●●●	●○○○○○
Footprint	●○○○○○	●●○○○○	●●○○○○	●●●●●○	●●●●●●	●○○○○○
Quieter printing	●○○○○○	●●●●○○	●○○○○○	●●●●○○	●●●●●○	●○○○○○
Flatbed printer	-	-	-	-	-	-
Platen gap adjustment	manual	manual	manual	manual	automatic*	manual
Multi-copy capability	1+4 parts	1+5 parts	1+4 parts	1+5 parts	1+9 parts	1+2 parts
Paper feeds/continuous	rear	rear	rear	rear	rear	rear
	-	bottom	-	bottom	bottom (front)	-
	-	front	-	front	-	-
Cut sheet	top	top	top	top	-	-
	-	-	-	front	-	-
Print width	80 columns, 8in	80 columns, 8in	136 columns, 13.6in	136 columns, 13.6in	136 columns, 13.6in	50 columns, 8.5in
Colour printing	-	-	-	-	-	-

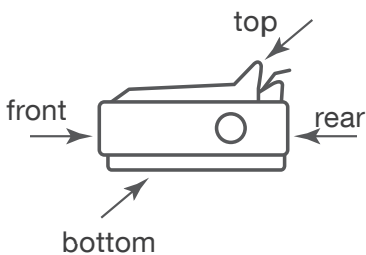

●○○○○○ = low ●●●●● = high

*DFX-9000, LQ-680Pro, PLQ-22 and DLQ-3500 have automatic platen gap adjustment to ensure optimum settings when changing between different media types with the minimum of user intervention. Automatic platen gap adjustment also allows printing on forms with varying thickness, such as multipart courier forms that also include a label.

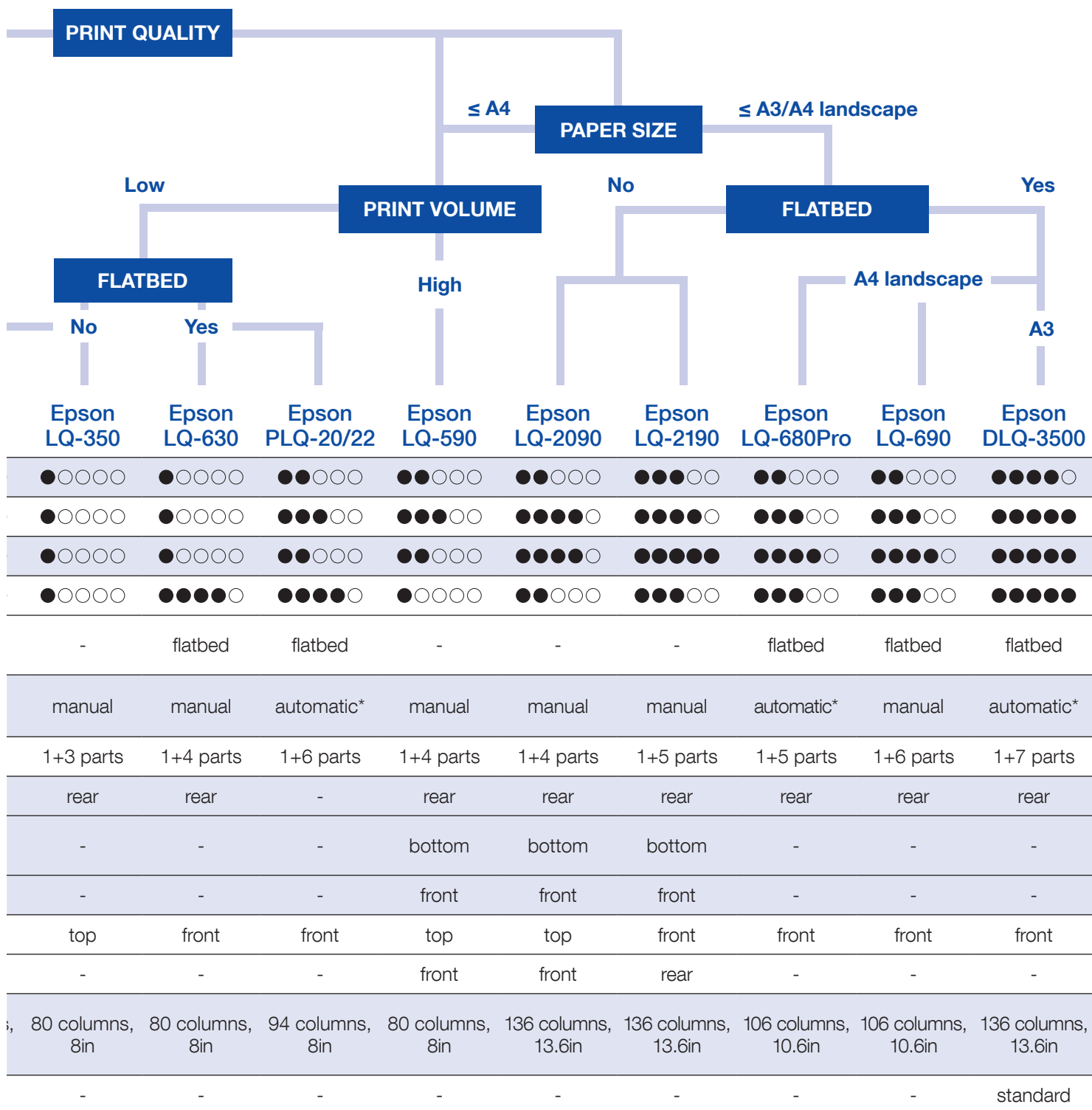

PRE-FLIGHT PRINTING

Epson dot matrix printers keep KLM on schedule at major international airport.

EXISTING SITUATION AND REQUIREMENTS

Ensuring a quick, efficient and on-time service is vital to the operation, profitability and reputation of all airlines. Even occasional passengers will be familiar with the array of checks and documentation required between check-in and take-off. Key to this process is the flight manifest; a printed document that provides the flight team with up-to-the-minute information on passengers, loadsheets and cargo, enabling pre-flight security checks and allowing the pilots to make last minute calculations on the weight and balance of the aircraft. As the manifest must contain the very latest available information it is printed for the flight crew when they reach the boarding gate. Without this manifest, the flight will not depart, making it extremely important that the printer works all the time, and prints out the information quickly. An error or malfunction could cause delay for the flight. In order to improve the printing of these documents KLM sought a new print partner who could offer high speed, accurate printing, and robust, easily serviceable products. Mr. Maikel Sporkslede, contract manager for KLM Royal Dutch Airlines, said, "As an International Airline it is crucial for us to be punctual, especially in these very competitive times, which is why reliability and speed is essential."

EPSON'S SOLUTION

Epson proposed the Epson FX-890 dot matrix printer as the ideal solution for all KLM's requirements at Schiphol. Small and the fastest in its class, with an outstanding 'volume between failure' rate of 52 million lines the Epson FX-890 is able to handle medium to heavy print loads quickly and reliably, and at low cost. The printer also has a wide selection of standard and optional paper formats, feeding and storage options to choose from. There's also an optional front sheet guide for smaller paper sizes. KLM was immediately interested in the Epson FX-890 dot matrix printer and, following seeding trials at Schiphol against several rival models and excellent feedback from staff, KLM confirmed that Epson was its supplier of choice in December 2010 for its boarding gate manifest printing at Schiphol. Soon afterwards installation of the units began and, since February 2011, 167 Epson FX-890 dot matrix printers have been keeping KLM on schedule at one of the world's busiest international airports.

BENEFITS

The Epson FX-890 dot matrix printer gives KLM flight crews the peace of mind that their flight manifests will be instantly printed on arrival at the boarding gate, enabling efficient and timely take off and smooth operation at the airline's primary hub. KLM's management team is also relieved, as this robust alternative to their previous installations reduces flight delays, passenger unrest and maintenance costs.

"We were looking for a successor to the previous dotmatrix printers installed at the gates which are used for loadsheet printing, passenger lists, cargo manifests etc. After a trial with several brands of printer, the Epson FX890 was chosen because of its printing speed and the fact that the printer is more robust."

Maikel Sporkslede,
Contract Manager, KLM



THE CASTILLA Y LEÓN SUCCESS STORY

In the Spanish educational system, passbooks are commonly used to keep track of students' academic data. Although this is a national practice, the method of recording data in passbooks is decided by local governments.

The Junta de Castilla y León (Autonomous Community of Castile and León) is the largest of the seventeen self-governed communities of Spain, with a population of 2.5 million. The schools of Junta de Castilla had been using printed labels to enter academic records into its students' passbooks, which involved printing individual labels and gluing them into the books.

THE PERFECT PRINTER FOR STUDENTS' PASSBOOKS

As these printed labels were easy to forge or tamper with, the autonomous communities decided it would be preferable to print directly onto the pages of the passbooks. At the same time, the communities wanted to introduce thicker passbooks with more pages, so that a single book would last through primary and secondary school.

Epson offered the perfect solution by customising its PLQ-20 passbook printer to handle thicker passbooks. This gives the schools of Junta de Castilla the flexibility to print passbooks of up to 46 pages plus the cover.

Furthermore, the PLQ-20 delivers high-quality, long-lasting prints which reduce the scope for counterfeit passbook entries.

As some of the schools had only a basic IT infrastructure, Epson provided Windows drivers to ensure the printer installation was as straightforward as possible.

Junta de Castilla is delighted with Epson's solution and has made an initial purchase of 1,000 PLQ-20 printers.



SOLUTION

With a customisation of its PLQ-20, Epson offered the schools of Junta de Castilla the solution to its problem, enabling them to print directly on the surface of the students' passbooks.



Epson LX-350

Due to its compact dimensions, the Epson LX-350 is not only the ideal 9-pin printer for front and back office applications where space is limited, it's also a low cost solution for measurement and control systems. With auto switching USB, serial and parallel interfaces, the LX-350 provides flexible stand-alone connectivity.

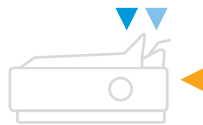

9-PIN DOT MATRIX PRINTER

Key features

- Compact 9-pin narrow carriage printer
- Up to 357 characters per second (12cpi)
- Robust printer with an MTBF of 10,000 hours
- Prints up to 5-part forms (1 original + 4 copies)
- Versatile top and rear paper paths
- 8 built-in barcode fonts
- USB, parallel and serial interfaces
- Reliable printhead life of 400 million strokes/wire
- Long lasting ribbon yield of 4 million characters

Options

- Roll paper holder

For options and consumables see page 25-27

Epson LX-1350

NEW

This wide-carriage 9-pin printer fits perfectly into a range of environments including data reporting, listings and point-of-sale. It is 337 cps fast, very reliable and cost efficient and has a range of options so you can create the perfect high quality printer to match your changing business requirements.

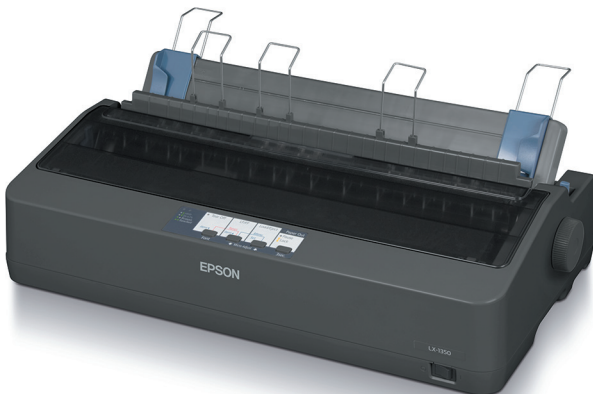

9-PIN DOT MATRIX PRINTER

Key features

- 9-pin wide carriage printer
- Up to 357 characters per second (12cpi)
- Robust printer with an MTBF of 10,000 hours
- Prints up to 5-part forms (1 original + 4 copies)
- Versatile top and rear paper paths
- 8 built-in barcode fonts
- USB, parallel and serial interfaces
- Reliable printhead life of 400 million strokes/wire
- Long lasting ribbon yield of 4 million characters

Options

- Roll paper holder

For options and consumables see page 25-27

	Standard	Optional
Continuous	▲	▲
Cut sheet	▲	▲

Epson FX-890/890A

This narrow carriage printer combines high speed with the highest reliability. A mean volume between failure of 52 million lines makes it ideal for medium and large print volumes. Paper can be fed from the front, top, rear or bottom and an optional push/pull tractor can be added to use a second continuous form – perfect for warehouses, wholesalers, freight forwarders and finance departments. For harsher printing environments the FX-890A has an additional sturdy, shock absorbing design.

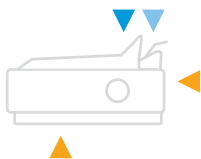

9-PIN DOT MATRIX PRINTER

Key features

- Compact 9-pin narrow carriage printer
- Up to 680 characters per second (12cpi)
- Robust printer with an MTBF of 20,000 hours
- Prints up to 6-part forms (1 original + 5 copies)
- Versatile top, bottom and rear paper paths
- USB, parallel and serial interfaces
- Reliable printhead life of 400 million strokes/wire
- Long lasting ribbon yield of 7.5 million characters

FX-890A only:

- Locked front cover for improved security
- Reinforced acrylic tear-off bar
- Shock absorbing cover and sheet feeder

Options

- 150 or 50 sheet cut sheet feeder
- Front sheet and paper guide
- Additional push/pull tractor unit
- Roll paper holder
- Wired network interface, serial interface

For options and consumables see page 25-27

Epson FX-2190/2190N

This wide carriage printer combines high speed printing with outstanding reliability. A mean volume between failure of 52 million lines makes this printer suitable for medium and large print volumes. The paper can be fed from the front, top, rear or bottom and an optional additional push/pull tractor unit can store a second continuous form, which is ideal for commercial and industrial environments. Also available as network version FX-2190N.

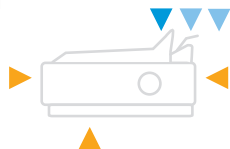

9-PIN DOT MATRIX PRINTER

Key features

- 9-pin wide carriage printer
- Up to 680 characters per second (12cpi), one of the fastest in its class
- Robust printer with an MTBF of 20,000 hours
- Prints up to 6-part forms (1 original + 5 copies)
- Versatile front, top, bottom and rear paper paths
- USB and serial interfaces
- Reliable printhead life of 400 million strokes/wire
- Long lasting ribbon yield of 12 million characters

Options

- Additional push/pull tractor unit
- Roll paper holder
- Wired network interfaces, serial interface

For options and consumables see page 25-27

Epson DFX-9000/9000N

The Epson DFX-9000 is a high print volume printer providing an unprecedented level of speed and reliability for the most demanding business. Its advanced paper handling accommodates a variety of paper types while the standard front and rear push tractors can be switched easily between different types of continuous paper. An optional perforation cutter provides paper finishing capabilities. Also available as network version DFX-9000N.



9-PIN DOT MATRIX PRINTER

Key features

- 4x 9-pin wide carriage printer
- Up to 1450 characters per second (12cpi)
- Robust printer with an MTBF of 20,000 hours
- Prints up to 10-part forms (1 original + 9 copies)
- Versatile front and rear paper paths
- USB, parallel and serial interfaces
- Reliable printhead life of 400 million strokes/wire
- Long lasting ribbon yield of 15 million characters
- Automatic platen gap adjustment

Options

- Perforation cutter
- Wired network interfaces
- Printer cabinet (Order code 7102677)

For options and consumables see page 25-27

Epson LQ-50

The Epson LQ-50 fits almost anywhere thanks to its small dimensions, which measure just 275x240x153mm. This 24-pin, 50-column dot matrix printer takes 6-inch paper, and is ideal for locations where space is at a premium such as delivery vans and small shop counters. It is even suitable for dusty or dirty environments when used with the optional protective roll paper cover.



24-PIN DOT MATRIX PRINTER

Key features

- 24-pin narrow carriage printer, 50 columns
- Up to 360 characters per second (12cpi)
- Robust printer with an MTBF of 10,000 hours
- Prints up to 3-part forms (1 original + 2 copies)
- USB and parallel interfaces
- Reliable printhead life of 200 million strokes/wire
- Long lasting ribbon yield of 3 million characters

Options

- Roll paper holder

For options and consumables see page 25-27

	Standard	Optional
Continuous	▲	▲
Cut sheet	▲	▲

Epson LQ-350

The compact Epson LQ-350 is the ideal printer for front and back office applications where space may be limited as well as for measurement and control systems. The copy capability of one original plus three copies makes this 24-pin printer suitable for point of sale applications where reliable, light duty printing is required.



24-PIN DOT MATRIX PRINTER

Key features

- Compact 24-pin narrow carriage printer
- Up to 416 characters per second (12cpi)
- Robust printer with an MTBF of 10,000 hours
- Prints up to 4-part forms (1 original + 3 copies)
- Versatile top and rear paper paths
- 8 built-in bar code fonts
- USB, parallel and serial interfaces
- Reliable printhead life of 400 million strokes/wire
- Long lasting ribbon yield of 2.5 million characters

Options

- Roll paper holder

Epson LQ-590

With a mean volume between failure of 40 million lines and a high print speed of 529cps this extremely robust printer is ideal for medium and large print volumes. Flexible paper management allows insertion from the front, top, rear, and bottom, while a front sheet guide enables front feeding of even small paper types. Typical applications are labels, barcodes and point of sale invoice printing.

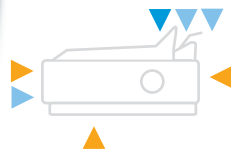

24-PIN DOT MATRIX PRINTER

Key features

- Very high print speed of up to 529 characters per second (12cpi)
- Copy capability of 1 original + 4 copies
- Extremely robust printer with an MTBF of 20,000 POH
- Reliable printhead life of 400 million strokes/wire
- Long lasting ribbon of 5 million characters
- Versatile front, top, rear and bottom paper paths
- Sound reduction down to 49dB(A) in low-noise mode

Options

- 150 or 50 sheet cut sheet feeder
- Additional push/pull tractor unit
- Roll paper holder
- Wired network interfaces, serial interface

For options and consumables see page 25-27

Epson LQ-630

With a small footprint (39×31cm), a column width of 80 characters, and print speed of up to 360 characters per second, this printer is ideal for environments with restricted space such as retail stores, doctors surgeries, ticket offices and industrial trade and service companies.

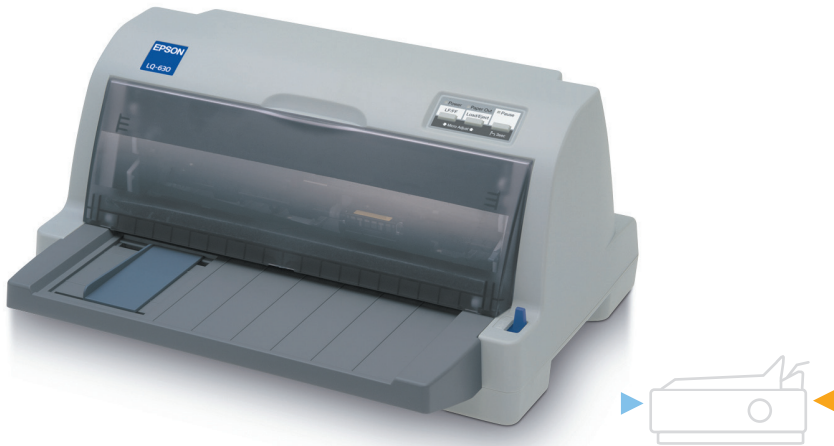

24-PIN DOT MATRIX PRINTER

Key features

- 24-pin narrow, flatbed carriage printer
- Up to 360 characters per second (12cpi)
- Robust printer with an MTBF of 6,000 hours
- Prints up to 5-part forms (1 original + 4 copies)
- USB and parallel interfaces
- Reliable printhead life of 200 million strokes/wire
- Long lasting ribbon yield of 2 million characters

For options and consumables see page 25-27

Epson LQ-680Pro

An extremely durable printer with a straight, flat paper path for ultra reliable flatbed printing. The Epson LQ-680Pro also includes automatic paper thickness adjustment for optimised print quality and optimised paper feeding – ideal for frequent changing between different paper types. It handles paper with varying thickness (eg overlapping forms and labels), and has simple push button paper source selection (eg between cut sheet and continuous paper).



24-PIN DOT MATRIX PRINTER

Key features

- 24-pin, 106 column flatbed carriage printer
- Up to 413 characters per second (10cpi)
- Robust printer with an MTBF of 10,000 hours
- Prints up to 6-part forms (1 original + 5 copies)
- Parallel and Type B interfaces
- Reliable printhead life of 400 million strokes/wire
- Long lasting ribbon yield of 2 million characters
- Automatic platen gap adjustment

Options

- 150 sheet cut sheet feeder
- Roll paper holder
- Wired network and serial interfaces

For options and consumables see page 25-27

	Standard	Optional
Continuous	▲	▲
Cut sheet	▲	▲

Epson LQ-690

The Epson LQ-690 offers the best in dot matrix performance where it matters most; speed, reliability, ribbon yield and ease-of-use. The LQ-690 is also versatile, handling cut sheets, continuous paper, labels, envelopes and cards. The new innovative Print Speed Enhancer feature allows fast printing of bit image data from Windows.



24-PIN DOT MATRIX PRINTER

Key features

- 24-pin medium duty, flatbed carriage printer
- Up to 529 characters per second (12cpi)
- Robust printer with an MTBF of 20,000 hours
- Prints up to 7-part forms (1 original + 6 copies)
- USB and parallel interfaces
- Reliable printhead life of 400 million strokes/wire
- Long lasting ribbon yield of 10 million characters

Options

- Roll paper holder

For options and consumables see page 25-27

Epson LQ-2090

An extremely robust printer with a mean volume between failure of 40 million lines. Its high print speed of 529cps makes it an ideal solution for medium and large print volumes. The Epson LQ-2090 impresses with flexible paper management which allows paper insertion from the front, top, rear, and bottom. A front paper guide makes it easy to insert even small sheets from the front.

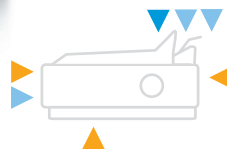

24-PIN DOT MATRIX PRINTER

Key features

- 24-pin wide carriage printer
- Up to 529 characters per second (12cpi)
- Robust printer with an MTBF of 20,000 hours
- Prints up to 5-part forms (1 original + 4 copies)
- USB, parallel and Type B interfaces
- Reliable printhead life of 400 million strokes/wire
- Long lasting ribbon yield of 8 million characters

Options

- Additional tractor unit
- Roll paper holder
- Wired network interfaces, serial interface

For options and consumables see page 25-27

Epson LQ-2190/2190N

The Epson LQ-2190 is a 24-pin wide-format printer and like its predecessor – the LQ-2180 – it is a fast, flexible, cost-effective and highly reliable printing solution which combines large print volumes with high letter quality – ideal for applications such as invoices, delivery notes, inventory listings or even labels. Also available as network version LQ-2190N.

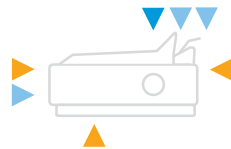

24-PIN DOT MATRIX PRINTER

Key features

- 24-pin wide carriage printer
- Up to 576 characters per second (12cpi)
- Robust printer with an MTBF of 20,000 hours
- Prints up to 6-part forms (1 original + 5 copies)
- USB, parallel and Type B interfaces
- Reliable printhead life of 400 million strokes/wire
- Long lasting ribbon yield of 15 million characters
- Front sheet guide

Options

- Additional tractor unit
- Roll paper holder
- Wired network interfaces, serial interface

For options and consumables see page 25-27

Epson DLQ-3500

This printer offers ultra reliable, high speed printing. An ability to print on 8-part stationery is especially useful for multiple copy forms, while up to three media paths provide versatile paper handling – front sheet feed with auto loading, rear tractor feed with paper park, and an optional automatic cut sheet feeder. Supplied with both black and colour fabric ribbons.

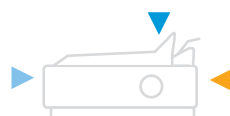

24-PIN DOT MATRIX PRINTER

Key features

- 24-pin wide carriage, flatbed printer
- Up to 550 characters per second (10cpi)
- Robust printer with an MTBF of 10,000 hours
- Prints up to 8-part forms (1 original + 7 copies)
- USB, parallel and Type B interfaces
- Reliable printhead life of 400 million strokes/wire
- Long lasting ribbon yield (black) of 6 or 9 million characters
- Colour printing
- Front sheet guide
- Automatic platen gap adjustment

Options

- 250 sheet cut sheet feeder
- Automatic sheet alignment unit
- Wired network interfaces, serial interface

For options and consumables see page 25-27

	Standard	Optional
Continuous	▲	▲
Cut sheet	▲	▲

Epson GP-M831

The GP-M831 heralds a new age in industrial-strength inkjet printers. With a tractor feeder and top speed of 16.5ipm (images per minute) in draft mode, the GP-M831 can handle large volume single ply printing in fast-paced work environments where time is of the essence.

Epson pigment ink means it delivers outstanding print results as well as excellent resistance to water, chemicals, fading and smudges. With a maximum resolution of 720x720dpi it is possible to print clear, sharp barcodes and photos.

The high-capacity, affordable ink cartridges allow longer print runs before needing to be replaced and the revolutionary printhead protection system reduces dust and dirt from clogging the nozzles. Durability like this makes the GP-M831 ideal for a wide range of environments including hospitals, laboratories, supermarkets, offices and warehouses.

Unlike conventional dot matrix printers, the GP-M831 keeps the peace thanks to quiet inkjet printing. Reduced power consumption is a major advantage for energy-conscious offices. Built for demanding work environments it can withstand weights of up to 20kg on top and have large side grips making it easier to move the printer. If you are looking for an alternative to dot matrix technology, the GP-M831 offers fast, high-quality printing combined into one.

INKJET PRINTER

Key features

- Tractor feed enables high-volume printing
- High-quality prints 720x720dpi
- Can print on a wide range of media including normal and glossy paper, as well as labels
- Unique head protection system protects print nozzles from clogging
- Fast print speeds of up to 16.5ipm
- Micro Piezo inkjet technology
- Ink cartridge ordering code: Black: C13S020563
- USB, Parallel and Ethernet (LAN 100/10BASE) interfaces as standard

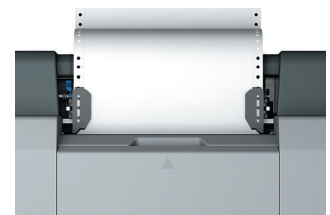

The unique tractor feed ensures perfect print results on various paper and label media.



2 black cartridges for low cost per print.

Epson PLQ-22/M

Epson PLQ-22CS/CSM

The Epson PLQ-22 Series offers banks, post offices and government institutions a very quiet printer with a low total cost of ownership. With print speeds of up to 576cps, the PLQ-22 Series is ideal to print a wide range of media including passbooks, passports, tickets and visas. Customers and staff alike will appreciate the quiet operation of this passbook printer, which has noise levels as low as 51dBA.

It's efficient too, its print speed enhancer enables fast printing of bit image data under Windows environments to help cut queues, while the highly accurate MICR/OCR (CS and CSM models) and MSRW (M and CSM models) heads make handling cheques and passbooks a smooth, trouble-free process.

Delivering substantial cost and energy savings, the PLQ-22/22M has a very low standby power consumption of 4.5W. Further reducing TCO, it can print around 10 million characters in draft mode between ribbon changes.

The PLQ-22 Series offers excellent passbook handling and data processing flexibility, thanks to its 128KB memory and capacity for passbooks up to 2.6mm thick.

Simple to install, the series features a choice of emulations plus parallel, serial and USB interfaces as standard for an easy fit into most IT environments.

24-PIN DOT MATRIX PRINTER

Key features

- 24-pin, 94 column flatbed passbook printer
- Time saving automatic sheet alignment and printhead adjustment
- Up to 576 characters per second (12dpi)
- Robust printer with an MTBF of 10,000 hours
- Easy to integrate into any IT environment with Olivetti PR2E, Epson ESC/P2 and IBM PPDS emulations
- Accurate MICR/OCR/MSRW data reading (selected models)
- USB Hub parallel and serial interfaces
- Reliable printhead life of 400 million strokes/wire
- Long lasting ribbon yield of 5 million characters

Options

- MICR/OCR head (CS/CSM model)
- MSRW head (M/CSM model)
- Space saving kit including top paper tray and rear paper guide

For options and consumables see page 25-27



Compact design and small footprint.



Change ribbon cartridges in seconds.



Front operation with easy paper loading.



Epson PLQ-20/M

Epson PLQ-20D

The Epson PLQ-20 Series is ideal for all front desk applications such as banking and public administration offices. The PLQ-20 provides fast print speeds of up to 576cps and can print on a wide range of media including passbooks, passports, tickets or visas. With its automatic printhead adjustment feature, it can handle media up to 2.6mm in thickness and has automatic sheet alignment for ease-of-use. With an MTBF of 10,000 hours this impact printer has been built to last.



24-PIN DOT MATRIX PRINTER

Key features

- 24-pin, 94 column flatbed passbook printer
- Time saving automatic sheet alignment and printhead adjustment
- Up to 576 characters per second (12cpi)
- Robust printer with an MTBF of 10,000 hours
- Easy to integrate into any IT environment with Olivetti PR2E, Epson ESC/P2 and IBM PPDS emulations
- Accurate MSRW data reading (selected models)
- USB, parallel and serial interfaces
- Reliable printhead life of 400 million strokes/wire
- Long lasting ribbon yield of 5 million characters

Options

- MSRW head (M model)
- Dual serial port (D model)
- Space saving kit including top paper tray and rear paper guide

For options and consumables see page 25-27

	PLQ-20	PLQ-20M	PLQ-20D	PLQ-22	PLQ-22M	PLQ-22CS	PLQ-22CSM
MSRW	-	●	-	-	-	-	●
Dual-user sharing	Via network sharing	Via network sharing	Dual serial port	Via network sharing	Via network sharing	Via network sharing	Via network sharing
Scanning	-	-	-	-	-	●	●
MICR/OCR	-	-	-	-	-	●	●
IR	-	-	-	-	-	●	●



EPSON SOLUTIONS FOR BANKS

Accuracy, performance, reliability, security, ease-of-use. Delivering all these qualities through innovative print and scanning technology, Epson's cheque scanners make electronic cheque capture simple to implement – for both retailers and financial organisations.

Epson TM-S9000MJ

Combine colour scanning, endorsement and receipt printing in one compact device. Set new standards in accuracy with a high MICR recognition rate of more than 99.9%, automatic skew correction and background noise filtering.

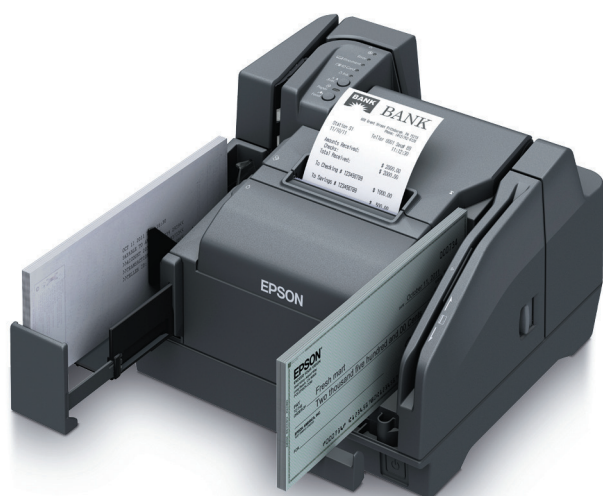

3-IN-1 SCANNER AND PRINTER

Key features

- Double-sided, full colour scanning at up to 200dpm
- Wide endorsement area: print up to 16 lines
- ASF for up to 100 documents
- Scan photo ID cards
- Options include: 1 or 2 output pockets, MSR reader and USB Hub
- Supports TWAIN scanning

Scan method	Contact Image Sensor
Scan speed	800mm/s
Paper dimensions (mm) (H to L)	60 to 120×120 to 235
Print method	Cut sheet paper unit: Line inkjet/Roll paper unit: Thermal line printing
Print speed	Cut sheet paper unit: 800mm/s/Roll paper unit: 300 mm/s
Print height	Cut sheet paper unit: 50.8mm
Interfaces	USB
Power supply	Exclusive AC adapter (included)
Dimensions (mm) (W×D×H)	One-pocket model: 250×374.8 (263.8 with stored output pocket) ×177 Two-pocket model also available
Weight	5kg

Epson TM-S2000MJ

Combine double-sided colour scanning and inkjet endorsement printing in one compact device for efficient processing of cheques, vouchers and cut sheets.

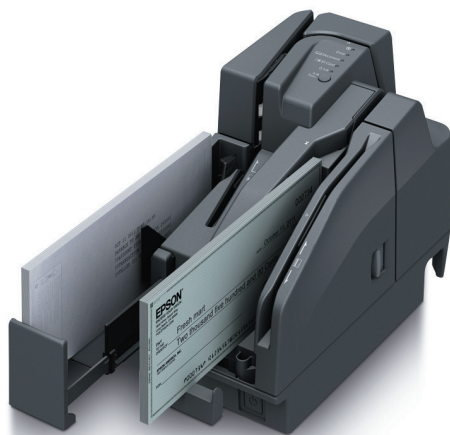

2-IN-1 SCANNER AND PRINTER

Key features

- Double-sided, full colour scanning at up to 200dpm
- Wide endorsement area: print up to 16 lines
- ASF for up to 100 documents
- Scan photo ID cards
- High MICR recognition rate of more than 99.9%
- Choose from 1 or 2 output pockets
- Also available with MSR reader and USB hub

Scan method	Contact Image Sensor
Scan speed	800mm/s
Paper dimensions (mm) (H to L)	60 to 120×120 to 235
Print method	Line inkjet
Print speed	800mm/s
Print height	50.8mm
Interfaces	USB
Power supply	Exclusive AC adapter (included)
Dimensions (mm) (W×D×H)	One-pocket model: 142×374.8 (263.8 with stored output pocket) ×177 Two-pocket model also available
Weight	4.5kg

Epson TM-S1000

Add reliability and innovation to crucial scanning in financial and corporate markets. Achieve the highest MICR accuracy in the desktop scanning market and make the process fast, easy and world class quality.



CHEQUE AND VOUCHER SCANNER

Key features

- High accuracy grayscale and B/W scanning for cheques and documents
- Drop-in auto sheet feeder and 2 pockets

Scan method	Contact Image Sensor
Scan speed	500mm/s
Paper dimensions (mm) (H to L)	120×68 to 235×120
Interfaces	USB
Power supply	Exclusive AC adapter (included)
Dimensions (mm) (W×D×H)	176×355×160
Weight	4kg



product
design
award

2009 ■

EPSON PRINTERS FOR THE POST OFFICE

In more than 20 European countries Epson is the preferred brand for processing all different kinds of materials in post offices. A perfect example is the UK Post with its 16,000 branches. The company needed a hard-working, secure solution to enhance the company's brand image.

The Epson solution

The Epson TM-J7100 inkjet is faster, quieter and prints high-quality two-colour logos for added security. It's very reliable, with low cost consumables for superb value across the 30,000 printer fleet. A key feature was its ability to fit easily into the existing emulation, with built-in flexibility to meet future changes.

Epson TM-J7000 Series

Enjoy fast, smooth retail and banking POS operations with this compact multifunction inkjet and cheque processor. Enhance the customer experience and your business efficiency with high-quality 2-colour receipts and slips including graphics and barcodes. Make a real difference to receipts with bright, eye-catching colour logos, coupons and advertisements. Print and validate customer cheques in seconds.

With class-leading print speeds and high resolution 2-colour graphics, prints are permanent so they last and stand out for longer. Print and endorse cheques in as little as 12 seconds with this multifunction printer's single-insertion system.

RECEIPT, SLIP (MICR, ENDORSEMENT OPTION)

Key features

- Class-leading speeds up to 14.3 text lines/sec
- One-pass cheque printing with SmartPass technology
- Durable and reliable for low cost of ownership
- High resolution 2-colour printing
- Autocutter life 1.5 million lines, MCBF 50 million lines
- Long-life ink cartridges
- Quality and efficiency with unique inkjet technology
- Handles cheques that have been folded or crumpled



“The TM-J7100 printer has more than lived up to our expectations, helping us deliver outstanding customer service.”

**Andy McLean,
Head of Service Delivery
UK Post**

Epson TM-L90

Enhance your business with the fast, compact printer that produces high-quality permanent labels and receipts. Choose from a wide variety of paper, including thermal labels, receipts and tickets. The Peeler version has a special function where it takes the labels off the liner for you, ideal for glove wearing environments.



LABEL AND RECEIPT

Key features

- Print at up to 150mm/sec at 203x203dpi
- Design custom labels quickly and easily
- Easy drop-in paper rolls
- Excellent reliability with an MCBF of 70 million lines

Print method	Thermal line printing
Print speed	150mm/s
Column capacity	48/64
Paper dimensions (mm)	79.5 +/- 0.5, 69.5 +/- 0.5 to 37.5 +/- 0.5
Interfaces	Changeable interface board
Power supply	PS-180 (option)
Dimensions (mm) (WxDxH)	140x201x148
Weight	1.9kg

Epson TM-T88V

Like the Epson TM-T88IV before it, innovation is at the heart of this printer. It is the world's first ENERGY STAR-qualified thermal receipt printer, and the first greyscale graphic POS printer too. It works harder for your business at the point of sale, with metal hinges, splash resistance, an integrated paper cutter with a 2 million cut life, MCBF of 70 million lines and a printhead with 50% more capacity. With this level of reliability we're happy to offer a 4-year commercial warranty.



RECEIPT PRINTING

Key features

- Very fast printing up to 300mm/sec
- Design and customise your own receipts
- Reduce waste with auto paper reduction
- Outstanding reliability with MCBF 70 million lines
- Easy to install and upgrade
- ENERGY STAR-qualified for power consumption
- Choose from cool white, dark grey, white or black

Print method	Thermal line printing
Print speed	300mm/s
Column capacity	42/56
Paper dimensions (mm)	79.5 ± 0.5, 57.5 ± 0.5 (W) x dia. 83
Interfaces	USB on board and changeable interface board
Power supply	PS-180 (option)
Dimensions (mm) (WxDxH)	145x195x148
Weight	1.6kg

SPECIFICATIONS EPSON 24-PIN

	LQ-50		LQ-350		LQ-590		LQ-630		LQ-680Pro	
	50		80		80		80		106	
CARRIAGE WIDTH IN COLUMNS										
PRINT SPEEDS	10cpi	12cpi	10cpi	12cpi	10cpi	12cpi	10cpi	12cpi	10cpi	12cpi
High speed draft	300	360	347	357	440	529	300	360	413	n/a
Draft	225	270	260	312	330	396	225	270	310	372
Letter quality	75	90	65	78	110	132	79	94	103	124
EMULATIONS										
Epson	ESC/P2		ESC/P2		ESC/P2		ESC/P2		ESC/P2	
IBM/OLIVETTI	IMB 2390 plus		IBM PPDS		IBM PPDS		IBM PPDS		2390 Plus	
PAPER HANDLING FEATURES										
Auto paper loading	■		■		■		■		■	
Auto and manual tear off position	■		■		■		■		■	
Paper parking – continuous stationary	■		■		■		■		■	
Micro feed	■		■		■		■		■	
Automatic platen gap adjustment										■*7
CUT SHEET STATIONERY										
Single sheet, paper, labels or envelopes			■		■		■		■	
Multi-part forms (original + copies)			1+3		□ 1+4 *4		1+4		1+5	
Sheets with varying thickness										■*7
Multi-part with overlap										■*7
Front in front out							■			■
Front in rear out										
Front in top out					■					
Top in top out			■		■					
50 sheet cut sheet feeder					□					□*3
150 sheet cut sheet feeder					□					□
250 sheet cut sheet feeder										
Combined 50/150 sheet cut sheet feeders					□					□
Front paper guide					■*5					
Front sheet guide					□*6		■			■
Automatic sheet alignment unit										
ROLL PAPER	■		□		□					□
CONTINUOUS STATIONARY	■									
Single sheet or labels			■		■		■		■	
Multi-part (original + copies)	1+2		1+3		1+4		1+4		1+5	
Sheets with varying thickness										■*7
Multi-part with overlap										■*7
Rear in front out – push feed							■			■
Rear in top out – push feed	■		■		■					
Rear in top out – pull feed										
Rear in top out – push and pull feed			□*1		□*1					
Front in top out – push feed					■					
Front in top out – pull feed					■					
Front in top out – push and pull feed					□*1					
Bottom in top out – pull feed					■					
Two stationery types loaded at once					□*1					
BUFFER	64KB		128KB		128KB		32KB		64KB	
ACOUSTIC NOISE LEVEL	54dB(A)		53dB(A)		49dB(A)		57dB(A)		55dB(A)	
COLOUR PRINTING										
FONTS										
Epson Draft	■		■		■		■		■	
Epson Courier	■		■		■		■		■	
Epson OCR-B	■		■		■		■		■	
Epson Orator	■		■		■		■		■	
Epson Orator-S	■		■		■		■		■	
Epson Prestige	■		■		■		■		■	
Epson Roman	■ S		■ S		■ S		■ S		■ S	
Epson Roman T	■ S		■ S		■ S		■ S		■ S	
Epson Sans Serif	■ S		■ S		■ S		■ S		■ S	
Epson Sans Serif H	■ S		■ S		■ S		■ S		■ S	
Epson Script	■		■		■		■		■	
Epson Script C	■		■		■		■		■	
BARCODE FONTS										
Code 128	■		■		■		■		■	
Code 39	■		■		■		■		■	
EAN-13	■		■		■		■		■	
EAN-8	■		■		■		■		■	
Interleave 2 of 5	■		■		■		■		■	
PostNet	■		■		■		■		■	
UPC-A	■		■		■		■		■	
UPC-E	■		■		■		■		■	
INTERFACES⁹										
USB	■		■		■		■		■	
Parallel	■		■		■		■		■	
Serial			■		□				□	
Network print server					□				□	
Type B internal interface slot					■				■	
DIMENSIONS IN MILLIMETRES										
Width	262mm		348mm		437.5mm		386mm		497mm	
Depth	240mm		275mm		374.5mm		306mm		387mm	
Height	153mm		154mm		171.5mm		185mm		230mm	
WEIGHT	3.3kg		4.1kg		7.1kg		3.5kg		9.4kg	
MTBF (POWER ON HOURS)	10,000		10,000		20,000		6,000		10,000	
PRINT HEAD LIFE (MILLION STROKES PER WIRE)										
Black	200m		400m		400m		200m		400m	
Colour										
RIBBON LIFE (IN MILLION CHARACTERS)										
BLACK RIBBON	3m		2.5m		5m		2m		2m	
COLOUR RIBBON										
Black										
Cyan										
Magenta										
Yellow										

*1Requires additional convertible tractor unit option. *2Requires two additional convertible tractor unit options. *3150 sheet cut sheet feeder must be fitted first. *4Front feed only. *5Can be used in conjunction with front continuous paper feeding. *6Cannot be used in conjunction with front continuous paper feeding. *7LQ-680Pro only.

SPECIFICATIONS EPSON 9-PIN

	LX-350		LX-1350		FX-890		FX-2190/N		DFX-9000/N	
CARRIAGE WIDTH IN COLUMNS	80		136		80		136		136	
PRINT SPEEDS	10cpi	12cpi	10cpi	12cpi	10cpi	12cpi	10cpi	12cpi	10cpi	12cpi
Ultra high speed draft					566	680	566	680		
High speed draft	347	357	300	357	559	627	559	627	1550	1450
Draft	260	312	225	270	419	503	419	503	1320	1320
Near letter quality	65	78	56	67	104.6	125.9	104.6	125.9	330	330
EMULATIONS	ESC/P		ESC/P		ESC/P		ESC/P		ESC/P	
Epson	ESC/P		ESC/P		ESC/P		ESC/P		ESC/P	
IBM/OKI	IBM PPDS		IBM PPDS		ProPrinter DS/ML		ProPrinter DS/ML		2381 Plus/PPDS	
PAPER HANDLING FEATURES										
Auto paper loading	■		■		■		■		■	
Auto and manual tear off position	■		■		■		■		■	
Paper parking – continuous stationary	■		■		■		■		■	
Micro feed	■		■		■		■		■	
Automatic platen gap adjustment										■
CUT SHEET STATIONARY										
Single sheet, paper, labels or envelopes	■		■		■		■		■	
Multi-part forms (original + copies)	1+4		1+4		1+5		1+5			
Front in top out					□		□			
Top in top out	■		■		■		■		■	
50 sheet cut sheet feeder					□		□			
150 sheet cut sheet feeder					□					
Combined 50/150 sheet cut sheet feeders					□		□			
Front paper guide					□ ^{*5}		□ ^{*5}			
Front sheet guide					□ ^{*6}		□ ^{*6}			
ROLL PAPER	□		□		□		□		□	
CONTINUOUS STATIONERY										
Single sheet or labels	■		■		■		■		■	
Multi-part (original + copies)	1+4		1+4		1+5 ^{*8}		1+5 ^{*8}		1+9 front	1+6 rear
Sheets with varying thickness										■
Multipart with overlap										■
Rear in top out – push feed	■		■		■		■		■	
Rear in top out – pull feed	■									□
Rear in top out – push and pull feed					□ ^{*1}		□ ^{*1}			□
Front in top out – push feed					■		■		■	
Front in top out – pull feed					■		■			□
Front in top out – push and pull feed					□ ^{*1}		□ ^{*1}			□
Bottom in top out – pull feed					■		■			■
Two stationery types loaded at once					□ ^{*1}		□ ^{*1}			■
BUFFER	128KB		128KB		128KB		128KB		128KB	
ACOUSTIC NOISE LEVEL	53dB(A)		53dB		55dB(A)		55dB(A)		58dB(A)	
COLOUR PRINTING										
FONTS										
Epson Draft	■		■		■		■		■	
Epson Roman	■		■		■		■		■	
Epson Sans Serif	■		■		■		■		■	
BARCODE FONTS										
Code 128	■		■		■		■		■	
Code 39	■		■		■		■		■	
EAN-13	■		■		■		■		■	
EAN-8	■		■		■		■		■	
Interleave 2 of 5	■		■		■		■		■	
PostNet	■		■		■		■		■	
UPC-A	■		■		■		■		■	
UPC-E	■		■		■		■		■	
INTERFACES^{*9}										
USB	■		■		■		■		■	
Parallel	■		■		■		■		■	
Serial	■		■		□		□		■	
Network print server					□		□			□
Type B internal interface slot					■		■		■	
DIMENSIONS IN MILLIMETRES										
Width	348mm		546mm		414mm		589mm		700mm	
Depth	275mm		275mm		350mm		350mm		378mm	
Height	154mm		163mm		167.5mm		167.5mm		363mm	
WEIGHT	4.1kg		6.4kg		7.2kg		9.4kg		34kg	
MTBF (POWER ON HOURS)	10,000		10,000		20,000		20,000		20,000	
PRINT HEAD LIFE (MILLION STROKES PER WIRE)										
Black	400m		400m		400m		400m		400m	
Colour					characters		characters		characters	
RIBBON LIFE (IN MILLION CHARACTERS)										
BLACK RIBBON	4m		4m		7.5m		12m		15m	
COLOUR RIBBON										
Black										
Cyan										
Magenta										
Yellow										

^{*1}Requires additional convertible tractor unit option. ^{*2}Requires two additional convertible tractor unit options. ^{*3}150 sheet cut sheet feeder must be fitted first. ^{*4}Front feed only. ^{*5}Can be used in conjunction with front continuous paper feeding. ^{*6}Cannot be used in conjunction with front continuous paper feeding. ^{*7}LQ-680Pro only. ^{*8}Multi-part 1+6 copies when using pull feed.

^{*9}Not available in all countries. Please contact your local Epson representative

■ = Standard □ = Optional S = Scalable from 2 to 32 point in 2 point steps.

OPTIONS, ACCESSORIES AND SUPPLIES

9-pin	OPTIONAL PAPER HANDLING	Order code	LX-350	LX-1350	FX-890	FX-2190/N	DFX-9000/N
	Convertible tractor unit	C12C800202			●		
		C12C800212				●	
		C12C800341		●			
	Roll paper holder	C12C811141	●	●	●	●	
	Front sheet guide					● ^{*3}	
	50 sheet cut sheet feeder	C12C806372	●		●		
	150 sheet cut sheet feeder	C12C806382			●		
		C12C806402				●	
	Perforation cutter	C12C815072					●
SUPPLIES							
Black fabric ribbon		C13S015637	C13S015642	C13S015329	C13S015327	C13S015384	
OPTIONAL INTERFACES^{*4}							
Serial interface (OK buffer)	C12C824432			●	●	●	
EpsonNet 10/100 Base Tx Int. Printer Server 5e	C12C824352			●	●	●	
WARRANTY^{*4}							
1 year replacement or repair		●	●	●	●		
1 year on-site							●
Optional extension to 3 years		ECPGRP10	ECPGRP20	ECPGRP20	ECPGRP25	ECPGRP70	

24-pin	OPTIONAL PAPER HANDLING	Order code	LQ-50	LQ-350	LQ-590	LQ-630	LQ-680/Pro	LQ-690	LQ-2090	LQ-2190/N	DLQ-3500	PLQ-20/M/D	PLQ-22/CS/CSM
	Convertible tractor unit	C12C800202			●								
		C12C800212							●				
		C12C800322								●			
	Roll paper holder	C12C811141		●	●		●	●	●	●		●	●
		C12C811262	●										
	50 sheet cut sheet feeder	C12C806372		●	●								
	150 sheet cut sheet feeder	C12C806382			●								
		C12C806872					●						
	250 sheet cut sheet feeder	C12C806832									●		
Space saving kit	C12C802202										●	●	
Automatic sheet alignment unit	C12C806882									●			
SUPPLIES													
Black fabric ribbon	C13S015(+)	+624	+633	+337	+307	+262	+610	+336	+086	+066	+339	+339	
Colour fabric ribbon	C13S015(+)										+067		
Black film ribbon	C13S015255					●							
OPTIONAL INTERFACES^{*4}													
Serial interface (OK buffer)	C12C824432			●		●		●	●	●			
EpsonNet 10/100 Base Tx Int. Print Server 5e	C12C824352			●		●		●	●	●			
WARRANTY^{*4}													
1 year replacement or repair			●	●	●	●	●	●	●	●	●	●	●
1 year on-site										●	●		
Extension to 3 years	ECP-(+)	+GRP5	+GRP10	+GRP20	+GRP20	+GRP20	+GRP20	+GRP30	+GRP30	+GRP50	+GRP20	+GRP20	

^{*1}150 sheet cut sheet feeder must be fitted first. ^{*2}Can be used in conjunction with front continuous paper feeding. ^{*3}Cannot be used in conjunction with front continuous paper feeding.

^{*4}Not available in all countries. Please contact your local Epson representative.

OPTIONS AND ACCESSORIES

TYPICAL PAPER PATHS

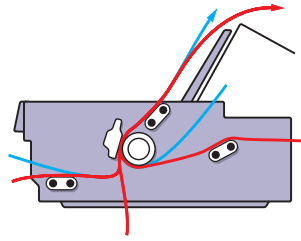
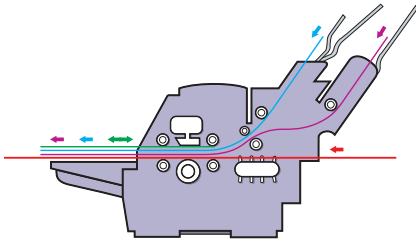

MOTORISED SHEET FEEDERS

For high volume cut sheet printing, optional motorised cut sheet feeders are available for selected products, like the 150 sheet cut sheet feeder for the Epson LQ-2180. Equipped with productivity enhancing, independent motor drives, these feeders reduce paper handling time and ensure optimum paper throughput.

CUT SHEET FEEDERS

Offering 50, 150 and 250 sheet, for automatic selection of forms and plain stationery.

PAPER FEED TRACTORS

A choice of push, pull and push/pull combined tractors not only enable more than one stationery type to be permanently loaded for delivery on demand, but handle continuous and multi-part stationery more efficiently.



LX-300 PULL TRACTOR UNIT
C12C800302



LX-1170 PULL TRACTOR UNIT
C12C800341

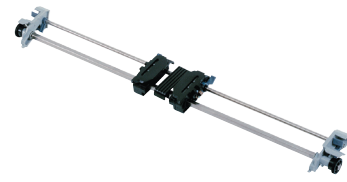

LQ-1170 PUSH/PULL TRACTOR UNIT
C12C800212

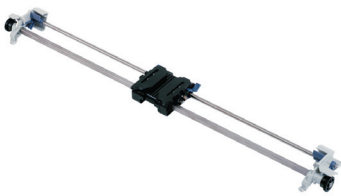

FX-/LQ-2170 PULL TRACTOR UNIT
C12C800322



LQ-870 PUSH/PULL TRACTOR UNIT
C12C800202



ROLL PAPER HOLDER
C12C811141



LQ-50 ROLL PAPER HOLDER
C12C811262



AUTOMATIC SHEET ALIGNMENT UNIT
C12C806882

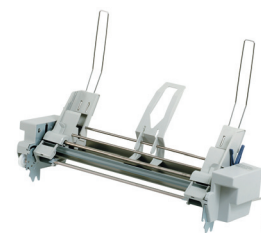

DLQ-3000+/3500 SINGLE-BIN CSF
C12C806832

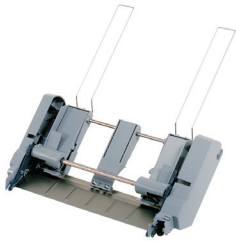

LQ-/SQ-870/LQ-570 SINGLE CSF
C12C806372

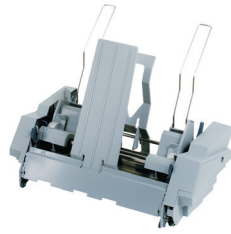

LQ-570 HIGH CAPACITY CSF
C12C806382



LQ-680/680PRO HIGH CAPACITY CSF
C12C806872



SERIAL I/F BOARD NO BUFFER TYPE-B
C12C824432



EPSON NET 10/100 BASE TX. INT. PRINT
SERV. 5E
C12C824352



DFX-9000 CABINET
7102677

Better Products for a Better Future™

At Epson, we know that planning for the future requires a strong commitment to the environment. That is why we strive to create innovative products that are reliable, recyclable, and energy efficient. Better products that use fewer resources help ensure a better future for us all.

To find out more visit www.epson.eu/ecopos

This optional, additional warranty extends your peace of mind for three years from the date of purchase. Epson CoverPlus allows the option of extending and upgrading the standard warranty available with the product to provide additional cover should the product develop any fault. Epson CoverPlus extended warranty packs must be purchased within 90 days of the purchase date of the original product it is to cover.

THE WORLD'S LEADING DOT MATRIX PRINTER MANUFACTURER

Epson is the world's largest manufacturer of dot matrix printers with a product range that offers the ultimate in high speed, low cost, reliable and durable printing across all stationery types. Ideal for back office, high volume data processing and multi-part stationery – for which there is simply no alternative – no other technology offers such broad capability from a single machine.

Offering a wider choice than any other manufacturer – and spanning every duty cycle, from light to heavy duty – the Epson dot matrix range enables you to strike exactly the right balance between capability, performance and cost.



^{*1} Worldwide sales volume, IDC

^{*2} Source: Interconnection Consulting, 2010

All features and specifications described are subject to change without notice. When Epson products are used for applications requiring high reliability/safety such as transportation devices related to aviation, rail, marine, automotive etc.; disaster prevention devices; various safety device etc.; or functional/precision device etc.; you should use the products only after giving consideration to inclusion of fail-safes and redundancies into your design to maintain safety and total system reliability.

Not all products are available in all countries. Please contact your local Epson office for more details.

For further information please contact your local Epson office or visit www.epson-europe.com

Algeria (+2213) 770 938 617 **Czech** 800/142 052 **France Export** 09 74 75 04 04 (Cost of local call, operator charges may apply)
East Africa (+254) 734 354 075 **Greece** 210-8099499 **Hungary** 06800 147 83 **Italy** 02-660321 10 (0,12 €/min) **Middle East** +9714 8872172
Morocco (+212) 661 31 11 18 **Poland** 0-0-800 4911299 (0,16 zł/min) **Russia** (095) 777-03-55 **Slovakia** 0850 111 429 **Southern Africa** (+2711) 465-9621
Turkey (0212) 3360303 **West Africa** (+234) 8022037575

Trademarks and registered trademarks are the property of Seiko Epson Corporation or their respective owners. Product information is subject to change without prior notice.