

### Overview

### HPE ProLiant ML350 Generation9 (Gen9)

The ML350 Gen9 is the 2P premium server which delivers a class-leading combination of performance, availability, expandability, manageability, reliability and serviceability making it the choice for remote offices, growing businesses and data centers.

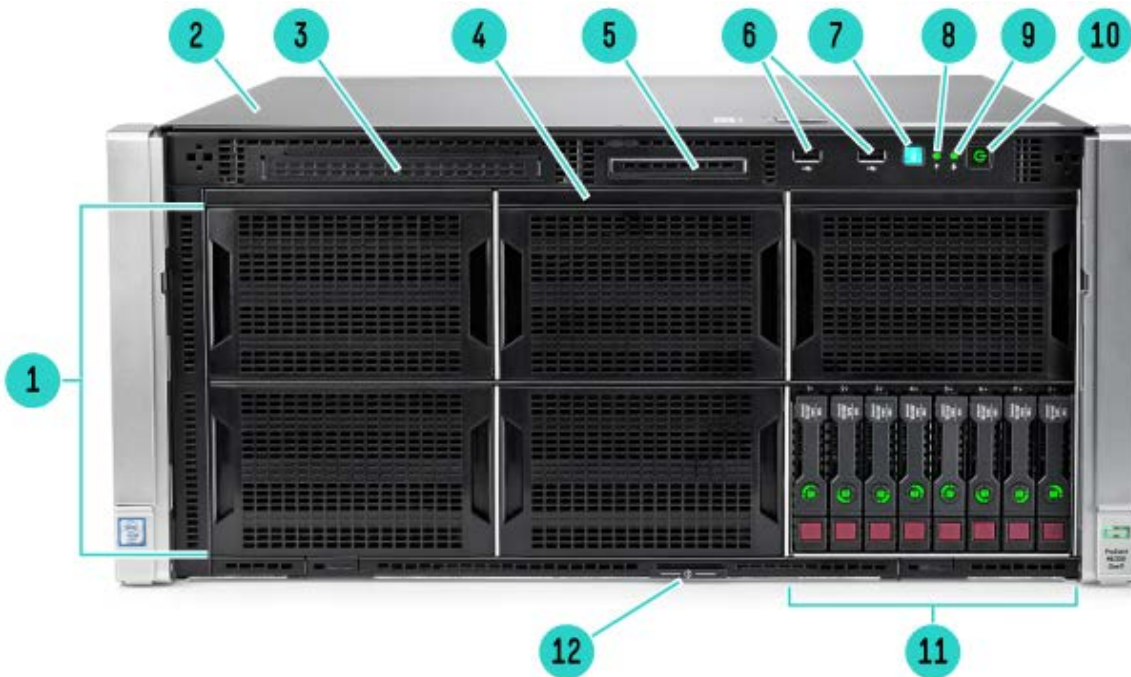

### Front View Rack Model (SFF)

- |    |                                                                                                      |    |                                                                                                                          |
|----|------------------------------------------------------------------------------------------------------|----|--------------------------------------------------------------------------------------------------------------------------|
| 1  | Optional HDD cage Drive Cage Bays (Rack shown with blanks. Tower shown with 16 LFF Optional drives)  | 2  | Quick removal access panel                                                                                               |
| 3  | Slim Height Drive Bay for Optional Slim Height SATA DVD-ROM or DVD RW Optical Drive (shown on Tower) | 4  | Media Drive Cage Bays – (Rack supports two half height or one full height device; Tower supports one half height device) |
| 5  | Systems Insight Display Bay for Optional SID (Rack models only)                                      | 6  | Two (2) USB 2.0 connectors                                                                                               |
| 7  | Unit ID LED button                                                                                   | 8  | Health LED                                                                                                               |
| 9  | NIC Activity LED                                                                                     | 10 | Power On /Standby button & system power LED button                                                                       |
| 11 | Eight (8) SFF (Rack)/LFF (Tower) SAS/SATA HDD cage                                                   | 12 | Serial label pull tab                                                                                                    |

## Overview

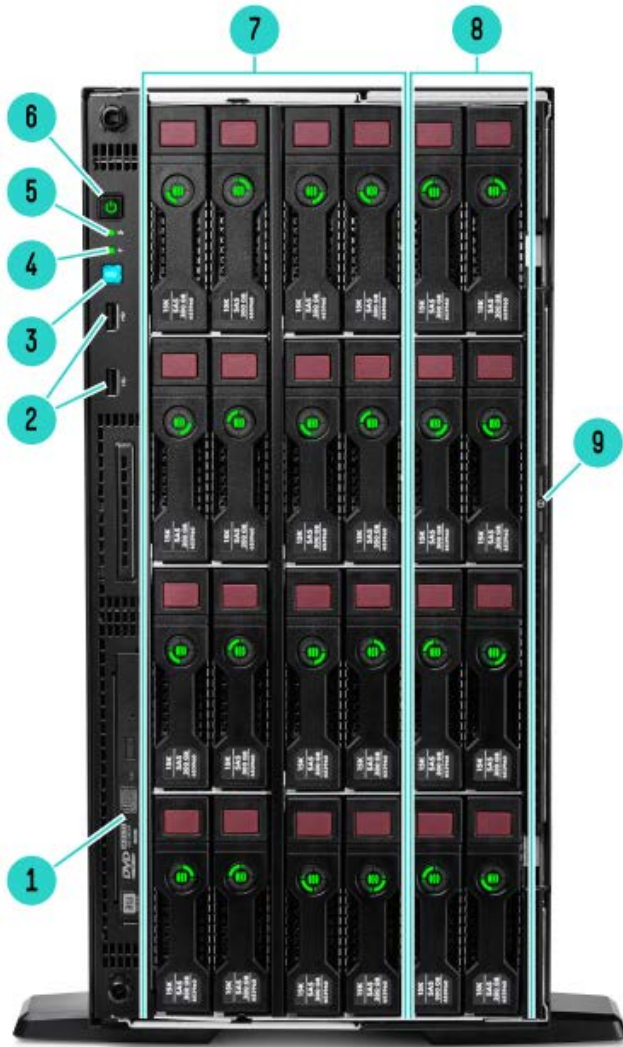

### Front View Tower Model (LFF)

- |   |                                                                                                     |   |                                                    |
|---|-----------------------------------------------------------------------------------------------------|---|----------------------------------------------------|
| 1 | Slim Height Drive Bay for Optional Slim Height SATA DVD-ROM or DVD RW Optical Drive                 | 2 | Two (2) USB 2.0 connectors                         |
| 3 | Unit ID LED button                                                                                  | 4 | Health LED                                         |
| 5 | NIC Activity LED                                                                                    | 6 | Power On /Standby button & system power LED button |
| 7 | Optional HDD cage Drive Cage Bays (Rack shown with blanks. Tower shown with 16 LFF Optional drives) | 8 | Eight (8) SFF (Rack)/LFF (Tower) SAS/SATA HDD cage |
| 9 | Serial label pull tab                                                                               |   |                                                    |

## Overview

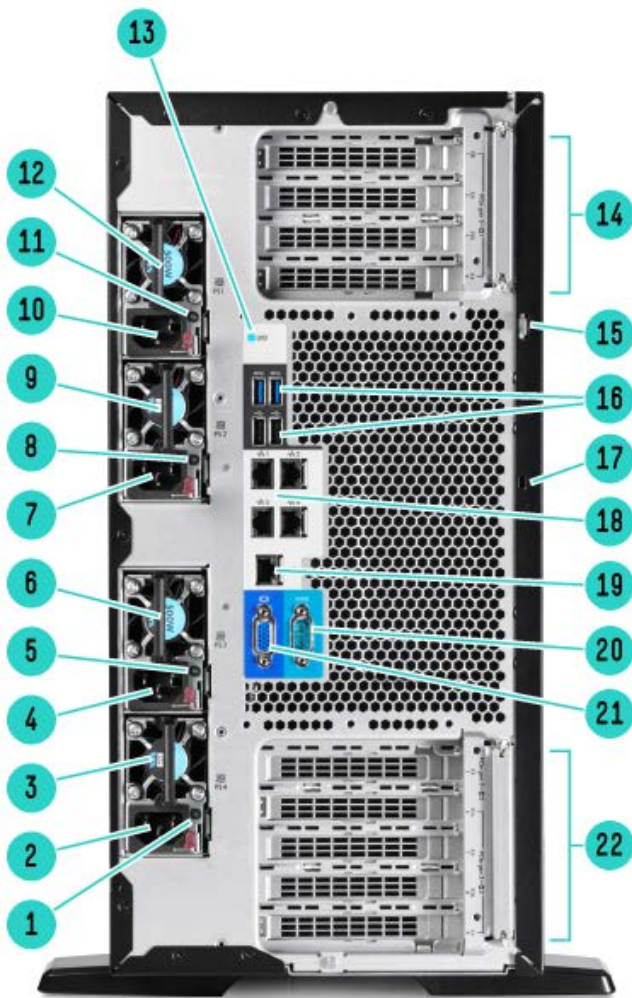

## Rear View (Tower Model)

- |    |                                                                                                                                                                                            |    |                                                                                                |
|----|--------------------------------------------------------------------------------------------------------------------------------------------------------------------------------------------|----|------------------------------------------------------------------------------------------------|
| 1  | Power supply Power LED                                                                                                                                                                     | 2  | Power supply Power connection                                                                  |
| 3  | HPE Flexible Slot 4 Power Supply (Optional - 500w Power Supply shown)                                                                                                                      | 4  | Power supply Power connection                                                                  |
| 5  | Power supply Power LED                                                                                                                                                                     | 6  | HPE Flexible Slot 3 Power Supply (Optional - 500w Power Supply shown)                          |
| 7  | Power supply Power connection                                                                                                                                                              | 8  | Power supply Power LED                                                                         |
| 9  | HPE Flexible Slot 2 Power Supply (Optional - 500w Power Supply shown)                                                                                                                      | 10 | Power supply Power connection                                                                  |
| 11 | Power supply Power LED                                                                                                                                                                     | 12 | HPE Flexible Slot 1 Power Supply (Standard Entry Model - 500w Power Supply shown)              |
| 13 | Unit ID LED                                                                                                                                                                                | 14 | PCI Slots (Slots 1-4) Slot 1 and 3 can support Optional GPU                                    |
| 15 | Padlock                                                                                                                                                                                    | 16 | USB 3.0 Connectors (2) top & USB 2.0 Connectors (2) bottom                                     |
|    | <b>NOTE: Chassis mechanical feature only to support Padlock.</b>                                                                                                                           | 18 | Embedded 4 x 1GbE Network Adapter                                                              |
|    | <b>NOTE: HPE do not offer padlock options or provide qualified part numbers. Customers will need to source from other 3rd party vendors to get this Hardware security feature enabled.</b> | 20 | Serial Connector                                                                               |
|    |                                                                                                                                                                                            | 22 | PCI Slots (Slots 5-9) requires Optional second processor-Slot 6 and 8 can support Optional GPU |

## Overview

### 17 Kensington Security Lock

**NOTE:** Chassis mechanical feature only to support Kensington Security lock.

**NOTE:** HPE do not offer Kensington security lock options or provide qualified part numbers. Customers will need to source from other 3rd party vendors to get this Hardware security feature enabled.

### 19 Dedicated iLO Connector

### 21 Video Connector

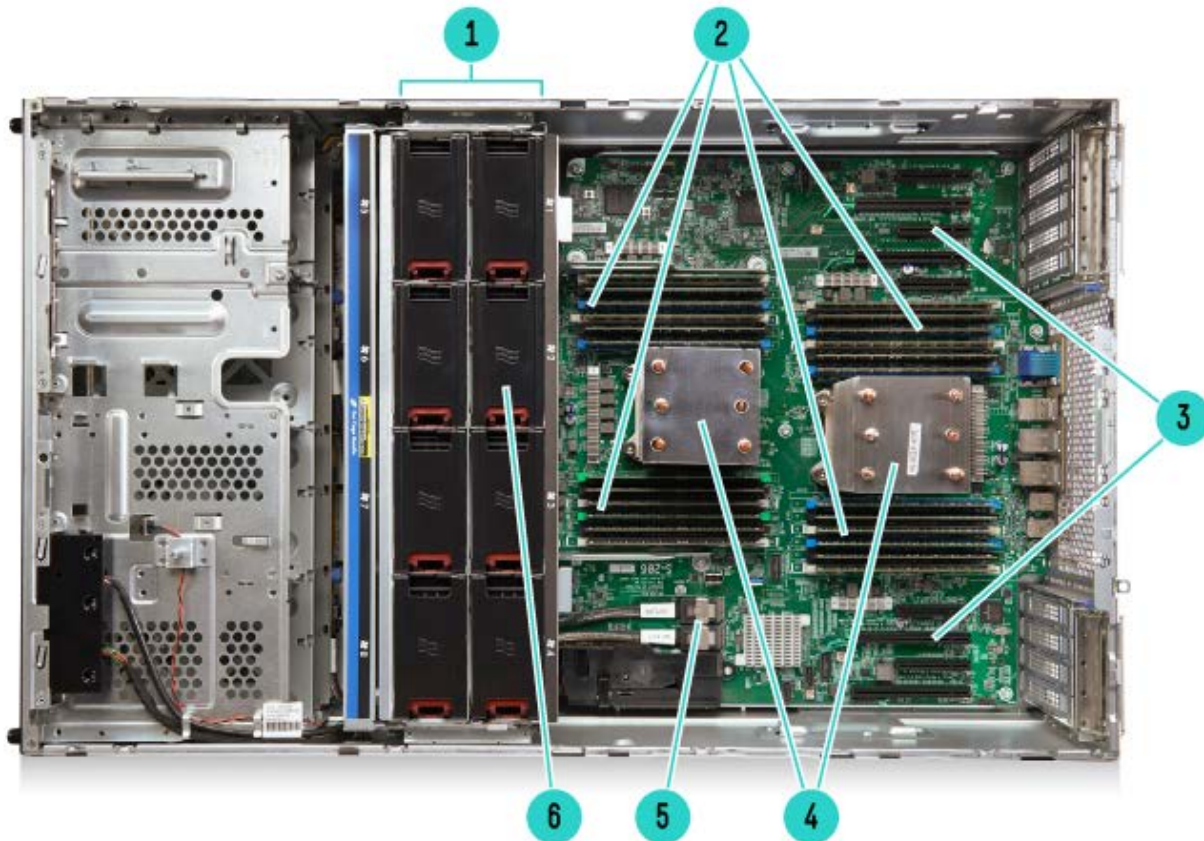

### Internal View (Rack Model)

- |   |                                                                                    |   |                                                                                            |
|---|------------------------------------------------------------------------------------|---|--------------------------------------------------------------------------------------------|
| 1 | System fans: Three (3) fans are standard Optional Five (5) systems fans are shown. | 2 | Twenty four DIMM slots: DDR4 Registered (RDIMM) or Load Reduced Registered (LRDIMM) memory |
| 3 | Nine (9) PCIe expansion slots (8 PCIe Gen3 and 1 PCIe Gen2)                        | 4 | Two (2) processors and heatsinks (Second Processor is Optional)                            |
| 5 | Optional HPE Flexible Smart Array or Smart HBA (not shown here)                    | 6 | Optional HPE Smart Storage Battery is under the system fans                                |

### What's New

- HPE DDR4 2400MHz SmartMemory RDIMM/LRDIMM offering 8/16/32/64/128 GB, maximum HOST memory capacity support up to 3 TB
- Support for Intel® Xeon® E5-2600 v4 processor offering
- New HPE 25GbE network adapter option offering, providing breakthrough performance at 2.5X increase over previous generation 10GbE
- New 10 TB SATA LFF HDD option offering, maximum internal storage capacity up to 240 TB

## Overview

- Six SFF Express Bay option supports up to six NVMe PCIe SSDs for application workloads that demand highest read/write access to storage
- TPM 2.0 module
- Graphic support of NVIDIA® M2000, M4000 and M5000
- New 16Gb and 32Gb 1-port and 2-port Fiber Channel HBA option offering

## Standard Features

**NOTE:** For more information regarding Intel Xeon processors, please see the following <http://www.intel.com/xeon>.

**Processor**  
One of the following  
depending on model

Model	CPU frequency	Cores	L3 Cache	Power	QPI	DDR4 Hz
E5-2699v3	2.3GHz	18	45MB	145W	9.6GT/s	2133
E5-2698v3	2.3GHz	16	40MB	135W	9.6GT/s	2133
E5-2697v3	2.6GHz	14	35MB	145W	9.6GT/s	2133
E5-2695v3	2.3GHz	14	35MB	120W	9.6GT/s	2133
E5-2690v3	2.6GHz	12	30MB	135W	9.6GT/s	2133
E5-2683v3	2.0GHz	14	35MB	120W	9.6GT/s	2133
E5-2680v3	2.5GHz	12	30MB	120W	9.6GT/s	2133
E5-2670v3	2.3GHz	12	30MB	120W	9.6GT/s	2133
E5-2667v3	3.2GHz	8	20MB	135W	9.6GT/s	2133
E5-2660v3	2.6GHz	10	25MB	105W	9.6GT/s	2133
E5-2650v3	2.3GHz	10	25MB	105W	9.6GT/s	2133
E5-2650Lv3	1.8GHz	12	30MB	65W	9.6GT/s	2133
E5-2643v3	3.4GHz	6	20MB	135W	9.6GT/s	2133
E5-2640v3	2.6GHz	8	20MB	90W	8.0GT/s	1866
E5-2637v3	3.5GHz	4	15MB	135W	9.6GT/s	2133
E5-2630v3	2.4GHz	8	20MB	85W	8.0GT/s	1866
E5-2630Lv3	1.8GHz	8	20MB	55W	8.0GT/s	1866
E5-2623v3	3.0GHz	4	10MB	105W	8.0GT/s	1866
E5-2620v3	2.4GHz	6	15MB	85W	8.0GT/s	1866
E5-2609v3	1.9GHz	6	15MB	85W	6.4GT/s	1600
E5-2603v3	1.6GHz	6	15MB	85W	6.4GT/s	1600
E5-2699v4	2.2GHz	22	55MB	145W	9.6GT/s	2400
E5-2698v4	2.2GHz	20	50MB	135W	9.6GT/s	2400
E5-2697v4	2.3GHz	18	45MB	145W	9.6GT/s	2400
E5-2697Av4	2.6GHz	16	40MB	145W	9.6GT/s	2400
E5-2695v4	2.1GHz	18	45MB	120W	9.6GT/s	2400
E5-2690v4	2.6GHz	14	35MB	135W	9.6GT/s	2400
E5-2683v4	2.1GHz	16	40MB	120W	9.6GT/s	2400
E5-2680v4	2.4GHz	14	35MB	120W	9.6GT/s	2400
E5-2667v4	3.2GHz	8	25MB	135W	9.6GT/s	2400
E5-2660v4	2.0GHz	14	35MB	105W	9.6GT/s	2400
E5-2650v4	2.2GHz	12	30MB	105W	9.6GT/s	2400
E5-2650Lv4	1.7GHz	14	35MB	65W	9.6GT/s	2400
E5-2643v4	3.4GHz	6	20MB	135W	9.6GT/s	2400
E5-2640v4	2.4GHz	10	25MB	90W	8.0GT/s	2133
E5-2637v4	3.5GHz	4	15MB	135W	9.6GT/s	2400
E5-2630v4	2.2GHz	10	25MB	85W	8.0GT/s	2133
E5-2630Lv4	1.8GHz	10	25MB	55W	8.0GT/s	2133
E5-2623v4	2.6GHz	4	10MB	85W	8.0GT/s	2133
E5-2620v4	2.1GHz	8	20MB	85W	8.0GT/s	2133
E5-2609v4	1.7GHz	8	20MB	85W	6.4GT/s	1866
E5-2603v4	1.7GHz	6	15MB	85W	6.4GT/s	1866

## Standard Features

<b>Chipset</b>	Intel® C610 Series Chipset Intel® E5-2600v3 Processor Family Intel® E5-2600v4 Processor Family <b>NOTE:</b> For more information regarding Intel® chipsets, please see the following URL: <a href="http://www.intel.com/products/server/chipsets/">http://www.intel.com/products/server/chipsets/</a>	
<b>On System Management Chipset</b>	HPE iLO (Firmware HPE iLO4 2.0 or later) 4GB NAND <b>NOTE:</b> 1GB USB user space configurable via UEFI and accessible via iLO. Read and learn more in the <a href="#">iLO QuickSpecs</a> .	
<b>Memory</b>	Type: One of the following HPE SmartMemory depending on model	
	DDR4 Registered (RDIMM) or Load Reduced (LRDIMM) <b>NOTE:</b> The following shows the support with E5-2600v3 processors.	
	DIMM Slots Available	24 (12 DIMM slots per processor, 4 channels per processor, 3 DIMMs per channel)
	Maximum Capacity (LRDIMM)	1.5TB (24 x 64GB LRDIMM)
	Maximum Capacity (RDIMM)	768GB 24 x 32GB RDIMM
	<b>NOTE:</b> Refer to the Memory section in this document for more memory support detail.	
	Type: <b>NOTE:</b> The following shows the support with E5-2600v4 processors.	
	DIMM Slots Available	24 (12 DIMM slots per processor, 4 channels per processor, 3 DIMMs per channel)
	Maximum Capacity (LRDIMM)	3TB (24 x 128GB LRDIMM)
	Maximum Capacity (RDIMM)	768GB 24 x 32GB RDIMM
	<b>NOTE:</b> Refer to the Memory section in this document for more memory support detail.	
	<b>NOTE:</b> Mixing of 2133 and 2400MHz memory is not supported.	
<b>Memory Protection</b>	Advanced ECC	Advanced ECC uses single device data correction to detect and correct single and all multibit error that occurs within a single DRAM chip.
	Online spare	Memory online spare mode detects a rank that is degrading and switches operation to the spare rank.
<b>Network Controller</b>	HPE 1Gb Ethernet 4-port 331i Adapter	

### Expansion Slots

Expansion Technology	Expansion Slots #	Bus Width	Connector Width	Bus Number	Form Factor	Notes
PCIe 3.0	9	x4	x8		Full-height, full-length slot	For processor 2
PCIe 3.0	8	x16	x16		Full-height, full-length slot	For processor 2
PCIe 3.0	7	x4	x8		Full-height, full-length slot	For processor 2
PCIe 3.0	6	x16	x16		Full-height, full-length slot	For processor 2

## Standard Features

5	PCIe 2.0	x4	x8		Full-height, half-length slot	For processor 2
4	PCIe 3.0	x4	x8	0	Full-height, full-length slot	For processor 1
3	PCIe 3.0	x16	x16	0	Full-height, full-length slot	For processor 1
2	PCIe 3.0	x4	x8	0	Full-height, full-length slot	For processor 1
1	PCIe 3.0	x8	x16	0	Full-height, full-length slot	For processor 1

**NOTE:** Bus number - Default bus assignment (in decimal). Inserting cards with PCI bridges may alter the actual bus assignment number.

**NOTE:** Nine total expansion slots. Three PCIe 3.0 x16 (x16 speed); One PCIe 3.0 x16 (x8 speed); Four PCIe 3.0 x8 (x4 speed); One PCIe 2.0 x8 (x4 speed).

<b>Storage Controller</b> One of the following depending on model	Entry Models	HPE Dynamic Smart Array B140i Embedded SATA controller
	Base Models	HPE Flexible Smart Array P440ar/2GB
	Performance Models	HPE Flexible Smart Array P440ar/2GB

<b>Internal Storage Devices</b> One of the following depending on model	Optical Drive	Optional SATA 9.5mm DVD-ROM Optical Drive Optional SATA 9.5mm DVD RW Optical Drive <b>NOTE: Optical is optional in entry, base and performance BTO models.</b>
	Hard Drive Bays	8 Hot plug SFF SAS/SATA HDD bays; upgradable to 48 8 Hot plug LFF SAS/SATA HDD Bays; upgradable to 24 <b>NOTE: All Pre-configured Models come populated with some hard drive blanks installed. Should the customer need additional hard drive blanks, they can order more using either P/N 666987-B21: HPE SFF HDD Blank Kit or P/N 666986-B21: HPE LFF HDD Blank Kit. These part numbers for single HDD blanks below are also provided should the customer require replacement HDD blanks for their server.</b>
	Hard Drives	None ship standard

Maximum Internal Storage	CAPACITY	CONFIGURATION	
One of the following depending on model	Hot Plug LFF SAS	240TB	24 x 10TB
	Hot Plug LFF SATA	240TB	24 x 10TB
	Hot Plug LFF SAS SSD	38.4TB	24 x 1.6TB
	Hot Plug LFF SATA SSD	92.16TB	24 x 3.84TB
	Hot Plug SFF SAS	96TB	48 x 2TB
	Hot Plug SFF SATA	96TB	48 x 2TB
	Hot Plug SFF SAS SSD	184.32TB	48 x 3.84TB
	Hot Plug SFF SATA SSD	184.32TB	48 x 3.84TB
	Hot Plug SFF NVMe PCIe SSD	7.2TB	6 x 1.2TB

<b>Power Supply</b> One of the following depending on model	HPE 500W Flex Slot Platinum Hot Plug Power Supply	<b>NOTE: The 500W Flex Slot PSU was not qualified or supported with the X4 RPS Enablement Kit.</b>
	HPE 800W Flex Slot Platinum Hot Plug Power Supply	
	HPE 1400W Flex Slot Platinum Plus Hot Plug Power Supply	
	HPE Flexible Slot (Flex Slot) Power Supplies share a common electrical and physical design that allows for hot plug, tool-less installation into HPE ProLiant Gen9 Performance Servers. Flex Slot power supplies	



## Standard Features

are certified for high-efficiency operation and offer multiple power output options, allowing users to "right-size" a power supply for specific server configurations. This flexibility helps to reduce power waste, lower overall energy costs, and avoid "trapped" power capacity in the data center.

To review the power requirements for your selected system, please use the HPE Power Advisor Tool located at <http://www.hp.com/go/hppoweradvisor>.

Power specifications and technical content for all HPE Server power supplies can be found at <http://www.hp.com/go/proliant/powersupply>.

System Fans	Non-redundant	Redundant
One of the following depending on model	3 fans	6 fans
1P model	3 fans	6 fans
	<b>NOTE:</b> Fan Redundancy is standard in performance model. ML350 Gen9 Redundant Fan option kit (725878-B21) consists of four system fans and two PCIe air baffles.	
	Non-redundant	Redundant
2P model	4 fans	8 fans
	<b>NOTE:</b> Refer to ML350 Gen9 User Guide for fan configuration rules.	

Interfaces		
Serial	1	
Video	1 (rear)	
Network RJ-45 (Ethernet)	4	
HPE iLO Remote Management Network Port	1 Gb Dedicated	
SD Slot	1 (internal)	
	<b>NOTE:</b> The Micro-SD slot is not a hot-pluggable device. Customers should not attempt to plug a Micro-SD card into the Micro-SD slot while the server is powered.	
USB 2.0 Ports	5 (2 front, 2 rear, 1 internal)	
USB 3.0	3 (2 rear, 1 internal)	

Operating Systems and Virtualization Software Support for ProLiant Servers	Microsoft Windows Server
	<u>Canonical Ubuntu</u>
	<u>Red Hat Enterprise Linux (RHEL)</u>
	<u>SUSE Linux Enterprise Server (SLES)</u>
	<u>VMware</u>
	<u>Citrix XenServer</u>

**NOTE:** For more information on Hewlett Packard Enterprise Certified and Supported ProLiant Servers for OS and Virtualization Software and latest listing of software drivers available for your server, please visit our Support Matrix at: <http://www.hp.com/go/ossupport> and our driver download page <http://h20565.www2.hp.com/hpsc/swd/public/readIndex?sp4ts.oid=7271260>.

Upgradeability	
	Upgradeable to 2 processors (up to 22 cores)
	<b>NOTE:</b> Total 4, 6, 8, 10, 12, 14, 16, 18, 20 & 22 cores.
	Up to 24 DIMM slots available for higher Memory capacity
	Up to 48 SFF Hard Drive Bays; Or 24 LFF Hard Drive Bays
	Up to 6 SFF NVMe PCIe SSD drives
	<b>NOTE:</b> The ML350 Gen9 6SFF Express Bay kit MUST be installed and it takes up one SFF drive cage space. For detail, refer to Express Bay kit and NVMe SSD section.
	8 PCIe 3.0 and 1 PCIe 2.0 I/O slots for additional communications and storage expansion
	4 redundant hot-plug power supplies
	Redundant Fan

## Standard Features

Optional optical drive (up to 1)

**NOTE:** Support of 9.5mm DVD-RW or DVD-ROM.

Optional SFF or LFF media bay kit to support RDX or tape device(s)

Tower to rack conversion

Optional System Insight Display

**NOTE:** Rack model only.

---

### Industry Standard Compliance

ACPI 2.0b Compliant

PCIe 3.0 Compliant

PXE Support

WOL Support

Novell Certified

IPMI 2.0, SMASH CLP, DCMI 1.0 compliant

Microsoft® Logo certifications

USB 3.0 Support

SMBIOS 2.7.1

ASHRAE A3/A4

Energy Star

---

### Graphics

16 bit color: maximum resolution of 1920 x 1200

Integrated Matrox G200 video standard

32 bit color: maximum resolution of 1280 x 1024

- 16 MB Flash
- 256 MB DDR3

---

### HPE Server UEFI/Legacy ROM

Unified Extensible Firmware Interface (UEFI) is an industry standard that provides better manageability and more secured configuration than the legacy ROM while interacting with your server at boot time. HPE ProLiant Gen9 platform defaults to UEFI and can be factory or field configured for Legacy BIOS Boot Mode.

**NOTE:** The UEFI System Utilities function is analogous to the HPE ROM-Based Setup Utility (RBSU) of legacy BIOS. For more information, please visit <http://www.hpe.com/servers/uefi>

UEFI enables numerous new capabilities specific to HPE ProLiant servers such as:

- Secure Boot
- Operating system specific functionality
- Support for > 2.2 TB (using GPT) boot drives
- USB 3.0 Stack
- Embedded UEFI Shell
- Mass Configuration Deployment Tool using RESTful API for iLO 4
- PXE boot support for IPv6 networks
- Boot support for option cards that only support a UEFI option ROM
- Network Stack configurations

**NOTE:** For UEFI Boot Mode, boot environment and OS image installations should be configured properly to support UEFI.

**NOTE:** UEFI FIO Setting (758959-B22) can be selected to configure the system in Legacy mode in the factory for your HPE ProLiant Gen9 Server.

## Standard Features

<b>Form Factor</b>	Tower or Rack (5U)
<b>Embedded Management</b>	<p><b>HPE Integrated Lights-Out (HPE iLO)</b> Monitor your servers for ongoing management, service alerting, reporting and remote management with HPE iLO. Learn more at <a href="http://www.hpe.com/info/ilo">http://www.hpe.com/info/ilo</a>.</p> <p><b>UEFI</b> Configure and boot your servers securely with industry standard Unified Extensible Firmware Interface (UEFI). Learn more at <a href="http://www.hpe.com/servers/uefi">http://www.hpe.com/servers/uefi</a>.</p> <p><b>RESTful API</b> RESTful API for iLO 4 is Redfish 1.0 conformance for simplified server management such as configuration and maintenance tasks based on modern industry standards. Learn more at <a href="http://www.hpe.com/info/restfulapi">http://www.hpe.com/info/restfulapi</a>.</p> <p><b>Intelligent Provisioning</b> Hassle free server and OS provisioning for 1 or few servers with Intelligent Provisioning. Learn more at <a href="http://www.hpe.com/servers/intelligentprovisioning">http://www.hpe.com/servers/intelligentprovisioning</a>.</p> <p><b>Embedded Remote Support</b> The Hewlett Packard Enterprise embedded remote support, when used with Insight Online direct connect or HPE Insight Remote Support, allows HPE ProLiant servers to transmit hardware events directly to Hewlett Packard Enterprise or a Hewlett Packard Enterprise Authorized Partner for automated phone home support. Learn more at <a href="http://www.hpe.com/info/insightonline/explore">http://www.hpe.com/info/insightonline/explore</a>.</p>
<b>Server utilities</b>	<p><b>Smart Update</b> Optimize firmware and driver updates with Smart Update solutions including Smart Update Manager (SUM) and Service Pack for ProLiant (SPP). Learn more at <a href="http://www.hpe.com/servers/smartupdatemanager">http://www.hpe.com/servers/smartupdatemanager</a>.</p> <p><b>HPE Systems Insight Manager (HPE SIM)</b> HPE SIM allows you to monitor the health of your HPE ProLiant Servers and HPE Integrity Servers, and also provides you with basic support for non-HPE servers. HPE SIM also integrates with Smart Update Manager to provide quick and seamless firmware updates. Learn more at <a href="http://www.hpe.com/servers/hpsim">http://www.hpe.com/servers/hpsim</a>.</p> <p><b>Scripting Tool Kit and Windows PowerShell</b> Provision 1 to many servers using your own scripts to discover and deploy them with Scripting Tool Kit (STK) for Windows and Linux or Scripting Tools for Windows PowerShell. Learn more at <a href="http://www.hpe.com/servers/proliant/stk">http://www.hpe.com/servers/proliant/stk</a> or <a href="http://www.hpe.com/servers/powershell">http://www.hpe.com/servers/powershell</a>.</p> <p><b>RESTful Interface Tool</b> RESTful Interface tool is a scripting tool to provision using RESTful API for iLO 4 to discover and deploy servers at scale. Learn more at <a href="http://www.hpe.com/info/resttool">http://www.hpe.com/info/resttool</a>.</p> <p><b>HPE iLO Mobile Application</b> Enables the ability to access, deploy, and manage your server anytime from anywhere from select smartphones and mobile devices. For additional information please visit: <a href="http://www.hpe.com/info/ilo/mobileapp">http://www.hpe.com/info/ilo/mobileapp</a>.</p> <p><b>HPE Insight Online</b> HPE Insight Online, available at no additional cost as part of your Hewlett Packard Enterprise warranty or contractual support agreement with Hewlett Packard Enterprise, is a personalized dashboard for simplified tracking of IT operations</p>

## Standard Features

and support information from anywhere, anytime. Learn more at <http://www.hpe.com/info/insightonline/explore>.

**NOTE:** The Service Pack for ProLiant (which includes SUM) can be downloaded from <http://www.hpe.com/servers/spp/download>. More information can be found on: <http://www.hpe.com/info/smartupdate>, <http://www.hpe.com/servers/spp> and <http://www.hpe.com/servers/hpsum>.

---

### Security

Power-on password

Setup password

Serial interface control

Power switch security

Administrator's password

UEFI

TPM 1.2

**NOTE:** Refer to Additional Options section in this document for detail.

TPM 2.0

**NOTE:** Need to upgrade BIOS before using the TPM 2.0. Refer to Additional Options section in this document for detail.

Security Front Bezel

**NOTE:** Refer to Additional Options section in this document for detail.

Chassis mechanical support of padlock and Kensington Security lock (located at system rear)

**NOTE:** HPE do not offer padlock or Kensington security lock options or provide qualified part numbers. Customers will need to source from other 3rd party vendors to get these Hardware security features enabled.

---

### Warranty

This product is covered by a global limited warranty and supported by HPE Services and a worldwide network of HPE Authorized Channel Partners resellers. Hardware diagnostic support and repair is available for three years from date of purchase. Support for software and initial setup is available for 90 days from date of purchase. Enhancements to warranty services are available through HPE Care Pack services or customized service agreements. Hard drives have either a one year or three year warranty; refer to the specific hard drive QuickSpecs for details.

**NOTE:** Server Warranty includes 3-Year Parts, 3-Year Labor, 3-Year Onsite support with next business day response. Warranty repairs may be accomplished through the use of Customer Self Repair (CSR) parts. These parts fall into two categories: 1) Mandatory CSR parts are designed for easy replacement. A travel and labor charge will result when customers decline to replace a Mandatory CSR part; 2) Optional CSR parts are also designed for easy replacement but may involve added complexity. Customers may choose to have HPE replace Optional CSR parts at no charge. Additional information regarding worldwide limited warranty and technical support is available at: <http://h17007.www1.hpe.com/us/en/enterprise/servers/warranty/>.

## Optional Features

<b>Embedded Management</b>	<b>iLO Advanced</b>	HPE iLO Advanced licenses offer smart remote functionality without compromise, for all HPE ProLiant servers. The license includes the full integrated remote console, virtual keyboard, video, and mouse (KVM), multi-user collaboration, console record and replay, and GUI-based and scripted virtual media and virtual folders. You can also activate the enhanced security and power management functionality. Learn more about HPE iLO Advanced at <a href="http://www.hpe.com/servers/iloadvanced">http://www.hpe.com/servers/iloadvanced</a> .
<b>Server Management</b>	<b>HPE Insight Control</b>	HPE Insight Control, lets you deploy, migrate, monitor, remote control, and optimize your IT infrastructure through a single, simple management console. For more information, see <a href="http://www.hpe.com/info/insightcontrol">http://www.hpe.com/info/insightcontrol</a> .
	<b>HPE Insight Cluster Management Utility (CMU)</b>	HPE Insight Cluster Management Utility is a HyperScale management framework that includes software for the centralized provisioning, management and monitoring of nodes and infrastructure. Learn more at <a href="http://www.hpe.com/info/cmu">http://www.hpe.com/info/cmu</a> .
<b>Rack and Power Infrastructure</b>	HPE Rack and Power Infrastructure products and services create highly efficient and intelligent solutions for existing or new IT data centers. HPE Rack and Power infrastructure solutions – rack infrastructure, power protection and management, performance optimized data centers (PODs) – are the foundation you are looking for to help secure your long-term IT success. These products are designed to help you react to changes in the industry. They deliver efficient, easy-to-use capabilities to manage, monitor, deploy and provision infrastructure from entry to enterprise. As an industry leader, Hewlett Packard Enterprise is uniquely positioned to address the key concerns of power, cooling, cable management and system access. Learn more at <a href="#">HPE Rack and Power Infrastructure</a> .	
<b>High Performance Clusters</b>	HPE Cluster Platforms are specifically engineered, factory-integrated large-scale ProLiant clusters optimized for High Performance Computing, with a choice of servers, networks and software. Operating system options include specially priced offerings for Red Hat Enterprise Linux and SUSE Linux Enterprise Server, as well as Microsoft Windows HPEC Server. A Cluster Platform Configurator simplifies ordering. <a href="http://www.hp.com/go/clusters">http://www.hp.com/go/clusters</a> . HPE Insight Cluster Management Utility (CMU) is a Hewlett Packard Enterprise licensed and supported suite of tools that are used for lifecycle management of hyperscale clusters of Linux ProLiant systems. CMU includes software for the centralized provisioning, management and monitoring of nodes. CMU makes the administration of clusters user friendly, efficient, and effective. <a href="http://www.hp.com/go/cmu">http://www.hp.com/go/cmu</a> . <b>NOTE:</b> High Performance Computing (HPC) interconnect technologies are available for this server as part of the HPE Cluster Platform portfolio. These high-speed InfiniBand and Gigabit interconnects are fully supported by Hewlett Packard Enterprise when integrated within a Hewlett Packard Enterprise cluster. Flexible, validated solutions can be defined with the help of configuration tools. <a href="http://www.hp.com/techservers/clusters/ucp/index.html">http://www.hp.com/techservers/clusters/ucp/index.html</a> .	
<b>HPC Interconnects</b>	<b>NOTE:</b> High Performance Computing (HPC) interconnect technologies are available for this server under the HPE Cluster Platform product portfolio. These high-speed interconnects are fully supported by Hewlett Packard Enterprise when they are part of these configure to order clusters. Solutions can be defined with a lot of flexibility with the help of configuration tools. Please visit the following URL to configure HPEC Clusters with InfiniBand Interconnects: <a href="http://www.hp.com/techservers/clusters/ucp/index.html">http://www.hp.com/techservers/clusters/ucp/index.html</a> .	
<b>Storage Software</b>	Whether you need to solve a specific data protection, archiving, or storage command and control challenge, or deliver on strategic consolidation, compliance, or continuity initiatives, look no further	

## Optional Features

than Hewlett Packard Enterprise storage software. Our storage software helps you reduce costs, simplify storage infrastructure, protect vital assets and respond faster to business opportunities. Storage software that gets the job done:

- **Data Protection and Recovery Software**  
Whether you're a large enterprise or a smaller business, Hewlett Packard Enterprise data protection and recovery software will cost-effectively protect you against disaster and ensure business continuity.
- **Data Archive and Migration Software**  
Hewlett Packard Enterprise storage software enables you to comply with data retention and retrieval requirements, improve application performance, and reduce costs by efficiently migrating infrequently accessed or less valuable data to lower cost storage.
- **Storage Resource Management Software (SRM)**  
Hewlett Packard Enterprise storage resource management software reduces operational costs and provides the command and control foundation you need to efficiently manage and visualize your physical and virtual environments.
- **Data Replication Software**  
Hewlett Packard Enterprise offers array-based and host-based replication software for use in disaster recovery, testing, application development and reporting.
- **Storage Device Management Software**  
Maximize your investment in Hewlett Packard Enterprise storage and networking with software that enables hardware-specific configuration, performance tuning and connectivity management.
- **HPE StoreVirtual VSA**  
Make the move to virtualized storage with HPE StoreVirtual VSA. Transform unused capacity inside your servers into a virtual storage array. Add StoreVirtual VSA to multiple servers, manage it as a single pool of shared storage capacity, and scale it to match your evolving needs. HPE ProLiant Gen9 servers include a 3-year limited license for HPE software-defined storage at no extra cost. You have the option to install free 1TB-capacity StoreVirtual VSA software during server setup within Intelligent Provisioning. More information, instructional videos, and free management software are available at <http://www.hpe.com/storage/tryVSA>.

**NOTE:** For more information about Storage Software including QuickSpecs, please see: <http://www.hp.com/go/storage/software>.

---

### One Config Simple (SCE)

SCE is a guided self-service tool to help sales and non-technical people provide customers with initial configurations in 3 to 5 minutes. You may then send the configuration on for configuration help, or use in your existing ordering processes. If you require "custom" rack configuration or configuration for products not available in SCE, please contact Hewlett Packard Enterprise Customer Business Center or an Authorized Partner for assistance. <https://h22174.www2.hp.com/SimplifiedConfig/Index>

## Service and Support

### HPE Support Services

HPE Technology Services delivers confidence, reduces risk and helps customers realize agility and stability. Connect to Hewlett Packard Enterprise to help prevent problems and solve issues faster. HPE Support Services enable you to choose the right service level, length of coverage and response time as you purchase your new server, giving you full entitlement to the support for need for your IT and business.

### Connect your devices

Unlock all of the benefits of your technology investment by connecting your products to Hewlett Packard Enterprise. Achieve up to 77%<sup>1</sup> reduction in down time, near 100%<sup>2</sup> diagnostic accuracy and a single consolidated view of your environment. By connecting, you will receive 24x7 monitoring, pre-failure alerts, automatic call logging, and automatic parts dispatch. HPE Proactive Care Service and HPE Datacenter Care Service customers will also benefit from proactive activities to help prevent issues and increase optimization. All of these benefits are already available to you with your server storage and networking products, securely connected to Hewlett Packard Enterprise support.

1- IDC 2 - HP CSC reports 2014 - 2015

### Recommended Support

#### **Standard: HPE Proactive Care\* with 24x7 coverage, three year Support Service**

HPE Proactive Care gives customers an enhanced call experience. When your products are connected to Hewlett Packard Enterprise, Proactive Care helps prevent problems and maintains IT stability by utilizing personalized proactive reports with recommendations and advice. This service combines three years proactive reporting and advice with our 24x7 coverage, four hour hardware response time when there is a problem. This service also includes collaborative software support for Independent Software Vendors (ISVs), (Red Hat, VMWare, Microsoft, etc.) running on your HPE servers.

<https://www.hpe.com/h20195/v2/GetPDF.aspx/4AA3-8855ENW.pdf>

#### **Optimized HPE Proactive Care\* with 6 hour call-to-repair commitment, three year Support Service**

HPE Proactive Care gives customers an enhanced call experience. When your products are connected to Hewlett Packard Enterprise, Proactive Care helps prevent problems and maintains IT stability by utilizing personalized proactive reports with recommendations and advice. This service combines three years' proactive reporting and advice with our highest level of hardware support – Hewlett Packard Enterprise 24x7, six hour hardware call-to-repair. Hewlett Packard Enterprise is the only leading manufacturer who makes this level of coverage available as a standard service offering for your most valuable servers. This service also includes collaborative software support for Independent Software Vendors (ISVs), (Red Hat, VMWare, Microsoft, etc.) running on your HPE servers.

<https://www.hpe.com/h20195/v2/GetPDF.aspx/4AA3-8855ENW.pdf>

### Parts and Materials

Hewlett Packard Enterprise will provide Hewlett Packard Enterprise-supported replacement parts and materials necessary to maintain the covered hardware product in operating condition, including parts and materials for available and recommended engineering improvements.

Parts and components that have reached their maximum supported lifetime and/or the maximum usage limitations as set forth in the manufacturer's operating manual, product QuickSpecs, or the technical product data sheet will not be provided, repaired, or replaced as part of these services.

The defective media retention service feature option applies only to Disk or eligible SSD/Flash Drives replaced by Hewlett Packard Enterprise due to malfunction.

### Related Services

#### **HPE Server Hardware Installation**

Provides for the basic hardware installation of Hewlett Packard Enterprise branded servers, storage devices and networking options to assist you in bringing your new hardware into operation in a timely and professional manner.

<https://www.hpe.com/h20195/V2/GetPDF.aspx/5981-9356EN.pdf>

#### **HPE Installation and Startup Service**

Provides for the installation and startup of Hewlett Packard Enterprise technology including BladeSystems, C-Class enclosure, HPE ProLiant c-Class and Integrity server blades, storage blades, SAN switch blades, HPE Virtual Connect modules (Ethernet and Fibre Channel), Ethernet network interconnects, and InfiniBand, as well as the installation of one supported operating system type (Windows® or Linux).

---

## Service and Support

### HPE Technology Services Support Credits

Offer flexible services and technical skills to meet your changing IT demands. With a menu of service that is tailored to suit your needs, you get additional resources and specialist skills to help you maintain peak performance of your IT. Offered as annual credits, you can plan your budgets while proactively responding to your dynamic business.

---

### HPE Education Services

Keep your IT staff trained making sure they have the right skills to deliver on your business outcomes. Book on a class today and learn how to get the most from your technology investment. <http://www.hpe.com/ww/learn>

---

**HPE Support Center** The HPE Support Center is a personalized online support portal with access to information, tools and experts to support Hewlett Packard Enterprise business products. Submit support cases online, chat with Hewlett Packard Enterprise experts, access support resources or collaborate with peers.

Learn more <http://www.hpe.com/support/hpesc>

The Hewlett Packard Enterprise Support Center Mobile App\* allows you to resolve issues yourself or quickly connect to an agent for live support. Now, you can get access to personalized IT support anywhere, anytime.

HPE Insight Remote Support and HPE Support Center are available at no additional cost with a Hewlett Packard Enterprise warranty, HPE Support Service or Hewlett Packard Enterprise contractual support agreement.

\*HPE Support Center Mobile App is subject to local availability.

For more information: <http://www.hpe.com/services>



## Pre-configured Models

For the Standard Features shipped in the "Factory Integrated Models", please see the "Configuration Information - Factory Integrated Models" section.

1. Pre-configured models ship with the configurations below. Options can be selected from the Core or Additional options section of this QuickSpecs.
2. Hewlett Packard Enterprise does not allow factory integration of options into pre-configured models. Any additional options purchased will be shipped separately.
3. If you desire a custom configuration please see "Configuration Information - Factory Integrated Models" section of this QuickSpecs.
4. Not all models are available in all regions. Check with your local country Hewlett Packard Enterprise offices for availability.

**NOTE:** All Pre-configured Models come populated with some hard drive blanks installed. Should the customer need additional hard drive blanks, they can order more using either P/N 666987-B21: HPE SFF Hard Drive Blank Kit or P/N 666986-B21: HPE LFF Hard Drive Blank Kit.

**NOTE:** All pre-configured servers ship with a standard 6-foot IEC C-13/C-14 jumper cord (A0K02A). This jumper cord is also included with each standard AC power supply option kit. If a different power cord is required, please check the [ProLiant Power Cables](#) web page.

**CAUTION:** Hewlett Packard Enterprise recommends that a minimum of two people are required for all Rack Server installations. Please refer to your installation instructions for proper tools and number of people to use for any installation.

	Entry Models		Base Models	
<b>[SKU Number]</b>	765819-xx1	835262-xx1	765820-xx1	835263-xx1
<b>Model Name</b>	HPE ProLiant ML350 Gen9 E5-2609v3 8GB-R B140i 8LFF 500W PS Entry Tower Server	HPE ProLiant ML350 Gen9 E5-2609v4 1P 8GB-R B140i 8LFF 500W PS Entry Server	HPE ProLiant ML350 Gen9 E5-2620v3 16GB-R P440ar 8SFF 500W PS Base Tower Server	HPE ProLiant ML350 Gen9 E5-2620v4 16GB-R P440ar 8SFF 500W PS Base Server
<b>Processor</b>	Intel® Xeon® E5-2609v3	Intel® Xeon® E5-2609v4	Intel® Xeon® E5-2620v3	Intel® Xeon® E5-2620v4
<b>Number of Processors</b>	One			
<b>Memory</b>	8GB (1x8GB Registered DIMMs, 2133 MHz)	8GB (1x8GB Registered DIMMs, 2400 MHz)	16GB (1x16GB Registered DIMMs, 2133 MHz)	16GB (1x16GB Registered DIMMs, 2400 MHz)
<b>Network Controller</b>	HPE Embedded 1Gb Ethernet 4-port 331i Adapter			
<b>Storage Controller</b>	HPE Dynamic Smart Array B140i		HPE Smart Array P440ar/2G Controller	
<b>Hard Drive</b>	None ship standard; includes 6 LFF hard drive blanks		None ship standard; includes 6 SFF hard drive blanks	
<b>Internal Storage</b>	8 LFF HDD Bays (upgradable to 24)		8 Hot plug SFF SAS/SATA HDD Bays; upgradeable to 48	
<b>Optical Drive Bay</b>	Optional LFF Media Cage Kit (726561-B21)		Optional SFF Media Cage Kit (726545-B21)	
<b>Optical Drive</b>	Optional Slim Optical Bay (SATA DVD-RW/ROM Optical Drive)			
<b>PCI-Express Slots</b>	9 PCIe slots			
<b>Power Supply</b>	(1) HPE 500W Flex Slot Platinum Power Supply			
<b>Fans</b>	3 hot swap fans, non-redundant			
<b>Management</b>	iLO Management (standard), Intelligent Provisioning (standard), iLO Advanced (optional), Insight Control (optional), HPE OneView (optional)			
<b>Energy Star</b>		Meets Energy Star requirements		Meets Energy Star requirements
<b>Form Factor</b>	Tower (5U)			

## Pre-configured Models

<b>Warranty</b>	Server Warranty includes 3-Year Parts, 3-Year Labor, 3-Year Onsite support with next business day response			
	<b>Performance Rack Models</b>		<b>Performance Models</b>	
<b>[SKU Number]</b>	765821-xx1	835264-xx1	765822-xx1	835265-xx1
<b>Model Name</b>	HPE ProLiant ML350 Gen9 2xE5-2630v3 2P 32GB-R P440ar 8SFF 2x800W PS ES Rack Server	HPE ProLiant ML350 Gen9 2xE5-2630v4 2P 32GB-R P440ar 8SFF 2x800W PS Perf ES Rack Server	HPE ProLiant ML350 Gen9 2xE5-2650v3 2P 32GB-R P440ar 8SFF 2x800W PS ES Tower Server	HPE ProLiant ML350 Gen9 E5-2650v4 2P 32GB-R P440ar 8SFF 2x800W PS Perf Server
<b>Processor</b>	Intel® Xeon® E5-2630v3	Intel® Xeon® E5-2630v4	Intel® Xeon® E5-2650v3	Intel® Xeon® E5-2650v4
<b>Number of Processors</b>	Two			
<b>Memory</b>	32GB (2x16GB Registered DIMMs, 2133 MHz)	32GB (2x16GB Registered DIMMs, 2400 MHz)	32GB (2x16GB Registered DIMMs, 2133 MHz)	32GB (2x16GB Registered DIMMs, 2400 MHz)
<b>Network Controller</b>	HPE Embedded 1Gb Ethernet 4-port 331i Adapter			
<b>Storage Controller</b>	HPE Smart Array P440ar/2G Controller			
<b>Hard Drive</b>	None ship standard; includes 6 SFF hard drive blanks			
<b>Internal Storage</b>	8 Hot plug SFF SAS/SATA HDD Bays; upgradeable to 48			
<b>Optical Drive Bay</b>	Optional SFF Media Cage Kit (726545-B21)			
<b>Optical Drive</b>	Optional Slim Optical Bay (SATA DVD-RW/ROM Optical Drive)			
<b>PCI-Express Slots</b>	9 PCIe slots			
<b>Power Supply</b>	(2) HPE 800W Flex Slot Platinum Power Supply			
<b>Fans</b>	8 hot plug fans, redundant			
<b>Management</b>	iLO Management (standard), Intelligent Provisioning (standard), iLO Advanced (optional), Insight Control (optional), HPE OneView (optional)			
<b>Energy Star</b>	Meets Energy Star requirements			
<b>Accessories</b>	Rack Kit included			
<b>Form Factor</b>	Rack (5U) HPE Easy Install Rails with CMA		Tower (5U)	
<b>Warranty</b>	Server Warranty includes 3-Year Parts, 3-Year Labor, 3-Year Onsite support with next business day response			

<b>Country Code Key</b>	xx1 = 001	US
	xx1 = 011	AU
	xx1 = 031	UK
	xx1 = 291	Japan
	xx1 = 371	AP
	xx1 = 421	EU
	xx1 = AA1	PRC
	xx1 = B21	Worldwide

**NOTE:** Not all models are available in all regions. Check with your local country Hewlett Packard Enterprise offices for availability.

## Configuration Information - Factory Integrated Models

This section lists some of the steps required to configure a Factory Integrated Model. To ensure only valid configurations are ordered, Hewlett Packard Enterprise recommends the use of an HPE approved configurator. Contact your local sales representative for information on configurable product offerings and requirements.

1. Factory Integrated Models must start with a CTO Server.
2. FIO indicates that this option is only available as a factory installable option.
3. All Factory Integrated Models will be populated with sufficient hard drive blanks based on the number of initial hard drives ordered with the server.
4. Some options may not be integrated at the factory. Contact your local sales representative for additional information.

### Step 1: Base Configuration (choose one of the following configurable models)

<b>[Chassis]</b>	HPE ProLiant ML350 Gen9 Hot Plug 8SFF Configure-to-order Rack Server	HPE ProLiant ML350 Gen9 Hot Plug 8SFF Configure-to-order Tower Server	HPE ProLiant ML350 Gen9 Hot Plug 8LFF Configure-to-order Tower Server
<b>SKU Number</b>	754534-B21	754536-B21	754537-B21
<b>Processor</b>	2 (optional) x HPE Smart Socket Guide		
<b>DIMM Slots</b>	24 DIMM slots for RDIMM, LRDIMM DDR4 Memory		
<b>Storage Controller</b>	HPE Dynamic Smart Array B140i		
<b>PCIe</b>	9 Standard (8 FH/FL, 1 FH/HL)		
<b>Drive Cage</b>	8SFF Hot Plug	8LFF Hot Plug	
<b>Network Controller</b>	HPE Embedded 1Gb Ethernet 4-port 331i Adapter		
<b>Fans</b>	3 hot swap fans, non-redundant		
<b>Management</b>	iLO Management (standard), Intelligent Provisioning (standard)		
<b>USB</b>	2 front, 2 internal, 4 rear		

### Step 2: Choose Required Options (only one of the following from each list unless otherwise noted)

Select one or two processors from Core Options-Processor section below,

- If one processor is desired, select one xxxxxx-L21
- If two processors are desired, select one xxxxxx-L21 and one xxxxxx-B21.
- Up to 2 processors supported. Mixing different processor models is not supported.
- DDR4 speed is the maximum memory speed of the processor. Actual memory speed may depend on the quantity and type of DIMMs installed.

For the Intel® C600 Chipset E5-2600 Series, the letter preceding the model number indicates the Product Line (E3, E5, E7); 2600x v#, 2 = number of CPUs in a Node, 6 is socket/segment designation, 00 = Processor SKU, x = L for low power SKUs and v# (not yet designated) = version number.

Select one or more memory from Core Options-Memory section below,

- UDIMM, RDIMM, and LRDIMM are all distinct memory technologies and cannot be mixed within a server.
- HPE memory options from previous generation servers are not qualified or warranted with Hewlett Packard Enterprise Gen9 systems. HPE SmartMemory is required to realize the memory performance improvements and enhanced functionality listed in this document for Gen9.
- If only one processor is installed, only half of the total DIMM slots are available. When populating with two processors all DIMM slots are available.
- Depending on the memory configuration and processor model, the memory speed may run at 2400MHz, 2133MHz, 1866MHz or 1600MHz. Please see Memory Population Table or the Online Memory Configuration Tool at: <http://www.hpe.com/go/ddr4config>.

## Configuration Information - Factory Integrated Models

Select one or more power supplies from Core Options-Power Supplies section below:

- Prior to selecting a power supply option, it is highly recommended that you review your server configuration in the HPE Power Advisor tool to determine the right size power supply for your server configuration. The HPE Power Advisor is located at: <http://www.hpe.com/go/hpepoweradvisor>.
- Mixing of power supplies in the same server is not supported. All power supplies must be of the same input voltage, output rating, and efficiency rating. If non-matching power supplies are installed, you may receive an error message and/or experience operational issues with your server.

### Step 3: Choose Additional Factory Integratable Options

Select a standup NIC adapter from Core Options-Networking section below,

- Please see the QuickSpecs for Technical Specifications and additional information: <http://www.hpe.com/go/ProLiantNICs>.
- These options are upgradeable and can be changed from the original configuration after the server is shipped.
- For 10Gb adapters, a minimum of two Gigabytes (2 GB) of server memory is required per each adapter.

Select one or more drives from Core Options-HPE Drives section below:

- The components of a storage subsystem (e.g. the drive, the HBA/controller, firmware, and the server backplane) should operate at the same data transfer rate or the system bandwidth will be negotiated down to an acceptable level for all components.
- Hard drives have either a one year or three year warranty; refer to the specific hard drive QuickSpecs for details.
- The HPE ProLiant Gen9 Smart Storage solutions are equipped with re-designed Small Form Factor (SFF 2.5 in) and Large Form Factor (LFF 3.5 in) hot plug carriers for HPE Qualified Hard Drives and Solid State Drives. These new carriers provide status and activity indicators as well as caution indicators for "Do Not Remove."

Select one or more graphics adapter from Additional Options section below.

- Please see the HPE Power Advisor for estimated power consumption of your individual system configuration prior to installing GPUs. The HPE Power Advisor is located at: <http://www.hpe.com/go/hpepoweradvisor>.
- This section may contain FIO options, please see HPE Computation & Graphics Accelerators section below.

Select one or more Unique options from Core Options section below.

- This section may contain FIO options, please see the Unique options section below.
- FIO indicates that this option is only available as a factory installable option.

Select one or more Fan Kits from Core Options section below.

- This section may contain FIO options, please see HPE Cooling Options section below.
- FIO indicates that this option is only available as a factory installable option.

Select one or more Storage options from Additional Options section below.

- The embedded B140i controller will operate in UEFI only mode. For legacy support an additional controller will be needed, and for CTO orders please also select the Legacy mode settings part, 758959-B22
- This section may contain FIO options, please see HPE Storage Controllers section below.
- FIO indicates that this option is only available as a factory installable option.

Select one type of rail kit from Additional Options section below.

## Configuration Information - Factory Integrated Models

- Please take a moment to review the installation documentation that comes with the server to help you with the installation of your Gen9 server.
- To assist in the installation of the server into the rack, an optional installation tool is available by contacting your local services representative (p/n 695539-001).
- See Hewlett Packard Enterprise Rack Options in Additional Options section of this QuickSpecs for more rack kit choices.

**CAUTION:** Hewlett Packard Enterprise recommends that a minimum of two people are required for all Rack Server installations. Please refer to your installation instructions for proper tools and number of people to use for any installation.

## Core Options

**NOTE:** Some options may not be integrated at the factory. To ensure only valid configurations are ordered, Hewlett Packard Enterprise recommends the use of an HPE approved configurator. Contact your local sales representative for additional information.

<b>HPE Unique Options</b>	HP ML350 Gen9 8LFF Hot Plug Drive Cage Kit	726547-B21
	<b>NOTE:</b> Add'l 8LFF Hard Drive Cage/backplane assembly, allowing for up to 24FF Drive Bays.	
	HP ML350 Gen9 8SFF Hard Drive Cage Kit	778157-B21
	<b>NOTE:</b> Add'l 8SFF Hard Drive Cage/Backplane assembly, allowing for up to 48SFF Drive Bays.	
	HP ML350 Gen9 Redundant Fan Kit	725878-B21
	<b>NOTE:</b> This kit consists of four add'l system fans and two PCIe air baffles to support fan redundancy.	
	HP ML350 Gen9 LFF Media Cage Kit	726561-B21
	<b>NOTE:</b> Cage for converting LFF drive bays to a media device. Supports 1*Half-Height tape storage/ Disk-Based Backup device. (RDX)	
	HP ML350 Gen9 SFF Media Cage Kit	726545-B21
	<b>NOTE:</b> Cage for converting SFF drive bays to a media device. Supports 2*Half-Height/ 1*Full-Height tape storage/ Disk-Based Backup device (RDX).	
	HP ML350 Gen9 Flexible Smart Array Controller Mini-SAS Cable Kit	765652-B21
	<b>NOTE:</b> Mini-SAS Cable Kit for Flexible Smart Array Controller (AROC).	
	HP ML350 Gen9 Smart Array Cable Kit	765650-B21
	<b>NOTE:</b> Mini-SAS Cable Kit for stand-up P-series Smart Array Card.	
	HP ML350 Gen9 Host Bus Adapter Mini-SAS Cable Kit	765648-B21
<b>NOTE:</b> Mini-SAS Cable kit for Host Bus Adapter.		
HP ML350 Gen9 Mini SAS Cable FIO Kit	765654-B21	
<b>NOTE:</b> Required to support B140i embedded SATA controller		
<b>NOTE:</b> FIO indicates factory integrated option for CTO order only.		
HP ML350 Gen9 Graphic Card Support Kit	726565-B21	
<b>NOTE:</b> Required to support graphic accelerators except for K2200.		
HP ML350 Gen9 Tower to Rack Conversion Kit	726567-B21	
<b>NOTE:</b> For converting a tower model to a rack model. It is consist of a 5U rail kit, cable management arm (CMA) and rack enablement kit (rack ear, rack handle, SID blank etc)		
HP ML350 Gen9 System Insight Display Kit	726563-B21	
<b>NOTE:</b> For rack model only.		
HP Security Bezel Kit	660584-B21	
<b>NOTE:</b> For ML350 Rack model only.		
HP 12Gb SAS Expander Card for ML350 Gen9	769635-B21	
<b>NOTE:</b> The SAS Expander card supports 24 drives. The SAS Expander card must be used in conjunction with an HPE Smart Array P840 or P440 controller, or an H240 Host Bus Adapter. The SAS Expander card cannot be connected to H240ar or P440ar Flexible Smart Array Controller cards.		
<b>NOTE:</b> The SAS Expander kit includes two cables to connect from the Smart Array controller or HBA to the SAS Expander and the other to connect from the Expander to the HDD backplane.		
<b>NOTE:</b> It DOES NOT support tape storage/ Disk-Based Backup device (RDX).		
HPE ML350 Gen9 2nd Expander FIO Kit	769637-B21	

## Core Options

**NOTE:** 2nd Expander FIO Kit (769637-B21) is for factory integrated only and support for 25-48 HDDs, CANNOT be selected when the 1st Expander Kit (769635-B21) is not in order.

**NOTE:** When 769637-B21 (2nd Expander FIO Kit) is selected, then 2nd CPU (-B21 processor) and (725870-B21) X4 RPS Enablement FIO Kit and P840 controller must be ordered.

**NOTE:** Can't support tape storage/ Disk-Based Backup device (RDX).

HP ML350 Gen9 X4 RPS Enablement Kit

802988-B21

**NOTE:** ML350 Gen9 supports max. four Power Supply slots. If Power supply selection qty is more than two, then X4 RPS Enablement Kit must be selected - to support the 3rd and 4th Power Supply Units. Minimum Power Supply qty. selection to configure with X4 RPS Enablement Kit is three.

**NOTE:** And this option is not supported with 720478-B21 (HPE 500W FS Plat Ht Plg Pwr Supply Kit).

**NOTE:** If hard drive cage selection qty. is more than three, this X4 RPS Enablement Kit must be selected - to get proper qty. of HDD backplane power connectors.

**NOTE:** If DW GPU card selection qty. is more than two, this X4 RPS Enablement Kit MUST be selected - in order to get proper qty. of GPU external power connectors.

HP ML350 Gen9 NVMe 6 Solid State Drive Express Bay Enablement Kit

726551-B21

**NOTE:** Support for SFF chassis SKU only. Maximum installation of NVMe express bay in ML350 Gen9 is one - installation limited to Box 1 or Box 4 for optimized cooling, which supports up to 6 SFF NVMe PCIe SSDs.

**NOTE:** One express bay bridge card is included in the enablement kit, with installation limited to PCIe slot 3, 6 or 8. If slot 6 or 8 is selected, a 2nd processor must be installed.

**NOTE:** For NVMe PCIe SSD selection, refer to drive section in this document.

## HPE Processors

## E5-2600v4 series Processors

HPE ML350 Gen9 Intel® Xeon® E5-2609v4 (1.7GHz/8-core/20MB/85W) Processor Kit	801233-B21
HPE ML350 Gen9 Intel® Xeon® E5-2609v4 (1.7GHz/8-core/20MB/85W) FIO Processor Kit	801233-L21
HPE ML350 Gen9 Intel® Xeon® E5-2603v4 (1.7GHz/6-core/15MB/85W) Processor Kit	801234-B21
HPE ML350 Gen9 Intel® Xeon® E5-2603v4 (1.7GHz/6-core/15MB/85W) FIO Processor Kit	801234-L21
HPE ML350 Gen9 Intel® Xeon® E5-2650Lv4 (1.7GHz/14-core/35MB/65W) Processor Kit	801250-B21
HPE ML350 Gen9 Intel® Xeon® E5-2650Lv4 (1.7GHz/14-core/35MB/65W) FIO Processor Kit	801250-L21
HPE ML350 Gen9 Intel® Xeon® E5-2630Lv4 (1.8GHz/10-core/25MB/55W) Processor Kit	801251-B21
HPE ML350 Gen9 Intel® Xeon® E5-2630Lv4 (1.8GHz/10-core/25MB/55W) FIO Processor Kit	801251-L21
HPE ML350 Gen9 Intel® Xeon® E5-2620v4 (2.1GHz/8-core/20MB/85W) Processor Kit	801232-B21
HPE ML350 Gen9 Intel® Xeon® E5-2620v4 (2.1GHz/8-core/20MB/85W) FIO Processor Kit	801232-L21

## Core Options

HPE ML350 Gen9 Intel® Xeon® E5-2643v4 (3.4GHz/6-core/20MB/135W) Processor Kit	801255-B21
HPE ML350 Gen9 Intel® Xeon® E5-2643v4 (3.4GHz/6-core/20MB/135W) FIO Processor Kit	801255-L21
HPE ML350 Gen9 Intel® Xeon® E5-2637v4 (3.5GHz/4-core/15MB/135W) Processor Kit	801256-B21
HPE ML350 Gen9 Intel® Xeon® E5-2637v4 (3.5GHz/4-core/15MB/135W) FIO Processor Kit	801256-L21
HPE ML350 Gen9 Intel® Xeon® E5-2623v4 (2.6GHz/4-core/10MB/85W) Processor Kit	801258-B21
HPE ML350 Gen9 Intel® Xeon® E5-2623v4 (2.6GHz/4-core/10MB/85W) FIO Processor Kit	801258-L21
HPE ML350 Gen9 Intel® Xeon® E5-2690v4 (2.6GHz/14-core/35MB/135W) Processor Kit	801225-B21
HPE ML350 Gen9 Intel® Xeon® E5-2690v4 (2.6GHz/14-core/35MB/135W) FIO Processor Kit	801225-L21
HPE ML350 Gen9 Intel® Xeon® E5-2680v4 (2.4GHz/14-core/35MB/120W) Processor Kit	801226-B21
HPE ML350 Gen9 Intel® Xeon® E5-2680v4 (2.4GHz/14-core/35MB/120W) FIO Processor Kit	801226-L21
HPE ML350 Gen9 Intel® Xeon® E5-2660v4 (2.0GHz/14-core/35MB/105W) Processor Kit	801228-B21
HPE ML350 Gen9 Intel® Xeon® E5-2660v4 (2.0GHz/14-core/35MB/105W) FIO Processor Kit	801228-L21
HPE ML350 Gen9 Intel® Xeon® E5-2650v4 (2.2GHz/12-core/30MB/105W) Processor Kit	801229-B21
HPE ML350 Gen9 Intel® Xeon® E5-2650v4 (2.2GHz/12-core/30MB/105W) FIO Processor Kit	801229-L21
HPE ML350 Gen9 Intel® Xeon® E5-2640v4 (2.4GHz/10-core/25MB/90W) Processor Kit	801230-B21
HPE ML350 Gen9 Intel® Xeon® E5-2640v4 (2.4GHz/10-core/25MB/90W) FIO Processor Kit	801230-L21
HPE ML350 Gen9 Intel® Xeon® E5-2697v4 (2.3GHz/18-core/45MB/145W) Processor Kit	801252-B21
HPE ML350 Gen9 Intel® Xeon® E5-2697v4 (2.3GHz/18-core/45MB/145W) FIO Processor Kit	801252-L21
HPE ML350 Gen9 Intel® Xeon® E5-2695v4 (2.1GHz/18-core/45MB/120W) Processor Kit	801253-B21
HPE ML350 Gen9 Intel® Xeon® E5-2695v4 (2.1GHz/18-core/45MB/120W) FIO Processor Kit	801253-L21
HPE ML350 Gen9 Intel® Xeon® E5-2667v4 (3.2GHz/8-core/25MB/135W) Processor Kit	801254-B21
HPE ML350 Gen9 Intel® Xeon® E5-2667v4 (3.2GHz/8-core/25MB/135W) FIO Processor Kit	801254-L21
HPE ML350 Gen9 Intel® Xeon® E5-2683v4 (2.1GHz/16-core/40MB/120W) Processor Kit	801257-B21
HPE ML350 Gen9 Intel® Xeon® E5-2683v4 (2.1GHz/16-core/40MB/120W) FIO Processor Kit	801257-L21
HPE ML350 Gen9 Intel® Xeon® E5-2699v4 (2.2GHz/22-core/55MB/145W) Processor Kit	801259-B21



## Core Options

HPE ML350 Gen9 Intel® Xeon® E5-2699v4 (2.2GHz/22-core/55MB/145W) FIO Processor Kit	801259-L21
HPE ML350 Gen9 Intel® Xeon® E5-2698v4 (2.2GHz/20-core/50MB/135W) Processor Kit	801271-B21
HPE ML350 Gen9 Intel® Xeon® E5-2698v4 (2.2GHz/20-core/50MB/135W) FIO Processor Kit	801271-L21
HPE ML350 Gen9 Intel® Xeon® E5-2697Av4 (2.6GHz/16-core/40MB/145W) Processor Kit	839989-B21
HPE ML350 Gen9 Intel® Xeon® E5-2697Av4 (2.6GHz/16-core/40MB/145W) FIO Processor Kit	839989-L21
HPE ML350 Gen9 Intel® Xeon® E5-2630v4 (2.2GHz/10-core/25MB/85W) Processor Kit	801231-B21
HPE ML350 Gen9 Intel® Xeon® E5-2630v4 (2.2GHz/10-core/25MB/85W) FIO Processor Kit	801231-L21
<b>E5-2600v3 series Processors</b>	
HP ML350 Gen9 Intel® Xeon® E5-2609v3 (1.9GHz/6-core/15MB/85W) Processor Kit	726661-B21
HP ML350 Gen9 Intel® Xeon® E5-2609v3 (1.9GHz/6-core/15MB/85W) FIO Processor Kit	726661-L21
HP ML350 Gen9 Intel® Xeon® E5-2603v3 (1.6GHz/6-core/15MB/85W) Processor Kit	726664-B21
HP ML350 Gen9 Intel® Xeon® E5-2603v3 (1.6GHz/6-core/15MB/85W) FIO Processor Kit	726664-L21
HP ML350 Gen9 Intel® Xeon® E5-2640v3 (2.6GHz/8-core/20MB/90W) Processor Kit	726651-B21
HP ML350 Gen9 Intel® Xeon® E5-2640v3 (2.6GHz/8-core/20MB/90W) FIO Processor Kit	726651-L21
HP ML350 Gen9 Intel® Xeon® E5-2630v3 (2.4GHz/8-core/20MB/85W) Processor Kit	726654-B21
HP ML350 Gen9 Intel® Xeon® E5-2630v3 (2.4GHz/8-core/20MB/85W) FIO Processor Kit	726654-L21
HP ML350 Gen9 Intel® Xeon® E5-2620v3 (2.4GHz/6-core/15MB/85W) Processor Kit	726658-B21
HP ML350 Gen9 Intel® Xeon® E5-2620v3 (2.4GHz/6-core/15MB/85W) FIO Processor Kit	726658-L21
HP ML350 Gen9 Intel® Xeon® E5-2630Lv3 (1.8GHz/8-core/20MB/55W) Processor Kit	726671-B21
HP ML350 Gen9 Intel® Xeon® E5-2630Lv3 (1.8GHz/8-core/20MB/55W) FIO Processor Kit	726671-L21
HP ML350 Gen9 Intel® Xeon® E5-2623v3 (3GHz/4-core/10MB/105W) Processor Kit	779834-B21
HP ML350 Gen9 Intel® Xeon® E5-2623v3 (3GHz/4-core/10MB/105W) FIO Processor Kit	779834-L21
HP ML350 Gen9 Intel® Xeon® E5-2637v3 (3.5GHz/4-core/15MB/135W) Processor Kit	726686-B21
HP ML350 Gen9 Intel® Xeon® E5-2637v3 (3.5GHz/4-core/15MB/135W) FIO Processor Kit	726686-L21
HP ML350 Gen9 Intel® Xeon® E5-2690v3 (2.6GHz/12-core/30MB/135W) Processor Kit	726636-B21

## Core Options

HP ML350 Gen9 Intel® Xeon® E5-2690v3 (2.6GHz/12-core/30MB/135W) FIO Processor Kit	726636-L21
HP ML350 Gen9 Intel® Xeon® E5-2680v3 (2.5GHz/12-core/30MB/120W) Processor Kit	726639-B21
HP ML350 Gen9 Intel® Xeon® E5-2680v3 (2.5GHz/12-core/30MB/120W) FIO Processor Kit	726639-L21
HP ML350 Gen9 Intel® Xeon® E5-2670v3 (2.3GHz/12-core/30MB/120W) Processor Kit	726642-B21
HP ML350 Gen9 Intel® Xeon® E5-2670v3 (2.3GHz/12-core/30MB/120W) FIO Processor Kit	726642-L21
HP ML350 Gen9 Intel® Xeon® E5-2660v3 (2.6GHz/10-core/25MB/105W) Processor Kit	726645-B21
HP ML350 Gen9 Intel® Xeon® E5-2660v3 (2.6GHz/10-core/25MB/105W) FIO Processor Kit	726645-L21
HP ML350 Gen9 Intel® Xeon® E5-2650v3 (2.3GHz/10-core/25MB/105W) Processor Kit	726648-B21
HP ML350 Gen9 Intel® Xeon® E5-2650v3 (2.3GHz/10-core/25MB/105W) FIO Processor Kit	726648-L21
HP ML350 Gen9 Intel® Xeon® E5-2650Lv3 (1.8GHz/12-core/30MB/65W) Processor Kit	726668-B21
HP ML350 Gen9 Intel® Xeon® E5-2650Lv3 (1.8GHz/12-core/30MB/65W) FIO Processor Kit	726668-L21
HP ML350 Gen9 Intel® Xeon® E5-2697v3 (2.6GHz/14-core/35MB/145W) Processor Kit	726674-B21
HP ML350 Gen9 Intel® Xeon® E5-2697v3 (2.6GHz/14-core/35MB/145W) FIO Processor Kit	726674-L21
HP ML350 Gen9 Intel® Xeon® E5-2695v3 (2.3GHz/14-core/35MB/120W) Processor Kit	726677-B21
HP ML350 Gen9 Intel® Xeon® E5-2695v3 (2.3GHz/14-core/35MB/120W) FIO Processor Kit	726677-L21
HP ML350 Gen9 Intel® Xeon® E5-2667v3 (3.2GHz/8-core/20MB/135W) Processor Kit	726680-B21
HP ML350 Gen9 Intel® Xeon® E5-2667v3 (3.2GHz/8-core/20MB/135W) FIO Processor Kit	726680-L21
HP ML350 Gen9 Intel® Xeon® E5-2643v3 (3.4GHz/6-core/20MB/135W) Processor Kit	726683-B21
HP ML350 Gen9 Intel® Xeon® E5-2643v3 (3.4GHz/6-core/20MB/135W) FIO Processor Kit	726683-L21
HP ML350 Gen9 Intel® Xeon® E5-2683v3 (2GHz/14-core/35MB/120W) Processor Kit	765794-B21
HP ML350 Gen9 Intel® Xeon® E5-2683v3 (2GHz/14-core/35MB/120W) FIO Processor Kit	765794-L21
HP ML350 Gen9 Intel® Xeon® E5-2699v3 (2.3GHz/18-core/45MB/145W) Processor Kit	781828-B21
HP ML350 Gen9 Intel® Xeon® E5-2699v3 (2.3GHz/18-core/45MB/145W) FIO Processor Kit	781828-L21
HP ML350 Gen9 Intel® Xeon® E5-2698v3 (2.3GHz/16-core/40MB/135W) Processor Kit	781830-B21
HP ML350 Gen9 Intel® Xeon® E5-2698v3 (2.3GHz/16-core/40MB/135W) FIO Processor Kit	781830-L21

## Core Options

### HPE Memory

#### Registered DIMMs (RDIMMs) for E5-2600v3 Series

HP 4GB (1x4GB) Single Rank x8 DDR4-2133 CAS-15-15-15 Registered Memory Kit	726717-B21
HP 8GB (1x8GB) Single Rank x4 DDR4-2133 CAS-15-15-15 Registered Memory Kit	726718-B21
HP 8GB (1x8GB) Dual Rank x8 DDR4-2133 CAS-15-15-15 Registered Memory Kit	759934-B21
HP 16GB (1x16GB) Dual Rank x4 DDR4-2133 CAS-15-15-15 Registered Memory Kit	726719-B21
HP 32GB (1x32GB) Dual Rank x4 DDR4-2133 CAS-15-15-15 Registered Memory Kit	728629-B21

**NOTE:** Depending on Processor selected this memory will run at 1600, 1866 or 2133MHz.

**NOTE:** Mixing of DIMM types is not supported.

**NOTE:** Mixing of 2133 and 2400MHz DIMMs is not supported.

#### Load Reduced DIMMs (LRDIMMs) for E5-2600v3 Series

HP 16GB (1x16GB) Dual Rank x4 DDR4-2133 CAS-15-15-15 Load Reduced Memory Kit	726720-B21
HP 32GB (1x32GB) Quad Rank x4 DDR4-2133 CAS-15-15-15 Load Reduced Memory Kit	726722-B21
HP 64GB (1x64GB) Quad Rank x4 DDR4-2133 CAS-15-15-15 Load Reduced Memory Kit	726724-B21

**NOTE:** Depending on Processor selected this memory will run at 1600, 1866 or 2133MHz.

**NOTE:** Mixing of DIMM types is not supported.

**NOTE:** Mixing of 2133 and 2400MHz DIMMs is not supported.

#### Registered DIMMs (RDIMMs) for E5-2600v4 Series

**NOTE:** The following memory is supported by the E5-2600v4 series Processor only.

HP 8GB (1x8GB) Single Rank x8 DDR4-2400 CAS-17-17-17 Registered Memory Kit	805347-B21
HP 16GB (1x16GB) Single Rank x4 DDR4-2400 CAS-17-17-17 Registered Memory Kit	805349-B21
HP 32GB (1x32GB) Dual Rank x4 DDR4-2400 CAS-17-17-17 Registered Memory Kit	805351-B21
HPE 16GB (1x16GB) Dual Rank x4 DDR4-2400 CAS-17-17-17 Registered Memory Kit	836220-B21

**NOTE:** Depending on Processor selected this memory will run at 1866, 2133 or 2400MHz.

**NOTE:** Mixing of DIMM types is not supported.

**NOTE:** Mixing of 2133 and 2400MHz DIMMs is not supported.

#### Load Reduced DIMMs (LRDIMMs) for E5-2600v4 Series

**NOTE:** The following memory is supported by the E5-2600v4 series Processor only.

HPE 32GB (1x32GB) Dual Rank x4 DDR4-2400 CAS-17-17-17 Load Reduced Memory Kit	805353-B21
HPE 64GB (1x64GB) Quad Rank x4 DDR4-2400 CAS-17-17-17 Load Reduced Memory Kit	805358-B21
HPE 128GB (1x128GB) Octal Rank x4 DDR4-2400 CAS-20-18-18 Load Reduced Memory Kit	809208-B21

**NOTE:** Depending on Processor selected this memory will run at 1866, 2133 or 2400MHz.

**NOTE:** Mixing of DIMM types is not supported.

**NOTE:** Mixing of 2133 and 2400MHz DIMMs is not supported.

## Core Options

<b>HPE Optical Drives</b>	HP 9.5mm SATA DVD-ROM JackBlack Gen9 Optical Drive	726536-B21
	HP 9.5mm SATA DVD-RW JackBlack G9 Optical Drive	726537-B21

### HPE Drives

**NOTE:** For a complete list of the drive, controller and cable options please check the compatibility matrix:

<https://www.hpe.com/h20195/V2/GetDocument.aspx?docname=4AA5-4154ENW&cc=us&lc=en>

#### SAS Hot Plug LFF (3.5-inch) Enterprise (ENT) Drives

HP 450GB 12G SAS 15K rpm LFF (3.5-inch) SC Converter Enterprise 3yr Warranty Hard Drive	737394-B21
HP 300GB 12G SAS 15K rpm LFF (3.5-inch) SC Converter Enterprise 3yr Warranty Hard Drive	737261-B21
HP 600GB 12G SAS 15K rpm LFF (3.5-inch) SC Converter Enterprise 3yr Warranty Hard Drive	765424-B21
HP 6TB 12G SAS 7.2K rpm LFF (3.5-inch) SC 512e Helium 1yr Warranty Hard Drive	793699-B21
HP 8TB 12G SAS 7.2K rpm LFF (3.5-inch) SC 512e Helium 1yr Warranty Hard Drive	793703-B21

#### SAS Hot Plug LFF (3.5-inch) Midline (MDL) Drives

HP 6TB 6G SAS 7.2K rpm LFF (3.5-inch) SC Midline 1yr Warranty Hard Drive	761477-B21
HP 3TB 6G SAS 7.2K rpm LFF (3.5-inch) SC Midline 1yr Warranty Hard Drive	652766-B21
HP 1TB 6G SAS 7.2K rpm LFF (3.5-inch) SC Midline 1yr Warranty Hard Drive	652753-B21
HP 4TB 12G SAS 7.2K rpm LFF (3.5-inch) SC Midline 512e 1yr Warranty Hard Drive	765257-B21
HP 6TB 12G SAS 7.2K rpm LFF (3.5-inch) SC Midline 512e 1yr Warranty Hard Drive	765259-B21
HP 4TB 12G SAS 7.2K rpm LFF (3.5-inch) SC 512e Performance 1yr Warranty Hard Drive	793669-B21
HP 6TB 12G SAS 7.2K rpm LFF (3.5-inch) SC 512e Performance 1yr Warranty Hard Drive	793671-B21
HPE 2TB 12G SAS 7.2K rpm LFF (3.5-inch) SC Midline 1yr Warranty Hard Drive	818365-B21
HPE 4TB 12G SAS 7.2K rpm LFF (3.5-inch) SC Midline 1yr Warranty Hard Drive	818367-B21
HPE 8TB 12G SAS 7.2K rpm LFF (3.5in) 512e SC Midline 1yr Warranty Hard Drive	819201-B21
HPE 1TB 12G SAS 7.2K rpm LFF (3.5in) SC Midline 1yr Warranty Hard Drive	846524-B21
HPE 3TB 12G SAS 7.2K rpm LFF (3.5in) SC Midline 1yr Warranty Hard Drive	846528-B21
HPE 6TB 12G SAS 7.2K rpm LFF (3.5in) SC Midline 1yr Warranty Hard Drive	846514-B21
HPE 10TB 12G SAS 7.2K rpm LFF (3.5in) 512e SC Midline 1yr Warranty Hard Drive	857644-B21
HPE 8TB 12G SAS 7.2K rpm LFF (3.5in) 512e SC Midline 1yr Warranty Hard Drive	861590-B21

#### SATA Hot Plug LFF (3.5-inch) Midline (MDL) Drives

HP 4TB 6G SATA 7.2k rpm LFF (3.5-inch) SC Midline 1yr Warranty Hard Drive	693687-B21
HP 3TB 6G SATA 7.2K rpm LFF (3.5-inch) SC Midline 1yr Warranty Hard Drive	628061-B21
HP 2TB 6G SATA 7.2K rpm LFF (3.5-inch) SC Midline 1yr Warranty Hard Drive	658079-B21
HP 1TB 6G SATA 7.2K rpm LFF (3.5-inch) SC Midline 1yr Warranty Hard Drive	657750-B21
HP 500GB 6G SATA 7.2K rpm LFF (3.5-inch) SC Midline 1yr Warranty Hard Drive	658071-B21
HP 4TB 6G SATA 7.2K rpm LFF (3.5-inch) SC Midline 512e 1yr Warranty Hard Drive	765253-B21

## Core Options

HP 6TB 6G SATA 7.2K rpm LFF (3.5-inch) SC Midline 512e 1yr Warranty Hard Drive	765255-B21
HPE 8TB 6G SATA 7.2K rpm LFF (3.5in) 512e SC Midline 1yr Warranty Hard Drive	819203-B21
HP 4TB 6G SATA 7.2K rpm LFF (3.5-inch) SC 512e Performance 1yr Warranty Hard Drives	793665-B21
HP 6TB 6G SATA 7.2K rpm LFF (3.5-inch) SC 512e Performance 1yr Warranty Hard Drive	793667-B21
HP 6TB 6G SATA 7.2K rpm LFF (3.5-inch) SC 512e Helium 1yr Warranty Hard Drive	793683-B21
HPE 2TB 6G SATA 7.2K rpm LFF (3.5in) SC Midline 1yr Warranty Hard Drive	861676-B21
HPE 4TB 6G SATA 7.2K rpm LFF (3.5in) SC Midline 1yr Warranty Hard Drive	861678-B21
HPE 1TB 6G SATA 7.2K rpm LFF (3.5in) SC Midline 1yr Warranty Hard Drive	861691-B21
HPE 3TB 6G SATA 7.2K rpm LFF (3.5in) SC Midline 1yr Warranty Hard Drive	861693-B21
HPE 10TB 6G SATA 7.2K rpm LFF (3.5in) 512e SC Midline 1yr Warranty Hard Drive	857648-B21
HPE 8TB 6G SATA 7.2K rpm LFF (3.5in) 512e SC Midline 1yr Warranty Hard Drive	861594-B21
HPE 6TB 6G SATA 7.2K rpm LFF (3.5in) SC Midline 1yr Warranty Hard Drive	846510-B21
<b>6G SATA Hot Plug LFF (3.5-inch) Enterprise Mainstream Solid State Drives</b>	
HP 240GB 6G SATA Read Intensive-2 LFF 3.5-in SCC 3yr Wty Solid State Drive	804590-B21
HPE 480GB SATA 6G Mixed Use LFF (3.5in) SCC 3yr Wty Digitally Signed Firmware SSD	872346-B21
HPE 960GB SATA 6G Mixed Use LFF (3.5in) SCC 3yr Wty Digitally Signed Firmware SSD	872350-B21
HP 200GB 6G SATA Mixed Use-2 LFF 3.5-in SCC 3yr Wty Solid State Drive	804616-B21
HP 800GB 6G SATA Mixed Use-2 LFF 3.5-in SCC 3yr Wty Solid State Drive	804628-B21
HP 1.6TB 6G SATA Mixed Use-2 LFF 3.5-in SCC 3yr Wty Solid State Drive	804634-B21
HP 480GB 6G SATA Mixed Use-2 LFF 3.5-in SCC 3yr Wty Solid State Drive	832417-B21
HP 200GB 6G SATA Write Intensive-2 LFF 3.5-in SCC 3yr Wty Solid State Drive	804642-B21
HP 400GB 6G SATA Write Intensive-2 LFF 3.5-in SCC 3yr Wty Solid State Drive	804668-B21
HP 1.2TB 6G SATA Write Intensive-2 LFF 3.5-in SCC 3yr Wty Solid State Drive	804680-B21
HP 800GB 6G SATA Read Intensive-2 LFF 3.5-in SCC 3yr Wty Solid State Drive	804602-B21
HP 1.6TB 6G SATA Read Intensive-2 LFF 3.5-in SCC 3yr Wty Solid State Drive	804608-B21
HP 800GB 6G SATA Write Intensive-2 LFF 3.5-in SCC 3yr Wty Solid State Drive	804674-B21
<b>6G SATA Hot Plug LFF (3.5-inch) RI-3 SCC SSD</b>	
HP 3.84TB 6G SATA Read Intensive-3 LFF 3.5-in SC Converter 3yr Wty Solid State Drive	816933-B21
<b>6G SATA Hot Plug LFF (3.5-inch) SC Read Intensive Solid State Drives</b>	
HP 80GB 6G SATA Read Intensive-2 LFF 3.5-in SCC 3yr Wty Solid State Drive	804578-B21
HP 120GB 6G SATA Read Intensive-2 LFF 3.5-in SCC 3yr Wty Solid State Drive	804584-B21
HP 480GB 6G SATA Read Intensive-2 LFF 3.5-in SCC 3yr Wty Solid State Drive	804596-B21
HPE 480GB SATA 6G Read Intensive LFF (3.5in) SCC 3yr Wty Digitally Signed Firmware SSD	869380-B21
HPE 1.6TB SATA 6G Read Intensive LFF (3.5in) SCC 3yr Wty Digitally Signed Firmware SSD	869388-B21
<b>6G SATA Hot Plug LFF (3.5-inch) MU-3 SCC SSD</b>	

## Core Options

HP 480GB 6G SATA Mixed Use-3 LFF 3.5-in SC Converter 3yr Wty Solid State Drive	816989-B21
HP 960GB 6G SATA Mixed Use-3 LFF 3.5-in SC Converter 3yr Wty Solid State Drive	816999-B21
<b>SAS Hot Plug SFF (2.5-inch) Enterprise (ENT) Drives</b>	
HP 1.2TB 6G SAS 10K rpm SFF (2.5-inch) SC Dual Port Enterprise 3yr Warranty Hard Drive	718162-B21
HPE 1.2TB SAS 12G Enterprise 10K SFF (2.5in) SC 3yr Wty Digitally Signed Firmware HDD	872479-B21
HPE 900GB SAS 12G Enterprise 15K SFF (2.5in) SC 3yr Wty DS Digitally Signed Firmware HDD	870759-B21
HP 900GB 6G SAS 10K rpm SFF (2.5-inch) SC Enterprise 3yr Warranty Hard Drive	652589-B21
HPE 600GB SAS 12G Enterprise 15K SFF (2.5in) SC 3yr Wty Digitally Signed Firmware HDD	870757-B21
HPE 600GB SAS 12G Enterprise 10K SFF (2.5in) SC 3yr Wty Digitally Signed Firmware HDD	872477-B21
HP 600GB 12G SAS 15K rpm SFF (2.5-inch) SC Enterprise 3yr Warranty Hard Drive	759212-B21
HP 600GB 6G SAS 10K rpm SFF (2.5-inch) SC Enterprise 3yr Warranty Hard Drive	652583-B21
HP 450GB 12G SAS 15K rpm SFF (2.5-inch) SC Enterprise 3yr Warranty Hard Drive	759210-B21
HP 450GB 6G SAS 10K rpm SFF (2.5-inch) SC Enterprise 3yr Warranty Hard Drive	652572-B21
HPE 300GB SAS 12G Enterprise 15K SFF (2.5in) SC 3yr Wty Digitally Signed Firmware HDD	870753-B21
HPE 300GB SAS 12G Enterprise 10K SFF (2.5in) SC 3yr Wty Digitally Signed Firmware HDD	872475-B21
HP 300GB 12G SAS 15K rpm SFF (2.5-inch) SC Enterprise 3yr Warranty Hard Drive	759208-B21
HP 300GB 6G SAS 10K rpm SFF (2.5-inch) SC Enterprise 3yr Warranty Hard Drive	652564-B21
HP 146GB 6G SAS 15K rpm SFF (2.5-inch) SC Enterprise 3yr Warranty Hard Drive	652605-B21
HP 600GB 12G SAS 10K rpm SFF (2.5-inch) SC Enterprise 3yr Warranty Hard Drive	781516-B21
HP 1.2TB 12G SAS 10K rpm SFF (2.5-inch) SC Enterprise 3yr Warranty Hard Drive	781518-B21
HP 300GB 12G SAS 10K rpm SFF (2.5-inch) SC Enterprise 3yr Warranty Hard Drive	785067-B21
HP 900GB 12G SAS 10K rpm SFF (2.5-inch) SC Enterprise 3yr Warranty Hard Drive	785069-B21
HPE 900GB SAS 12G Enterprise 15K SFF (2.5in) SC 3yr Wty 512e Digitally Signed Firmware HDD	870765-B21
HPE 600GB SAS 12G Enterprise 15K SFF (2.5in) SC 3yr Wty 512e Digitally Signed Firmware HDD	870763-B21
HP 600GB 12G SAS 15K rpm SFF (2.5-inch) SC 512e Enterprise 3yr Warranty Hard Drive	748387-B21
HPE 1.8TB SAS 12G Enterprise 10K SFF (2.5in) SC 3yr Wty 512e Digitally Signed Firmware HDD	872481-B21

## Core Options

HP 1.8TB 12G SAS 10K rpm SFF (2.5-inch) SC Enterprise 512e 3yr Warranty Hard Drive	791034-B21
<b>SAS Hot Plug SFF (2.5-inch) Midline (MDL) Drives</b>	
HP 1TB 6G SAS 7.2K rpm SFF (2.5-inch) SC Midline 1yr Warranty Hard Drive	652749-B21
HP 1TB 12G SAS 7.2K rpm SFF (2.5-inch) SC 512e 1yr Warranty Hard Drive	765464-B21
HP 2TB 12G SAS 7.2K rpm SFF (2.5-inch) SC 512e 1yr Warranty Hard Drive	765466-B21
HPE 1TB 12G SAS 7.2K rpm SFF (2.5in) SC Midline 1yr Warranty Hard Drive	832514-B21
<b>SATA Hot Plug SFF (2.5-inch) Midline (MDL) Drives</b>	
HP 1TB 6G SATA 7.2K rpm SFF (2.5-inch) SC Midline 1yr Warranty Hard Drive	655710-B21
HP 1TB 6G SATA 7.2K rpm SFF (2.5-inch) SC 512e 1yr Warranty Hard Drive	765453-B21
HP 2TB 6G SATA 7.2K rpm SFF (2.5-inch) SC 512e 1yr Warranty Hard Drive	765455-B21
<b>12G SAS Mainstream Endurance Hot Plug SFF (2.5-inch) Enterprise Mainstream H2 Solid State Drives</b>	
HP 1.6TB 12G SAS Mainstream Endurance SFF 2.5-in ENT Mainstream SC 3yr Wty H2 Solid State Drive	779176-B21
HP 800GB 12G SAS Mainstream Endurance SFF 2.5-in ENT Mainstream SC 3yr Wty H2 Solid State Drive	779172-B21
HP 400GB 12G SAS Mainstream Endurance SFF 2.5-in ENT Mainstream SC 3yr Wty H2 Solid State Drive	779168-B21
HP 200GB 12G SAS Mainstream Endurance SFF 2.5-in ENT Mainstream SC 3yr Wty H2 Solid State Drive	779164-B21
<b>12G SAS Hot Plug SFF (2.5-inch) Enterprise Value Solid State Drives</b>	
HP 1.6TB 12G SAS Value Endurance SFF 2.5-in SC Enterprise Value 3yr Wty Solid State Drive	762263-B21
HP 200GB 12G SAS Write Intensive SFF 2.5-in SC 3yr Wty Solid State Drive	802578-B21
HP 400GB 12G SAS Write Intensive SFF 2.5-in SC 3yr Wty Solid State Drive	802582-B21
HP 800GB 12G SAS Write Intensive SFF 2.5-in SC 3yr Wty Solid State Drive	802586-B21
HP 1.92TB 12G SAS Read Intensive SFF 2.5-in SC 3yr Wty Solid State Drive	802891-B21
<b>12G SAS Mixed Use Hot Plug SFF (2.5-inch) Solid State Drives</b>	
HPE 3.2TB 12G SAS Mixed Use-3 SFF 2.5-in SC 3yr Wty Solid State Drive	822567-B21
HPE 800GB 12G SAS Mixed Use-1 SFF (2.5in) SC 3yr Wty Solid State Drive	846434-B21
HPE 1.6TB 12G SAS Mixed Use-1 SFF (2.5in) SC 3yr Wty Solid State Drive	846436-B21
<b>12G SAS Read Intensive Hot Plug SFF (2.5-inch) Solid State Drives</b>	
HPE 3.84TB 12G SAS Read Intensive-3 SFF 2.5-in SC 3yr Wty Solid State Drive	816576-B21
<b>12G SAS Write Intensive Hot Plug SFF (2.5-inch) Solid State Drives</b>	
HPE 800GB 12G SAS Write Intensive-1 SFF (2.5in) SC 3yr Wty Solid State Drive	846430-B21
HPE 1.6TB 12G SAS Write Intensive-1 SFF (2.5in) SC 3yr Wty Solid State Drive	846432-B21
<b>6G SATA Hot Plug SFF Value Endurance (2.5-inch) Enterprise Value M1 Solid State Drives</b>	
HP 800GB 6G SATA Value Endurance SFF 2.5-in SC Enterprise Value 3yr Wty M1 Solid State Drive	764929-B21
HP 480GB 6G SATA Value Endurance SFF 2.5-in SC Enterprise Value 3yr Wty M1 Solid State Drive	764927-B21
HP 240GB 6G SATA Value Endurance SFF 2.5-in SC Enterprise Value 3yr Wty M1 Solid State Drive	764925-B21
HP 120GB 6G SATA Value Endurance SFF 2.5-in SC Enterprise Value 3yr Wty M1 Solid State Drive	764923-B21
<b>6G SATA Hot Plug RI-3 SFF (2.5-inch) SC Solid State Drives</b>	

## Core Options

HP 3.84TB 6G SATA Read Intensive-3 SFF 2.5-in SC 3yr Wty Solid State Drive	816929-B21
HPE 400GB SATA 6G WI SFF SC DS SSD	872355-B21
HPE 800GB SATA 6G WI SFF SC DS SSD	872359-B21
HPE 1.6TB SATA 6G WI SFF SC DS SSD	872363-B21
<b>6G SATA Hot Plug MU-3 SFF (2.5-inch) SC Solid State Drives</b>	
HP 480GB 6G SATA Mixed Use-3 SFF 2.5-in SC 3yr Wty Solid State Drive	816985-B21
HP 960GB 6G SATA Mixed Use-3 SFF 2.5-in SC 3yr Wty Solid State Drive	816995-B21
HP 1.92TB 6G SATA Mixed Use-3 SFF 2.5-in SC 3yr Wty Solid State Drive	817011-B21
<b>6G SATA Hot Plug SFF (2.5-inch) Enterprise Boot Solid State Drives</b>	
HP 80GB 6G SATA Read Intensive-2 SFF 2.5-in SC 3yr Wty Solid State Drive	804575-B21
HP 120GB 6G SATA Read Intensive-2 SFF 2.5-in SC 3yr Wty Solid State Drive	804581-B21
HP 240GB 6G SATA Read Intensive-2 SFF 2.5-in SC 3yr Wty Solid State Drive	804587-B21
HP 480GB 6G SATA Read Intensive-2 SFF 2.5-in SC 3yr Wty Solid State Drive	804593-B21
HP 800GB 6G SATA Read Intensive-2 SFF 2.5-in SC 3yr Wty Solid State Drive	804599-B21
HP 1.6TB 6G SATA Read Intensive-2 SFF 2.5-in SC 3yr Wty Solid State Drive	804605-B21
HP 200GB 6G SATA Mixed Use-2 SFF 2.5-in SC 3yr Wty Solid State Drive	804613-B21
HP 800GB 6G SATA Mixed Use-2 SFF 2.5-in SC 3yr Wty Solid State Drive	804625-B21
HPE 1.92TB SATA 6G Mixed Use SFF (2.5in) SC 3yr Wty Digitally Signed Firmware SSD	872352-B21
HP 1.6TB 6G SATA Mixed Use-2 SFF 2.5-in SC 3yr Wty Solid State Drive	804631-B21
HPE 960GB SATA 6G Mixed Use SFF (2.5in) SC 3yr Wty Digitally Signed Firmware SSD	872348-B21
HPE 480GB SATA 6G Mixed Use SFF (2.5in) SC 3yr Wty Digitally Signed Firmware SSD	872344-B21
HP 480GB 6G SATA Mixed Use-2 SFF 2.5-in SC 3yr Wty Solid State Drive	832414-B21
HP 200GB 6G SATA Write Intensive-2 SFF 2.5-in SC 3yr Wty Solid State Drive	804639-B21
HP 400GB 6G SATA Write Intensive-2 SFF 2.5-in SC 3yr Wty Solid State Drive	804665-B21
HP 800GB 6G SATA Write Intensive-2 SFF 2.5-in SC 3yr Wty Solid State Drive	804671-B21
HP 1.2TB 6G SATA Write Intensive-2 SFF 2.5-in SC 3yr Wty Solid State Drive	804677-B21
<b>6G SATA Hot Plug SFF (2.5-inch) SC Read Intensive Solid State Drives</b>	
HPE 1.92TB 6G SATA Read Intensive SFF (2.5in) SC 1yr Warranty Solid State Drive	871770-B21
HPE 1.6TB SATA 6G Read Intensive SFF (2.5in) SC 3yr Wty Digitally Signed Firmware SSD	869386-B21
HPE 960GB SATA 6G Read Intensive SFF (2.5in) SC 3yr Wty Digitally Signed Firmware SSD	869384-B21
HPE 960GB 6G SATA Read Intensive SFF (2.5in) SC 1yr Warranty Solid State Drive	871768-B21
HPE 480GB SATA 6G Read Intensive SFF (2.5in) SC 3yr Wty Digitally Signed Firmware SSD	869378-B21
HPE 240GB SATA 6G Read Intensive SFF (2.5in) SC 3yr Wty Digitally Signed Firmware SSD	869376-B21
HPE 150GB SATA 6G Read Intensive SFF (2.5in) SC 3yr Wty Digitally Signed Firmware SSD	869374-B21
<b>HPE NVMe PCIe Read Intensive SFF (2.5 inch) Solid State Drives</b>	
HP 400GB NVMe PCIe Read Intensive SFF 2.5-in SC2 3yr Wty Solid State Drive	764904-B21
HP 1.2TB NVMe PCIe Read Intensive SFF 2.5-in SC2 3yr Wty Solid State Drive	764906-B21

**NOTE:** ML350 Gen9 6SFF Express Bay Enablement Kit (726551-B21) is required to support these drives.



## Core Options

**NOTE:** HPE has qualified the NVMe drive portfolio using the Operating System inbox drivers, full detail on the [HPE Solid State Drive QuickSpecs](#).

### HPE NVMe PCIe Mixed Use SSDs

HP 400GB NVMe PCIe Mixed Use SFF 2.5-in SC2 3yr Wty Solid State Drive 765034-B21

HP 800GB NVMe PCIe Mixed Use SFF 2.5-in SC2 3yr Wty Solid State Drive 765036-B21

**NOTE:** ML350 Gen9 6SFF Express Bay Enablement Kit (726551-B21) is required to support these drives.

**NOTE:** HPE has qualified the NVMe drive portfolio using the Operating System inbox drivers, full detail on the [HPE Solid State Drive QuickSpecs](#).

### HPE NVMe PCIe Write Intensive SFF (2.5-inch) Solid State Drives

HP 400GB NVMe PCIe Write Intensive SFF 2.5-in SC2 3yr Wty Solid State Drive 736936-B21

HP 800GB NVMe PCIe Write Intensive SFF 2.5-in SC2 3yr Wty Solid State Drive 736939-B21

**NOTE:** ML350 Gen9 6SFF Express Bay Enablement Kit (726551-B21) is required to support these drives.

**NOTE:** HPE has qualified the NVMe drive portfolio using the Operating System inbox drivers, full detail on the [HPE Solid State Drive QuickSpecs](#).

### M.2 SSD

HP Dual 120GB Value Endurance Solid State M.2 Enablement Kit for ProLiant ML/DL Servers 777894-B21

**NOTE:** If this option is selected, then Optical drives CANNOT be selected.

HP 120GB Value Endurance Solid State M.2 Enablement Kit for ProLiant ML/DL Servers 788028-B21

HPE Dual 340GB Read Intensive-2 Solid State M.2 Enablement Kit for ProLiant ML/DL Servers 835565-B21

HPE 340GB Read Intensive-2 Solid State M.2 Enablement Kit for ProLiant ML/DL Servers 835563-B21

**NOTE:** M.2 SSD ML-DL Enablmt Kit can be used to build RAID 0, 1 by using B140i controller.

- When HPE 120GB or 340GB M.2 SSD ML-DL Dual Enablmt Kit is ordered, it can support RAID 0, 1.

- When HPE 120GB or 340GB M.2 SSD ML-DL Sngl Enablmt Kit is ordered, it can support RAID 0.

**NOTE:** M.2 SSD ML-DL Enablmt Kit CANNOT support RAID setting when AROC card (P440ar or H240ar) is selected. Embedded B140i controller CANNOT be used when AROC is ordered.

### Hard Drive Blank Kits

HP Large Form Factor Hard Drive Blank Kit 666986-B21

HP Small Form Factor Hard Drive Blank Kit 666987-B21

### Hard Drive Kits

HP ML350 Gen9 SFF Media Cage Kit 726545-B21

HP ML350 Gen9 8LFF Hot Plug Drive Cage Kit 726547-B21

HP ML350 Gen9 LFF Media Cage Kit 726561-B21

HP ML350 Gen9 8SFF Hard Drive Cage Kit 778157-B21

HP ML350 Gen9 NVMe 6 Solid State Drive Express Bay Enablement Kit 726551-B21

**NOTE:** The ML350 Gen9 6SFF Express Bay kit is consist of one x6 SFF NVMe drive cage assembly, one Express Bay Bridge card, etc.

## HPE Networking

### 1 Gigabit Ethernet adapters

HP Ethernet 1Gb 4-port 331T Adapter 647594-B21

HP Ethernet 1Gb 2-port 361T Adapter 652497-B21

HP Ethernet 1Gb 2-port 332T Adapter 615732-B21

HP Ethernet 1Gb 4-port 366T Adapter 811546-B21

### 10 Gigabit Ethernet adapters

## Core Options

HP Ethernet 10Gb 2-port 560SFP+ Adapter	665249-B21
HP Ethernet 10Gb 2-port 530T Adapter	656596-B21
HP Ethernet 10Gb 2-port 530SFP Adapter	652503-B21
HP Ethernet 10Gb 2-port 561T Adapter	716591-B21
HP Ethernet 10Gb 2-port 546SFP+ Adapter	779793-B21
HP Ethernet 10Gb 2-port 557SFP+ Adapter	788995-B21
HPE Ethernet 10Gb 2-port 562SFP+ Adapter	727055-B21

### 25 Gigabit Ethernet adapters

HPE Ethernet 10/25Gb 2-port 640SFP28 Adapter	817753-B21
HPE Ethernet 4x25Gb 1-port 620QSFP28 Adapter	817762-B21

**NOTE:** The ML350 Gen9 ships with 4x1Gb ports Embedded.

**NOTE:** Direct Attach Cable (DAC) for copper environments or fiber transceivers and cables for fiber-optic environments must be purchased separately. Please see the related NIC QuickSpecs for Technical Specifications and additional information: <http://www.hp.com/go/ProLiantNICs>

---

<b>HPE InfiniBand</b>	HP InfiniBand FDR 2-port 545QSFP Adapter	702211-B21
-----------------------	------------------------------------------	------------

---

### HPE Power Supplies

#### HPE Flex Slot Platinum Hot-plug Power supplies

HPE 500W Flex Slot Platinum Hot Plug Power Supply Kit	720478-B21
HPE 800W Flex Slot Platinum Hot Plug Power Supply Kit	720479-B21
HPE 1400W Flex Slot Platinum Plus Hot Plug Power Supply Kit	720620-B21
HPE 800W Flex Slot -48VDC Hot Plug Power Supply Kit	720480-B21
HPE 800W Flex Slot Titanium Hot Plug Power Supply Kit	720482-B21
HPE 800W Flex Slot Universal Hot Plug Power Supply Kit	720484-B21
HP ML350 Gen9 X4 RPS Enablement Kit	802988-B21

**NOTE:** If Power supply selection qty is more than two, then X4 RPS Enablement Kit must be selected (minimum Power Supply qty. selection to configure with X4 RPS Enablement Kit is three).

**NOTE:** And this option is not supported with 720478-B21 (HPE 500W FS Plat Ht Plg Pwr Supply Kit).

**NOTE:** If hard drive cage selection qty. is more than three, this X4 RPS Enablement Kit must be selected - to get proper qty. of HDD backplane power connectors.

**NOTE:** If DW GPU card selection qty. is more than two, this X4 RPS Enablement Kit MUST be selected - in order to get proper qty. of GPU external power connectors.

### HPE Computation and Graphics Accelerators

---

HP ML350 Gen9 Graphic Card Support Kit	726565-B21
<b>NOTE:</b> One Graphic Card Support Kit- 726565-B21 is required for each computation or graphics accelerator except for K2200 or M2000.	
HP NVIDIA Quadro K2200 Graphics Accelerator	J0G89A
<b>NOTE:</b> A maximum of four of these cards can be selected.	
NVIDIA Quadro K6000 PCI-E Graphics Adapter	730874-B21
<b>NOTE:</b> A maximum of four of these cards can be selected. Each requires one Graphic Card Support Kit (726565-B21).	
<b>NOTE:</b> If this SKU is selected then minimum quantity = 2 of 800W Power Supply Kit (725870-B21) must be selected.	
NVIDIA Tesla K40C 12GB Computational Accelerator	753960-B21

## Core Options

**NOTE:** A maximum of four of these cards can be selected. Each requires one Graphic Card Support Kit (726565-B21).

**NOTE:** If this SKU is selected then minimum quantity = 2 of 800W Power Supply Kit (725870-B21) must be selected.

HP NVIDIA Quadro M6000 Graphics Accelerator J0G92A

**NOTE:** A maximum of four of these cards can be selected. Each requires one Graphic Card Support Kit (726565-B21).

HP AMD FirePro W7100 Accelerator Kit J0H10A

**NOTE:** A maximum of four of these cards can be selected. Each requires one Graphic Card Support Kit (726565-B21).

HPE NVIDIA Quadro M4000 Graphics Accelerator M9X58A

**NOTE:** A maximum of four of these cards can be selected. Each requires one Graphic Card Support Kit (726565-B21).

**NOTE:** Only supported with E5-2600v4 processors.

HP NVIDIA Quadro M5000 Graphics Accelerator M9R60A

**NOTE:** A maximum of four of these cards can be selected. Each requires one Graphic Card Support Kit (726565-B21).

**NOTE:** Only supported with E5-2600v4 processors.

HPE NVIDIA Quadro M2000 Graphics Accelerator P8Y48A

**NOTE:** A maximum of four of these cards can be selected.

**NOTE:** Only supported with E5-2600v4 processors.

**NOTE:** If more than two Double Wide Graphics options are selected, then HPE ML350 Gen9 X4 RPS Enablement Kit must be selected in order to get the third and fourth supporting power connectors to supply power to the GPU cards.

**NOTE:** Only the above listed Graphics cards are HPE standard supported options in this server.

**NOTE:** The NVIDIA Quadro modules are supported only on 64-bit versions of Linux and Windows operating systems as well as on Virtual Machine client operating systems. The supported bare metal operating systems are RHEL6, SLES 11 and Windows Server 2012 R2.

**NOTE:** Please see the HPE Power Advisor for estimated power consumption of your individual system configuration prior to installing GPUs. The HPE Power Advisor is located

at: <http://www.hp.com/go/hppoweradvisor>.

**NOTE:** All GPU Accelerators are restricted to equal less than 1024GB for system HOST memory.

---

## HPE Cooling Options

HP ML350 Gen9 Redundant Fan Kit 725878-B21

**NOTE:** This kit consists of four system fans and two PCIe air baffles.

## Additional Options

**NOTE:** Some options may not be integrated at the factory. To ensure only valid configurations are ordered, Hewlett Packard Enterprise recommends the use of an HPE approved configurator. Contact your local sales representative for additional information.

<b>HPE Insight Software</b>	<b>HPE Insight Control</b>	
	HPE Insight Control including 1yr 24x7 Technical Support and Updates 1-server LTU	C6N27A
	HPE Insight Control including 1yr 24x7 TSU E-LTU	C6N28ABE
	<b>NOTE:</b> The Electronic software license is available in EMEA only.	
	HPE Insight Management Media Kit	C6N31A
	HPE Insight Control including 1yr 24x7 Support ProLiant ML/DL/BL-bundle Single Server FIO LTU	C6N36A

<b>Embedded Management</b>	<b>HPE iLO Advanced</b>	
	HPE iLO Advanced including 3yr 24x7 Tech Support and Updates 1-server LTU	BD505A
	HPE iLO Advanced including 1yr 24x7 Technical Support and Updates E-LTU	E6U59ABE
	HPE iLO Advanced including 1yr 24x7 Technical Support and Updates 1-server LTU	512485-B21
	HPE iLO Advanced including 3yr 24x7 Technical Support and Updates E-LTU	E6U64ABE

<b>High Performance Clusters</b>	<b>HPE Cluster Management Utility</b>	
	HPE Insight Cluster Management Utility 1yr 24x7 Flexible LTU	QL803B
	HPE Insight Cluster Management Utility 3yr 24x7 Flexible LTU	BD476A
	<b>NOTE:</b> These part numbers can be used to purchase one certificate for multiple licenses and support with a single activation key. Each license is for one node (server). Customer will receive a printed end user license agreement and license entitlement certificate via physical shipment. The license entitlement certificate must be redeemed online in order to obtain a license key. Customer also will receive a support agreement.	
	HPE Insight Cluster Management Utility Media	BD477A

<b>HPE PCIe Workload Accelerator Options</b>	<b>Light Endurance (LE) PCIe Workload Accelerators</b>	
	HPE 5.2TB FH/HL Light Endurance (LE) PCIe Workload Accelerator	775672-B21
	HPE 2.6TB HH/HL Light Endurance (LE) PCIe Workload Accelerator	775670-B21
	HPE 1.3TB HH/HL Light Endurance (LE) PCIe Workload Accelerator	775668-B21
	HPE 1.0TB HH/HL Light Endurance (LE) PCIe Workload Accelerator	775666-B21

<b>HPE Security</b>	HP Security Bezel Kit	660584-B21
	<b>NOTE:</b> Rack model only.	
	HP Trusted Platform Module Option	488069-B21
	<b>NOTE:</b> The HPE Trusted Platform Module Option (488069-B21) is the TPM 1.2 version. Compatible server platforms include Gen8 and Gen9 servers.	
	<b>NOTE:</b> HPE server systems can have a TPM module (of any type) installed only once. It cannot be replaced with any other TPM module.	
	<b>NOTE:</b> The TPM (Trusted Platform Module) is a microcontroller chip that can securely store artifacts used to authenticate the server platform. These artifacts can include passwords, certificates and encryption keys. Windows® BitLocker™ Drive Encryption (BitLocker) is a data protection feature available in Windows Server® 2008. BitLocker leverages the enhanced security capabilities of a Trusted Platform Module (TPM) version 1.2. The TPM works with BitLocker to help protect user data and to ensure that a server running Windows Server	

## Additional Options

2008 has not been tampered with while the system was offline. For more information about TPM, go

to: <https://www.hpe.com/h20195/v2/gethtml.aspx?docname=c04939549>.

**NOTE:** ProLiant OS pre-installed units will come with the partition required for TPM deployment.

**NOTE:** The TPM key is unique to every TPM deployed server and must be retained. Misplacing or losing the key could result in data loss.

HP Trusted Platform Module 2.0 Kit

745823-B21

**NOTE:** HPE Trusted Platform Module 2.0 Option works with Gen9 servers with UEFI Mode not Legacy Mode. It is not compatible with HPE ProLiant Gen8 servers or earlier generation variants.

**NOTE:** HPE Gen9 servers purchased earlier may need the latest firmware update to be compatible with the TPM 2.0 Option.

**NOTE:** HPE server systems can have a TPM module (of any type) installed only once. It cannot be replaced with any other TPM module.

**NOTE:** ML350 Gen9 supports both TPM 1.2 (488069-B21) and TPM 2.0 (745823-B21). However, once the TPM version 1.2 is installed on the system board, it can no longer be upgraded to TPM version 2.0.

**NOTE:** A new TPM (1.2 or 2.0) can only be installed on a Gen9 server if there is no TPM already installed. Once a TPM is installed with the security rivet, it is not designed to be removed. This means that if a customer already has a TPM 1.2 module riveted down on their Gen9 server, they cannot remove it and change it to a TPM 2.0 module.

**NOTE:** For more information about TPM, go

to: <https://www.hpe.com/h20195/v2/gethtml.aspx?docname=c04939549>.

### HPE Storage Controllers

#### SAS Controllers

##### HPE Flexible Smart Array Controllers

HP Smart Array P440ar/2GB FBWC 12Gb 2-ports Int SAS Controller

726736-B21

**NOTE:** Provides support for up to 8 internal SAS/SATA drives without using a PCIe slot.

**NOTE:** Includes the HPE Smart Storage Battery.

HP Smart Array P440ar/2GB FBWC 12Gb 2-ports Int FIO SAS Controller

749974-B21

**NOTE:** Provides support for up to 8 internal SAS/SATA drives without using a PCIe slot.

**NOTE:** Includes the HPE Smart Storage Battery.

**NOTE:** FIO indicates factory integrated option via CTO.

##### HPE Smart Array Controllers

HP Smart Array P440/4GB FBWC 12Gb 1-port Int SAS Controller

726821-B21

**NOTE:** Provides support for up to 8 internal SAS/SATA drives, consumes 1 PCIe slot.

HP Smart Array P440/4GB FBWC 12Gb 1-port Int FIO SAS Controller

761872-B21

**NOTE:** Includes the HPE Smart Storage Battery.

**NOTE:** FIO indicates factory integrated option via CTO.

HP Smart Array P840/4GB FBWC 12Gb 2-ports Int SAS Controller

726897-B21

HP Smart Array P840/4GB FBWC 12Gb 2-ports Int FIO SAS Controller

761874-B21

**NOTE:** Includes the HPE Smart Storage Battery.

**NOTE:** FIO indicates factory integrated option via CTO.

HP Smart Array P441/4GB FBWC 12Gb 2-ports Ext SAS Controller

726825-B21

HP Smart Array P841/4GB FBWC 12Gb 4-ports Ext SAS Controller

726903-B21

#### HPE Smart Host Bus Adapters

## Additional Options

HP H240ar 12Gb 2-ports Int Smart Host Bus Adapter	726757-B21
<b>NOTE:</b> Provides support for up to 8 internal SAS/SATA drives without using a PCIe slot.	
HP H240ar 12Gb 2-ports Int FIO Smart Host Bus Adapter	749976-B21
<b>NOTE:</b> Provides support for up to 8 internal SAS/SATA drives without using a PCIe slot.	
<b>NOTE:</b> FIO indicates factory integrated option via CTO.	
HP H240 12Gb 2-ports Int Smart Host Bus Adapter	726907-B21
HP H240 12Gb 2-ports Int FIO Smart Host Bus Adapter	761873-B21
<b>NOTE:</b> FIO indicates factory integrated option via CTO.	
HP H241 12Gb 2-ports Ext Smart Host Bus Adapter	726911-B21
<b>Optional Upgrades</b>	
HP 12Gb SAS Expander Card for ML350 Gen9	769635-B21
<b>NOTE:</b> The SAS Expander card supports 24 drives. The SAS Expander card must be used in conjunction with an HPE Smart Array P440 or P840 controller, or an H240 Host Bus Adapter. The SAS Expander card cannot be connected to H240ar or P440ar Flexible Smart Array Controller (AROC) cards. The SAS Expander kit includes two cables to connect from the Smart Array controller or HBA to the SAS Expander and the other to connect from the Expander to the HDD backplane.	
<b>NOTE:</b> It DOES NOT support tape storage/ Disk-Based Backup device (RDX).	
HP ML350 Gen9 2nd Expander Card	811216-B21
<b>NOTE:</b> The ML350 Gen9 2nd Expander Card must be used in conjunction with ML350 Gen9 SAS Expander kit (769635-B21, see config. guideline described in above item), a 2nd processor kit, ML350 Gen9 x4 RPS enablement kit (802988-B21) and P840 controller. This configuration can support maximum 48 drives in SFF chassis system.	
<b>NOTE:</b> This kit DOES NOT support tape storage or disk-based backup devices (RDX) either.	
HP 96W Smart Storage Battery with 145mm Cable for DL/ML/SL Servers	727258-B21
HPE SmartCache No Media 24x7 Technical Support 1-server LTU	D7S26A
HPE SmartCache No Media 24x7 Technical Support Flexible LTU	D7S27A
HPE SmartCache No Media 24x7 Technical Support E-LTU	D7S27AAE
<b>HPE Cable Options</b>	
HP ML350 Gen9 Flexible Smart Array Controller Mini-SAS Cable Kit	765652-B21
<b>NOTE:</b> Mini-SAS Cable Kit for Flexible Smart Array (AROC) Controller.	
HP ML350 Gen9 Smart Array Cable Kit	765650-B21
<b>NOTE:</b> Mini-SAS Cable Kit for stand-up P-series Smart Array Card.	
HP ML350 Gen9 Host Bus Adapter Mini-SAS Cable Kit	765648-B21
<b>NOTE:</b> Mini-SAS Cable kit for Host Bus Adapter.	
HP ML350 Gen9 Mini SAS Cable FIO Kit	765654-B21
<b>NOTE:</b> Required to support B140i embedded SATA controller.	
<b>NOTE:</b> FIO indicates factory integrated option for CTO order.	

---

**HPE Tape Backup** **NOTE:** For the complete range of tape drives, autoloaders, libraries and media see: <http://www.hp.com/go/tape>. For hardware and software compatibility of Hewlett Packard Enterprise tape backup products see: <http://www.hp.com/storage/SPOCK> and <http://www.hp.com/go/ebs>.

### Tape Drives

HPE StoreEver LTO-4 Ultrium 1760 SAS External Tape Drive	EH920B
----------------------------------------------------------	--------

## Additional Options

HPE StoreEver LTO-4 Ultrium 1760 SAS Internal WW Tape Drive	EH919B
HPE StoreEver LTO-5 Ultrium 3000 SAS External Tape Drive	EH958B
HPE StoreEver LTO-5 Ultrium 3000 SAS Internal Tape Drive	EH957B
HPE StoreEver LTO-5 Ultrium 3000 SAS Tape Drive in a 1U Rack Mount Kit	EJ014B
HPE StoreEver LTO-6 Ultrium 6250 External Tape Drive	EH970A
HPE StoreEver LTO-6 Ultrium 6250 Internal Tape Drive	EH969A
HPE StoreEver 1/8 G2 LTO-6 Ultrium 6250 Fibre Channel Tape Autoloader	C0H19A
HPE StoreEver LTO-6 Ultrium 6250 Tape Drive in a 1U Rack Mount Kit	C0L99A
HPE StoreEver Mini-SAS High Density to 4-lane Mini-SAS External Fanout 2m Cable	K2R09A
HPE StoreEver Mini-SAS High Density to 4-lane Mini-SAS External Fanout 4m Cable	K2R10A
HPE StoreEver LTO-7 Ultrium 15000 Internal Tape Drive	BB873A
HPE StoreEver LTO-7 Ultrium 15000 External Tape Drive	BB874A

### HPE Tape Storage Systems

#### HPE StoreEver MSL6480

HPE StoreEver MSL6480 Scaleable Expansion Module	QU626A
<b>NOTE:</b> Please see the <a href="#">HPE StoreEver MSL6480 Tape Library QuickSpecs for Technical Specifications and additional information.</a>	
HPE StoreEver MSL6480 Scalable Base Module	QU625A
HPE StoreEver MSL2024 0-drive Tape Library	AK379A
HPE StoreEver MSL4048 0-drive Tape Library	AK381A

### HPE Disk Backup **HPE RDX Removable Disk Backup Systems USB**

HPE RDX500 USB3.0 Internal Disk Backup System	B7B64A
HPE RDX1000 USB3.0 Internal Disk Backup System	B7B67A
HPE RDX 2TB USB3.0 Internal Disk Backup System	E7X52A
HP RDX+ 500GB External Backup System	B7B66B
HP RDX+ 1TB External Backup System	B7B69B
HP RDX 2TB USB3.0 External Disk Backup System	E7X53B
HPE RDX+ External Docking System	C8S07B
HPE RDX USB 3.0 Internal Docking Station	C8S06A
HPE RDX 3TB USB 3.0 Internal Disk Backup System	P9L71A
HPE RDX+ 3TB USB 3.0 External Disk Backup System	P9L72A

**NOTE:** For the complete range of RDX drives and media see: <http://www.hp.com/go/rdx>. For hardware and software compatibility of HPE disk backup products see: <http://www.hp.com/storage/SPOCK>.

### HPE Storage Options

**NOTE:** The following is a list of all Fibre Channel Host Bus Adapters for Windows and Linux. For detailed compatibility information please

see: <http://h18006.www1.hp.com/storage/saninfrastructure/hba.html>

#### Emulex Fibre Channel HBAs

HPE 81E 8Gb 1-port PCIe Fibre Channel Host Bus Adapter	AJ762B
HPE 82E 8Gb 2-port PCIe Fibre Channel Host Bus Adapter	AJ763B
HPE StoreFabric SN1100E 16Gb Single Port Fibre Channel Host Bus Adapter	C8R38A
HPE StoreFabric SN1100E 16Gb Dual Port Fibre Channel Host Bus Adapter	C8R39A
HPE StoreFabric SN1600E 32Gb Single Port Fibre Channel Host Bus Adapter	Q0L11A
HPE StoreFabric SN1600E 32Gb Dual Port Fibre Channel Host Bus Adapter	Q0L12A
HPE StoreFabric SN1200E 16Gb Single Port Fibre Channel Host Bus Adapter	Q0L13A
HPE StoreFabric SN1200E 16Gb Dual Port Fibre Channel Host Bus Adapter	Q0L14A

#### QLogic Fibre Channel HBAs

## Additional Options

HPE 81Q 8Gb 1-port PCIe Fibre Channel Host Bus Adapter	AK344A
HPE 82Q 8Gb 2-port PCIe Fibre Channel Host Bus Adapter	AJ764A
HPE StoreFabric SN1000Q 16GB 1-port PCIe Fibre Channel Host Bus Adapter	QW971A
HPE StoreFabric SN1000Q 16GB 2-port PCIe Fibre Channel Host Bus Adapter	QW972A
HPE StoreFabric 84Q 4-port 8Gb Fibre Channel Host Bus Adapter	P9D91A
HPE StoreFabric SN1100Q 16Gb Single Port Fibre Channel Host Bus Adapter	P9D93A
HPE StoreFabric SN1100Q 16Gb Dual Port Fibre Channel Host Bus Adapter	P9D94A
HPE StoreFabric SN1600Q 32Gb Single Port Fibre Channel Host Bus Adapter	P9M75A
HPE StoreFabric SN1600Q 32Gb Dual Port Fibre Channel Host Bus Adapter	P9M76A

### Converged Network Adapter

HPE StoreFabric CN1100R Dual Port Converged Network Adapter	QW990A
HPE StoreFabric CN1200E 10Gb Converged Network Adapter	E7Y06A
HPE StoreFabric CN1100R 10GBASE-T Dual Port Converged Network Adapter	N3U52A
HPE StoreFabric CN1200E 10GBASE-T Dual Port Converged Network Adapter	N3U51A

### HPE Disk Storage Systems

#### Disk Enclosures

HP D6000 Dual I/O Module Disk Enclosure	QQ695A
<b>NOTE: See the <a href="#">HPE D6000 Disk Enclosure QuickSpecs</a> for additional information including configuration steps and additional options needed for a complete solution.</b>	
HPE D6000 w/70 8TB 12G SAS 7.2K LFF (3.5in) Dual Port MDL HDD 560TB Bundle	M0T59A
HPE D6000 w/35 8TB 12G SAS 7.2K LFF (3.5in) Dual Port MDL HDD 280TB Bundle	M0T58A
HP D6000 w/35 4TB 6G SAS 7.2K LFF Dual Port MDL HDD 140TB Bundle	E7W30A
HP D6000 w/70 4TB 6G SAS 7.2K LFF Dual Port MDL HDD 280TB Bundle	E7W31A
HP D6000 w/35 2TB 6G SAS 7.2K LFF Dual port MDL HDD 70TB Bundle	QQ697A
HP D6000 w/70 2TB 6G SAS 7.2K LFF Dual port MDL HDD 140TB Bundle	QQ698A
HP D6000 w/35 3TB 6G SAS 7.2K LFF Dual port MDL HDD 105TB Bundle	QQ699A
HP D6000 w/70 3TB 6G SAS 7.2K LFF Dual port MDL HDD 210TB Bundle	QQ700A

### HPE Data Center Racks

#### HPE Advanced Series Racks

HPE 11648 1075mm Pallet Universal Rack	H6J87A
HPE 11648 1075mm Shock Universal Rack	H6J88A
HPE 11642 1075mm Pallet Universal Rack	H6J65A
HPE 11642 1075mm Shock Universal Rack	H6J66A
HPE 11642 1200mm Pallet Universal Rack	H6J67A
HPE 11642 1200mm Shock Universal Rack	H6J68A
HPE 11636 1075mm Pallet Universal Rack	H6J77A
HPE 11636 1075mm Shock Universal Rack	H6J78A
HPE 11622 G2 1075mm Pallet Universal Rack	H6J83A
HPE 11622 G2 1075mm Shock Universal Rack	H6J84A
HPE 11614 1075mm Shock Universal Rack	H6J82A

**NOTE: Please see the [HPE Advanced Series Racks QuickSpecs](#) for information on additional racks options and rack specifications.**

#### HPE Enterprise Series Racks

HPE 647 1075mm Pallet Intelligent Series Rack	BW911A
HPE 647 1075mm Shock Intelligent Series Rack	BW912A
HPE 647 1200mm Pallet Intelligent Series Rack	BW913A
HPE 647 1200mm Shock Intelligent Series Rack	BW914A



## Additional Options

HPE 642 1075mm Pallet Intelligent Series Rack	BW903A
HPE 642 1075mm Shock Intelligent Series Rack	BW904A
HPE 642 1200mm Pallet Intelligent Series Rack	BW907A
HPE 642 1200mm Shock Intelligent Series Rack	BW908A
HPE 636 1075mm Pallet Intelligent Series Rack	BW895A
HPE 636 1075mm Shock Intelligent Series Rack	BW896A
HPE 842 1075mm Pallet Intelligent Series Rack	BW917A
HPE 842 1075mm Shock Intelligent Series Rack	BW918A

**NOTE:** Please see the [HPE Enterprise Series Racks QuickSpecs](#) for information on additional racks options and rack specifications.

### HPE Standard Series Rack

HPE V142 1075mm deep Pallet 100 series Rack	AF046A
---------------------------------------------	--------

**NOTE:** Please see the [HPE Standard Series Racks QuickSpecs](#) for information on additional racks options and rack specifications.

---

<b>HPE Power Distribution Units (PDUs)</b>	<b>HPE Basic Power Distribution Units (PDU)</b>	
	HPE Basic Modular 4.9kVA/L6-30P 24A/208V Outlets (4) C19/Horizontal NA/JP Core Only PDU	252663-D74
	HPE Basic Modular 8.3kVA/CS8265C 40A/208V Outlets (4) C19/Horizontal NA/JP PDU	252663-D75
	HPE Basic Modular 7.3kVA/60309 3-wire 32A/230V Outlets (4) C19/Horizontal INTL Core Only PDU	252663-B33
	HPE Basic Modular 3Ph 17.3kVA/60309 60A 4-wire 48A/208V Outlets (6) C19/Horizontal NA/JP PDU	AF511A
	HPE Basic Modular 3Ph 22kVA/60309 5-wire 32A/230V Outlets (6) C19/Horizontal INTL PDU	AF518A
	HPE Basic 3.6kVA/60320 C20 Detachable 16A/230V Outlets (12) C13/Horizontal WW PDU	H5M56A
	HPE Basic 4.9kVA/L6-30P 24A/208V Outlets (20) C13/Vertical NA/JP PDU	H5M58A
	HPE Basic 7.3kVA/60309 5-wire 32A/230V Outlets (20) C13/Vertical INTL PDU	H5M68A
	HPE Basic 7.3kVA/60309 3-wire 32A/230V Outlets (24) C13 (6) C19/Vertical INTL PDU	H5M70A
	HPE Intelligent Modular 3Ph 11kVA/60309 5-wire 16A/230V Outlets (6) C19/Horizontal INTL PDU	AF526A
	HPE Intelligent Modular 3Ph 22kVA/60309 5-wire 32A/230V Outlets (6) C19/Horizontal INTL PDU	AF527A
	<b>NOTE:</b> Please see the <a href="#">HPE Basic Power Distribution Units (PDU) QuickSpecs</a> for information on additional options and product specifications.	
	<b>HPE Metered Power Distribution Units (PDU)</b>	
	HPE Metered 2.8kVA/L5-30P 24A/120V Outlets (12) 5-20R/Horizontal NA/JP PDU	D9N43A
	HPE Metered 3.6kVA/60320 C20 Detachable 16A/230V Outlets (16) C13/Vertical WW PDU	D9N45A
	HPE Metered 4.9kVA/L6-30P 24A/208V Outlets (20) C13 (4) C19/Vertical NA/JP PDU	D9N47A
	HPE Metered 7.3kVA/60309 32A 3-wire/230V Outlets (20) C13 (4) C19/Vertical INTL PDU	D9N48A
	HPE Metered 7.3kVA/60309 32A 3-wire/230V Outlet (32) C13 (4) C19/Vertical INTL PDU	D9N50A
	HPE Metered 3Ph 11kVA/60309 5-wire 16A/230V Outlets (18) C13 (3) C19/Vertical INTL PDU	D9N55A

## Additional Options

HPE Metered 3Ph 11kVA/60309 5-wire 16A/230V Outlets (30) C13 (3) C19/Vertical INTL PDU	D9N57A
HPE Metered 3Ph 17.3kVA/60309 60A 4-wire 48A/208V Outlets (12) C13 (12) C19/Vertical NA/JP PDU	D9N59A
HPE Metered 3Ph 22kVA/60309 5-wire 32A/230V Outlet (30) C13 (3) C19/Vertical INTL PDU	D9N56A
HPE Metered 3Ph 22kVA/60309 5-wire 32A/230V Outlets (12) C13 (12) C19/Vertical INTL PDU	D9N60A

**NOTE:** Please see the [HPE Metered Power Distribution Units \(PDU\) QuickSpecs](#) for information on additional options and product specifications.

### HPE Intelligent Power Distribution Unit (PDU)

HPE Intelligent Modular 4.9kVA/L6-30P 24A/208V Outlets (6) C19/Horizontal NA/JP PDU	AF520A
HPE Intelligent Modular 8.3kVA/CS8265C 40A/208V Outlets (6) C19/Horizontal NA/JP PDU	AF521A
HPE Intelligent Modular 3Ph 8.6kVA/L15-30P 24A/208V Outlets (6) C19/Horizontal NA/JP PDU	AF522A
HPE Intelligent Modular 3Ph 17.3kVA/60309 60A 4-wire 48A/208V (6) C19/Horizontal NA/JP PDU	AF523A
HPE Intelligent Modular 3Ph 17.3kVA/IEC 60309 60A 4-wire 48A/208V (12) C19/Horizontal NA/JP PDU	AF535A
HPE Intelligent Modular 4.9kVA/L6-30P 24A/208V Outlets (20) C13 (6) C19/Horizontal NA/JP PDU	AF531A
HPE Intelligent Modular 3Ph 8.6kVA/L15-30P 24A/208V Outlets (20) C13 (6) C19/Horizontal NA/JP PDU	AF532A
HPE Intelligent Modular 7.3kVA/60309 3-wire 32A/230V Outlets (6) C19/Horizontal INTL PDU	AF525A
HPE Intelligent Modular 7.3kVA/60309 3-wire 32A/230V Outlets (6) C19/Horizontal INTL PDU Kit	AF534A

**NOTE:** Please see the [HPE Intelligent Power Distribution Unit \(PDU\) QuickSpecs](#) for information on additional options and product specifications.

### HPE Rack Mount Consoles, KVM Switches, and Keyboards

#### Rack location options

HP ML350 Gen9 Discover Service FIO Kit	726549-B21
<b>NOTE:</b> For Rack CTO server only.	
HP ML350 Gen9 System Insight Display Kit	726563-B21
HPE 36U Location Discovery Kit	BW945A
HPE 42U Location Discovery Kit	BW946A
HPE 47U Location Discovery Kit	BW947A
HPE Location Discovery Services LCD8500 Kit	TL052A

#### Rail Kits

HP ML350 Gen9 5U FIO Rail Kit	790357-B21
<b>NOTE:</b> For Rack CTO server only.	
HP ML350 Gen9 Tower to Rack Conversion Kit	726567-B21
<b>NOTE:</b> For converting a tower model to a rack model. It is consist of a 5U rail kit, cable management arm (CMA) and rack enablement kit (rack ear, rack handle, SID blank etc).	

#### HPE Rack Mount Consoles

HP LCD8500 1U US Rackmount Console Kit	AF630A
HP LCD8500 1U UK Rackmount Console Kit	AF631A
HP LCD8500 1U DE Rackmount Console Kit	AF632A

## Additional Options

HP LCD8500 1U FR Rackmount Console Kit	AF633A
HP LCD8500 1U JP Rackmount Console Kit	AF642A
HP LCD8500 1U RU Rackmount Console Kit	AF643A
HP LCD8500 1U INTL Rackmount Console Kit	AF644A
HP LCD8500 1U US TAA Rackmount Console Kit	AF645A

### HPE KVM Switches

**NOTE:** To learn more, please visit the [HPE KVM Switches web page](#).

HP 1x1Ex8 KVM IP Console Switch G2 with Virtual Media CAC Software	AF620A
HP 2x1Ex16 KVM IP Console Switch G2 with Virtual Media CAC Software	AF621A
HP 0x2x16 KVM Server Console Switch G2 with Virtual Media CAC Software	AF618A
HP 1x4 USB/PS2 KVM Console Switch	AF611A
HP 0x2x32 KVM Server Console Switch G2 with Virtual Media CAC Software	AF619A
HP 4x1Ex32 KVM IP Console Switch G2 with Virtual Media CAC Software	AF622A
HP KVM Console USB Interface Adapter	AF628A
HP KVM Console USB 2.0 Virtual Media CAC Interface Adapter	AF629A
HP USB Remote Access Key for G3 KVM Console Switches	AF650A
HP 0x1x8 G3 KVM Console Switch	AF651A
HP 0x2x16 G3 KVM Console Switch	AF652A
HP TAA 0x2x16 G3 KVM Console Switch	AF653A

### HPE USB Keyboard and Mouse

HP USB BFR with PVC Free US Keyboard/Mouse Kit	631341-B21
HP USB BFR with PVC Free Intl Keyboard/Mouse Kit	672097-B33
HP USB BFR with PVC Free UK Keyboard/Mouse Kit	631344-B21
HP USB BFR with PVC Free FR Keyboard/Mouse Kit	631346-B21
HP USB BFR with PVC Free ES Keyboard/Mouse Kit	631348-B21
HP USB BFR with PVC Free DE Keyboard/Mouse Kit	631358-B21
HP USB BFR with PVC Free JP Keyboard/Mouse Kit	631360-B21
HP USB BFR with PVC Free IT Keyboard/Mouse Kit	631362-B21
HP USB BFR with PVC Free CN Keyboard/Mouse Kit	631364-B21
HP USB BFR with PVC Free AE Keyboard/Mouse Kit	638212-B21
HP USB BFR with PVC Free RU Keyboard/Mouse Kit	638214-B21
HP USB BFR with PVC Free SE Keyboard/Mouse Kit	672097-103
HP USB BFR with PVC Free CH Keyboard/Mouse Kit	672097-113
HP USB BFR with PVC Free PT Keyboard/Mouse Kit	672097-133
HP USB BFR with PVC Free TR Keyboard/Mouse Kit	672097-143
HP USB BFR with PVC Free CZ Keyboard/Mouse Kit	672097-223
HP USB BFR with PVC Free FI Keyboard/Mouse Kit	672097-353
HP USB BFR with PVC Free AP-Intl Keyboard/Mouse Kit	672097-373
HP USB BFR with PVC Free IN Keyboard/Mouse Kit	672097-D63
HP USB BFR with PVC Free KR Keyboard/Mouse Kit	672097-KD3

**NOTE:** Please see the [HPE USB Keyboard and Mouse QuickSpecs](#) for information on additional options and product specifications.

## HPE Uninterruptible HPE Tower UPS

### Power Systems (UPS)

HPE R1500 G4 JP/TWN Uninterruptible Power System	J2R05A
HPE R1500 G4 INTL Uninterruptible Power System	J2R03A
HPE T750 G4 NA/JP Uninterruptible Power System	J2P85A
HPE T1000 G4 NA/JP Uninterruptible Power System	J2P86A
HPE T1500 G4 NA/JP Uninterruptible Power System	J2P87A
HPE T750 G4 INTL Uninterruptible Power System	J2P88A

## Additional Options

HPE T1000 G4 INTL Uninterruptible Power System	J2P89A
HPE T1500 G4 INTL Uninterruptible Power System	J2P90A
HPE R5000 3U L630 High Voltage NA/JP Uninterruptible Power System	AF460A

### HPE Rack-mountable UPS

HPE 32A 400-415 Volt Three Phase INTL R12000 DirectFlow UPS IEC309 Input/Output Module	AF488A
HPE R5000 3U IEC309-32A High Voltage INTL Uninterruptible Power System	AF461A
HPE R7000 4U IEC-32A High Voltage INTL Uninterruptible Power System	AF463A
HPE R7000 4U 50A High Voltage NA/JP Uninterruptible Power System	AF462A
HPE RP12000/3 12000VA Three Phase INTL 6U Rackmount Uninterruptible Power System	AF437A

**NOTE:** To learn more, please visit the [HPE Uninterruptible Power Systems \(UPS\) web page](#).

---

<b>HPE USB and SD Options</b>	HPE 32GB microSD Mainstream Flash Media Kit	700139-B21
	HPE 8GB microSD Enterprise Mainstream Flash Media Kit	726116-B21
	HP 8GB USB Enterprise Mainstream Flash Media Drive Key Kit	737953-B21
	HP Dual 8GB microSD Enterprise Midline USB Kit	741279-B21

---

<b>HPE Support Services</b>	<b>Installation &amp; Start-up Services</b>	
	HPE Install ProLiant ML350(p) Service	U4522E
	HPE Installation and Startup ML350(p) Service	U4523E
	<b>Proactive Care</b>	
	HPE 3 year Proactive Care 24x7 ML350 Gen9 Service	U7BG4E
	HPE 3 year Proactive Care Call to Repair ML350 Gen9 Service	U7BH0E
	HPE 3 year Proactive Care 24x7 with DMR ML350 Gen9 Service	U7BG5E
	HPE 3 year Proactive Care 24x7 with CDMR ML350 Gen9 Service	U7BG6E
	HPE 3 year Proactive Care Call to Repair 24x7 with DMR ML350 Gen9 Service	U7BH1E
HPE 3 year Proactive Care Call to Repair with CDMR ML350 Gen9 Service	U7BH2E	

## Memory

### Memory Population Guidelines

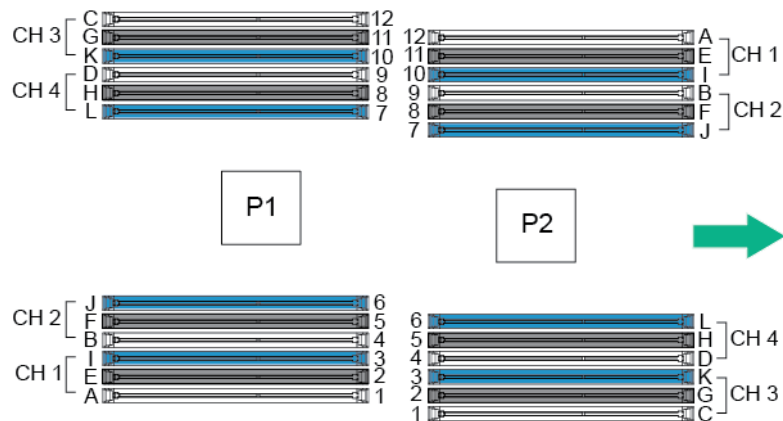

DIMM population order			
	1st slot of channel	2nd slot of channel	3rd slot of channel
	A B C D	E F G H	I J K L
Number of DIMMs to install	4	8	12

#### General Memory Population Rules and Guidelines:

- . A minimum of one DIMM is required per server.
- . White DIMM slots denote the first slot to be populated in a channel.
- . Install DIMMs only if the corresponding processor is installed.
- . If only one processor is installed in a two processor system, only half of the DIMM slots are available.
- . To maximize performance, it is recommended to balance the total memory capacity between all installed processors and load the channels similarly whenever possible.
- . When two processors are installed, balance the DIMMs across the two processors.
- . Place the DIMMs with the highest number of ranks in the white slot when mixing DIMMs of different ranks on the same channel.
- . Do not mix RDIMMs or LRDIMMs.
- . Quad rank RDIMMs are not supported in HPE ProLiant ML350 Gen9 servers.
- . Quad rank LRDIMMs are capable of up to three DIMMs per channel.
- . RDIMMs operating at 1.2V
- . DIMMs of different speeds may be mixed in any order; the server will select a common optimal speed.
- . The maximum memory speed is a function of the memory type, memory configuration, and processor model.
- . The maximum memory capacity is a function of the memory type and number of installed processors.
- . To realize the performance memory capabilities listed in this document, HPE SmartMemory is required. For additional information, please see the HPE SmartMemory QuickSpecs at: <https://www.hpe.com/h20195/v2/GetHTML.aspx?docname=c04111535>.
- . For memory population rules and additional memory guidelines, please see the ML350 Gen9 user guide at [http://h20628.www2.hp.com/km-ext/kmcsdirect/emr\\_na-c04431235-6.pdf](http://h20628.www2.hp.com/km-ext/kmcsdirect/emr_na-c04431235-6.pdf)
- . There are four (4) channels per processor; eight (8) channels per server. There are three (3) DIMM slots for each memory channel; twenty-four (24) total slots Memory channels 1 and 3 consists of the

## Memory

three (3) DIMMs that are furthest from the processor Memory channel 2 and 4 consists of the three (3) DIMMs that are closest to the processor

All GPU Accelerators are restricted to equal less than 1024GB for system HOST memory.

### Intel Gen9 Supported Memory Bandwidth for HPE ProLiant Gen9 Intel® Xeon® E5-2600v3 Series Processor Family

Memory Bandwidth and Capacity								
[DIMM Type]	Registered DIMMs (RDIMMs)					Load Reduced (LRDIMMs)		
HPE SKU P/N	726717-B21	726718-B21	759934-B21	726719-B21	728629-B21	726720-B21	726722-B21	726724-B21
DIMM Rank	Single Rank	Single Rank	Dual Rank	Dual Rank	Dual Rank	Dual Rank	Quad Rank	Quad Rank
DIMM Capacity	4GB	8GB	8GB	16GB	32GB	16GB	32GB	64GB
Voltage	Std Voltage 1.2V	Std Voltage 1.2V	Std Voltage 1.2V	Std Voltage 1.2V	Std Voltage 1.2V	Std Voltage 1.2V	Std Voltage 1.2V	Std Voltage 1.2V
DRAM Depth [bit]	512M	1G	512M	1G	1G	2G	2G	2G
DRAM Width [bit]	x8	x4	x8	x4	x4	x4	x4	x4
DRAM Density	4Gb	4Gb	4Gb	4Gb	4Gb	8Gb	8Gb	8Gb
CAS Latency	15-15-15	15-15-15	15-15-15	15-15-15	15-15-15	15-15-15	15-15-15	15-15-15
DIMM Native Speed (MT/s)	2133	2133	2133	2133	2133	2133	2133	2133
SLOTS THAT CAN BE POPULATED								
24 slot servers	24	24	24	24	24	24	24	24
MAXIMUM CAPACITY (GB)								
	96	192	192	384	768	384	768	1536
POPULATED DIMM SPEED (MT/s)								
1 DIMM Per Channel	2133	2133	2133	2133	2133	2133	2133	2133
2 DIMM Per Channel	2133	2133	2133	2133	2133	2133	2133	2133
3 DIMM Per Channel	1600	1600	1600	1600	1866	1600	1866	1866

### Intel Gen9 Supported Memory Bandwidth for HPE ProLiant Gen9 Intel® Xeon® E5-2600v4 Series Processor Family

Memory Bandwidth and Capacity							
[DIMM Type]	Registered DIMMs (RDIMMs)				Load Reduced (LRDIMMs)		
HPE SKU P/N	805347-B21	805349-B21	836220-B21	805351-B21	805353-B21	805358-B21	809208-B21
DIMM Rank	Single Rank	Single Rank	Dual Rank	Dual Rank	Dual Rank	Quad Rank	Octal Rank
DIMM Capacity	8GB	16GB	16GB	32GB	32GB	64GB	128GB

## Memory

<b>Voltage</b>	Std Voltage 1.2V	Std Voltage 1.2V	Std Voltage 1.2V	Std Voltage 1.2V	Std Voltage 1.2V	Std Voltage 1.2V	Std Voltage 1.2V
<b>DRAM Depth [bit]</b>	1G	2G	1G	2G	2G	2G	2G
<b>DRAM Width [bit]</b>	x8	x4	x4	x4	x4	x4	x4
<b>DRAM Density</b>	8Gb	8Gb	4Gb	8Gb	8Gb	8Gb	8Gb
<b>CAS Latency</b>	17-17-17	17-17-17	17-17-17	17-17-17	17-17-17	17-17-17	20-18-18
<b>DIMM Native Speed (MT/s)</b>	2400	2400	2400	2400	2400	2400	2400
<b>SLOTS THAT CAN BE POPULATED</b>							
24 slot servers	24	24	24	24	24	24	24
<b>MAXIMUM CAPACITY (GB)</b>							
	192	384	384	768	768	1536	3072
<b>POPULATED DIMM SPEED (MT/s)</b>							
<b>1 DIMM Per Channel</b>	2400	2400	2400	2400	2400	2400	2400
<b>2 DIMM Per Channel</b>	2133	2133	2400	2400	2400	2400	2400
<b>3 DIMM Per Channel</b>	1866	1866	1866	1866	2133	2133	2133

## DIMM slot and configuration diagram

## DIMM slot and configuration diagrams

- Population order; start with "A" first, "B" second, "C" third, etc.
- When one processor is installed, install DIMMs in sequential alphabetic order: A, B, C, D, E, F.
- When two processors are installed, install DIMMs in sequential alphabetic order: CPU1-A, CPU2-A, CPU1-B, CPU2-B, CPU1-C, CPU2-C

	CPU 1		CPU 2		
	Slot #	population order	Slot #	population order	
Chnl 1	1	A	1	C	Chnl 4
	2	E	2	G	
	3	I	3	K	
	CPU 1		CPU 2		
	Slot #	population order	Slot #	population order	
Chnl 2	4	B	4	D	Chnl 3
	5	F	5	H	
	6	J	6	L	
	CPU 1		CPU 2		
	Slot #	population order	Slot #	population order	
Chnl 3	7	L	7	J	Chnl 2
	8	H	8	F	
	9	D	9	B	

## Memory

	CPU 1		CPU 2		
	Slot #	population order	Slot #	population order	
Chnl 4	10	K	10	I	Chnl 1
	11	G	11	E	
	12	C	12	A	

### Memory Speed by Processor Model

Processor Models	Supported Memory Speeds
E5-2609v3, E5-2603v3	1600MT/s
E5-2640v3, E5-2630v3, E5-2620v3, E5-2630Lv3, E5-2623v3	1866MT/s
E5-2637v3, E5-2690v3, E5-2680v3, E5-2670v3, E5-2660v3, E5-2650v3, E5-2650Lv3, E5-2697v3, E5-2695v3, E5-2667v3, E5-2643v3, E5-2683v3, E5-2699v3, E5-2698v3	2133MT/s
E5-2609v4, E5-2603v4	1866MT/s
E5-2630Lv4, E5-2620v4, E5-2623v4, E5-2640v4, E5-2630v4	2133MT/s
E5-2650Lv4, E5-2643v4, E5-2637v4, E5-2690v4, E5-2680v4, E5-2660v4, E5-2650v4, E5-2697v4, E5-2695v4, E5-2667v4, E5-2683v4, E5-2699v4, E5-2698v4, E5-2697Av4	2400MT/s

### Standard and Maximum Memory Capacity (Pre-configured Models)

Pre Configured Models	Standard Memory	Maximum Memory Plus Optional Memory	Standard Memory Replaced with Optional Memory
E5-2650v4, E5-2650v3, E5-2630v4, E5-2630v3	32GB (2x16GB)	736GB (22x32GB, 2x16GB)	1536GB (24x64GB)
E5-2620v4, E5-2620v3	16GB (1x16GB)	752GB (23x32GB, 1x16GB)	1536GB (24x64GB)
E5-2609v4, E5-2609v3	8GB (1x8GB)	744GB (23x32GB, 1x8GB)	1536GB (24x64GB)

### DDR4 memory options part number decoder

**NOTE:** Capacity references are rounded to the common gigabyte (GB) values.

- 2GB = 2,048MB
- 4GB = 4,096MB
- 8GB = 8,192MB
- 16GB = 16,384MB
- 32GB = 32,768MB
- 64GB = 65,536MB



# Memory

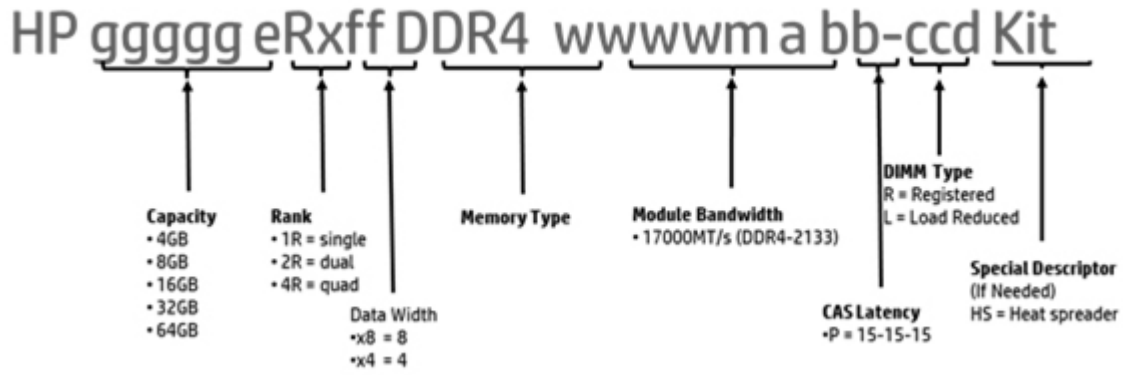

Storage

48 SFF hot-plug drive model (Tower)

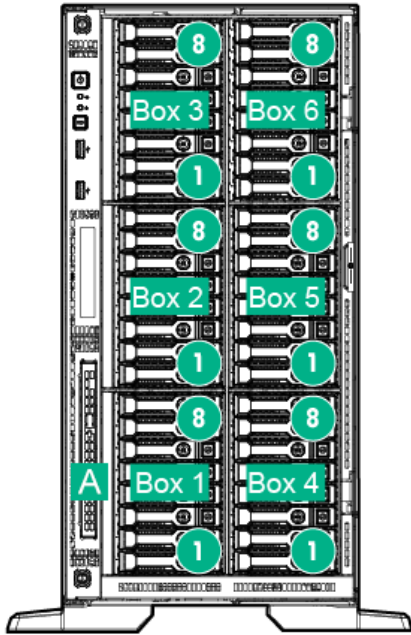

- A Optional Slim DVD-ROM/DVD-RW
- 1-6 8 x SFF SATA/SAS/SSD Hot Pluggable Hard Drive Bays

48 SFF hot-plug drive model (Rack)

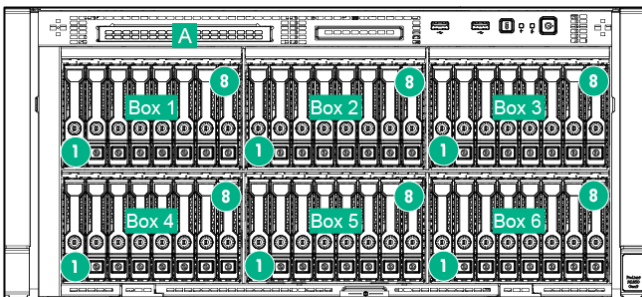

- A Optional Slim DVD-ROM/DVD-RW
- 1-6 8 x SFF SATA/SAS/SSD Hot Pluggable Hard Drive Bays

24 LFF hot-plug drive model (Tower)

- A Optional Slim DVD-ROM/DVD-RW
- 1-3 8 x LFF SATA/SAS/SSD Hot Pluggable Hard Drive Bays

Storage

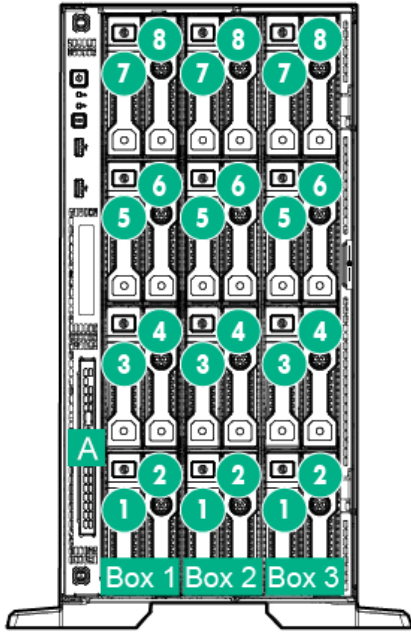

24 LFF hot-plug drive model (Rack)

A

Optional Slim DVD-ROM/DVD-RW

1-3

8 x LFF SATA/SAS/SSD Hot Pluggable Hard Drive Bays

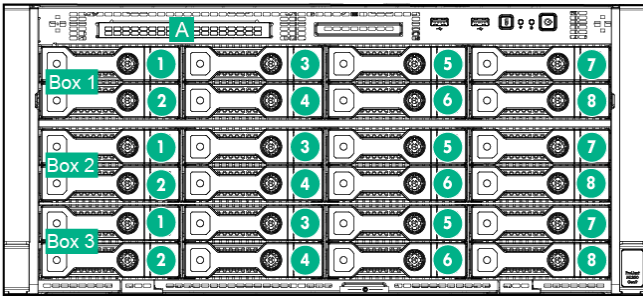

32 SFF hot-plug drives with SFF media cage

A

Optional Slim DVD-ROM/DVD-RW

B

SFF Media Cage

1-4

Remark: Support up to 2 RDX or Tape devices.  
8 x SFF SATA/SAS/SSD Hot Pluggable Hard Drive Bays  
Image shown a ML350 Gen9 Rack model

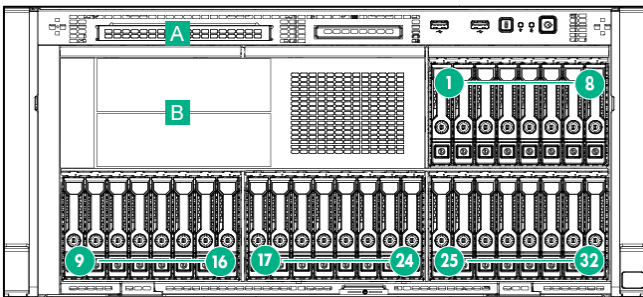

16 LFF hot-plug drives with LFF media cage

A

Optional Slim DVD-ROM/DVD-RW

B

LFF Media Cage

1-2

8 x LFF SATA/SAS/SSD Hot Pluggable Hard Drive Bays  
Image shown a ML350 Gen9 Rack model

## Storage

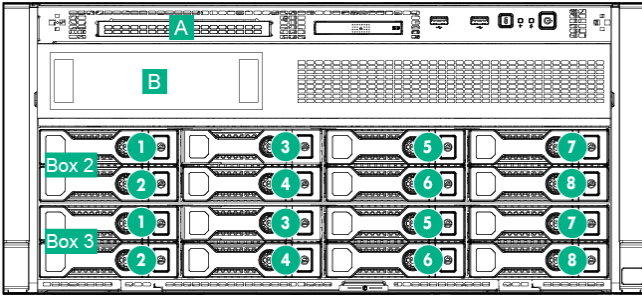

40 SFF hot-plug drives with 6 SFF NVMe SSD

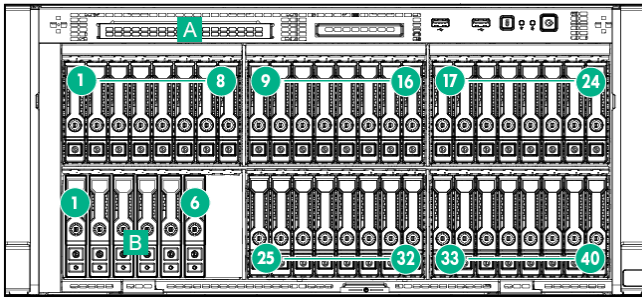

- A Optional Slim DVD-ROM/DVD-RW
- B 1 SFF Express Bay to support 6 x SFF PCIe NVMe SSDs
- 1-5 8 x SFF SATA/SAS/SSD Hot Pluggable Hard Drive Bays  
Image shown a ML350 Gen9 Rack model

**NOTE:** For additional storage configuration guidelines, please see the ML350 Gen9 user guide at [http://h20628.www2.hp.com/km-ext/kmcsdirect/emr\\_na-c04431235-6.pdf](http://h20628.www2.hp.com/km-ext/kmcsdirect/emr_na-c04431235-6.pdf)

**NOTE:** For maximum storage capacity information with different types of drives installation, refer to the "Standard Features" section in this document.

**NOTE:** For drive options and part numbers supported by ML350 Gen9, refer to the "Core Options" section in this document.

**NOTE:** For controller options and part numbers supported by ML350 Gen9, refer to the "Additional Options" section in this document.

## Technical Specifications

<b>System Unit</b>	<b>Tower Dimensions</b>	18.27(H) x 8.62(W) x 30.28(D) in (46.4 x 21.9 x 76.9 cm)	
	<b>Rack Dimensions</b>	8.58(H) x 17.51(W) x 29.37(D) in (21.8 x 44.5 x 74.6 cm)	
	<b>Tower Weight</b>	Minimum:	66.14lb(30kg)
		Maximum:	121.30lb (55kg)
	<b>Rack Weight</b>	Minimum:	57.3lb(26kg)
		Maximum:	112.4lb(51kg)
	<b>Input Requirements</b>	Range Line	100 to 120 VAC
		Voltage	200 to 240 VAC
	<b>BTU Rating</b>	Maximum	For 1400W Power Supply: 5459 BTU/hr (at 200 VAC), 5459 BTU/hr (at 240 VAC), 5459 BTU/hr (at 240 VAC) for China Only
			For 800W Power Supply: 3207 BTU/hr (at 100 VAC), 3071 BTU/hr (at 200 VAC), 3112 BTU/hr (at 240 VAC) for China Only
<b>Power Supply Output</b>	Rated Steady-State Power	For 1400W Power Supply: 1400W (at 240 VAC), 1400W (at 240 VAC)	
		For 800W Power Supply: 800W (at 100 VAC), 800W (at 240 VAC), 800W (at 240 VAC) input for China only	
<b>System Inlet Temperature</b>	Standard Operating Support	For 500W Power Supply: 500W (at 100 VAC), 500W (at 240 VAC), 500W (at 240 VAC) input for China only	
		For 1400W Power Supply: 1400W (at 200 to 240 1VAC), 1400W (at 240 VAC) input for China only	
<b>System Inlet Temperature</b>	Non-operating	For 800W Power Supply: 800W (at 100 to 127 VAC), 800W (at 200 to 240 1VAC), 800W (at 240 VAC) input for China only	
		For 500W Power Supply: 500W (at 100 to 127 VAC), 500W (at 200 to 240 VAC), 500W (at 240 VAC) input for China only	

## Technical Specifications

<b>Relative Humidity</b>	Operating	Minimum to be the higher (more moisture) of -12°C (10.4°F) dew point or 8% relative humidity. Maximum to be the lower (less moisture) of 24°C (75.2°F) dew point or 90% relative humidity.
	Non-operating	5 to 95% relative humidity (Rh), 38.7°C (101.7°F) maximum wet bulb temperature, non-condensing.
<b>Altitude</b>	Operating	3050 m (10,000 ft). This value may be limited by the type and number of options installed. Maximum allowable altitude change rate is 457 m/min (1500 ft/min).
	Non-operating	9144 m (30,000 ft). Maximum allowable altitude change rate is 457 m/min (1500 ft/min).
<b>Acoustic Noise</b>	Listed are the declared A-Weighted sound power levels (LWAd) and declared average bystander position A-Weighted sound pressure levels (LpAm) when the product is operating in a 23°C ambient environment. Noise emissions were measured in accordance with ISO 7779 (ECMA 74) and declared in accordance with ISO 9296 (ECMA 109).	
	<b>Idle</b>	
	L WAd	3.6 Bels (1P LFF Entry) 3.5 Bels (1P SFF Base) 3.6 Bels (2P SFF E-star Rack) 3.4 Bels (2P SFF E-star Tower)
	L pAm	21 dBA (1P LFF Entry) 21 dBA (1P SFF Base) 20 dBA (2P SFF E-star Rack) 19 dBA (2P SFF E-star Tower)
	<b>Operating</b>	
	L WAd	3.7 Bels (1P LFF Entry) 3.6 Bels (1P SFF Base) 4.5 Bels (2P SFF E-star Rack) 4.5 Bels (2P SFF E-star Rack)
	L pAm	21 dBA (1P LFF Entry) 22 dBA (1P SFF Entry) 28 dBA (2P SFF E-star Rack) 28 dBA (2P SFF E-star Tower)
	<b>NOTE:</b> Configurations tested for 1P LFF Entry models included two (2) 500GB LFF SATA Midline HDD and Windows 2012 Enterprise 64-bit.	
	<b>NOTE:</b> Configurations tested for 1P and 2P SFF models included two (2) 500GB SFF SATA Midline HDD and Windows 2012 Enterprise 64-bit.	
	<b>NOTE:</b> The Listed sound levels apply to standard shipping configurations. Additional options may result in increased sound levels.	
<b>Emissions Classification</b>	FCC Rating	Class A
	Normative Standards	CISPR 22; EN55022; EN55024; FCC CFR 47, Pt 15; ICES-003; CNS13438; GB9254; K22;K24; EN 61000-3-2; EN 61000-3-3; EN 60950-1; IEC 60950-1
	<b>NOTE:</b> Product conformance to cited product specifications is based on sample (type) testing, evaluation, or assessment. This product or family of products is eligible to bear the appropriate compliance logos and statements.	

<b>HPE Dynamic Smart Array B140i Controller</b>	<b>Number of PCI links</b>	Four
	<b>PCI link rate</b>	4Gb/s

## Technical Specifications

<b>Storage protocol support</b>	SATA
<b>SAS/SATA peak data transfer rate</b>	6Gb/s
<b>Number of SAS/SATA links</b>	10 links
<b>SAS/SATA connectivity</b>	2x4 connectors; 2x1 connectors
<b>Expander support</b>	No
<b>Drives supported (max)</b>	Up to 10 Internal Drives
<b>RAID support</b>	0, 1, 10, 5 SATA
<b>Software management</b>	HPE SSA, SMH, SIM
<b>Warranty</b>	Server warranty
<b>HPE Secure Encryption license</b>	Not Supported
<b>HPE SmartCache License</b>	Not Supported
<b>HPE Smart Storage Administrator</b>	Supported

---

<b>HPE Ethernet 1Gb 4-port 331i Adapter</b>	<b>Network Interface</b>	10Base-T/100Base-TX/1000Base-TX		
	<b>Compatibility</b>	IEEE 802.3 10Base-T IEEE 802.3ab 1000Base-T IEEE 802.3u 100Base-TX		
	<b>Data Transfer Method</b>	PCI Express, two lanes (x2)		
	<b>Controller</b>	BCM5719		
	<b>Network Transfer Rate</b>	10Base-T (Half-Duplex)	10 Mb/s per port,	40 Mb/s combined
		10Base-T (Full-Duplex)	20 Mb/s per port,	80 Mb/s combined
		100Base-TX (Half-Duplex)	100 Mb/s per port,	400 Mb/s combined
		100Base-TX (Full-Duplex)	200 Mb/s per port,	800 Mb/s combined
		100Base-TX (Half-Duplex)	1000 Mb/s per port,	4000 Mb/s combined
		100Base-TX (Full-Duplex)	2000 Mb/s per port,	8000 Mb/s combined
<b>Connector</b>	RJ-45			
<b>Cable Support</b>	10 Base-T	Categories 3, 4 or 5 UTP; up to 328 ft (100 m)		
	10/100/1000 Base-TX	Category 5 or higher UTP; up to 328 ft (100 m)		

## Technical Specifications

---

**Environment-friendly Products and Approach****End-of-life Management and Recycling**

Hewlett Packard Enterprise offers end-of-life product return, trade-in, and recycling programs, in many geographic areas, for our products. Products returned to Hewlett Packard Enterprise will be recycled, recovered or disposed of in a responsible manner.

[http://www8.hp.com/us/en/hpe/hp-information/livingprogress/environmentalprogress/product-recycling.html#.V-IPA\\_krKiM](http://www8.hp.com/us/en/hpe/hp-information/livingprogress/environmentalprogress/product-recycling.html#.V-IPA_krKiM)

The EU WEEE directive (2002/95/EC) requires manufacturers to provide treatment information for each product type for use by treatment facilities. This information (product disassembly instructions) is posted on the Hewlett Packard Enterprise web site. These instructions may be used by recyclers and other WEEE treatment facilities as well as Hewlett Packard Enterprise OEM customers who integrate and re-sell Hewlett Packard Enterprise equipment.

[http://www8.hp.com/us/en/hpe/hp-information/livingprogress/environmentalprogress/product-recycling.html#.V-IPA\\_krKiM](http://www8.hp.com/us/en/hpe/hp-information/livingprogress/environmentalprogress/product-recycling.html#.V-IPA_krKiM)



## Summary of Changes

Date	Version History	Action	Description of Change
13-Feb-2017	From Version 21 to 22	Added	Added new HDD and SSD offering to the HPE Drives section.
		Changed	HPE StoreVirtual VSA content was revised.
28-Nov-2016	From Version 20 to 21	Added	Added new Hard Drives offering.
		Changed	Maximum Internal Storage and HPE Storage Options were revised.
		Removed	Obsolete SKUs were removed from the QuickSpecs.
28-Oct-2016	From version 19 to version 20	Removed	Obsolete Hard Drives were removed from the QuickSpecs.
26-Sep-2016	From Version 18 to 19	Added	Added new SATA & SAS LFF HDD offering and 16Gb/32Gb FC HBAs. Added new 128GB LRDIMM memory.
		Changed	Standard features was revised to reflect the system support with the new option offering eg. 128GB DIMM, max memory capacity 3TB, etc. What's new and memory table were updated.
15-Aug-2016	From Version 17 to 18	Added	Added new Networking and Storage option offering.
		Changed	PCIe expansion slot 5 support revised to support FH/HL cards in Standard Features section.
		Removed	Removed K4200 & K5200 from the Computation and Graphics Accelerators section along with a few PCIe workload accelerators for option EOL.
24-Jun-2016	From Version 16 to 17	Changed	Expansion Slot 5 under the Standard Features section was revised.
6-Jun-2016	From Version 15 to 16	Added	New option offering incl. NVIDIA Quadro M2000, 340GB M.2 kits, LTO-7, new HDD options, dual 32GB micro-SD USB kit, RDX 3TB.
		Changed	Updated 2400MHz memory table in the Standard Features section. Updated memory speed, memory configuration guidelines in the memory section. Added notes to the storage section.
		Removed	Removed EOL drive options.
22-Apr-2016	From Version 14 to 15	Changed	Part numbers for the E5-2600v4 Smart Buy Models in the NA version were revised.
8-Apr-2016	From version 13 to 14	Changed	HPE Processors section was revised.
31-Mar-2016	From version 12 to 13	Added	New E5-2600 v4 CPU, new 2400MHz DIMM, new M4000 & M5000 GPU, new networking cards, TPM2.0 and new drives added. Added mechanical features for HW security: padlock, Kensington lock. Added new E5-2600 v4 BTO SKUs.
		Changed	Internal Storage Devices, Upgradeability, Embedded Management, Service and Support, Pre-configured Models, HPE Security, HPE Tape Backup, and Memory sections were revised.  Storage section - added additional front views of different storage configuration among HDD/SSD, SFF/LFF media cage, NVMe SSD.

## Summary of Changes

		Removed	Obsolete SKUs were removed from the QuickSpecs.
26-Feb-2016	From Version 11 to 12	Removed	340GB M.2 options (835563-B21 & 835565-B21) were removed from Core Options.
16-Feb-2016	From version 10 to 11	Added	New 12G SAS Drives and M.2 offering was added to HPE Drives.
1-Dec-2015	From version 9 to 10	Added	New HDD offering was added to HPE Drives.  New options added to HPE Unique Options, HPE Security, HPE Tape Backup, and HPE Disk Storage Systems.
		Changed	On System Management Chipset, Maximum Internal Storage, Embedded Management, and Server utilities were revised.  Product images were updated.
		Removed	Obsolete SKUs were removed from the QuickSpecs.
16-Nov-2015	From version 8 to 9	Added	New Solid State Drives offering was added to HPE Drives.
		Changed	Maximum Internal Storage, and Additional Options were updated. X4 RPS Enablement Kit note was updated. iLO FW updated to iLO4 2.3
17-Aug-2015	From version 7 to 8	Added	New Solid State Drives offering was added to HPE Drives.  New graphic options were added to HPE Computation and Graphics Accelerators.
		Changed	Memory, Maximum Internal Storage, and Additional Options were updated.
		Removed	Obsolete SKUs were removed from QuickSpecs.
1-Jun-2015	From version 6 to 7	Added	New Hard Drives were added to QuickSpecs.  New RDX+ external backup options were added.
		Changed	Number of fans for Energy Star Models and Performance Models were revised.  HPE Memory was revised.
		Removed	Obsolete SKUs were removed from QuickSpecs.
30-Mar-2015	From version 5 to 6	Added	New Hard Drives offering.  Optional Software added to HPE Storage Controllers.
		Changed	HPE Power Supplies, HPE Storage Controllers, HPE Disk Storage Systems, Micro SD Options were updated.
9-Feb-2015	From version 4 to 5	Added	Added new HPE Drives, HPE Disk Backup, and new G4 UPS models.  HPE Drives, HPE Computation and Graphics Accelerators, HPE Tape Backup, HPE Rack Mount Consoles, KVM Switches, and Keyboards, and HPE Uninterruptible Power Systems (UPS) sections were revised.

## Summary of Changes

1-Dec-2014	From version 3 to 4	Changed	Changes made throughout the entire QuickSpecs.
13-Oct-2014	From version 2 to 3	Added	6G SATA Enterprise Value G1 Solid State Drives were added to Core Option section.  High Performance Clusters, HPE PCIe Workload Accelerator Options, HPE USB and SD options, and HPE Care Pack Services were added to the Additional Options section.
		Changed	Standard Features, Optional Features, Core Options, Additional Options, and Memory sections were revised.
19-Sep-2014	From Version 1 to 2	Changed	Changes made throughout the entire QuickSpecs.



[hpe.com/qref/ml350gen9](http://hpe.com/qref/ml350gen9)



**Sign up for updates**

© Copyright 2017 Hewlett Packard Enterprise Development LP. The information contained herein is subject to change without notice. The only warranties for Hewlett Packard Enterprise products and services are set forth in the express warranty statements accompanying such products and services. Nothing herein should be construed as constituting an additional warranty. Hewlett Packard Enterprise shall not be liable for technical or editorial errors or omissions contained herein.

Intel® and Xeon® are registered trademarks of Intel Corporation in the U.S. and other countries.

Microsoft®, Windows®, and Windows Server® are U.S. registered trademarks of the Microsoft group of companies.

For hard drives, 1GB = 1 billion bytes. Actual formatted capacity is less

c04346270 - 15035 - Worldwide - V22 - 13-February-2017

