

www.signupdate.co.uk

# SignUpdate

MAY/JUNE 2017 ISSUE 171 £2.50

CNC PRINT LASER WATER

“The professionals choice for engraving,  
sign making, fabrication and woodworking!”

MAXICAM M3  
PROFESSIONAL CNC ROUTER



**MAXICAM**  
CUTTING EDGE TECHNOLOGY

Contact our team now:  
T: +44 (0) 845 689 0294  
E: sales@maxicamuk.com  
www.powell-cnc.com



# FLEX FACE SIGN BOX SOLUTIONS

From the Nation's Leading Aluminium Sign Systems Supplier

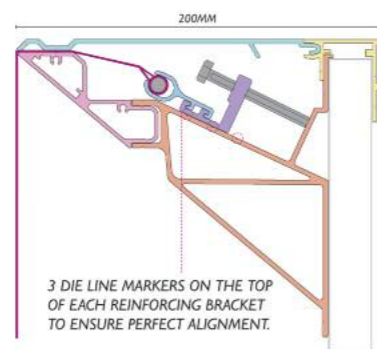

## NOVAFLEX

A robust single sided, full perimeter tensioning system which comfortably produces large flex face light boxes. The system uses a rod and puller method and can be rapidly tensioned from the front using power tools creating wrinkle free images every time.

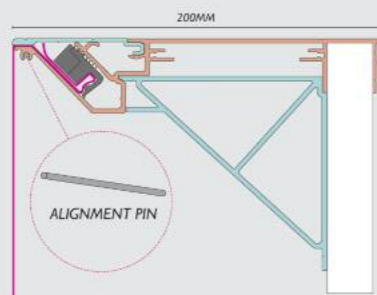

## NOVACOMP

Incorporating the popular black clip tensioning system NovaComp is available at both 135mm and 200mm depths. Light boxes are competitively produced in all shapes and sizes and can be delivered to site or your premises.

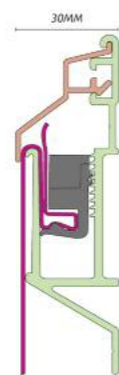

## SIGNCOMP FRAME

Non-illuminated framing system for flex face signage which utilises the industry familiar black clip tensioning procedure. Perfect for low cost flex face signage and for use with the NovaTube overhead lighting system.

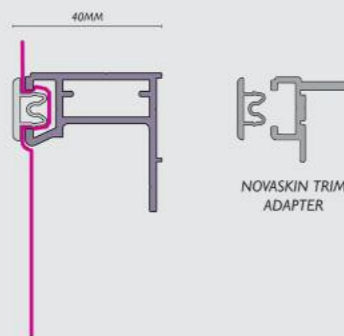

## NOVASKIN

An innovative framing system which brings flex face competitively to the High Street. The system also incorporates a bead adaptor for use with standard light boxes.



Published by **SignUpdate** Ltd

www.signupdate.co.uk

Allens Orchard, Chipping Warden, Banbury, Oxon, OX17 1LX.

## CONTENTS

5	<b>Welcome page</b>
8	<b>Product news and updates</b>
26	<b>Digital signage feature</b>
36	<b>Product choice</b> Who's using what and signage solutions
42	<b>Digital printing feature</b>
52	<b>Project news</b> Sign and graphic display companies showcase their work
64	<b>Sign news</b> Events, business and enterprise, and people in the industry
74	<b>Classifieds</b> Businesses and equipment for sale Job vacancies
85	<b>Buyers Guide</b>

Advertising Manager - **Martin Hinchliffe**.....Tel: 01784 605 601  
email: martin@signupdate.co.uk

Editor - **Kathryn Johnson**.....Tel: 01784 605 602  
email: editor@signupdate.co.uk

Features Editor - **Jemima Codrington** .....Tel: 07772 516 227  
email: jemimac@signupdate.co.uk

Graphic Design - **Tony Hinchliffe**.....Tel: 01784 605 601  
email: tony@signupdate.co.uk

Accounts - **Linda Hinchliffe**.....Tel: 01784 605 601  
email: linda@signupdate.co.uk

Publisher - **Roger Hinchliffe**.....Tel: 01784 605 601  
email: roger@signupdate.co.uk

**Subscriptions** - Annual subscriptions are £14.00 including postage and packing • Europe €28 • Rest of world £28

Send Cheques and postal orders made payable to Sign Update Ltd to:

Subscriptions Department, Sign Update Ltd., Allens Orchard, Chipping Warden, Banbury, Oxon OX17 1LX

### PRODUCTS AND EDITORIAL SUBMISSIONS

Sign Update welcomes news and information relating to new and improved products for possible coverage within the news and review pages. Sign Update however accepts no obligation to provide coverage or return unsolicited products which are sent to it.

Sign Update is always delighted to receive correspondence hints and tips for articles which should be sent in the first instance in outline form, together with the author's name and address. Manuscripts, photographs and other materials will not be returned unless accompanied by a stamped address envelope. No responsibility is accepted for any unsolicited materials. Sign Update takes every effort to ensure the accuracy of the contents of the magazine and takes all reasonable care in accepting advertisements for publication, but makes no representation as to their accuracy or quality.

Sign Update or its agents accept no liability whatsoever for any claim or complaint from any contributor or third party as a result of any advertisement or editorial coverage. Sign Update gives no warranty as to the accuracy or validity of any claim made in the magazine or in any advertisement including any relating to the specification or originality of any goods or services. Advertisements are accepted only on the basis that the advertiser indemnifies the publisher or his agents against any claim brought by a third party for infringement or alleged infringement of its rights or any defamatory or derogatory statements or claim.



Prices from  
£8,495 ex. VAT  
including delivery  
&  
installation  
&  
5 years on site  
warranty

100% designed and  
manufactured in  
Europe

- Standard sizes up to 2.2m wide and 7m long
- Custom sizes available
- Mount on any flat media up to 60mm thick
- Optional end cutter
- Allows single operator mounting
- Eliminates bubbles and creases
- Operate from either side

Josero Limited  
Tel: +44 (0) 1954 232564  
Email: info@josero.com  
www.josero.com









## 3M introduces blade-free installation

3M's new Knifeless Tape Technology enables car wrappers and installers to cut through graphic film with sharp, clean lines and curves without the need for a blade. Knifeless Tape Technology from 3M takes all the worry out of cutting and trimming during installation, says the company.

3M is launching a range of knifeless tapes that incorporate patented technology, which uses a filament embedded in the centre of the tape for cutting adhesive films, after they acquired Knifeless Tech Systems. The film is placed over the knifeless tape and cutting is achieved by pulling the filament up through the film. The tapes are both flexible and blade-free, which allow installers to quickly cut graphic film, along the contours of the surface, with precision and without risk of damaging the film surface.

"The addition of 3M Knifeless Tapes to the range of innovative graphic films and installation tools we offer underlines our commitment to supporting 3M customers and making their installations as simple, quick and worry-free as possible," says Christian Stoehr, Portfolio Manager West Europe, 3M Commercial Solutions Division.

### The range includes:

#### Classic series

It easily follows the contours and curves of any vehicle and is ideal for new knifeless installers. 3M Bridge Line Knifeless Tape creates evenly cut graphics bridging from one panel to the next for a professional finish. It is used to create uniform cuts in wide gaps between doors, bumpers and rubber mouldings.

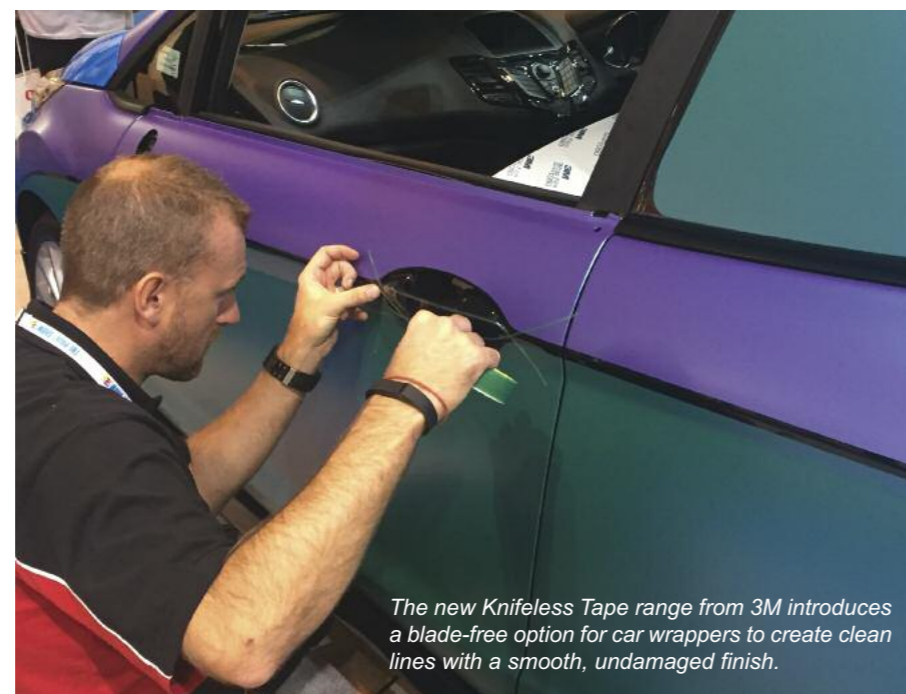

The new Knifeless Tape range from 3M introduces a blade-free option for car wrappers to create clean lines with a smooth, undamaged finish.

#### Design series

The tape is engineered to create highly contoured designs with sharp, clean edges, and is ideal for creating stripes and accents. 3M Tri-Line Knifeless Tape is a unique triple-lined tape that ensures an accurate, consistent stripe width from one end of the car to the other and is ideal for pinstripes, gaps and butt seams.

All 3M Knifeless Tapes are supplied in resealable, single roll pouches for easy

storage and to prevent tape damage from dust and dirt.

Training is vital to the success of any film installation, and that applies to the new 3M Knifeless Tapes, which have been added to the 3M Endorsed Training Programme.

[www.3mgraphics.com](http://www.3mgraphics.com)  
[www.3Mgraphics.com](http://www.3Mgraphics.com)

## William Smith's new "game changing" product



The new Arlon SLX Cast Wrap with FLITE Technology is available to order from William Smith.

Arlon SLX™ Cast Wrap with FLITE Technology™ is a 50 micron premium gloss white repositionable cast film designed for the single installer. It is ideal for full and partial vehicle and fleet applications, and a good choice for both novice and experienced installers, says the company.

FLITE Technology is a light contact system that allows graphics to float over a substrate until firm pressure is applied. It "guarantees the fastest installation while ensuring long-term bond, conforming effortlessly around rivets, complex curves and deep channels".

SLX Cast Wrap has a tinted, permanent pressure-sensitive adhesive providing excellent opacity, while also offers a vibrant and reliable print quality. The low profile, air egress liner aids with easy installation, resulting in a smooth finish, according to William Smith.

"We are delighted to be able to offer our customers the option of using this game-changing product," said William Smith's Head of Marketing, Chris Bradley.

"We believe the combination of its easy installation, fantastic print quality and seven-year durability will appeal to all wrappers."



## Ashby Plate Signage System

Vinyl Faced Signs from £8.36

### Key Facts:

- 3mm Aluminium Sheet
- No Minimum Size
- 24 Vinyl laminates from stock
- High & Engineering grade reflective options
- Internal & external use
- Cost effective signage
- Durable & Low maintenance
- Grey backed as standard

Vinyl laminated Ashby Plate products are available on a **next day despatch**, so you don't have to wait around for your signage.

Tel: 0118 981 5343

8:00am - 7:00pm, Monday to Friday

[sales@ashbytrade.co.uk](mailto:sales@ashbytrade.co.uk)

[www.ashbytrade.net](http://www.ashbytrade.net)





## Antalis expands range

Antalis have had a busy start to the year, by adding nine new products to their sign and display range.

Their Coala non-woven wall design range has been extended with seven new creative finishes: fibre, canvas, fine canvas, stucco, leather, brush and plaster. These are "ideal for creating everything from personalised murals through to decorative wall covering for hotels and offices".

Coala Flamestop is a fire-rated roller banner pop up display, available in 200mic and 500mic, which can be used for exhibitions and conferences where fire-retardant signage is necessary. This is in addition to Coala Floor R, a slip rated and fire-rated laminate range that can be used for floor and wall graphics.

Their Drytac range of adhesive-coated products has been increased with the new Drytac Polar Carpet and Drytac Anti-Microbial Laminate. Drytac Polar Carpet can be

applied on short pile carpet while being easily removable after short-term use, making it ideal for trade fairs, point of sale or furniture stores. Drytac Anti-Microbial Laminate features a durable anti-bacterial additive designed to prevent the growth and spread of bacteria; an important benefit when used in restaurants, hospitals or any other sectors where optimised hygiene is important.

The Antalis Foamalite Xpress Filmed and Foamlite Black Filmed ranges of PVC foam sheet have been extended to include 10mm, enabling greater rigidity for more arduous signage applications.

They've also expanded their Printbond aluminium composite range with the introduction of a thicker 0.3mm skin, perfect for more demanding jobs, while also adding five new sizes and thickness to its PVC range.

Chris Green, channel head for Sign and Display at Antalis, said: "As a business committed to remaining on the pulse of

As a business committed to remaining on the pulse of innovation, we are always looking for new ways in which to help customers achieve even the most complex signmaking and display requirements.

innovation, we are always looking for new ways in which to help customers achieve even the most complex signmaking and display requirements. Be it hospital signage where hygiene optimisation is paramount, through to a custom designs for hotels, and everything in between."

[www.antalis.co.uk](http://www.antalis.co.uk)



Antalis have added nine new products to their large sign and display range.

**VISTECH**<sup>TM</sup>  
TECHNICAL SERVICES

AFFORDABLE  
SERVICING

ROLAND, MIMAKI, MUTOH



Call **07777 696019** for more information now!



01202 630091



[info@vts-service.co.uk](mailto:info@vts-service.co.uk)



[www.vts-service.co.uk](http://www.vts-service.co.uk)





## Flexible, magnetically-receptive self-adhesive films

ASLAN has launched its new range of FerroSoft films, with three new magnetically-receptive solutions that are particularly user-friendly, says the company.

The new films are "extremely soft and flexible", which make them easy to apply. Another benefit is that all three finishes can be stored and transported in a rolled-up condition. The self adhesive ferrous films come with three different finishes: digital printable, whiteboard and anthracite coloured.

The new FerroSoft films can transform any smooth substrate into a magnetically-receptive surface, like the existing ferrous films from the ASLAN memo board portfolio. The flexible films also lend themselves perfectly to creative customisation, says ASLAN. They can be cut to any imaginable shape or size, and can be used as organisational boards, communications surfaces or even background graphics for magnetic, changeable advertising messages.

FerroPrint ASLAN FF 480, the new printable variant in matt white, can be printed with solvent, eco-solvent, UV-curing and even latex inks. This means any desired printed image can be made magnetically-receptive. Combined with ASLAN's transparent blackboard and whiteboard films, printed graphics can also be written on with chalk or whiteboard markers.



FerroSoft Whiteboard film.

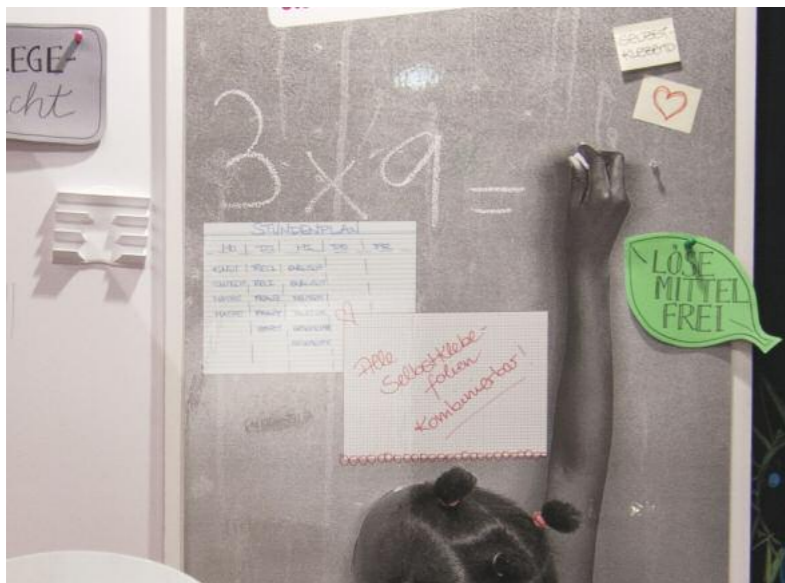

FerroSoft Print film.

The new FerroSoft Whiteboard ASLAN FF 550 film, in glossy white, offers a ready-made two in one solution, which combine the magnetic function with the ability to be written on and wiped clean like a whiteboard. This lets users create a high-quality, multi-functional communications surface in just a single pass. The anthracite-coloured FerroSoft ASLAN FF 410 film is designed to be freely combined with other self-adhesive films, which creates customised whiteboard, blackboard or coloured surfaces that are magnetically-receptive.

The new self-adhesive FerroSoft films conform to REACH and available immediately in a 12m x 1.01m format.

[www.ASLANSchwarz.com](http://www.ASLANSchwarz.com)

## Spandex expands its ImagePerfect portfolio

Spandex is adding seven new textile substrates specifically designed for latex, solvent and UV printers to its ImagePerfect range of materials.

These new substrates complement the existing ImagePerfect portfolio, which offer sign makers and graphics producers a choice of 21 textile materials compatible with existing latex, solvent or UV printers.

ImagePerfect 2329

Display offers lay-flat hanging, making it perfect for display frames, pop-up systems, soft furnishings, banners and interior décor



ImagePerfect textiles- Interior applications

**ImagePerfect 2326 Display Grey Back** is a curl-free blockout material, making it ideal for roll-up applications as well as display frame systems, backdrops and banners.

**ImagePerfect 2327 Backlit** is a fine woven fabric with a special light diffusion back coating for light boxes. It can also be used for other applications such as inflatables, shower curtains and banners.

**ImagePerfect 2328 Display Satin** offers the user a choice of two printable sides, one matt and the other satin. With its soft feel, it can be used for display frame systems, pop-up display systems, table cloths and banners.

**ImagePerfect 2330 Canvas Banner** is optimised for use for canvas frames, art reproduction, roll-up display systems, wall coverings and banners.

**ImagePerfect 2329 Display** offers lay-flat hanging, making it perfect for display frames, pop-up systems, soft furnishings, banners and interior décor.

**ImagePerfect 2331 Banner Grey Back** is designed for indoor and outdoor use and is also 100 per cent recyclable. It can be used for wall coverings, curtains, banners and other interior décor applications.

The new ImagePerfect textiles range offer fray-free performance and are suitable for cold knife cutting and sold up to 3.2m in width. A number of the textiles also offer crease free or crease resistant properties and are fire rated.

[www.spandex.com](http://www.spandex.com)



ImagePerfect textiles -Backlit illuminated graphics



## Awltech PVC-bending machine

A new PVC-bending machine has been added to the range of specialised plastics fabrication, flame and diamond-edge polishing and heat-bending solutions supplied by Awltech. With many new features, the semi-automatic AFF machine will help speed up the processing of a wide variety of plastic materials, such as PVC, PMMA, PP and PS, used in the sign manufacturing and plastics fabrication industries, says the company.



The Awltech PVC bending machine, with many new features.

Single or multiple sheets of material can be processed simultaneously by the machine

Key design features of the machine include an adjustable working height function; a powerful vacuum hold-down facility that keeps the material being processed firmly in place during the heating, bending and cooling cycle; and an integrated clamping bar in the upper frame of the machine housing an electronically-controlled heater. This is fully adjustable to control both the level of heat generated and the heating time required using a foot-operated switch. The AFF is also supplied on a purpose-built wheel-mounted table to be manoeuvred easily.

The thickness of the materials that can be processed ranges from 0.2 to 1.5mm, while the angle of the bend is adjustable from 0-180 degrees. The material being processed is contact heated using a Teflon-coated sword that is easily replaceable to accommodate different-sized profiles; and to enable the radius of the bend to be varied to meet specific requirements. Single or

multiple sheets of material can be processed simultaneously by the machine.

The AFF PVC-bending machine can be viewed at the Awltech showroom situated in the Omni Business Centre on the Omega Park in Alton, Hampshire.

[www.awltech.co.uk](http://www.awltech.co.uk)

## PPB Ltd adds new 3A Composite cast acrylic sheets to range



CRYLUX® ARGENTA cast acrylic sheets from 3A Composite, available from PPB.

Special colours and characteristics make sure that CRYLUX® ARGENTA cast acrylic stands out from other acrylic materials, says PPB. It has a "unique metallic look and fascinating depth effect that grabs the attention". Argenta's two different surfaces offer many creative opportunities: the front side is sparkling coloured and is characterised by a gloss and depth effect; while the metallic silver reverse side provides an opaque appearance.

This cast acrylic is ideal for applications that combine innovative interior design concepts with various manufacturing and surface processing methods, including thermoforming, according to the company. Applications

include luxurious POS/POP displays, quality shop fittings, interior design, furniture, lighting and signage.

Richard Proctor, Managing Director for PPB, said: "We added the Polycasa range to our industrial plastics range recently, and are delighted to add the new colourful and eye-catching Argenta range. Both Polycasa and Argenta offers the chance to use self-coloured materials from stock rather than having to try and print plain white sheets to try and create the same finish. This reduces the time taken/costs of producing a job, and for brand owners also makes sure the same colour is achieved time after time."

## New patterns in 3M's DI-NOC range

William Smith stock all 80 patterns of the 3M DI-NOC decorative range, with customers able to order by the metre and for next day delivery. New Trend Line swatches will also be available for customers to view the array of patterns in a physical form.

The Trend Line range is regarded as another "bold statement" for William Smith, as it commits to invest in new architectural product ranges. They will also offer DI-NOC application training, to enable customers to learn how to apply the film and become an installer themselves.

Developed by 3M as a cost effective design solution for interior and exterior new building refurbishment projects, these vinyl films realistically recreate the visual effect of natural materials. DI-NOC Architectural Finishes offer a number of key benefits.

Lightweight and self-adhesive, they can be applied on site to existing substrates quickly and easily, with less likelihood of error and waste. Businesses can remain open during the DI-NOC application, in turn minimising disruption during a refurbishment. 3M DI-NOC films come with CE marking and EN 13501 fire certification.

"We believe DI-NOC is a pioneering product, within a lucrative market," says William Smith's Marketing Manager, Lindsay Appleton.

"As a result of launching the 3M Trend Line range, the key DI-NOC patterns will be a lot more accessible and readily available to supply new projects. By investing in stock, we can ensure there are no longer issues with supply times."

[lappleton@williamsmith.co.uk](mailto:lappleton@williamsmith.co.uk)

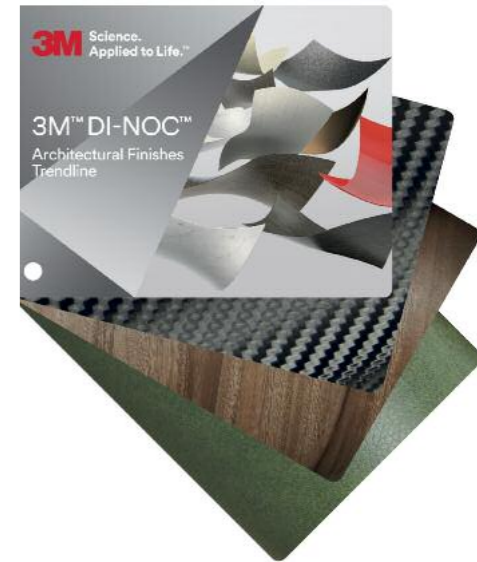

Swatches from the new Trend Line range of 3M DI-NOC vinyl films.

## Mimaki adds new printer to its small format flatbed range

Mimaki has added a new member to the UJF-MkII product family, its latest generation of small format UV flatbed printers. The UJF-3042MkII EX, which will be unveiled at FESPA 2017, combines four steps into one: delivering the ability to place primer for

strong ink adhesion, white ink for high print opacity, full colour CMYK printing and a clear print surface treatment, all in one operation. This has been made possible by the addition of a fourth print head and the ability to hold eight ink bottles.

The compressed workflow includes:

- Inkjet primer retains the texture of the material while printing, which is difficult to do with manual primer application. The Mimaki PR-200 primer can be used on resin, glass and metal materials.
- White ink with high opacity enables more vivid expression of full colour, especially on dark or transparent substrates. Two bottles of white ink can be attached to the printer to achieve high density white print in a shorter time with more opacity.
- Clear ink, with either glossy or matte effects can add texture and depth. Clear ink can be laid down in multiple layers for an embossed effect.
- The texture library as part of the Mimaki RasterLink6 RIP software offers 129 different textures that can be displayed as swatches in Adobe® Illustrator. Application of these textures with clear ink can deliver more elaborate designs, such as a floral motif or other patterns that add even more value to the printed piece.



The newest product in Mimaki's small format UV flatbed range, combines four steps into one.

[www.mimakieurope.com](http://www.mimakieurope.com)



## The first roll-to-roll printer built on new UVgel technology

Canon Europe has introduced the Océ Colorado 1640, the first 64" roll-to-roll wide format printer built on the "revolutionary" new Canon UVgel technology.

The UVgel technology has been developed by Canon to deliver "unprecedented productivity, matched with excellent output quality on a broad range of media for optimum applications versatility". Working with the attributes of UVgel, the Océ Colorado 1640 has been engineered to the highest industrial standards to produce high volumes of wide format graphics within short turnaround times, says the company.



*The Océ Colorado 1640 printer will have its first public presentation in EMEA at FESPA 2017, 8 -12 May 2017.*

Canon UVgel technology reduces ink consumption by as much as 40 per cent compared with competitive technologies, thanks to a more efficient way of jetting ink, says Canon.

### Productivity

The 1640 has a top speed of 159 m<sup>2</sup>/hr for applications such as billboards or outdoor banners; and at the highest level of quality for close-up indoor applications, the printer operates at a speed of 40 m<sup>2</sup>/hr.

Canon UVgel ink is instantly 'pinned' on contact with the substrate, which results in a highly controlled and precisely positioned dot with minimal gain. By minimising ink spread and coalescence on the media, the required volume of ink can be printed in each pass, delivering rich, intense images at high speed, says Canon.

The low temperature LED-UV curing system moves independently from the printing carriage, to enable uniform, post-print UV curing that further contributes to print speed and print quality. The cured UVgel prints are instantly dry and ready for finishing or laminating, ideal for businesses handling jobs that need fast turnaround and installation.

### Quality

The precise, instantly 'pinned' UVgel dot produces sharp images with minimal dot gain and virtually no satellites; while the stable, highly controlled dot ensures superb colour consistency from swathe to swathe.

Canon UVgel printheads incorporate patented continuous nozzle monitoring using acoustic sampling, to detect and correct any under performing nozzles, which "virtually eliminates white lines".

The printer's heavy, robust frame, rigidity and industrial components ensure the stable handling of media.

### Broad application range

The Océ Colorado 1640 is suitable for businesses producing both indoor and outdoor applications, including posters, banners, signage, POS, billboards, window graphics, decals and bespoke wall coverings.

UVgel is a low-heat process using LED curing, for minimal media distortion and extending the range of printable substrates, such as thin and heat-sensitive media. UVgel ink contains no water, which significantly reduces media swelling, improving dimensional consistency.

### Value

Canon UVgel technology reduces ink consumption by as much as 40 per cent compared with competitive technologies, thanks to a more efficient way of jetting ink, says Canon.

The printer's automation features reduce operator handling time, with a unique dual-roll media system to decrease the time required to load media.

[www.canon-europe.com](http://www.canon-europe.com)

Discover the new collection

# gli Unici



CUT AND PRINT VINYLs FOR WRAPPING AND DECORATIONS ON GLASS, SHOP-WINDOWS, WALLS, FABRICS AND INTERIOR DESIGN. **APA, AN UNMATCHED COLLECTION OF FILMS, EXCLUSIVE SERVICES AND ACCESSORIES.**

[www.apaspa.com](http://www.apaspa.com)



## Major enhancement for lightboxes with LED module

Germany-based Majert has added the latest CL-FLEXO model to the Chiplite CL Series of LED modules. It follows expansion of the company's third-generation CL-X Series and provides a "radically enhanced" illumination capability for lightbox installations.

A key design feature of the CL-FLEXO module is the specially developed 170-degree optical lens that enables shadow-free illumination of lightboxes with a depth of 40mm. By using a flexible circuit board rather than traditional wiring, there is no show-through of cables to the illuminated sign face. At a depth of 40mm, it is possible to create an 80 x 80mm grid that requires only 144 modules per square metre. The distance between each module on the circuit board is set at 80mm for ease of installation.

The size of each CL-FLEXO LED module is 35mm (depth) x 23mm (width), with the modules supplied in 4.8 metre-long rolls. Like with all Chiplite LED modules, the CL-FLEXO model carries RoHS (Restriction of Hazardous Substances) certification and a CE rating in accordance with BS EN 55015. It is also IP65 rated to BS EN 60529 that relates to the sealing effectiveness of electrical enclosures against the ingress of dirt and water and other contaminants.

Chiplite LED modules provide a wide choice of luminous flux, power consumption and optical efficiencies to accommodate virtually any lightbox or illuminated sign tray and lettering requirement, says the company.

[www.chiplite.de](http://www.chiplite.de)

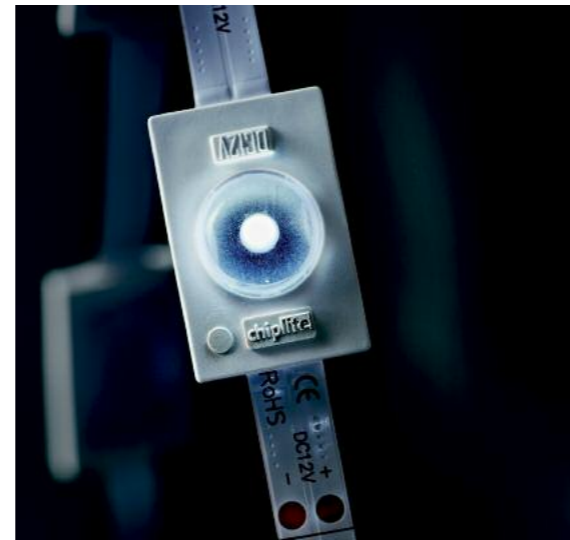

The CL-FLEXO model is the latest addition to Majert's Chiplite CL-X Series of LED modules.

## Mutoh adds new printer to its wide format dye sublimation range

Mutoh Belgium nv adds the new ValueJet 1604WX (VJ-1604WX) to its wide format dye sublimation printer line-up. This new single head high quality 64" (162 cm) wide budget friendly dye sublimation printer will suit those looking for a wider printer to increase their portfolio of digital transfer decoration, fashion and objects, says the company.

Standard delivered with a motorised 30 kg take-up system and professional RIP software, the printer is suited for volume production runs as well as short print runs of textile decoration and displays, textile banners, pop-ups, sportswear and personalised home decoration.

Engineered and made in Japan, the VJ-1604WX features a high level of operator comfort, print production efficiency as well as high print quality and precision, says Mutoh. The compact ValueJet 1604WX includes a variable drop eight channel print head, allowing output resolutions up to 1440 x 1440 dpi. The piezo print head is capable of firing drops from 3.5 pl up to 21 pl.

Delivering typical production speeds up to 22 m<sup>2</sup>/h at 360 x 1080 dpi (3 Pass), the ValueJet 1604WX will print on common dye sublimation transfer papers and can handle 2" and 3" core rolls.

The ValueJet 1604WX printer uses Mutoh's genuine DS2-series dye sublimation inks which are 100 per cent VOC free.

[www.mutoh.eu](http://www.mutoh.eu)



The new wide format dye sublimation printer from Mutoh is available now.

Whatever the sign...  
...We have the solution



The UK's No.1 selling LED sign light ideal for retail and brewery signage



- FULL OPTICAL CONTROL  
Choice of revolutionary lenses for optimum illumination
- FULL CERTIFICATION  
As required by The Electrical Equipment (Safety) Regulations 1994 all products tested by the The Lighting Association and compliant to BS4533 and EN60598



The innovative asymmetric Ecolux Super lens can illuminate up to 5m depths without the need for longer brackets

- FULLY RATED  
Products IP rated, thermally tested and certified



01922 721133



[www.portlandlighting.co.uk](http://www.portlandlighting.co.uk)



Portland Lighting Ltd



@PortlandLight



Units A2 & A3, Walsall Enterprise Park, Regal Drive, Walsall WS2 9HQ  
Fax: 01922 659545 Email: [sales@portlandlighting.co.uk](mailto:sales@portlandlighting.co.uk)



## Award-winning film “ideal” for short term campaigns

Perforated window films are the ideal way to create high-impact graphics for short term campaigns, branding windows or glass doors with the latest promotion, product launches or event marketing, says Contra Vision.

Award-winning Contra Vision® Campaign™, \* from Contra Vision, makes this option more cost effective and trouble-free for both client and printer.

Contra Vision® Campaign with Grayliner™ recently won a Product of the Year award at SGIA, the USA based, speciality printing and imaging technology association in Las Vegas.

Contra Vision® Campaign™, one of the latest additions to their range of perforated window films, was developed specifically for



Contra Vision® Campaign™ is ideal to use for short term campaigns and promotions.

shorter term campaigns and offers an economically priced perforated window film, while it retains the range's high performance characteristics.

Contra Vision® Campaign™, which is suitable for UV, solvent, eco-solvent and latex printing technologies, has a one-year dura-

bility rating, is REACH compliant, and features a high specification clean-remove adhesive.

Available in a wide range of transparencies, Contra Vision® Campaign™ is available with Contra Vision® Grayliner™, a patented improvement to perforated window films. This makes it easier to assess the final look of see-through graphics during the printing stage.

For longer-term and large scale applications, such as complete window coverage, building wraps, and vehicle applications, Contra Vision® Performance™ perforated window film is still the recommended choice.

For further information, prices and professional help in choosing the product most suited to your specific application, email George Howell at ghowell@william-smith.co.uk, for a simple guide, or to speak with a knowledgeable representative.

Contra Vision® Campaign with Grayliner™ recently won a Product of the Year award at SGIA, the USA based, speciality printing and imaging technology association in Las Vegas.



Contra Vision has added a new product to its range of perforated window films.

## First Artificial Intelligence-based vector drawing experience

CorelDRAW® Graphics Suite 2017 is the latest version of Corel's flagship graphics software that offers designers a new, hands-on creative experience that's "unlike any other" vector application. With LiveSketch™, hand-drawn strokes are intelligently interpreted, adjusted, and combined with existing vector curves, making it simple to sketch and draw directly on a pen-enabled device. This graphics solution is built specifically for Windows, and offers new work flow enhancements, plus support for the latest technologies such as advanced stylus and touch-enabled devices, the Microsoft Surface Dial, and Ultra HD 5K monitors.

"Right from the start, vector design software has forced artists to work in a world dominated by mathematics. When you train yourself to think in terms of geometric shapes, polylines, and Bezier curves, the design process can feel removed from where your creativity began; the simple joy of drawing," says Gérard Métrailler, Vice President of Global Products at Corel.

### Features include:

New LiveSketch™ tool: LiveSketch uses the power of a neural network to understand and deliver a natural vector drawing experience that replicates the feel of pen and paper. For the first time, users can free-form sketch vector curves directly on a pen-enabled device, thanks to an intelligent tool that interprets and understands sketching styles, such as overlapping strokes, folded lines, and even chicken scratches. LiveSketch also eliminates the time-consuming task of sketching on paper, scanning, and tracing to vector by enabling you to start your designs directly on screen.

Enhanced nodes, handles and vector preview: Each node type is assigned a unique shape, so you can quickly identify cusp,

smooth, and symmetrical nodes. Vector previews for nodes and curves have been enhanced to stand out against background colours in your design.

Powerful stylus enhancements: Enjoy a more natural drawing experience with native support for the Surface Studio, Surface Pen, and Surface Dial, plus advanced support for Wacom styluses and tablets.

Import legacy workspaces: Bring your earlier environments directly into the new CorelDRAW Graphics Suite 2017 and continue designing right where you left off. Reuse CorelDRAW and Corel® PHOTO-PAINT® workspaces that were created in versions X6, X7, and X8.

### CorelDRAW Graphics Suite 2017 includes

- CorelDRAW® 2017: Intuitive vector-illustration and page-layout application
- Corel® PHOTO-PAINT® 2017: Professional image-editing application
- Corel Font Manager™ 2017
- Corel® PowerTRACE® 2017: Bitmap-to-vector tracing utility (included in CorelDRAW 2017)
- Corel® CONNECT™ 2017: Access digital content in the Content Exchange and on a local computer
- Corel® Website Creator™: Website-design application
- Corel® CAPTURE™ 2017: One-click screen capture utility
- PhotoZoom Pro 4: Plug-in to export and enlarge digital images from Corel PHOTO-PAINT

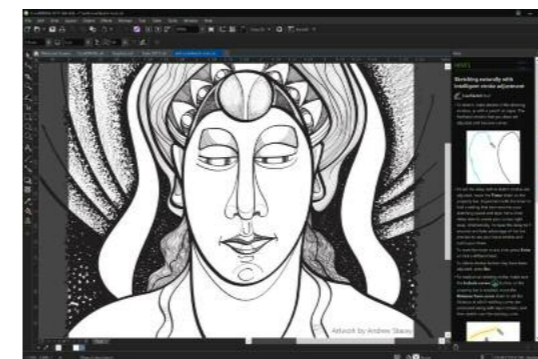

With the LiveSketch™ tool users can free-form sketch vector curves directly on a pen-enabled device, thanks to an intelligent tool that interprets and understands sketching styles.

CorelDRAW Graphics Suite 2017 also includes: 10,000 clipart and digital images; 2,000 high-resolution digital photos; over 1,000 fonts; 350 professionally designed templates; 2,000 vehicle templates; over 500 interactive frames and photo frames; over 600 fountain, vector and bitmap fills; expert insights, product hints, and over five hours of training videos.



Another new feature of CorelDRAW Graphics Suite is the enhanced node, handles and vector preview.

### Customers can choose from two flexible purchase options:

Perpetual license: make a one-time payment and license the product permanently; available as a box or download version

Subscription: pay a monthly or annual fee to use the product; upgrades to the latest version are included as long as your subscription is active

CorelDRAW Graphics Suite 2017 also gives perpetual license customers the option to sign up for the upgrade programme. This enables them to pay one affordable yearly fee and be assured of working with the latest design tools, file compatibility, and most current technology. As long as your account is active, you'll automatically receive the latest version when it's released.

Enterprise clients can take advantage of volume licensing options and maintenance, which offers benefits including network deployment and virtualisation.

CorelDRAW® Technical Suite 2017 coming soon.

Built on the power of our new CorelDRAW Graphics Suite 2017, CorelDRAW Technical Suite 2017 will deliver new enhancements to power the technical illustration work flow. CorelDRAW Technical Suite 2017 will be available in summer 2017. For a full list of everything included in CorelDRAW Graphics Suite 2017 and to download a free 15-day trial, please visit

www.coreldraw.com



## Protac Anti-Bacterial film is bacteria's worst new enemy!

Drytac Europe recently launched its Protac Anti-Bacterial film in Europe, the Middle East, and Asia.

The new product had its debut at Sign & Digital UK 2017 event on its UK distributor Antalis's stand.

Drytac Protac Anti-Bacterial film is a 150µ (6 mil) textured polyester laminating film with a durable antibacterial additive. It offers reliable protection from mould growth and bacterial contamination, such as MRSA, Streptococcus, E.coli and Salmonella. The laminating film is ideal for use in environments where hygiene is of particular importance, such as schools, nurseries, restaurants/cafeterias and hospitals, says the company.

Drytac Protac Anti-Bacterial film's textured finish gives it good resistance to abrasions, which makes it useful for exhibitions and POP displays; while its clarity ensures that no colours are diminished. It is resistant to chemicals and many common household cleaners, allowing for ease of cleaning in all applications.

The reverse side of Drytac Protac Anti-Bacterial is coated with a pressure-sensitive, solvent acrylic adhesive, protected with a

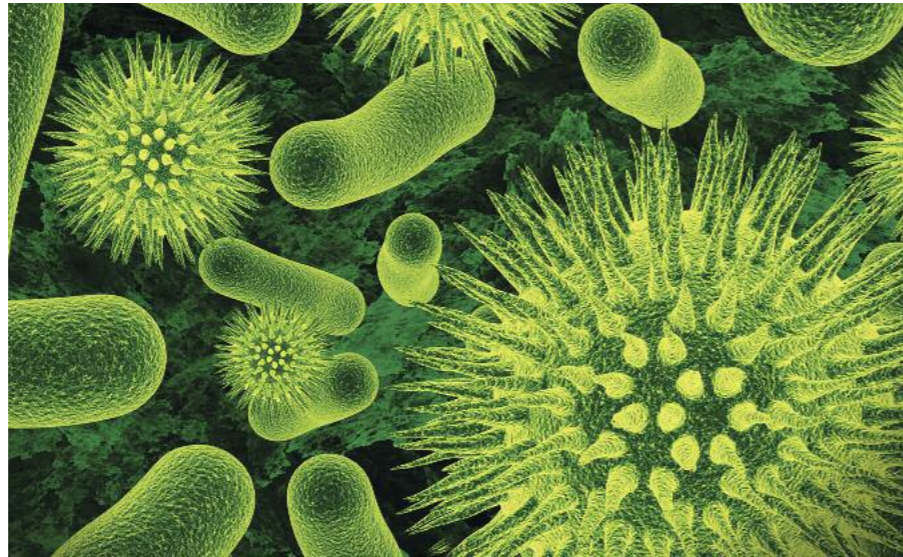

The laminating film protects against contamination from bacteria such as MRSA and E.Coli.

siliconised polyester release liner, for ease of application.

Steve Broad, Sales Director for Drytac Europe, said: "Drytac Protac Anti-Bacterial film is a high specification film with the antibacterial agents being within the film itself – not just added as a lacquered coating.

When the film is wiped clean, the antibacterial properties remain, which makes Protac Anti-Bacterial film the ideal choice for environments where cleanliness is essential."

[www.antalis.co.uk](http://www.antalis.co.uk)  
[www.drytac.co.uk](http://www.drytac.co.uk)



Drytac's anti-bacterial film is particularly suited to environments such as hospitals.

## HEMTEK ST **LEISTER** Banner Welding

- Ideal for hemming & joining of PVC materials
- Hems of 20, 30 or 40mm widths
- Operates at speeds upto 12metres/min
- Bench / table top mounted
- Simple single foot pedal controls



**Welwyn** TOOL GROUP  
 Tel: 01707 331111  
[info@welwyntoolgroup.co.uk](mailto:info@welwyntoolgroup.co.uk)

## Quality Castings Polyurethane - Aluminium - Bronze

SIR WILLIAM LANCASTER  
 1841 - 1929  
 CO-FOUNDER OF THE PUTNEY SCHOOL OF ART  
 MAYOR OF WANDSWORTH 1901 - 2



**BENENDE**



Call us we specialise!

SIGNS OF THE TIMES  
 — QUALITY CAST SIGNS —

T: 01525 874185  
[enquiries@sott.co.uk](mailto:enquiries@sott.co.uk) [www.sott.co.uk](http://www.sott.co.uk)



01509 323 800

Crown Norge - CNC Router Tools  
 for the professional



Quality CNC Router Tools  
 for the sign making  
 industry

A full range of tool / cutter sizes for Aluminium, ACM, Brass, Acrylic, Plastics, Wood and MDF ready for next day delivery

[www.regaltools.co.uk](http://www.regaltools.co.uk)



## Mimaki updates Tx300P-1800 Series

Mimaki is upgrading its Tx300P-1800 and Tx300P-1800B direct-to-textile printers, to make them simultaneously load both textile pigment and sublimation inks. This enables the use of a single printer to print directly onto a much wider range of textiles without the need to swap out ink systems. This previously unavailable, newly developed technology represents a breakthrough that will significantly improve productivity and increase flexibility for these textile printers, says Mimaki.

Mimaki have created the option to switch fabric types quickly and easily, by selecting the most appropriate ink system for each fabric. This was after they identified the demand for fast turnaround times, as well as short and bespoke production runs by customers in the textile, fashion and apparel markets. The enhanced system

also provides valuable environmental benefits by the removal of water or steaming from the post-treatment process.

Mimaki already offers five different ink types for textile printing: sublimation dye ink, dispersion dye ink, textile pigment ink, reactive dye ink and acid dye ink. In the normal course of operation, one ink per printer must be selected. Textile print producers will now be able to use the two most popular ink types in one single printer.

Both the Tx300P-1800 and Tx300P-1800B will have the capability to simultaneously load TP400 textile pigment ink for cotton and hemp materials; as well as Sb420 sublimation dye ink for polyester material.

Since neither ink type generally requires steaming or washing in the post-treatment process, there is no need for a large operational space, huge volumes of water, or special expertise in handling the printed

fabric. All that is required is the printer and colour fixing equipment, which make these entry-level printers suitable for use by designers, fabric workshops, and educational and research institutions, says the company.

### The details

Mimaki's TP400 textile pigment ink, which consists of solvent, pigment and binder agent, is fixed through heat without impairing the breathability and water absorbency of the fabric; which removes the need for large post-treatment equipment. These inks deliver beautiful print results on cotton and hemp materials and are recommended for interior fabrics, t-shirts and various other apparel applications.

The Mimaki Sb420 sublimation dye ink is specifically designed for use with pre-treated polyesters. The colour is fixed using heat after printing and printing on polyester with these inks delivers "excellent" colour accuracy and reproduction.

The Mimaki Tx300P-1800 printer can print directly onto almost any type of natural or man-made fabric and is ideally suited for thick and woven textiles. Its combination of affordable price, speed and high quality make it "perfect" for producing short runs or samples of customised or bespoke designs. The Mimaki Tx300P-1800B printer uses an innovative automated belt-fed conveyance system, which makes it particularly effective for printing on modern stretchable materials. With the capability to print to a broad range of natural and man-made fabrics this machine can be used to produce fashion, clothing and soft furnishing materials.

[www.hybridservices.co.uk](http://www.hybridservices.co.uk)



The Mimaki Tx300P-1800 direct to textile printer is getting an upgrade.

## More products from William Smith

Trade supplier to the sign and graphics industry, William Smith, has a new "re-energised" addition to its range of 3M vehicle wrapping products.

The company will stock 3M Print Wrap Film IJ180mC, which "cements its reputation as the UK's leading material trade supplier, and highlights its ongoing commitment to become the number one choice for materials and signage".

With the high-quality benefits of ComplyTM Adhesive with micro technology, these 3M IJ180mC films will increase

installation and provide even more design options for wrappers, says the company.

Along with improved liner release IJ180mC-10 also provides a non-visible comply pattern to ensure a smooth, bubble-free finish to a completed wrap. The launch of the new film also includes the introduction of clear and metallic options: 3MTM Print Wrap Film IJ180mC-114 and 3MTM Print Wrap Film IJ180mC-120. There are also permanent and removable adhesive options all with microComply™.



William Smith adds to its range with new print wrap film from 3M.



### Trade Print Service

Roll to Roll up to 5 metres wide

- Wallpaper & Floor graphics
- Frontlit and backlit banners
- Mesh banners
- Polymeric vinyls
- Cast wrap films

### Direct to substrate printing

- Foam board
- Polypropylene fluted board
- ACM

### Exhibition Displays

### Quick Turnaround

### Competitive mtr<sup>2</sup> prices

Contact us for a free no obligation quote

+44 (0)1263 863100

[www.structure-flex.co.uk](http://www.structure-flex.co.uk)

[digitalprint@structure-flex.co.uk](mailto:digitalprint@structure-flex.co.uk)

















**A-LITE WHITE CORE**  
aluminium composite panel



**EASY PEEL FILM**  
Provides excellent protection and is easily removed, leaving no residue on the panel.



**PERSPEX**  
Distribution Ltd



**ALUPANEL A-LITE WHITE CORE**  
Aluminium Composite Panel with a digital coating and a white core, ideal for applications where edges are exposed.



**DIGITAL SURFACE**  
The flat, smooth, digital surface with vastly improved ink adhesion helps to display printed colours with increased brightness and intensity.



Bringing Print to Life  
**A-LITE**  
aluminium composite panel



**MADE IN THE UK**



**MANUFACTURED IN KENT**  
Most advanced technology in the industry.

**Now available from Perspex Distribution:**

Alupanel aluminium composite panels - the ONLY aluminium composite manufactured in the UK.

Visit [www.perspex.co.uk](http://www.perspex.co.uk) to contact us for more information.



## New Roland RIP software for dye-sublimation printers

Roland DG's ErgoSoft Roland Edition 2 RIP software is available for its Texart dye-sublimation transfer printers.

ErgoSoft Roland Edition 2 is the latest RIP software developed by ErgoSoft, one of the premier RIP providers in the textile printing industry, says the company. It has been developed specifically for the Texart XT-640 and RT-640 to support digital textile printing of sports and fashion apparel; soft signs such as polyester banners and flags; and other interior décor, as well as promotional goods and personalised gifts.

Current XT-640 and RT-640, customers who activated the previous ErgoSoft Roland Edition RIP on or after 8 March 2016, will have access to a complimentary software upgrade. Customers seeking an upgrade should contact their local Roland DG dealer for further details.

ErgoSoft Roland Edition 2 is designed to boost users' productivity and provides over 40 new features and innovative enhancements, says Roland. A new dithering method increases rasterization speed and improves dot placement accuracy, which results in 40 per cent faster RIP times and smoother gradients. A new PDF engine displays dynamic, colour-accurate previews of PDF files and improves overall performance

### ErgoSoft Roland Edition 2

and colour management. The software also includes up to eight simultaneous RIP servers to reduce processing time when working with high-capacity data or multiple print jobs at the same time.

Image Add-Ons functions support several new effects such as barcodes, rulers and drill holes. Multiple effects can also be applied to a single set of data. Specific editing functions support file formats that are commonly used for textile printing. The Step & Repeat feature to create flawless repeating textile patterns from a single image is available for PDF and EPS file formats. The Color Replacement feature for creating multiple colour variations is also available for TIFF and PSD file formats. Variable data printing for the efficient production of personalised goods and apparel such as uniforms is included as standard.

Roland DG offers two Texart 64 inch (1625mm) models. For fast, high-volume printing with dual-staggered print heads, the XT-640 is built for continuous production on long print runs. The RT-640 is designed to provide "superb quality, productivity and



*ErgoSoft Roland Edition 2 is the latest RIP software developed by ErgoSoft for digital textile printing.*

value with ease of operation that will please both experienced operators and beginners". Both dye-sublimation printers have the ink switching system, a choice of four-colour high-speed or eight-colour wide-gamut printing, fluorescent pink and yellow inks for creating hundreds of eye-catching colours, and print control technology.

\* Existing software and print settings can still be used even after updating to the ErgoSoft Roland Edition 2.

[www.rolanddg.com](http://www.rolanddg.com) / [www.rolanddg.co.uk](http://www.rolanddg.co.uk)

## Roland DG releases Roland PrintStudio by Caldera

Roland DG recently launched Roland PrintStudio (RPS) by Caldera across the EU region, North and South America. With many time-saving and efficiency-driving tools, users of Roland DG technology will be able to optimise their print production processes with this newly upgraded RIP and print management software package, says the company.

Ready for the latest Mac OS, armed with APPE 4 and available in multiple languages, the software speeds up image processing and improves organisation for wide-format businesses of all kinds. It "offers a newly designed interface, enhanced

colour control, better file preparation and fast RIP speeds, to make sure users can deliver on spec, on time, every time".

Valery de March, OEM Business Director at Caldera, said: "Users will be pleased to be able to take advantage of extensive colour management features, create an unlimited number of presets, use automated functionalities and hot-folders and take advantage of advanced tiling and nesting tools."

Paul Willems, Head of Business Development and Product Management, EMEA said: "With RPS there are multiple features to ensure enhanced colour-accuracy,

including hundreds of spot colours within the Roland colour and metallic system libraries, and support for RAL, HKS and Pantone® colour swatches. Users can access our library of media profiles on the profile centre; and PrintStudio offers the ability for users to create their own ICC profiles, and provides support for low-cost colour spectrophotometers."

Roland PrintStudio by Caldera can be ordered via the Roland DG Authorised Dealer network.

[www.rolanddg.com](http://www.rolanddg.com) / [www.rolanddg.co.uk](http://www.rolanddg.co.uk)

**MULTI**technic Ltd The TRADE Etching Experts! Est. 1972

**FAST QUOTES FAST TURNAROUND TOP QUALITY PRODUCT**

**316 Marine Grade Stainless Steel: A4 £65, A3 £98, No extra charge for brass. Next Day Delivery £10\***



*Etched brass on hardwood base*



*Etched stainless steel with colour blends*



*Brass with textured background*

**Email: [sales@multitechnic.co.uk](mailto:sales@multitechnic.co.uk) or phone: 01670 512090**

PRICES EXCLUDE VAT. \* TO MOST MAINLAND UK ADDRESSES

**Chemical Etching and Digital Anoprinting for the Sign Trade**

**SYGNET**  
[www.sygnet-signs.com](http://www.sygnet-signs.com)

**THE TRADE SIGN MANUFACTURER**

PROJECTING SIGNS  
TOTEMS & MONOLITHS  
LED ILLUMINATION  
BESPOKE BUILDS  
BUILT UP LETTERS  
FLAT CUT LETTERS  
SIGN TRAYS

Tel 0116 262 6288 or  
[sales@sygnet-signs.com](mailto:sales@sygnet-signs.com)

129 Humberstone Road  
Leicester LE5 3AP



## Progress of the digital sign age

This month, we take a look at the specialist area of digital signage, how it is flourishing and the way in which it is becoming increasingly used as a means of promotion almost without us realising. In our digital world, as it is introduced to a growing number of industries, offering them new ways to market their products and services, it never ceases to amaze us just how seamlessly this rising phenomenon is developing.

We asked a number of digital signage experts their thoughts on this niche industry and what they think the future holds for its further development. Here's what they had to say.



Jeff Hastings, CEO BrightSign

“Digital signage adoption is increasing almost everywhere. Surveys such as the authoritative IHS Global Market for Digital

Signage report forecast that shipments of displays and players into the signage market will grow by 9.3% and 8.1% respectively in 2017. Each vertical which we serve is seeing growth at this time. Retail, the big market for signage, is far from saturated. For example, Technavio is forecasting a 16% growth in retail display sales. There are still retailers adopting signage for the first time, whilst existing users are introducing screens to further stores, increasing the number of screens in locations that already have them, and replacing PCs, screens and infrastructure as technology improves. Corporate, leisure, education, food service and transport are also all growing markets.

As demand continues to grow, dedicated appliances designed specifically for the task are coming to dominate the market. Appliance player design is evolving, to make them easier to integrate into the display. Until now the players built into screens have been relatively limited in their capabilities and software support. At ISE, we saw the

launch of a BrightSign HD3 DSM (digital signage module) that can be readily embedded into a display, and offers the features and software integration of the industry leading Series 3 player family. In addition, the launch of new OPS players gives the 2 million OPS displays worldwide access to an affordable, reliable media player that offers features and functionality that have come to be expected for commercial-grade digital signage.

### Scalability, stability and content management

We sell to all market segments: sign makers, interior designers, shop fitters and system integrators. They like purpose-built players for three basic reasons: scalability, stability and content management. A specific model of an appliance player is identical no matter where in the world it is installed – so if an application works in the integrators lab, it will work anywhere.

The hardware and firmware design is stable – new releases of firmware are normally only to implement new features, and are optional. If you don't need the new feature you don't need to upgrade. Finally, appliance players are closely integrated with the leading content management systems, making it easy to manage national, regional or global player networks. Integrators also love the signature reliability of dedicated players – with a proprietary operating system designed specifically for one purpose around one specific hardware architecture, there is nothing to fail.

2017 will be the year of engagement: interactivity, mobile engagement and HTML5 will combine to create the digital experience. This year, retailers will encourage customers to engage directly through the digital signage screen and indirectly via their own devices. Proximity based content will arise. Bluetooth™ and beacon technology is enabling a new level of audience participation. Customers will be presented with options to interact with and control the signage from their mobile device. These technologies will allow retailers to increase sales with engaging point-of-purchase promotions. ”



BrightSign supply digital signage hardware to the National September 11 Memorial & Museum in lower Manhattan



BrightSign and Mood Media deliver the first Costa Coffee digital menu boards

“In retail, AV is everywhere you turn and look. Stores and malls are festooned with screens showing videos, advertising products and services available on site, and directing visitors to points of

interest, promotions and events. These screens range from massive video walls to single screens promoting a specific range.



Andy Fliss, Vice President, Sales and Marketing, tvONE



tvONE CORIOmaster drives 16K video wall at University of Warwick

Networked video will compete with high resolution LED for most influential technologies. Companies that can develop quality signal flow and intuitive user interfaces will shine above the rest in both areas. Network video will become more stable and provide consistent performance while LED technology will become more affordable and will replace flat panel monitors as a large image solution.



This will enable the growth of cloud based streaming services, which will revolutionise the way the AV industry works. Services such as Wosza, Microsoft Azure, AW and USTREAM are going to play an important part.

Within the next year, we will see high end streaming applications where the IP feeds will be combined with other AV connections for visual experiences including retail, information hubs, education, security monitoring, control rooms, transport hubs, team collaboration, health-

care monitoring and conference centres. For the AV industry, what will be essential is how seamlessly we interface with these services.

#### Trained and accredited installers

Trained and accredited installers are key in our mission to create satisfied customers. That is why we put a lot of effort into training so that installers fully understand how to access the capabilities and features that our systems offer. tvONE Training Academy with CTS accredited hands-on

sessions are very popular.

We have recently invested £100,000 in a new studio area to enable the development of an extensive suite of online tutorial videos as well as the expansion of its series of webinars. We have already created over 20 short videos from brief product overviews and unboxing videos to in-depth step-by-step tutorials on how to deliver specific functions. We will also continue to offer CTS accredited Pro AV modules face-to-face, over the web or at client sites. ”

“ One thing that has become very clear over the last six to nine months is that digital signage providers and end users are looking at new ways to leverage IP infrastructure. Just six months ago 63% of our customers told us that moving content over IP networks was important to their future success. That number today stands at 75%. Signage providers realise that this move toward integrated IP networks for AV, signage and data requires a skills and mindset change, but brings huge opportunities, allowing them to offer solutions with greater flexibility over a standards based IP infrastructure. This puts them in a position to reach screens not traditionally considered part of the “digital signage network” driving messaging even deeper into organisations and venues.



Rob Muddiman, EMEA Sales Director, ZeeVee

#### A better in-store experience for everyone

We continue to be astonished at the diversity of uses that retailers find for AV, beyond simply communicating product information. Many use it to create aspiration, for example motorcycle dealerships showing bikes being ridden through stunning countryside. However, AV has the potential to make visiting a store much more of an experience, entertaining as well as educating the customer.

Another interesting development we have seen recently is the metamorphosis of what might be considered signage only companies into providers of a wider breadth of services. More and more, end users are looking for one provider for signage, entertainment, and light integration work and we are seeing signage providers step up to fill that need.

A major Lexus dealer in Colorado has really taken the technology to heart. They are not only creating a relaxed environment in the showroom itself with enormous portrait screens showing the beauty of the surrounding scenery, but are also using signs in the service area to update customers on the progress being made with their vehicle. Using a Wi-Fi enabled chip in each car that they service, the dealership recognises the vehicle on arrival, welcomes the customer and confirms the work to be undertaken. Further screens provide movies and other entertainment.

In another example, a major chain of retail furniture stores is using digital signage not only to provide information but also to entertain its youngest customers – children shopping with their parents. The same signage is also used at times to relay major sporting events. This results in a better in-store experience for everyone.

#### Upgrading... rather than building entirely new networks... makes sense from a time, money and environmental stand point

Because ZeeVee's main focus is delivering content over whatever network the client desires, we focus on a wide set of customers - signage providers, integrators and end users. Very often this means we are working with IT departments who welcome the ability to transmit signage and AV content over their IP networks. They understand these networks and are becoming more and more comfortable with the expansion of their use for AV and signage as it ultimately results in cost savings and ultimately the development of more robust IP infrastructure. Additionally, managing the installation cost is key and the cabling needed to pipe content round a large store, shopping mall, stadium or campus is a significant expense. ZeeVee offers both RF coax based and IP based solutions which means customers have the ability to leverage their existing infrastructure, often upgrading its capabilities rather than building entirely new networks, which just makes sense from a time, money and environmental stand point. ”

# DYSS

## The Best Choice in Digital Cutting Machines

- **Powerful router** gives high quality finish on: acrylic, DIBOND®, rigid PVC (FOREX®), aluminium, HIP, and more.
- **Kiss cut tool** for precise cutting of vinyl, foils, paper and light card.
- **Reciprocating and static heavy duty knives** for FOREX®, foamcore, magnetic foil, corrugated, carton board and more.
- **Creaser and V-Cut tools** for folding a variety of substrates. Tape dispenser tool option.
- **Range of automation options** including camera guided cutting and **sheet feeders**.



The perfect combination of tooling and automation for 24/7 sign production.



XVT - V cutting tool, perfect for POS and displays using hexacomb board.



Powerful router makes light work of acrylics and other sign and display materials.



AG/CAD Limited  
www.dyss-uk.com



# DIGITAL SIGNAGE Feature

“It is a really exciting time for digital signage, clever software solutions combined with display screens of all sizes and resolutions are shaping the way advertising campaigns are run.

From a consumer perspective ads are becoming more personalised, informative, interactive and strategically targeted. Additionally, advertising screens are now appearing in more places than they ever have before such as waste recycling trucks and will soon be on buses as well as other types of vehicles.

The exposure to the content displayed on these types of screen will exponentially increase compared to the screens installed at a fixed location. Although putting digital signage on vehicles is not a new thing, everyone has likely seen the small screens on Hackney carriages. It is now the content management side that is showing innovation, where specific ads are triggered based on data like real time GPS location of the vehicle, weather data and daily event data.

For example; running an ice cream ad on a sunny day is more effective than running it on a typical rainy British day!

Our core market is general digital signage, we have been supplying, installing and maintaining simple informative text and graphic displays for over 20 years and we have also completed projects involving big indoor and outdoor screens.

## Customer training following purchase or rental

Typically, a day's training and comprehensive user guides are provided. We have developed software solutions which are customer focused and easy to use, hence minimum amount of training is required. We also offer free 24/7 customer support.

Enhancing the in-store shopping experience, we supply the screen and software package capable of handling the latest content, social media interaction options, real-time data and remote connectivity.



Santosh Surabi, Senior Technical Engineer, Stocksigns Ltd

## Outward-facing digital signage window displays

We design and specify screens to meet the requirements in terms of screen size, pixel pitch, brightness etc. Once the customer is happy with the specification we also help them with applying for planning permission if required.

Planning permission is the biggest challenge; UK legislation is still very stringent on brightness levels of screens and content which can be displayed on them. Once the signs are installed we make sure they are operating within the law and that they comply to all standards. ”

“Retailers are using increasingly large touchscreens to create an impact, with multi-touch capability allowing the creation of interactive displays which can be used by multiple customers and sales people simultaneously. Such touchscreens can be mounted on the wall, an angled plinth or even integrated into a coffee table to offer browsing and product selection in a relaxed setting for an enhanced in-store experience.



Ian Crosby, Sales and Marketing Director, Zytronic

User interface designers are using new approaches and technologies to improve engagement and ease of use, and to attract the attention of customers. Force sensing technology, for example, which has recently found favour on smartphones and tablets, is now emerging on large format touch screens too. Object recognition is another technology that is becoming available for touch tables for further creative interaction with customers.

Integrators have the opportunity to think beyond the customer's brief and create a solution that goes beyond what the retailer believes is possible. For example, Hyundai approached our Turkish system integrator Nerotouch with a project to improve the ambiance and customer experience in its 80 strong car dealership network. With their encouragement, they modified the scope of the project, and created unique multi-touch tables using custom designed 40-point multi-touch MPCT™ Projected Capacitive Technology touch sensors supplied by Zytronic, that can not only be used unaided by customers, but can also be used by the sales team as an integrated part of the sales process.

Similarly, South American mobile network Movistar approached Peruvian AV specialist PX Group with a brief to make its store in a busy, upscale area of Santiago, a place that its customers would make a special trip to visit.

They responded with a completely new concept featuring a touch video wall with three 50" or 46" touch screens using Zytronic ZYFILM® Multi-touch Projected Capacitive Technology, allowing customers to browse while they are waiting, as well as a kiosk with a full product catalogue using a 40" screen. When it opened, the new store with the Multi-touch wall was disruptive. There was no store like it anywhere else in Santiago or the rest of the country.

Force sensing and object recognition technologies provide a fantastic opportunity for developers to deliver more immersive experiences, creating touch interfaces that offer features users will have rarely seen before, other than in sci-fi movies. Whilst users may be familiar with force sensing from their smartphones, object recognition may be completely new to them. In both cases, commercial touch screens are keeping pace with innovation in the consumer electronic world.

Force or pressure sensing literally and figuratively adds a new dimension to the touch experience. It is particularly powerful when used in combination with multi-touch technology, exceeding what is possible on all but the most advanced tablets and smartphones today. For example, in a way finder or web browsing application, a soft touch can open a preview window – then by pressing harder, fully opens the window. On a kiosk, a soft touch can bring up a menu of options and increasing the applied force makes a selection.

Similarly, object recognition provides a compelling new way of engaging the user with the touch screen and the interactive content available on touch tables. Users can create their own interactive objects for use with Zytronic multi-touch sensors, creating a more engaging, immersive experience. ”



Way finder in the prestigious Marina Bay Sands hotel complex, Singapore



Real-time content on display at CDEC



The 43" multi-touch tables created by Nerotouch using Zytronic touch sensors, have been installed at 80 Hyundai car dealerships in Turkey to provide customers and the sales team with information where it is required



The Movistar interactive touch video walls and kiosks use Zytronic technology for an enhanced customer experience



# DIGITAL SIGNAGE Feature

“ There’s plenty happening in the digital signage industry at the moment. Purely visual and interactive touchscreens are becoming a constant element in day-to-day life in several verticals such as retail, travel and quick-serve restaurants.

Large brands and chains, as well as certain independent retailers, have invested heavily in apps and other digital content platforms such as photography, videos and e-commerce systems, and digital signage solutions make an inexpensive but effective choice to push content, such as a brand website or existing digital content in an eye-catching, well-presented way in the physical stores. In addition, technologies such as RFID [Radio Frequency Identification], NFC [Near Field Communication], beacons, Bluetooth and so on all enable real-time personalised communication and analytics of the interaction on the screen.

In-store interactive screens put a store’s full stock in front of a customer and at their fingertips, giving them the ability to explore different sizes or colours of a product, place orders, make reservations, check availability and also share content with friends via social media platforms. By adding a payment terminal, an interactive screen becomes a point of sale, which speeds up the purchasing process.

## Stand out from the crowd and impress customers

A large number of our customers are in the retail industry.

Many experts expect bricks and mortar stores to be the next industry hit by the digital tornado, thanks to new motions such as the endless aisle or ‘BOPIS’ (buy online pick-up in store).

Retailers should expect to see their competitors starting to incorporate tech solutions too, so the time is now.

## Blending the best of both online and in-store

Shoppers continue to visit brick and mortar stores thanks to features such as endless aisle and the introduction of ‘BOPIS’ but soon, we’ll also see point-of-sale (POS) move out from behind the counter and become accessible anywhere in a store, offering more control to the consumer as well as the retailer. Further adoption of self-service digital touchscreen kiosks will enhance in-store e-commerce and trends such as artificial intelligence (AI), virtual reality (VR) and chatbots which are also all beginning to advance, so their popularity among consumers and with retailers will also grow. AI especially promises to make it easier for sales associates to engage and conduct transactions with customers anywhere throughout the store. We’re likely to start seeing the first real integrations of AI throughout stores, which will be there to help consumers with questions or deal with product requests if sales assistants are busy helping other customers.

By blending the best of both online and in-store, retailers will create seamless omnichannel shopping capabilities that will truly enhance customer experience and brand loyalty potential.



Maarten Bais, VP and General Manager at Elo EMEA

Touchscreens are now contributing to what we can expect to be a ‘cashless society.’ Customer behaviour is starting to shift and we’re seeing a significant reduction in cash transactions over time. Although cash enables consumers to pay anywhere, for retailers, a complete move to ‘contactless’ would be far more convenient as they wouldn’t have to manage cash anymore. In order for this to happen, ‘cashless’ needs to provide the same option that currency does – the ability to pay anywhere. I see the next few years becoming the turning point as we start to see such a model come to fruition across retail.

Retailers will also get to know their customers better through digital interaction online, through mobile apps and in-store. This will give them the opportunity to customise their offerings and touchscreens will make it easier for them to adapt content, track metrics and maximize the return on investment. ”



Interactive touchscreens are becoming a constant element in retail



Creativity. Framed.

We manufacture **aluminium frames** and **lightboxes** for specific use with tensioned fabric graphics.



EDGE LIT FLAT PACK



BACK LIT FLAT PACK



SOLID PANEL SLIM LINE

[www.dpi-uk.com](http://www.dpi-uk.com) | 01332 228 150

DPI UK Ltd. 29 Royal Scot Road, Pride Park, Derby DE24 8AJ

# SMT

## SIGN MAKING TOOLS

The **SignMaker**  
MiniRoll - Application Table

Transform your work flow -  
Save hours per week -  
Short ROI time

Application Areas available  
1350mm x 745mm From £1500.00  
1350mm x 995mm From £2150.00  
1285mm x 2500mm From £4500.00  
Table top or free standing  
Custom sizes available  
Extendable Beds



**Laminates**  
**Mounts**  
**Tapes**

Prices Start From Just  
**£1500**

Unit D7, Haybrook Ind. Est., Halesfield 9, Telford, Shropshire. TF7 4QW - 01952 581313

[www.signmakingtools.co.uk](http://www.signmakingtools.co.uk)

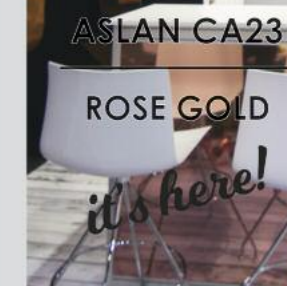

ASLAN SE75  
MIRROR FILM



ROLAND  
GR SERIES  
PLOTTER



dorotape  
be creative

01858 431 642  
sales@dorotape.co.uk  
www.dorotape.co.uk



# JKN Digitally Print onto Easy Apply Textile Wallpaper ( with repositionable adhesive )



## JKN Easy Apply Textile Wallpaper

made of 100% woven polyester fabric with a repositionable adhesive. The flexibility of the fabric makes for easy application on walls or other flat surfaces, while the adhesive properties make for ease of application and repositioning to ensure a perfect fit.

These properties make **Printed Easy Apply Textile Wallpaper**

ideal for:-  
 Business Rooms  
 Reception Areas  
 Exhibitions  
 Lobbies  
 Bars  
 Clubs  
 Hotels  
 Restaurants  
 Private house feature walls....



In fact anywhere a unique image is needed.



**Free Printed Samples Available**

**JKN Digital Ltd**  
 Tel: 01772 722735

www.jkndigital.co.uk  
 email sales@jkndigital.co.uk

Celebrating **27 years in the industry**

JKN DIGITAL printers of

**Wallpaper**

**Vinyls**

**Banners**

**Vehicle Graphics**

**Exhibition Graphics**

**Print Finishing**

**Window Graphics**

**Posters**

**3D Displays**

**Backlits**

**Textiles**

**Nationwide Delivery & Installation**



For all enquiries email [sales@jkndigital.co.uk](mailto:sales@jkndigital.co.uk) Tel 01772 722735

Please enquire about  
**Greensolutions**  
 A division of JKN DIGITAL Ltd  
 Manufacturing Products that Respect Mankind and the Environment





## UK's first EFI VUTEK 5r installed

The UK's first EFI VUTEK 5r printer has been installed at Hollywood Monster's Birmingham headquarters. Supplied and installed by EFI distributor CMYUK, the company chose the 5m-wide machine for its ability to meet the productivity levels required by its expanding retail customer base.

Featuring high-quality output with 7 picolitre greyscale imaging in resolutions up to 1,200 dpi, the new VUTEK 5r model offers the fastest throughput in its class, says the company.

Other features include: powerful LED-curing technology; unique feature sets such as easy and accurate double-sided backlit and blackout printing; carriage height adjustment and wrinkle analyser to avoid head strikes; and handling of rolls up to 750kg.



View of Hollywood Monster's Birmingham factory.

The printer also features an inline X-Y finishing system for cutting and slitting, which enables the production of trimmed-to-size print straight from the printer. Hollywood Monster is maximising its production time, with a fast print system and less downtime between jobs, thanks to this integrated cutting function.

Simon McKenzie, Managing Director at Hollywood Monster, said: "Prior to the EFI VUTEK 5r installation, we would typically

move printed output over to a cutting table for finishing. However, the 5r model's X-Y cutting eliminates that process, removing significant delays.

"It's not unusual for us to print off hundreds or even thousands of banners for big events. Previously they would all have needed trimming on our cutting table, or, dependent on size, even by hand. That entire process is completed on-the-fly during the print process. It's a huge productivity boost.

"Being a long-time UV-LED printer user, we already expected increased reliability, instant on/off curing lamps, the ability to print sensitive and thin materials, reduced costs of replacement lamps and reduced energy consumption. However, the EFI VUTEK 5r goes beyond that and delivers a number of new features aimed at running cost and waste reduction, including higher ink efficiency and a reduction in media wastage (just 40cm of wasted material per load).

"The EFI VUTEK 5r is a printer that appears to have been designed in association with experienced operators, as almost every new feature seems to solve a problem, improve a process or make the day-to-day running of the system easier and more efficient."

Prior to the EFI VUTEK 5r installation, we would typically move printed output over to a cutting table for finishing. However, the 5r model's X-Y cutting eliminates that process, removing significant delays



Simon McKenzie, Managing Director of Hollywood Monster (L) and Mat Jephcott, Hollywood Monster's Operations Director with their new EFI VUTEK 5r printer.

## Mimaki "powers" Modex Exhibitions

Modex Exhibitions are transforming their business with an investment in a Mimaki JFX200-2513 flatbed LED UV printer.

They produce bespoke, modular exhibition stands and displays for clients such as BAE Systems, Nat West and Nottinghamshire County Council. Established in 2003, the company has developed a simple but highly effective business model that provides clients with a uniquely designed 'one-stop' modular exhibition display package. This includes: graphics, flooring, furniture, lighting, installation and removal, all at a fixed price per square metre.



Their new Mimaki JFX200-2513 Flatbed LED UV printer.

The new JFX200 has quickly established itself as a really important production tool for the business, which makes a significant contribution to the production of 30 to 40 display stands per month

Director Rob Brooks, said: "Modex Exhibitions is well established as a designer and builder of high quality, custom-modular exhibition stands, delivered at a realistic price. We do virtually everything in-house, but the one thing that historically we've never had the capability for was the actual print of the graphics panels, which we had always outsourced."

Without any prior knowledge or experience in print operations, after meeting the team from Mimaki re-seller Granthams, they had demonstration of the JFX200 at UK Mimaki distributor, Hybrid Services. "Within 20 minutes of the demonstration starting I was convinced that this machine was just what we needed to become almost totally self-sufficient as a business – the speed and print quality just blew us away!" says Rob.

The new JFX200 has quickly established itself as a really important production tool for the business, which makes a significant contribution to the production of 30 to 40 display stands per month. Rob said: "From a standing start at installation, within the first three weeks we had successfully printed more than 600 8' x 4' rigid Foamex display boards - all without a single problem"

The Mimaki JFX200-2513 Flatbed LED UV printer offers a choice of inks, including white and clear. With the capability to print to a wide range of substrates, the JFX200 maximizes productivity by using industry standard (8' x 4') media on its 2.5m x 1.3m bed.

www.modexuk.com  
www.granthams.co.uk



An exhibition stand created by Modex Exhibitions.



## Durst delivers best quality production to RMC Digital Print

Investment in a new Durst system to ramp up capacity and further improve quality is at the heart of a £1million expansion programme for RMC Digital Print in Hull.

Durst has installed the new Rho P10 inkjet system that gives RMC the opportunity to print on the widest range of rigid and roll media through "unrivalled" versatility. The six-colour configuration including a white

option also enables RMC to continue producing multi-layered backlit work.

RMC is using the Durst for every flatbed test sample sent out customers. The company, which was set up in 2010, is a trade printer with 70 per cent of its work for sign companies and the rest for exhibition businesses. It employs 22 staff and has a turnover of £2.5million, but is now running out of space in its Yorkshire location. This has led to plans for a £1million investment at RMC Digital Print's base, which will include expanding production workspace and buying an additional cutting system.

Nicole Spencer, Operations Director at RMC Digital Print, said: "The quality on the Durst is the best I have ever seen. We have been hugely impressed. The other machines just don't get near.

Every flatbed sample that now goes out to customers is produced on the Durst.

"We needed to upgrade our flatbed systems because of a need to increase our capacity by at least a third; plus the fact that the reality today is that there is a tight turnaround requirement for trade clients, who use our services. We've been operating around the clock because the orders continue to grow."

Peter Bray, Managing Director of Durst UK, said: "The Durst P10 250 high speed system has been the perfect answer for RMC's demand for further improving quality and performance, while opening up new business opportunities with their trade clients, for both signage and exhibition work. I know they have been impressed by the high levels of consistency."

RMC first approached Durst at last year's FESPA. Full production with the Durst P10 250 HS started at the end of February.



Nicole Spencer, from RMC Digital Print, with their new Durst Rho P10 inkjet system.

## SPD Design & Print saves on Mimaki purchase with CSAF finance rewards initiative

Thanks to the new CSAF finance initiative from CMYUK, customers can potentially save tens of thousands of pounds over the duration of their equipment finance contract.

SPD Design & Print Ltd. bought a Mimaki UJV55-320 superwide format printer from CMYUK during Sign & Digital UK this year and benefited from the new initiative. Called CSAF (Consumable Supported Asset Finance), the reward scheme is closely tailored to the needs of the client.

The Mimaki UJV55-320 LED UV printer bought by SPD delivers a high volume of signs, banners, windows and retail displays, exhibition graphics and other similar applications up to 3.2m wide, with the added versatility of twin-roll simultaneous printing.

CMYUK's Senior Digital Sales Consultant, Sue Hayward, said: "SPD were looking at a similar printer from another manufacturer but the benefits of CSAF won them over to us. They quickly understood the financial gains of the scheme and saw how fast they could earn a return on their investment.

"CSAF is a very simple purchasing solution that CMYUK has exclusively developed with Paragon Finance. The customer switches some or all of their material spend to CMYUK, and we will contribute a monthly amount directly into their finance agreement, reducing their monthly payment. The more you purchase from CMYUK, the more you save."

### How it works

Tell CMYUK what materials you buy on a monthly basis, they then analyse the data, and quickly let you know how much CMYUK will contribute towards your monthly finance agreement. CMYUK guarantees to price match or beat your current purchase rates and supply you with either the same products or equivalent products of the same quality.

Your finance agreement with Paragon will have two direct debits every month. One



Photo shows (from left to right) Robin East from CMYUK; Shevy Kapoor and Graham Watts from SPD; and Sue Hayward from CMYUK.

from you, and one from CMYUK. There is no limit to the level of contribution, so you could reduce your monthly finance cost literally to zero. The contribution from CMYUK will continue for as long as you keep purchasing.

[www.cmyuk.com/CSAF](http://www.cmyuk.com/CSAF)  
[www.spddesignandprint.com](http://www.spddesignandprint.com)

## G4B gets a lucky break with DYSS

When Ian Hatfield, the Director of Graphics4 Business (G4B) Ltd broke his ankle, he was confined to working from home. But he used the time to evaluate the business, the industry and the opportunities for a PoS, exhibition and signage business. The result is they bought a DYSS X5 digital cutting table from AG/CAD.

Formed in 2004, the Droitwich company has continually evolved its services and equipment and makes exhibition graphics, signage, pop-up systems and banner stands, vinyl, fabrication, PoS, fabric and flags. From a print perspective, the evolution sees them use aqueous, solvent and large format UV flatbed digital printing that all culminated in a bottleneck for the final process of hand cutting. So Ian investigated the prospect of a digital cutting table to eradicate the bottleneck.

By reducing the labour requirement, the DYSS X5 has improved speed, precision, repeatability on long runs and also the edge finishes

With a 3m cutting area on the OCE Arizona, G4B opted for a 3m by 1.6m DYSS X5 with a roll feeding conveyor facility. The combination of a large bed and a conveyor would accommodate all the large format work han-



K-Cut Vision System on DYSS X5 locating position of printed sheet.

dled by the OCE, as well as the long rolls produced on the other printers. Installed in September, the DYSS X5-1630 has already made a huge impact at G4B, says the company.

Ian Hatfield said: "The industry has evolved considerably with customers continually demanding greater flexibility on both the print quantities and the substrates we print on. Compounding this was the cost reductions sought by customers. We bought an OCE Arizona XT flat bed printer four years ago and this meant we had three printers in

operation. These machines all fed in to a bottleneck that was our manual hand-cutting operation. The flatbed enabled us to print foamex, foam board, cardboard, Corex, PVC and much more. These materials brought greater challenges when conducting precision hand cutting. I used my time working from home to investigate the available options. The DYSS X5-1630C digital cutting table from AG/CAD was the only feasible option for our business.

"We had one member of staff hand cutting on a full-time basis and still struggling to keep pace with the printers. Now, the DYSS churns through the creasing, marking and cutting and the printers are now the bottleneck."

By reducing the labour requirement, the DYSS X5 has improved speed, precision, repeatability on long runs and also the edge finishes. The operator is also less likely to suffer from Repetitive Strain Injury (RSI) or the risk of accidentally cutting themselves.

The DYSS X5 has also absorbed some of the capacity from the company's dedicated CNC routing machine. The heavy duty router is committed to machining PoS and exhibition work that is manufactured from Perspex, plywood and rigid PVC (Foamex) board. The robust build quality and heavy duty tooling configuration of the T-Head system enables the DYSS to efficiently process some of the tough boards and materials that can often be a bottleneck on the CNC.



Hotel safety signage being cut on DYSS X5.



## Ottimo Digital installs UK's first EFI Quantum 5LXr printer

Ottimo Digital has invested in the UK's first EFI Quantum LXR5 UV-LED printer to meet increased production demand. The 5-metre wide, roll-fed printer was installed in February 2017 by CMYUK.

The EFI Quantum LXR5 UV-LED printer, which features powerful LED-curing technology with lower power consumption, is a seven-colour system with optional white ink. The printer offers high-quality imaging with 7 picolitre greyscale imaging in resolutions up to 1,200 dpi.

The Quantum also benefits from labour-saving inline finishing and single-operator

media handling capabilities. The printer also sets a new benchmark in reducing waste, with only 40cm of wasted material per roll.

The achievable print quality makes the EFI Quantum 5LXr ideal for exhibition graphics that are often viewed at much closer ranges than output such as signage, banners and billboards.

Ottimo Digital, based in Newport, was started in 2009 by Lee Crew and Nick Lindwall. The company specialises in the printing of exhibition graphics for both end-user and trade customers.



Lee Crew (left) and Nick Lindwall are 'over the moon' with their EFI Quantum LXR5 UV-LED printer.

Entering the 5m wide market, along with our already comprehensive range of equipment, means that we are perfectly placed to handle absolutely any project that our customers might require

Director Nick Lindwall said: "Our business is primarily in exhibition graphics for retail and trade. In 2016 we identified a need for a roll-to-roll UV printer big enough to cope with high-quality 4-metre high exhibition stand graphics printed as a single piece. We were also keen to streamline our finishing process, as that might have become something of a bottleneck if we began producing output that was too large to fit on our 3.2m cutting table."

With the assistance of CMYUK, the EFI Quantum 5LXr immediately began producing live customer work, with the first jobs being produced during the training process.

Director Lee Crew said: "We are over the moon with this latest purchase. Entering the 5m wide market, along with our already comprehensive range of equipment, means that we are perfectly placed to handle absolutely any project that our customers might require.

"The Quantum is the only 5m-wide machine to offer full in-line cutting which will speed up our finishing process, enabling us to offer extremely short turnarounds."

## William Smith recommend perfect product for the job

William Smith gave the "perfect" recommendation for DeSigns Signage in its recent project for South Hunsley School.

Signage and vehicle branding company DeSigns had been contracted to cover several sun-damaged panels on the building's exterior. The job required the workers to be as quick and discrete as possible, without causing disruption to daily school life.

William Smith, the UK's oldest sign maker, recommended Avery Dennison Facade Film as the ideal solution for the demands of the

project. Particularly, the importance of time and speed, as well as the scale of the area to be covered. Using two rolls of the White Aluminium Gloss FF RAL 9006, the project was finished within 16 hours.

Marketing Manager Lindsay Appleton said: "When DeSigns came to us with their project, we already knew we had the perfect solution. Facade Film is a highly specified conformable cast film and is an excellent, durable and cost effective alternative to traditional paint."



Avery Dennison Facade Film.

Avery Dennison Facade Film is designed for building facades, panels and window frames to restore, restyle or brand. Its strong adhesive can withstand all weather conditions and it has no drying time. The application process is more efficient than traditional paint methods and the film has a life expectancy of over ten years.

Commercial Director of DeSigns, Shane Windas, said: "The Avery Facade film was designed to meet the exact requirements of our project, and is a fantastic product for builders and architectural designers.

"From start to finish, we couldn't have asked for the process and application to be any smoother and I'd happily use the product again and recommend it to anyone.

"We've worked with William Smith for over 15 years. It's a great company with great people who have extensive knowledge of the signage and graphics industry."

Avery Dennison Facade Film is available in 22 standard colours, with colour matching optional for corporate colour requirements.



South Hunsley School after the refurbishment.

## 6,000 man-hour annual savings for Gardners

The productivity of a Durst 'workhorse' is saving 6,000 man hours a year alone for Gardners, one of the UK's largest super-wide commercial printers in the UK.

Playing a major part in helping Gardners drive through hundreds of thousands of square metres of print a month, the Durst Rho 1330 hybrid near £1million investment could pay for itself in less than two years.

One reason for the new Durst investment, they already have two Durst Rho 512R systems, was Gardner's acquisition of the Agripa licence, which has

brought a sudden surge in new work that will see the company employing 120 staff goes through the £13million turnover barrier this year.

Agripa is a patented advertising system that enables large print to be changed in a matter of minutes. It's widely used for marketing; one prime example being the printed advertising on the side of delivery lorries. Although the mesh used with Agripa is not printed on the Durst Rho 1330, which is used for roll-to-roll and flatbed work on a 24x7 basis, it's taking work off other systems.



Richard Courtney, Managing Director of Gardners, which has a 20-strong armoury of wide format printers at its Cardiff headquarters, of which three are Dursts.



### BUILT UP LETTERS

HIGHEST QUALITY PRODUCT  
HIGHEST QUALITY SERVICE

ALL STAINLESS STEEL **316 MARINE GRADE**

MIRROR OR SATIN

ALSO ALUMINIUM, BRASS, ACRYLIC

STOVE ENAMEL & POWDER COAT

( ALL ABOVE ALSO IN FLAT CUT )

email: info@impact3Dsigns.co.uk www.impact3Dsigns.co.uk

TEL : 0191 536 0 536 FAX : 0191 536 5 536

13/14 Hutton St. Boldon Colliery Ind Est. Tyne & Wear NE35 9LW



## Fast-moving sign industry drives demand for greater versatility

*With lead times shrinking and competition increasing sign makers must find ways of responding quickly to the diverse needs of customers. Sign Update reviews some of the latest technologies*

Over the past three years Epson has been busy introducing a new generation of high quality wide format inkjet printers specifically designed to meet the disparate needs of the signage market.

In April 2014 Epson predicted it would launch 25 SureColor printers over the following 18 months; since then it has introduced over 30 models for photo/fine art, signage, textile and label applications with a variety of ink sets including aqueous, eco-solvent, UV and dye sublimation.

The stand at Sign & Digital UK brought everything together in one stunning display

Not surprising then that the SureColor SC-S Series of wide-format printers is now the top-selling eco-solvent technology in its class in Western Europe (Infosource research shows that Epson grew market

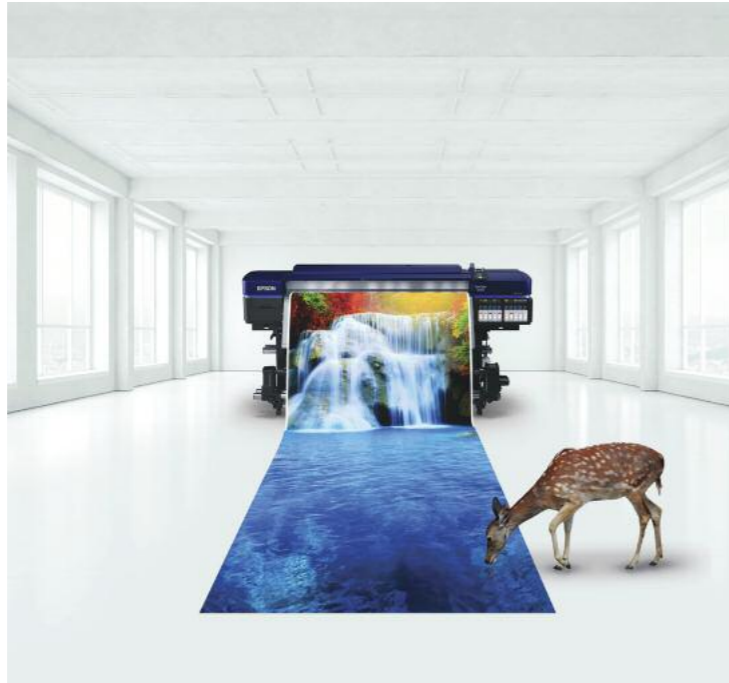

*Everything about the design of the SureColor SC-S is centred on improving the printing experience for sign and graphics specialists while reducing cost of ownership*



*Mel Mantle's intricate floral image featuring myriad vibrant colours met the brief perfectly and was subsequently chosen for the exhibition stand at Sign & Digital UK*

share for these printers from fifth place with just over 9% in 2015 to a league-topping 28.4% by the end of 2016). This success follows the launch of a new generation of 64-inch width Epson SureColor SC-S printers in January 2016: the SureColor SC-S80600, SC-S60600 and SC-S40600 which give users the choice of 4-10 colours (including white and metallic) and up to 95.3sqm/hr single-pass productivity.

### Complete package

Featuring Epson's permanent Precision-Core TFP print heads with variable size ink droplet technology, delivering consistent 1440 x 1440 dpi output, the SureColor SC-S printers create stunning results on a range of coated and uncoated substrates for indoor/outdoor signage, display graphics, posters and backlit panels, POS materials, vehicle wraps, wallpaper and photo canvases.

These innovative printers have generated considerable interest from companies looking for technology that delivers quality, productivity, flexibility, ease of use and rapid ROI in one package.

Everything about the design of the SureColor SC-S is centred on improving the printing experience for sign and graphics specialists while reducing cost of ownership. The latest models for example, use 10-15% less ink than the previous generation and up to 50% less ink than latex technology, depending on the substrate and quality printed.

### Quality results regardless of medium

Epson regularly supports community projects and charities close to its Hemel Hempstead head office and when planning

its stand at the recent Sign & Digital show it asked its local Longdean School to help. The company needed an exciting design to highlight the impressive capabilities of Epson's SureColor eco-solvent and dye-sublimation printers by featuring a wrapped car, wallpaper, signage and textiles.

Each and every element would be blended together to demonstrate that Epson's printers can achieve excellent results regardless of the medium.

Students were tasked with developing a vibrant and contemporary design that could be used throughout the stand including the front half of a car bursting through a wall. Epson provided advice about the SureColor inkjet printers and their capabilities while signage specialist Slam Signs guided the

students through what is involved when developing and applying a digital car wrap.

Mel Mantle's intricate floral image featuring myriad vibrant colours met the brief perfectly and was subsequently chosen for the exhibition stand.

Slam Signs printed the car graphics on the 10-colour SureColour SC-S80600 and wrapped the car chassis at the school. The stand at Sign & Digital brought everything together in one stunning display. Mel's design was printed onto vinyl, paper, canvas and textiles for different applications, showing just how flexible Epson SureColor aqueous, eco-solvent and dye-sublimation printers are and how they produce rich and perfectly-matched colours.

[www.epson.co.uk](http://www.epson.co.uk)

## High production LED-UV flatbed printer

Leading international manufacturer of printers, inks and media, InkTec celebrated its 25th anniversary with the worldwide launch of its JETRIX LXi8 LED-UV flatbed printer at the recent Sign & Digital UK, along with additions to its range of consumables.

"The groundbreaking 3.2m wide LXi8 will open up exciting new printing opportunities for sign and display companies thanks to its top speed of over 206sqm per hour, great efficiency and optimal printing results," comments head of national sales Ben Woodruff.

"We're hoping to attract a huge amount of interest from potential customers looking to take advantage of our new developments

and upgrade their current equipment. In addition to speed, the LXi8 has a host of new features including our latest generation LED-UV ink."

### Environmentally-friendly inks

InkTec showcased its latest inks and media including additions to its Eco Solvent range: the company claims that these 'environmentally friendly' inks have been specifically designed to improve printing performance for Mimaki and Roland printers without releasing harmful chemicals and VOCs.

Enhancing its sublimation inks range, InkTec has developed one for selected Epson print heads including the DX4, DX5 and

DX7; and a latex media specifically for HP latex printers which is tacky without being sticky, can be re-applied and remain in position.

The LXi8 printer is suitable for applications including short-term outdoor signage, clear film window graphics, interior and furniture decoration, industrial equipment, spot varnishing and wood prints; features include:

- 3.2m wide true flatbed
- ultra-high speed up to 206sqm/h
- powerful zonal vacuum system with automated pin registration for quick and accurate media placement
- automatic head cleaning
- print resolution of 1,080 x 720dpi
- latest generation Konica Minolta print heads
- rigid media size of 3,200mm x 2,030mm
- rigid media thickness of 100mm
- innovative LED curing system that reduces operational costs through lower energy consumption and longer lifetime
- powered by dedicated JETRIX GUI (Graphical User Interface) which simplifies, optimises and automates as many steps as possible.

[www.inktec-uk.co.uk](http://www.inktec-uk.co.uk)





## Pushing the boundaries for new applications

HP has seen a transformative shift in the sign and display industry from solvent to HP latex technology, providing many striking applications for traditional sign and display businesses

Digital wide format printing continues to be one of the most significant growth areas in the print industry. InfoTrends projects that print volumes will experience a compound annual growth rate (CAGR) of over 9% until 2019. This continued growth is the collective result of increased adoption, new technologies and an expanding range of applications including soft signage, rigid panel printing, textiles and decoration. Industry research shows that almost 30% of PSPs in developed markets plan to purchase or lease a new digital wide-format printer in the coming year. The average number of units owned by PSPs has risen from 2.3 in 2013 to over 3 in 2016, confirming the industry's health.

### Shift from solvent to latex

Latex technology is HP's hero product for the signage market. The company has seen a transformative shift in the sign and display industry from solvent to HP latex technology, providing many new and striking applications for traditional sign and display businesses. Businesses are changing their messaging more frequently to drive sales activities and this will spur growth in signage applications. In addition, a growth in the request for interior decoration solutions from end-users is a fantastic opportunity for signage customer's and latex inks provide a perfect fit for applications within people's homes and living spaces. The range of latex printers from HP include:



The power of HP latex printing is its versatility

- High-quality at production, printing up to 64 inches wide with the HP Latex 300 series at speeds up to 334 ft<sup>2</sup>/hr (31 m<sup>2</sup>/hr) for outdoor application; 1200 dpi enabled by the HP Latex Optimizer and HP Optical Media Advance Sensor (OMAS).
- HP Latex 560 and 570 printers which help customers manage a variety of print jobs and last-minute high-volume peaks in production at a low upfront investment.
- The new HP Latex 1500 which builds on the success of the proven HP Latex 3000 series and offers a robust, affordable solution for super-wide indoor and outdoor applications.
- HP Latex 3100 and 3500 ideal for high-volume, dedicated application production, enabling more unattended operation with heavy-duty roll-handling and 10-litre ink cartridges.

Today, everyone is a designer. With powerful design tools and inspiration at your fingertips it is easy to see why demand for customised wall coverings, blinds and canvases is rising rapidly.

HP Signage Suite provides cloud-based web apps for easy signage creation, helping PSPs, small sign and copy shops with HP Latex and HP DesignJet printers drive new growth for applications including rollups, banners and commercial posters. This tool supports the full product line of HP Latex printers which use water-based inks, making applications safe for use in bedrooms, children's rooms and even hospitals.

A free, online tool designed for easy integration into PSPs websites, Signage Suite helps boost ecommerce capabilities including 24/7 availability to receive orders. This level of integration ranges from a basic hyperlink to a fully tailored experience. HP Signage Suite joins the HP WallArt Suite in the new HP Applications Center, the go-to source for cloud-based solutions to create customised large-format applications. WallArt has been hugely popular with thousands of users already benefiting from the tool.

The power of HP Latex printing is its versatility: it goes even where solvent cannot, allowing the widest application adaptability. Customers can now expand their opportunity beyond vinyls and banners to films, papers, textiles, canvas and wallpaper. Latex is perfect for interiors and closed spaces as it's a green and emission-free technology, says HP.



Customers can expand their opportunities beyond vinyls and banners to films, papers, textiles, canvas and wallpaper

[www.hp.com](http://www.hp.com)



© Dmitrii Brighidov

NEW!  
CorelDRAW<sup>®</sup>  
Graphics Suite 2017



## OUR BEST JUST GOT BETTER

CorelDRAW Graphics Suite 2017 is our latest and most innovative product yet! Our suite comes with cutting-edge features to help you create impactful signs, custom projects and more. Its intuitive features let you quickly repurpose and combine assets such as illustrations, scanned logos, photos, and fonts for all your sign-making needs. Plus, with the amazing new LiveSketch™ drawing tool, you can skip sketching and scanning from paper, and go right to your computer to capture your ideas the instant that creativity strikes.



- > NEW state-of-the-art LiveSketch™ tool
- > ENHANCED vector previews, nodes and handles
- > EXPANSIVE font management and filtering

For more information go to [www.coreldraw.com/signupdate](http://www.coreldraw.com/signupdate) or visit one of our preferred resellers:

[amazon.com](http://amazon.com)

[qbs](http://qbssoftware.com)  
SOFTWARE



## Solving real world problems

**Mimaki continues to pioneer new technology across all of its product areas and is focused on bringing products to market that solve real world problems for the sign and graphics market.**

Mimaki has released a raft of new products over the past few months with major UK debuts at the recent Sign & Digital UK exhibition for the JFX200-2531 which attracted high levels of attention for its productivity and ability to print and load two 8' x 4' sheets at the same time; and the Tx300P-1800 direct to textile printer ideal for soft signage, flags and exhibition graphics.

"Mimaki continues to pioneer new technology across all of its product areas and is very focused on bringing to market new printers to solve real world problems for the sign and graphics market so watch this space as we move through 2017", says John de la Roche, national sales manager at Hybrid, exclusive appointed UK & Ireland distributor for Mimaki.

Fast turnaround, high quality and cost of production have always been the priority of graphics producers throughout the UK so Mimaki prides itself on its printers being reliable, easy to use and while being capable of exceptionally high quality print, are cost effective and efficient.

Speed, quality and low running costs do not go hand in hand. As a manufacturer Mimaki continues to strive to get the balance right between these key factors.

It is important for manufacturers such as Mimaki to keep abreast of the demands of graphic designers within the commercial sector as keeping up to date with current advertising trends that require print to a particular type of media requires good knowledge of ink technologies, media types and finishing products such as laminates. It is a continual learning process as the demands on graphics producers are constantly changing.

### LED UV technology

Within the general roll-to-roll market, print quality and finish have been clearly defined for many years. Using a combination of the correct media and laminate is well understood for established graphics producers. Where there has been an increase in demand for different types of finish is direct-to-substrate printing using LED UV technology. This is because UV printing is usually carried out directly on the finished product and is able to deal with the challenges presented by substrates such as glass and metal. In response, Mimaki has developed printers and inks including white and clear that enable printing to coloured substrates as well as providing attractive surface effects.

### Performance and reliability

After spending 15 years building its reputation as a go-to signage and grand format print company with Mimaki printers at its heart, Carrickfergus-based Signscript knew that the Mimaki UJV55-320 LED UV roll-fed printer would give them the long term quality needed to boost production capacity for the retail and exhibition industries.



*UV printing is able to deal with the challenges presented by substrates such as glass and metal*

"We invested in the new 3.2m UV Mimaki printer because we knew it would give us quality, performance and reliability," explains MD Brendan Nugent. "After 15 years of using Mimaki printers they have proven to be the best performing printers in the market with year on year advancement in production speeds."

"Having the capacity to print up to 3.2m wide is essential for winning bigger contracts in the retail PoS and exhibition sectors. UV inks give vibrant colours and high blockout which is perfect for customers looking for backlit signage. The UJV55 is terrific value for money and we get low running costs thanks to LED UV curing lamps and economical UV inks."

The Mimaki UJV55-320 has become very popular due to its keen price point and innovative features. An inline, post-print LED lightbox allows print quality of backlit signage to be checked during the production run, simulating its installed look and reducing waste and time; twin roll printing capability enables two different jobs to be run simultaneously on two separate rolls of the same media.

[www.hybridservices.co.uk](http://www.hybridservices.co.uk)

## Future-proof UV print systems

**Quality Print Services provides printers, top quality inks, technical support services along with media and software direct to the wide-format print market and the Longier UV print system is proving popular with customers.**

To date QPS has installed eight of the robust and energy efficient Longier Hunter UV print systems which are designed to be 'virtually future-proof'.

"We were excited to introduce Longier flatbed printers to the UK market last year," says MD Chris Bailey. "The brand is a real competitor against our industry's more recognised names and with Nazdar inks ready-installed, it offers exceptional quality and cost savings".

QPS installed the UK's first Longier Hunter FP-3750 LED flatbed printer at WAE Group's Leeds print room in late May 2016 where it quickly proved its worth as a fast, high-quality and user-friendly machine.

Hoardings, health and safety signs and commercial estate boards for the construction sector, medical panels for hospitals and POS are bread and butter for the signage specialist who was looking to upgrade its existing printing line-up.

"We needed extra capacity, couldn't keep up with demand and were getting stuck with orders," explains MD Paul Austin. "When Chris Bailey recommended Longier we went to see the FR-3750 flatbed with roll-to-roll demonstrator in action and were impressed by the fine print; it's very clear all the way down to a very small point which is what is needed for POS."



*Separate RIP and print console configuration on the Hunter FP-6000 ensures fast workflow for maximum user efficiency*

"The water-cooled LED lamps used to cure the ink are significantly cheaper than conventional mercury vapour lamps and do not need to be replaced nearly as often while the power consumption is considerably lower than conventional UV."

"When testing the inks we found we didn't need a liquid primer on composite materials which cuts costs further. The print quality is fantastic and we've reverse printed with white onto 8mm clear acrylic and it looks great. Colours are vibrant with less ink coverage and there's even a program on the machine showing the cost of the ink you've used. It's very user-friendly and quicker to set up in the morning and shut down at night than our other machines. We're really happy with it."

### Alternative UV-curable printing inks

Among QPS key offerings is Nazdar's extensive and cost-effective range of high quality alternative UV-curable, water-based and solvent printing inks.

These are matched to specific makes and models of wide-format printers; customers simply provide their printer details and application requirements to the QPS team to get the right product.

"One of the biggest challenges facing sign-makers is squaring the continual need for increased machine speed with ensuring ink reliability," continues Bailey. "They demand ever faster turnaround and reducing cost wherever possible; ink can sometimes be problematic in terms of consistency and drying time and OEM products can price them out of business."

### Green credentials

By integrating used ink cartridge collections into existing delivery and service routes QPS helps customers improve their environmental credentials and boost applications for ISO 14001 certification.

Furthermore, QPS distributes DGEN direct-to-textile printers, providing an option to print businesses working to reduce their carbon footprint: soft signage is strong and durable but lightweight and packed easily for optimum space efficiency during transportation.

"We're really a one-stop shop for the sector," concludes Bailey. "We're able to help print businesses achieve higher margins through quality alternative inks, meet growing demand for environmentally friendlier output, maintain their existing equipment using more traditional substrates and ink, upgrade to the newest end-to-end systems and offer applications such as textiles."

[www.qualityprintservices.com](http://www.qualityprintservices.com)



*The Hunter FP-4900 UV LED utilises up to 2 x 8 printhead sets, enabling high speed, low heat printing*



*The JFX200-2531 attracted high levels of attention for its productivity and ability to print and load two 8' x 4' sheets at the same time*



# DIGITAL Printers

## Vacuum bed keeps a grip on substrate

Affordable print systems that are easy to set up and primers suitable for a wide range of substrates are key industry requirements being addressed by Signmaster Systems

An ongoing challenge for companies producing digital print is maintaining a level of production, minimising downtime and meeting new 'green' standards that are being rolled out by the end user.

Oki addressed this previously with the M64 series and the newer SX ink formulation, although aimed at larger companies with a higher production threshold and those offering a trade print service.

With the E64 series OKI has brought all the benefits of the M64 into an affordable solution for companies able to handle entry to mid-level production.

Additions to the product line-up for 2017 from Signmaster Systems include the E64 series from Oki, VersaUV LEF200 from Roland and a whole range of retrofit attachments to further enhance the potential of the Versa UV range.

Customers are always looking for the best primer to use on metals, glass or plastics and Signmaster addresses the ongoing requirements with a broad range of substrate specific products to ensure that the best ink adhesion is achieved.

**Minimising downtime**  
Auto-calibration, a self-cleaning wiper system, nozzle re-mapping, safe scan system



The LEF200 provides an excellent hold of substrates onto the bed and supports the use of thin films papers and flexible materials, perfect for packaging mock-ups

and customisable media pre-sets ensure that users can have the machine up and running quickly and minimises downtime; these features ensure the machine is so easy to use that virtually anyone can walk up to the machine and operate it without special training; very useful if the printer operator is unavailable when production is scheduled. The smart pass, dynamic dot features combined with the ink properties enable the machine to produce high quality (sellable) prints at production speeds, further enhancing the potential profitability of the machine.

Fast drying is assured with the combination of SX ink, airflow drying system and new heater platens. In addition, the SX ink holds 'Green Guard Gold' and 'Nordic Swan' certifications and produces vivid colours with a rich/high gloss finish. Furthermore, the combination of the print head and high viscosity

of the ink ensures low ink consumption and opens up the applications that can be produced, further enhancing the profits made by adding an E64 to any business.

Signmaster has launched a 'Do More with VersaUV' branch to the already impressive offerings of Roland's desktop UV printing solutions. Roland has added the LEF12i and LEF200 to the VersaUV range which enables the desktop UV flatbeds to now be commissioned with primer cartridge; this supports the use of spot primer and reduces the time spent preparing substrates for print.

In addition to the Roland VersaUV, Signmaster Systems supply a range of attachments for the LEF range to further enhance the machine's potential. A rotary printing attachment enables cylindrical items to be printed on any of the LEF printers including candles, plastic/glass bottles and cans.

**Excellent hold of substrates**  
A vacuum bed available to fit to the LEF12i and LEF200 provides an excellent hold of substrates and supports the use of thin films papers and flexible materials, perfect for packaging mock-ups.

The foil system is available for the LEF300 and produces impressive results, enabling foiling to be used in conjunction with 4-colour printing and producing full colour foil effects onto numerous substrates which is brilliant for packaging, awards, card/stationery or phone cases. The Digitrans systems can be used with any of the LEFs.

[www.signmaster.co.uk](http://www.signmaster.co.uk)



With the E64 series OKI has brought all the benefits of the M64 into a unit that is an affordable solution for companies that handle entry to mid-level production

For all Chapter 8 and Hi-Vis Conspicuity requirements, for a competitive quote and a fast professional service:  
**Tel: 08700 777 777**  
web: [www.chapter8highways.co.uk](http://www.chapter8highways.co.uk)  
email: [chapter8@signsrus.co.uk](mailto:chapter8@signsrus.co.uk)

**CHAPTER 8 SOLUTIONS FOR ALL:**  
CARS  
VANS  
TRUCKS

**chapter 8 highways.co.uk**  
3M APPROVED  
THE VEHICLE SAFETY MARKING SPECIALISTS

**NIS**  
new Image Signs  
TRADE ONLY

**Built up Letters In**

- Mirror, Brushed, Mild & Descaled Stainless Steel
- Powder Coated Aluminium • Acrylic • Brass
- Led Illumination • CNC Cut panels & metal fabrication

Visit our new website with online enquiry service [www.newimagesigns.co.uk](http://www.newimagesigns.co.uk)  
**Call: 0191 477 3943**  
Unit 6-7, Stadium Ind. Park, Stadium Road, Gateshead NE10 0XF  
E: [sales@newimagesigns.co.uk](mailto:sales@newimagesigns.co.uk) W: [www.newimagesigns.co.uk](http://www.newimagesigns.co.uk)  
All letters are fabricated in house by time served highly skilled craftsmen

## High Performance Signmaking Adhesives



Will bond most metals, plastic, composites, GRP, glass, wood, stone...

**Eurobond**  
ADHESIVES LIMITED

Call: 01795 427888

[www.eurobond-adhesives.co.uk](http://www.eurobond-adhesives.co.uk)



## Optimising performance, efficiency and speed

**Machines increasingly need to offer a wider range of applications in order to cater to the variety of customer requirements. Rob Goleniowski explains how Roland DG is meeting this challenge.**

Increasingly, we're seeing a merging of markets across the digital print sector. With products traditionally made by signmakers being produced by digital printer and vice versa, there's a definite blurring of boundaries. As a result machines increasingly need to diversify, offering a wider range of applications in order to cater to the extensive variety of customer requirements.

The doors of our Creative Centre are always open to visitors wanting to find out how Roland DG machines can boost business profitability.

As always, the main challenge the digital print sector faces is time. Lead times are getting shorter, competition fiercer and businesses have to find new ways to be the most responsive, flexible and productive service on the market. We are always looking for ways to support customers in becoming more efficient and most importantly, more profitable without sacrificing on product quality.

### Smooth operation

The key to this is to focus not only on print speed but to look at overall workflow and the importance of a smooth operational experience between each stage of the creation process. Roland DG's products are designed to work in complete synergy with each other to optimise performance, efficiency and speed from software to machinery to ink.

Innovative software and versatile machinery can combine to streamline existing methods. For example, Roland DG's VersaWorks Dual RIP software allows for native processing of PDF as well as PostScript files, offering an increased RIP speed and saving time by ensuring transparency effects are processed accurately and removing the need for additional editing processes such as flattening.

### Preparation and planning

Prior preparation and thorough planning is essential. Taking a few seconds to check the finer details and check again before printing pays dividends as does using good quality products. While higher quality products usually cost more at the outset, opting for cheaper alternatives almost always prove a false economy in the long run as lower levels of compatibility can reduce quality and performance levels.

Roland DG's TrueVIS Ink, for example, has been developed in tandem with the print heads of the TrueVIS VG and SG series; the ink delivers optimum performance and high quality outputs every time so that every drop of ink falls exactly where it is intended, delivering beautiful images and uniform colours even at high production speeds.

### Ultimate print and cut package

Addressing a need for a machine that caters for a wide variety of applications and materials, Roland DG has launched the CAMM-1 GR-640/540/420 professional vinyl cutters.

Advanced cutting features ensure that the GR can handle just about anything. Electronic pinch rollers adjust the pressure to 10 pre-set levels at the touch of a button for smooth media feeding at any thickness.



Paired with a Roland DG printer the GR series of cutters offers users the ultimate print and cut package for maximum versatility and profitability

Paired with a Roland DG printer such as the SOLJET EJ-640 high volume or VersaEXPRESS RF-640, the GR series offers users the ultimate print and cut package for maximum versatility and profitability; they are able to read crop marks on pre-printed data to accurately align graphics and automatically create weed lines after designs have been cut.

### Proper care and maintenance

Proper care and machine maintenance can help ensure top quality outputs in the long-term. To help our customers look after their investment we've developed step-by-step videos in-house to educate signmakers in how they can carry out a simple 10-minute clean once a week to help care for their Roland DG machinery.

Once customers are aware of the wide range of options available to them they're keen to sample the newest products and materials on offer. The best thing a sign-

maker can do is anticipate this and choose a versatile printer that gives them greater opportunity to turn their hands to a wide range of customer requests.

In a market where adaptability is key to success the award-winning TrueVIS VG-640 and VG-540 printer/cutter is the ideal solution. From printing a run of thousands of complex stickers to a single large graphic, the VG can create stunning images on a range of uncoated/coated media and cut virtually any type of adhesive vinyl perfectly.

Machines with this level of flexibility allow signmakers to offer a whole range of profitable applications for outdoor or indoor use to ensure they are one step ahead of the competition.

The doors of our Creative Centre are always open to visitors wanting to find out how Roland DG machines can boost business profitability.

[www.rolanddg.co.uk](http://www.rolanddg.co.uk)



From printing a run of thousands of complex stickers to a single large graphic, the VG can create stunning images on uncoated/coated media

**Top Dog for trade price window films**

Order online at [www.windowfilmsdirect.co.uk](http://www.windowfilmsdirect.co.uk)  
We also offer a full supply & fit service throughout the UK, please call for further information.

<b>Silver Reflective Window Film</b> (152cm x 30 metres) from <b>£145</b>	
<b>Solar &amp; Glare Window Films</b> (152cm x 30 metres) from <b>£165</b>	
<b>Safety &amp; Security Window Film</b> (152cm x 30 metres) from <b>£145</b>	
<b>Frosted Window Film</b> (152cm x 30 metres) from <b>£120</b>	
<b>Automotive Window Tint</b> (50cm x 30 metres) from <b>£52</b>	

Samples available on request

**NEW!** Within the window film range we now supply Decorative and Privacy Window Films. Please email or call for further details.

Telephone **0116 278 4844**  
Email: [sales@windowfilmsdirect.co.uk](mailto:sales@windowfilmsdirect.co.uk) · [www.windowfilmsdirect.co.uk](http://www.windowfilmsdirect.co.uk)

**Window Films Direct**  
Visual House, 2a Winchester Avenue,  
Blaby, Leicester LE8 4GZ

**3D Acrylics & Metals Ltd**

Specialists in Quality built up & flat cut lettering & logos

- Acrylic
- Aluminium
- Stainless Steel
- LED illumination

tel: 0191 469 1199 fax: 0191 438 4276  
[www.3dacrilycs.co.uk](http://www.3dacrilycs.co.uk)  
Email: [acrilycs3d@hotmail.com](mailto:acrilycs3d@hotmail.com)

Unit B1, Felling Business Centre, Green  
Felling, Tyne & Wear NE10 0QH



## Hardy Signs create signage for The Midlands Air Ambulance charity

This year Hardy Signs were approached by The Midlands Air Ambulance Charity to manufacture and install signage for a special commemorative project.

After a year in the planning, a bespoke sculpture to commemorate 25 years of Midlands Air Ambulance Charity has been launched at Roadchef's Norton Canes Services on the M6 toll.

The 'Air Pulse' memorial stands at over 6m tall and sits on top of a prominent hillside at the Norton Canes site. Weighing over one metric tonne, the monument honours the lifesaving work of the aircrew, and the dedication and loyalty of the charity's supporters.

At the base of the monument is a circular paved surround created from 3,000 dedication bricks. Midlands Air Ambulance Charity is inviting the public to create a lasting remembrance of a loved one with a dedication brick.

Hardy Signs designed, manufactured and installed two bespoke aluminium sign fabrications to complement the sculpture, and offer information to visitors regarding the significance of the memorial as well as the charity's essential work.

We feel these signs complement the impressive sculpture and will be both decorative and informative to those visiting the site

The signs are finished in the distinctive red with yellow and white detail to match the charity's and their three helicopters' instantly recognisable colour scheme.

Over the next three years the dedication bricks will complete the surround of the Air Pulse memorial, and will raise £150,000 towards the charity's vitally important pre-hospital work.

Dedication messages will be placed on a high-quality Staffordshire Blue bricks and engraved in gold coloured text with a personalised message that will remain in place for ten years.



Hardy Signs helped create a special commemorative feature to raise fund and awareness of the Midland Air Ambulance service.

Midlands Air Ambulance Charity is the charity responsible for funding and operating three air ambulances serving the communities of six counties: Gloucestershire, Herefordshire, Shropshire, Staffordshire, Worcestershire and the West Midlands.

"We feel these signs complement the impressive sculpture and will be both decorative and informative to those visiting the site," says Nik Hardy, Managing Director of Hardy Signs.

Each Midlands Air Ambulance Charity mission costs £2,500 and in excess of £7 million is needed each year to keep its three air ambulances operational, which is donated entirely by the public and local businesses.

"We're immensely proud to work with such a vital charity that serves our region," says Nik.

[www.hardysigns.co.uk](http://www.hardysigns.co.uk)

## FITTING NETWORK

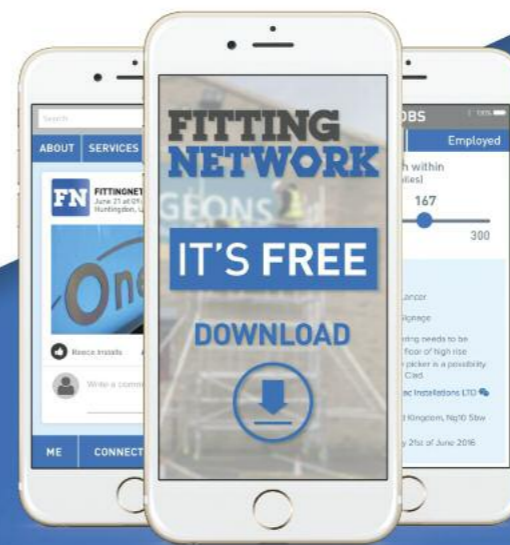

[www.fittingnetwork.com](http://www.fittingnetwork.com)



## Centre Signs (UK) Ltd



For all your trade letter requirements

Tel: 0116 2714247 email: [graphics@centresigns.co.uk](mailto:graphics@centresigns.co.uk)

## THE UK'S NO. 1 SUPPLIER OF TOOLS FOR SIGN MAKERS

- » You'll find our vast range, extensive knowledge, exceptional levels of technical support and after sales care hard to beat
- » With next day delivery we ensure you get the right tool at the right time, and because you're buying direct from the manufacturer, the best value

**itc** industrialtooling corporation ltd

call us now on: **01827 304500**  
or email: [sales@itc-ltd.co.uk](mailto:sales@itc-ltd.co.uk)



[WWW.ITC-LTD.CO.UK](http://WWW.ITC-LTD.CO.UK)



## A national brand refresh

Signs Express has helped launch a dramatic brand refresh for planning and development consultancy, Nathaniel Lichfield & Partners Ltd (NLP).

On 14 February, in a nod to its founder, NLP changed its trading name to 'Lichfields'. The move, which was in the pipeline for several months, was combined with a new vision for the company's corporate identity. This meant that all eight of their offices had to be wholly refreshed - a job that was awarded to Signs Express.

With the requirements stipulating that the refresh take place across the country simultaneously, ready for launch on the morning of the 14 February, Signs Express was the obvious choice with their network of 65 franchised businesses across the UK and Ireland. On the evening of the 13 February, seven Signs Express centres began installing all the various interior and exterior brandings that they had spent the previous weeks designing and printing.



Rick Nurse, Business Development Manager at Signs Express (Leeds), was first approached by Lichfields and co-ordinated the speedy roll-out of the signage across eight sites. Rick said: "One of the great benefits of being part of a network is the potential to work together and complete much larger projects that a lone signage company would not be able to manage. This was a momentous project for Lichfields and a great honour to be a part of it!"

The seven Signs Express' involved in the print and installation alongside Leeds were Falkirk, Manchester, Newcastle, Reading, Croydon and Cardiff. The network com-

bined forces to remove and replace the existing signage simultaneously at Lichfield's offices up and down the country, to create a surprise for employees when they turned up to work the next day.

"Rick was a pleasure to work with," says Rebecca Thomas, Associate Director (Graphic Design). "He co-ordinated the production and installation seamlessly, whilst keeping in regular contact with us throughout the process so that we knew everything was on track. We have received very positive feedback on the work Signs Express completed for us."





**Precision, Accuracy And Repeatability**

- ★ Large stock of spares available
- ★ All of our machine work with 2D Design, CorelDRAW, Illustrator, Autocad and many others
- ★ Finance available
- ★ 12 months to 3 years warranty

600x900 Machine 60 watt £5,250.00

Demonstrations available in our show rooms

Delivery and installation available using our own vans

HPC Laser Ltd are proud suppliers of CO2 laser machines and fibre/galvo lasers to industry and education.

From desktop to large flatbed vacuum bed CNC Routers, we have a wide range to suit all applications.

**Free 3D Printer**

With our Full Machine Packages - Visit our Website for details

**UK CE Certified**

We offer installation, service and back-up provided by friendly, highly experienced staff.

T: 01422 310800  
e: sales@hpcclaser.co.uk  
w: hpcclaser.co.uk

# GTGRAFIX

**CNC, LASER & WATER-JET TRADE SERVICE**

## Flat Cut Letters



Flat Cut Letters in almost any size, thickness and material. Locators and fitting template supplied with all orders. Free delivery on all orders over £100

## Built Up Letters



Built Up Letters. Specialists in stainless steel built up letters. Powder Coated to your chosen colour. Un-lit, face lit or halo lit, we do it all so give us a call! Free delivery on all orders over £100

# 0161 343 7053

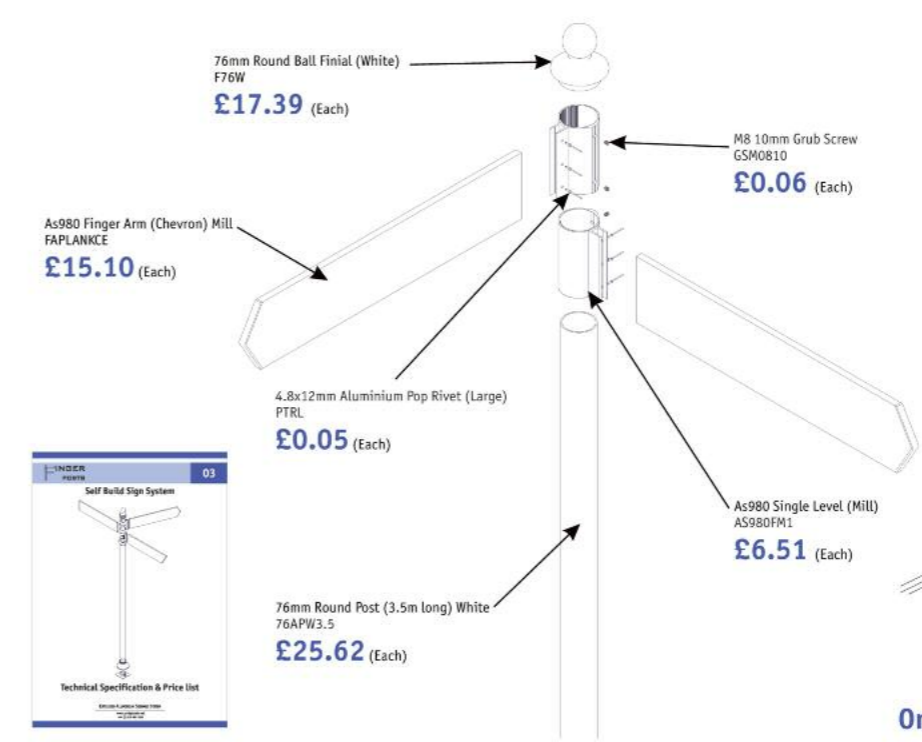

[www.builtupletters.co.uk](http://www.builtupletters.co.uk)

You can now buy **FINGER POSTS** Signage Systems in component form from Ashby



- 76mm Round Ball Finial (White) F76W **£17.39** (Each)
- M8 10mm Grub Screw GSM0810 **£0.06** (Each)
- As980 Finger Arm (Chevron) Mill FAPLANKCE **£15.10** (Each)
- 4.8x12mm Aluminium Pop Rivet (Large) PTRL **£0.05** (Each)
- As980 Single Level (Mill) AS980FM1 **£6.51** (Each)
- 76mm Round Post (3.5m Long) White 76APW3.5 **£25.62** (Each)

**Component Brochures available now**

Total price (Per Fingerpost system)

only **£86.77**

Carriage/VAT (Excluded)  
\*Price correct when bought in component form for bulk manufacture

[www.ashbytrade.net](http://www.ashbytrade.net)  
+44 (0) 118 981 5343  
8.00am - 7.00pm, Monday to Friday



## ITC sculpts a great future for digital fabrications

With a degree in sustainable 3D design from University of Falmouth, David Forsyth has a keen eye for turning the most creative of designs and concepts into a reality. Along the path to setting up Digital Fabrications Ltd, the entrepreneur designed and built surfboards, campervan conversions and trophies.

Prior to setting up Newquay based Digital Fabrications, he taught students how to use 3D milling machines. Here he learnt about the value of high quality cutting tools from Industrial Tooling Corporation (ITC) Ltd. "We used high quality cutting tools from ITC at the university and we always had excellent technical support. So when Digital Fabrications started with its first XYZ routing machine, ITC was the natural choice for cutting tools."



A 3D model of the design alongside the full scale sculpture.

Being a UK manufacturer, ITC can provide new tools as well as re-grind used tools and modify tools for specific projects with an extremely quick turnaround time

In the three years since starting, the business has manufactured mouldings for yachts, bespoke coffee tables, sculptures and signage for retail and exhibition displays. More recent and prestigious projects have involved working with George Clarke

and his amazing spaces television series, and also sculptor Ben Barrell. A recent project with Ben Barrell is the creation of two 7m high and 1.8m wide sycamore leaf sculptures for 'The Address Downtown Dubai' hotel in Dubai. 'The Address Downtown Dubai' hotel faces the iconic Burj Khalifa, the world's tallest building. The Ben Barrell sycamore leaf sculpture that is manufactured by Digital Fabrications will be

centre stage at this location. When completed, the sycamore leaf sculptures will be planted on a 10m granite base with an infinity waterfall feature.

David said: "We started with a 30cm model that Ben designed. We laser scanned the profile and used our Rhino 3D architectural software and Arcam additive manufacturing to build a model for visual reference. The next step was to scale the design up to the full 7m size. We sliced our model up and fitted it all back together like a 3D puzzle and this was how the full size sculpture was manufactured - in layers."

The layers were machined on the XYZ 2.4 by 1.2m bed routing machine. This workhorse was cutting high density foam for over 12-15 hours a day, for almost six weeks. At the "sharp-end" of this machining process was the ITC Brit Cut range of long series end mills. They used an ITC Brit Cut 20mm 4-flute AlTiN coated square end milling cutter for rough machining the complete profile of the 7m model. The scale of the sculpture required the long series Brit Cut 204 Series tool to use its full 75mm flute length to expedite the rough machining process.



David Forsyth with the sculpture at his production facility in Cornwall.

David said: "All our routing tools are supplied by ITC as the technical support from Sally Hunt is second-to-none. The long series 20mm diameter Brit Cut was recommended as the complete flute length could be used for machining. Whilst the overall length of 150mm gave us exceptional tool reach for completing each panel in a single set-up. The rigidity of the Brit Cut eliminated vibration, improved surface finish and more pertinently, the tool life was exceptional as a single Brit Cut tool completed the roughing of the 7m structure."



The Dubai Wings sculpture outside the hotel.



The sculpture being positioned outside the hotel.

Once the rough machining process was complete, Digital Fabrications then finish machined the profile of the sycamore leaf sculpture with a 20mm diameter Brit Cut 204 series ball nose end mill. Like the square end tool, the ball nose used its 150mm length to reach difficult-to-access features and surfaces; whilst the tool geometry and coating technology delivered "impeccable" surface finishes.

To put the tool life of both cutters into perspective; one 7m sycamore leaf required three weeks of machining at 15 hours a day. This equates to over 220 hours of machining, something that was completed with just one square-end roughing tool and one ball-nose finishing cutter.

"Sally from ITC has been making sure we have the right tools for the right job since we set-up the business. The support from ITC has been invaluable. Being a UK manufacturer, ITC can provide new tools as well as re-grind used tools and modify tools for specific projects with an extremely quick turnaround time."

The company has worked closely with the sculpture artist and a structural engineer to guarantee the integrity of the structure. The sycamore leaves have been manufactured with a steel core for stability and rigidity. The completed structures have been delivered to the United Arab Emirates where they will take centre stage on the famous Dubai Boulevard. To underpin the company's future growth ambitions, Digital Fabrications has recently installed a Biesse Rover B 5-axis machine with a 1.5m by 3.6m bed.



## PPB's Allison Board creates a striking 3D #impression

PPB's Allison Board has been used to create an attention-grabbing backdrop at an event to launch the new Reebok® Crossfit Nano 7.

The two metre high, 3D lettering to promote the Twitter hashtag, #NANO7, for the new shoes, was created by Welwyn Garden City-based Best Digital.



After printing the sheets on their Screen Truepress 3200 HS flat bed, they were bonded together and faced off with a reverse printed 1mm Acrylic to give a premium feel

As well as meeting the right price point, Allison Board proved to be the ideal material for the project. Geoff Rawlings, managing director of Best Digital, said: "We found Allison Board very good to work with and it was easy to cut on our routing machines. Also, as the signage was only needed for a short, one-off event, we wanted a material that could be easily recycled, and Allison Board ticked that box too".

Allison Board, which is stocked in the UK exclusively by PPB Ltd, is a lightweight, strong, inverted corrugated centred board that can be used for a whole host of end

applications. It is particularly good for 3D constructions, says the company. It is also 100 per cent paper-based with its core constructed from recycled paper and its top surface layer a PEFC certified paper.

To create the #NANO7 3D structure, Best Digital chose 16mm Allison Board, which they built up in layers to a depth of 96mm. After printing the sheets on their Screen Truepress 3200 HS flat bed, they were bonded together and faced off with a reverse printed 1mm Acrylic to give a premium feel.



## Hi-tech digital solution for European photo company

CEWE Ltd have been printing photographs for 50 years, and supply award-winning products to retail partners in 24 European

countries. With 3,300 employees, CEWE print enough photos each year to stretch around the world almost 10 times!



The high definition LCD digital display mounted on a custom vertical bracket, in the headquarters of CEWE photo printers.

In February this year, CEWE contacted Hardy Signs Ltd to discuss digital signage options for their UK headquarters in Warwick. They had identified the need to communicate with visitors and staff at the facility, and wanted a solution to reflect the organisation's quality image.

Working from a given brief, the digital signage team at Hardy Signs presented a full high-definition LCD digital display, which would be mounted to a custom fabricated vertical bracket to greet those arriving in the main reception.

At 50 inch and with seam less, tablet-like aesthetics, the display also featured tempered glass surface for added protection in this busy environment. Hardy Signs also used a dedicated cloud-based control system to allow CEWE to operate the display remotely from any location with internet access.

"Images, video and live information such as weather and social media feeds can be easily utilised with this user-friendly system," says Hardy Signs Digital Signage Technician Ben White.

"The impressive display has WiFi capability and is connected directly to the internal network at CEWE – giving full flexibility in updating and scheduling the content."

[www.hardysigns.co.uk](http://www.hardysigns.co.uk)

## Students gain hands-on skills with Hardy Signs

Creative students at Burton and South Derbyshire College were recently given an insight into the sign industry, when they assisted Hardy Signs with the installation of large scale vinyl signs across the college.



Students from Burton and South Derbyshire College learn about producing graphics from Hardy Signs.

Hardy Signs worked alongside students, sharing knowledge and demonstrating the best techniques for installing the various printed substrates. Students were taken through the process of producing graphics, from material selection to ink usage and colour matching. The college's main reception has been transformed with the addition of printed wallpaper, vinyl wrap on the support pillars and an inspirational word "cloud" that greets those arriving in the foyer.

The work experience project is part of a wider partnership between Burton and South Derbyshire College and Hardy Signs after the college's launch of its Sign and Print Academy, in association with Hardy Signs last year. 2017 has seen the successful growth of this joint venture, cementing an already long-established partnership. The Sign and Print Academy based at the Lichfield Street Campus has been set up to develop specialist sign-making and printing skills, using the latest technology, previously unavailable in the area.



## Boaty McBoatface gets a facelift from Signs Express

Boaty McBoatface, a yellow submarine named by popular vote, has started its first mission, looking resplendent in special graphics created and applied by Signs Express (Southampton).

The team at Signs Express (Southampton) have worked closely with the National Oceanography Centre (NOC), the UK's centre for oceanographic sciences based in Southampton, on numerous projects over the years. When they were offered the chance to get involved with the branding of the NOC's Autosub Long Range, the team jumped at the chance.

Mark Kendall, co-owner of Signs Express (Southampton) said: "We have loved working with the NOC over the years, as they bring us some really interesting projects; and to be involved with a cause as worthy as theirs is truly excellent. We don't just specialise in applying graphics to sea-worthy vessels however, we have provided them with all sort over the years from banners to illuminated signs and this project was just the icing on the cake."

Boaty McBoatface is joining ocean scientists from the University of Southampton and British Antarctic Survey (BAS) on an expedition to study some of the deepest and coldest abyssal ocean waters on earth, and how they affect climate change. Considering the sub's epic journey, the graphics that were applied had to be of the highest marine grade vinyl that would withstand the icy temperatures and prolonged periods of time submersed at great depths and under great pressures. This was no barrier for Signs Express (Southampton) who, over the years, have applied graphics to several submersible crafts.



Boaty McBoatface (image courtesy of National Oceanography Centre)

Boaty McBoatface has been given the name following last year's campaign by the Natural Environment Research Council to name the UK's new polar research ship, which has been named after famous broadcaster and naturalist, Sir David Attenborough despite popular vote. In a compromise, the Council has dubbed this groundbreaking vessel and several others like it Boaty McBoatface.

The mission began by travelling to the Southern Ocean aboard the BAS research ship RRS James Clark Ross on Friday 17 March from Punta Arenas, Chile.

In a compromise, the Council has dubbed this groundbreaking vessel and several others like it Boaty McBoatface

## Applelec's illuminated letters installed in London refurbishment

Logic CP Limited selected Applelec's luxury illuminated letters to create new branding for the reception desk of the recent Two Pancras Square refurbishment project in London.

The reception area of Two Pancras Square was recently refurbished to create a space that is more energy efficient and modern.

Along with an ecological lighting scheme, Logic CP Limited installed a black granite reception desk that features Applelec's low energy, luxury LED illuminated letters.

At 150mm in height, the letters were painted jet black to complement the dark granite surface of the reception desk. The unusual effect of black letters mounted onto a black

surface was successfully achieved by the Two Pancras Square logo being created with side illumination. The cool, white 3200K embedded LEDs provided even illumination and delivered a crisp, elegant glow against the black granite surface. This particular lighting effect ensured the acrylic letters were a prominent feature on the reception desk, creating a striking installation, says Applelec.

Grade A building, Two Pancras Square has been created as part of a two million sq ft collection of office spaces that are located next to St Pancras International and King's Cross Station.

Andy Armitage, head of signage sales at Applelec said: "For this project, side as opposed to halo illumination was advised for the black letters, to make sure the mounted logo and lighting effect wouldn't be lost against the dark, glossy granite. The thermally managed LEDs and high quality finish of this letter range provided a solution that was suitable for an eye-level installation."



The illuminated letters were lit with side illumination, to create a prominent feature on the black granite desk.

## Tecna Display and Recon invite IBTM visitors to 'Meet in Reykjavik'

Tecna Display recently worked with specialist event consultants Recon to create a stunning display for 'Meet in Reykjavik' at IBTM World in Barcelona, using the T3 System and Wandlite.

IBTM is a global event for the meetings, incentives, conferences, events and business travel industry. Meet in Reykjavik is the official convention bureau in Iceland for Reykjavik and its surrounding areas.

The vibrant 58sqm promotional stand included a 5.5m long, 2m wide and 2.5m high display framework designed with a unique sweeping curve on one face. Recon used the UK-manufactured T3 modular display system's channel and fusion profiles to create the framework, with the Wandlite LED tube system for illuminating graphics.

The design called for a variety of custom curves, and this was made possible thanks to the T3 System's ability to create unique and stunning curved structures that few other systems can manage.

The stand's two large sides were each wrapped with a single graphic, giving the stand a strikingly clean finish. By printing the graphics onto UV backlit fabric, Recon designed the entire stand to be backlit using Wandlite LED tubes.

Adalsteinn Sverrisson, Managing Director of Recon said: "We used the Wandlite for our back lighting because it gives us the greatest versatility when it comes to these sorts of projects. The light that it provides is bright white, 360 degrees and very easy to power. With it being almost unbreakable and it's safe to ship, it is ideal for on-site installations and unconventional locations."

The brief for the stand also called for two large display monitors to be incorporated showing promotional videos; plus a functional custom door at the side of the display that allowed staff to use the display as storage space. These features were easily incorporated into the stand using Tecna's monitor support brackets and its array of custom doors.



The finished stand at the show in Barcelona.

The entire stand was assembled by two members of the Recon team in under two days, including the installation and mounting of the display monitors, lighting and graphics.

Adalsteinn said: "For this event brief, logistics were key for us. We and our client are both based in Iceland, so we were designing and pre-building in Reykjavik and then transporting to the show in Barcelona. We needed to be able to break down the stand into small units for easy shipping, so the system needed to have optimal flexibility and versatility without losing any of its display potential. The T3 System offers all of this to us and we were very happy with the result. The stand was also partially used by the client at another event of theirs in Iceland, which is a fantastic testament to the versatility and reusability of a stand created with the T3 System."

Mukesh Kansara, Senior Designer for Tecna Display said: "The clean finish and vibrant graphics created by Recon were stunning and the inclusion of the custom curves to one side made it a unique and eye catching display."

www.recon.is  
www.t3systems.com

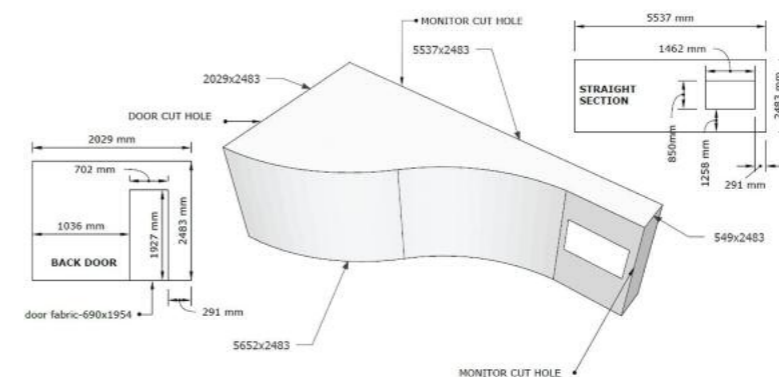

The graphical representation of the Recon stand.



# nanolight



The most advanced trough light.

## ATTENTION TO DETAIL

Nanolight has been carefully engineered by a team of experts to achieve a stunning and precise design. The result is a remarkably slim 47mm profile with internal IP67 rated drivers, making Nanolight the smallest trough light of its kind in the UK. This provides a contemporary, sleek finish to any indoor or outdoor sign, without the inconvenience of housing unwanted external drivers.

With over 10 years of lighting expertise, we know that design is not just what it looks and feels like.

Design is how it works. That's why we have ensured Nanolight is quick and effortless to install. Simply hook Nanolight on to the included adjustable brackets and fasten securely.

The technology inside Nanolight is as revolutionary as its design. With industry leading IP67 rated LEDs we have reached the perfect balance between brightness and efficiency, boasting an impressive 140 lumens per watt output.

## EFFORTLESS INSTALLATION THANKS TO OUR NEW QUICK-FIX BRACKETS

- T-shaped brackets to hang and hold Nanolight in place whilst fastening.
- Strong yet unobtrusive, perfectly coordinated with Nanolight.
- 4-way adjustability to reach the preferred angle.
- Available in various sizes for ideal light projection.
- Powder coated and finished to match Nanolight.



*Nanolight also fits on to our current range of brackets.*

## A REFRESHED PICTORIAL BRACKET SYSTEM

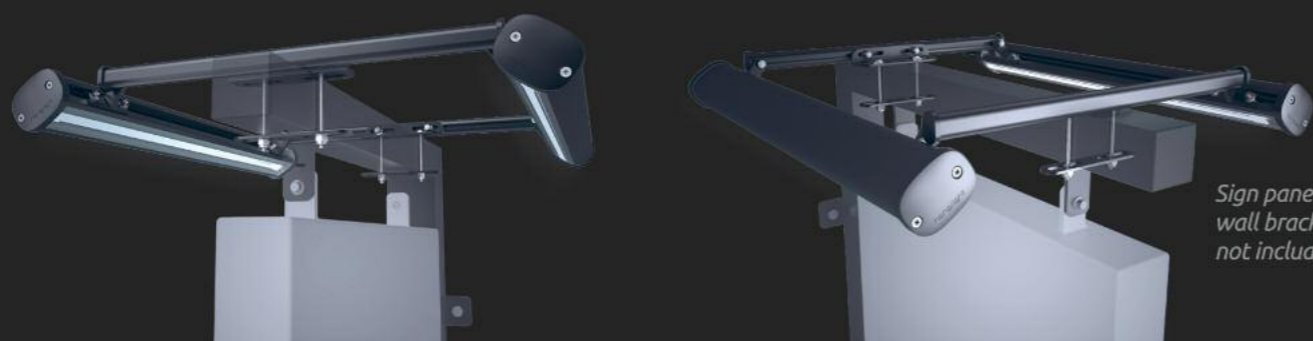

*Sign panel and wall bracket not included*

We have also created a new 4-way adjustable pictorial bracket set to complement Nanolight on existing wall mounted hanging signs. Simply clamp the brackets on to the sign and hook Nanolight on to the brackets in the same convenient way as our quick-fix brackets.

## A ROBUST AND RELIABLE CONNECTOR TO JOIN TWO OR MORE UNITS

Nanolight can be manufactured to any length, supplied in sections of up to 4575mm (15ft). For sizes greater than 4575mm, two or more sections can easily be connected together using our innovative middle connector system. This consists of two parts, which bolt together to provide strength, each independently sealed to prevent water ingress. Power is transferred through a 'plug and play' IP67 rated connector, which can handle up to 240 volts.

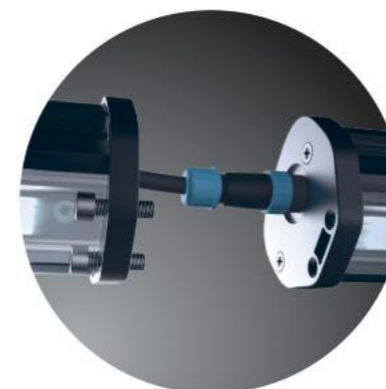

*Versatile IP67 rated power connector handles up to 240 volts.*

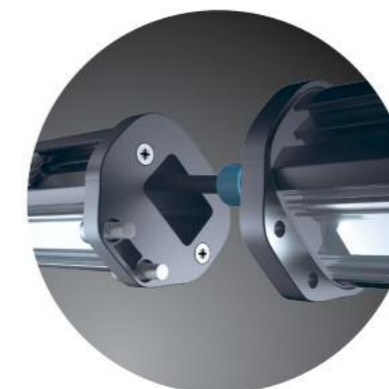

*The power connector is neatly concealed in a waterproof compartment.*



*Both parts bolt together to provide a secure seal.*

## MAIN BENEFITS

- Choice of LEDs 6000K cool white as standard. Or choose 3000K warm white.
- Maintenance friendly. Quick release LED drivers accessed via end cap.
- Dual extruded lens with built in gaskets.
- Magnifying lens to maximise light output.
- Powder coated in-house. Black or white as standard. Or available in most RAL colours.
- 5 year parts warranty for peace of mind.
- Stunning design, slim 47mm profile.
- Made to order to any length. In 4575mm sections maximum.

*Visit our website or contact us for further details.*

📍 Unit 1, Wortley Moor Lane, Leeds, LS12 4JD  
☎ 01132 799745 ✉ sales@visiondepot.co.uk

[www.visiondepot.co.uk](http://www.visiondepot.co.uk)

**VISIONDEPOT** Ltd  
Manufacturers & Suppliers of Sign Lighting



## CMYUK appointed Ritrama distributor

CMYUK has been appointed as official UK distributor for Ritrama's expanding range of self-adhesive materials. This marks another important move by both companies, as they increase their impact on the digital printing segment, in-line with the demand for new and innovative applications and opportunities, say the companies.

CMYUK's approach and strategy to market has seen its customer base rise exponentially. The addition of Ritrama enables greater reach into new areas across the display and sign-making segments, according to CMYUK. Extended and existing products across the portfolio will be showcased throughout 2017, backed up by on-line and live examples of applications and innovative uses.

As part of the distribution agreement, CMYUK understand HP's latex certifications for Ritrama products, to make sure all new and existing customers are able to benefit from full compliance. This removes any queries and questions that can arise when working with interior and exterior materials across all environments.



Wall graphics produced using Ritrama materials.

"CMYUK is exactly the type of dynamic and forward-thinking company that we need to work with to achieve our expansion goals," says Lee Ward, Sales Director at Ritrama.

"This distribution agreement enables us to promote through the new channel our existing and new ranges being developed, such as Deco-Wall and Hi-Grip's vinyls."

[www.cmyuk.com](http://www.cmyuk.com)

## Roland DG launches new website

Roland DG (UK) Ltd has launched a new company website, with an interactive and responsive design, to improve visitor experience. The website, which functions as the hub of Roland DG online, reflects the brand's values and ethos of being the 'easiest company to work with', says the company.

Featuring information, specifications, brochures, imagery and inspirational videos of all Roland DG technologies, the website structure is developed so visitors easily find the content they need. The reactive platform means that end-users can also easily view information on phones

and tablets; with enhanced product pages that detail information in an attractive layout.

Helping to inspire visitors with the wide-variety of profitable solutions that Roland DG technology can assist with; a showcase menu includes information on some of the endless lists of applications that can be created. Alongside customer success stories, contests and awards, and information about the Roland DG Creative Centre.

To help Roland DG owners get the best out of their technology, the RolandCare menu provides information on warranties, plus houses an online resources centre where manuals, drivers and FAQs can be found. A dedicated Roland DG Academy zone provides information on the wide-range of courses available, along with a new online booking system.

[www.rolanddg.com](http://www.rolanddg.com) / [www.rolanddg.co.uk](http://www.rolanddg.co.uk)

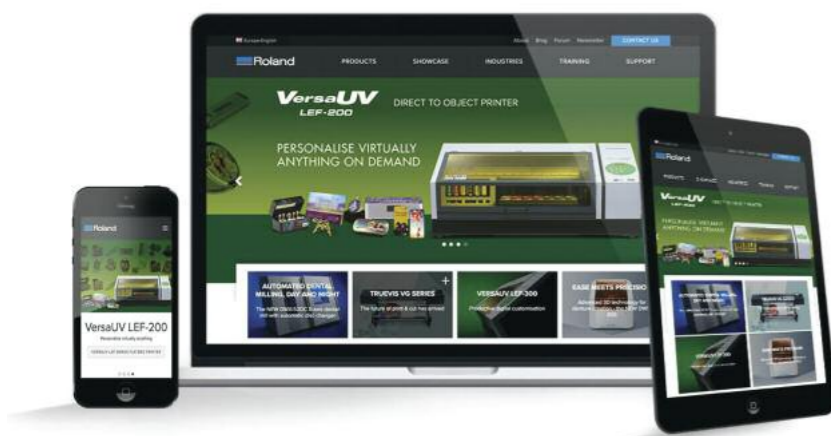

## → 1<sup>st</sup> class laser systems and engraving supplies for the sign & display industries

**trotec**  
laser. marking cutting engraving  
setting new standards

Choose a Trotec laser machine for:

- Precision contour cutting and engraving detail
- A low maintenance, all-in-one solution
- Expert support & advice

A wide range of sign and engraving supplies:

- Next day delivery
- Cut to size service
- Quality products & service

If you want to arrange a laser machine demonstration or find out more about our materials range.

Call us on: 0191 580 1182  
Or visit: [www.troteclaser.co.uk](http://www.troteclaser.co.uk)  
[www.engraving-supplies.co.uk](http://www.engraving-supplies.co.uk)



You can now buy **MODULAR** Signage Systems in component form from Ashby

**Ashby**  
Trade Sign Supplies

75mm Round Modular Metal Post Cap (White)  
MPCAP75MRW  
£2.26 (Each)

100mm Modular Plank Extrusion (4.2m long) White  
MPL100W4.2  
£22.26 (Each)

Modular Cap Screw (Large)  
MCPMCS4.8x19  
£0.02 (Each)

Modular Fillet Extrusion (3.0m long) White  
MPTW3.0  
£6.58 (Each)

Modular Post Mounted Plank Screw (Small)  
MPMPS4.2x50  
£0.04 (Each)

75mm Modular Round Post (6.0m long) White  
MP75RW6.0  
£59.05 (Each)

Technical Specification & Price List

Component Brochures available now

www.ashbytrade.net  
+44 (0) 118 981 5343  
8.00am - 7.00pm, Monday to Friday

Total price (Per Sign)  
**Only £46.47**  
Carriage/VAT (Excluded)  
\*Price correct when bought in component form for bulk manufacture



## FESPA 2017 seminar programme

FESPA's seminar programme will "deliver key insights and market knowledge" across the sign-making, digital, screen, industrial, textile and interior printing industries. It takes place at Messe Hamburg from 8 to 12 May 2017.

The FESPA seminar schedule offers educational content from speakers, which will be delivered daily in one theatre. Through inspirational content FESPA is able to provide delegates with a varied schedule of bite size seminar content created with speciality printers and sign-makers in mind, say the organisers.

The seminar programme covers a range of topics, which focus on the use of digital, screen and textile print technology in a variety of scenarios. Delegates attending these seminars have exclusive access to insights and discussions with industry experts, who will provide invaluable knowledge and understanding across a wide portfolio of printing applications.

Duncan MacOwan, Head of Events and New Media at FESPA, said: "This year we have consolidated our educational offering into one main seminar theatre. The theatre, located on the show floor, will address the needs of visitors to FESPA 2017, European Sign Expo and Printers' use code: FESM707 when registering."



This year's seminars will take place in one theatre and covers a range of topics.

Seminars start at 2pm on Monday 8 May and run until 1pm on Friday 12 May. Sessions throughout the event will include, but are not limited to, How to create a great retail experience by Mal MacGowan, Owner, McGowans; Print: A Designers' creative journey to market by Debbie McKeegan, Creative Director, Digetex; European Sign Code of Practice by Luc Steegmans Owner at ELBO Signs And Technology - ESF European Sign Federa-

tion; and New measurement method of light emission by Ralph Hug, Engineer, Swiss Association VWP.

For more information on FESPA 2017, to register and to view the entire seminar schedule visit [www.fespa2017.com](http://www.fespa2017.com). For free entry to FESPA 2017, European Sign Expo and Printers' use code: FESM707 when registering.

## New website for Grafityp

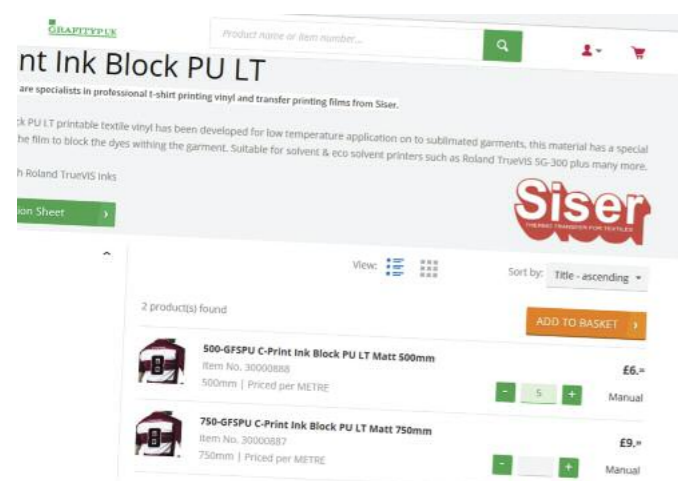

Grafityp UK Ltd recently launched their new website, which has a "bright new look and easy navigation that makes the site user friendly, to encourage users to return time and again".

The site offers secure online ordering, and for larger products such as machinery (printers, lasers) they can give a quote to get their best price at the time. Orders can be placed out of hours on evenings and weekends and will be processed directly on their return to the office.

There is access to a range of documents relating to products, such as specification sheets to ensure you have the right material for the job with the required features, and application instructions for garment decorators. Download drivers for vinyl cutters and laser machines; ICC profiles for printers; or digital editions of their latest price lists and catalogues. View a range of product videos, see what events they will be exhibiting at or read the latest product news.

[www.grafityp.co.uk](http://www.grafityp.co.uk)

## HNS's Arcadian project shortlisted for award

HNS Signs new signage for Arcadian nightclub in Birmingham has been shortlisted for a FESPA award, the independent global print and signage awards to be held in Hamburg in May.

Competing against hundreds of other nominees, HNS Signs say they are overwhelmed with the judges feedback and are getting ready for the event in May.

Michelle Henry, Managing Director at HNS Signs: "We worked really hard with Studio Able to deliver such an innovative and exciting signage solution at The Arcadian, which took a number of days and nights to complete."



The shortlisted project – the Arcadian nightclub in Birmingham.

FESPA Awards are an annual global celebration of excellence in the print and signage industry, recognising world-class projects and we were overwhelmed with submissions this year.

"Projecting 30 metre long images across the buildings to outline was particularly interesting, especially after dark!. But it was the only way to hand paint a 30 metre long sign professionally, and we are over the moon it has been recognised by a global body.

"The Arcadian project was the perfect canvas for us to not only do what we do best, which is deliver stand out signage but also showcases how creative and flexible we are."

HNS Signs were asked to hand finish "perspective art onto the sides of the building to bring the site to life along with new, and 'on trend' hand painted way finding signage across the centre".

Five shortlisted entries within the non-printed signage category are: Harley Davidson in Hungary, Seville FC in Spain, The

Devon Lash Dolls, UK, Zenith in Belgium and The Arcadian.

The two-phase project had started in September, and mixed traditional sign painting techniques with new technology to deliver a "big, bold and beautiful" wayfinding project to a tired, once loved Birmingham venue.

Duncan MacOwan, Head of Events at FESPA adds: "FESPA Awards are an annual global celebration of excellence in the print and signage industry, recognising world-class projects and we were overwhelmed with submissions this year."

## Unibox win SDEA Best Stand Award at EuroShop 2017

A leading panel of industry experts voted Unibox the winner of the SDEA Best Stand Award at the world's largest shopfitting, display, PoP and exhibition systems show this year.

Unibox, retail display and lighting technology specialists, faced stiff competition from many British and European companies exhibiting at the show. Alan Pegram, SDEA

President and managing director of Global Display, said: "All the stands were of a very high calibre but Unibox had the best use of space and clear messaging."

The award was presented to director, Cliff Thornton on the Unibox stand by SDEA Director, Antony Behiels.

[www.shopdisplay.org](http://www.shopdisplay.org)



SDEA Director Antony Behiels, (r) presents the SDEA Best Stand Award to Cliff Thornton of Unibox.



# trade services

Totally in house production facilities allow us to have complete control over your requirements. Established since 1962 our highly experienced staff will be able to advise and quote on your requirements

trade cut-outs and moulded lettering

**ACRYLIC** (Perspex - Colours Gold & Silver add 10% for Gold & Silver) £18 + VAT minimum charge + carriage

Height	75mm	100mm	125mm	150mm	175mm	200mm	225mm	250mm	275mm	300mm	350mm	400mm	450mm	500mm	550mm	600mm	700mm	800mm	900mm	1200mm
<b>3mm</b>	0.90	1.10	1.20	1.40	1.75	2.25	2.75	3.10	3.75	4.35	5.50	7.00	8.00	9.00	11.00	13.50	17.00	30.00	37.00	48.00
<b>5mm</b>	1.30	1.65	1.80	2.30	2.90	3.50	3.95	5.40	6.45	7.50	8.75	10.00	12.00	14.50	16.74	18.00	23.50	30.00	45.00	62.00
<b>10mm</b>	2.50	2.80	3.70	4.60	5.75	7.35	8.55	12.00	13.00	15.75	18.50	21.50	24.50	28.50	32.00	36.00	50.00	73.00	94.00	130.00

**FOAM PVC** (all available colours - 10mm & 19mm available in white only) £18 + VAT minimum charge + carriage

Height	75mm	100mm	125mm	150mm	175mm	200mm	225mm	250mm	275mm	300mm	350mm	400mm	450mm	500mm	550mm	600mm	700mm	800mm	900mm	1200mm
<b>3mm</b>	0.75	1.06	1.12	1.20	1.30	1.51	1.90	2.30	2.60	2.90	3.73	4.60	5.20	5.60	6.70	7.90	10.50	16.50	19.00	22.50
<b>5mm</b>	0.95	1.25	1.55	1.90	2.30	2.70	3.10	3.40	3.95	4.50	5.62	6.60	7.50	8.00	9.30	10.60	16.50	22.50	25.00	28.50
<b>10mm</b>	1.70	1.90	2.60	3.60	4.20	4.85	5.95	6.92	7.90	8.80	10.60	12.60	15.00	16.50	18.50	21.50	26.00	30.00	45.50	56.00
<b>19mm</b>	2.80	3.80	4.40	4.80	6.40	7.50	9.00	10.50	12.70	14.90	16.00	18.50	21.50	23.80	25.80	29.00	37.00	40.00	53.50	84.50

**3mm ALUMINIUM COMPOSITE** (Dibond, Alupanel) £18 + VAT minimum charge + carriage

Height	75mm	100mm	125mm	150mm	175mm	200mm	225mm	250mm	275mm	300mm	350mm	400mm	450mm	500mm	550mm	600mm	700mm	800mm	900mm	1200mm
<b>Colours</b>	1.65	2.00	2.50	2.95	3.50	4.50	5.50	6.59	7.60	8.43	10.26	11.50	14.00	16.00	17.00	20.50	24.50	35.00	46.00	63.00
<b>Mirror</b>	2.50	2.90	4.00	5.00	6.50	8.00	9.00	11.00	13.50	16.00	17.50	20.00	23.50	26.50	28.00	32.50	38.00	47.50	51.00	96.50
<b>Brushed</b>	1.85	2.20	2.80	3.50	4.00	4.90	5.90	7.00	8.50	10.00	11.50	13.00	16.00	17.50	19.50	22.00	29.00	39.00	49.00	67.50

**MILL FINISH ALUMINIUM** (Comes in its raw form ready for coating) £18 + VAT minimum charge + carriage

Height	50mm	75mm	100mm	125mm	150mm	175mm	200mm	225mm	250mm	275mm	300mm	375mm	425mm	500mm	600mm	700mm
<b>2mm</b>	2.88	3.80	4.30	5.75	6.50	7.25	8.20	9.45	10.50	11.55	12.75	15.85	18.80	26.90	36.00	49.50
<b>3mm</b>	3.20	4.20	4.80	5.90	6.80	7.60	8.50	9.70	10.85	12.50	13.95	17.90	21.40	29.90	42.00	66.00
<b>5mm</b>	3.50	4.60	5.50	6.60	7.40	8.50	9.60	11.20	12.90	14.85	16.75	21.65	25.00	34.75	49.00	71.60

**EXTERIOR MDF** £18 + VAT minimum charge + carriage

Height	50mm	75mm	100mm	125mm	150mm	175mm	200mm	225mm	250mm	275mm	300mm	375mm	425mm	500mm	600mm	700mm
<b>6mm</b>	0.58	1.10	1.64	1.83	2.70	2.85	3.30	3.95	4.55	5.40	6.90	9.75	11.25	12.75	14.95	45.50
<b>12mm</b>		1.90	2.12	2.96	4.25	4.90	5.70	6.42	7.65	9.60	10.50	12.20	14.50	17.60	19.75	59.95
<b>18mm</b>		2.70	3.25	4.25	5.30	6.45	7.95	8.90	11.05	12.75	15.20	17.40	21.25	22.90	29.95	89.63

Add 20% for locators and layout Add 30% for 3mm letters Add 30% for Cladded fascia drawing

**MOULDED ACRYLIC LETTERING** (Including locators and paper template) \*ADD 10% FOR SILVER & GOLD

Height	152mm	203mm	254mm	305mm	380mm	457mm	610mm
<b>Colours*</b>	5.80	9.00	10.50	12.50	15.50	18.50	38.39

Stock Styles: HELVETICA BOLD, TIMES BOLD & CLARENDON MEDIUM  
Quotes for logos & non-standard typestyles

Quotes on request for extended typestyles, logos, flame polishing and spraying  
All prices are exclusive of VAT. Delivery at £20.00 on all orders upto £300

Discounts Available ...over £50 - 3% over £100 - 4% over £300 - 5%

Tel: 01603 666699 F: 01603 616781 sales@mercuryphillips.co.uk  
Check out our website - www.mercuryphillipssigns.co.uk

## why not take advantage....

- ➔ **Acrylic Fabrication**  
Built up letters and logos, industrial and medical covers and guards, point of sale, display cases and much more...  
CNC cutting and routing.  
Diamond and flame polishing facilities.
- ➔ **Moulding**  
From design to finished job. We can create your tooling and produce from a large range of materials such as: PETG, Acrylic, Hips, ABS and more...
- ➔ **Screen & Digital print**  
From 1 to 100,000 printing on automated machines. Full colour up to 1500 x 1000mm on a large range of materials..
- ➔ **Etching & Engraving**  
Your design on to stainless steel, brass, bronze and more. Filled spot or even full colour if required.
- ➔ **Metal Fabrication**  
Built up letters from stainless steel, box and pan form trays in composite, aluminium and steel. Bespoke one-offs.



call mercury phillips today..  
T: 01603 666699 F: 01603 616781  
sales@mercuryphillips.co.uk  
Check out our website - www.mercuryphillipssigns.co.uk



**OTHER TRADE SERVICES:**  
ACRYLIC FABRICATION, MOULDING, SCREEN & DIGITAL PRINT, ETCHING (ENGRAVING) & METAL FABRICATION



## Signage firm partner with motorsport event

Hardy Signs have a new partnership with Chateau Impney Hotel and Exhibition Centre, and in particular, the Chateau Impney Hill Climb event.

The deal sees Hardy Signs named as official signage partner to the hotel, a Grade II listed 19th-century house built in the style of a French château near Droitwich Spa in Worcestershire.

The Hill Climb is a revival motorsport event that takes place annually in 140 acres of picturesque grounds, and the company's support of the event will form part of the package that includes the exclusive spon-

sorship of the finish line at the event, which returns on Saturday 8 and Sunday 9 July 2017.

More than 200 invited pre-1967 cars will tackle the challenging 885-metre course along with exotic cars and bikes from every era performing demonstration runs.

With more than 15,000 people expected over the weekend and coverage on national TV, Hardy Signs will provide solutions to inform, direct and promote the visiting public, exhibitors and sponsors.

[www.hardysigns.co.uk](http://www.hardysigns.co.uk)



Hardy Signs agree the partnership with Chateau Impney Hotel in February this year.

## Printwear & Promotion LIVE! fulfils pre-show promise

2017 was yet another exceptional year for Printwear & Promotion LIVE! say the organisers. From Sunday until Tuesday, Hall 20 at the NEC in Birmingham was packed full of visitors. A total of 5,620 people from around the world came to discover new developments and products within the garment and promotional product decoration industry.

"This year, P&P LIVE! truly fulfilled the promise of there being 'even more to see'. Having doubled in size over the last five years, P&P LIVE! moved from Hall 12 to the larger Hall 20 to accommodate further growth. With over 30 new exhibitors joining those from previous years, such as Stormtech, Kariban, Sanco Technology and Xpres, there was a record high of over 160 stands exhibiting advancements and innovations in the printwear field. This year's show was without a doubt a huge success on all fronts," says event director Tony Gardner. "In addition to numerous live machinery demonstrations, there were over 30 equipment and garment launches at this year's show!"

P&P LIVE! 2017 was a fantastic year for exhibitors, with a large number of new clients and existing contacts present at the event. Scott Mason, sales manager at AJS Embroidery Services, said: "In my experi-

ence over the last 21 years of attending Printwear & Promotion LIVE!, I can honestly say, I think this was the best show ever.

"The quality of potential customers visiting this year was phenomenal. Every enquiry was a quality enquiry and the general feedback from visitors was that our trade is busy, growing and everyone was generally ultra-positive about the future."

The seminar programme proved as popular as ever, offering specialist-led talks on developments, discoveries and expansions within garment decoration. Oliver Luedtke, director of marketing at Kornit Digital Europe, discussed the concept of mass customisation and the technical developments that make it possible in the textile industry. While Karen Burrows of Madeira UK spoke about the fine details of embroidery.

P&P LIVE! 2017 was attended by both returning and new guests. New visitors Tom Cooney and Thomas Self of Northern Golf & Embroidery said: "It was our first time at the show and we found it extremely useful. We have learnt a lot from our visit, in particular about the garment technology out there." Returning visitor Loyd Canty of L.S. Canty Promotional Printing, said: "It's lovely

to see the way technology and garments are progressing, because when I started in the industry over 50 years ago the industry was a very different place. I really enjoy coming to the show and will come back next year to see what's new again."

Special show features included the energetic and entertaining fashion show, showcasing the latest lines in leisure wear, sportswear, outdoor clothing and workwear, once again sponsored by Regatta. The Screen Print Workshop which returned for a second time following its success at the 2016 show. And the Bag and Headwear Decoration Advice stand sponsored by Beechfield Brands.

Tony said: "For some time the major printwear brands and distributors have wanted the show to move into January to better coincide with the launch of their new lines at the start of the year. Consequently, for 2018 we have been able to secure earlier dates, as well as halls that allow for yet further expansion."

Next year, Printwear & Promotion LIVE! will take place in Halls 17 and 18 at the NEC and will run from Sunday, 21 January to Tuesday, 23 January. Save the date!

## Check into the Printeriors hotel

The global print community is invited to visit Printeriors 2017, an interior design showcase that illustrates how print can be used to create stand-out interior design applications, from 8 to 12 May 2017 at Messe Hamburg, Germany.

This unique event, presented in the style of a hotel, will show print service providers, sign-makers, interior designers and architects how they can realise the potential of print, and develop new business opportunities.

Through room sets created using a combination of screen, digital and textile print technology, visitors to Printeriors 2017 there will be "endless" opportunities in the form of printed flooring, wallpaper, soft furnishings (including bed linen and curtains), ceramics, glass, mirrored surfaces, furniture and decorative textiles, all using the latest printing techniques.

The showcase, which will run for five days in hall B2 lower, will be complemented by a half day conference on Thursday 11 May. The conference, for interior designers and architects, will explore the

benefits of using print as a medium for interior design and how it can transform interiors. Conference delegates will also be able to join a guided tour of Printeriors by curator Jennifer Castoldi, CEO and Chief Creative Director, Trendease International LLC, who will demonstrate how the tools and insight they've heard in the conference can produce real life applications.

For more information on Printeriors and to register to attend, visit: [www.printeriors.net](http://www.printeriors.net) for free entry use code PRNM701 when registering.



## Printeriors Conference

FESPA has announced the line-up for the 2017 Printeriors Conference, which will take place on Thursday 11 May 2017 during FESPA 2017.

Drawing on their experience, speakers will explore the benefits of using print as a medium for interior design and will offer real-life examples of how it can transform

interiors, whether residential or commercial, say the organisers.

Delivered in three main sessions: The interior trends you'll be loving in 2017/18; Inspiration hour, stand out from the crowd; and Design beyond your eye, the conference will focus on topics key to the industry, providing valuable insight into print in interior design applications.

Roz McGuinness, Divisional Director, FESPA said: "The conference programme has been created with the aim to inspire and engage, showing designers just what is possible when using print for interior décor. As technology has evolved, so too have the possibilities."

There is no cost to attend the Printeriors Conference, to reserve your place visit [www.printeriors.net](http://www.printeriors.net) and use promotional code PRCM701.



The Printeriors Conference at FESPA last year. This year's Printeriors is a half day conference.



## Wrap Master winner

Patrick Charrier of Bazoom Studio, France has won FESPA's World Wrap Masters Design Competition. The winning design will be applied to a speedboat used by the Haugaard Racing Team in the 2017 World Formula 4 UIM Powerboat Championship.

Participants were required to produce an attention-grabbing design demonstrating their creative skills to qualify. Prerequisites for the design included the boat number (22), the racing team's logo and World Wrap Masters sponsor, Hexis' logo.

Patrick's design will be printed and installed during the World Wrap Masters Final, taking place at FESPA 2017 in Hamburg. Patrick Charrier said: "I was overwhelmed when I heard I'd won the design competition. I can't wait to see the professional installers performing their art at the World Wrap Masters Series Final in Hamburg.

"The inspiration for my design came from the Danish Drakkar (aka Viking longboat). The general idea was to give an impression of movement to the boat, even when it's at a standstill. Blue and white are the

top colours for a boat - lots of white for the pontoons to contrast with the surface of the water. The graduated honeycomb patterns evoke the composite materials used to construct the boat. The stars are included to reference the pilot, the tightrope walker in his cockpit, as well as a nod to shooting stars and speed on water."

The winning design was chosen by the driver of the raceboat, Sebastian Haugaard Trads, and the World Wrap Masters Series head judge, Ole Solskin Ravn. Sebastian said: "Bazoom Studio's design is unique and personal, incorporating beautiful flow lines and colours. We have not yet seen similar designs in the racing community and are confident this design will differentiate us in the field. We look forward to meeting Patrick at FESPA 2017 and seeing his design come to life."

Visitors to FESPA 2017 will be able to see the boat being wrapped with Patrick's design during the live final on the 10 and 11 May 2017.



The winning design by Bazoom Studio in France.

Vehicle wrappers still have the opportunity to enter the Wrap Masters Europe competition at FESPA 2017, where they will have the chance to showcase their wrap skills and compete against the world's best installers. The winners will then go on to compete in the World Wrap Masters Series Final.

[www.fespa2017.com](http://www.fespa2017.com)

## STORMBOARD wins Ecobuild and M&S Big Innovation Pitch

STORMBOARD™, the sustainable alternative to plywood used for hoardings and other applications, is the joint winner of the M&S Big Innovation Pitch at Ecobuild 2017.

Manufactured by Protomax Plastics and distributed exclusively in the UK by Amari Plastics, STORMBOARD is a sustainable alternative to plywood produced from mixed

waste plastics. Much plywood is used for temporary works such as hoardings and needs to be clad in costly PVC and paint before ending life in landfill.

Nico Stillwell, Imagineer from Protomax Plastics said: "I didn't expect to win at all. Our idea was so different because no one else was talking about recycling but it seems to have captured the imagination of M&S."

Jamie Manifold of Amari Plastics said: "This is a well deserved accolade for Protomax Plastics. STORMBOARD is a truly innovative material that addresses a global sustainability issue by reducing pressure on landfill. Protomax has invested heavily in manufacturing infrastructure so we will be well placed to meet supply requirements from M&S and other customers."

Ecobuild's Big Innovation Pitch is in its third consecutive year and provides the industry with a platform to pitch innovative building products and engineering solutions.

[www.ecobuild.co.uk/BIP](http://www.ecobuild.co.uk/BIP)  
[www.amariplastics.com](http://www.amariplastics.com)



Nico Stillwell of Protomax Plastics (5th from left) accepted the M&S Big Innovation Pitch award at London's Ecobuild event.

## StackaWraps™ attract industry investment

Ben Moss and Rob Kelly, independent owners of various display graphics businesses and previous directors of the likes of Service Graphics Ltd and St Ives plc, are investing in UK based StackaWraps™.



Stackawraps can be used for product launches, events, exhibitions, retail visuals and sporting events.

Ben said: "I have been working in the graphics and display markets for three decades and have not seen a product as clever as this one since the invention of the 'pop up' display system; it genuinely made me excited to see if I could get involved."

The StackWraps™ method is a unique system that reproduces a photo-realistic large scale 3D version of any product. Giant drinks bottles, baked bean cans, perfume bottles or any type of packaged product can be produced cost effectively and without the need of a 3D printer or expensive 3D model maker. The products are distributed flat packed and assemble in minutes.

Rob said: "When I saw an image of a six foot high drinks bottle that looked like a solid object I thought well I've seen this before, so what? Then I realised that it was made up of a photo realistic graphic wrap zipped around a frame that flat packs! The products look real, not like a 3D printed and painted version or a 3D model and they have all the shadows, curves and features of the real thing. In fact if you look at a photo of one in isolation it looks like a normal product shot until you realise it is as tall as a person."

[hello@stackawraps.com](mailto:hello@stackawraps.com)



Their software scans the original product, generating a digital 3D blueprint. A precise framework is then laser cut from MDF and all parts are numbered making for easy assembly in minutes.

## Europoint partners Superbike rider to add ColorFlow™ to his performance

Europoint has partnered with British Superbike Rider, Shaun Winfield, who is part of the Anvil Hire Tag Yamaha team. Making his debut at the MCE British Superbike

Championship in 2014, Shaun has progressed to the premier class after competing in the National Superstock 1000 Championship.

Europoint and Shaun Winfield came together following an enquiry for Europoint's new Avery Supreme Wrapping™ Film ColorFlow™ series for Shaun's race helmets. With five colour shifting iridescent shades it transforms into works of art, providing superior performance and conformability around curves and recesses, says the company. Shaun decided to go with a mixture of 'Roaring Thunder' and 'Fresh Spring' colours and said: "It's amazing and so easy to fit. I really want the helmet to stand out on the track with the movement of colour".

Margaret Smith, Service Centre Manager, Europoint said: "We will support his pursuit of achieving championship points and are delighted by his choice of our range of extensive of market leading brands in our joint quest to add innovation in this sporting arena."

[www.europoint.co](http://www.europoint.co)



Shaun Winfield with his helmet



# CLASSIFIED

Check our website for the latest job vacancies or items for sale.

## EQUIPMENT FOR SALE

### Mimaki JV33 Printers

AIT



Fully refurbished from  
**£5,495\***  
Also available:  
CG-FX Cutters and Laminators

\*Plus VAT

[www.applied-image.com](http://www.applied-image.com)

### Sign Making and Industrial Engraving company

#### For sale in Nottinghamshire

Well established with a strong customer database with repeat orders for Sign Making, Vehicle Graphics and Engraving, (both rotary and laser), Banners, CNC Routing, Commemorative Plaques and Nameplates, s/a Labels, Stainless Steel Machinery ID Plates and Electrical Components.  
Sale to include all stock, machinery and equipment.

- Assets include:
- Roland SP-540V Digital Printer
  - Roland SP-300 Digital Printer
  - Graphtec CE5000-120 Vinyl Cutter/Plotter
  - Universal Pro-Series Laser Engraver
  - AXYZ CNC Machine
  - Meistergram 2412 Engraving Machine
  - Meistergram PA912 Engraving Machine
  - Gem . U-Marq Engraving Machine
  - Easymount Laminator EM-S1400C
  - Easymount Laminator EM 720
  - Kimoto/Freejet 330 Flatbed Printer
  - A3 Acid Etching System by Mega
  - 24" Gravograph Flatbed Saw SX20845
  - Wall Saw
  - G.H. Alexander ( pantograph ) Machine
  - Guillotine
  - 2 x Pillar Drills
  - Spray Booth
  - 2 x Bevelling Machines
  - Cutter Grinder / Sharpener

**£220,000**

Tel: 0115 931 2777

For more information please contact:  
K. J. Eaton & Co. Accountants. 32 Main Street, Lambley, Nottingham. NG4 4PN

## EQUIPMENT WANTED (TRADE)

### DIGITAL PRINTERS

## WANTED

DEAD or ALIVE

CASH WAITING

07841 158 330

[Kaput-printers@mail.com](mailto:Kaput-printers@mail.com)  
Chinese Machines? - Yes Please!

### WANTED

Engraving Machines  
manual and computerised, most makes, in any condition.

Tel: 01992 899 255

Fax: 01992 899 256

Evening Tel: 01707 872 991

[sales@ronamachines.co.uk](mailto:sales@ronamachines.co.uk)  
[ronamachines.co.uk](http://ronamachines.co.uk)

## JOB VACANCIES

# Sign Maker, Artworker and Project Manager Gatwick

A unique opportunity has arisen in a small, but highly successful sign unit of a UK & European based Safety Company. From brief to manufacture we are looking for an individual who can successfully plan and assist in delivering our signage services. The successful candidate will be a team player and highly motivated to deliver excellent customer service.

### Key roles and responsibilities:

- Artwork generation
- Creating sign schemes for client approval
- Specification of sign materials
- Responding to clients requests in a timely manner
- Wide format printing of signs
- Application of printed signs to substrates

### Required Skills:

- Experience in Signage Installation
- Computer literate
- Good knowledge of Adobe illustrator
- Good knowledge of Microsoft Office
- Basic understanding of large format printing
- Enthusiastic approach to work
- Ability to communicate ideas clearly
- Strong planning and organisation
- Effective time management

Please send CV to [ukrecruitment@anderco.eu](mailto:ukrecruitment@anderco.eu)

Closing date: 31/05/2017

**anderco**<sup>®</sup>  
when know-how matters



QUALITY ENGINEERS OF SIGNS AND GRAPHICS

## NATIONAL SALES EXEC

Have a background in sales of signs & graphics and looking for a change or new challenge?

Brand Consortia are a rapidly expanding National Signage and Rebranding Contractor based in Greater Manchester.

We have a strong belief in forging lasting relationships with our nationally recognised clients. We're looking for the right person, passionate about what they do, to help grow our Business Development team. After several successful years we are well into our major growth initiative and we would love to hear from a like-minded professional who believes they have the knowledge & drive to join us on this journey.

The role is not necessarily office based as it may involve travelling nationally to help develop long-lasting relationships with future partners.

We're proud to design, manufacture, install and maintain - from start to finish - using our recently refitted in-house manufacturing facilities.

We are driven by an exceptionally customer-focussed, loyal & talented team.

We aim to make your job as easy as possible and our tight control on quality along with our efficient working methods help to ensure that your quotes can be very competitive without your margins suffering. Expanding our accreditations with our new ISO14001 Environmental Award will help you stand out from the crowd.

The position warrants past experience in a successful sign and graphics sales role (or allied trade such as shop-fitting). We will offer a package that will exceed your expectations for results that will exceed ours.

Give us a call 0845 2000 768 and have a chat about the role, or email [hr@brandconsortia.com](mailto:hr@brandconsortia.com) (strictly no agencies please)



- ✓ Environmentally sound
- ✓ Quality Assured
- ✓ Safety First

Hiring Now - Call 0845 2000 768

0845 2000 768 @letstalkMCR brandconsortia.com

## perfectionist projects limited

Expert Signage Support  
- Nationwide

Experienced Sign Fitters wanted  
**across the UK**

We are a trade installation company providing installation resource to the Sign, POS & Print industries across the UK.

### Our employment benefits include;

- 24 hour phone support for engineers
- 30 days annual leave per year
- Guaranteed 35 working hours per week
- Paid lunch breaks
- Double time for Sunday working

If you have proven industry experience installing a variety of traditional signage including illuminated, neon and LED across all market sectors and are CSCS, UKATA IPAF and PASMA trained we welcome your application.



If you are interested, please contact Caroline Stevens on 01323 489361 or send an email to [cstevens@perfectionistprojects.co.uk](mailto:cstevens@perfectionistprojects.co.uk)  
[www.perfectionistprojects.co.uk](http://www.perfectionistprojects.co.uk)



## WWW.SPECIALIZED SIGNS.CO.UK

PROJECT MANAGER  
&  
OPERATIONS MANAGER

EDINBURGH

PROVIDING SCOTLANDS SIGNAGE

SALARY NEGOTIABLE  
PLEASE EMAIL YOUR CV TO  
[INFO@SPECIALIZEDSIGNS.CO.UK](mailto:INFO@SPECIALIZEDSIGNS.CO.UK)

OR CALL 0131 337 1237  
FOR MORE DETAILS

(MUST BE WILLING TO RELOCATE)



EXPERIENCED SIGN FITTERS WANTED IN  
**NEW ZEALAND**

Neo Neon Signs is a highly regarded signage manufacturing and printing company trading for over 35 years. We are a professional and growing business with a great culture. We work with some of New Zealand's leading corporate companies.

### TRADITIONAL SIGNAGE INCLUDES

- Fascias
- LED and Neon
- Sign assembly
- Graphics

### REQUIRED SKILLSET

- 5 - 10 years' sign fitting experience
- Team leader
- Smart device literate
- Great communication skills

Send CV and covering letter to [richard@neoneon.co.nz](mailto:richard@neoneon.co.nz)



# Sign Business Share

## Bedfordshire

Signs of the Times Ltd, www.sott.co.uk, in Bedfordshire are looking for someone to invest in part of the business and to share in the management/day to day running. The position has become vacant due to retirement.

We are looking for someone who has an interest in all aspects of the business but perhaps a particular interest in marketing to open up new sales channels possibly in the building sector but also to share in the management and direction of the company.

Our customer base is large and extremely varied including local authorities, sign companies and to a lesser extent construction firms.

The company has stable profitability and has been running for more than 35 years.

If you would like more information on this opportunity, please contact:  
SOTT c/o Maidment Judd Ltd, Charter House, Marlborough Park, Southdown Road, Harpenden, Herts, AL5 1NL  
mivey@maidmentjudd.com Tel: 0755 444 1522

### Vinyl Graphics and Large Format Printer/ Studio All Rounder Leeds, West Yorkshire

We are looking for someone who is experienced in the production of vinyl signage, large format print, graphic application and general sign design and manufacture.





To join our professional team, the right candidate will have around 5 years' experience in the graphics and signage industry and have the flexibility to travel at short notice. For these skills and commitment we offer professional development opportunities and a negotiable salary.

www.signupdate.co.uk/vglfpl



## Sign Trade SUPPLIER

sales@whitevilla.co.uk

<p><b>LIGHT BOXES &amp; EXTRUSIONS</b></p> <ul style="list-style-type: none"> <li>• Slim or Dual Case</li> </ul>	
<p><b>LED MODULES &amp; TUBES</b></p> <ul style="list-style-type: none"> <li>• Samsung LED Modules</li> <li>• Transformers &amp; RGB Controllers</li> <li>• LED Trough Lights</li> </ul>	
<p><b>ALUMINIUM COMPOSITE &amp; ACRYLIC PANELS</b></p> <p>*Founder and official Distributor of * Delivery within M25 only</p> 	
<p><b>LASER &amp; CNC CUT</b></p> <ul style="list-style-type: none"> <li>• Stencil Signs</li> <li>• Flat Cut &amp; Acrylic Built Up Letters</li> </ul>	

**Tel: 020 7237 8000**

Unit 1 | Surrey Canal Trade Park | Surrey Canal Road | London SE14 5RW

## FITTING NETWORK

Social media for the signage industry

www.fittingnetwork.com





IT'S FREE  
DOWNLOAD

### Office Manager/ Sales Administrator Bristol

Zulu Signs are a manufacturing based sign company producing high quality signage along with excellent customer service. We have a wealth of experience in the industry and understand the importance of signage and the role it plays when promoting businesses.

We currently have an opportunity for an Office Manager/Sales Administrator. Your role will be to manage the office duties and assist the Managing Director in the day to day running of the business.

**Duties will include:**

- Main point of contact for all new enquiries by telephone and email.
- Sales administration including purchase ledger, sales ledger and credit control.
- Basic bookkeeping. Following up on enquiries. Assisting in producing quotations for customer's approval. Helping to develop the company's expanding customer/client base.
- Managing customer relations. General office duties.

Experience in the sign industry or other similar industries would be advantageous but not essential. The right person will be friendly, polite and have good communication skills. You will have a high attention to detail and be able to manage your time effectively.

This is an exciting opportunity to become part of a dedicated and friendly team. Very competitive salary offered depending on experience.

Please apply in writing providing a background of your experience and a full CV to sales@zulusigns.co.uk

### Classified advertising rates

Half page	£220
Quarter page	£120
1/8 <sup>th</sup> page	£70
1/16 <sup>th</sup> page	£40
1/32 <sup>th</sup> page	£30

Job Vacancies and items for sale also go online at no extra cost:  
www.signupdate.co.uk/job  
www.signupdate.co.uk/for-sale

### Customer facing artworker and CNC programmer East Sussex

The perfect applicant would have knowledge of the sign industry however use of CorelDRAW, Adobe suites and CNC programming is more important.

Email: robb@graffitidesign.co.uk



**A1 SIGNS**  
Manufacturers of High Quality  
**NEON & COLD CATHODE**

• Design • Manufacture •  
• Installation • Service & Repairs •

**020 8646 9886**

Email: enquiry@a1signs.co.uk  
Unit 10, Wandle Technology Park, Mill Green Road, Mitcham, CR8 4JZ



**ORIGINAL GENUINE**  
**EdgeFoil**

**REFILLS & CARTRIDGES**

**EdgeFX from £29.95**  
**Edge2, Edge from £29.95**



**EdgeLexan**

Polycarbonate EdgeMedia  
Electronic Control Panels  
Electronics Membranes  
Overlays & Labels



**www.EdgeFoil.co.uk**



## "The soft-signage specialists"



**SPIRIT|TEX** FABRIC SYSTEM

A REVOLUTION in fabric displays  
WITHOUT stitched finishing  
COMPATIBLE with all printing technologies



**SPIRIT|FLEX** TENSION SYSTEM

A TRIED AND TESTED solution  
for stretching and tensioning  
all types of banner and flexface





**Trade Only Manufacturing Made in the UK**

**WWW.SPIRIT-DISPLAYS.COM**

**LETTERCRAFT TOPSIGNS** ARE NOW SUPPLYING

PREMIUM GRADE  
WHITE GLOSS MAGNETIC ROLL  
0.8mm X 620mm WIDE

FOR ONLY  
**£50**  
Per 10 Meter Roll  
EXC. V.A.T.

Tel:- 0191 5120096  
Fax:- 0191 5847804  
Email:- sales@lettercrafttopsignsuk.co.uk

Driving School Signs  
Supplied  
at Trade Prices



For Full Range Visit:  
www.lettercrafttopsigns.co.uk

**GUARANTEED  
NEXT DAY DELIVERY**

### PROTECT YOUR SIGNS THE ULTIMATE BIRD DETERRENT

- Transparent UV stabilised polycarbonate
- User friendly rounded tips - not harmful to pigeons
- Self adhesive fitting tape option available (no glue or screws needed)
- 8 Snap off grooves per length - no waste!
- 7 Glue fixing holes reduces adhesive costs!
- Light weight, stacks compactly - reduces storage space, makes it easy to carry on site.
- Made in the UK

**Flock-Off bird deterrents Ltd.**  
PO Box 92 Ware, Herts SG11 2BD  
Tel: 01279 503250 Fax: 01279 659133  
Email: sales@flockoff.co.uk www.flockoff.co.uk



**SIGNGEER**  
FOR THE PROFESSIONAL SIGNMAKER

## 303 PAGES OF SUPER SIGNMAKING TOOLS FOR THE TRADE

INCLUDING YOUR MUST-HAVE CLEANERS, POSTS, FIXINGS, TAPES, ETC

**TO ORDER A COPY CALL 0800 5 999 059 | VISIT OUR ONLINE STORE: WWW.SIGNGEER.COM**







**METALCRAFT**  
TRADE SIGNAGE SPECIALISTS

**FASCIA SIGNS** ◀▶ **3D BUILT UP LETTERS**

**PROJECTION SIGNS** ◀▶ **EXTRUDED LIGHTBOXES**

**POWDER COATING** ◀▶ **LED ILLUMINATION**

**TOTEM/MONOLITH SIGNS** ◀▶ **DIGITAL PRINT SERVICE**

**IN-HOUSE FABRICATION**

**NATIONWIDE DELIVERY**



WITH OVER 40 YEARS EXPERIENCE IN THE INDUSTRY, PRECISION & QUALITY ARE AT THE HEART OF WHAT WE DO BEST

**0191 487 0729**

UKMETALCRAFT.COM SALES@UKMETALCRAFT.COM  
UNIT 6 STIRLING COURT • TEAM VALLEY • GATESHEAD • NE11 0JF



**YorKut**

**LETTER COMPANY**

YOUR FLAT CUT LETTER TRADE SERVICE

**FLAT CUT LETTERS  
AT BEST PRICES**

ACRYLIC • FOAM PVC • MAGNETIC • MEDITE  
STAINLESS STEEL • ALUMINIUM • DIBOND

**Call 01904 690330**

YorKut Letter Company, 34-36 Auster Road,  
Clifton Moor, York, YO30 4XA.  
email: sales@yorkut.co.uk Fax: 01904 692155  
**www.yorkut.co.uk**

YorKut Letter Company is a subsidiary of Sign\*A\*Rama (York) Ltd

**3D**  
Acrylics & Metals Ltd

Specialists in Quality built up  
& flat cut lettering & logos

- Acrylic
- Aluminium
- Stainless Steel
- LED illumination

tel: 0191 469 1199 fax: 0191 438 4276

[www.3dacrlyics.co.uk](http://www.3dacrlyics.co.uk)

Email: [acrlyics3d@hotmail.com](mailto:acrlyics3d@hotmail.com)

Unit B1, Felling Business Centre, Green Lane,  
Felling, Tyne & Wear NE10 0QH



**SignTrade** Because you need the Best  
Trade suppliers to the sign industry  
[www.signtrade.co.uk](http://www.signtrade.co.uk)  
0500 456700

**Iceland.co.uk**

**co-op**

**A**

Moulded Letters  
Flatcut Letters  
Chromaform Letters  
Trays in composite  
Complete builds  
LED Lighting  
Acrylic Domes & Dishes

**It's where the trade go.**

**3D Built Up Channel Letter Specialists**  
Stainless Steel - Acrylic - Aluminium - Marquee  
**Specialising in LED Illumination**  
Face Lit - Halo Lit - Face & Halo Lit - Full Lit



**We also offer:**  
LED Fabric Light box - LED Window Pockets  
LED Poster Frame - Digital Media Players  
LED Screens - LED Message Displays



**inview** Visual Communications  
01371 641 000  
[sales@inviewltd.com](mailto:sales@inviewltd.com)



for all your signs & design needs.....  
**morcant designs**  
 .....quality at an affordable price

# FULL COLOUR DIGITAL PRINT

Wrap vinyls  
for vehicle graphics



Monomeric & polymeric vinyls  
normal or reversed



Banners, Mesh  
Roller Banners



.... plus - floor graphics, self cling stickers, desk banners

- ★ HIGH QUALITY PRINT from £9sqm
- ★ LAMINATION or NON LAMINATION
- ★ QUICK TURN AROUND TRADE SERVICE
- ★ FREE DELIVERY ON ORDERS OVER £100

e sales@morcant-designs.co.uk t 01382 732941

www.morcant-designs.co.uk



**DES LIMITED** Order Now For Next Day Delivery

£33.08  
864 x 533mm\* (\*image area)  
1.2mm zinc coated steel.  
White powder coated.  
Available in 4 styles (ie standard, poster, blackboard\* and poster blackboard\* available at extra cost.

Legged Pavement Sign  
Size: From £45.11  
915 x 610mm\* (\*image area)

Manufactured from 1.2mm zinc coated steel.  
Powder coated in white as standard.  
Two heavy duty metal side stays and legged feet.  
Double folded sides give extra strength.

01663 744824  
www.desltd.co.uk

**DOMES BY PROJECT PLASTICS**

**SPECIALISTS IN PLASTIC FABRICATION**

- ACRYLIC DOMES AND SHAPES •
- 3MT X 2MT C.N.C. ROUTING •
- LAZER CUTTING / ENGRAVING •
- OVEN FORMING UP TO 3MT X 2MT •
- FLAT CUT ACRYLIC LETTERS •
- PROTOTYPE AND BESPOKE SPECIALISTS •
- POINT OF SALE DISPLAYS •

TEL: (01206) 868696  
FAX: (01206) 793737  
www.projectplastics.co.uk  
7 Grange Way Business Park, Colchester, Essex CO2 8HF

**DIAMOND EDGE POLISHERS**

**UP TO DATE TECHNOLOGY AT AN AFFORDABLE PRICE**  
A bench-top machine which can handle single or multiple workpieces up to 20mm thick is now available

**HEAT BENDERS**

**A NEW RANGE OF HIGH QUALITY MACHINES**  
We can offer machines to suit all needs capable of bending materials such as PMMA, PS, PP, PVC and acrylic from just 0.3mm to 20mm thick

**FLAME POLISHERS**

**STILL THE CHEAPEST AND SIMPLEST WAY**  
to apply a professional finish to cut edges of acrylic material

**AWLTECH**

For more information or a brochure call AWTTECH  
Tel: 01420 525222  
Fax: 01420 525226  
www.awltech.co.uk

## signinstallations

your signs in safe hands...

w sign-installations.co.uk | t 01273 424900

Your sign installation company of choice....  
Covering London, Sussex, Hampshire, Surrey and Kent.



- ▶ Sign Installation
- ▶ Sign Maintenance
- ▶ 25 Years Experience
- ▶ Fully Qualified Sign Technicians
- ▶ Certified, Accredited, Professionals



## SCREEN PRINTING TO THE TRADE



**HUMPHREYS SCREENPRINTERS**

CORREX • PVC • VINYL • MAGNETICS • ACRYLICS  
ESTATE AGENTS BOARDS A SPECIALITY  
compare our for sale board prices on our web site

t:01745 814066 f:01745 815374  
www.humphreys-signs.co.uk sales@humphreys-signs.co.uk

**ALLWOOD PRODUCTS**  
Wood Component Manufacturers for Signs, Awards & Displays



Allwood Products  
Tel - 01461 40565  
Fax - 01461 40333  
info@allwoodproducts.co.uk  
www.allwoodproducts.co.uk

**Vista system** A world leader in way-finding signage

THANKS TO ALL OUR VISITORS AT THE UK SIGN AND DIGITAL SHOW



IT WAS LOVELY TO MEET YOU

THANK YOU FOR VISITING

sign digital UK

SEE YOU IN 2018

24-26 April Halls 17-18

www.signanddigitaluk.com

For Information Or Quotes Please Contact  
+44 080 0051 8885 | info@vistasystem.co.uk

# Print Team 0161 8 300 600

We print....

- ✓ Direct to Substrate Specialists
- ✓ Textiles
- ✓ Wide Format Printing
- ✓ Banners and Backdrops
- ✓ Roll to Roll and Flatbed
- ✓ Hoarding / Display Boards
- ✓ Wallpapers
- ✓ Canvas Prints
- ✓ ACM - Composite Panels
- ✓ Window, Floor and Wall Graphics
- ✓ Vinyl Laminated Prints
- ✓ Latex / UV / Eco Solvent

We also offer a complete installation service

info@midasignservices.co.uk www.midasignservices.co.uk

## MidaSignServicesUK

Installation Team • Print Team

Direct to Substrate and Wide Format Printing



Welbeck Street South, Ashton-under-Lyne, Lanc's OL6 7QZ





# Trade Engraving



Control Panels



Prestigious Engraving



Data & ID labels

- ✓ Stainless steel
- ✓ Brass
- ✓ Traffolyte
- ✓ Laser laminate
- ✓ Aluminium
- ✓ Laser or rotary



Est. 15 years  
For **REAL** trade prices...

Tel: 01296 488902 Fax: 01296 488869  
E-mail: info@impactsignsolutions.co.uk  
Web: www.impactengraving.co.uk



It means what it says  
fast professional results for all your etched signage needs

etchFAST — for fast, reliable etching

## Chemical Etching and Engraving



Engraving on Marble, Slate and Stone  
in addition to metals and laminates

Large lettering or fine details  
including both on the same panel



Complex shapes no problem  
engraved or laser cut to your design

See our main advert  
on page 99

etchFAST has 50 years' experience  
in Chemical Etching and Engraving

TEL: 0208 880 2070 Web: www.etchfast.com  
FAX: 0208 880 2333 E-mail: info@etchfast.com

Unit 5, Crusader Industrial Estate, 167 Hermitage Road LONDON N4 1LZ

# FKMOORE



Stand-off  
Wall Fixings



Coverhead  
Screws



Interscrews



Nylon  
Locators



Sign  
Hangers



**The UK's Widest Range Of Sign Locators**

fkmoore.com sales@fkmoore.com +44 (0) 1843 593440

## one to one engravers ltd

Chemical Etching, Engraving & Laser Engraving

**VeroMetal**<sup>®</sup>  
new innovative finishing product

VeroMetal is a cold sprayable hard metal coating that gives the effect of solid metal. It can be applied to almost any surface such as wood, plastic, fibre glass, ceramic, plaster... etc

Polished/Brushed Brass  
Brushed Stainless Steel  
Mirror Stainless Steel  
Back Lit Clear Acrylic  
Anodised Aluminium  
Wood  
Engraving Laminates  
Lasermax / Acrylic  
Maglat Systems

Info@otoel.com, Verometal@otoel.com  
www.otoel.com, www.verometal-uk.com  
T: 01604 644604 F: 0845 331 3054

Unit 3 Cirrus Park, Lower Farm Road, Moulton Park,  
Northampton Nn3 6UR





**iSpittrade**  
PAY THE REAL TRADE PRICE

Rod Systems, Cable Systems, Sign Fixings, Screw Covers, LED's and More...

Best Prices **GUARANTEED**

Free Carriage with your first web order enter  
"signupdate" during checkout



Call us today for your copy of our new brochure and start sourcing your shopfitting kit at THE REAL TRADE PRICE

**www.ispittrade.com | lo-call 0845 241 2467**

**BEST IN CLASS 7 YEAR WARRANTY** CE 2017.01 KOREA

arena | lens powered by SAMSUNG

"Fit and Forget" Reliability

citi LENS POWERED BY LG Innotek 1W 7500K CE IP68 KOREA

CE UL LM80 ROHS COMPLIANT

**citi-LED**  
the leading light in signage

Modules | Flex Strip | RGB Cabochon | Pixel LED  
RGB-DMX control systems | DMX-SPI Control | Dimmers

Tel: 0141 422 2500 sales@citi-led.co.uk

**WhiteVilla.co.uk MANUFACTURER**  
MADE TO ORDER OR KITS ONLY

Official UK distributor of ARQUATI AWNINGS

MONACO best seller BN  
ARQUATI  
VillaAwning best seller  
COMPACT fully cassetted

Official UK distributor of S.A.RECASENS FABRICS  
FOUNDED IN 1886

**Canopies** Made to Measure  
DUTCH TRIANGULAR  
FIXED VALANCE TRIANGULAR

**Tel: 020 7237 8000**  
Unit 1 | Surrey Canal Trade Park | Surrey Canal Road | London SE14 5RW

3D DOME LABELS  
3D DOMING SYSTEMS  
A BOARDS  
ACRYLIC FABRICATION  
ACRYLIC SHEET  
ALUMINIUM SIGN BLANKS  
ALUMINIUM SIGNS  
ARCHITECTURAL LIGHTING & SIGNAGE  
BANNER FIXING SYSTEMS  
BANNER INSTALLATION  
BANNER SUPPLIERS  
BLADES / SMART KNIVES  
BRAILLE AND TACTILE SIGNS  
BRONZE PLAQUES  
BUILT UP LETTERS ACRYLIC  
BUILT UP LETTERS METAL  
CABLE DISPLAY SYSTEMS  
CAST SIGNS  
CHEMICAL ETCHING  
CHROME PLATED LETTERS  
CNC ROUTING & ENGRAVING MACHINES  
COAT OF ARMS  
COMMEMORATIVE PLAQUES  
CUT-OUT LETTERS  
DIGITAL PRINT  
DIGITAL PRINTED SIGNS  
DIGITAL PRINTER SUPPLIES  
DMX LED SYSTEMS  
DOMES & DISHES  
EDGELIT SIGNS

ENGRAVING  
ESTIMATING SOFTWARE  
FINGERPOST SIGNS  
FLAME POLISHERS  
FLAT CUT LETTERS  
FLEXIBLE FACE SIGNAGE  
GENERAL SIGN SUPPLIERS  
GOLD LEAF SUPPLIERS  
INSTALLATION CONTRACTORS  
LAMINATING/ENCAPSULATING  
LASER CUTTING/ENGRAVING  
LASER CUTTING/ENGRAVING MACHINES  
LED DRIVERS  
LED ILLUMINATED LETTERS  
LED ILLUMINATION  
LED STRIP LIGHTS  
LIGHT BOXES & LIGHTING  
MAGNETIC MATERIAL  
METAL FABRICATIONS  
MODULAR PANEL SIGN SYSTEMS  
MOULDED & FABRICATED PLASTICS  
MOULDED LETTERS  
NAMEPLATES  
NEON MANUFACTURERS (TRADE)  
NEON PLUS®  
NEON REPLACEMENT LETTERS  
NOTICE BOARDS - LOCKABLE/EXTERIOR  
NUMBER PLATES  
PLASTIC SHEETS  
POINT OF SALE FITTINGS

POLYSTYRENE SIGN SERVICE  
POSTER HOLDERS / CASES  
POWER SUPPLIES  
PRINT/POSTER FRAMES  
PROGRAMMABLE LED DISPLAYS  
PROJECTING SIGNS  
REFLECTIVE VINYL/TAPES  
ROAD SIGNS & EQUIPMENT  
ROUTER CUTTERS/ PLOTTER BLADES  
SCREEN PRINTING  
SCULPTORS  
SHEET MATERIALS  
SIGN & DISPLAY SYSTEMS  
SIGN LOCATORS  
SIGN SUPPORT SYSTEMS  
SIGN SURVEYOR  
SIGN TRADE SUPPLIERS  
SOLAR POWERED SIGNS & DISPLAYS  
SPECIALITY FILMS  
STONE ENGRAVING  
STREET SIGNS  
TEXTILE SIGNAGE  
TRANSFER PAPERS/HEAT PRESSES  
TROUGH LIGHTING  
VINYL & GRAPHIC INSTALLATIONS  
VINYL SUPPLIES  
WAYFINDING SIGNS  
WIDE FORMAT SOLUTIONS PROVIDER  
WOODWORKING

## BUYERS GUIDE

Search through the Buyers Guide quickly online at [www.signupdate.co.uk/bg](http://www.signupdate.co.uk/bg)

To advertise on these pages costs as little as £130 for a full years advertising in our magazine and our website with web-links back to you!

Phone 01784 605 601 for full details of how to get your company to 22,000 Sign Update readers

### 3D DOME LABELS

#### MOCKRIDGE LABELS & NAMEPLATES LTD

Cavendish Street, Ashton-under-Lyne, Lancs OL6 7QL  
Tel: 0161 308 2331  
sales@mockridge.com  
www.mockridge.com  
3D Resin Doming adds value to screen and digitally printed signs, lettering, labels and emblems. Mockridge offer a wide range of products from budget-priced starter kits to mass-production systems. Contract Doming service available. Send for samples.

### 3D DOMING SYSTEMS

#### MOCKRIDGE LABELS & NAMEPLATES LTD

Cavendish Street, Ashton-under-Lyne, Lancs OL6 7QL  
Tel: 0161 308 2331  
sales@mockridge.com  
www.mockridge.com  
3D Resin Doming adds value to screen and digitally printed signs, lettering, labels and emblems. Mockridge offer a wide range of products from budget-priced starter kits to mass-production systems. Contract Doming service available. Send for samples.

### A BOARDS

#### DES LTD

Buxton Road, Furness Vale, High Peak, Derbyshire, SK23 7PH  
Tel: 01663 744824  
desaboard@aol.com  
www.desltd.co.uk  
Any size, and colour, aluminium, steel or stainless steel. Standard A board display area 21" x 36" powder coated in polyester. Can be used as a poster board with a magnetic transparent cover. Swing signs also available. Fax your drawings for a quotation on special display boards.

#### PLEX DISPLAY LTD

The Furlong, Berry Hill Industrial Estate, Droitwich, Worcestershire, WR9 9BG  
Tel: 01905 798 123  
sales@plexdisplay.com  
www.plexdisplay.com  
Established in 1994, Plex Display are hardware designers and manufacturers of Display, Café Barrier and Signage systems. We offer the trade highly competitive pricing, unrivalled stock levels and same day despatch, all backed by first class customer service and technical support. So whether you are in the exhibition, display, signage or large format printing industries we have products to suit you



## SIGNWAVES

Lefevre Way, Gapton Hall Industrial Estate, Great Yarmouth, Norfolk NR31 0NW

Tel: 01493 419300

enquiries@signwaves.co.uk

www.signwaves.co.uk

Signwaves is the UK's leading provider of Pavement Signs & A-Boards. A wide range of traditional and adapted A-Board designs are available for next day delivery, with a selection of poster insert and printed display options to choose from. Swinger and Ecoflex pavement signs are also manufactured by Signwaves – with lowest prices guaranteed direct from the supplier.

## UK POS

Horsfield Way, Bredbury Park Industrial Estate, Stockport SK6 2TD  
Tel: 0161 431 4400/4411

www.ukpos.com

UK POS are the UK's no.1 POS display specialists. Working in a variety of plastics, wood and metal, we currently design and supply over 25 million individual products. We combine nearly three decades of proven experience with cutting edge technology to create innovative products.

## ACRYLIC FABRICATION

### MID WEST DISPLAYS

The Display Centre, Knights Way, Battlefield Enterprise Park, Shrewsbury SY1 3AB

Tel: 01743 465531

sales@midwestdisplays.co.uk

www.midwestdisplays.co.uk

Mid West Displays stock a wide range of sign support systems. We also stock wall mounts, snap frames, mirror screws, cable/rod suspended systems, LED Display Panels, poster pockets and many more. We are pleased to be working with the highest quality materials at competitive prices.

## ACRYLIC SHEET

### N E PLASTICS LTD

Unit 1, Ruxley Corner Industrial Estate, Edgington Way, Sidcup, Kent DA14 5BL

Tel: 020 8308 9990

sales@neplastics.co.uk

www.neplastics.co.uk

One of the UK's largest independent stockholders of semi-finished plastics, offering a huge range of both branded and own label products including Crylux cast acrylic, Alliance ACP, Foamalite, Lumex, Viscom and Arla. A next day delivery service on cut to size and polished acrylic is available. We also offer a trade service on CNC Router & Laser cutting, Sign trays and bespoke plastic fabrication.

## PERSPEX DISTRIBUTION LTD

2-3 Lonebarn Link, Springfield Business Park, Chelmsford, Essex CM2 5AR

Tel: 01245 232800

sales.chelmsford@perspex.co.uk

www.perspex.co.uk

Perspex Distribution offer unique access to many of the principal plastic sheet products for the sign industry from their 5 regional distribution centres in Blackburn, Chelmsford, Leeds, Tamworth and Weybridge. With a comprehensive stock-holding in many colours and finishes and a cut to size service at all branches, Perspex Distribution can deliver your requirements fast..

## RIGHTON LTD

Righton House, Brookvale Road, Witton, Birmingham B6 7EY  
Tel: 0121 356 1141

marketing@righton.co.uk

www.righton.co.uk

UK distributor of Polycasa Crylux cast & Crylon extruded sheet acrylic. Available in a wide range of clear, opals, colours and special finishes. Also stocked: Alucobest aluminium composite sheet, Marlon solid polycarbonate, PET-G, SAN, polystyrene, hygienic cladding, rigid PVC and fixing accessories, sign post systems, aluminium sheet and extrusions.

## VISIONS IN PLASTICS

Unit 3, Delta Court (Robin Hood Airport), Auckley, Doncaster DN9 3GN  
Tel: 01302 775920

sales@visionsinplastics.co.uk

www.visionsinplastics.co.uk

Stocks of Mirrored Extruded Acrylic in clear, 19 colours, See-Thru, Two sided, Anti Scratch, Anti Fog, Mirrored Polycarbonate, Petg and Polystyrene. Non mirrored sheet in Acrylic, ABS, Polycarbonate, Polystyrene and PVC Foam.

## ALUMINIUM SIGN BLANKS

### SYGNET SIGNS LTD

129 Humberstone Rd, Leicester, LE5 3AP

Tel: 0116 262 6288

sales@sygnetsigns.com

www.sygnetsigns.com

Nationwide specialist trade supplier of fabricated alu/stainless steel trays, any shape, blank or router/laser cut. Powder coated or stove enamelled. We also supply fully illuminated fascia/projecting signage to your designs. All works carried out in-house. We also manufacture much more.....

## ALUMINIUM SIGNS

### MULTITECHNIC LTD

(EST. 1972)

Coopies Lane Industrial Estate, Morpeth, Northumberland NE61 6JQ  
Tel: 01670 512090

sales@multitechnic.co.uk

www.multitechnic.co.uk

Full colour graphics that are genuinely under the surface of anodised aluminium. Unlike any other process, the highest quality digital print is created inside the anodised layer as part of the anodising process. This means that the signs cannot be defaced by scraping off the image, making digital anoprinting ideal for signs in public buildings such as schools, colleges & student accommodation.

## ARCHITECTURAL LIGHTING & SIGNAGE

### MEGALED LTD

236-242 Alma Road, Enfield EN3 7BB

Tel: +44 (0)208 432 0995

led@megaled.com

www.megaled.com

MegaLED offer award winning architectural led lighting solutions & design assistance. Lights, multi-channel led hardware, in-depth product knowledge, integrated service, support and custom LED Lighting. All this makes us the go-to supplier for all types of challenging architectural and signage lighting projects. For quality service and unrivalled product knowledge, call us today: 0208 432 0995.

## BANNER FIXING SYSTEMS

### SIGNSCAPE AND SIGNCONEX LTD

Pear Tree Works, Bath Road, Upper Langford, Bristol BS40 5DJ

Tel: 01934 852 888

sales@signscape.co.uk

www.signscape.co.uk

Serving the Sign Trade for over 40 years, we are a leading manufacturer of sign systems, notice boards & information displays. Our Bannerfix system provides the components required to support the temporary or permanent installation of PVC or fabric banners onto lamp columns, posts or on to walls, with either steel banding or Tamtorque fixings. Standard and custom length banner arms are available.

## BANNER INSTALLATION

### MIDA SIGN SERVICES UK LTD

Welbeck Street South, Ashton-Under-Lyne OL6 7QZ

Tel: 0161 8 300 600

info@midasignservices.co.uk

www.midasignservices.co.uk

Installers of any size of banner, from 1off's to nationwide marketing promotions, we supply & install post mounted and wire tension systems with a nationwide maintenance and emergency call out service, call for further details.

## BANNER SUPPLIERS

### PLEX DISPLAY LTD

The Furlong, Berry Hill Industrial Estate, Droitwich, Worcestershire, WR9 9BG

Tel: 01905 798 123

sales@plexdisplay.com

www.plexdisplay.com

Established in 1994, Plex Display are hardware designers and manufacturers of Display, Café Barrier and Signage systems. We offer the trade highly competitive pricing, unrivalled stock levels and same day despatch, all backed by first class customer service and technical support. So whether you are in the exhibition, display, signage or large format printing industries we have products to suit you

## SIGNWAVES

Lefevre Way, Gapton Hall Industrial Estate, Great Yarmouth, Norfolk NR31 0NW

Tel: 01493 419300

enquiries@signwaves.co.uk

www.signwaves.co.uk

Signwaves supplies a variety of banners suitable for internal and external use. The range includes: Feather, Teardrop and Rectangular Flying Banners, Café Barriers and PVC/Pennant Hanging Banners. These can be printed if required. A selection of mounting accessories are offered for Signwaves' Flying Banners – covering hard and soft surfaces with little to no groundwork needed to install.

## BLADES / SMART KNIVES

### EDWARD MATHIAS & CO

PO BOX 121, Frodsham, Cheshire, WA6 1AA

Tel: 01928 739 799

info@edwardmathias.com

www.edwardmathias.com

Specialist manufacturers/suppliers of tungsten carbide plotter blades and router cutters. We don't just sell blades, we are the UK's leading manufacturer. Note - we have no connection with any other company who sell or re-sharpen blades.

## BRILLE AND TACTILE SIGNS

### BESPOKE MANUFACTURING LTD

Unit 1B Commerce Way, Walrow Industrial Estate, Highbridge, Somerset TA9 4AG

Tel: 01278 793 800

sales@bespokemanufacturing.co.uk

www.bespokemanufacturingltd.co.uk

Bespoke Manufacturing specialise in a wide range of Braille and Tactile signage. We've been trading for over 16 years and have built up an impeccable reputation in the braille and tactile sector. We use substrates such as acrylics, brass, copper, stainless steel and aluminium including slats style systems providing single signs, to complete directories. All our work is carried out in house.

## BRONZE PLAQUES

### SIGN INDUSTRIES

Gardyne, Forfar, Angus, Scotland, DD8 2SQ

Tel: 01241 828 694

info@signindustries.com

www.signindustries.com

Sign Industries Ltd is a leading manufacturer of Bronze plaques and plates sized between matchbox to 3 metres in length. We use the highest quality Bronze sourced from British companies. It is now possible to create your own memorial bronze plaque direct from our website.

## BUILT UP LETTERS ACRYLIC

### 3D ACRYLICS & METALS LTD

Unit B1, Felling Business Centre, Green Lane, Gateshead, Tyne & Wear, NE10 0QH

Tel: 0191 469 1199

www.3dacrilycs.co.uk

In house manufacturers of high quality built up and flat cut lettering and logos, we can offer back trays and fixings along with face and/or halo LED illumination. Our prices are very competitive and offer a prompt service.

## APPLELEC

Appleby House, Walker Terrace, Bradford, West Yorkshire BD4 7HJ

Tel: +44 (0)1274 774477

sales@applelec.co.uk

www.applelec.co.uk

Trade suppliers of quality 3D built up acrylic letters and logos in colours and finishes from a variety of different sheet manufacturers.

Built up letters are available with halo and/or face lit illumination from our award winning and cost effective LED range. Please ask for an information pack or contact one of our friendly and experienced sales staff for assistance. (Flat cut lettering is also available).

## I.C.E.

Marcon House, Wyther Lane, Leeds LS5 3BT

Tel: 0113 2242124

sales@icesigns.co.uk

www.icesigns.co.uk

Manufacturers of built up acrylic letters and logos. We can offer face or halo illumination with the installation of LEDs if required.

Please call our staff on the number below if you have any questions.

## SIGN HERE

179 Fosse Road North, Leicester, LE3 5EZ

Tel: 0500 428 021

sales@sign-here.co.uk

www.sign-here.co.uk

Trade service for 3D built up lettering & logos in a variety of materials. We will give you a professional reliable & efficient service at a competitive price. From a single letter to a fully illuminated sign ready for installation. For a quote or just friendly advice contact us. We are here to help.

## BUILT UP LETTERS METAL

### 3D ACRYLICS & METALS LTD

Unit B1, Felling Business Centre, Green Lane, Gateshead, Tyne & Wear, NE10 0QH

Tel: 0191 469 1199

www.3dacrilycs.co.uk

In house manufacturers of high quality built up and flat cut lettering and logos in aluminium and stainless steel, we also offer a painting or powder coating service & most letters can be fitted with LED modules. Our prices are very competitive and offer a prompt service.

## AES SIGNS LTD

(EST. 1972)

The Old Laundry, 15 Barratt Street, Easton, Bristol BS5 6DE

Tel: 0117 951 0234

sales@aesigns.co.uk

www.aesigns.co.uk

Specialist manufacturers of built-up/flat cut letters, logos in stainless steel, brass, aluminium etc. Very competitive prices, excellent delivery, highest quality, full design service. Prompt response to all enquiries.

## APPLELEC

Appleby House, Walker Terrace, Bradford, West Yorkshire BD4 7HJ

Tel: +44 (0)1274 774477

sales@applelec.co.uk

www.applelec.co.uk

Trade suppliers of quality 3D built up metal letters and logos. Lettering starts at just 50mm high in materials such as stainless steel, brass, copper, titanium and aluminium with a variety of different finishes. Built up letters are available with halo and / or face lit illumination from our award winning and cost effective LED range. Please ask for an information pack or contact one of our friendly and experienced sales staff for assistance.

## AVENUE SIGNS LTD

216-222 Luton Road, Chatham, Kent ME4 5BS

Tel: 01634 841300

info@avenuesigns.co.uk

www.avenuesigns.co.uk

Specialists in stainless steel letter fabrication sprayed to your specification. Neon and transformers, etc. also made to suit.

## CENTRE SIGNS (UK) LTD

Alexander House, Iliffe Avenue, Oadby, Leicester LE2 5LH

Tel: 0116 271 4247

graphics@centresigns.co.uk

www.centresigns.co.uk

Specialist metal fabricators to the sign trade only. Built up letters in Stainless Steel, Aluminium, Gold Titanium Stainless, Brass and Copper. Fabricated Aluminium and Stainless boxes to any shape. Flat cut aluminium and flat cut perspex letters.

## FABRICUT

Unit 2 Browells Lane, Feltham, Middlesex, TW13 7EQ

Tel: 020 8751 7250

mailus@fabricut.co.uk

www.fabricut.co.uk

Trade suppliers of 3D built up letters and logos. Full LED service available for Halo or Face illumination. Stove enameling available from BS, RAL and Pantone colours. Fast turnaround with competitive prices.

## FABSIGN

280a High Street, Berkhamsted, Herts, HP41AH

Tel: 01442 386 618

Mob: 07739 364 613

info@fabsign.co.uk

www.fabsign.co.uk

Fabsign are a company who specialise in built up letters and logos and metal fabrications. We are experts in this field so we can offer our customers a non compromising service to manufacture to their requirements and expectations at the lowest prices available. We also supply flat cut letters and logos in any material. So give us a call and let us see what we can do for you.

## I.C.E.

Marcon House, Wyther Lane, Leeds, LS5 3BT

Tel: 0113 2242124

sales@icesigns.co.uk

www.icesigns.co.uk

Manufacturers of Built Up - Flat Cut - Rim and Return Letters and Logos in Stainless Steel, Aluminium, Copper and Brass. We also fit neon tube or LED modules within the Letters for face or halo illumination.

## LOGOTECH DISPLAY SOLUTIONS LTD

Unit 6, Atley Business Pk, North Nelson Ind Est, Cramlington, Newcastle Upon Tyne NE23 1WP

Tel: 01670 737 225

sales@logotech-ltd.co.uk

www.logo-tech.co.uk

In our fully equipped metal department we produce high quality built up letters/logos in aluminium, stainless, brass and copper. Supplied to the trade nationwide, at a very competitive price. We also manufacture boxes, post signs, gantry signs, frames and panels, which can be finished to your specifications.

We have our own in-house neon department and can supply you with the complete sign service, ready for you to install.

## SIGN HERE

179 Fosse Road North, Leicester, LE3 5EZ

Tel: 0500 428 021

sales@sign-here.co.uk

www.sign-here.co.uk

Trade service for flat cut lettering & logos in Acrylic Foamex, Dibond, Aluminium, Stainless steel & MDF. We will give you a professional reliable & efficient service at a competitive price. From a single letter to a fully illuminated sign ready for installation. For a quote or just friendly advice contact us. We are here to help.

## SYGNET SIGNS LTD

129 Humberstone Rd, Leicester, LE5 3AP

Tel: 0116 262 6288

sales@sygnetsigns.com

www.sygnetsigns.com

Nationwide specialist trade suppliers of alu/stainless steel 3D built ups. Brushed/Satin/Mill/chemically coloured finishes. 1050 grade alu, 316 or 304 grade s/s. We can also supply a variety of back trays to suit and fit LEDs/Neon etc for face/halo illumination. All works carried out in-house. (we also supply flat cut text/logos).

## CABLE DISPLAY SYSTEMS

### E-SIGNFITTINGS HOBDAY LTD

57 Aston Brook Street East, Aston, Birmingham, B6 4RR

Tel: 0121 608 4431

sales@e-signfittings.co.uk

www.e-signfittings.co.uk

E-Signfittings are one of the largest suppliers of Cable & Rod Display Systems in the UK. We have large stocks available on next day delivery for orders received before 3pm. Other products in our range include Stand-offs, Screw Head Covers, Poster Hanging Systems, Sign Hanging Systems, Leaflet Holders and Poster Displays. Visit our web site to check our current stock levels and fantastic prices.

## MID WEST DISPLAYS

The Display Centre, Knights Way, Battlefield Enterprise Park, Shrewsbury SY1 3AB

Tel: 01743 465531

sales@midwestdisplays.co.uk

www.midwestdisplays.co.uk

Mid West Displays stock a wide range of sign support systems. We also stock wall mounts, snap frames, mirror screws, cable/rod suspended systems, LED Display Panels, poster pockets and many more. We are pleased to be working with the highest quality materials at competitive prices.

## CAST SIGNS

### SIGNS OF THE TIMES LTD

Wingfield Road Tebworth, Beds, LU7 9QG

Tel: 01525 874 185

enquiries@sott.co.uk

www.sott.co.uk

Specialists in the manufacture of quality cast signs - mainly cast in polyurethane but also grp, bronze, brass and aluminium. All patterns are made by our in house pattern maker to your specification. A few millimetres up to several metres in size. Cast signs for town entrances, buildings, way finding fingerpost signs, blue plaques, street signs.

## WARD SIGNS

Maze House, Maze Street, Barton Hill, Bristol BS5 9TE

Tel: 0117 955 3385

info@ward-signs.co.uk

www.ward-signs.co.uk

Plaques, Crests, Lettering. In aluminium and Bronze. From Pattern Making to Finishing in Stove Enamel. 60 Years of Experience.

## CHEMICAL ETCHING

### AES SIGNS LTD

(EST. 1972)

The Old Laundry, 15 Barratt Street, Easton, Bristol BS5 6DE

Tel: 0117 951 0234

sales@aesigns.co.uk

www.aesigns.co.uk

The complete sign service. Engraved/etched screen printed, signs, nameplates, etc in all materials. Very competitive prices, excellent delivery, highest quality. Full design service. Prompt response to



## DARTFORD ENGRAVING & SCREENPRINTING LTD

Unit 4 Power Works Industrial Estate, Slade green Road, Erith, Kent DA8 2HY  
Tel: 01322 340 194  
mail@desp.co.uk  
www.desp.co.uk

DESP has been trading for over 50 years. Chemical Etching, Screen Printing, CNC engraving, Laser Engraving, Heavy Duty Machine engraving (ALL CARRIED OUT INHOUSE), including artwork. So whether its a 1 off or 1,000s off, we can offer a quick competitive turnaround.

## HALLMARK ENGRAVING ETCHING & SIGNS LTD

(EST. 1899)  
116-118 Selsdon Road, South Croydon, Surrey, CR2 6PG  
Tel: 020 8686 6649  
sales@hallmarksigns.co.uk  
www.hallmarksigns.co.uk  
SUPERFAST and efficient trade service for ALL commercial and industrial etching, using the latest technology and computerised equipment. One-off urgent specials or long runs no problem. Full graphics and artwork service for logos, crests and designs. Specialists for commemorative plaques, company name plates and awards in all metals and plastics. Professionally designed-drawings supplied free.

## IMPACT ENGRAVING

23-23 Rabans Close, Aylesbury, Bucks, HP19 8RS  
Tel: 01296 488902  
Mob: 07957 870 756  
andy@impactengraving.co.uk  
www.impactengraving.co.uk  
REAL Trade prices for chemical etching, brass and stainless steel a speciality. ULTRA FAST DELIVERY

## MOCKRIDGE LABELS & NAMEPLATES LTD

Cavendish Street, Ashton-under-Lyne, Lancs OL6 7QL  
Tel: 0161 308 2331  
sales@mockridge.com  
www.mockridge.com  
Specialists in chemically etched nameplates. Brass, Stainless Steel and Anodised Aluminium. Any size up to 2400 x 1200mm (8ft x 4ft). One-offs up to 5000+. trade work is totally confidential.

## MULTITECHNIC LTD

(EST. 1972)  
Coopies Lane, Morpeth, Northumberland NE61 6JQ  
Tel: 01670 512090  
sales@multitechnic.co.uk  
www.multitechnic.co.uk  
We are established specialists in chemical etching. WE ARE THE ONLY TRADE ONLY SIGN ETCHING SPECIALISTS IN THE UK. We can offer effects that nobody else can do such as complex blended colours. All our stainless steel is 316 marine grade, we don't use inferior grades & our brass is the best too. We want your business so will give you a fast turnaround & excellent service.

## SIGN INDUSTRIES

Gardyne, Forfar, Angus, Scotland, DD8 2SQ  
Tel: 01241 828 694  
info@signindustries.com  
www.signindustries.com  
SIGN INDUSTRIES are specialist TRADE MANUFACTURERS of etched Stainless Steel, Brass, and Bronze. We also Laser Engrave Plastics and Wood as stand alone products as well as moulds for castings. SIGN INDUSTRIES normally work with 3 mm thick material, and can etch bend and weld Stainless Steel up to 3 metres x 1.5 metres, and down to small sequential tags for wiring looms.

## TRADE ETCHING DIRECT LTD

10 Pywell Court, Pywell Road, Corby, Northants, NN17 5WA  
Tel: 01536 203813  
sales@tradeetching.com  
www.tradeetching.com  
Trade Etching Direct Ltd is a well-established chemical etching company specialising in high quality etched signage. Our work is 100% guaranteed. Our etching machines are specially designed for deep etching. We can offer gradient fills, a range of patina finishes and hand filled complex multi colours, on a wide range of metals. We can produce etched signs up to 4m x 2m in size.

## CHROME PLATED LETTERS

## SIGNTRADE LETTERS LTD

225 Long Lane, London N3 2RL  
Tel: 0500 456700  
sales@signtrade.co.uk  
www.signtrade.co.uk  
ChromaForm; the NEW generation of Chrome effect letters. We now offer a complete range of ChromaForm Letters for a 7 day turnaround not available anywhere else. We can also supply and fit LED lights to the ChromaForm range of letters for an even better effect. Ring Susan or Lesley for details and samples.

## CNC ROUTING & ENGRAVING MACHINES

## ATA ENGINEERING PROCESSES

ATA House, Unit B, Boundry Way, Hemel Hempstead, Herts HP2 7SS  
Tel: 01442 264411  
sales@ataeng.com  
www.ataeng.com  
The C R Onsrud range of CNC routers offers a wide variety of options from entry level 3 axis machines up to 5 axis with fixed or moving gantry.

## COAT OF ARMS

## BRYAN RAWLINGS DESIGN

45 Nunney Close, Keynsham, Bristol BS31 1XG  
Tel: 0117 986 7894 / 7291  
bryan@bryanrawlings.com  
www.bryanrawlings.com  
Designers and makers of coats of arms, emblems and all types of sculptural and decorative signage. GRP, cast resins, metals, detailed hand painting and much more. Large range of royal coats of arms available. Specialist suppliers to the sign trade.

## SIGNS OF THE TIMES LTD

Wingfield Road Tebworth, Beds, LU7 9QG  
Tel: 01525 874 185  
enquiries@sott.co.uk  
www.sott.co.uk  
Cast in polyurethane with detail in relief and hand painted full colours. May be cast on their own or as part of an entrance sign, blue plaque or street sign etc. We also cast coats of arms in aluminium, grp or bronze. Please send details for a quotation.

## WARD SIGNS

Maze House, Maze Street, Barton Hill, Bristol BS5 9TE  
Tel: 0117 955 3385  
info@ward-signs.co.uk  
www.ward-signs.co.uk  
Wards of Bristol Specialise in manufacture, restoration and accurate reproduction of historical and modern coats of arms. We are able to produce from originals, information from heraldic associations, or even from a photograph. Check our website for recent projects.

## COMMEMORATIVE PLAQUES

## MERCURY & PHILLIPS SIGNS

51/59 Waterworks Rd. Norwich NR2 4DA  
Tel: 01603 666699  
sales@mercuryphillips.co.uk  
www.mercuryphillipssigns.co.uk  
Manufacturers of plaques in stainless steel, brass and aluminium, chemically or machine engraved, colour filled to your choice. Logos and text from artwork supplied.

## SIGN INDUSTRIES

Gardyne, Forfar, Angus, Scotland, DD8 2SQ  
Tel: 01241 828 694  
info@signindustries.com  
www.signindustries.com  
Sign Industries is one of the UK's leading sign making manufacturers, offering a broad range of memorial and commemorative plaques in many varying styles using the finest materials such as bronze, brass, stainless steel and wood. You can now create your own custom plaques and nameplates and order them directly from our website.

## SIGNS OF THE TIMES LTD

Wingfield Road Tebworth, Beds, LU7 9QG  
Tel: 01525 874 185  
enquiries@sott.co.uk  
www.sott.co.uk  
Trade service for flat cut lettering & logos in Acrylic Foamex, Dibond, Aluminium, Stainless steel & MDF. We will give you a professional reliable & efficient service at a competitive price. From a single letter to a fully illuminated sign ready for installation. For a quote or just friendly advice contact us. We are here to help.

## WARD SIGNS

Maze House, Maze Street, Barton Hill, Bristol BS5 9TE  
Tel: 0117 955 3385  
info@ward-signs.co.uk  
www.ward-signs.co.uk  
Wards of Bristol have produced countless cast metal commemorative blue plaques, but also specialise in traditional bronze plaques and custom 3D hand crafted plaques, which are hand painted to depict scenes of historical events, places and figures.

## CUT-OUT LETTERS

## APPLELEC

Appleby House, Walker Terrace, Bradford, West Yorkshire, BD4 7HJ  
Tel: +44 (0)1274 774477  
sales@applelec.co.uk  
www.applelec.co.uk  
Trade suppliers of flat cut out letters, logos and intricate laser work. Lettering in a variety of materials such as acrylic, foamex, dibond, stainless steel, aluminium and MDF is available in different finishes and supplied with or without fixings. Please ask for an information pack or contact one of our friendly and experienced sales staff for assistance. (3D built up lettering is also available).

## I.C.E.

Marcon House, Wyther Lane, Leeds LS5 3BT  
Tel: 0113 224 2124  
sales@icesigns.co.uk  
www.icesigns.co.uk  
Manufacturers of flat cut letters in ALL materials. Incl. Acrylic, Foamex, MDF, Stainless Steel, Brass, Copper, Corian. Many finishes available- Gilding, painting, powdercoating, lacquering. A special service at a competitive price.

## MERCURY & PHILLIPS SIGNS

51-59 Waterworks Road, Norwich NR2 4DA.  
Tel: 01603 666699  
sales@mercuryphillips.co.uk  
www.mercuryphillipssigns.co.uk  
A fully comprehensive service to the trade in acrylic, foam PVC, MDF, brass and aluminium. Contact us for price list or quotation.

## SIGN HERE

179 Fosse Road North, Leicester, LE3 5EZ  
Tel: 0500 428 021  
sales@sign-here.co.uk  
www.sign-here.co.uk  
Trade service for flat cut lettering & logos in Acrylic Foamex, Dibond, Aluminium, Stainless steel & MDF. We will give you a professional reliable & efficient service at a competitive price. From a single letter to a fully illuminated sign ready for installation. For a quote or just friendly advice contact us. We are here to help.

## SIGNTRADE LETTERS LTD

225 Long Lane, London N3 2RL  
Tel: 0500 456700  
sales@signtrade.co.uk  
www.signtrade.co.uk  
Plastic is our speciality including Flat Cut lettering in Perspex, foam pvc and aluminium composite. All supplied with locators and template as standard. We also offer a complete range of Moulded letters in Perspex and ChromaForm, offering over 60 years experience.

## SYGNET SIGNS LTD

129 Humberstone Rd, Leicester, LE5 3AP  
Tel: 0116 262 6288  
sales@sygnetsigns.com  
www.sygnetsigns.com  
We have over 5000 styles to choose from or you can send your own artwork. Letters/logos available in acrylic, foam, md, polycarb, dibond, stainless steel and much more. All cut by router or laser. With or without fixings. All works carried out in-house (we also manufacture built ups and much more).

## DIGITAL PRINT

## MOCKRIDGE LABELS & NAMEPLATES LTD

Cavendish Street, Ashton-under-Lyne, Lancs OL6 7QL  
Tel: 0161 308 2331  
sales@mockridge.com  
www.mockridge.com  
Full Colour Digitally printed self adhesive labels, full colour sub-surface printed overlays, full colour nameplates, including plaques and signs. Low Cost. Quick turnaround.

## MORCANT DESIGNS LTD

Unit 6, Tom Johnston Road, West Pitkerro Industrial Estate, Dundee DD4 8XD  
Tel: 01382 686 286  
Mob: 07712 654757  
sales@morcant-designs.co.uk  
www.morcant-designs.co.uk  
Full colour digital printed graphics: monomeric, polymeric, cast or vehicle wrap vinyls. Full colour canvases, banners, roller banners, pop-up frames. Full colour signs, name-plates. All of these at very competitive prices and quick turnaround times.

## DIGITAL PRINTED SIGNS

## AVENUE SIGNS LTD

216-222 Luton Road, Chatham, Kent ME4 5BS  
Tel: 01634 841300  
info@avenuesigns.co.uk  
www.avenuesigns.co.uk  
Trade service for digital printing and laminating up to 1600mm wide. Printing onto vinyl, banner, canvas, paper, etc.

## DIGITAL PRINTER SUPPLIES

## ARTSYSTEMS

Units 10 – 12 Glaisdale Point, Glaisdale Parkway, Nottingham NG8 4GP  
Tel: 0115 9380 380  
marketing@artsytems.co.uk  
www.artsystems.co.uk  
UK Trade Distributor for HP Designjet, HP Latex, HP UV printers, Colortrac scanners, Summa Cutters, and Onyx RIPs. ISO 9001, ISO14001 Certified HP and Canon consumables, Neschen media and our own large format media range called Xativa.

## BISBELL MAGNETIC PRODUCTS LTD.

Hillfield Lane, Stretton, Burton on Trent, Staffs DE13 0BN  
Tel: 01283 531000  
sales@bisbellmagnets.com  
www.bisbellmagnets.com  
The UK's widest range of digitally printable wide format magnetic and ferro sheet (both over 1200mm wide). Maxmag vehicle grade magnetic materials available in white, plain or adhesive backed - by roll or cut to your specific requirements. Also available neo magnets, vehicle roof magnets, sign grippers and a full range of high tape to suit every budget and application.

## DORO TAPE (UK) LTD

New Mill, Farndon Road, Market Harborough, Leics LE16 9NP  
Tel: 01858 431 642  
sales@dorotape.co.uk  
www.dorotape.co.uk  
Specialists in media for digital printing, Doro Tape supply products from major European manufacturers including Ritrama, Asian, Xerox and Poli-Tape for all large format printers. Whether it's for sign graphics; interior exhibition or retail displays; floor graphics or vehicle wraps, Doro can supply the right product. Contact Doro Tape for expert advice on digital media.

## MACTAC UK LTD

37 Tenter Road, Moulton Park, Northampton NN3 6AX  
Tel: 01604 644697  
www.mactac.eu  
MACTac are global manufacturers of self-adhesive material for wide-format Digital Printing (Water Based, Solvent, Eco-Solvent, Latex & UV) with Print Profiles to match these materials that are designed for Vehicle Wrapping, Wall, Street, Floor and Window Graphics. Many Laminates available include wood & metal effects. Some products are Class O fire-rated and CBS Outdoors (formerly Viacom) approved.

## DMX LED SYSTEMS

## MEGALED LTD

236-242 Alma Road, Enfield EN3 7BB  
Tel: +44 (0)208 432 0995  
led@megaled.com  
www.megaled.com  
Specialist led lighting; lights, multi-channel DMX LED light controllers, system design and custom light programming is the norm at MegaLED! We offer a complete service and full range of custom DMX led driver cards, DMX splitters, DMX mains relays, led dimmers and more. If you have any led lighting projects requiring light control or dimming, please call: 0208 432 0995 for a brilliant solution.

## DOMES & DISHES

## PROJECT PLASTICS LTD

Unit 7 Grange Way Business Park, Whitehill Industrial Estate, Colchester, Essex CO2 8HF  
Tel: 01206 868 696  
project.plastics@btinternet.com  
www.projectplastics.co.uk  
Manufacturing and stocking clear acrylic domes and dishes in over 25 sizes and all produced on site at our factory in Colchester. We also stock over 170 different size blowing rings for other shapes and weird and wonderful diameters. Pans, dishes, squares, oblong and ovals are our speciality.

## TALBOT DESIGNS LTD

225 Long Lane, Finchley London N3 2RL  
Tel: 020 8346 8515  
sales@talbotdesigns.co.uk  
www.talbotdesigns.co.uk  
With 70 years of making Domes & Dishes, our Teedy Domes have set the standard. With our vast range of tooling we can make almost any size – so just ask. We are now the first to offer unbreakable Polycarbonate Domes.

## EDGELIT SIGNS

## APPLELEC

Appleby House, Walker Terrace, Bradford, West Yorkshire BD4 7HJ  
Tel: 01274 774477  
sales@applelec.co.uk  
www.applelec.co.uk  
Manufacturers of edge lit signs incorporating a variety of extruded profile options along with bespoke engraved acrylic panels. With award winning and cost effective LED modules and a choice of mounting or hanging shop fitting kits, Applelec supplies an unrivalled range of edge lit trade components. Please ask for an information pack or contact our friendly and experienced sales staff for assistance.

## KINGS PLASTICS LTD

The Signbuild Centre, Kelso House, Waterloo Street, St Philips, Bristol, BS2 0PH  
Tel: 0117 9411 411  
enquiry@kingsplastics.co.uk  
www.kingsplastics.co.uk  
Edgelits are our speciality, we supply our tracks with integral or separate power supplies. Single colour or fully programmable RGB colour changing all up to 3mtrs long. Panels cnc engraved and lasered engraved. We supply three tracks the Reflex, Miniflex & Duallflex. For images and prices please visit our online shop or contact our experienced sales team.

## MEGALED LTD

236-242 Alma Road, Enfield EN3 7BB  
Tel: +44 (0)208 432 0995  
led@megaled.com  
www.megaled.com  
MegaLED are pioneers in edge lighting. Providing a professional LED illumination service and the most impressive range of 'designer' edge lit signs available anywhere. Specialist led lighting and display designs. Manufacturers of quality contemporary edge lit signs in both glass and acrylic. For award-winning led lighting, wayfinding, retail and architectural projects, call us on: 0208 432 0995

## ENGRAVING

## AES SIGNS LTD

(EST. 1972)  
The Old Laundry, 15 Barratt street, Easton, Bristol, BS5 6DE  
Tel: 0117 951 0234  
sales@aessigns.co.uk  
www.aessigns.co.uk  
The complete sign service Engraved / Etched & Screen Printed signs Nameplates etc. in all materials. Very competitive prices, excellent delivery, highest quality, full design service, prompt response to all enquires

## ALAN ROBERTS ENGRAVERS

27 Thingwall Drive, Irby Village, Wirral, CH61 3XN  
Tel: 0151 709 3404  
mail@alanrobertsengravers.co.uk  
www.alanrobertsengravers.co.uk  
Fast Confidential Engraving Service to the trade. We can provide plaques, nameplates, control panels, safety signs, switch plates, commemorative plaques with unveiling unit (on hire basis), bespoke signs and labels etc.

## COUNTY ENGRAVERS & SIGNS LTD

Unit 5, Trent View Court, Moreland Street, Nottingham NG2 3FX  
Tel: 0115 985 1171  
sales@countyengravers-signs.co.uk  
www.countyengravers-signs.co.uk  
Engravers of all types of plaques, plates, labels and control panels in a wide range of materials. Fine detail etching in brass and stainless steel. Industrial and Laser Engraving and Component Marking. Full colour printing from labels to wide format.



## DARTFORD ENGRAVING & SCREENPRINTING LTD

Unit 4 Power Works Industrial Estate, Slade green Road, Erith, Kent DA8 2HY  
Tel: 01322 340 194  
mail@desp.co.uk

www.desp.co.uk

DESP has been trading for over 50 years. CNC engraving, Laser engraving, Heavy Duty machine engraving, Chemical etching, Screen Printing, (ALL CARRIED OUT IN-HOUSE), including artwork. So whether its a 1 off or 1,000 off, we can offer a quick competitive turnround.

## FIRST SIGNS & LABELS LTD

Unit 1, Raynham Close, Raynham Rd Ind Estate, Raynham Road, Bishops Stortford, Herts, CM23 5JP  
Tel: 01279 467999

sales@firstsignsandlabels.co.uk  
www.firstsignsandlabels.co.uk

We manufacture and engrave nameplates, Labels, Tags, Switchplates, Mimics, Brass Plates, Components, Warning labels, Plaques, Logo's and Signs. We also produce printed fire & Safety Signs & Vinyl Graphics.

## HALLMARK ENGRAVING

### ETCHING & SIGNS LTD (EST. 1899)

116-118 Selsdon Road, South Croydon, Surrey CR2 6PG  
Tel: 020 8686 6649

sales@hallmarksigns.co.uk  
www.hallmarksigns.co.uk

Superfast and reliable trade service with 100 years experience for all etching, routing and profiling. Specialists for nameplate and commemorative plaques in bronze, brass, aluminium, stainless and plastics. Logos and crests. High quality graphics - drawings free of charge. Precision industrial engravers of panels, labels and moulds. Keytop specialist. Presentation silverware and glass engraving experts.

## IMPACT ENGRAVING

22-23 Rabans Close, Aylesbury, Bucks, HP19 8RS  
Tel: 01296 488902

Mob: 07957 870 756

andy@impactengraving.co.uk  
www.impactengraving.co.uk

REAL Trade prices for Engraving and chemical etching, rotary, diamond, laser and acid. Control panels, data plates etc. Stainless steel, Traffolyte, special laminates, brass, aluminium etc. ULTRA FAST DELIVERY !

## MERCURY & PHILLIPS SIGNS

51/59 Waterworks Rd. Norwich NR2 4DA

Tel: 01603 666699

sales@mercuryphillips.co.uk  
www.mercuryphillipssigns.co.uk

Manufacturers of all types of plates or plaques, machine engraved or chemically etched using a variety of materials, brass, stainless steel, aluminium, plastics and wood. For high quality and intricate detail with colour infills to your choice.

## SIGN INDUSTRIES

Gardyne, Forfar, Angus, Scotland, DD8 2SQ

Tel: 01241 828 694

info@signindustries.com

www.signindustries.com

SIGN INDUSTRIES are specialist TRADE MANUFACTURERS of etched Stainless Steel, Brass, and Bronze. We also Laser Engrave Plastics and Wood as stand alone products as well as moulds for castings. SIGN INDUSTRIES normally work with 3 mm thick material, and can etch bend and weld Stainless Steel up to 3 metres x 1.5 metres, and down to small sequential tags for wiring looms.

## ESTIMATING SOFTWARE

## GOFASO SOFTWARE

129 Devizes Road, Hilperton, Trowbridge, Wiltshire, BA14 7SZ

Tel: 01225 718930

sales@gofaso.co.uk

www.gofaso.co.uk

Gofaso Software makes quoting fast and easy! Gofaso has been specialised for Sign companies, providing user-friendly calculation templates, workshop management, invoicing and customer relations upkeep. With module E-CRM you can make use of QR-codes on worksheets. Gofaso includes startling new tips and innovative techniques giving your company the strongest advantage.

## FINGERPOST SIGNS

## SIGNSCAPE AND SIGNCONEX LTD

Pear Tree Works, Bath Road, Upper Langford, Bristol BS40 5DJ  
Tel: 01934 852 888

sales@signscape.co.uk  
www.signscape.co.uk

Serving the Sign Trade for over 40 years, we are a leading manufacturer of modular sign systems, notice boards & information displays. Our high quality Fingerpost system combines aluminium or steel posts, with double skin finger-arms, making it highly durable, and ideal for public locations. Choose from Chevron, Bull-nosed or Square ended finger arms, available in standard or custom lengths.

## FLAME POLISHERS

## I-SPI LTD

47 Mansionhouse Road, Mount Vernon, Glasgow G32 0RP

Tel: 0141 764 1600

sales@ispitrade.com

www.ispitrade.com

I-SPI Trade supplier of CE approved flame polishers. The simplest way to add a crystal clear, glass like edge to acrylic. Machines to suit every budget all at THE REAL TRADE PRICE. Visit our web site for more info or give Stephen or Sean a call and we can answer any questions you may have.

## FLAT CUT LETTERS

## ACCENT SIGNS LTD

Units 4, Broadcott Ind. Est., Station Rd., Cradley Heath B64 6NT  
Tel: 0121 561 4600

accsign1@aol.com

www.accentesignsltd.co.uk

Accent Signs have been supplying the sign trade with quality flat cut letters in Acrylic, ACM, Foam PVC, MDF and other substrates for over 30 years. Our letters are supplied with Plastic Locators, Brass Locators or VHB tape, complete with fixing templates or fixing stencils if required. Fast turnaround and confidentiality assured.

## APPLELEC

Appleby House, Walker Terrace, Bradford, West Yorkshire, BD4 7HJ  
Tel: +44 (0)1274 774477

sales@applelec.co.uk

www.applelec.co.uk

Trade suppliers of flat cut out letters, logos and intricate laser work. We offer lettering in a variety of materials such as acrylic, foamex, dibond, stainless steel, aluminium and MDF in different finishes and supplied with or without fixings. Please ask for an information pack or contact one of our friendly and experienced sales staff for assistance. (3D built up lettering is also available).

## CENTRE SIGNS (UK) LTD

Alexander House, Liffie Avenue, Oadby, Leicester LE2 5LH

Tel: 0116 271 4247

graphics@centresigns.co.uk

www.centresigns.co.uk

Trade only supplier for all Flat cut lettering and Logo's. Available in Stainless steel, Aluminium, Alupanel, Dibond, Perspex, Foamex, Polycarbonate, Brass and all composite materials. Laser cutting and Router cutting services as standard. Painted finished are always available. We can supply with or without fixings and always with marked fitting templates. We also supply Builtup Metal lettering.

## FABRICUT

Unit 2 Browells Lane, Feltham, Middlesex, TW13 7EQ

Tel: 020 8751 7250

mailus@fabricut.co.uk

www.fabricut.co.uk

Trade suppliers of flat cut letters and logos etc with a 24 hr next day service available. Lots of materials to choose from: Foamex, Perspex, Composites, MDF, Ply, Aluminium, Polished/Brushed Stainless. Aluminium Composite trays signs folded, glued ready for you to hang. Plastic, brass & nickel locators, various studs & sleeves, 3M VHB tape, drilling templates also available.

## MORCANT DESIGNS LTD

Unit 6, Tom Johnston Road, West Pitkerro Industrial Estate, Dundee DD4 8XD

Tel: 01382 686 286

sales@morcant-designs.co.uk

www.morcant-designs.co.uk

I-SPI Trade supplier of CE approved flame polishers. The simplest way to add a crystal clear, glass like edge to acrylic. Machines to suit every budget all at THE REAL TRADE PRICE. Visit our web site for more info or give Stephen or Sean a call and we can answer any questions you may have.

## SIGN HERE

179 Fosse Road North, Leicester, LE3 5EZ

Tel: 0500 428 021

sales@sign-here.co.uk

www.sign-here.co.uk

Trade service for flat cut lettering & logos in Acrylic Foamex, Dibond, Aluminium, Stainless steel & MDF. We will give you a professional reliable & efficient service at a competitive price. From a single letter to a fully illuminated sign ready for installation. For a quote or just friendly advice contact us. We are here to help.

## SYGNET SIGNS LTD

129 Humberstone Rd, Leicester, LE5 3AP

Tel: 0116 262 6288

sales@sygnetsigns.com

www.sygnetsigns.com

We have over 5000 styles to choose from or you can send your own artwork. Letters/logos available in acrylic, foam, md, polycarb, dibond, stainless steel and much more. All cut by router or laser. With or without fixings. All works carried out in-house (we also manufacture built ups and much more).

## FLEXIBLE FACE SIGNAGE

## BROWNING'S LTD

157 English Street, Hull, HU3 2BT

Tel: 01482 380900

sales@browningssltd.co.uk

www.browningssltd.co.uk

Brownings is one of the largest, TRADE ONLY suppliers of signage products in the UK. The Company manufacture everything from poster frames to flexface signs. We can supply you lengths of extrusions, signs in kit form or make the whole sign for you. We utilise the Signcomp suite including Econoflex, Retroframe and Fascia Frame. All signs are to your individual, specific requirements.

## MIDA SIGN SERVICES UK LTD

Welbeck Street South, Ashton-Under-Lyne OL6 7QZ

Tel: 0161 8 300 600

info@midasignservices.co.uk

www.midasignservices.co.uk

Specialised installers of all flexible faced systems. Nationwide service. Illuminated or non-illuminated. We can supply and install. Call for details.

## GENERAL SIGN SUPPLIERS

## BROWNING'S LTD

157 English Street, Hull, HU3 2BT

Tel: 01482 380900

sales@browningssltd.co.uk

www.browningssltd.co.uk

Brownings is one of the largest, TRADE ONLY suppliers of signage products in the UK. We manufacture poster frames, menu cases, slimlocks, signtrim, troughlights, acrylic-faced light boxes, flexfaced signage and now our new Texsign frames for internal use. We supply in any size or quantity, from 1 offs to multiple rollouts either as lengths of extrusion, in kit form or as made-up signs.

## KINGS PLASTICS LTD

The Signbuild Centre, Kelso House, Waterloo Street, St Philips, Bristol, BS2 0PH

Tel: 0117 9411 411

enquiry@kingsplastics.co.uk

www.kingsplastics.co.uk

For all types of sign. Individual flatcut & built up lettering, illuminated with LED's. Edgelite signs, Illuminated signs, Modular sign systems, Frames & panels, engraving on plastics, LED's and aluminium and brass, labels and stencils. LED's & convertors etc. Also material supplies cut to size & laser cutting. A complete service to the trade. For further information, check out our website & online shop.

## CHANNEL ISLANDS

BluePrint Signs & Garments, 20 Ap-sley Road, St Helier, Jersey, Channel Islands, JE2 4LR

Tel: 01534 857633

Mob: 07700 800 999

paul@blueprintsigns.co.uk

www.blueprintsigns.co.uk

Blueprint Signs & Garments offers a professional signage production and installation service throughout the Channel Islands, fully qualified crews based in Jersey completely cover all of the Channel Islands inclusive of Guernsey, Sark, Herm and Alderney.

## GLOBAL ERECTING SIGN

### SERVICES LTD (EST. 1996)

Ascension House, Phoenix Business Park, St Neots, Cambridgeshire, PE19 8EP

Tel: 01480 211948

info@gessltd.co.uk

www.gess.uk.com

The complete package. We offer an exemplary installation service for all types of signage, from street level to extreme high level, specialising in abseiling. We have full Public and Company Liability Insurance. For each installation we provide a full project management service, from site survey to sign off and provide a full Risk and Method Statement prior to any works being undertaken.

## MEDIA ABSEILING

69 Soulbury Road, Leighton Buzzard, Beds, LU7 2RW

Tel: 0845 345 7712

Mob: 07702 950 218

info@mediaabseiling.com

www.mediaabseiling.com

Rope access company specialising in the installation and maintenance of all types of signage, banners and lighting. We operate nationwide and throughout Europe and provide advice, site visits, fast turnaround and most importantly award-winning results.

## MIDA SIGN SERVICES UK LTD

Welbeck Street South, Ashton-Under-Lyne OL6 7QZ

Tel: 0161 8 300 600

info@midasignservices.co.uk

www.midasignservices.co.uk

Professional installation and maintenance of all types of signage, graphics and banners. Including, Site surveys, Illuminated signs, Flexface signage, LED etc. Nationwide service. Established 1984.

## PERFECTIONIST PROJECTS LTD

Dittons Road, Polegate, BN26 6HY

Tel: 01323 489361

www.perfectionistprojects.co.uk

Our unbranded installation crews are very experienced, fully qualified and are all directly employed by us, we do not sub-contract out work - this ensures clear and accurate communication at all times. We are available at short notice to assist your company anywhere in the UK with a complete range of professional services.

## PROLICHT UK LTD

14 Spire Green Centre, Flex Meadow, Pinnacles West, Harlow, Essex CM19 5TR

Tel: 01279 780 170

ukhelp@prolicht.com

www.prolicht.com

An experienced professional sign and lighting contractor to undertake Surveys, Project Management, Individual or Programmed Installations, Planned or Reactive Maintenance, Illumination and Accident 'make safe' and repairs, throughout the U.K. All crews are fully trained to current Health and Safety standards including Pasma, IPAF and UKPIA Safety Passports.

## SIGN INSTALL

Rayford House, School Road, Hove, Sussex, BN35HX

Tel: 01903 866 101

trade@sign-install.co.uk

www.sign-install.co.uk

We'll take all the hassle, you make all the profit. Offering the complete package, from installation of signs and graphics down to waste signage removal. Fully Health and Safety Compliant expert signage installation teams, at affordable realistic prices. Covering the South East, London and the Midlands.

## SIGN INSTALLATIONS (EST. 1995)

2-4 Foredown Drive, Portslade, East Sussex BN41 2BB

Tel: 01273 424900

sales@sussexsigns.com

www.sign-installations.co.uk

Let us be your professional sign installation team, in London, Sussex, Hampshire, Surrey and Kent. With 25 years of sign installation experience, our neatly presented fitting crews will work for you to increase your profits. Customer service and client confidentiality are paramount, so you can be sure your hard earned reputation is in safe hands.

## SIGNS & GRAPHICS INSTALLATIONS

40 Sherwell Valley Road, Torquay, Devon TQ2 6EY

Tel: 01803 701 887

steve@signsandgraphicsinstallations.co.uk

www.signsandgraphicsinstallations.co.uk

Signs & Graphics Installations offer a one-stop installation and maintenance service, providing a whole package: surveying, project managing, installation and maintenance. Once we receive your order our professional sign fitting crew will be able to install, maintain and finish your signage to the highest standard.

## LAMINATING/ENCAPSULATING

## VIVID LAMINATING TECHNOLOGIES

St.Georges House, Whitwick Road, Coalville, Leicestershire, LE67 3FA

Tel: 0345 1 30 40 50

sales@vivid-online.com

www.vivid-online.com

Vivid supply a wide range of laminating products including the award-winning Easymount range of wide format laminators, available in cold, heat assist and hot models. Vivid also supply the Boss range Pressure Sensitive Over Laminates, Self Wound Mount Films & Printable Vinyl Roll fed and the Trimfast range of wide format Board Cutters and Multi Substrate Cutters.

## LASER CUTTING/ENGRAVING

## N E PLASTICS LTD

Unit 1, Ruxley Corner Industrial Estate, Edginton Way, Sidcup, Kent DA14 5BL

Tel: 020 8308 9990

sales@neplastics.co.uk

www.neplastics.co.uk

One of the UK's largest independent stockholders of semi-finished plastics, offering a huge range of both branded and own label products including Crylux cast acrylic, Alliance ACP, Foamalite, Lumex, Viscom and Aria. A next day delivery service on cut to size and polished acrylic is available. We also offer a trade service on CNC Router & Laser cutting, Sign trays and bespoke plastic fabrication.

## SIGN HERE

179 Fosse Road North, Leicester, LE3 5EZ

Tel: 0500 428 021

sales@sign-here.co.uk

www.sign-here.co.uk

Trade service for Laser flat cut & built up lettering & logos in Acrylic, Aluminium & Stainless steel. We will give you a professional reliable & efficient service at a competitive price. From a single letter to a fully illuminated sign ready for installation. For a quote or just friendly advice contact us. We are here to help. Work with us..... work with experience

## SYGNET SIGNS LTD

129 Humberstone Rd, Leicester, LE5 3AP

Tel: 0116 262 6288

sales@sygnetsigns.com

www.sygnetsigns.com

Specialist laser cutting service. We stock a variety of materials in various thicknesses. You may also free issue materials. Laser capabilities are - stainless steel up to 4mm, mild steel up to 12mm. We can also cut very small acrylic detail with d/s tape already applied. All works carried out in-house.



## THINK LASER LTD

Unit 3, Perrywood Business Park,  
Honeycrook Lane, REDHILL, Surrey  
RH1 5DZ

Tel: 01737 826902  
info@thinklaser.com  
www.thinklaser.com

Our Subcontract department offers a high quality laser engraving service for permanently marking flat, cylindrical and irregular surfaces of virtually any material. We also offer laser cutting up to 1400 x 900mm in size and 18mm in thickness on a wide variety of non-metallic materials such as acrylic, PLY and MDF. With a minimum order value of £30, laser processing has never been so affordable.

## LASER CUTTING/ENGRAVING MACHINES

### HPC LASER LTD

Eildon, Bradford Road, Cleckheaton,  
West Yorkshire BD19 3LW  
Tel: 01422 310 800

sales@hpclaser.co.uk  
www.hpclaser.co.uk

Specialist suppliers of LASERSCRIPT CO2 laser engravers and cutters. Our lasers are capable of cutting, engraving and marking a wide range of materials including laminate, metal, glass, acrylic, textiles, wood, paper, card and leather. Also available is an A4 Laser with professional Laser software for those struggling for space. Optional 1 to 3 year warranty available. Over 1100 machines supplied!

### THINK LASER LTD

Unit 3, Perrywood Business Park,  
Honeycrook Lane, REDHILL, Surrey  
RH1 5DZ

Tel: 01737 826902  
info@thinklaser.com  
www.thinklaser.com

The "Lightblade" range of flatbed CNC laser cutting and engraving machines are specifically designed for non-metallic marking and cutting applications. Our comprehensive system specification and 1st class training and support ensures you will be up and running in no time. With bed sizes ranging from 300 x 400mm up to 1600 x 1000mm there's a system to suit all applications and pockets. Call us now!

### TROTEC LASER

Unit 3 Faraday Close, Washington,  
Tyne & Wear NE38 8QJ  
Tel: 0191 580 1184

www.troteclaser.co.uk

Manufacturers and suppliers of leading laser cutting, marking and engraving technology, Trotec offers a range of lasers with desktop, flatbed, large format and galvo options. With 6 showrooms in the UK and Ireland, hands-on workshops, training and demos show the high quality engraving and productivity of Trotec's laser machines. Trotec also supplies its own range of rotary & laser materials.

## LED DRIVERS

### POWERPAX

Unit 10 The Markham Centre, Station Road, Theale, Reading, Berkshire, RG7 4PE

Tel: +44 (0)118 903 3290  
www.powerpax.co.uk

One of Europe's leading suppliers of power conversion products. PowerPax LED drivers cover power ratings from 6W to 600W. All models are long life with warranty up to 5 years. Fully safety approved and meeting latest efficiency standards. Available from UK stock. Check out the website for further information on our new ultra slim range of LED drivers specifically for illuminated sign manufacturers

## LED ILLUMINATED LETTERS

### ACCENT SIGNS LTD

Units 4, Broadcote Ind. Est., Station Rd., Cradley Heath B64 6NT  
Tel: 0121 561 4600

accsign1@aol.com  
www.accent-signs-ltd.co.uk

Accent signs "SLIMLITE" flat cut letters & logos made from 6mm opal acrylic with imbedded super bright white Led's to create a unique edge and halo illumination. Available with ACM, Acrylic or vinyl faces. Suitable for internal & external use. Supplied with standard locator fixings for ease of fitting.

## LED ILLUMINATION

### 3D SIGN SYSTEMS LTD T/A CITI LED

Unit 1, 411 Pollokshaws Rd, Glasgow, G41 1QZ  
Tel: 0141 422 2500

sales@citi-led.co.uk  
www.citi-led.co.uk

We are a trade only supplier of LED Modules for all types of channel letters, light boxes and solid acrylic "Neon" effect type letters. We have some very unique specialist LEDs, visit our website for product information and installation tutorials. We offer premium grade reliable products at highly competitive prices. Our unrivalled pre-sales guidance and after sales support will ensure your projects are executed with maximum effect.

### APPLELEC

Appleby House, Walker Terrace,  
Bradford, West Yorkshire BD4 7HJ  
Tel: +44 (0)1274 774477

sales@applelec.co.uk  
www.applelec.co.uk

Trade suppliers of proven LED lighting solutions and manufacturers of the flat lighting unit, LED Light Sheet. Energy efficient, award winning LED lighting modules in a variety of colours including RGB (colour changing) are available for both indoor and outdoor applications. Applelec offer unrivalled service and after sale technical support for our LED solutions to ensure customers receive continued assistance.

## ARTILLUS - WAYS 2 DISPLAY LTD

Britannia House, 29 Station Road,  
Kettering, Northants NN15 7HJ  
Tel: 0333 123 0345

sales@artillus.com  
www.artillus.com

DIAMOND 24V LED light boxes and GARNET light panels can be produced in any size up to 2500 x 1500mm. Diamond light boxes have a 20mm deep frame and 25mm snap frame front. Standard sizes in A4 up to A0 for next day delivery. Custom boxes & GARNET 8mm deep light panels can be made in single colour LED or RGB with controllers, can be dimmable or have built-in phasing. No minimum order quantity.

### FOCUS LED UK LTD.

Unit 64 Cariocca Business Park, 2  
Hellidon Close, Arkwick, Manchester, M12 4AH

Tel: 0161 27 27 778  
sales@focusledltd.co.uk

www.focusledltd.co.uk

Specialise in LED Lighting for Signs & Shop fitting, Kitchens, Restaurants, Commercial & Domestic Lighting. Quality & Professional Lighting to get your job done by giving you our best advises, there is no job too small. You only pay for quality products at Focus LED. Check out our gallery to see how we helped others to achieve their projects.

### KINGS PLASTICS LTD

The Signbuild Centre, Kelso House,  
St Philips, Bristol, BS2 0PH  
Tel: 0117 9411 411

enquiry@kingsplastics.co.uk  
www.kingsplastics.co.uk

White, warm white & coloured LED modules in 4 sizes and LED ribbon - Flexi ribbon & RGB ribbon. 12v power converters, RGB controllers, together with a range of connectors. Leds ideal for lettering & lightboxes. For full details on our range, prices and for images, check out our website & online shop. Competitive prices guaranteed!

## LED SOLUTIONS

129 Humberstone Road, Leicester  
LE5 3AP  
Tel: 0116 262 5933

sales@ledsolutions.co.uk  
www.ledsolutions.co.uk

LED Solutions supply quality, energy efficient LED products along with power supplies and control gear for use in the sign trade. We are UK distributors for Hitechled who specialise in modules for sign illumination and offer 5-year warranties. We supply RGB modules, DMX systems, Flexible LED and IP Rated Power Supplies. Please contact us for further information.

## OSHINO LED LIGHTING

1 Churchfield Court, Robey Close,  
Linfield Lane, Nottingham NG15 8AA  
Tel: 0115 964 1305

Mob: 07766 777878  
sales@oshino.co.uk

www.oshino-lamps.co.uk

New H-LED 333 is a chain LED lighting system for built-up channel letters, flat-cut letters and other sign lighting applications. Manufactured using a state-of-the-art automated assembly process, H-LED 333 promises to bring a new level of economy to the discerning sign maker along with a fully featured specification you would expect from Oshino.

### SIGNTRADE LETTERS LTD

225 Long Lane, London N3 2RL  
Tel: 0500 456 700

sales@signtrade.co.uk  
www.signtrade.co.uk

Chromasign launched at Sign UK. We offer a complete range of ChromaForm Letters with Halo Lighting not available anywhere else. Ring Susan or Lesley for details and samples.

### WELOVELEDS.CO.UK

Tel: 01132 524 706  
www.WeLoveLEDS.co.uk

The favourite online LED supplier to the sign, display and shopfitting trade. Large stocks carries, experienced sales people, no non-sense ordering. Orders can be made online, over the phone and by email. Use Code: EX10 for 10% trade discounts.

## LED STRIP LIGHTS

### LED-SUPPLIES.COM

Unit 10 The Markham Centre, Station Road, Theale, Reading, Berkshire, RG7 4PE

Tel: +44 (0)118 903 3290  
www.led-supplies.com

One of the largest suppliers of the widest range of LED strip lighting in the UK. The 'How to use LED strip' videos on YouTube from LED-SUPPLIES.COM have now had over 2.5 million views. Massive range of high reliability LED strip lighting from stock for next day delivery. Full technical support and wide range of installation accessories and controllers

## LIGHT BOXES & LIGHTING

### APPLELEC

Appleby House, Walker Terrace,  
Bradford, West Yorkshire, BD4 7HJ  
Tel: 01274 774477

sales@applelec.co.uk  
www.applelec.co.uk

Trade suppliers of fabricated and extruded light boxes, custom made to client design requirements. From flat faced and curved styles, to LED illumination and colour changing modules, a definitive range of light box products are available. Applelec's flat light unit LED Light Sheet is regularly used to create ultra slim light boxes with even illumination and a depth of just 25mm.

### BROWNING'S LTD

157 English Street, Hull, HU3 2BT  
Tel: 01482 380900

sales@browningsltd.co.uk  
www.browningsltd.co.uk

Brownings is one of the largest TRADE ONLY suppliers of signage products in the UK. The Company manufacture everything from poster frames to flex-faced signage. We have our own extrusions for the manufacture of acrylic-faced light boxes and can supply as lengths, in kit form or as ready-made up signs. All to your individual, specific requirements in terms of size, colour or shape.

### MID WEST DISPLAYS

The Display Centre, Knights Way,  
Battlefield Enterprise Park, Shrewsbury SY1 3AB  
Tel: 01743 465531

sales@midwestdisplays.co.uk  
www.MidWestDisplays.co.uk

Mid West Displays manufacture wide range of LED illuminated Light Panel Poster Displays. We also stock wall mounts, snap frames, mirror screws, cable/rod suspended systems, poster pockets and many more. We are pleased to be working with the highest quality materials at competitive prices.

## MAGNETIC MATERIAL

### ANCHOR MAGNETS LTD

Bankside Works, Darnall Road,  
Sheffield S9 5AH

Tel: 0114 244 1171  
sales@anchormagnets.com

www.anchormagnets.com

Magnetic & attractive products including the universally printable & wide format products: digifilm® ferrous media (1600mm), supraferro® ferrous sheet (1260mm) & supamag® magnetic sheet (1260mm) UK's highest pull force, anti-marking UV coating, in white, plain, dry wipe, adhesive backed. For graphics, retail POS, vehicle signage, holding & hanging solutions use the UK's leading magnetic innovators.

## BISBELL MAGNETIC PRODUCTS LTD.

Hillfield Lane, Stretton, Burton on  
Trent, Staffs DE13 0BN  
Tel: 01283 531000

sales@bisbellmagnets.com  
www.bisbellmagnets.com

The UK's widest range of digitally printable wide format magnetic and ferro sheet (both over 1200mm wide). Maxmag vehicle grade magnetic materials available in white, plain or adhesive backed - by roll or cut to your specific requirements. Also available neo magnets, vehicle roof magnets, sign grippers and a full range of high tape to suit every budget and application.

### MAGNETIC SOLUTIONS LTD

Brooklands Business Park, Leigh  
Street, Sheffield S9 2PR

Tel: 0114 2422211  
sales@magnetic-solutions-ltd.co.uk

www.magnetic-solutions-ltd.co.uk  
Part of the Sanders Group, Europe's largest combined supplier of magnetic & ferro sheet materials including wide format magnetic (1370mm) and ferrous media (1600mm). Also available, retail POS graphic materials, magnetic flooring, neo magnets, sign grippers and magnetic tape with a range of adhesive finishes to suit your requirements. We can provide the solutions.

## METAL FABRICATIONS

### SIMPLEX LTD

Unit 3 - 16 Peter Rd, Lancing Business Park, Lancing, West Sussex.  
BN15 8TH

Tel: 01903 750333  
sales@simplexltd.com

www.simplexltd.com

Simplex are a trade only supplier of metal fabrications and sign systems. With an in house CNC router, 3 metre guillotine, brake-press and rollers, full welding equipment and much much more we are able to turn your ideas into reality!! From basic trays, to fret cut and illuminated fascias, oval lightboxes, built up metal letters, right up to 7 metre monolith signs we've pretty much made it all!

## MODULAR PANEL SIGN SYSTEMS

### SIGNSCAPE AND SIGNCONEX LTD

Pear Tree Works, Bath Road, Upper  
Langford, Bristol BS40 5DJ  
Tel: 01934 852 888

sales@signscape.co.uk  
www.signscape.co.uk

Serving the Sign Trade for over 40 years, we are a leading manufacturer of modular sign systems, notice boards & information displays. Our systems create a wide range of sign solutions including; post and panel, flush panel and curved panel signs; wayfinding signs, wall directories, monolith and finger-post signs. Other products include exterior notice boards, poster/menu cases, and letter boards.

### SIMPLEX LTD

Unit 3 - 16 Peter Rd, Lancing Business Park, Lancing, West Sussex.  
BN15 8TH

Tel: 01903 750333  
sales@simplexltd.com  
www.simplexltd.com

Simplex are a trade only supplier of sign systems and metal fabrications. We offer a range of Pole & Plank products for post and wall mounted signs, fingerposts and mini monoliths. For versatile curved interior directories our System 4 is unbeatable whilst as an approved convertor for the Accord 15 "slat" type system and a recognised supplier of MSS we really hope we can help with all your needs.

## MOULDED & FABRICATED PLASTICS

### MERCURY & PHILLIPS SIGNS

51-59 Waterworks Road, Norwich  
NR2 4DA

Tel: 01603 666699  
sales@mercuryphillips.co.uk

www.mercuryphillipssigns.co.uk

Suppliers of moulded acrylic pans and logos up to 2800mm x 1500mm and other types of press and vacuum forming in PVC and HIPS. Specialists in fabricated plastics for POS displays with full screen print, graphics and CNC routing capabilities.

### PROJECT PLASTICS LTD

7 Grange Way Business Park, Whitehill Industrial Estate, Colchester  
CO2 8HF

Tel: 01206 868696

project.plastics@btinternet.com  
www.projectplastics.co.uk

Manufacturers of acrylic domes and shapes, tubes, point of sale displays and showcases. Bespoke plastic fabrication. CNC routing, diamond edge polishing, 3m x 2m moulding oven for oven forming, vacuum forming and screen printing. Plastic cut to size service.

## MOULDED LETTERS

### ACCENT SIGNS LTD

Units 4, Broadcote Ind. Est., Station Rd., Cradley Heath B64 6NT  
Tel: 0121 561 4600

accsign1@aol.com  
www.accent-signs-ltd.co.uk

Largest range of moulded acrylic letters in the UK. Mirror effect moulded letters, LED illumination, logos, panels, complete fascia panels, blow moulding, aluminium, composite trays and more! Samples on request.

### MERCURY & PHILLIPS SIGNS

51/59 Waterworks Rd. Norwich NR2 4DA

Tel: 01603 666699

sales@mercuryphillips.co.uk  
www.mercuryphillipssigns.co.uk

Moulded letters and logos in all standard Perspex colours and UV stabilised gold and silver acrylics, in 8 standard sizes, bespoke sizes available on application. Press, vacuum and blow moulded pans, in acrylic and petg also available.

### SIGNTRADE LETTERS LTD

225 Long Lane, Finchley London N3 2RL

Tel: 020 8346 8515  
sales@signtrade.co.uk

www.signtrade.co.uk

Moulded letters are our speciality with stock of 20 fonts 8 letter heights in coloured Perspex and 1000's of flat cut letters as well. Your own font or logo is made by our own toolmakers. With over 60 years of experience to call on.

### WARD SIGNS

Maze House, Maze Street, Barton  
Hill, Bristol BS5 9TE

Tel: 0117 955 3385  
info@ward-signs.co.uk

www.ward-signs.co.uk

Having patented the original method of making cast resin letters, Wards of Bristol can manufacture and supply resin lettering to the highest standard. Our stock patterns for resin letters are a cost effective method of achieving the same styles as traditional bronze and aluminium (which we also cast in house) but we can also make custom designed patterns for letters and logos for all your needs.

## NAMEPLATES

### MOCKRIDGE LABELS & NAMEPLATES LTD

Cavendish Street, Ashton-under-Lyne, Lancs OL6 7QL  
Tel: 0161 308 2331

sales@mockridge.com  
www.mockridge.com

Specialists in chemically etched nameplates. Brass, Stainless Steel and Anodised Aluminium. Any size up to 2400 x 1200mm (8ft x 4ft). One-offs up to 5000+. Trade work is totally confidential.



## NEON MANUFACTURERS (TRADE)

### A1DESIGNS

4 Sandy Lane North, Wallington, Surrey SM6 8JX  
Tel: 020 8646 9886  
enquiry@a1designs.co.uk  
www.a1designs.co.uk

Neon & Cold Cathode Manufacturers to the Trade. Fast turnaround & Delivery, Quick repair service. Installation, Fault diagnosis, Repairs & Maintenance. Confidential Service. All neon accessories, Transformers, Cable, Tube supports etc.

### AVENUE SIGNS LTD

216-222 Luton Road, Chatham, Kent ME4 5BS  
Tel: 01634 841300  
info@avenuesigns.co.uk  
www.avenuesigns.co.uk

Full computerised design service neon and cold cathode lighting. Fully qualified installation engineers, fault diagnosis, fast repair service. Complete sign service from vinyl through to acrylic to polished stainless steel to transformer and neon accessory supplies.

### LOGOTECH DISPLAY SOLUTIONS LTD

Unit 6, Atley Business Pk, North Nelson Ind Est, Cramlington, Newcastle Upon Tyne NE23 1WP  
Tel: 01670 737 225  
sales@logotech-ltd.co.uk  
www.logo-tech.co.uk

Specialists in neon manufacture to the trade, all types of neon work undertaken. Quick repair service. Very competitive prices. Over 25 years experience in the sign trade.

## NEON PLUS®

### THE SIGN GROUP

Victoria Works, Bruntcliffe Road, Morley, Leeds, West Yorkshire, LS27 0LF  
Tel: 0113 25 24 706  
info@thesigngroup.co.uk  
www.thesigngroup.co.uk

Ultra Slimline illuminated letters and shapes suitable for interior and exterior applications. Extremely bright with various colour options. Very strong and robust, easy to fit and outlast other comparable alternatives.

## NEON REPLACEMENT LETTERS

### ACCENT SIGNS LTD

Units 4, Broadcote Ind. Est., Station Rd., Cradley Heath B64 6NT  
Tel: 0121 561 4600  
accsign1@aol.com  
www.accentesigns.co.uk

Accent Signs "LITEFORM" letters & logos with a moulded half round acrylic profile of only 15mm to look like Neon glass. Illuminated with super bright Led's. Available in a wide range of colours. Suitable for internal & external use. Supplied with standard locator fixings for ease of fitting.

## NOTICE BOARDS - LOCKABLE/EXTERIOR

### NOTICE ME

2 Glenister House, Avondale Drive, Hayes, Middx UB3 3PP  
Tel: 0208 581 1067  
sales@noticeme.org.uk  
www.noticeme.org.uk

Sign companies come to us for a truly extensive range of standard and made to measure, indoor & outdoor notice boards and whiteboards. Standard internal pin boards are available in over 100 felt colours and our cut to size service is available on many products. We supply some extremely competitive outdoor notice boards to compliment your sign work. See our complete range of display products.

### SIGNSCAPE AND SIGNCONEX LTD

Pear Tree Works, Bath Road, Upper Langford, Bristol BS40 5DJ  
Tel: 01934 852 888  
sales@signscape.co.uk  
www.signscape.co.uk

Serving the Sign Trade for over 40 years, we are a leading manufacturer of modular sign systems and notice boards. We have the widest range of exterior notice boards of all UK manufacturers, and specialise in tailoring our boards to suit each location. This is achieved through a wide range of options, including; wall, rail, post and stand mountings, mains/solar illumination and custom graphics.

## NUMBER PLATES

### TENNANTS UK LTD

Tennant House, Mount Street, New Basford, Nottingham NG7 7HX  
Tel: 0115 973 8080  
sales@tennantsuk.com  
www.tennantsuk.com

Approaching our 50th Anniversary, Tennants go from strength to strength in the supply of number plate printing systems and components. LG Plates is the original full colour printing software available to the trade and is still considered the industry standard. Signmakers; upgrade to LG Signs for quick and easy sign manufacture. Visit our website or contact the sales office for more information.

## PLASTIC SHEETS

### BRETT MARTIN PLASTIC SHEETS

24 Roughfort Road, Mallusk, Co Antrim BT36 4RB  
Tel: 028 9084 9999  
semifinished@brettmartin.com  
www.brettmartin.com

Brett Martin is a leading manufacturer of plastic sheet products for signage, interior design, shop outfitting, POS displays and fabrication. Products include Foamalux, the extensive foam PVC range in bright White, Satin and Gloss colours and an environmentally friendly Recycled material in addition to Polycarbonate, PVC, Acrylic, aPET, PETg and Styrene sheet.

### NE PLASTICS LTD

Unit 1, Ruxley Corner Industrial Estate, Edgington Way, Sidcup, Kent DA14 5BL  
Tel: 020 8308 9990  
sales@neplastics.co.uk  
www.neplastics.co.uk

One of the UK's largest independent stockholders of semi-finished plastics, offering a huge range of both branded and own label products including Crylux cast acrylic, Alliance ACP, Foamalite, Lumex, Viscom and Arla. A next day delivery service on cut to size and polished acrylic is available. We also offer a trade service on CNC Router & Laser cutting, Sign trays and bespoke plastic fabrication.

### PERSPEX DISTRIBUTION LTD

2-3 Lonebarn Link, Springfield Business Park, Chelmsford, Essex CM2 5AR  
Tel: 01245 232800  
sales.chelmsford@perspex.co.uk  
www.perspex.co.uk

Perspex Distribution offer Perspex® cast acrylic, extruded acrylic, aluminium composite, PVC foam and other thermoplastic sheets for the sign industry from 5 distribution centres in Blackburn, Chelmsford, Leeds, Tamworth and Weybridge. With a comprehensive stock-holding in many colours and finishes and a cut to size service at all branches, Perspex Distribution can deliver your requirements fast.

### RIGHTON LTD

Righton House, Brookvale Road, Witton, Birmingham B6 7EY  
Tel: 0121 356 1141  
marketing@righton.co.uk  
www.righton.co.uk

UK distributor of Polycasa Crylux cast & Crylon extruded sheet acrylic. Available in a wide range of clear, opals, colours and special finishes. Also stocked: Alucobest aluminium composite sheet, Marlon solid polycarbonate, PET-G, SAN, polystyrene, hygienic cladding, rigid PVC and fixing accessories, sign post systems, aluminium sheet and extrusions.

### TELEGAN PRESSED PRODUCTS LTD.

Unit 3, Old Mercedes Building, Stour Road, Bathside, Harwich, Essex, CO12 3HF  
Tel: 01255 554141  
sales@teleganpressedproducts.com  
www.teleganpressedproducts.com

Leading manufacturer of plate pressed PVC sheet offering equivalents to Darvic, Pacton and Cobex under our trade name TELBEX. We also manufacture VYNALAST™ engraving laminate. A comprehensive range of photoluminescent boards and self adhesive vinyl is available in PSPA class B and Class C to order.

### THYSSENKRUPP MATERIALS (UK) LTD

Coxs Lane, Cradley Heath, West Midlands B64 5QU  
Tel: 0844 846 9573  
sales.tkruk@thyssenkrupp.com  
www.thyssenkruppmaterials.co.uk

thyssenkrupp Materials are stockists of plastics and aluminium for the sign industry. Experienced staff and an extensive product range give customers the flexibility to cover all their requirements. Products include Acrylic, PETG, Polycarbonate, Dibond and Foam, alongside which we offer a cut to size service and shipment to all areas on our own transport.

## POINT OF SALE FITTINGS

### SIGNWAVES

Lefevre Way, Gapton Hall Industrial Estate, Great Yarmouth, Norfolk NR31 0NW  
Tel: 01493 419300  
enquiries@signwaves.co.uk  
www.signwaves.co.uk

Signwaves is the UK's leading supplier of point of sale equipment. From trade exclusive Stand-Off Sign Fixings to a wide range of glass mounted, wall mounted and suspended poster holders, there are a multitude of fittings available to mount displays in any location. Pavement and forecourt signs, illuminated displays and portable exhibition displays also form part of the Signwaves collection.

### UK POS

Horsfield Way, Bredbury Park Industrial Estate, Stockport SK6 2TD  
Tel: 0161 431 4400/4411  
www.ukpos.com

UK Point of Sale leading manufacturers of display products Acrylic & PVC poster holders, Sign Supports, Aluminium Snap Frames, A Boards, Poster cases & Point of sale fittings.

## POLYSTYRENE SIGN SERVICE

### Fonteyne Signs & Displays

Unit 3, 181 Verulam Road, St Albans, Herts AL3 4DR  
Tel: 01727 832146  
studio@fonteynesigns.co.uk  
www.fonteynesigns.co.uk

Manufacturers of all types of polystyrene cut letters, graphics & 3-dimensional models. Virtually any logo, graphic or shape can be cut in polystyrene. Especially useful for short term exhibition, conference or promotional use (All polystyrene has a fire retardant additive). Polystyrene can be faced with vinyl or inkjet prints. Fitting service nationwide. Established 1976.

## POSTER HOLDERS / CASES

### BROWNINGS LTD

157 English Street, Hull, HU3 2BT  
Tel: 01482 380900  
sales@browningsltd.co.uk  
www.browningsltd.co.uk

Brownings is one of the largest, TRADE ONLY suppliers of signage products. We manufacture poster frames, menu cases, slimlocks, signtrim, troughlights, acrylic-faced light boxes, flexfaced signage and now our new Texsign frames for internal use. The two versions of poster holders, the slimlock and menu case are both thin, lockable and hinged. They are available in any practical size and colour.

### SIGNSCAPE AND SIGNCONEX LTD

Pear Tree Works, Bath Road, Upper Langford, Bristol BS40 5DJ  
Tel: 01934 852 888  
sales@signscape.co.uk  
www.signscape.co.uk

Serving the Sign Trade for over 40 years, we are a leading manufacturer of modular sign systems, notice boards & information displays. Our Avenue poster case provides high quality yet affordable, external poster display. Sizes from A4-A0, in wall, post, and rail mounted versions, with headers and sign panel options. We also manufacture illuminated menu cases for hotel and restaurant settings.

### SIGNWAVES

Lefevre Way, Gapton Hall Industrial Estate, Great Yarmouth, Norfolk NR31 0NW  
Tel: 01493 419300  
enquiries@signwaves.co.uk  
www.signwaves.co.uk

Signwaves supplies poster displays suitable for both indoor and outdoor use. As the UK's largest manufacturer of point of sale signs and displays, Signwaves can provide you with high quality poster frames, snapframes, menu cases and lockable noticeboards. Express made to order service is available for a selection of custom coloured Slimlok Menu Cases, Poster Cases and Noticeboards.

### UK POS

Horsfield Way, Bredbury Park Industrial Estate, Stockport SK6 2TD  
Tel: 0161 431 4400/4411

www.ukpos.com

UK Point of Sale leading manufacturers of display products Acrylic & PVC poster holders, Sign Supports, Aluminium Snap Frames, A Boards, Poster cases & Point of sale fittings.

## POWER SUPPLIES

### POWERPAX

Unit 10 The Markham Centre, Station Road, Theale, Reading, Berkshire, RG7 4PE  
Tel: +44 (0)118 903 3290  
www.powerpax.co.uk

One of Europe's leading suppliers of power conversion products. PowerPax LED drivers cover power ratings from 6W to 600W. All models are long life with warranty up to 5 years. Fully safety approved and meeting latest efficiency standards. Available from UK stock. Check out the website for further information on our new ultra slim range of LED drivers specifically for illuminated sign manufacturers

## PRINT/POSTER FRAMES

### BROWNINGS LTD

157 English Street, Hull, HU3 2BT  
Tel: 01482 380900  
sales@browningsltd.co.uk  
www.browningsltd.co.uk

Brownings is one of the largest, TRADE ONLY suppliers of signage products in the UK. We manufacture poster frames, menu cases, slimlocks, signtrim, troughlights, acrylic-faced light boxes, flexfaced signage and now our new Texsign frames for internal use. The aluminium frame are available in two widths, 25mm and 38mm, can be supplied to your specification and can even be illuminated.

### SIGNWAVES

Lefevre Way, Gapton Hall Industrial Estate, Great Yarmouth, Norfolk NR31 0NW  
Tel: 01493 419300  
enquiries@signwaves.co.uk  
www.signwaves.co.uk

Leading trade suppliers of high quality traditional and contemporary projecting signs and brackets, offering a large range of brackets, panels and lights off the shelf, as well as a comprehensive bespoke service. Competitive prices and next day service. Please visit our website or phone for a brochure.

### UK POS

Horsfield Way, Bredbury Park Industrial Estate, Stockport SK6 2TD  
Tel: 0161 431 4400/4411

www.ukpos.com

UK Point of Sale leading manufacturers of display products Acrylic & PVC poster holders, Sign Supports, Aluminium Snap Frames, A Boards, Poster cases & Point of sale fittings.

## PROGRAMMABLE LED DISPLAYS

### JAYEX TECHNOLOGY LTD

13 Sovereign Business Park, Coronation Road, London NW10 7QP  
Tel: 020 8838 6222  
sales@jayex.com  
www.led-signs-international.com

Jayex is the UK's largest trade supplier and designer of dynamic moving message LED text and video products. We provide indoor and outdoor LED displays that can be embed into static signs or used as stand-alone item providing an eye catching display of virtually any shape and size. We will design and price LED products for your project, helping to keep your workload to a minimum.

### MESSAGEMAKER DISPLAYS LTD

Unit 43 Ormside Way, Holmethorpe Industrial Estate, Redhill, Surrey RH1 2LG  
Tel: 01737 774 738  
info@messagemaker.co.uk  
www.messagemaker.co.uk

Programmable LED text and video specialists for Electronic Digital Signage, standalone or incorporate in your own sign project. Many products are available from stock for Indoor & Outdoor applications, over 15 years experience in the market. Call now for a free quotation or to arrange a visit from a member of our national sales team.

## PROJECTING SIGNS

### IRON DESIGN

37A Douglas Rd., Poole, BH12 2AU  
Tel: 01202 463573  
enquiries@ironsigns.com  
www.ironsigns.com

Leading trade suppliers of high quality traditional and contemporary projecting signs and brackets, offering a large range of brackets, panels and lights off the shelf, as well as a comprehensive bespoke service. Competitive prices and next day service. Please visit our website or phone for a brochure.

### SIGNWAVES

Lefevre Way, Gapton Hall Industrial Estate, Great Yarmouth, Norfolk NR31 0NW

Tel: 01493 419300

enquiries@signwaves.co.uk

www.signwaves.co.uk

Signwaves is the UK's leading manufacturer and supplier of projecting signs, fabric flags and flying banners. A selection of wall mounted, glass mounted and freestanding options are available, with many units suitable for interior and exterior use. All of Signwaves' projecting signs and flags can be printed to order if required.

## REFLECTIVE VINYL/TAPES

### ATC LTD

Calf Hey South, off Well'ith Lane, Rochdale OL11 2JS  
Tel: 01706 633043  
sales@apptape.co.uk  
www.apptape.co.uk

Suppliers of Micro prismatic reflective tapes (3m, Avery, Reflexite) and glass bead reflective vinyl for use on emergency vehicles (police cars & chapter 8 legislation etc) also HGV markings as per EC 104. We stock Conspicuity tape manufactured by Reflexite and Avery which are some of the most reflective materials available on the market. Chapter 8 chevron kits also available.

### TENNANTS UK LTD

Tennant House, Mount Street, New Basford, Nottingham NG7 7HX  
Tel: 0115 973 8080  
sales@tennantsuk.com  
www.tennantsuk.com

In our position of the only UK Master Distributor of Orafol reflective products and bringing 50 years of industry experience, Tennants are ideally placed to service all of your reflective requirements. We stock the full range – Class Ra1, Class Ra2 and micro-prismatic – of roll goods for temporary and permanent traffic signs and provide Chapter 8 chevron kits, conspicuity tape and PPE products.

## ROAD SIGNS & EQUIPMENT

### TENNANTS UK LTD

Tennant House, Mount Street, New Basford, Nottingham NG7 7HX  
Tel: 0115 973 8080  
sales@tennantsuk.com  
www.tennantsuk.com

Tennants are one of the UK's largest manufacturers of temporary traffic signs and a leading distributor of traffic management equipment. So whether your requirements are for sign plates, frames, cones, barriers or lamps, we can be your one stop shop for all things TM. Celebrating our 50th Anniversary next year, we bring significant experience to the industry.



## ROUTER CUTTERS/ PLOTTER BLADES

### ATA ENGINEERING PRO-CESSES

ATA House, Unit B, Boundry Way, Hemel Hempstead, Herts HP2 7SS  
Tel: 01442 264411

sales@ataeng.com  
www.ataeng.com

Extensive range of high quality solid carbide, PCD, carbide tipped and HSS cutters manufactured by ONSRUD CUTTER offer routing solutions for most types of material.

### EDWARD MATHIAS & CO

PO BOX 121, Frodsham, Cheshire, WA6 1AA  
Tel: 01928 739 799

info@edwardmathias.com  
www.edwardmathias.com

Specialist manufacturers/suppliers of tungsten carbide plotter blades and router cutters. We don't just sell blades, we are the UK's leading manufacturer. Note - we have no connection with any other company who sell or re-sharpen blades.

## SCREEN PRINTING

### DARTFORD ENGRAVING & SCREENPRINTING LTD

Unit 4 Power Works Industrial Estate, Slade green Road, Erith, Kent DA8 2HY

Tel: 01322 340 194  
mail@desp.co.uk

www.desp.co.uk

DESP has been trading for over 50 years. Screenprinting, anodic printing, correx boards, stickers, overlays, signs, chemical etching, engraving processes also covered (ALL CARRIED OUT INHOUSE), including artwork. So whether its a 1 off or 1,000s off, we can offer a quick competitive turnround.

### FIRST SIGNS & LABELS LTD

Unit 1, Raynham Close, Raynham Rd Ind Estate, Raynham Road, Bishops Stortford, Herts, CM23 5JP

Tel: 01279 467999

sales@firstsignsandlabels.co.uk  
www.firstsignsandlabels.co.uk

We specialise in high quality screen printing. We are suited to meet print requirements onto many substrates. We have finishing capabilities with die cutting and CNC routing. We offer a fast and efficient service, should you require 1 off's or larger run's give our team a call.

### HT SCREEN PRINT

9 Merlin Way, Hillend Industrial Estate, Dalgety Bay, Fife, KY11 9JY  
Tel: 01383 824522

info@htscreenprint.co.uk  
www.htscreenprint.co.uk

Trade screen printing of garments, estate agency boards, pvc, vinyl, acrylics, metals, glass, wood, POS, anything flat. HT Screenprint have been in business for over 20 years, supplying the highest quality screen printing to the trade at very competitive prices. Our experience produces quality quickly!

### MERCURY & PHILLIPS SIGNS

51/59 Waterworks Rd. Norwich NR2 4DA

Tel: 01603 666699

sales@mercuryphillips.co.uk

www.mercuryphillipsigns.co.uk

High quality screen printing to all types of rigid and flexible base materials ie. self-adhesive vinyl, paper, plastic and metal. From single to full colour and small or large runs.

## SCULPTORS

### BRYAN RAWLINGS DESIGN

45 Nunney Close, Keynsham, Bristol BS31 1XG

Tel: 0117 986 7894 / 7291

bryan@bryanrawlings.com

www.bryanrawlings.com

Designers and makers of coats of arms, emblems and all types of sculptural and decorative signage. GRP, cast resins, metals, detailed hand painting and much more. Large range of royal coats of arms available. Specialist suppliers to the sign trade.

## SHEET MATERIALS

### N E PLASTICS LTD

Unit 1, Ruxley Corner Industrial Estate, Edgington Way, Sidcup, Kent DA14 5BL

Tel: 020 8308 9990

sales@neplastics.co.uk

www.neplastics.co.uk

One of the UK's largest independent stockholders of semi-finished plastics, offering a huge range of both branded and own label products including Crylux cast acrylic, Alliance ACP, Foamalite, Lumex, Viscom and Arla. A next day delivery service on cut to size and polished acrylic is available. We also offer a trade service on CNC Router & Laser cutting, Sign trays and bespoke plastic fabrication.

### RIGHTON LTD

Righton House, Brookvale Road,

Witton, Birmingham B6 7EY

Tel: 0121 356 1141

marketing@righton.co.uk

www.righton.co.uk

UK distributor of Polycasa Crylux cast & Crylon extruded sheet acrylic Available in a wide range of clear, opals, colours and special finishes. Also stocked: Alucobest aluminium composite sheet, Marlon solid polycarbonate, PET-G, SAN, polystyrene, hygienic cladding, rigid PVC and fixing accessories, sign post systems, aluminium sheet and extrusions.

### TELEGAN PRESSED PRODUCTS LTD.

Unit 3, Old Mercedes Building, Stour Road, Bathside, Harwich, Essex, CO12 3HF

Tel: 01255 554141

sales@teleganpressedproducts.com

www.teleganpressedproducts.com

Leading manufacturer of plate pressed PVC sheet offering equivalents to Darvic, Pacton and Cobex under our trade name TELBEX. We also manufacture VYNALAST™ engraving laminate. A comprehensive range of photoluminescent boards and self adhesive vinyl is available in PSPA class B and Class C to order.

### VISIONS IN PLASTICS

Unit 3, Delta Court (Robin Hood Airport), Auckley, Doncaster, DN9 3GN

Tel: 01302 775920

sales@visionsinplastics.co.uk

www.visionsinplastics.co.uk

Stocks of Mirrored Extruded Acrylic in clear, 19 colours, See-Thru, Two sided, Anti Scratch, Anti Fog, Mirrored Polycarbonate, Petg and Polystyrene. Non mirrored sheet in Acrylic, ABS, Polycarbonate, Polystyrene and PVC Foam.

## SIGN & DISPLAY SYSTEMS

### PLEX DISPLAY LTD

The Furlong, Berry Hill Industrial Estate, Droitwich, Worcestershire, WR9 9BG

Tel: 01905 798 123

sales@plexdisplay.com

www.plexdisplay.com

Established in 1994, Plex Display are hardware designers and manufacturers of Display, Café Barrier and Signage systems. We offer the trade highly competitive pricing, unrivalled stock levels and same day despatch, all backed by first class customer service and technical support. So whether you are in the exhibition, display, signage or large format printing industries we have products to suit you

### SIGNSCAPE AND SIGNCONEX LTD

Pear Tree Works, Bath Road, Upper Langford, Bristol BS40 5DJ

Tel: 01934 852 888

sales@signscape.co.uk

www.signscape.co.uk

Serving the Sign Trade for over 40 years, we are a leading manufacturer of modular sign and display systems, notice boards & other information displays. Our 6 major sign systems are used and combined, to create a wide range of sign display solutions, including full signage schemes. With all products made to order, we specialise in tailoring solutions to suit each client, location and application.

### SIGNWAVES

Lefevre Way, Gapton Hall Industrial Estate, Great Yarmouth, Norfolk NR31 0NW

Tel: 01493 419300

enquiries@signwaves.co.uk

www.signwaves.co.uk

Signwaves offers sign and display systems suitable for both internal and external use. The Adresco Café Barrier system has stylish framework components and banner materials available to mix and match. Alternatively, freestanding Modular Pole Systems with a choice of poster frames, brochure shelves and banner sets for 2 channel or 4 channel poles can create informative internal displays.

### VISTA SYSTEM LTD

103 High Street, Waltham Cross, Herts, EN8 7AN

Tel: 0800 404 9151

www.vistasystem.com

Vista System is an international pioneer and world leader in Modular Aluminium Sign Frames with distribution all over the globe. We offer a wide range of products, running the gamut from curved to flat signs, small and extra large signs, LED illuminated and Frame-less signs, innovative Brochure Holders, Illuminated Stretch Fabric signs and many more.

### I-SPI LTD

47 Mansionhouse Road, Mount Vernon, Glasgow G32 0RP

Tel: 0141 764 1600

sales@ispitrade.com

www.ispitrade.com

I-SPI Trade supplier of sign support systems. Our range includes wall mounts, cable & rod display systems, screw covers, LED lighting and much more all at THE REAL TRADE PRICE. Massive stocks and next day delivery. See our products on our web site or give Stephen or Sean a call for a brochure.

### MID WEST DISPLAYS

The Display Centre, Knights Way, Battlefield Enterprise Park, Shrewsbury SY1 3AB

Tel: 01743 465531

sales@midwestdisplays.co.uk

www.MidWestDisplays.co.uk

Mid West Displays stock a wide range of sign support systems. We also stock wall mounts, snap frames, mirror screws, cable/rod suspended systems, lighting, poster pockets and many more. We are pleased to be working with the highest quality materials at competitive prices.

### UK POS

Horsfield Way, Bredbury Park Industrial Estate, Stockport SK6 2TD

Tel: 0161 431 4400/4411

www.ukpos.com

UK Point of Sale leading manufacturers of display products Acrylic & PVC poster holders, Sign Supports, Aluminium Snap Frames, A Boards, Poster cases & Point of sale fittings.

## SIGN SURVEYOR

### PB WILLIAMS SIGN SURVEYOR

48 Durley Rd, Aintree L9 9AW

Tel: 07885 486 182

pbwilliams48@yahoo.co.uk

We specialise in sign surveying to the trade, with 30 years of experience as a sign fitter/manufacturer. I was contracted to large companies in the north west, and country wide. I am based in Merseyside and have PASMA, IPAF/PAL & CSCS qualifications and will travel UK and Europe. For further details please contact the above number or email.

## SIGN SUPPORT SYSTEMS

### E-SIGNFITTINGS HOBDAV LTD

57 Aston Brook Street East, Aston, Birmingham, B6 4RR

Tel: 0121 608 4431

sales@e-signfittings.co.uk

www.e-signfittings.co.uk

E-Signfittings are one of the largest suppliers of Sign Standoffs, Cable & Rod Display Systems in the UK. We have large stocks available on next day delivery for orders received before 3pm and are equipped to supply orders from a few pounds up to thousands of pounds. Products in our range include Screw Head Covers, Poster Hanging Systems, Sign Hanging Systems, Leaflet Holders and Poster Displays.

### SIGNSCAPE AND SIGNCONEX LTD

Pear Tree Works, Bath Road, Upper Langford, Bristol BS40 5DJ

Tel: 01934 852888

sales@signscape.co.uk

www.signscape.co.uk

Serving the Sign Trade for over 40 years, we are a leading manufacturer of modular sign systems, notice boards & information displays. Our systems create a wide range of sign solutions including; post and panel, flush panel and curved panel signs; wayfinding signs, wall directories, monolith and finger-post signs. Other products include exterior notice boards, poster/menu cases, and letter boards.

### SIGNWAVES

Lefevre Way, Gapton Hall Industrial Estate, Great Yarmouth, Norfolk NR31 0NW

Tel: 01493 419300

enquiries@signwaves.co.uk

www.signwaves.co.uk

Signwaves is a UK manufacturer of sign and display products for internal and external use. The range includes pavement signs and a-boards (including Swinger and Ecoflex signage), snapframes, poster mounting and exhibition displays. Signwaves also offer trade exclusive Stand-Off Sign Fixings and Premier A-Board Frames with low prices guaranteed.

### SYGNET SIGNS LTD

129 Humberstone Rd, Leicester, LE5 3AP

Tel: 0116 262 6288

sales@sygnetsigns.com

www.sygnetsigns.com

We manufacture most sign solutions you will ever need. Fascia's, built up letters/logos, flat cut letters/logos, laser/router cutting service, "off the shelf" or made to measure illuminated poster cases, LED illumination, powder/stove enamel coatings, 3D development in both design and manufacture. All works carried out in-house.

### THE SIGN GROUP

Victoria Works, Bruntcliffe Road, Morley, Leeds, West Yorkshire, LS27 0LF

Tel: 0113 25 24 706

info@thesigngroup.co.uk

www.thesigngroup.co.uk

We are a specialist trade manufacturer of bespoke sign systems to the signage, design, shopfitting and display industries throughout Europe. Services include: Built up letters/logos, sign trays, lightboxes, flat cut letters/logos, laser/cnc cutting, SG Light-Sheet™, LED Stockists. All inhouse, all in control.

## SIGN TRADE SUPPLIERS

### BROWNINGS LTD

157 English Street, Hull, HU3 2BT

Tel: 01482 380900

sales@browningsltd.co.uk

www.browningsltd.co.uk

Brownings is one of the largest, TRADE ONLY suppliers of signage products in the UK. We manufacture poster frames, menu cases, slimlocks, signtrim, troughlights, acrylic-faced light boxes, flexfaced signage and now our new Texsign frames for internal use. Any size or quantity, from 1 off's to multiple rollouts. We are happy to supply as lengths of extrusion, in kit form or as made-up signs.

## SOLAR POWERED SIGNS & DISPLAYS

### SIGNSCAPE AND SIGNCONEX LTD

Pear Tree Works, Bath Road, Upper Langford, Bristol BS40 5DJ

Tel: 01934 852 888

sales@signscape.co.uk

www.signscape.co.uk

An eco-friendly and long term cost effective solution, our Eco-Vision Solar Display System provides solar powered illuminated noticeboards, monoliths and stencil cut backlit signage. Powered purely by daylight, it is an ideal solution for remote and highly urban locations where illuminated information is required and where routing a mains power supply is undesirable, unpractical or costly.

## SPECIALITY FILMS

### ATC LTD

Calf Hey South, Off Well'ith Lane, Rochdale, Lancs OL11 2JS

Tel: 01706 633043

sales@apptape.co.uk

www.apptape.co.uk

Suppliers of various speciality films including Etch glass, Reflective, Fluorescent, Reflexite daybrite, Reflexite prismatic reflective, Hi intensity reflective, Photoluminescent, Cast metallics, 2yr Fluorescent, Gemstone metallics, Multi lens, Transparent colours, Checker plate, Mirror colours, Prismatic colours, Glitter colours, Brushed aluminium silver and gold.

### MACTAC UK LTD

37 Tenter Road, Moulton Park, Northampton NN3 6AX

Tel: 01604 644697

www.mactac.eu

MACTac are global manufactures of self-adhesive Speciality Films incl PVC, PET, PP, PE and more. World renowned brands include MACmark (coloured Vinyls) MACscreen, Imagen and Permacolor inkjet printable films and Protection Laminates. Also available, a diverse range of Technical Tapes and Label substrates using Speciality Films and products Class O fire-rated and CBS Outdoors (Viacom) approved.

## STONE ENGRAVING

### SOMERVILLE STONE LTD

Eastney Pumping Station, Beam house Museum, 199 Henderson Road, Southsea, Portsmouth, PO4 9JF

Tel: 08432 894 788

/ 023 9282 4457

Mob: 07711 386 023

info@somervillestone.co.uk

www.somervillestone.com

Stone Masons offering a stone engraving service. Deeply engraved lettering to your requirements on stone from all around the world, Business Signs, Property Signs.

## STREET SIGNS

### SIGNS OF THE TIMES LTD

Wingfield Road Tebworth, Beds, LU7 9QG

Tel: 01525 874 185

enquiries@sott.co.uk

www.sott.co.uk

Street signs in a variety of materials. Cast polyurethane, aluminium and bronze. Die pressed street signs for council specification. For a quotation send us the text required on your signs and specify what material is required.

## TEXTILE SIGNAGE

### BROWNINGS LTD

157 English Street, Hull, HU3 2BT

Tel: 01482 380900

sales@browningsltd.co.uk

www.browningsltd.co.uk

We manufacture poster frames, menu cases, slimlocks, signtrim, troughlights, acrylic-faced light boxes, flexfaced signage and now our new Texsign frames for internal use. Frames range from a 17mm "retro" extrusion to a 180mm deep double-sided application. The profiles can accept a digitally-printed image by way of a rubber keder attached to the edges of the print and can be changed in seconds.

### TRANSFER PAPERS/HEAT PRESSES

### THE MAGIC TOUCH

Unit 4, Apex Business Centre, Boscombe Road, Dunstable LU5 4SB

Tel: 01582 671 444

sales@themagictouch.co.uk

www.themagictouch.co.uk

Manufacturers of Transfer Papers and Materials used in conjunction with Laser Printers and Copiers (toner based) for full colour image transfer onto T-Shirts, Caps, Polo's, Mugs, Mousemats etc. Plus Magicut® film for use with Plotter/Cutter for heat transfer.

## TROUGH LIGHTING

### BROWNINGS LTD

157 English Street, Hull, HU3 2BT

Tel: 01482 380900

sales@browningsltd.co.uk

www.browningsltd.co.uk

Brownings is one of the largest, TRADE ONLY suppliers of signage products in the UK. We manufacture poster frames, menu cases, slimlocks, signtrim, troughlights, acrylic-faced light boxes, flexfaced signage and now our new Texsign frames for internal use. The troughlight comes complete with a high impact, hinged polycarbonate face. We supply in any size, colour or quantity.



## VINYL & GRAPHIC INSTALLATIONS

### MIDA SIGN SERVICES UK LTD

Welbeck Street South, Ashton-Under-Lyne OL6 7QZ  
Tel: 0161 8 300 600  
info@midasignservices.co.uk  
www.midasignservices.co.uk

Specialist applicators of all types of vinyl and graphics. Vehicle application, Windows, Wall & Floor graphics etc. Fleet specialists. Nationwide service.

## VINYL SUPPLIES

### 3M COMMERCIAL SOLUTIONS

3M House, 4th Floor, Building 8, Exchange Quay, Salford Quays, Manchester M5 3EJ  
Tel: 01344 857000

commgraphics.uk@mmm.com

www.3m.co.uk/graphicsolutions

3M are global manufacturers of a wide variety of 'Matched Component System' Warranted graphic materials: 3M Scotchcal™, 3M Controltac™ Plus, 3M Scotchlite™, 3M Diamond Grade™, 3M Light Management™ film technologies, 3M Panaflex™ flexible substrates, Comply™ Adhesive Technology, 3M DI-NOC™, Scotchprint® Graphics™ and 3M™ Envision products.

### APA (UK) LTD

Unit 10 Capital Ind. Est., Crabtree Manorway South, Belvedere, Kent, DA17 6BJ

Tel: 020 8311 4400

apauk@apaspa.com

www.apaspa.com

One of Europe's main vinyl manufacturing companies supplying own brand self-adhesive plotter vinyl and Digital Print media. Plotter vinyls from short-term up to 10 years including Truck, Cast, Vehicle Wrapping, Frost-effect, Solar, Reflective and an extensive range of Print material for UV, Solvent and Dye/Pigment inks, all application aids are available.

### ATC LTD

Calf Hey South, Off Well'ith Lane, Rochdale, Lancs OL11 2JS

Tel: 01706 633043

sales@apptape.co.uk

www.apptape.co.uk

Distributors of Ritrama UK's full range of sign-making vinyls including their complete portfolio of Digital Films. We also have available a full range of signmaking vinyls manufactured in the UK by KPMF. We stock a range of application tapes from R Tape USA and various Digital Media manufactured by LG Hausys. Discounts available on credit card payments.

### BISBELL MAGNETIC PRODUCTS LTD.

Hillfield Lane, Stretton, Burton on Trent, Staffs DE13 0BN  
Tel: 01283 531000

sales@bisbellmagnets.com

www.bisbellmagnets.com

The UK's widest range of digitally printable wide format magnetic and ferro sheet (both over 1200mm wide). Maxmag vehicle grade magnetic materials available in white, plain or adhesive backed - by roll or cut to your specific requirements. Also available neo magnets, vehicle roof magnets, sign grippers and a full range of high tape to suit every budget and application.

### DORO TAPE (UK) LTD

New Mill, Farndon Road, Market Harborough, Leics LE16 9NP

Tel: 01858 431 642

sales@dorotape.co.uk

www.dorotape.co.uk

Doro Tape provide an extensive range of vinyl from major European manufacturers such as Ritrama and Aslan. Specialist films include reflective, fluorescent, glass etch effect films, holographic films, window tints, Ritrama gemstone vinyl, vehicle wrap films, polyester mirror and brushed effect films and stencil masking films, plus a large selection of accessories.

### GREENSTIK MATERIALS LTD

Unit 9 Lancaster Road, Carnaby Industrial Estate, Carnaby, Bridlington, East Yorkshire, YO15 3QY  
Tel: 01262 602 222

sales@greenstikmaterials.co.uk

www.greenstikmaterials.co.uk

Offering a full range of Monomeric & Polymeric Sign Vinyls, Wide Format Digital Inkjet Films, Car Wrap & Interior Decoration Films, 3M Cushionmount™, Trade Slitting (Custom Slitting-Width down to 6mm in any Length available). Credit Card Facilities Available

### MACTAC UK LTD

37 Tenter Road, Moulton Park, Northampton NN3 6AX  
Tel: 01604 644697

www.mactac.eu

MACTac are a global manufacture of self-adhesive materials including Vinyls for CAD CAM plotting, Laminating or Printing using many techniques including Ink Jet, Screen and Litho. The range has products specifically designed Vehicle Wrapping, Wall, Street, Floor and Window Graphics as well as General Signage. Some products are Class O fire-rated and CBS Outdoors (formerly Via-com) approved.

### MDP SUPPLIES

Unit 3 Lumina Park, Bromborough, Wirral CH62 3PT  
Tel: 0151 272 1234

info@mdpsupplies.co.uk

www.mdpsupplies.co.uk

Distributor to sign makers and garment printers. Stocking Ritrama, KPMF, DeTape and many other leading brands. Order online at www.mdpsupplies.co.uk, by phone or at any of our 8 branches across the UK. No account needed. Last order time - 6pm for next day delivery.

### SIGN TRADE SUPPLIES LTD

Britannia House, Granville Road, Maidstone, Kent ME14 2BJ  
Tel: 01622 689 410

orders@signtradesupplies.co.uk

www.signtradesupplies.co.uk

Distributor to sign makers across the UK. Supplying a large range of sign making supplies including vinyl, digital print media and sign making tools. Receive next day AM delivery as standard when purchasing online. We stock Avery Dennison, Image Perfect, Ritrama, Oracol, 3M, Reflexite & many more.

### SYDNEY BEAUMONT (LEEDS) LTD

Sydenham Road, Domestic Street Ind. Estate, Leeds LS11 9RU  
Tel: 0113 245 8729

info@sydb.co.uk

www.selfadhesivevinyls.com

Distributors of self-adhesive vinyls since 1966. Stockists of a huge range from leading manufacturers: MACTAC, ASLAN SCHWARZ, POLITAPE, RITRAMA and INTERCOAT. As part of the Pyramid Group we can offer the full range of MACTAC cad and print vinyls along with ASLAN specialities such as 2-sided Metallised films and Memo-board films. All stock available for national next-day delivery.

## WAYFINDING SIGNS

### APPLELEC

Appleby House, Walker Terrace, Bradford, West Yorkshire BD4 7HJ  
Tel: +44 (0)1274 774477

sales@applelec.co.uk

www.applelec.co.uk

Trade suppliers of curved or flat-faced wayfinding and aluminium display systems with directories incorporating wall mounted, projecting, and totem signs. Poster display frames with a snap side profile to allow for easy interchange of inserts and an exterior light box series are available. Please ask for an information pack or contact one of our friendly and experienced sales staff for assistance.

### I.C.E.

Marcon House, Wyther Lane, Leeds LS5 3BT  
Tel: 0113 2242124

sales@icesigns.co.uk

www.icesigns.co.uk

Suppliers of internal and external wayfinding and directory systems to DDA (1995) guidelines if required.

### SIGNSCAPE AND SIGNCONEX LTD

Pear Tree Works, Bath Road, Upper Langford, Bristol BS40 5DJ  
Tel: 01934 852 888

sales@signscape.co.uk

www.signscape.co.uk

Serving the Sign Trade for over 40 years, we are a leading manufacturer of modular sign systems & information displays. We have 4 major systems for creating interior and exterior wayfinding sign solutions including; post and panel, flush panel and curved panel signs; desk, door and wall signs, wall directories, monolith and fingerpost signs. We have also offer a full graphics service if required.

### VISTA SYSTEM LTD

103 High Street, Waltham Cross, Herts, EN8 7AN  
Tel: 0800 404 9151

www.vistasystem.com

Vista System is an international pioneer and world leader in Modular Aluminum Sign Frames with distribution all over the globe. We offers a wide range of products, running the gamut from curved to flat signs, small and extra large signs, LED illuminated and Frame-less signs, innovative Brochure Holders, Illuminated Stretch Fabric signs and many more.

## WIDE FORMAT SOLUTIONS PROVIDER

### COLOURGEN

The AmBer Centre, Oldfield Road, Maidenhead, Berkshire SL6 1TH  
Tel: 01628 588722

sales@colourgen.com

www.colourgen.com

Colourgen is the UK's leading specialist distributor of large format digital colour printing solutions, consumables, bespoke software, engineering and technical support services. The Company is the exclusive UK distributor for the Mutoh Sign & Display, Speciality/Industrial, Dye Sublimation and Direct to Textile printers.

## WOODWORKING

### HALLMARK ENGRAVING

ETCHING & SIGNS LTD (EST. 1899)

116-118 Selsdon Road, South Croydon Surrey CR2 6PG  
Tel: 0208 686 6649

sales@hallmarksigns.co.uk

www.hallmarksigns.co.uk

Quality joinery for Notice Boards, Honours Boards and Bespoke Signs. Directional signs, Finger Posts and Waymarkers made in all timbers. Backboards and Plinths can be made to any shape - singles or bulk orders. Memorial bench rails, crosses and wooden signs can all be engraved with designs and lettering. Please call for a prompt quotation or to discuss any project. Please go to our website to see examples of our work.



# It means what it says

fast professional results for all your etched signage needs



## Simple and Stylish Signs

with optional wooden backing

## Large lettering or fine details

including both on the same panel



## Complex shapes no problem

engraved or laser cut to your design



## Engraving on Marble, Slate and Stone

Also full engraving service on metals and laminates



## Etching on glass panels

for a clean, modern look



## Your artwork gets straight to work

what you see is what you get

We are able to accept artwork in .EPS, .AI, Corel Draw and Signlab formats



etchFAST has 50 years' experience in Chemical Etching and Engraving



# TEL: 0208 880 2070

# FAX: 0208 880 2333

Web: [www.etchfast.com](http://www.etchfast.com)  
E-mail: [info@etchfast.com](mailto:info@etchfast.com)

Unit 5, Crusader Industrial Estate, 167 Hermitage Road LONDON N4 1LZ



# TRADE-LETTERS.COM

THE UK'S PREMIER SUPPLIER OF FLAT-CUT & METAL BUILT-UP LETTERS SINCE 1952



## THE ECO-FRIENDLY LETTER MAKERS

All our manufactured letters are now produced using 100% renewable energy



**WE WOULD VERY MUCH LIKE TO QUOTE YOU ON THE FOLLOWING PRODUCTS...**

### FLAT-CUT LETTERS

**Quoted in 10 minutes  
Delivered 2-3 days**

### BUILT-UP METAL LETTERS

**Quoted in 10 minutes  
Delivered 7-10 days**  
*Ask about our fantastic pre-fitted LEDs!*

***Manufactured in the UK by Craftsmen, not machines!***

We only use quality materials such as Perspex and Dibond together with industry standard Snapfix locators.

All our work comes with a 2 Year Workmanship Guarantee giving you 100% confidence in the sign you supply your clients

- ✓ 100% renewable energy manufacturer
- ✓ 30,000 kgs of carbon reduction per annum
- ✓ Rainbow locators - choose the colour of the cups at no extra charge 
- ✓ 100% carbon neutral delivery vehicles
- ✓ 100% CONFIDENTIAL - Trade only supplier (we do not give factory tours)
- ✓ 95% of our waste material is recycled

**CALL FREE 0800 917 6376** FAX: 0151 652 6846

**Absolutely No Charges For Using Credit Cards**



**sales@trade-letters.com**

Trade-letters.com, Rosemount, Oxton Village, Wirral, Merseyside CH43 5SN

