



[www.wacom.com](http://www.wacom.com)

# DTF-720

interactive pen display

Installation Guide & User's Manual



Wacom DTF-720 interactive pen display  
Installation Guide & User's Manual

English version 1.0, August 12, 2005

Copyright © WACOM Company, Limited, 2005

All rights reserved. No part of this manual may be reproduced except for your express personal use. Wacom reserves the right to revise this publication without obligation to provide notification of such changes. Wacom does its best to provide current and accurate information in this manual. However, Wacom reserves the right to change any specifications and product configurations at its discretion, without prior notice and without obligation to include such changes in this manual.



Watch for the Penabled logo to ensure you are getting the natural feel and superior performance of Wacom's patented cordless and battery-free pen technology.

DuoSwitch is a trademark, and Penabled and Wacom are registered trademarks of WACOM Company, Limited. Photoshop is either a registered trademark or a trademark of Adobe Systems Incorporated in the United States and/or other countries. Microsoft and Windows are either registered trademarks or trademarks of Microsoft Corporation in the United States and/or other countries. Apple, the Apple logo, and Macintosh are registered trademarks of Apple Computer, Inc., registered in the U.S. and other countries.

Any additional company and product names mentioned in this documentation may be trademarked and/or registered as trademarks. Mention of third-party products is for informational purposes only and constitutes neither an endorsement nor a recommendation. Wacom assumes no responsibility with regard to the performance or use of these products.

# INTRODUCTION AND OVERVIEW

The Wacom® DTF-720 interactive pen display combines the benefits of an LCD monitor with the control, comfort, and productivity of Wacom's cordless, battery-free pen technology. This gives you a direct pen-on-screen interface that can be used with a Personal Computer (PC) or Macintosh® computer.

The basic components of the DTF-720 include a Wacom pen tablet internally mounted behind a 17.0" diagonal TFT color LCD monitor, and a cordless, battery-free Wacom pen.

The DTF-720 also comes equipped with a VGA pass-thru (RGB-OUT) port, enabling you to simultaneously connect a VGA monitor or projector to the pen display.

This manual describes how to install the DTF-720 hardware and software. It also describes how to use the DTF-720 and pen. The information is common to both platforms, and Windows screen captures are shown unless otherwise noted. **Please follow all instructions carefully.**

**Note that the computer treats the DTF-720 as two separate devices (the LCD monitor and the pen tablet).** Therefore, the installation process is completed in two stages:

- First install the DTF-720 as a display.
- Then install the DTF-720 as a pen tablet.

Both stages require hardware and software installations and adjustments. **Please follow all instructions carefully.**

The following kinds of information are not included with this product: information about your specific computer hardware or operating system, or information about your application software. Your best source for this information is the set of manuals and disks that came with your hardware, operating system, or application.

Refer to *Unpacking your DTF-720* on page 6 when removing the DTF-720 from the box.

For information on using the Tablet control panel for customizing your pen display tablet and pen settings, see *Customizing* on page 18.

To use the pressure-sensitivity of the pen with your favorite drawing application, refer to instructions in that application's manuals.

# PRECAUTIONS ON USE AND HANDLING

Be sure to follow all instructions, cautions, and warnings found within this manual. Failure to do so could cause the loss of data or damage to your computer. Failure to do so could also void your warranty, in which case Wacom shall have no responsibility to repair or replace the product.

## Physical location



### WARNING

**Do not use the DTF-720 interactive pen display in a facility control system that requires extremely high reliability;** it may cause other electronic devices to malfunction, or other devices may cause the pen display tablet to malfunction. Where use is prohibited, power off the DTF-720 to prevent the possibility of it causing other electronic devices to malfunction. Wacom does not accept any liability for direct or consequential damages. For details, please refer to your Warranty located at the end of this manual.

## Environment

### Temperature and humidity

- Operating temperature and humidity: 5° to 35°C, 20 to 80% RH
- Storage temperature and humidity: -10° to 60°C, 20 to 90% RH



### CAUTION

**Do not use or store the DTF-720 where:**

- Temperature changes are severe or exceed specifications (e.g., outdoors or inside a vehicle).
- The DTF-720 and pen are exposed to direct sunlight or heat from an appliance, or are exposed to water or any other kind of liquid.



### CAUTION

**Do not use the DTF-720 in a dusty environment;** this may damage the unit.

## Usage



### WARNING

**Only use the power adapter that came with the DTF-720.** If a different type of power adapter is used, the DTF-720 will not work properly or may be damaged. **Using a different type of power adapter also has the potential to result in fire.** Use of a different power adapter will void your warranty.



### CAUTION

**Be sure to use a grounded power source when applying power to the DTF-720.**



### CAUTION

**Do not connect or disconnect the video or power cables while the DTF-720 or your computer are turned on;** this may damage the LCD monitor or computer video card. In this case, Wacom shall have no responsibility to repair or replace the product.



### CAUTION

**This product is for use with a VGA video card;** using an inappropriate video card may damage the DTF-720.



### CAUTION

**Do not block the rear panel ventilation holes;** this may overheat and damage the unit.

**When not using the DTF-720 for long periods of time, unplug the power adapter from the AC outlet.**

# Handling



**WARNING**

**High Voltage. Do not open or disassemble the DTF-720 interactive pen display. There is a risk of electrical shock when the casing is open.** This will also void your warranty and Wacom shall have no responsibility to repair or replace the product.



**WARNING**

**If the LCD screen has been damaged, DO NOT touch any liquid that may be leaking from it;** this liquid is an irritant. In case of contact with skin, eyes, or mouth, rinse immediately with running water for at least 15 minutes or more. If contact is made with the eyes or mouth, also consult a physician.



**WARNING**



**– LAMP(S) INSIDE THIS PRODUCT CONTAIN MERCURY AND MUST BE RECYCLED OR DISPOSED OF ACCORDING TO LOCAL, STATE OR FEDERAL LAWS.**

**The DTF-720 interactive pen display has a backlight which contains mercury (Hg).** Be sure to dispose of properly, and to manage any disposal of this unit in accordance with your local ordinances and laws.



**WARNING**

**Prevent children from swallowing the pen tip or side switch.** The pen tip or side switch may accidentally be pulled out if children are biting on them.



**CAUTION**

**Do not disassemble the pen.** This may cause the device to malfunction. In this case, Wacom shall have no responsibility to repair or replace the product.



**CAUTION**

**Do not scratch the display screen.** Avoid placing sharp objects on the display screen surface.



**CAUTION**

**When adjusting the tilt angle of the DTF-720, be careful to avoid catching your finger in the gap of the movable portion of the stand.**



**CAUTION**

**Do not lift the DTF-720 by the stand; this may damage the stand mechanism.** When lifting or moving the DTF-720, always do so by grasping the main body casing.



**CAUTION**

**Avoid intensive shock or vibration to the DTF-720 or the pen.** Hitting or dropping the DTF-720 may damage the display screen or other components.



**CAUTION**

**Do not put heavy articles on the pen display tablet or push against it with a strong force;** this may damage the display screen or bend the stand.



**CAUTION**

**Do not place heavy articles on the DTF-720 cabling, repeatedly bend the cables sharply, or apply heavy stress to the cable connectors;** this may damage the unit or cabling.



**CAUTION**

**If the pen tip becomes sharp or angular, it may damage the coating on the display screen.** Please replace the pen tip if necessary.



**CAUTION**

**Do not use any organic solvent (e.g., alcohol) or even mild detergent to clean the display screen. Use of these cleaners can damage the coating on the screen. Please note that damage of this kind is not covered by the manufacturer's warranty.**

- To clean the display screen, use an anti-static cloth or a slightly damp cloth. When cleaning, apply only a light amount of pressure to the display screen and do not make the surface wet.
- To clean the DTF-720 casing or pen, use a soft cloth with mild detergent (such as dish washing liquid) diluted with water.



**Reuse, recycling, and recovery.** You are urged to recycle this product when replacing it with a newer product or when it has outlived its useful life by bringing it to an appropriate collection point for recyclable materials in your community or region. By doing this, you can help improve the environment of your community as well as minimize the potential negative effects created should any hazardous substance that may possibly be present within waste material reach the environment during the disposal process.

Within the European Union, users are required not to dispose of Waste Electrical and Electronic Equipment (WEEE) as unsorted municipal waste, according to the Directive 2002/96/EC of the European Parliament and of the Council of 27 January 2003, or the corresponding local laws of the Member States. Products for which this is applicable will be marked with the WEEE symbol shown at the beginning of this note unless this is not feasible because of the size or the function of the product. Wacom products are subject to the Directive 2002/96/EC and therefore you should always collect them separately and bring them to the appropriate collection point in your community or region.

# CONTENTS

Introduction and overview .....	1
Precautions on use and handling .....	2
Physical location .....	2
Environment .....	2
Usage .....	2
Handling .....	3
Unpacking your DTF-720 .....	6
Package contents .....	6
Interactive pen display components .....	7
Front view .....	7
Rear view .....	8
Installation .....	9
System requirements .....	9
Step 1: LCD monitor installation .....	10
Step 2: Pen tablet installation .....	13
Working with your DTF-720 .....	15
Setting up your work area .....	15
Using the pen .....	16
Pen operations .....	17
Customizing .....	18
Opening the control panel .....	18
Control panel overview .....	19
Control panel details .....	21
Adjusting the LCD monitor .....	24
Troubleshooting .....	29
Testing the DTF-720 .....	29
Display troubleshooting .....	31
Pen tablet troubleshooting .....	33
Technical support options .....	38
Obtaining driver downloads .....	39
Appendix .....	40
Caring for the DTF-720 .....	40
Using an alternate mount or stand .....	41
Uninstalling the DTF-720 .....	42
Product specifications .....	43
Purchasing parts and accessories .....	44
Radio and television interference .....	45
Warranty .....	46

# UNPACKING YOUR DTF-720

## Package contents

Your product came with the following items:

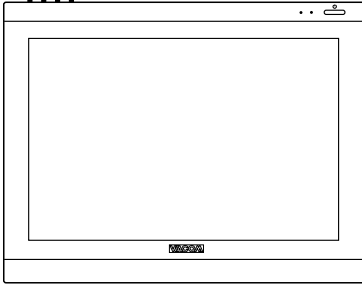

DTF-720 interactive pen display, main unit

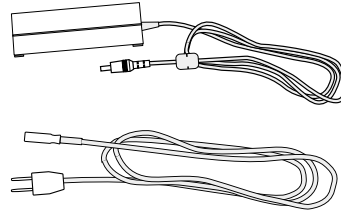

Power adapter (POW-A097-01)  
and  
Power cable (SCD-A039-01)

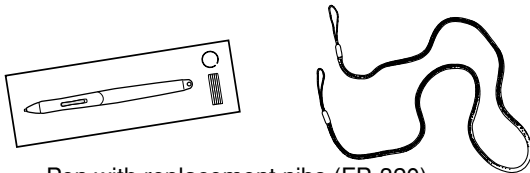

Pen with replacement nibs (FP-320)  
and  
Pen tether (PKB-A016)

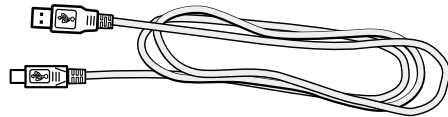

USB cable (STJ-A250)



Installation Guide & User's Manual  
(This manual.)

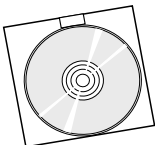

Wacom Pen Tablet Driver CD  
(Contains the driver software.)

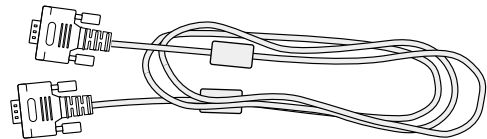

VGA to VGA cable (STJ-A228)

**Notes:** Images are not shown to scale. Some product configurations may come with different pens having no side switches. Some configurations may include additional CDs containing application software. To install these applications, review the instructions that came with those CDs. Retain the package box for use when storing or shipping the DTF-720.

**Next Step:** Familiarize yourself with the *Interactive pen display components*. See page 7.



# INTERACTIVE PEN DISPLAY COMPONENTS

The LCD monitor and tablet sensor function as an integrated input and output device. The LCD monitor supports resolutions up to 1280 x 1024 pixels at 16.2 million colors. The tablet sensor reports pen coordinates, pressure, and switch information.

## Front view

### On Screen Display (OSD) controls

These controls, located on the upper edge of the tablet, enable you to adjust a variety of display settings. See *Adjusting the LCD monitor* on page 24 for more information.

### Power LED

Lights blue when power has been supplied to the DTF-720 and a video signal is present.

Glows orange when no video signal is detected by the DTF-720. (e.g., Your computer is turned off, starting up, or has entered a power management mode in which video signals are not sent.)

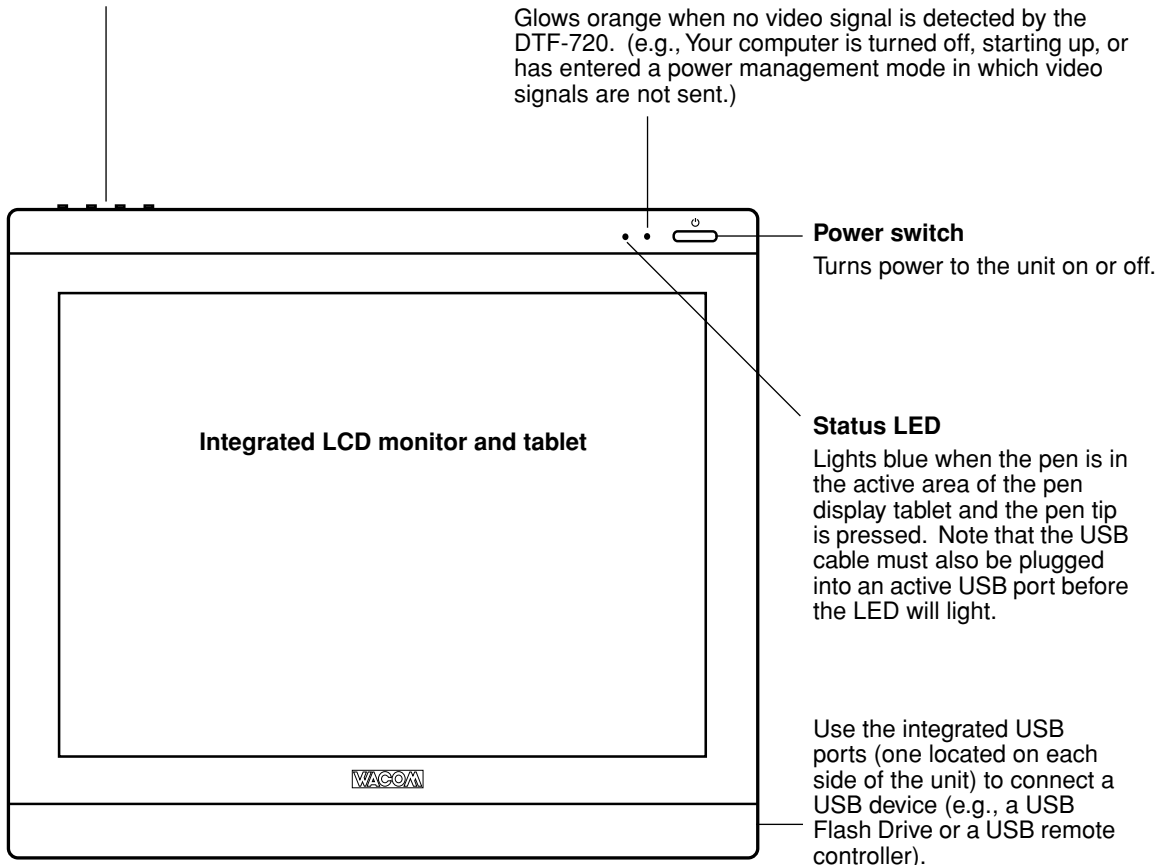

Be sure to fully install the DTF-720 hardware and software before connecting any other devices to the unit.

## Rear view

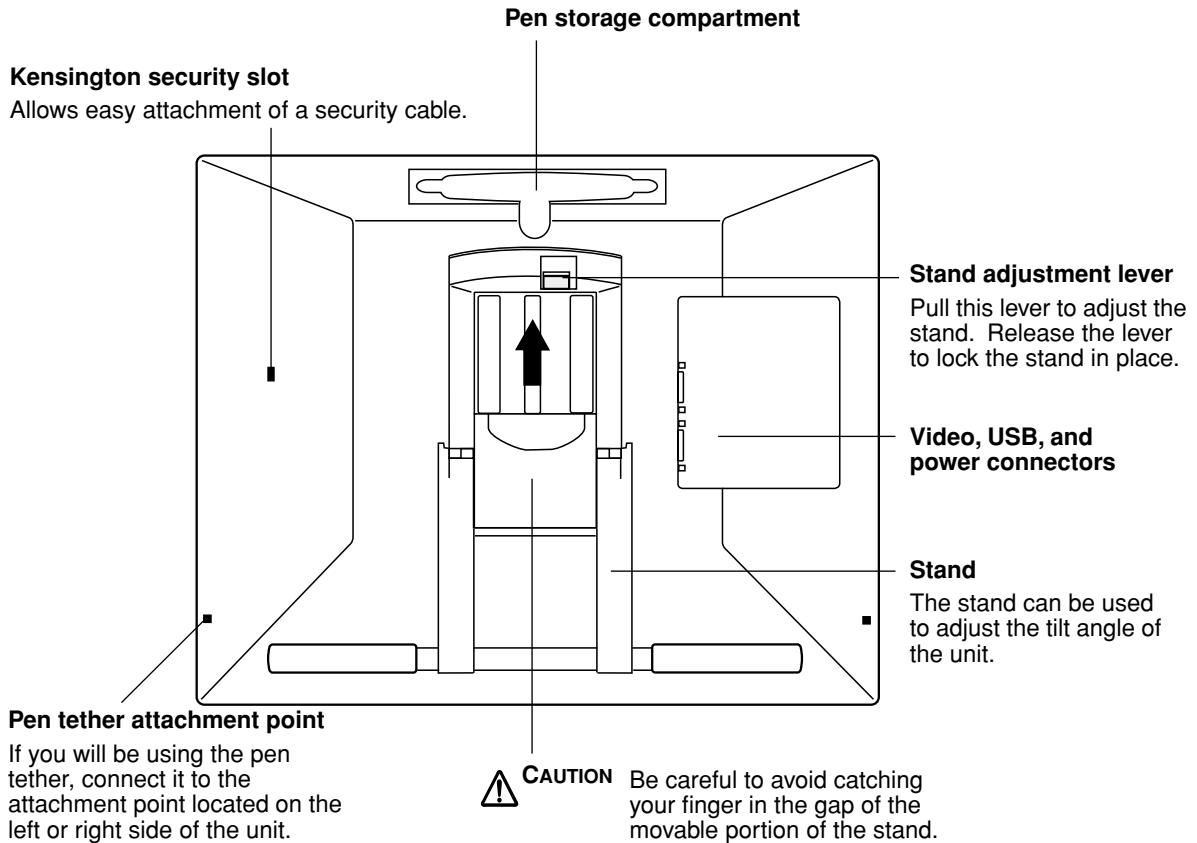

**Important:** Be sure to adjust the stand to the low tilt position before packaging the DTF-720. If you do not close the stand, the notched mechanism may be damaged during transportation and storage. Do not lift the unit by the stand; this may damage the stand mechanism. When lifting or moving the DTF-720, always do so by grasping the main body casing.

**Next Step:** *Installation.* See page 9.

# INSTALLATION

## **System requirements**

Before installing the DTF-720, make sure your computer meets the following system requirements:

- **PC.** Windows XP, XP x64, 2000, Me, or 98SE. VGA video connector, available USB port, and CD-ROM drive.
- **Macintosh.** OS X, v10.2.8 or greater. VGA video connector, available USB port, and CD-ROM drive.

**Note:** The DTF-720 can be used alone or with another display. You may connect a second VGA device such as a monitor or LCD projector to the DTF-720 RGB-OUT port. When using this port, the second device will mirror the image on the DTF-720. Complete the DTF-720 installation before connecting a projection device to the unit.

Depending on the capabilities of your video card and operating system, you may be able to set up the DTF-720 as a mirrored, extended, or independent display. Refer to your video card documentation for more information on its capabilities.

When you are working with more than one monitor, the DTF-720 will map to the monitors based upon how your system is configured. By default, if you are in mirror mode, the pen tablet will map to the entire space on each display or monitor. Please refer to your hardware and operating system documentation for details on configuring your computer and operating system for use with multiple monitors.

**There are two primary steps to the installation process:**

- **Step 1: LCD monitor installation**
- **Step 2: Pen tablet installation**

**Be sure to follow ALL instructions carefully.**

## Step 1: LCD monitor installation

In the first stage of the installation process, the DTF-720 is installed as a monitor on your system. As you work through the first stage of the installation process, please refer to the *LCD monitor cabling diagram* on the following page when making cable connections.

**Important:** Do not connect the USB data cable until instructed to do so.

- Turn off your computer.

**Caution:** Never connect or disconnect the video or power cables while your computer or DTF-720 are powered on – this can damage the LCD monitor or video card.

- If your computer has only one analog (VGA) video connector, you will need to unplug your previous monitor or add a second VGA card.
- Plug one end of the VGA cable into the DTF-720. Plug the other end of the cable into the VGA connector on your computer's video card. See – **A** – in the connection diagram on page 11.

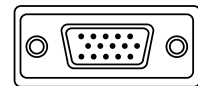

**VGA connector**

- Be sure to tighten the thumbscrews on the connectors.
- Connect the power adapter to the DTF-720. See – **B** – on the next page. Then connect the adapter's power cable and plug the adapter into an AC outlet. See – **C** –.

## LCD monitor cabling diagram

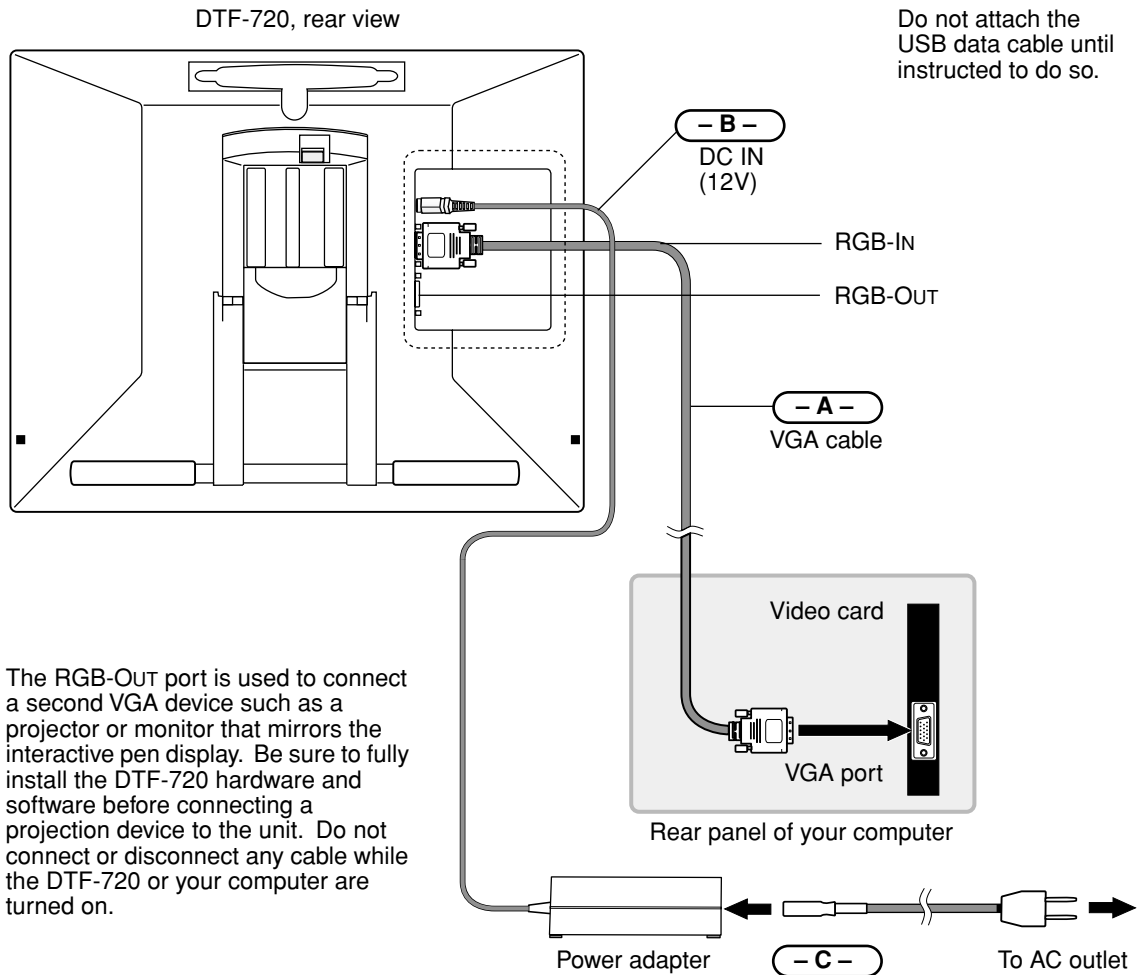

**CAUTION** Use only the power adapter that came with the DTF-720; use of an improper power adapter may damage the unit.

**Do not connect or disconnect the video or power cables while the DTF-720 or your computer are turned on – this can damage the LCD monitor or computer video card.**

**Make sure that the display refresh rate does not exceed 75 Hz.**

- Turn on the DTF-720. The power LED will light orange.
- Next, turn on your computer.  
Windows XP, XP x64, and 2000: The DTF-720 will automatically install as a default monitor.  
Windows 98SE and Me: The NEW HARDWARE WIZARD will display. Follow the prompts selecting the default options and install the DTF-720 as a default VGA monitor.
- As necessary, configure the display control panel settings for the proper size and color resolution. The maximum (native) resolution of the DTF-720 is 1280 x 1024 pixels. The display size and color resolution may be constrained by the capabilities of your video card. See the video card manufacturer's documentation for details.  
To fine-tune the display, please refer to *Adjusting the LCD monitor*, beginning on page 24 for more information.  
Windows: If you are using the DTF-720 as a secondary display, you may first need to enable the DTF-720 in your Display Properties control panel.
- After the LCD monitor portion of the DTF-720 is working to your satisfaction, move on to the next section (*Step 2: Pen tablet installation*) to install the pen tablet portion of the DTF-720.  
For troubleshooting tips, please refer to page 29.

#### **Notes:**

Each DTF-720 LCD panel is produced under very stringent quality standards. Production techniques cannot guarantee an absolutely perfect TFT display, and some panels may exhibit a certain number of pixels that show an incorrect color. Refer to the specifications on page 43 for more information.

If an image has fine striping (such as screen stripes), it may appear to flicker or display a moiré pattern.

Do not apply excessive pressure on the display surface, it may cause the appearance of a moiré or pooling pattern. If you notice this action, use less pressure on the display screen when working with the pen.

When a still image is displayed for a long period of time, an after-image may remain for a short time. To prevent this, Wacom recommends using a screen saver or other power management feature.

## Step 2: Pen tablet installation

### USB cable installation

Plug the square end of the USB cable into the DTF-720 port labeled USB. Plug the other end into an available USB port on your computer or on a USB hub attached to your computer. See **- D -** in the connection diagram below.

**Note:** For Windows 98SE, the ADD NEW HARDWARE WIZARD will display. Follow the prompts, selecting the default options. If prompted to install drivers for the USB Human Interface Device, insert the Windows 98SE CD, click OK, and enter the location of the Windows CAB files (e.g., D:\WIN98).

### Pen tablet cabling diagram

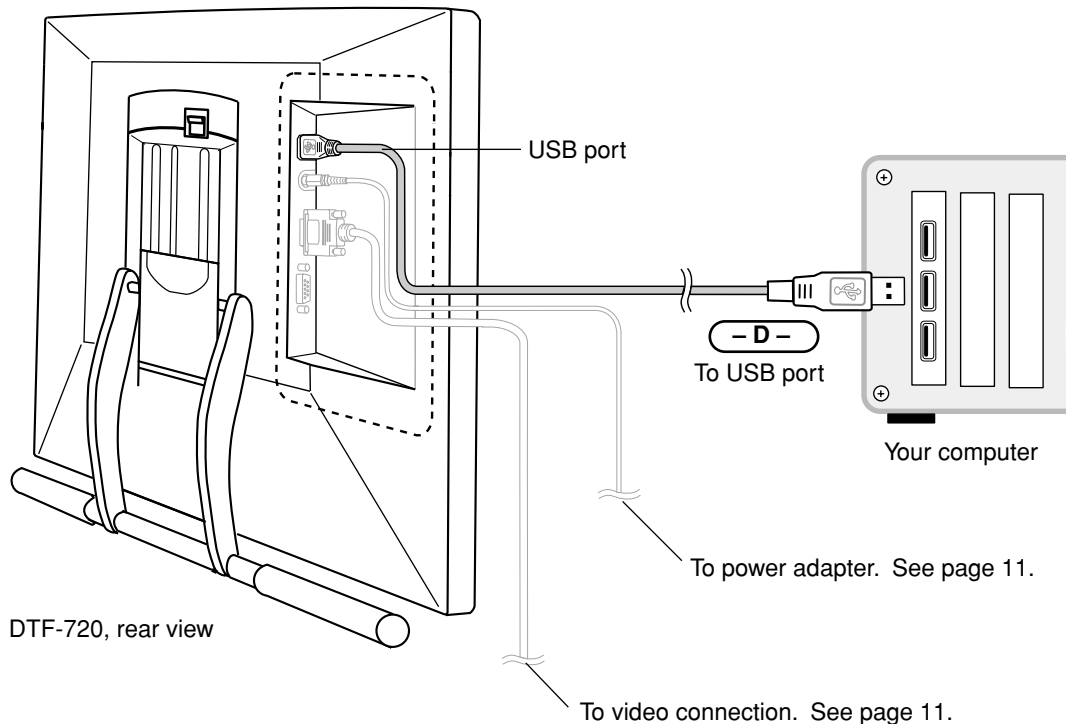

Next, move on to the pen tablet *Software installation* on page 14. You must install the Wacom tablet driver software for full tablet functionality.

## Software installation

To install the tablet software:

- Save your work and close all open applications before installing the tablet software. Temporarily disable any virus protection programs.
- Insert the Wacom Pen Tablet Driver CD into your computer's CD-ROM drive. The software installer menu should automatically display. If you are running Macintosh OS X or the menu does not display, double-click on the INSTALL icon located on the CD.
- Click on the INSTALL TABLET link and follow the prompts to install the driver software.
- Re-enable your virus protection program.
- After the software installation has been completed, make sure you can use your pen on the DTF-720 display to move the screen cursor.

When you place the pen tip on the display screen, the screen cursor should immediately jump to a corresponding position approximately beneath the pen tip. Lift the pen tip and place it on the display screen surface in a different location – the screen cursor should again jump to the new position. This is known as absolute positioning, and enables you to position the screen cursor without having to drag your pen across the display screen surface. To fine-tune the cursor-to-pen relationship, see *Calibrating the DTF-720* on page 20.

Be sure to check the Read Me file for late-breaking news. If you have trouble installing the DTF-720, see the *Troubleshooting* section beginning on page 29 of this manual.

### Next Steps:

Be sure to adjust the pen display tablet calibration to precisely align the screen cursor position with the location of the pen tip. See *Calibrating the DTF-720* on page 20.

To learn more about using the DTF-720, proceed to *Working with your DTF-720* on page 15.



# WORKING WITH YOUR DTF-720

As you work with the DTF-720 interactive pen display you can rest your hand lightly on the display screen, just as if it were a drawing board or sheet of paper.

- Because the DTF-720 drawing surface will be a little higher than your desk, consider adjusting the height of your desk or chair to assure comfortable use of the device.
- When working with the DTF-720, maintain a good posture at all times and change your position if you feel any discomfort due to your work position.
- Be careful that you do not pull the cables out of their connections by accidentally moving the DTF-720 too far from the computer.

## **Setting up your work area**

To minimize fatigue, organize your work area so you can work comfortably. Position the DTF-720, the pen, and your keyboard so they are easily accessible without unnecessary reaching. The pen display and any other monitors should be positioned so you can view them comfortably with a minimum of eyestrain.

Here are some other points to keep in mind:

- Take short breaks between tasks to stretch and relax your muscles.
- Use a gentle grip when working with the pen.
- Alternate tasks throughout the day.
- Minimize awkward postures and repetitive movements that cause discomfort.
- Alternate between different modes of use.
- Set the DTF-720 pen display tablet on a flat surface when not using it in a hand-held or lap position.

**Note:** Wacom makes no representation, promise or guarantee that Wacom products will cure or prevent, in whole or in part, mouse-induced repetitive stress symptoms, injuries or conditions. Individual results may vary. Always obtain competent medical advice to determine the most appropriate treatment for your specific situation.

The pen tether can be used to ensure your pen stays with your pen display tablet. Simply loop one end of the tether through the tether hole located on the pen, and the other end of the tether through the tether connection point located on the left or right side of the tablet.

**Next Step:** If you have not already done so, learn about the basics of customizing the pen. See *Pen operations* on page 17 and *Customizing* on page 18.

## Using the pen

As you work with the DTF-720 you can rest your hand lightly on the display screen, just as if it were a drawing board or sheet of paper. The Wacom pen is cordless, battery-free, and sensitive to the pressure you exert upon it. Hold the pen like you would a normal pen or pencil. Make sure the DuoSwitch is in a convenient location where you can toggle it with your thumb or forefinger, but not accidentally press it while drawing. You can tilt the pen in any way that feels most comfortable for drawing.

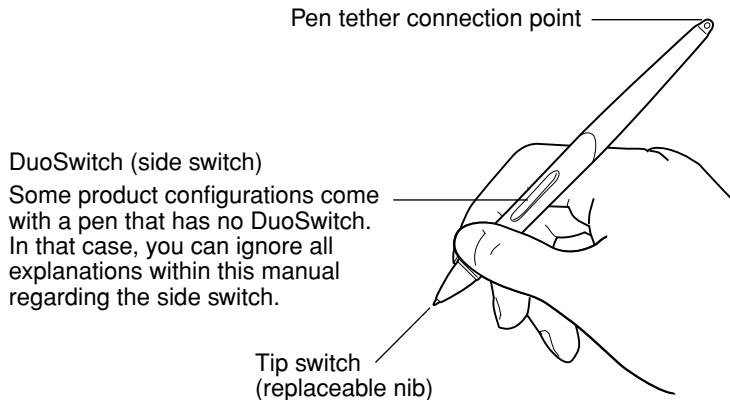

**Note:** When the pen is not in use, place it in the pen storage compartment or lay it flat on your desk. To maintain the sensitivity of your pen, do not store the pen in a container where it will rest on its tip.

DuoSwitch (side switch)  
Some product configurations come with a pen that has no DuoSwitch. In that case, you can ignore all explanations within this manual regarding the side switch.

Tip switch  
(replaceable nib)

## Pen components

The components of your pen function in the following manner:

**Pen tip:** The pen becomes activated as soon as it is brought within 5 mm (0.2 inch) of the pen display tablet screen. This allows you to position the screen cursor or use the DuoSwitch without touching the pen tip to the display screen. When pressure is applied to the pen tip, the tip switch is turned on and the pen simulates a primary mouse button click. The tip click pressure can be adjusted in the Tablet control panel.

**DuoSwitch:** The DuoSwitch is programmable, and can be used to perform the same click and double-click functions as the tip switch. Toggle the DuoSwitch in either direction to activate the upper or lower button functions. You can use the DuoSwitch whenever the pen tip is within 5 mm (0.2 inch) of the tablet surface; you do not need to touch the pen tip to the tablet in order to use the switch. By default, the upper switch is set to DOUBLE CLICK and the lower switch is set to RIGHT CLICK.

**Important:** Use only the pen that came with your DTF-720 interactive pen display. Other pens may not function properly. Also, the DTF-720 pen tip is specifically designed for use with the DTF-720 interactive pen display – the tips on other pens could damage the protective coating on the DTF-720 display screen.

See *Customizing the pen* on page 19 for information on customizing the pen settings.

## Pen operations

The basic methods of working with the pen are as follows:

**Pointing and selecting:** Move the pen above the DTF-720 display screen to position the screen cursor. The pen tip needs to be within 5 mm (0.2 inch) of the pen display tablet surface; you do not need to touch the tablet surface to move the screen cursor. The cursor jumps to the location where you place the pen (absolute positioning). Press the pen tip on the display screen to make a selection.

**Note:** You will need to calibrate the pen display tablet to correctly align the screen cursor with the pen tip. (See *Calibrating the DTF-720* on page 20.) If the screen cursor does not jump to a position close to the pen tip when you place the pen on the display screen, then the pen tablet driver may not be installed or is not loading. Install the pen tablet driver software if necessary. Otherwise, refer to *Troubleshooting*, beginning on page 29.

**Clicking:** Tap the display screen once with the pen tip, or touch the pen to the display screen with enough pressure to register a click.

**Tip:** You can make navigating with the pen easier by configuring Windows to select when the pen is over an icon and to launch the icon with a single click. To turn on this feature:

Windows XP, XP x64, 2000, or Me. Open a folder, select the TOOLS pull-down menu, and FOLDER OPTIONS.... From the GENERAL tab select the option SINGLE-CLICK TO OPEN AN ITEM (POINT TO SELECT).

Windows 98SE. Open a folder, select the VIEW pull-down menu, and FOLDER OPTIONS.... From the GENERAL tab select the WEB STYLE option.

**Double-clicking:** Press the upper side switch, or quickly tap the display screen twice in the same place with the pen tip. Double-clicking is easier when the pen is perpendicular to the tablet screen. To fine-tune the double-click area, see *Adjusting double-click* on page 21.

**Dragging:** Select an object, then slide the pen tip across the display screen to move the object.

**Using the side switch:** The pen is equipped with a DuoSwitch. This switch has two programmable functions that can be selected by rocking the switch in either direction. You can use the DuoSwitch whenever the pen tip is within 5 mm (0.2 inch) of the tablet surface; you do not need to touch the pen tip to the tablet in order to use the switch. The upper switch is set to DOUBLE CLICK, and the lower switch is set to RIGHT CLICK by default.

**Drawing with pressure-sensitivity:** The pen responds to the nuance and inflection of your hand movements, enabling you to create natural-looking pen and brush strokes within applications that support this feature. To draw with pressure, select a pressure-sensitive tool from your application's tool palette. As you draw on the screen surface, use various amounts of downward pressure on the tip of the pen. Press lightly for thin lines or softer color. Press harder for thick lines or dense color.

# CUSTOMIZING

After you master the basics of using your pen on the DTF-720 interactive pen display, you may want to customize the way the pen works. The Tablet control panel makes it easy to customize the DTF-720 and pen.

## **Opening the control panel**

To open the control panel, use the DTF-720 pen on the pen display tablet:

**Windows.** Click on the Windows START button and choose ALL PROGRAMS. (For versions other than Windows XP, choose the PROGRAMS group.) Then select TABLET PROPERTIES and choose the TABLET PROPERTIES option.

**Macintosh.** Open SYSTEM PREFERENCES from either the Dock, the Apple menu, or from the APPLICATIONS folder. Then click on the TABLET icon.

**Note:** If more than one pen display tablet is installed on your system, the control panel will change the settings for the tablet that was last used before opening the control panel.

After opening the control panel, see *Control panel overview* on page 19.

## Control panel overview

Open the Tablet control panel to customize your product. Experiment with different settings to find what works best for you. Any changes you make will take effect immediately, but you can always click DEFAULT to return to the factory settings.

Additionally, your keyboard tab and arrow keys can be used to navigate the control panel.

## Customizing the pen

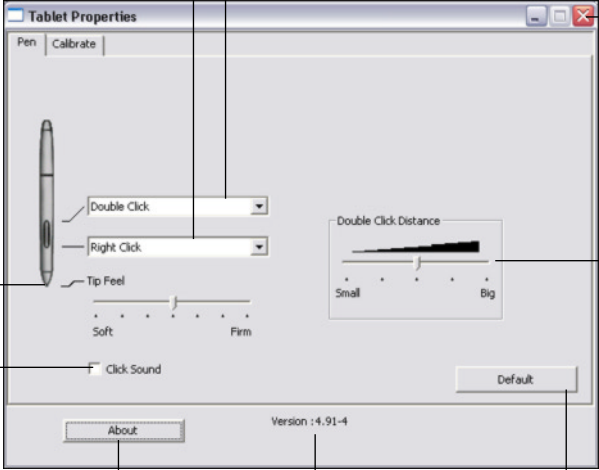

The image shows a screenshot of the 'Tablet Properties' control panel window. The window has a title bar with 'Tablet Properties' and standard window controls. Below the title bar are two tabs: 'Pen' and 'Calibrate'. The 'Pen' tab is active, showing a list of pen settings. On the left, there is a small image of a pen. The settings include: 'Double Click' (a dropdown menu), 'Right Click' (a dropdown menu), 'Tip Feel' (a slider from 'Soft' to 'Firm'), and 'Click Sound' (a checkbox). On the right, there is a 'Double Click Distance' slider from 'Small' to 'Big' with a visual representation of the click area. At the bottom, there are 'About' and 'Default' buttons, and the text 'Version : 4.91-4'. Several lines with text annotations point to various parts of the interface.

Selects the pen side switch button functions. See page 21.

Closes the control panel.

**Tip Feel.**  
Customizes the amount of pressure needed to click or draw with the pen.

Adjusts the size of the double-click area. See page 21.

When checked, an audible “click” sound will be heard whenever a pen click occurs and your computer speakers are turned on.

Displays information about the control panel and driver.

Software driver version.

Returns the PEN tab settings to their factory defaults.

**Hint:** To create broad brush strokes or to click with a light touch, use a soft tip setting. A soft setting provides a wider range of pressure values with most pressure-sensitive applications. In some applications, a soft pressure setting can make the pen overreact – any small press on the pen is magnified on the screen. If you experience this, try a firmer tip setting.

If more than one pen display tablet is installed on your system, the control panel will change the settings for the tablet that was last used before opening the control panel.

**Note:** When customizing your pen, choose those options that match the buttons on the pen you are working with.

## Calibrating the DTF-720

You will need to calibrate the pen display tablet in order to align the screen cursor position with the position of the pen on the display screen. This is required to adjust for parallax caused by the display screen cover glass and coating. Set the DTF-720 in its working position, then follow the procedure below.

**Important:** Make sure the LCD monitor is properly adjusted before calibrating the tablet. See *Adjusting pitch and phase* on page 27, and *Adjusting the LCD monitor* beginning on page 24.

- In the Tablet control panel, select the CALIBRATE tab.
- If you are working with multiple monitors, select the MONITOR corresponding to the DTF-720 display. (Only monitors that are set to one of the resolutions supported by the DTF-720 will appear in the list.)
- Click on the CALIBRATE button to activate the calibration screen.
- Holding the pen and positioning your head as you normally do when working with the tablet, use the pen tip to click on the center of the cross-hairs in the upper-left corner.
- Then click on the center of the cross-hairs that are displayed in the lower-right corner.
- Test the alignment by positioning the pen at a few different points on the display. Click OK to accept the calibration. Click TRY AGAIN to recalibrate.

Be sure to read the directions in the calibration screen for detailed instructions and additional options. The calibration setting applies to all applications.

Adjustment pattern for pitch and phase.  
See *Adjusting pitch and phase* on page 27 for details.

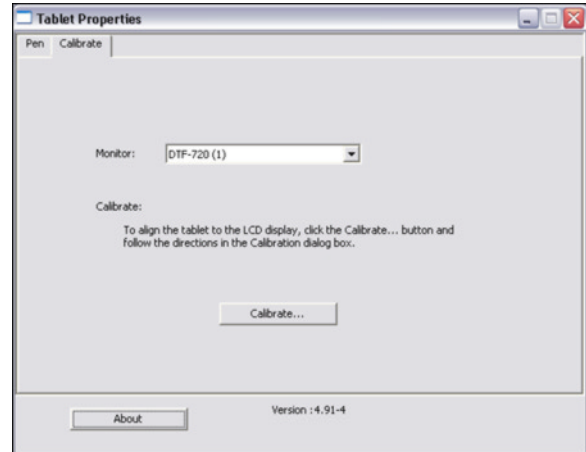

### Cross-hairs



**Note:** If more than one pen display tablet is installed on your system, the control panel will change the settings for the tablet that was last used before opening the control panel.

To calibrate two pen display tablets, first touch the pen to tablet #1 and open the control panel without touching the pen to tablet #2. In the control panel, select the correct monitor and calibrate tablet #1. Close the control panel, touch the pen to tablet #2, and again open the control panel without touching the pen to tablet #1. Select the correct monitor and calibrate tablet #2.

## Control panel details

### Adjusting double-click

Double-clicking with the pen tip can be made easier by expanding the tap area that accepts a double-click (the double-click distance), or by using the pen's side switch to automatically double-click when pressed. A large double-click distance may cause a delay at the beginning of your brushstrokes in some drawing applications. If you notice such effects, try setting a smaller double-click distance and using the side switch to double-click.

**Hint:** Press the upper switch to double-click. This is easier than tapping twice with the pen tip.

### Customizing the side switch button functions

You can set the pen's DuoSwitch to simulate a variety of functions. Just select an option from the pull-down menu for either the upper or lower side switch. Your changes take effect immediately. When you bring the pen tip within 5 mm (0.2 inch) of the pen display tablet surface without touching the tablet and press the side switch, the selected function occurs. The following list describes the available options.

**CLICK.** Default setting for the pen tip. This option simulates a primary mouse button click.

**DOUBLE CLICK.** Default setting for the upper position of the side switch. Simulates a primary mouse button double-click. For easier double-clicking, use this function instead of tapping twice with your pen tip.

**MIDDLE CLICK.** Simulates a middle mouse button click.

**RIGHT CLICK.** This is the default setting for the lower position of the side switch. Displays a context menu (simulates a right mouse button click on Windows systems and CTRL+CLICK on Macintosh).

**CLICK LOCK.** Simulates holding down the primary mouse button. Press the side switch once to initiate click lock. Press the switch again to release click lock. Click lock is useful for dragging objects or selecting blocks of text.

**4TH CLICK (FORWARD).** Issues the FORWARD command in browser applications (simulates a 4th mouse button click).

**5TH CLICK (BACK).** Issues the BACK command in browser applications (simulates a 5th mouse button click).

**DEFAULT.** Returns a button to its default setting.

**DISABLED.** Disables the button function.

**APPLICATION DEFINED.** Allows the application to determine the button function. Use this for applications such as CAD programs that have built-in button support.

**ERASE.** Sets a button so that when the button is pressed, the pen tip will act like an eraser in applications that support the ERASE function.

**INK TOGGLE.** (Macintosh.) Toggles the Ink ANYWHERE function of Inkwell on and off. Inkwell automatically recognizes and converts your handwriting into text and inserts it into a document. Note that Ink must be turned on for this button function to work. See your Macintosh help for information on working with Inkwell.

**KEYSTROKE....** Enables you to simulate keystrokes. Selecting this option displays the DEFINE KEYSTROKE dialog box where you can enter a keystroke or keystroke sequence to play back at the press of a button.

You can manually enter a keystroke or keystroke combination in the KEYS entry box. Keystroke combinations can include letters, numbers, function keys (such as F3) and modifier keys (such as SHIFT or CTRL).

You can also select special keystrokes or keystroke combinations from the ADD SPECIAL drop-down menu. When you make a selection it is added to the KEYS entry box.

After defining a keystroke sequence, click OK.

**Important:** Because the ENTER (Windows) and RETURN (Macintosh) keys can be selected as a defined keystroke, they cannot be used to select OK. You must use your pen to click on the OK button.

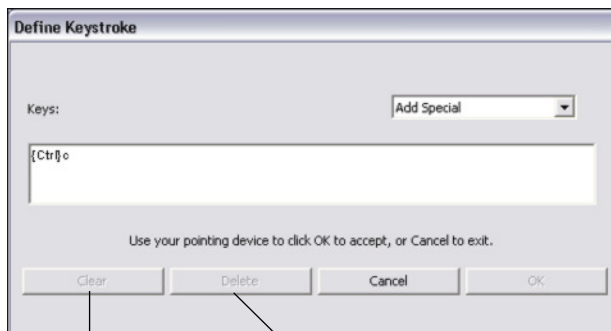

Clears the keystroke entry box.

Deletes only the last entry in the keystroke entry box.

**MODIFIER....** Enables you to assign modifier key(s) (such as SHIFT or CTRL). Many applications use modifier keys to constrain the size or placement of objects. Selecting this option displays the SELECT MODIFIER(S) dialog box where you can assign one or more modifier key functions. After choosing the modifier function(s), click OK.

In addition to choosing one or more modifier key options, you can select the CLICK box if you want a mouse click to occur whenever you press the tool button.

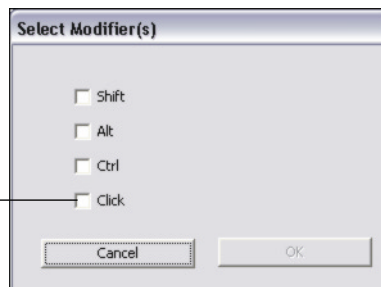

**PRESSURE HOLD.** Locks the pressure at the current pressure level until the side switch is released. For example, you can paint with pressure-sensitivity until you reach the brush size that you like. You can then press the switch and continue painting with the same size brush until the switch is released.



**MODE TOGGLE....** Toggles between the pen tracking mode (pen mode) and mouse mode. The tracking mode you select determines the relationship between pen movement and cursor movement.

- With the pen display tablet correctly calibrated in pen mode, the screen cursor should always follow the physical pen tip on the screen. This is the default setting.
- When toggled to your computer's mouse settings (mouse mode), the screen cursor is not directly "linked" to the pen tip and is positioned like a mouse, requiring a "pick up and slide" motion to move the cursor on the screen. On multiple monitor systems, mouse mode will allow you to access the other monitor(s) with your pen.

# Adjusting the LCD monitor

## Factory presets, multi-sync, and user settings

**Factory presets:** For optimal display quality, set your video card to the DTF-720's native resolution of 1280 x 1024 pixels. See page 43 for signal specifications.

**Multi-sync:** The DTF-720 attempts to automatically synchronize to the incoming signal. Multi-sync will function when the horizontal frequency is between 30 to 80 kHz and the vertical frequency is between 50 to 75 Hz. If the DTF-720 does not automatically synchronize with the incoming signal, you can use the On Screen Display (OSD) RESET AUTO ADJUST option to initiate display synchronization. Further screen display adjustments can be manually made using the OSD controls.

**User settings:** When you manually set the display using the OSD function, the settings are stored within the DTF-720 for use the next time the unit receives a similar signal. This is applicable to all display modes.

## Working with on screen display settings

The DTF-720 is equipped with an On Screen Display (OSD) function. The OSD function enables you to adjust and optimize a variety of display settings at the touch of a button. The OSD controls are located on the upper left edge of the unit.

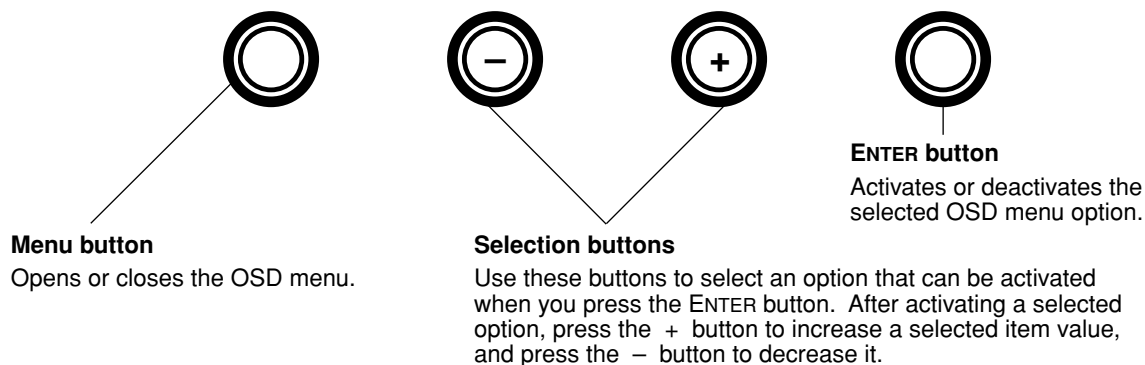

The basic process for working with the OSD is as follows:

- Press the MENU button to open the OSD main menu.
- Use the + or - buttons to select an option. When the option you want to adjust is highlighted, press the ENTER button. The current settings and adjustment sub-menu for that option will appear.
- Use the + or - buttons to adjust the option settings.
- After making your changes, press the ENTER button to save. To exit, press the MENU button.

**Note:** All settings are automatically saved when the OSD menu closes. If you make changes to the display appearance and cannot return to the original settings, use the RESET RECALL option to return the DTF-720 to its original factory defaults.

When you open the On Screen Display, the following menu option icons are displayed:



**CONTRAST.** Select to increase or decrease image contrast.

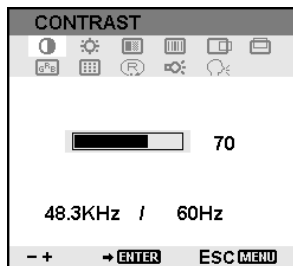

**BRIGHTNESS.** Select to increase or decrease image brightness.

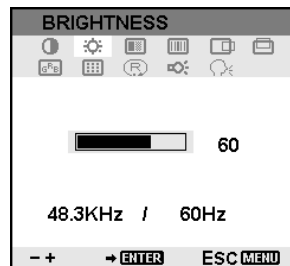

**PHASE.** Select to reduce or eliminate horizontal distortion lines.  
To automatically adjust, use the RESET option.

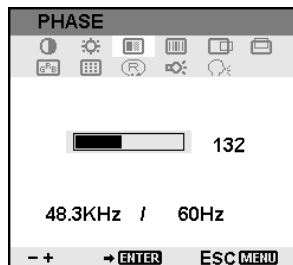

**PITCH.** Select to reduce or eliminate vertical distortion lines.  
To automatically adjust, use the RESET option.

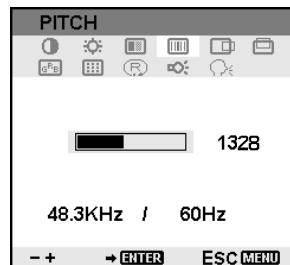

**HORIZONTAL CENTER.** Select to move the screen image left or right.  
To automatically adjust, use the RESET option.

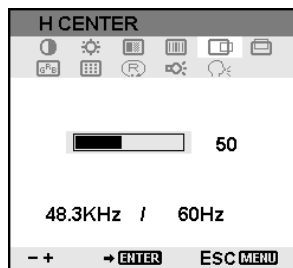

**VERTICAL CENTER.** Select to move the screen image up or down.  
To automatically adjust, use the RESET option.

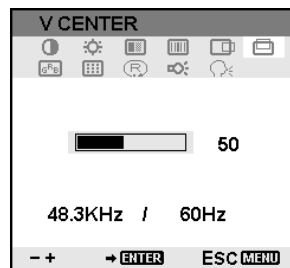

**MENU POSITION.** Select to move the OSD menu around the display screen.

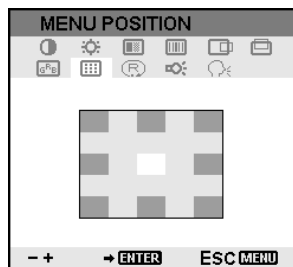

**RESET.** Provides two options: Use **AUTO ADJUST** to reset only the image parameters. Use **RECALL** to reset all screen options to the factory default.



Selecting the **EXIT** icon exits the RESET window without resetting anything.



**BACKLIGHT.** Select to increase or decrease the backlight brightness level.

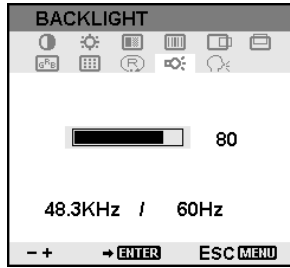

**LANGUAGE.** Select to choose a language option for the OSD.



**COLOR.** Provides color temperature settings for 9300°, 6500°, and 5000° Kelvin.

DIRECT displays the received signal as it is without any adjustment. When DIRECT is selected, the BRIGHTNESS and CONTRAST settings are also set to DIRECT and cannot be adjusted manually.

The USER option enables you to adjust Red, Blue, and Green independently.

Choose a setting and press ENTER to activate your selection.

Change the USER setting by selecting the ENTER icon. →

In the user adjustment COLOR window, change Red, Green, or Blue to calibrate color.

Select the EXIT ← icon to exit.

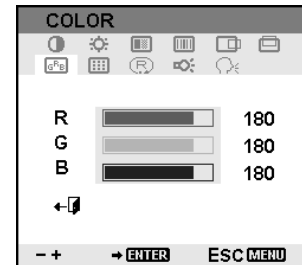
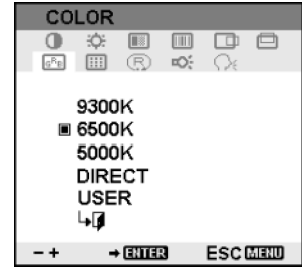

## Adjusting pitch and phase

Some computers and video cards may not allow the multi-sync function to fully work when the DTF-720 is first connected. If some portion of text appears blurred, adjust pitch and phase by following the procedure below. For crisp images, set the resolution of your video card to 1280 x 1024.

- In the Tablet control panel, select the CALIBRATE tab.
- If you are working with multiple displays, be sure the display corresponding to the DTF-720 is selected in the MONITOR menu.
- Click on the CALIBRATE button to activate the calibration screen.
- Using the OSD controls, open the OSD Menu and select the PITCH icon. Then adjust the pitch level so that the pattern of fine vertical stripes displays evenly. (For details on changing the OSD settings, see *Working with on screen display settings* on page 24.)
- In the OSD Menu, select the PHASE icon. Adjust the phase level so that the adjustment pattern shows clearly.
- After completing these adjustments, press the ENTER and MENU buttons to exit the OSD Menu.

Click on the CANCEL button or press ESC to exit the calibration screen.

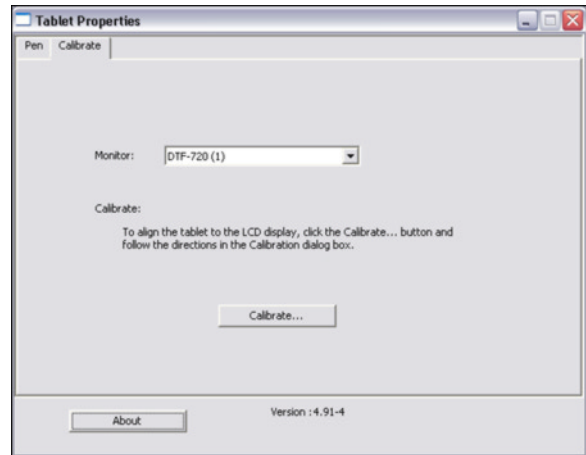

Adjustment pattern for pitch and phase.

## Power saving

The DTF-720 conforms to VESA and ENERGY STAR® power saving guidelines.

When using the DTF-720 with a VESA Display Power Management Signaling (DPMS) compliant computer or graphics card, the display will automatically comply with the below power saving parameters.

<b>Power saving mode</b>	<b>H-sync</b>	<b>V-sync</b>	<b>Video</b>	<b>Power consumption</b>	<b>Power lamp</b>
Power ON	Yes	Yes	Active	37 W, max.	Blue
Standby mode	No	Yes	Blanked	2 W, max.	Blue/Orange
Suspend mode	Yes	No	Blanked	2 W, max.	Blue/Orange
OFF mode	No	No	Blanked	1 W, max.	Orange

# **TROUBLESHOOTING**

Most of the time your pen display tablet will work flawlessly. But if you are having trouble, Wacom recommends you do the following:

1. If the DTF-720 does not function properly, refer to the troubleshooting section below. See also *Display troubleshooting* on page 31, or look in the *Pen tablet troubleshooting* on page 33. Your problem may be described there and you can try the solution offered.
2. Open the Wacom pen display tablet Read Me file for late-breaking information.
3. If you are having a compatibility conflict between the DTF-720 and a new hardware or software product, check if a newer pen tablet software driver is available. See *Obtaining driver downloads* on page 39 for information on downloading an updated software driver. Wacom periodically updates the software driver to maintain compatibility with new products.
4. Check the FAQs (Frequently Asked Questions) on the Wacom web site for your region.
5. If you have tried the suggestions in this manual and still cannot resolve the problem, then contact Wacom for Technical Support. See the Read Me file for information on where to obtain support for your region.

## **Testing the DTF-720**

### **1. If the DTF-720's power LED does not light, check the following:**

- First verify that the green light on the power adapter is on. If the light is not on, check that the power cable is properly connected to the power adapter and to an active AC outlet.
- Check that the power adapter cable is securely connected to the DTF-720 and that the DTF-720 power switch is turned on. The DTF-720 power LED will glow orange or blue whenever the DTF-720 is on.

**Important:** Use only the AC adapter that came with pen display tablet. Other adapters may cause damage to your tablet.

### **2. If there is no display:**

- Make sure that your computer is turned on. The power LED will light blue when the proper video signal is received, and orange if there is no video signal or if the computer is in a power saving mode.
- Verify that the DTF-720 is connected to an active VGA connector.
- Check that your video card has been properly installed and is functional. If you have another display that is compatible with your video card, you can connect that display to the card in order to verify that the video card is operating correctly.

### 3. Verify that the tablet and pen are working:

- Press the pen tip against the display and verify that the status LED lights blue.
- If the LED does not light, verify that the DTF-720's USB cable is plugged into an active USB port. If the DTF-720 is plugged into a USB hub, try plugging the DTF-720 directly into the USB port on your computer.
- The status LED will light blue when the DTF-720 is registered as a USB device and the pen tip is pressed against the display.

### 4. Check the pen. If you cannot make a selection on the display screen with the pen:

- Test the pen by pressing the pen tip against the surface of the pen display tablet. The tablet status LED should light blue.
- Now, without applying pressure to the pen tip but keeping the pen within 5 mm (0.2 inch) of the pen display tablet surface, press the side switch. The status LED should again light blue.
- If the status LED does not light blue for these tests, be sure you are using the correct pen that came with your DTF-720.

If you are still having problems, you may have a defective pen or pen display tablet.



# Display troubleshooting

If you encounter problems with the DTF-720 display, refer to the following tables; your problem may be described here and you can try the solution offered. For additional information about color issues, refer to the documentation that came with your operating system or applications.

## General display problems

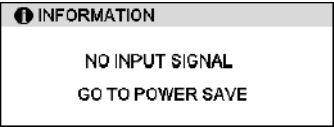
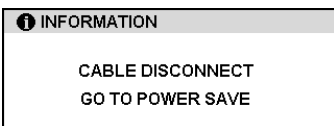
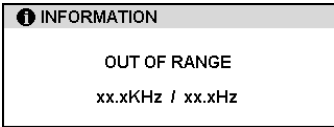
No display. The power LED is off.	<ul style="list-style-type: none"><li>• Verify that the AC power cable is connected, and that the DTF-720 power switch is turned on.</li></ul>
No display. The power LED is lit blue.	<ul style="list-style-type: none"><li>• Check the contrast, brightness, and backlight controls. Adjust as necessary, or open the OSD menu, go to the RESET menu and select the RECALL option.</li></ul>
The power LED is lit orange. The following message appears briefly on your display screen: 	<ul style="list-style-type: none"><li>• Your computer may be in a power management mode. Touch the pen tip to the display screen, move the mouse, or depress any key on your keyboard.</li><li>• Verify that the video card is properly installed.</li><li>• Turn off both your computer and the DTF-720 pen display tablet, and check the video cable for bent or broken connector pins. Then properly connect the video cable and turn on the DTF-720 and your computer.</li></ul>
The following message appears briefly on your display screen: 	<ul style="list-style-type: none"><li>• Check that your computer is turned on.</li><li>• Verify that you are using the video cable that came with the DTF-720.</li><li>• Check that the DTF-720 video cable is fully connected.</li><li>• Turn off both your computer and the DTF-720 pen display tablet, and check the video cable and any video adapters for bent or broken connector pins. Then properly connect the video cable and any necessary adapters.</li></ul>
The following message appears briefly on your display screen: 	<ul style="list-style-type: none"><li>• The input signal frequency is incorrectly set or not compatible with the DTF-720. Connect a different display and set the refresh rate (vertical frequency) to some value between 50 and 75 Hz. If your video card driver supports adjustment of the horizontal frequency, make sure it is set to some value between 30 and 80 kHz.</li><li>• The resolution is set too high (1280 x 1024, maximum).</li><li>• The refresh rate is set too high (75 Hz maximum).</li><li>• Set the display properties to detect plug and play monitors.</li></ul>

The image appears multiple times on the display.	<ul style="list-style-type: none"> <li>Do not extend the video cable. Do not use an input selector switch box.</li> </ul>
When a still image is displayed for a long period of time without refreshing the screen, an after-image remains for a short period of time.	<ul style="list-style-type: none"> <li>Use a screen saver or other power management feature.</li> </ul>
The color white does not display as white.	<ul style="list-style-type: none"> <li>Verify that the display is operating at the factory default settings. If that is not sufficient, then adjust color as necessary. For details on color management, refer to your operating system and application documentation.</li> <li>Verify that the video cable and connector are fully connected.</li> </ul>

## VGA problems

The display ripples or flickers.	<ul style="list-style-type: none"> <li>Open the OSD menu, go to the RESET menu, and select the AUTO ADJUST option. Then, if necessary, manually adjust pitch and phase.</li> <li>Verify that the display adapter or video card matches the specifications for the DTF-720.</li> <li>Adjust the refresh rate in the Display Properties control panel.</li> </ul>
The display is not clear.	<ul style="list-style-type: none"> <li>As necessary, adjust contrast or brightness, pitch and phase.</li> <li>Set the display resolution of your video card to 1280 x 1024.</li> </ul>
The display and LCD panel are not lined up. The display size is not correct.	<ul style="list-style-type: none"> <li>Open the OSD menu, go to the RESET menu, and select the RECALL option.</li> <li>As necessary, adjust pitch and phase, and horizontal and vertical position. Note that some video cards may not show the display in proper sizing.</li> </ul>
The display ripples or shows a moiré pattern. The display color is not even.	<ul style="list-style-type: none"> <li>Open the OSD menu, go to the RESET menu, and select the RECALL option.</li> <li>As necessary, adjust pitch and phase.</li> </ul>

## Pen tablet troubleshooting

If you encounter problems with the DTF-720 interactive pen display, refer to the following tables. Your problem may be described here, and you can try the solution offered. Be sure you refer to the DTF-720 Read Me file for the latest information.

For additional information, visit Wacom's web site at <http://www.wacom.com/productsupport> and follow the links to the FAQs.

### General problems

The computer does not have an available USB port.	Check if there is an available USB port on a USB hub. If none are available you will need to add a USB hub or USB card.
A USB device plugged into one of the pen display's integrated USB ports does not function.	<ol style="list-style-type: none"><li>1. Make sure the pen display itself is properly connected to a working USB port on your computer.</li><li>2. Then be sure the pen display is powered on and that the power LED lights blue. The DTF-720 contains a powered USB hub and the integrated USB ports will not work when the power is off.</li></ol>
The tablet power LED is off.	<p>Make sure the pen display tablet power switch is turned on.</p> <p>Check that the AC power adapter is plugged into both the pen display tablet and an active power outlet.</p> <p>Use only the power adapter that came with the pen display tablet; other adapters may cause damage to your product.</p>
The pen works only in mouse mode, and does not draw with pressure-sensitivity.	<p>The tablet driver software was not installed or did not load properly. Make sure the tablet driver software is installed and functioning. Install the pen tablet driver software in accordance with the instructions found in the <i>Installation</i> section of this manual.</p> <p>Some applications, including Photoshop 7.0 and greater, require that you turn on the pressure capabilities before the pen will respond as a pressure-sensitive tool.</p>
Clicking is difficult.	Open the Tablet control panel and go to the Pen tab. Try using a lighter TIP FEEL.
The pen selects everything or will not stop drawing.	Open the Tablet control panel and go to the PEN tab. Move the TIP FEEL slider toward FIRM. If this does not help, see <i>Testing the DTF-720</i> on page 29.
Double-clicking is difficult.	<p>Be sure you are quickly tapping the display screen twice in the same place on the pen display tablet's active area. Wacom recommends using the side switch to double-click. See <i>Adjusting double-click</i> on page 21.</p> <p>Try increasing the DOUBLE CLICK DISTANCE or using a lighter TIP FEEL.</p> <p><b>Windows:</b> Try setting your system to launch programs with a single click. See <i>Pen operations</i> on page 17.</p>
You notice a delay at the beginning of pen strokes.	Try decreasing the DOUBLE CLICK DISTANCE. See <i>Adjusting double-click</i> on page 21.

You have to press hard with the pen when clicking or drawing.

Open the Tablet control panel and go to the PEN tab. Move the TIP FEEL slider toward SOFT.

---

The pen tip does not function.

Be sure you are using the pen that originally came with your pen display tablet. Other pens may not function properly on the DTF-720 interactive pen display.

Make sure the status LED lights blue when the tip is pressed. If the LED does not light, verify that the USB cable is plugged into an active port on your computer or on a USB hub.

If the LED still does not light, you may have defective hardware (see *Troubleshooting* on page 29).

---

The side switch does not work.

Be sure you are using the pen that originally came with your pen display tablet. Other pens may not function properly on the DTF-720 interactive pen display.

Be sure you press the side switch when the pen tip is within 5 mm (0.2 inch) of the pen display tablet's active area – do this without pressing down on the pen tip.

From the Tablet control panel, verify that the side switch is set to the proper function you are expecting to occur.

Make sure the status LED lights blue when you press the side switch. If the LED does not light, verify that the USB cable is plugged into an active USB port on your computer or on a USB hub; the LED will not light if the USB cable is not plugged into an active port.

If the LED does not light, you may have defective hardware (see *Troubleshooting* on page 29).

---

The pen tip and screen cursor do not properly line up.

Open the Tablet control panel and select the CALIBRATE tab. Continue with *Calibrating the DTF-720* on page 20.

---

The screen cursor moves but it does not jump to the pen tip location when the pen is placed on the display screen, and it does not follow the pen tip when the pen is moved across the display.

Make sure the Wacom tablet driver has loaded properly by opening the Tablet control panel. If the driver did not load you will see an error message. If an error message appears, reboot your computer. If the problem persists, refer to the *Installation* instructions and reinstall the Wacom tablet software. (For Macintosh, you must restart your computer after installing the Wacom tablet driver for proper tablet operation.)

If you have customized the side switch on your pen to toggle between pen mode and mouse mode, make sure that your pen display tablet is operating in pen mode. See *Customizing the side switch button functions*, beginning on page 21.

---

When using the pen display tablet on a multiple monitor system, you cannot use the pen to control the other monitor(s).

You can use your pen to control the other monitors in mouse mode. To use mouse mode, first set the pen's DuoSwitch to MODE TOGGLE.... Then use the switch to toggle between pen mode and mouse mode.

The line you are drawing does not line up with the location of the screen cursor in paint applications.

To function properly, some applications require that the pen is set to pen mode. Make sure the pen has not been toggled to mouse mode. If the pen is set to pen mode and the problem still exists, then you may have a corrupted preferences file. Follow the instructions in the next tip to create a new preferences file.

---

You suspect the pen tablet preferences may be corrupted, or want to make certain that all settings are at their factory defaults.

Delete the pen tablet preferences as follows:

**Windows:** Do a Search or Find for the TABLET.DAT file and delete it. The file should be located in your Windows or Windows\System32 folder. Then restart your computer. When the tablet driver loads, it will create a new preferences file with the factory default settings. Recalibrate the unit.

**Macintosh OS X:** For a single user, delete the tablet preferences by first choosing your HOME folder from the GO menu. Then open your home LIBRARY folder. Within your home LIBRARY folder, open the PREFERENCES folder and delete the COM.WACOM.TABLETPREFERENCES file. Log out, then log back in. When the tablet driver loads it will create a new preferences file with the factory defaults.

For multiple users, delete all tablet preferences by first opening the main APPLICATIONS folder. Then open the TABLET folder and run the REMOVETABLET utility. When the utility starts, click on the REMOVE ALL PREFERENCE FILES button. Log out, then log back in. When the tablet driver loads, it will create new preferences files with the factory defaults.

Recalibrate the tablet.

**Note:** Do not manually remove the WACOM TABLET.PREFPANE file from the main LIBRARY PREFERENCEPANES folder. This file is only to be removed when uninstalling the tablet software driver, and then only when using the REMOVETABLET utility.

---

The computer does not go to sleep.

When you are not using the pen, remove it from the pen display tablet surface or the tablet will continue to send data, keeping the computer awake.

---

The screen cursor jumps back when using your regular mouse or trackball.

When the pen is not in use, place it in the pen storage compartment or at some location near the pen display tablet, but not on the display. Leaving your pen on the display may interfere with screen cursor positioning when using other input devices.

---

The screen cursor moves erratically or jumps around on the display screen when another tablet is connected to your computer.

The tablet portion of the DTF-720 emits electromagnetic waves at a certain frequency. If another tablet is too closely placed to the DTF-720 it may interfere with screen cursor positioning. If this occurs, move the tablet further away from the DTF-720.

## Windows-Specific Problems

After changing right- and left-handed settings in the computer's mouse control panel, the pen tip no longer functions properly.

Restart Windows for your Wacom tool settings to be correctly recognized.

---

**Windows 98SE or Me:**  
Your pen does not function inside a full screen DOS window.

You must use a mouse when working in a full screen DOS window.

---

**Windows 98SE or Me:**  
After pressing CTRL+ALT+DEL, the screen cursor cannot be controlled with your pen.

When the CLOSE PROGRAM dialog box is active the pen tablet will not work. Use your mouse or keyboard to continue. When this dialog box is closed, you can again use your pen to control the screen cursor.

---

**Windows XP:**  
After installing the pen display tablet on a system with multiple users, the pen display tablet only works on the primary user desktop.

Reboot the system after installing the pen display tablet on a system with multiple users.

---

## Macintosh-Specific Problems

At startup, a dialog box appears telling you that either the driver failed to load or the tablet preferences have not yet been created.

The tablet was not detected at startup. Check that the USB interface cable is securely connected to a USB port on your computer or to a USB hub. Make sure that the tablet power LED is on. If this does not correct the problem, see *Troubleshooting* on page 29.

From the GO menu, select APPLICATIONS and open the UTILITIES folder. Launch the APPLE SYSTEM PROFILER and select the DEVICES AND VOLUMES tab. A USB tablet should be displayed by the profiler. If a USB tablet was not found, check the USB tablet cable connection or try plugging the tablet into a different USB port.

If you are still having problems, go to the Applications/Utilities folder, open the Disk Utility program, and run REPAIR DISK PERMISSIONS from the FIRST AID tab. If this does not help, contact Wacom for Technical Support. See *Technical support options* on page 38.

---

Inkwell does not work correctly with the pen display tablet.

There may be a problem with the Inkwell preferences. Remove the damaged preference files as follows. They will be recreated when you enable handwriting recognition.

1. From the Apple menu, choose SYSTEM PREFERENCES. From the System Preferences menu, choose SHOW ALL and select INK. Then turn off handwriting recognition.
2. From the Go menu, choose your HOME. Open the LIBRARY and PREFERENCES folders. Then remove the following preferences:
  - com.apple.ink.framework.plist
  - com.apple.ink.inkpad.plist
  - com.apple.ink.inkpad.sketch
3. Go back to SYSTEM PREFERENCES and INK, and then enable handwriting recognition.
4. Test the Inkwell function using your Wacom pen display tablet and pen.
5. If this procedure does not resolve your problem with Inkwell, contact Apple Support for further assistance. Wacom is not the software manufacturer for Inkwell and we are limited in our abilities to support a third party software application.

## Technical support options

If you have a problem with your DTF-720 interactive pen display, first check the appropriate *Installation* section in this guide to make sure the unit is installed correctly. Then review the *Troubleshooting* procedures within this guide; your problem may be described there and you can try the solution(s) offered.

If you cannot find the answer in this guide, you may find updated information about your problem in the appropriate Read Me file for your platform (located on the Wacom Pen Tablet Driver CD). You can also check the product FAQs (Frequently Asked Questions) on the Wacom web site for your region.

If you have an Internet connection you can download the latest software drivers from the Wacom web site for your region. See *Obtaining driver downloads* on page 39.

If you cannot solve the problem and you think your Wacom product is not working properly, contact the Wacom support staff for the area where your product was purchased. See the Wacom tablet Read Me file, located on the Wacom Pen Tablet Driver CD, for contact information.

When you call, you should be at your computer with the following information available:

- This manual.
- Pen display tablet serial number. (Look at the label on the back of the unit.)
- Driver version number. (See the Wacom Pen Tablet Driver CD or the Tablet control panel.)
- The make and model of your computer, and operating system version number.
- The make, model, and connection type of your video card.
- A list of peripheral devices attached to your computer.
- The software application and version you were using when the problem occurred.
- The exact wording of any error message that appeared on your screen.
- What happened and what you were doing when the problem occurred.
- How you tried to solve the problem.



## Obtaining driver downloads

Wacom periodically updates the pen tablet software driver to maintain compatibility with new products, and recommends that you regularly update the driver for best functionality. A new Wacom tablet software driver (when available) can be downloaded from the Internet.

### USA, Canada, Central and South America

Worldwide Web: <http://www.wacom.com/productsupport> Software updates.

### Europe, Middle East and Africa

Worldwide Web: <http://www.wacom-europe.com> Software updates.

---

Anonymous FTP Site: <ftp://ftp.wacom-europe.com/pub/> Software updates.

### Japan

Worldwide Web: <http://tablet.wacom.co.jp> Software updates. (Japanese)

### Asia Pacific (English)

Worldwide Web: <http://www.wacom.com/ap> Software updates. (English)

### China

Worldwide Web: <http://www.wacom.com.cn> Software updates.  
(Simplified Chinese)

# APPENDIX

## Caring for the DTF-720

Keep the pen and the DTF-720 LCD screen surface clean. Dust and dirt particles can stick to the pen and cause wear to the display screen surface. Regular cleaning will help prolong the life of your LCD screen surface and pen. Keep the DTF-720 and the pen in a clean, dry place and avoid extremes in temperature. Room temperature is best. The DTF-720 and pen are not made to come apart. Taking apart the product will void your warranty.

## Cleaning

To clean the DTF-720 casing or the pen, use a soft, damp cloth; you can also dampen the cloth using a very mild soap diluted with water. Do not use paint thinner, benzine, alcohol, or other solvents to clean the unit casing or pen.

To clean the display screen, use an anti-static cloth or a slightly damp cloth. When cleaning, apply only a light amount of pressure to the display screen and do not make the surface wet. Do not use detergent to clean the display screen; this may damage the coating on the screen. Please note that damage of this kind is not covered by the manufacturer's warranty.

## Replacing the pen tip

The pen tip (nib) will wear with normal use. When the nib gets too short or develops a sharp edge, you can replace it with one of the extra nibs that came with the pen.

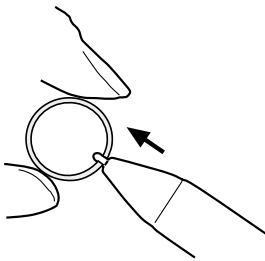

### To remove the old nib:

Clasp it with a pair of tweezers, needle-nosed plier, or similar instrument and pull the old nib straight out of the pen.

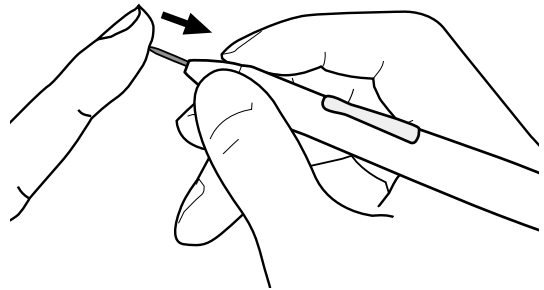

### To insert a new nib:

Slide it straight into the barrel of the pen. Firmly push the nib until it stops. The new nib will slide into the correct position.

**⚠ WARNING** **Prevent children from swallowing the pen tip or side switch.** The pen tip (nib) or side switch may accidentally be pulled out if children are biting on them.

If the pen nib wears and becomes angular, it may damage the coating on the DTF-720 display screen. To avoid this, periodic tip replacement is recommended.

**Important:** When the pen is not in use, place it in the pen storage compartment or lay it flat on your desk. To maintain the sensitivity of your pen, do not store the tool in a container where it will rest on its tip.

## Using an alternate mount or stand

If you will be using the DTF-720 in an installation that requires the use of an alternate mounting platform, you can remove the adjustable stand from the unit and mount the pen display onto any mount arm or stand conforming to the VESA 75 standard.

Mounting screws that are 4 mm wide with a 0.7 mm pitch (M4 Regular), with a screw clearance depth of 15 mm are required. Exceeding the clearance depth of 15 mm will damage the DTF-720 internal components.

To remove the adjustable stand and attach the DTF-720 to a different mounting platform:

1. Turn off your computer and power off the DTF-720. Then disconnect all cables from between the unit and your computer.
2. Protect the display screen surface by spreading a soft cloth onto a flat table and placing the DTF-720 face down on the cloth.
3. Remove the four screws and lift the adjustable stand assembly away from the body of the unit.
4. Using the appropriate screws for your mounting platform, firmly attach the DTF-720 to the alternate mounting platform.
5. Refer to the *Installation* instructions, beginning on page 9, and reattach the cabling.

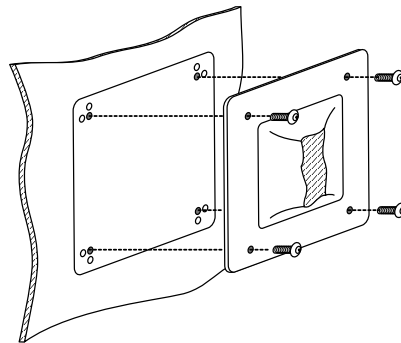
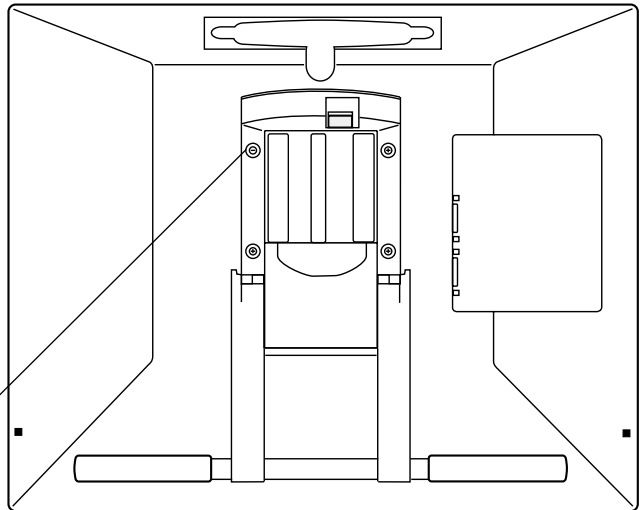

**CAUTION** When attaching the DTF-720 onto an alternate mounting platform, be sure to follow all instructions in the documentation supplied by the platform manufacturer. If improperly installed, the unit could fall, resulting in damage to the unit or physical injury.

## Uninstalling the DTF-720

Follow the appropriate procedure below to remove the Wacom tablet software and the DTF-720 from your system.

**Important:** When you remove the Wacom tablet driver software from your system, any other Wacom tablet connected to your computer will no longer operate with full Wacom tablet functionality.

### Windows XP or XP x64:

1. Click START. In the start menu, select CONTROL PANEL. Then select ADD OR REMOVE PROGRAMS.
2. In the ADD OR REMOVE PROGRAMS window, choose TABLET and click on the CHANGE OR REMOVE PROGRAMS button. Follow the prompts to remove the pen tablet driver.
3. When the driver has been removed, shut down your system, power off your computer, and turn off the DTF-720. When your computer and the DTF-720 are off, disconnect the DTF-720 from your computer.

### Windows 98SE, Me, or 2000:

1. Click the Windows START button. Then choose SETTINGS and CONTROL PANEL.
2. In the CONTROL PANEL window, double-click on the ADD/REMOVE PROGRAMS icon. In the dialog box that appears, choose the TABLET option.
3. Click on the ADD/REMOVE... button and follow the prompts to remove the pen tablet driver.
4. When the driver has been removed, shut down your system, power off your computer, and turn off the DTF-720. When your computer and the DTF-720 are off, disconnect the DTF-720 from your computer.

### Macintosh OS X:

1. From the GO menu, choose APPLICATIONS and open the WACOM TABLET folder.
2. Double-click on the REMOVE TABLET icon and select the REMOVE TABLET SOFTWARE button. Enter your administrator login name and password.
3. After the removal is completed, click OK.
4. Shut down your computer and turn off the DTF-720. When your computer and the DTF-720 are off, disconnect the DTF-720 from your computer.

# Product specifications

## General specifications

Physical dimensions (W x D x H)	400 x 362 x 120.2 mm (15.8 x 14.3 x 4.7 in), excluding stand
Weight	6.1 kg (13.4 lb), excluding stand
Input voltage	12 VDC
Power consumption	37 W or less
Operating temperature and humidity	5° to 35° C, 20 to 80% RH (non-condensing)
Storage temperature and humidity	-10° to 60° C, 20 to 90% RH (non-condensing) (maximum storage humidity is 38% at a temperature of 60° C, and maximum storage temperature is 42° C at a humidity of 90%)
Certification and compliance	FCC part 15 class B, CE, VCCI class B, EDID 1.3, C-tick, BSMI, MIC, CCC

## LCD monitor

Display	a-Si TFT active matrix LCD
Screen size	17.0 in, diagonal
Signal inputs	VGA (Analog RGB)
Signal outputs	VGA (Analog RGB)
Resolution	1280 x 1024 pixels (SXGA), 1024 x 768 pixels (XGA), 800 x 600 pixels (SGA), 640 x 480 pixels (VGA)
Refresh rate	50 to 75 Hz (vertical) All scan modes are non-interlaced.
Pixel pitch	0.264 x 0.264 mm (0.010 x 0.010 in)
Color depth	16.2 million (6 bits for RGB + FRC)
Brightness	250 cd/m <sup>2</sup>
Contrast ratio	500:1
Plug and Play	DDC2B
LCD quality	Each DTF-720 LCD panel is produced under very stringent quality standards. Production techniques cannot guarantee an absolutely perfect TFT display. Wacom does not allow any pixel to be always white or always black. A small number of pixels (5 or less) are allowed to show a wrong color for some parts of the color spectrum. This does not mean the display is defective.

## Pen tablet

Reading technology	Electromagnetic resonance method
Active area	337.9 x 270.3 mm (13.3 x 10.65 in)
Resolution	20 lpmm (0.05 mm) (508 lpi (0.002 in))
Accuracy	±1 pixel
Reading height	5 mm (0.2 in)
Maximum report rate	100 points/sec.
Pressure levels	512 levels
Communication interface	USB v2.0
Integrated USB hub	USB v2.0 Powered hub with two external ports, 500 mA per port

## Power adapter

Input voltage	100 to 240 VAC, 50/60 Hz
Output voltage	12 VDC, 4.16 A

## Pen (model FP-320)

Pressure levels	512
Pen tip travel	0.1 mm (0.004 in) or less
Physical dimensions (L x D)	146.5 x 12.5 mm (5.77 x 0.49 in)
Weight	12 g (0.42 oz), approximately
Side switch type	Rocker switch

## Purchasing parts and accessories

To purchase parts and accessories, refer to the Wacom tablet Read Me file and see who to call for your region. You can also do the following:

**To purchase parts and accessories in the USA or Canada,** call 1.888.884.1870 (toll-free) or visit Wacom's web site at <http://www.wacomdirect.com> (USA only).

**To purchase parts and accessories in Europe,** call +49 (0)180 500 03 75 or send an email to [parts@wacom-europe.com](mailto:parts@wacom-europe.com). Or, visit the Wacom web site at [www.wacom-europe.com/solutionstore](http://www.wacom-europe.com/solutionstore). You can also contact your local dealer, distributor, or Technical Support using the appropriate number for your region.

**To purchase parts and accessories in other countries,** please contact your local dealer or distributor.

## Radio and television interference

The equipment described in this manual generates, uses, and can radiate radio-frequency energy. If it is not installed and used properly – that is, in strict accordance with applicable instructions – it may cause interference with radio and television reception.

### Federal Communications Commission (FCC) notice

This device complies with Part 15 of the FCC Rules. Operation is subject to the following two conditions: (1) this device may not cause harmful interference, and (2) this device must accept any interference received, including interference that may cause undesired operation.

This equipment has been tested and found to comply with the limits for a Class B digital device, pursuant to Part 15 of FCC Rules. These limits are designed to provide reasonable protection against harmful interference in a residential installation.

This equipment generates, uses and can radiate radio frequency energy and, if not installed and used in accordance with the instructions, may cause harmful interference to radio communications. However, there is no guarantee that interference will not occur in a particular installation.

You can determine whether the equipment is causing interference by powering it off. If the interference stops, it was probably caused by the equipment.

If the equipment does cause interference to radio or television reception, you may be able to correct the interference by using one or more of the following measures:

- Rotate the television or radio antenna until the interference stops.
- Move the equipment farther away from the television or radio.
- Plug the equipment and computer into an outlet that is on a different circuit from the television or radio.

If necessary, consult your Wacom dealer or an experienced radio/television technician for help.

Changes or modifications to this product not authorized by Wacom could void the FCC Certification and negate your authority to operate the product.

### CE declaration

The DTF-720 interactive pen display has been tested and found to comply to the following harmonized European Norms:

- EN 55024: 1998+A1:2001+A2:2003 (electromagnetic immunity)
- EN 55022: 1998+A1:2000+A2:2003, Class B (electromagnetic emissions)
- EN 61000-3-2: 2000, Class D (electromagnetic emissions)
- EN 61000-3-3: 1995+A1:2001 (electromagnetic emissions)

The Wacom power adapters have been tested by their manufacturers and found to comply to the following harmonized European Norms:

- EN 55024: 1998+A1:2001 (electromagnetic immunity)
- EN 55022: 1998+A1:2000, Class B (electromagnetic emissions)
- EN 61000-3-2: 2000, Class D (electromagnetic emissions)
- EN 61000-3-3: 1995+A1: 2001 (electromagnetic emissions)
- EN 60950: 2000 (safety)

Based on the results of these tests, Wacom declares that the above mentioned device conforms to the European Council Directives 89/336/EEC and 73/23/EEC, and their amendment Directive 93/68/EEC and indicates this conformity by the CE-sign on each device.

The device must be installed and operated always in strict accordance to the instructions given in this manual. Any changes or modifications to this product that were not specifically authorized by Wacom will invalidate this declaration.

# Warranty

## **Limited Warranty (U.S.A. and Canada)**

Wacom warrants the product, to the original consumer purchaser, except for the Software and consumable items such as the pen nibs, to be free from defects in materials and workmanship under normal use and service for a period of two (2) years, from the date of original retail purchase, as evidenced by a copy of the receipt and registration with Wacom by mail or online within 30 days of purchase.

The Software is licensed "as is." Wacom makes no warranty with respect to its quality or performance. Wacom cannot guarantee you uninterrupted service or the correction of any errors.

*Upon discovery of a defect in the product, except in the Software, within the Warranty Period, you should contact Wacom Technical Support via telephone, email, or fax to obtain an RMA (Return Merchandise Authorization) number and instructions for shipping the product to a service location designated by Wacom. You should send the product, shipping charges prepaid, to the designated service location, accompanied by the return authorization number, your name, address and telephone number, proof of purchase date, and a description of the defect. Wacom will pay for return shipping by United Parcel Service or by an equivalent service as chosen by Wacom.*

Wacom's sole obligation and entire liability under this warranty shall be, at Wacom's option, either the repair or replacement of the defective product or parts thereof of which Wacom is notified during the Warranty Period; provided, however, that you are responsible for (i) the cost of transportation of the product to the designated service location and (ii) any loss or damage to the product resulting from such transportation.

Wacom shall have no responsibility to repair or replace the product if the failure of the product has resulted from accident, abuse, misuse, negligence, or unauthorized modification or repair, or if it has been handled or stored other than in accordance with Wacom's storage instructions.

Any descriptions, drawings, specifications, samples, models, bulletins, or similar material, used in connection with the sale of the product, shall not be construed as an express warranty that the product will conform or comply with your requirements.

EXCEPT FOR THE LIMITED WARRANTY DESCRIBED ABOVE, THERE ARE NO OTHER WARRANTIES MADE BY WACOM ON THIS PRODUCT. NO ORAL OR WRITTEN INFORMATION OR ADVICE GIVEN BY WACOM, ITS DEALERS, DISTRIBUTORS, AGENTS, OR EMPLOYEES SHALL CREATE A WARRANTY OR IN ANY WAY INCREASE THE SCOPE OF THIS WARRANTY, AND YOU MAY NOT RELY ON ANY SUCH INFORMATION OR ADVICE. THIS WARRANTY GIVES YOU SPECIFIC LEGAL RIGHTS, AND YOU MAY ALSO HAVE OTHER RIGHTS WHICH VARY FROM STATE TO STATE.

WACOM LIMITS THE DURATION OF ANY LEGALLY IMPLIED WARRANTIES INCLUDING IMPLIED WARRANTIES OF MERCHANTABILITY OR FITNESS FOR A PARTICULAR PURPOSE, TO THE DURATION OF WACOM'S EXPRESS WARRANTY. SOME STATES DO NOT ALLOW LIMITATIONS ON HOW LONG AN IMPLIED WARRANTY LASTS, SO THE ABOVE LIMITATION MAY NOT APPLY TO YOU.

NEITHER WACOM NOR ANYONE ELSE WHO HAS BEEN INVOLVED IN THE CREATION, PRODUCTION, OR DELIVERY OF THIS PRODUCT SHALL BE LIABLE FOR ANY DIRECT, CONSEQUENTIAL, OR INCIDENTAL DAMAGES (INCLUDING DAMAGES FOR LOSS OF BUSINESS PROFITS, BUSINESS INTERRUPTION, LOSS OF BUSINESS INFORMATION AND THE LIKE) ARISING OUT OF THE USE OF OR INABILITY TO USE SUCH PRODUCT, EVEN IF WACOM HAS BEEN ADVISED OF THE POSSIBILITY OF SUCH DAMAGES. SOME STATES DO NOT ALLOW THE EXCLUSION OR LIMITATION OF INCIDENTAL OR CONSEQUENTIAL DAMAGES, SO THE ABOVE LIMITATION OR EXCLUSION MAY NOT APPLY TO YOU.

In the event that any of the above limitations are held unenforceable, Wacom's liability for any damages to you or any party shall not exceed the purchase price you paid, regardless of the form of any claim.

This Limited Warranty is governed by the laws of the United States of America and the state of Washington.

This Limited Warranty is valid for and only applies to products purchased and used inside the United States (and its territories or possessions) and Canada.



## **Warranty Service in the U.S.A. and Canada**

To obtain Warranty service within the U.S. or Canada contact:

Wacom Technical Support  
Phone: 1.360.896.9833  
Fax: 1.360.896.9724  
E-mail: support@wacom.com

## **Warranty Service Outside of the U.S.A. and Canada**

For products purchased or used outside of the United States and Canada, upon discovery of a defect in the product, except in the Software, within the Warranty Period you should contact your local dealer or distributor. If an authorized Wacom repair center is not available in your local country you will be responsible for all transportation costs including duties and taxes to and from the Wacom repair center. In all other respects the terms of the warranty as set forth above apply to such sales.

Should you have any questions about this Agreement, or if you desire to contact Wacom for any reason, please contact in writing:

### **In North and South America contact:**

Wacom Technology Corporation  
1311 SE Cardinal Court  
Vancouver, Washington 98683  
U.S.A.

(This page intentionally left blank.)

**Wacom Technology Corporation**

1311 SE Cardinal Court  
Vancouver, WA 98683  
U.S.A.

**Telephone**

General: +1.360.896.9833

Fax: +1.360.896.9724

**WACOM Co., Ltd.**

2-510-1 Toyonodai  
Otone-Machi, Kitasaitama-Gun  
Saitama, 349-1148  
Japan

**Telephone**

General: +81.(0)480.78.1213

Fax: +81.(0)480.78.1217

**WACOM China Corporation**

Room 611 CNT MANHATTAN BUILDING  
No. 6, Chaoyangmen Bei Road. Beijing, China 100027

**Telephone**

General: ++86.(0)10.8528.2819

Fax: ++86(0)10.8528.2386

**WACOM Europe GmbH**

Europark Fichtenhain A9  
47807 Krefeld  
Germany

**Telephone**

General: +49.(0)2151.3614.0

Fax: +49.(0)2151.3614.111

**WACOM Co., Ltd.**

Asia Pacific Office  
Harmony Tower 18F, 1-32-2 Hon-Cho,  
Nakano-Ku, Tokyo 164-0012  
Japan

**Telephone**

General: +81.3.5309.1513

Fax: 81.3.5309.1514

**WACOM Digital Solutions Co., Ltd.**

Gangnam Telepia B/D 9th Fl, 662-18  
Yeoksam-dong, Gangnam-gu, Seoul, 135-080  
Korea

**Telephone**

General: +82.2.557.3894

Fax: +82.2.557.3895

# DTF-720

interactive pen display

## Installation Guide & User's Manual

WACOM Co., Ltd.



Watch for the Penabled logo to ensure you are getting the natural feel and superior performance of Wacom's patented cordless and battery-free pen technology.

UE-0329